

# DLP® LightCrafter™ Single DLPC900 Evaluation Module (EVM) User's Guide



## ABSTRACT

The DLP® LightCrafter™ Single DLPC900 evaluation module (EVM) offers a reference design to enable faster development cycles for users of the Single DLPC900 Controller architecture in support of DMDs that use a single DLPC900 controller. This platform targets applications needing intelligent pattern management along with high resolution display.

## Table of Contents

<b>1 Trademarks</b>	3
<b>2 About This Guide</b>	4
<b>3 Related Documentation from Texas Instruments</b>	5
<b>4 If You Need Assistance</b>	5
<b>5 DLP LightCrafter Single DLPC900 EVM Overview</b>	5
5.1 Welcome	5
5.2 DLP LightCrafter Single DLPC900 Evaluation Module (EVM) Hardware	6
5.3 EVM Board	7
5.4 Other Items Needed for Operation	8
5.5 DLP LightCrafter Single DLPC900 Connections	9
5.6 DLP LightCrafter Single DLPC900 EVM Flex Cable	13
5.7 DLP LightCrafter Single DLPC900 EVM and DMD EVM Assembly	13
<b>6 Quick Start</b>	15
6.1 Power-up the DLP LightCrafter Single DLPC900 EVM	15
6.2 Creating a Simple Pattern Sequence	16
<b>7 Operating the DLP LightCrafter Single DLPC900 EVM</b>	19
7.1 DLP LightCrafter Single DLPC900 Control Software	19
7.2 PC Software	20
7.3 System Common Controls	21
7.4 System Settings	24
7.5 Video Mode	26
7.6 Pattern Modes	28
7.7 Batch Files	42
7.8 Peripherals	47
7.9 Firmware	48
7.10 Flash Device Parameters	54
7.11 JTAG Flash Programming	55
7.12 Programming an EDID	56
<b>8 Connectors</b>	57
8.1 Input Trigger Connectors	57
8.2 Output Trigger Connectors	57
8.3 DLPC900 UART	57
8.4 DLPC900 I <sup>2</sup> C Port 0	58
8.5 DLPC900 I <sup>2</sup> C Port 1	58
8.6 DLPC900 I <sup>2</sup> C Port 2	58
8.7 JTAG Boundary Scan	59
8.8 GPIO and PWM	59
8.9 Power	60
8.10 External Parallel Video Connector	60
<b>9 Power Supply Requirements</b>	61

9.1 External Power Supply Requirements.....	61
<b>10 Safety</b> .....	<b>62</b>
10.1 Caution Labels.....	62
<b>11 Revision History</b> .....	<b>62</b>

## List of Figures

Figure 2-1. DLP LightCrafter Single DLPC900 Evaluation Module.....	4
Figure 5-1. DLP LightCrafter Single DLPC900 Hardware Components.....	6
Figure 5-2. DLP LightCrafter Single DLPC900 EVM Block Diagram.....	7
Figure 5-3. DLP LightCrafter Single DLPC900 EVM Connectors (Top View).....	9
Figure 5-4. Correct J14 and J15 Labels.....	10
Figure 5-5. Incorrect J14 and J15 Labels.....	10
Figure 5-6. DLP LightCrafter Single DLPC900 EVM Trigger Voltage Level Selectors.....	12
Figure 5-7. Flex Cable Diagram.....	13
Figure 5-8. DLPLCRC900EVM Flex Cable Pad.....	13
Figure 5-9. Assembled DLPLCRC900EVM with DLPLCR65EVM.....	14
Figure 6-1. Pattern Mode Panel.....	17
Figure 6-2. Simple Three Pattern Sequence.....	18
Figure 7-1. DLP LightCrafter DLPC900 GUI.....	20
Figure 7-2. High DPI Settings.....	21
Figure 7-3. System Settings Panel.....	24
Figure 7-4. Video Mode Panel - Source Settings Tab.....	26
Figure 7-5. Video Mode Panel - Display Settings Tab.....	27
Figure 7-6. Pattern Mode Design Panel.....	28
Figure 7-7. Pattern Mode Menu Bar.....	29
Figure 7-8. Add From List.....	29
Figure 7-9. Pattern Sequence.....	30
Figure 7-10. Three Pattern Sequence.....	31
Figure 7-11. Pattern Design Example.....	33
Figure 7-12. LUT Editor Panel.....	34
Figure 7-13. Reorder Example.....	35
Figure 7-14. Video Pattern Mode.....	37
Figure 7-15. DMD Block Load Pattern Sequence.....	39
Figure 7-16. Pattern Settings Panel.....	41
Figure 7-17. Batch Files Panel.....	42
Figure 7-18. Batch File Example.....	45
Figure 7-19. Peripherals Panel.....	47
Figure 7-20. Firmware Panel.....	49
Figure 7-21. Pattern LUT Definition and Configuration.....	52
Figure 7-22. Updating the Index and Bit Position.....	53
Figure 7-23. Flash Device Parameters Text File.....	54
Figure 7-24. UM232H Module.....	55
Figure 7-25. UM232H Wiring Diagram.....	55

## List of Tables

Table 5-1. DLP LightCrafter Single DLPC900 EVM Connector Reference.....	9
Table 8-1. Trigger Input Connector Pins.....	57
Table 8-2. Trigger Output Connector Pins.....	57
Table 8-3. UART Connector Pins.....	57
Table 8-4. I <sup>2</sup> C Port 0 Connector Pins.....	58
Table 8-5. I <sup>2</sup> C Port 1 Connector Pins.....	58
Table 8-6. I <sup>2</sup> C Port 2 Connector Pins.....	58
Table 8-7. JTAG Boundary Scan Connector Pins.....	59
Table 8-8. GPIO and PWM Connector Pins.....	59
Table 8-9. Power Connector Pins for J17.....	60
Table 8-10. Power Connector Pins for J18.....	60

## 1 Trademarks

LightCrafter™ is a trademark of Texas Instruments.

DisplayPort™ is a trademark of DisplayPort.

DLP® is a registered trademark of Texas Instruments.

HDMI® is a registered trademark of HDMI.

All trademarks are the property of their respective owners.

## 2 About This Guide

This guide explains the hardware and software features of the DLP LightCrafter Single DLPC900 EVM systems. The EVM architecture and connectors are described along with a quick start guide on how to operate the DLP LightCrafter Single DLPC900 EVM using a Graphical User Interface (GUI). Specific details for each DLP component can be found in related component documentation.

### Note

Power supply, optics, illumination source, and cables are sold separately.

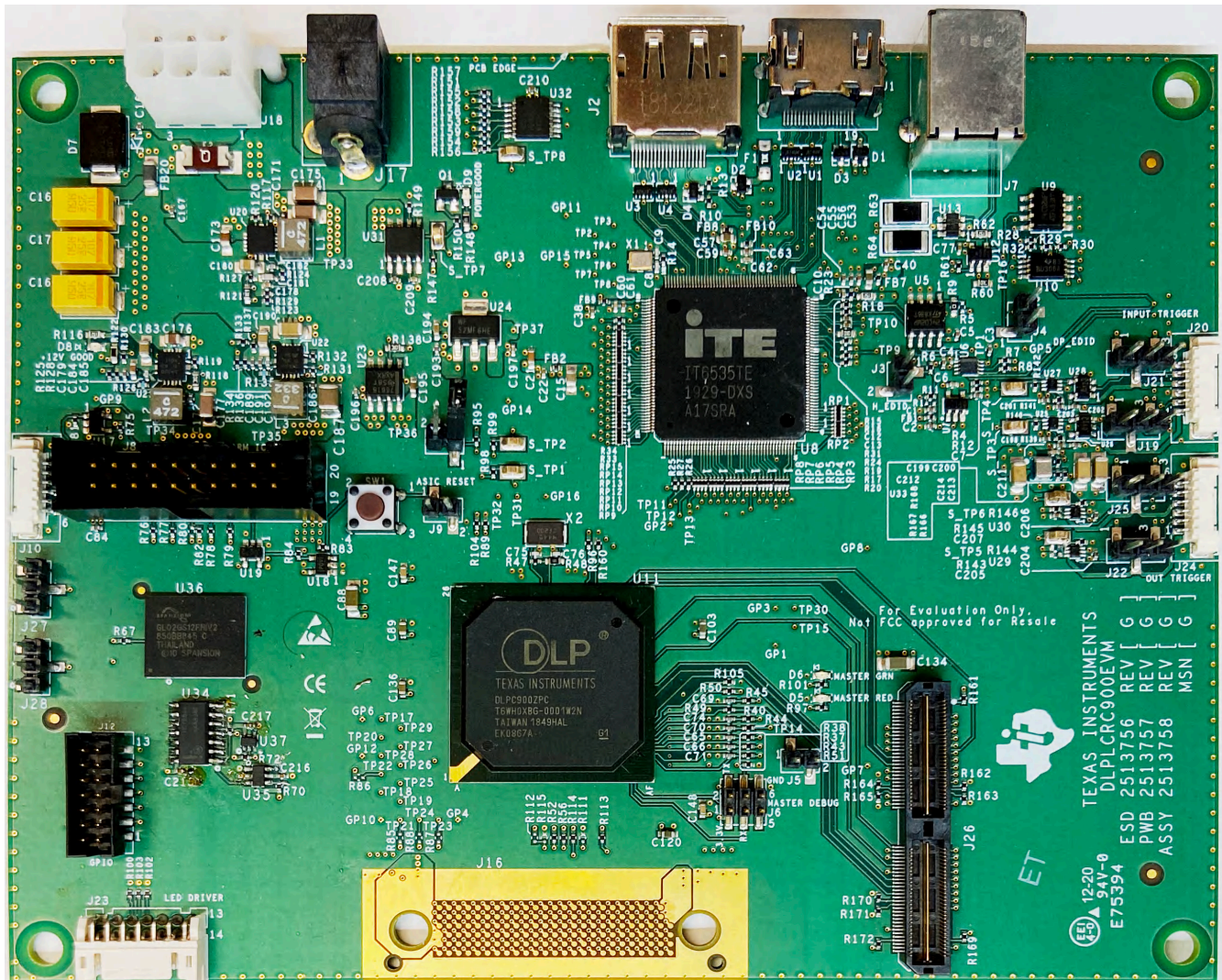

Figure 2-1. DLP LightCrafter Single DLPC900 Evaluation Module

### 3 Related Documentation from Texas Instruments

Component datasheets, technical documents, design documents, and ordering information can be found at the following links:

- [DLPC900 Digital Controller Product Folder](#)
- [DLPC900 Programmer's Guide](#)
- [LightCrafter Single DLPC900 EVM Product Folder](#)
- [DLP6500FYE DMD Product Folder](#)
- [DLP LightCrafter DLP6500FYE DMD EVM Product Folder](#)
- [DLP5500 DMD Product Folder](#)

### 4 If You Need Assistance

Refer to the [TI E2E DLP products forum](#).

## 5 DLP LightCrafter Single DLPC900 EVM Overview

### 5.1 Welcome

The DLP LightCrafter Single DLPC900 EVM, coupled to a supported Single Controller DMD EVM allows for easy evaluation of the DLP LightCrafter subsystem in bringing together high resolution display and advanced pattern control which is well suited for:

- Structured light applications
  - Factory automation and 3D machine vision
  - In-line automated optical 3D inspection
  - Robotic 3D vision
  - Offline 3D metrology
  - 3D scanners
  - 3D identification and biometrics
- 3D printing and additive manufacturing
- Medical and life sciences
- High speed imaging and display



## 5.2 DLP LightCrafter Single DLPC900 Evaluation Module (EVM) Hardware

The DLP LightCrafter Single DLPC900 EVM is one half of a complete DMD imaging electronics subsystem. The DLP LightCrafter Single DLPC900 EVM consists of the single DLPC900 board which includes a single DLPC900 Digital Controller, a digital video receiver, flash memory, power management circuits, and supporting digital logic.

Also needed to complete the imaging subsystem is a DLP LightCrafter Single Controller DMD EVM which is compatible with the LightCrafter Single DLPC900 EVM. A DMD EVM consists of a DMD, a DMD board (pcb) containing on-board DMD power circuits, DMD mounting hardware when necessary, and a flexible (pcb) cable for connections to the Single DLPC900 board.

Figure 5-1 outlines the major hardware components of a DLP LightCrafter Single DLPC900 System Hardware Components.

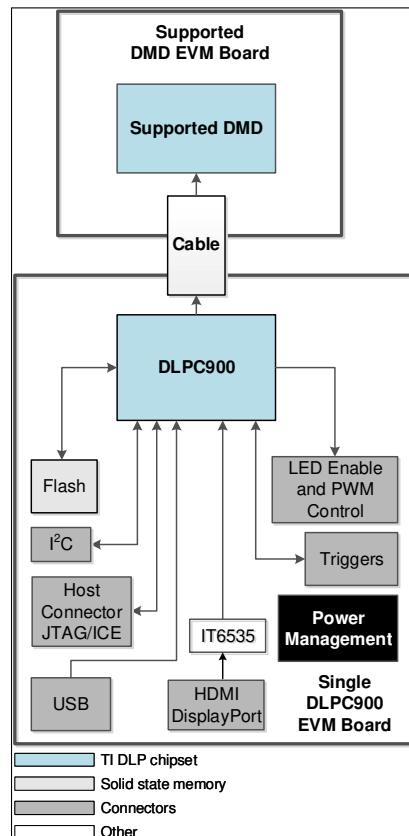
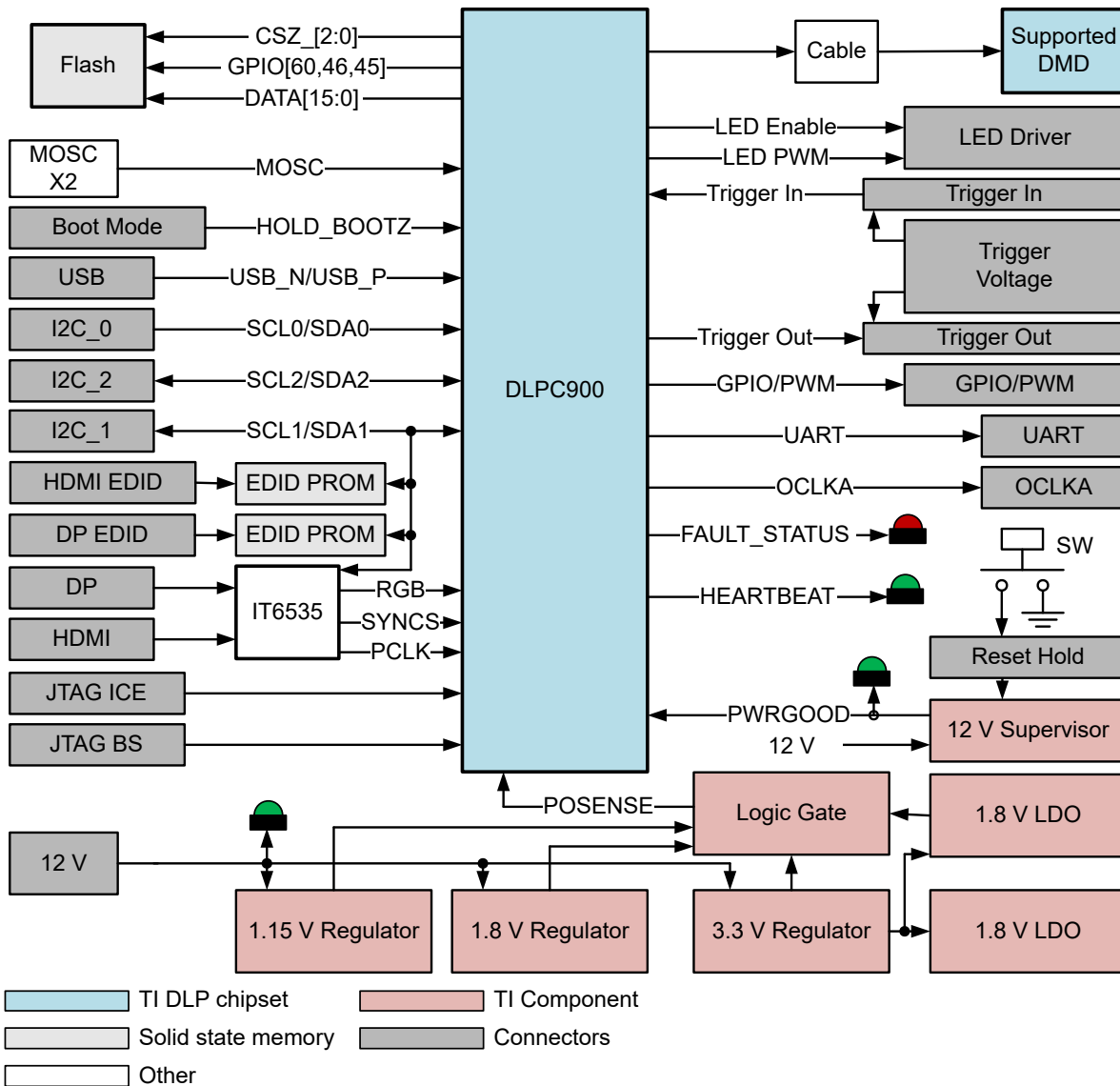

Figure 5-1. DLP LightCrafter Single DLPC900 Hardware Components

### 5.3 EVM Board

The DLP LightCrafter Single DLPC900 EVM contains the electronics capable of controlling supported Single controller DMDs. The EVMs offer several interface options, USB, I<sup>2</sup>C, trigger inputs and outputs, with video inputs through HDMI or Display Port connectors. Figure 5-2 shows the EVM block diagram of the DLP LightCrafter Single DLPC900 EVM.



**Figure 5-2. DLP LightCrafter Single DLPC900 EVM Block Diagram**

The DLP LightCrafter Single DLPC900 EVM major components are:

- A DLPC900 Digital DMD Controller
- Parallel FLASH memory for storing programming and pattern images for the DLPC900
- All necessary power supplies to support the DLP subsystem
- One IT6535 digital receiver for HDMI and Display Port Video Input

## 5.4 Other Items Needed for Operation

The DLP LightCrafter Single DLPC900 EVM is a flexible, ready-to-use evaluation module which, when coupled to one of the DLP LightCrafter DMD EVMs, enables the sending of customer created patterns from the DLPC900 Controllers to the attached DMD for display at the customer determined pattern rates. The DLP LightCrafter Single DLPC900 EVM and the DMD EVMs are offered for purchase separately so that customers can determine which elements they wish to piece together for their own application evaluation system.

The following items are not included with the EVM and need to be purchased separately if needed for customer evaluation:

- Power supply - see [Section 9.1 External Power Supply Requirements](#) for details
- USB cable: Type A to Type B USB cable
- HDMI® or DisplayPort™ cable connected to a graphics or video source (if using video input)
- Illumination module or source
- Illumination and projection optics



### 5.5 DLP LightCrafter Single DLPC900 Connections

Figure 5-3 depicts the switches and connectors with their respective locations. Note: Power supply (and cable), USB cable, and display cable are NOT included with the module.

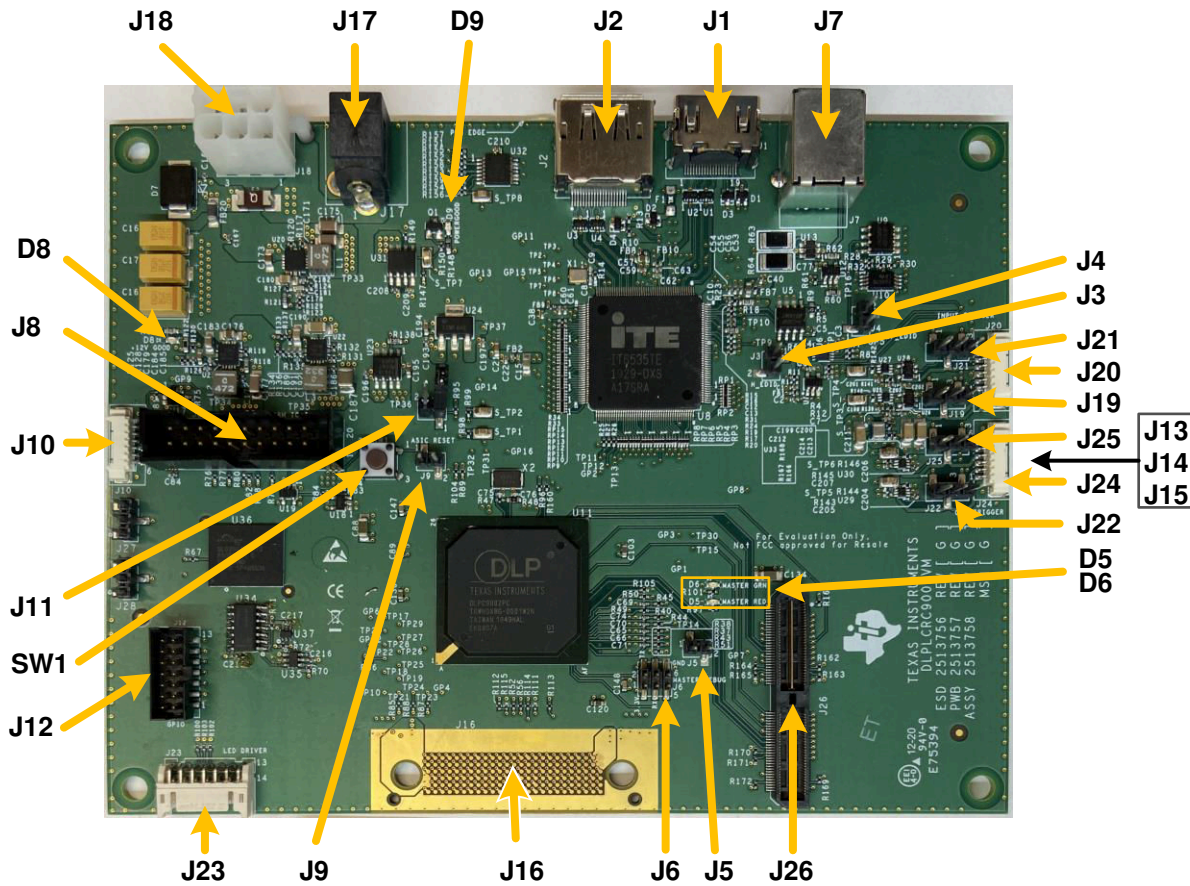

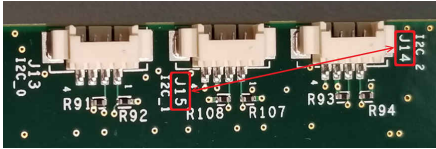

Figure 5-3. DLP LightCrafter Single DLPC900 EVM Connectors (Top View)

Table 5-1. DLP LightCrafter Single DLPC900 EVM Connector Reference

Connector Reference	EVM Function	Description or Use
SW1	Hardware Reset Switch	When pressed resets the DLPC900 controller. When released, the controller boots from reset.
J1	HDMI Input	HDMI video input (primary).
J2	DisplayPort Input	DisplayPort video input (secondary).
J3	EDID jumper (HDMI)	When jumper is installed, the EDID prom for the HDMI interface can be updated.
J4	EDID jumper (DisplayPort)	When jumper is installed, the EDID prom for the DisplayPort interface can be updated.
J5	OCLKA output	User configurable DLPC900 output clock for additional user on board logic. Pin 1 = OCLKA; Pin 2 = GND
J6	DLPC900 debug UART	DLPC900 UART interface for debug messages to a terminal <ul style="list-style-type: none"> <li>• Bits per second: 115200</li> <li>• Data bits: 8</li> <li>• Parity: None</li> <li>• Flow Control: None</li> <li>• Pin 1 = 3.3 V</li> <li>• Pin 2 = TX out</li> <li>• Pin 6 = Ground</li> </ul> LVTTTL compatible only
J7	Host USB interface	DLPC900 USB interface for Host communications with DLPC900

**Table 5-1. DLP LightCrafter Single DLPC900 EVM Connector Reference (continued)**

Connector Reference	EVM Function	Description or Use
J8	ARM RVI ICE debugger	TI use only; Used for debugging DLPC900 ARM software code, requires the ARM RVI ICE debugger.
J9	DLPC900 Reset jumper	When jumper is installed, the controller is held in RESET.
J10	JTAG Boundary Scan	Used for programming the boot image into the flash memory when flash memory is blank or corrupted.
J11	BOOTHold jumper	When jumper is installed, forces the controller to remain in boot mode when power is applied.
J12	GPIO inputs/outputs	User configurable general purpose Inputs and/or outputs for customer use.
J13	Host I <sup>2</sup> C Port 0	Host dedicated I <sup>2</sup> C interface port for communications to DLPC900. [Pin 1 = SCL, Pin 2 = SDA, Pin 3 = 3.3V, Pin 4 = GND]
J14	Host I <sup>2</sup> C Port 1	I <sup>2</sup> C interface port for programming EDID UARTs via I <sup>2</sup> C [ Pin 1 = SCL, Pin 2 = SDA, Pin 3 = 3.3V, Pin 4 = GND]
J15	Host I <sup>2</sup> C Port 2	I <sup>2</sup> C interface port 2. For TI internal use. [ Pin 1 = SCL, Pin 2 = SDA, Pin 3 = 3.3V, Pin 4 = GND]
<p><b>Note</b></p> <p>On several board lots, the silk screen jumper labels <i>J14</i> and <i>J15</i> are swapped. Labels <i>I2C_1</i> and <i>I2C_2</i> on all boards are correct. The correct jumper labels are <i>I2C_1</i> is <i>J14</i> and <i>I2C_2</i> is <i>J15</i>.</p>		
		
<p><b>Figure 5-4. Correct J14 and J15 Labels</b></p>		
		
<p><b>Figure 5-5. Incorrect J14 and J15 Labels</b></p>		
J16	DMD flex connector (DLPC900)	Flex cable connection for data interface to DMD board and DMD.
J17	+12 VDC Power input	EVM power input. [Pin 1 = +12 VDC, Pin 2,3 = GND] See <a href="#">Section 9.1</a> .
J18	+12 VDC Power input (Alternate)	EVM power alternate input. [Pin 1,2,3 = GND, Pin 4,5,6 = +12 VDC] See <a href="#">Section 9.1</a> .
J19	Trigger Input 1 voltage level selectors.	Set the voltage levels of the Trigger Input 1 signals. <ul style="list-style-type: none"> <li>Jump across pins 1 to 2 for 3.3 V</li> <li>Jump across pins 2 to 3 for 1.8 V</li> </ul>
J20	External Input Triggers connector	Trigger input 1 and 2 for triggering the DLPC900 with external input signals (from Cameras, processors, etc.). See <a href="#">Section 8.1</a> .
J21	Trigger Input 2 voltage level selectors.	Set the voltage levels of the Trigger Input 2 signals. <ul style="list-style-type: none"> <li>Jump across pins 1 to 2 for 3.3 V</li> <li>Jump across pins 2 to 3 for 1.8 V</li> </ul>
J22	Trigger Output 1 voltage level selectors	Set the voltage levels of the Trigger Output 1 signals. <ul style="list-style-type: none"> <li>Jump across pins 1 to 2 for 3.3 V</li> <li>Jump across pins 2 to 3 for 1.8 V</li> </ul>

**Table 5-1. DLP LightCrafter Single DLPC900 EVM Connector Reference (continued)**

Connector Reference	EVM Function	Description or Use
J23	LED illuminator enables and PWM drive signals	<ul style="list-style-type: none"> <li>• Pins 1, 2, and 3 are 12 V.</li> <li>• Pin 5 is Red LED Enable output.</li> <li>• Pin 6 is Green LED Enable output.</li> <li>• Pin 7 is Blue LED Enable output.</li> <li>• Pin 8 is RED PWM output.</li> <li>• Pin 9 is Green PWM output.</li> <li>• Pin 10 is Blue PWM output.</li> <li>• Pin 11 is 3.3V.</li> <li>• Pins 12, 13, and 14 are ground.</li> </ul>
J24	Trigger Output connector	Trigger outputs 1 and 2 for triggering external devices. See <a href="#">Section 8.2</a> .
J25	Trigger Output 2 voltage level selectors	Set the voltage levels of the Trigger Output 2 signals. <ul style="list-style-type: none"> <li>• Jump across pins 1 to 2 for 3.3 V</li> <li>• Jump across pins 2 to 3 for 1.8 V</li> </ul>
J26	External Parallel Video Connector	Used for direct connection to an external parallel video source.
D5	DLPC900 Red fault status LED	When lit indicates a fault has occurred in the DLPC900 controller.
D6	DLPC900 Green Heartbeat LED	When toggling indicates DLPC900 controller is operating. <hr/> <p style="text-align: center;"><b>Note</b></p> <p style="text-align: center;">The heartbeat will operate even if no DMD is present.</p> <hr/>
D8	12-V Power LED	When lit indicates external 12-V supply is on.
D9	PWRGOOD LED	When lit indicates power is within the expected limits.

### 5.5.1 DLP LightCrafter Single DLPC900 LED Enable and PWM Outputs

The LED enables on J23 are low-current 3.3-V outputs and are not to be used to drive LEDs directly. The enables are to be used as a control to enable a regulator that provides the necessary current to the LEDs. The PWM outputs are also 3.3-V outputs and used for controlling the current to the LEDs, which controls the brightness.

---

#### Note

The 12-V DC output on J23 are not to be used to power the LED drive circuitry since it does not provide the necessary current when all three LED enables are simultaneous turned on. Doing so can cause a drop in the 12-V supply to the EVM regulator circuitry and reset the controller.

---

### 5.5.2 DLP LightCrafter Single DLPC900 Trigger Input and Output Voltage Selectors

The trigger inputs on J20 are inputs from external devices to control the pattern sequence. While trigger input 2 is high, trigger input 1 advances the pattern sequence to the next pattern that is waiting for a trigger input. See [Reordering a Pattern Sequence using the Edit LUT Feature](#) for more information.

The trigger outputs on J24 are outputs to control external devices. While trigger output 1 frames the exposure time of the pattern, trigger output 2 pulses to mark the beginning of each pattern with a 19.4  $\mu$ s pulse.

Both input and output triggers have voltage level selectors. Use J19, J21, J22, and J25 to select the voltage as shown in [Section 8.1](#) and [Section 8.2](#). If no voltage is selected, then the onboard logic is not functional and any outgoing or incoming signals are not available.

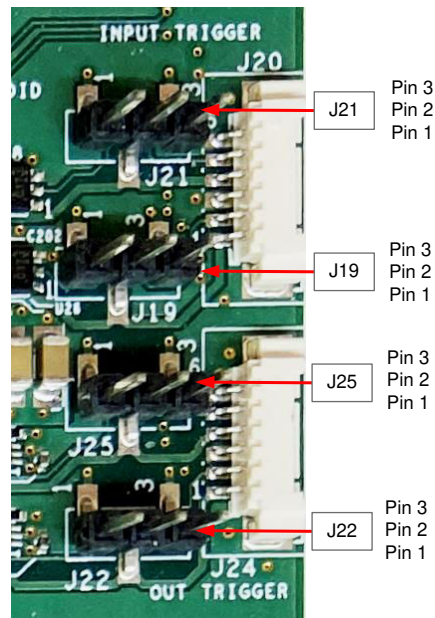
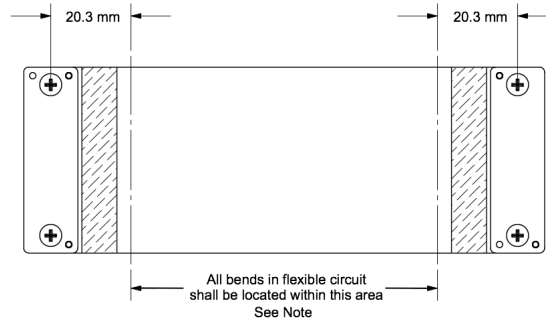

**Figure 5-6. DLP LightCrafter Single DLPC900 EVM Trigger Voltage Level Selectors**

## 5.6 DLP LightCrafter Single DLPC900 EVM Flex Cable

Electrical malfunctions can occur by stressing the flex cable connecting the DMD circuit board to the DLPC900 controller circuit board. Stressing the flex cable can be caused by:

- Bending the cable outside the area identified in [Figure 5-7](#) (within 20.3 mm of connector plate centers).
- Repeatedly bending the flex cable(s) where the bend radius is less than 25.4 mm.
- A single bending of the flex cable(s) where the bend radius is less than 6.35 mm.



**Figure 5-7. Flex Cable Diagram**

### Note

The minimum bend radius for forming flex cable (flexible) circuit is 6.35 mm.

Use caution when bending the flex cable to not exceed bending guidelines explained above.

## 5.7 DLP LightCrafter Single DLPC900 EVM and DMD EVM Assembly

The DLP single DLPC900 EVM requires a suitable DMD EVM such as the DLPLCR65EVM.

- The flex cable provided with the DMD EVM has one end marked "DMD End" with key pins arranged diagonally that only fit one way onto the DMD board preventing attachment to the wrong side of the board. Place the insulated backer plate on the other side of the DMD board from the flex side with connection pins and carefully tighten the screws. Alternate tightening the screws from side to side until the screws are firm, but not overtightened (SCREW TORQUE REQUIREMENT: 6-8 in-lb [0.7-0.9 N-m]). [Figure 5-9](#) shows the flex cable DMD ends correctly assembled to an example DMD board.
- The other end of the flex cable attaches to the single DLPC900 controller board. The key pins are arranged laterally symmetric and are able to be inserted from either side of the controller board. To ensure the cables are connected to the correct side of the single DLPC900 controller board, check that the connection flex pins are facing the pads shown in [Figure 5-8](#). Place the insulated backer plate on the other side of the controller board from the flex side with pins and carefully tighten the screws. Alternate tightening the screws from side to side until the screws are firm, but not overtightened (SCREW TORQUE REQUIREMENT: 6-8 IN\*LB [0.7-0.9 N\*m]). [Figure 5-9](#) shows the flex cable ends correctly assembled to the single DLPC900 controller board.

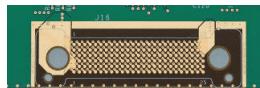

**Figure 5-8. DLPLCR900EVM Flex Cable Pad**

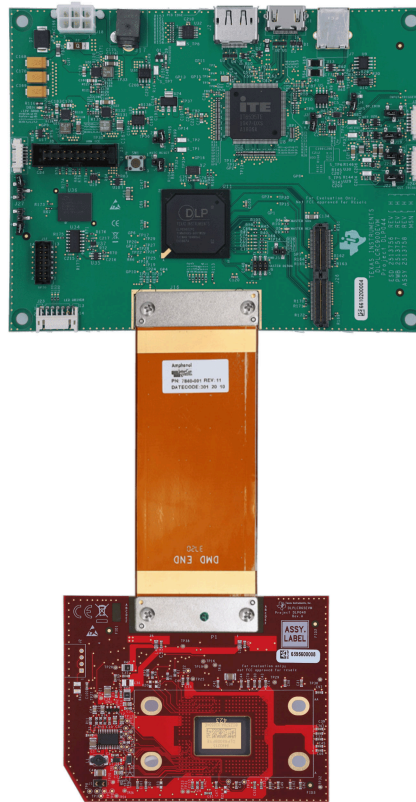

**Figure 5-9. Assembled DLPLC900EVM with DLPLCR65EVM**



## 6 Quick Start

This chapter offers a quick start guide to power-up the EVM, run the GUI control software, and create a simple three pattern sequence.

---

### Note

Be sure to install DLP LightCrafter GUI software version 5.0 and firmware 6.0 or newer. Operating the DLP LightCrafter Single DLPC900 EVM (DLPLCRC900EVM) with prior revisions of the GUI may render the EVM inoperable.

For DLP5500 DMD operation (DLPLCR55EVM) GUI version 5.2.x and firmware version 6.2.0 or newer is required.

---

### Note

If the text in the GUI does not display correctly, see [DPI Settings](#).

---

### 6.1 Power-up the DLP LightCrafter Single DLPC900 EVM

The DLP LightCrafter Single DLPC900 EVM is ready to use, out of the box, after assembling with a supported Single Controller DMD EVM. Steps 1 through 6 show how to power, display an image, and connect the EVM to a PC.

1. Connect a 12-V DC power supply to the power supply connector J17 in [Figure 5-3](#).
2. LEDs — D8 and D9 light up green to indicate configuration and power is within the expected limits.
3. LEDs — D6 toggles on and off, indicating the DLPC900 controller is operating.
4. After 5 seconds, the DLPC900 device starts sending a built-in rotating pattern sequence of images to the DMD for display on the DMD.
5. Connect a USB cable from a PC to connector J7 on the DLP LightCrafter Single DLPC900 EVM, as seen in [Figure 5-3](#). The first time the cable is connected on a PC, the DLP LightCrafter Single DLPC900 EVM enumerates as a USB composite device with human-interface device (HID) class. No drivers are required since these are natively handled by the Windows operating system.
6. The DLP LightCrafter Single DLPC900 EVM can be controlled with the GUI software and firmware versions that are available for download from [DLPC900REF-SW](#).

---

### Note

The DLPC900 does not have a dedicated INIT\_DONE signal output to indicate that it has completed its power-up initialization and is ready to accept commands. The user may configure one of the nine GPIOs available as an INIT\_DONE signal output simply by adding the GPIO configuration into a default batch file that is executed at power-up. A 10-k $\Omega$  pull-down resistor must be connected to the GPIO to be used.

The following is an example of adding the configuration for GPIO\_08 to a batch file, where GPIO\_08 is configured as an output and the signal is set high. When this command is added to the top of the batch file, the GPIO output goes high in approximately 800 ms from the time POSENSE goes high.

```
GPIO_CONFIG: 0x8 0x3
```

---

## 6.2 Creating a Simple Pattern Sequence

Before creating a pattern sequence, make sure to follow the steps in [Section 6.1](#). Download and execute the latest [DLPC900REF-SW](#) Windows-Installer, and then start the DLP LightCrafter DLPC900 GUI application. The GUI detects the attached EVM, and the *Connected* radio-button lights up **Green** indicating the connection was successful. The GUI software includes sample images for the DLP LightCrafter Single DLPC900 EVM that are used in the examples in this guide. If the sample image files have not been unzipped during the installation process, then within the GUI install directory, unzip the image files to gain access to all the sample images. All images are 1-bit binary patterns and have the native resolution of the attached DMD.

Follow these steps to create a pattern sequence. See [Figure 7-7](#) to identify the buttons on the Menu bar.

1. Select *Pattern On-The-Fly Mode* from the *Operating Mode* group box, and click the *Pattern Design* button so that the panel is displayed as shown in [Figure 6-1](#).
2. Click the *Add Pattern* button (with the plus sign) in the *Menu* bar and browse for any three bitmap images from the sample of images. The default directory location is C:\Texas Instruments-DLP\DLPC900REF-SW-5.x\DLPC900REF-GUI\Images and Batch files\[DMD]\_Images. Be sure to select them from the correct image sub-folder for the EVM that is being used. All three images can be selected at the same time within the open file dialog window, but may not appear in the same order in the GUI as in the dialog window.

---

### Note

For the next three steps a selected pattern is indicated by a lighter gray selection area. See [Figure 6-2](#) which shows the third pattern (pattern 2) selected.

---

3. Select the first pattern (pattern 0) within the *Pattern Design* panel and choose a bit depth of 1. Set exposure to 100000  $\mu$ s, dark time to 50000  $\mu$ s, and select **Red** for the color.
4. Select the second pattern (pattern 1) and choose a bit depth of 1. Set exposure to 150000  $\mu$ s, dark time to 75000  $\mu$ s, and select **Green** for the color.
5. Select the third pattern (pattern 2) and choose a bit depth of 1. Set exposure to 200000  $\mu$ s, dark time to 100000  $\mu$ s, and select **Blue** for the color. [Figure 6-2](#) shows the pattern sequence.
6. Select the *Repeat* radio-button to continuously repeat the pattern sequence.
7. Click the *Update LUT* button to upload the pattern sequence definition including the three pattern images to the EVM.
8. Click the *Start* button to run the pattern sequence. The three selected patterns show for the timings entered in steps 3, 4, and 5 and repeat until Step 9 is completed.
9. Click the *Stop* button to stop the pattern sequence.

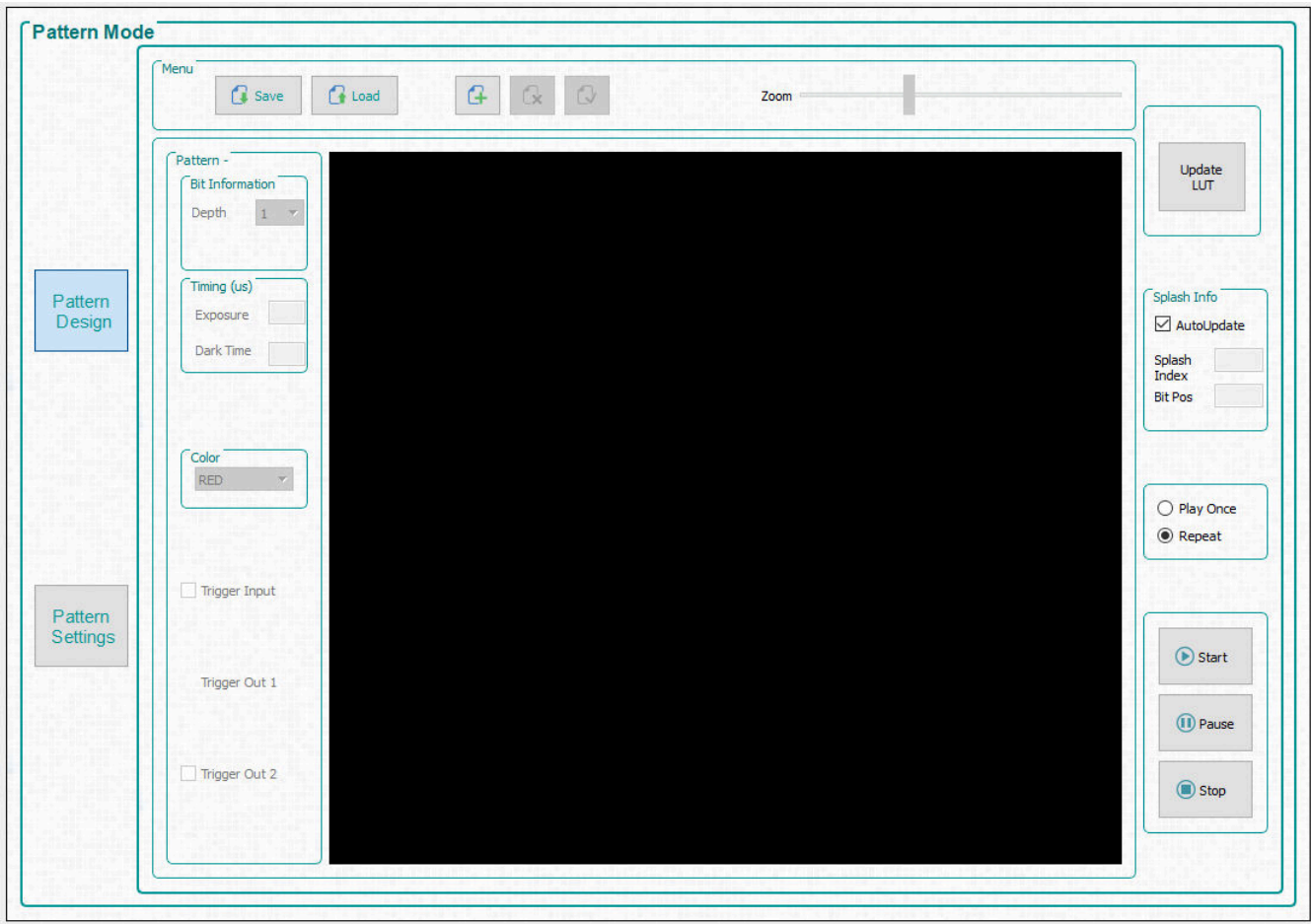

**Figure 6-1. Pattern Mode Panel**

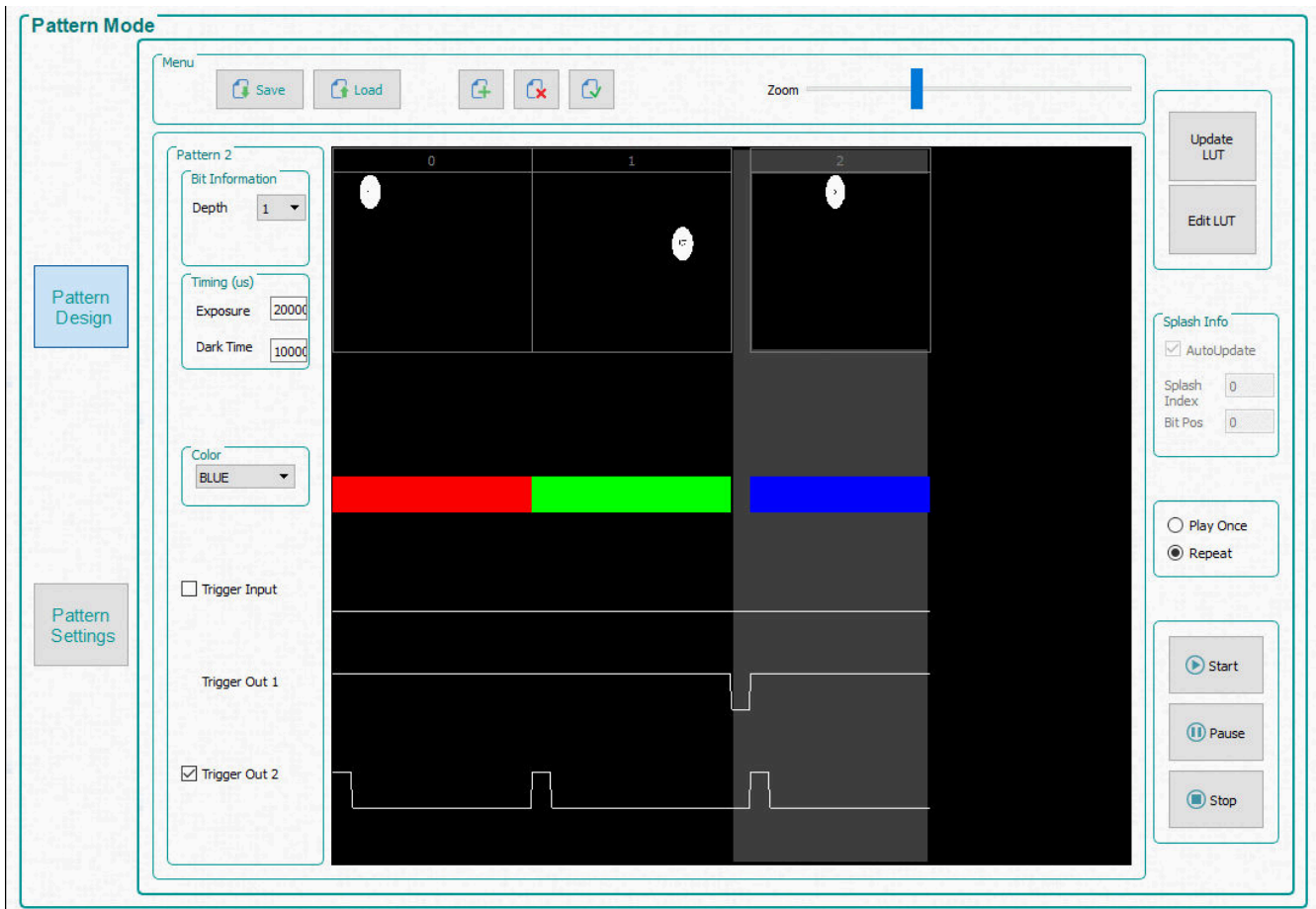

Figure 6-2. Simple Three Pattern Sequence

## 7 Operating the DLP LightCrafter Single DLPC900 EVM

This chapter introduces the Windows software provided with the DLP LightCrafter Single DLPC900 EVM.

### 7.1 DLP LightCrafter Single DLPC900 Control Software

The [DLPC900REF-SW](#) bundle includes a GUI application to control the modules through the USB interface. QT is a cross-platform application and user-interface framework with open source and commercial licenses available. Install the GUI download and execute the latest [DLPC900REF-SW](#) Windows-Installer, and then start the DLP LightCrafter DLPC900 GUI application.

The following items are found in DLPC900REF-SW:

- DLPC900REF-GUI – The software bundle includes the executable files for the PC-based Graphical User Interface (GUI) for easy communication over USB with the DLPC900 controller. The GUI was developed using the QT Library and the QT Creator. The GUI source code is provided so that the user can customize it as required or use it as a reference to create their own DLPC900 controller software interface.
- DLPC900REF-JTAG – The JTAG Flash Programmer gives developers the ability to load the DLPC900 configuration firmware into flash memory attached to a DLPC900 controller. JTAG boundary scan programming allows developers to install the DLPC900 firmware in the absence of standard USB connectivity. For example, the JTAG Flash Programmer is used if the bootloader becomes corrupted and the board is rendered inoperable.
- DLPC900REF-EDID – EDID files which can be programmed to the DLPC900EVM or DLPC900DEVM board according to the DMD the DLPC900 is controlling.
- DLPC900REF-FPGA – This binary file is used to configure the FPGA on the DLPC900EVM, to enable the display of 24-bit RGB data with dual DLPC900 controllers.

The DLP LightCrafter Single DLPC900 EVM supports two basic types of operation:

- Video Mode displays images from:
  - HDMI and DisplayPort inputs.
  - 24-bit RGB customer provided bitmaps stored in flash memory.
  - Internal test pattern generator with ten user-selectable patterns.
  - Solid Full-screen Curtain with user-selectable colors.
- Pattern Sequence displays images from:
  - Pre-stored Pattern Mode: 1-, 2-, 3-, 4-, 5-, 6-, 7-, and 8-bit user-defined bitmap images pre-stored in Flash memory.
  - Video Pattern Mode: 1-, 2-, 3-, 4-, 5-, 6-, 7-, and 8-bit user-defined bitmap images streamed through the DLPC900 24-bit RGB interface.
  - Pattern On-the-Fly Mode: 1-, 2-, 3-, 4-, 5-, 6-, 7-, and 8-bit user-defined bitmap images dynamically loaded into internal memory via USB or I<sup>2</sup>C interfaces.

## 7.2 PC Software

Upon execution of the DLP LightCrafter DLPC900 GUI application, the panel shown in [Figure 7-1](#) is displayed. The GUI panel contains the following three sections:

- System common controls and status on the left.
- System feature controls buttons on the top.
- Feature control panels in the center.

In any of the GUI sections, clicking a Get button reads the current settings of that particular subsection. Clicking the Set button programs the settings into the respective subsection. Please note that some commands may require additional steps before the GUI display is updated.

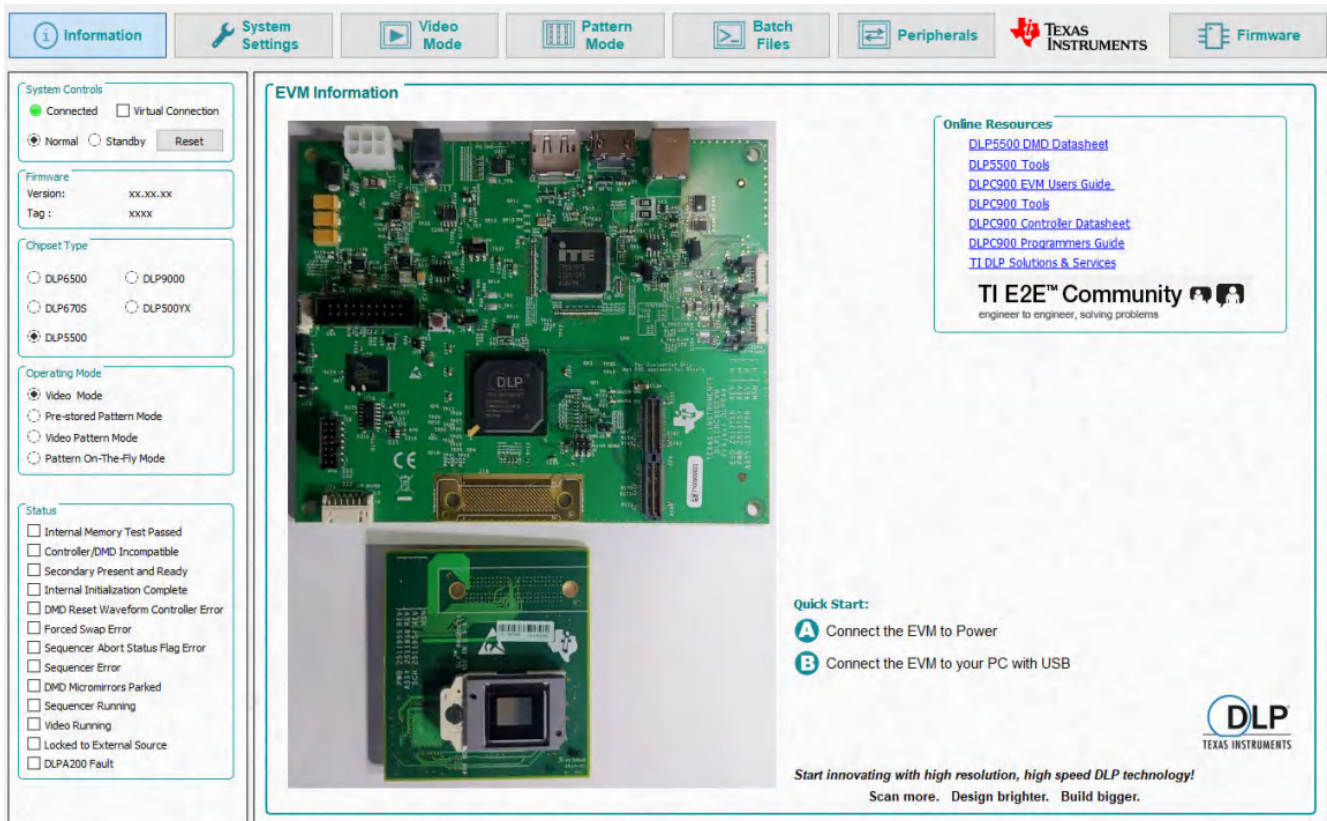
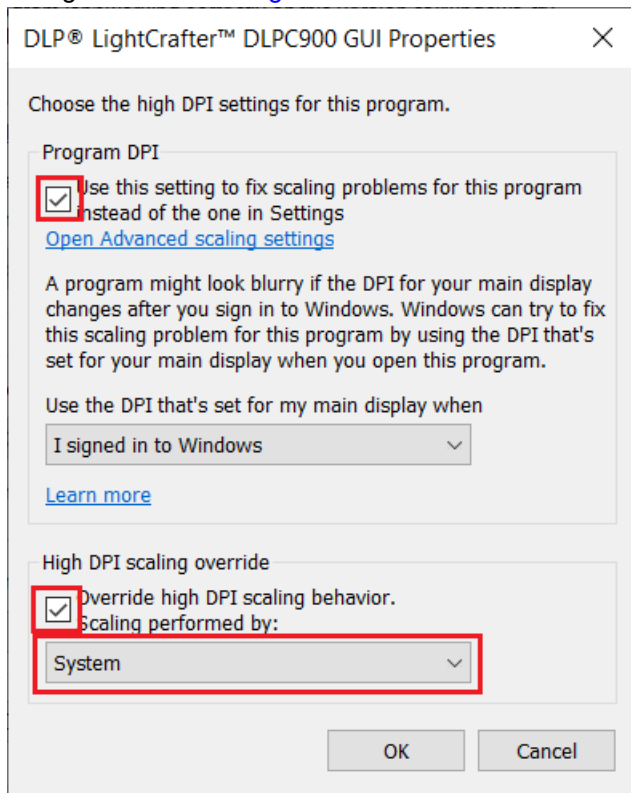

**Figure 7-1. DLP LightCrafter DLPC900 GUI**



**Note**

If the text in the GUI does not display correctly please change the DPI settings. Right click on the executable and select *Properties*. On the *Compatibility* tab select the "Change high DPI settings" button. Change your settings as shown in [Figure 7-2](#).



**Figure 7-2. High DPI Settings**

**7.3 System Common Controls**

The DLP LightCrafter Single DLPC900 EVM communicates with the DLPC900 using USB 1.1. The DLPC900 enumerates as a USB device with HID Support. The PC polls all the HID peripherals and once the PC detects the DLPC900, the *Connected* radio-button changes to **green**. If the USB cable is disconnected, the *Connected* radio-button changes to **red**. Once the *Connected* radio-button shows **green**, the firmware *Version* and the *Tag* name are displayed.

The *Virtual Connection* option is useful when there is no connection to the EVM. When the *Virtual Connection* is checked, all commands continue to operate as if there was a connection to the EVM except for firmware uploads, updating the Look Up Table (LUT), and get commands.

### 7.3.1 Operating Mode

Within the *System Controls* group box, the GUI updates the state of the EVM to indicate it is in *Normal Mode* or *Standby Mode*. The user may command the EVM into *Standby Mode* if the EVM is not being used or the *Normal Mode* can be selected to command the EVM to wake up. The user may click the *Reset* button to command the EVM to perform a software reset.

---

#### Note

When in Standby Mode the GUI suspends status updates until a return to operation or software reset is issued. If a hardware reset is asserted the GUI must be restarted to recognize return to operation.

Standby mode requires a wait period of two minutes to run 50/50 and park the DMD. Three additional seconds are needed to complete all operations before issuing a Return to Normal Mode command.

Once Standby has been issued the only command accepted by the DLPC900 controller board is Return to Normal Mode (0). **Any other command can result in unexpected behavior.** In particular, a Park/Unpark is not accepted until Normal mode is resumed. Using the isolated Park/Unpark command is no longer recommended except for debugging purposes.

---

The EVM can be commanded to enter one of the four operating modes. Within the *Operating Mode* group box there are four choices:

1. *Video Mode* – This mode is primarily used for display applications, and is not recommended for applications which require pixel and timing accuracy. In this mode, the user can choose from the four following video modes:
  - Parallel RGB interface
  - Internal test pattern generator with ten test pattern options
  - Pattern image display from flash memory
  - Solid Curtain with choice of color
2. *Pre-stored Pattern Mode* – In this mode, the user can create a pattern sequence using images stored in flash.
3. *Video Pattern Mode* – In this mode, the user can define a pattern sequence using pattern data or video which is streamed using a parallel RGB interface.
4. *Pattern On-The-Fly Mode* – In this mode, the user can create a pattern sequence using bitmap images which are loaded into the internal memory of the DLPC900 via the USB or I<sup>2</sup>C interfaces. This mode can be helpful to view a pattern sequence before storing the images in flash memory, as updating the flash to use *Pattern Mode* can be a timely process.

### 7.3.2 Connected DMD Type

The GUI queries the DLP LightCrafter Single DLPC900 EVM to determine the DMD type the firmware is programmed for and is expecting to be connected to the DLP LightCrafter Single DLPC900 EVM. The indicators in the *Chipset Type* group box are updated to show which DLPC900 compatible DMDs is connected.

### 7.3.3 EVM Information

The *Introduction Main Page* shows an image of the EVM currently connected and helpful links to online resources.

### 7.3.4 Status

The *Status* panel indicators show the current state of the DLPC900. When any of the boxes are checked, this indicates the stated text has occurred. Any boxes that state an error and remain checked must be corrected before continuing to operate the EVM.

The following is a description of each status indicator:

- *Internal Memory Test Passed* – The DLPC900 performs an internal system memory test at power-up. The box is checked if the test passed.
- *Controller/DMD Incompatible* – The box is checked if either the controller or DMD are incompatible with the firmware including loading incorrect firmware or an issue with communication between the controller and DMD. Check for possible damage to the DMD SCP lines, or damage to the flex cable. Also ensure that the DMD is sitting properly in the socket, and is not missing or damaged.
- *Secondary Present and Ready* – The box is checked when the GUI is connected to a DLP LightCrafter Dual DLPC900 EVM. If the GUI is connected to a DLP LightCrafter Single DLPC900 EVM and the box is checked then the DLPC900 is potentially malfunctioning or was incorrectly programmed with one of the Dual DLPC900 firmware files.
- *Internal Initialization Complete* – The box is checked when all power-up initialization routines have completed and passed.
- *DMD Reset Waveform Controller Error* – The box is checked whenever the DMD Reset Controller has found multiple overlapping Vbias or reset operations accessing the same DMD block of micromirrors.
- *Forced Buffer Swap* – The box is checked whenever a forced buffer swap occurs. This error can occur if the DLP LightCrafter Single DLPC900 EVM is set to Video Mode and the vertical back-porch timing is too small. The error can also occur if the DLP LightCrafter Single DLPC900 EVM is set to Video Pattern Mode where the patterns are from the video port and the pattern sequence timings do not match the video port VSYNC - specifically the cumulative exposure times are greater than the frame time. Forced buffer swaps may also occur during any of the pattern modes in preparing a pattern sequence and the timing of a status read. The user may need to perform additional reads of the status to get a correct state of this indicator. If the box continues to be checked, check for an error condition in the pattern sequence.
- *Sequence Abort Status Flag* – The box is checked whenever a sequence abort has occurred. Sequence abort may occur during any pattern mode in preparing a pattern sequence and the timing of reading the status. Additional status reads may be needed to get a correct state of this indicator. If the box continues to be checked, check for an error condition in the pattern sequence. Also check that the cumulative exposure time is not greater than the frame time.
- *Sequence Error* – The box is checked whenever a sequence error has occurred. Sequence errors may occur during any of the pattern modes in preparing a pattern sequence and the timing of reading the status. The user may need to perform additional reads of the status to get a correct state of this indicator. If the box continues to be checked, check for an error condition in the pattern sequence.
- *DMD Micromirrors Parked* – The box is checked whenever the DMD micromirrors are parked.
- *Sequencer Running* – The box is checked whenever the sequencer is running.
- *Video Running* – The box is checked whenever video is running.
- *Locked to External Source* – The box is checked to indicate that the EVM has *locked* to an external parallel RGB video source. If the EVM loses the locked signal at any time, the box becomes unchecked. A locked source must be present to switch to Video Pattern Mode.
- *DLPA200 Fault* – The box is checked whenever a [DLPA200](#) fault has occurred. The box is active when a DLP5500 DMD is connected.

## 7.4 System Settings

Click the *System Settings* button at the top of the GUI to display the *System Settings* panel shown in [Figure 7-3](#).

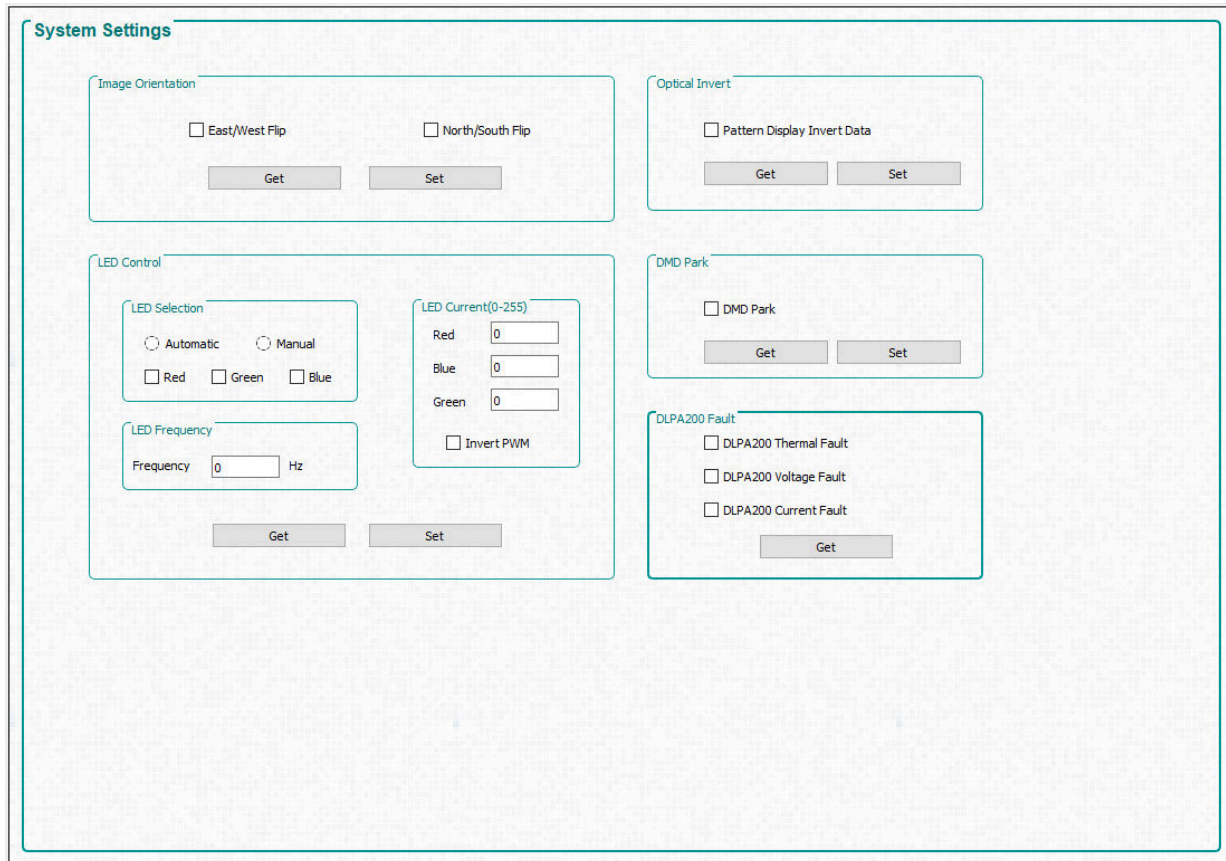

**Figure 7-3. System Settings Panel**

Within the *System Settings* panel, the user can control the orientation of the image, the LEDs, and the optical inversion.

- *Image Orientation* – Depending on the orientation of the projected image, the image may require to be flipped on its short or long axis. The *East/West Flip* setting causes the image to be flipped on its long axis. The *North/South Flip* setting causes the image to be flipped on its short axis. This setting must be set before any Pattern LUT updates are sent to the DLPC900 and the pattern sequence must be in the stopped state.
- *LED Controls* – The LED controls allow the user to manually control the state of the LEDs or allow the internal DLPC900 sequencer to control them.
- *DLPA200 Fault* – The user can read the status of the DLPA200, displayed as a checked box for any of the following: thermal fault, voltage fault, and current fault.

### Note

If the LEDs are disabled in manual control, they must be enabled before switching to automatic control (internal DLPC900 sequencer).

The LED current regulates the brightness of the LEDs. When manipulating the LED frequency and current, it is best to think of the led current value from 0-255 (0.39% per step) as the duty cycle where 255 equals ~100% (99.61%) Internally the software then calculates the PWM value depending on the set frequency and duty cycle. Setting the Invert PWM changes the polarity of the PWM signal which causes the LED currents to have an opposite effect on the LEDs as the current is changed.

### Note

DLP LightCrafter Single DLPC900 EVMs do not come with LEDs or optical engines of any kind.

- *Pattern Display Invert Data* – This setting allows the user to invert the data to the DMD. The setting must be set before any Pattern LUT updates are sent to the DLPC900 and the pattern sequence must be in the stopped state. This setting is not applicable to *Video Mode*.
- *DMD Park* – This setting allows the user to park and un-park the DMD. Using the isolated Park/Unpark command is no longer recommended except for debugging purposes. If the Display Mode is set to Pre-stored pattern mode, Video pattern mode or Pattern On-The-Fly mode, the pattern sequence must be stopped prior to execution of this command.



## 7.5 Video Mode

Click the *Video Mode* button at the top of the GUI to display the *Video Mode* panel. Within this panel, there are two tabs:

The Source Settings Tab is shown in [Figure 7-4](#).

The Display Settings Tab is shown in [Video Mode Panel - Display Settings Tab](#).

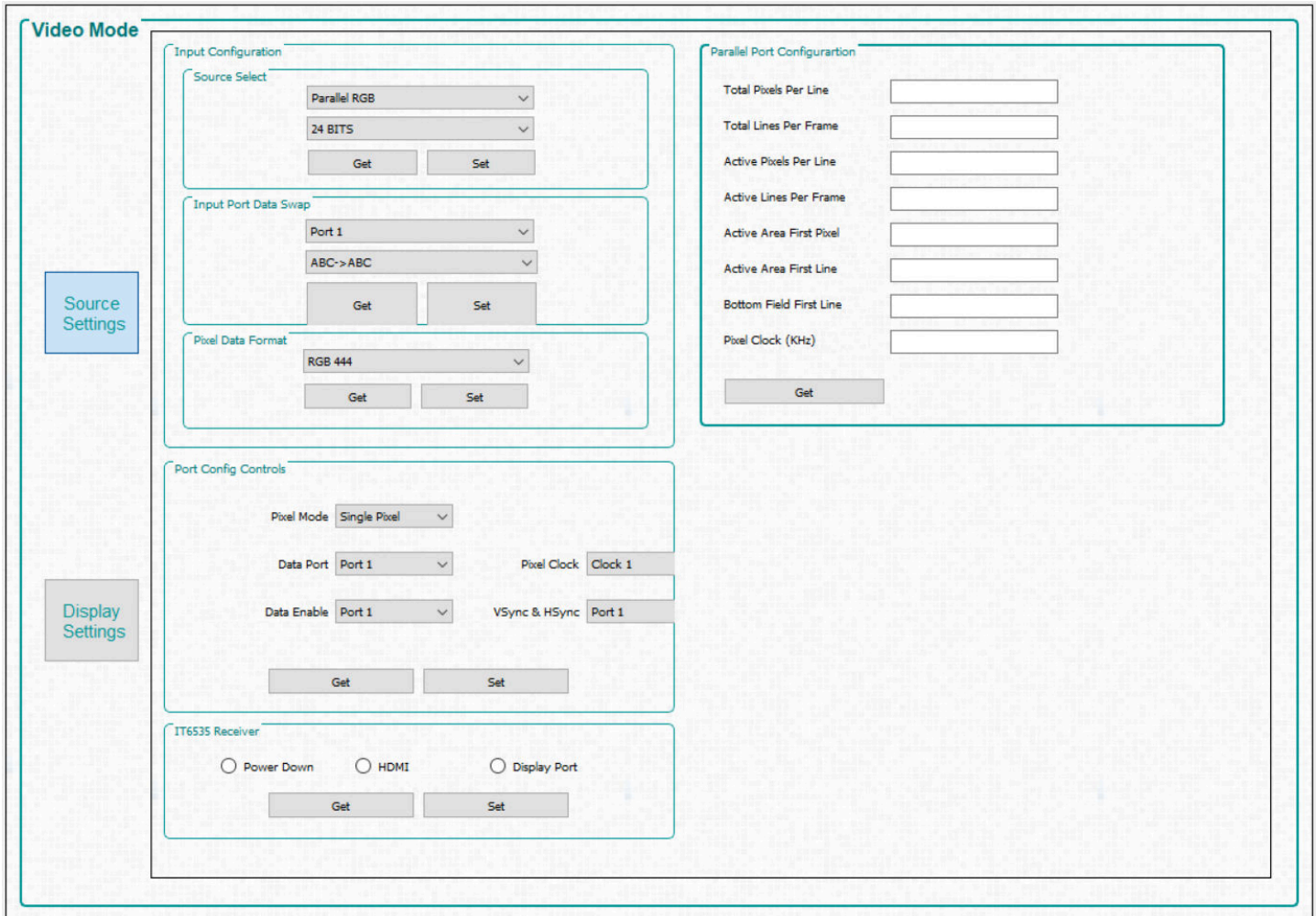

**Figure 7-4. Video Mode Panel - Source Settings Tab**

### 1. Input Configuration.

- *Source Select* – Allows the user to select :
  - a. Parallel RGB interface
  - b. Internal test pattern generator
  - c. Pattern images from flash memory
  - d. Solid Curtain– which displays a constant, solid color image (including black or white)
- *Input Port Data Swap* – Depending on the routing of the parallel RGB data lines, it may be necessary to swap the order of the color channels. The DLP LightCrafter Single DLPC900 EVM requires an RGB → GRB setting. The user selects which port to apply the settings.
- *Pixel Data Format* – Allows the user to select the video format of the input source.



2. **Port Config Controls** – Depending on which input signals were chosen during board design, it may be necessary to select the appropriate signals so that the DLPC900 can properly detect the incoming video source. If incorrect settings are chosen, the curtain may be displayed or the image may be incorrect. *Pixel Mode* can also be set to Single Pixel or Dual Pixel. Dual Pixel allows for higher data rates by loading two pixels per clock instead of one pixel per clock.

**Note**

Only Pixel Clock 1 is connected on the DLPLC900EVM. Selecting Pixel Clock 2 or 3 on the EVM will result in erratic behavior.

3. **IT6535 Receiver** – This control allows selection between the HDMI or the DisplayPort input connectors of the IT6535 digital receiver. The digital receiver can also be powered-down, which tri-states all the output signals of the IT6535 to allow another device to share the input ports and syncs of the DLPC900.
4. **Parallel Port Configuration** - Allows readback of the current parallel port configuration parameters determined by the EDID or user Display Dimensions. Values are read only from the primary controller.

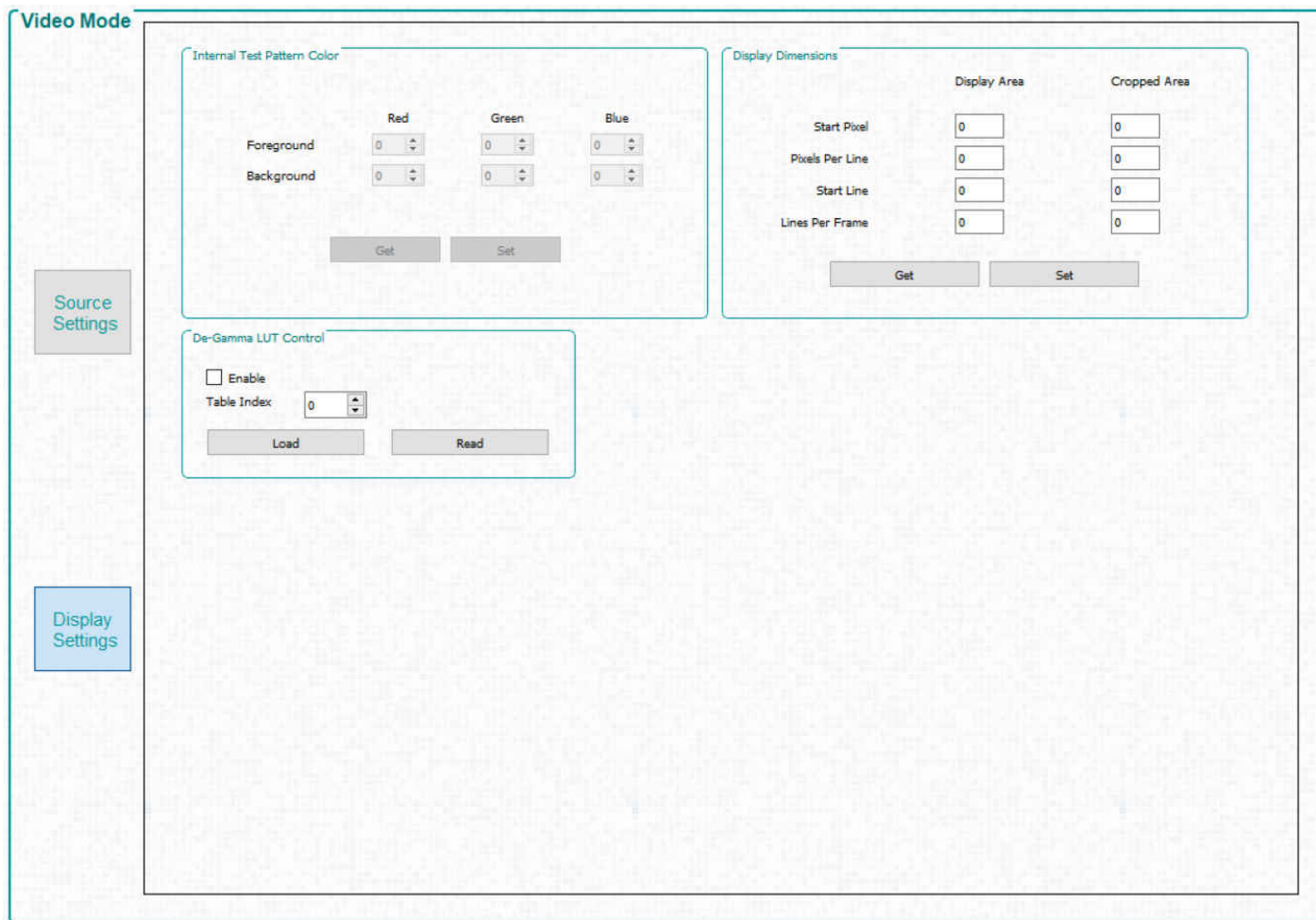

**Figure 7-5. Video Mode Panel - Display Settings Tab**

1. **Internal Test Pattern Color** – When the internal test pattern is selected as the input source, the foreground and background colors can be changed.
2. **Display Dimensions** – Allows the user to scale or crop the image of the incoming video source.
3. **De-Gamma LUT Control** – De-Gamma controls:
  - Enable/Disable - Command enables or disables De-Gamma
  - Sets the level of De-gamma - See the *Gamma Configuration and Enable* section of the [DLPC900 Programmer's Guide](#) for further information

## 7.5.1 Video Support

Please refer to the DMD data sheet of the DMD connected to the DLP LightCrafter Single DLPC900 EVM for supported video frame rates.

## 7.6 Pattern Modes

Click the *Pattern Mode* button at the top of the GUI to display the *Pattern Mode* panel as shown in [Figure 7-6](#).

The *Pattern Mode* panel allows the user to create a pattern sequence. First the user must choose the operating mode by selecting which of the three pattern modes to use. The three pattern modes are:

1. *Pre-Stored Pattern Mode*. In this mode the patterns are pre-stored in flash memory and loaded into the internal memory of the DLPC900 by the firmware. The pattern sequences and images must first be defined before starting the pattern sequence.
2. *Video Pattern Mode*. In this mode, the images are streamed from the incoming video source. The pattern sequences must be defined first before starting the pattern sequence.
3. *Pattern On-The-Fly Mode*. In this mode the patterns are uploaded to the internal memory of the DLPC900 via the USB or the I<sup>2</sup>C interface. The pattern sequences must be defined first before starting the pattern sequence. Using USB is preferred for its higher upload speed.

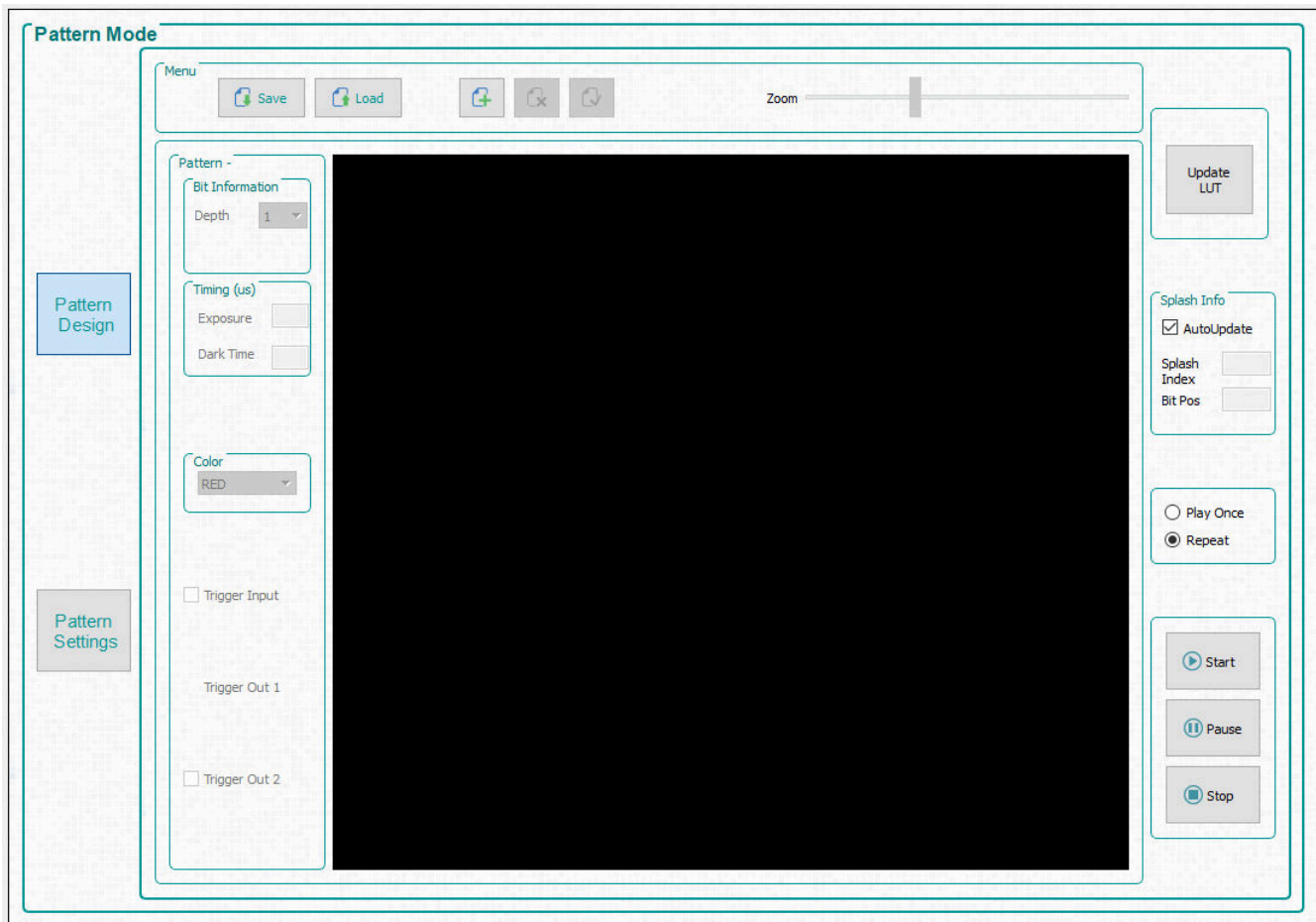

**Figure 7-6. Pattern Mode Design Panel**

### 7.6.1 Menu Bar

The *Menu* bar has six controls as shown in [Figure 7-7](#).

- The *Save* button allows the current pattern design to be saved to a file.
- The *Load* button allows a saved design to be loaded into the Design Panel. This control also allows images to be loaded from a text file that contains a list of the bitmaps in a desired order.
- The *Add* pattern button adds a single pattern or multiple patterns to be loaded into the Design Panel.
- The *Zoom* bar allows the Design Panel to show more of the patterns within the panel.
- The *Delete* pattern button deletes a selection of patterns (a single pattern or multiple patterns) from the Design Panel.
- The *Select* button selects all the patterns from within the Design Panel.

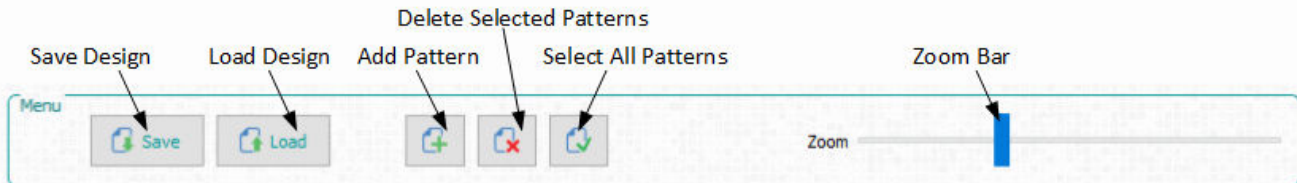

Figure 7-7. Pattern Mode Menu Bar

### 7.6.2 Creating a Pattern Sequence in Pattern On-The-Fly Mode

*Pattern On-The-Fly Mode* is the easiest and quickest way to create a pattern sequence. Follow these steps to create a simple pattern sequence using three images

1. Make sure the EVM is powered up and operating correctly, and the *Connected* radio-button is lit **green**.
2. Select *Pattern On-The-Fly Mode* from the *Operating Mode* group box, and then click the *Pattern Design* button so that the large black panel is displayed as shown in [Figure 7-6](#).
3. Click the *Add Pattern* button in the *Menu* bar and browse for any three bitmap images from the sample of images directory. Be sure to select them from the correct image folder for the EVM that is being used. All three images can be selected at the same time within the open file dialog window. When selecting multiple files at once, the operating system may not load the images in the same order as they were selected. To add images in a predefined order, use the *Load* button. This option loads the images from a text file that contains the file names of each bitmap in the desired order. Alternatively, you can add the images one at a time using the *Add Pattern* button to ensure order. [Figure 7-8](#) shows an example of loading images from a file. The bitmap images must be located in the same directory as the text file. See [Figure 7-9](#) after the images have been added.

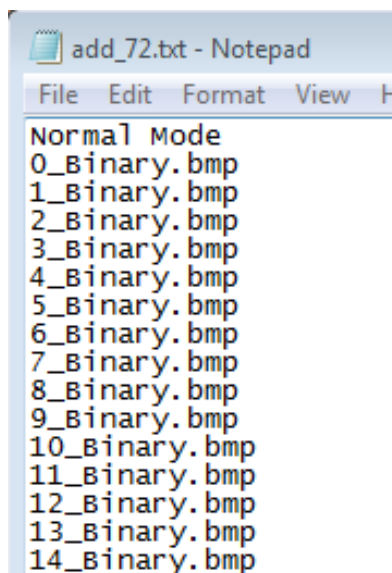

Figure 7-8. Add From List

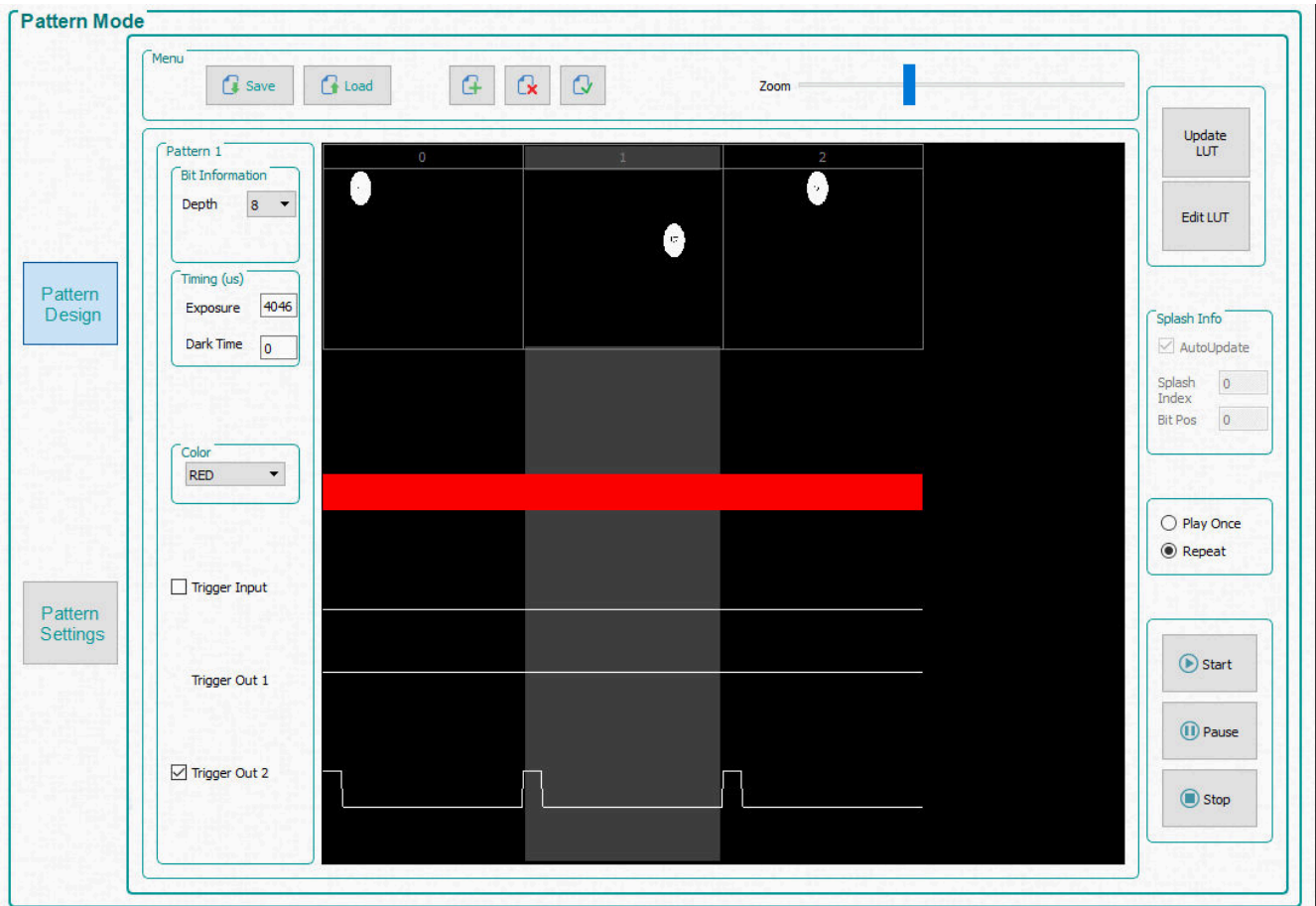
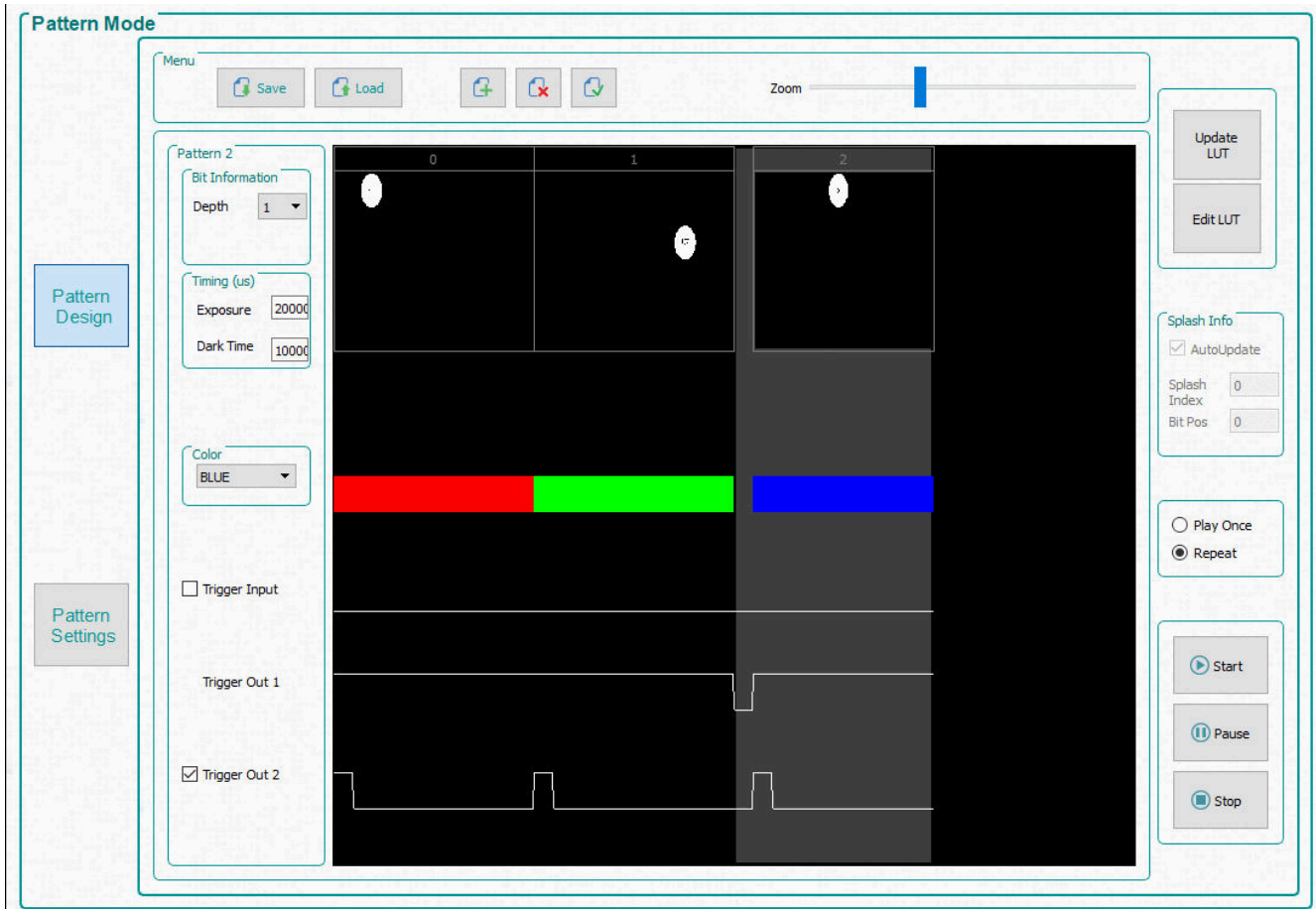

Figure 7-9. Pattern Sequence

4. Each pattern in the display can now be selected individually or a multiple selection can be done. To select multiple patterns in a series, use *Shift+Click*. To select multiple patterns that are not in a series, use *Ctrl+Click*. An alternate method for selecting all images is to use the *Select All Patterns* button on the *Menu* bar.
5. Select the first pattern and choose a bit depth of 1. Set exposure to 100000  $\mu$ s and set dark time to 50000  $\mu$ s. The dark time is the time from the end of one pattern to the start of the next pattern. Select **Red** for the color.
6. Select the second pattern and choose a bit depth of 1. Set exposure to 150000  $\mu$ s and set dark time to 75000  $\mu$ s, and select **Green** as the color.
7. Select the third pattern and choose a bit depth of 1. Set exposure to 200000  $\mu$ s and set dark time to 100000  $\mu$ s, and select **Blue** as the color. [Figure 7-10](#) shows the pattern sequence. The *Zoom* bar can be used to zoom in and out which is useful when many patterns are loaded into the panel.



**Figure 7-10. Three Pattern Sequence**

8. Select the *Repeat* radio-button to continuously repeat the pattern sequence, or, if only one time is desired, then select the *Play Once* radio-button.
9. Click the *Update LUT* button to upload the pattern sequence definition, including the three pattern images, to the DLPC900. Notice the green status bar indicating that the updated LUT is uploading to the EVM. This animation does not occur if the user only edits pattern settings rather than uploading actual new patterns. If there are any errors in the pattern sequence, the GUI displays an error message.
10. Once the upload is complete, click the *Start* button. The display repeatedly displays the Red, Green, and Blue dots.
11. To pause the pattern sequence, click the *Pause* button. To continue from where the pattern sequence paused, click the *Start* button.
12. To stop the pattern sequence, click the *Stop* button. To restart the pattern sequence click the *Start* button. The pattern sequence starts from the beginning whenever the pattern sequence is stopped using the *Stop* button.



Another method of creating a pattern sequence in *Pattern On-The-Fly Mode* is using a batch file that contains all the necessary commands and the compressed images.

Follow these steps to execute a pattern sequence using a batch file.

1. Stop the pattern sequence if it is currently running.
2. Click the *Batch Files* button at the top of the GUI.
3. Check the box to *Enable Command Logging*.
4. Click the *Clear All* button to clear any content in the panel.
5. Click the *Load Batch File* button and select the **onthe-fly.txt** file located in the sample images directory. Be sure to select the correct file for the EVM being used.
6. Click the *Execute All* button. Wait for the batch file to execute.
7. Click the *Pattern Mode* button at the top of the GUI.
8. Click the *Start* button.
9. Click the *Stop* button to end this example.

### 7.6.3 Creating a Pattern Sequence in Pre-Stored Pattern Mode

Creating a Pre-Stored Pattern sequence is very similar to *Pattern On-The-Fly Mode*. The difference is that the patterns are pre-stored in flash memory.

If images are not present in the flash memory, proceed to [Section 7.9.1](#) section to add the images to the firmware and upload them to the EVM, then return here for steps on creating the pattern sequence.

To start creating a Pre-Stored Pattern sequence, follow the steps in [Section 7.6.2](#) with the only change in step 2. In step 2, select the *Pre-Stored Pattern* radio-button and then proceed with step 3.



### 7.6.4 Reordering a Pattern Sequence using the Edit LUT Feature

The *Edit LUT* feature is only available in *Pre-Stored Pattern Mode* and *Pattern On-The-Fly Mode* when using GUI 4.0 or later in conjunction with Firmware 5.0 or later. This feature allows the user to manipulate the pattern display sequence without having to reload or change any data in the DLPC900 memory. The *Edit LUT* button appears on the right hand side of the *Pattern Mode* tab after adding patterns as described in [Section 7.6.2](#).

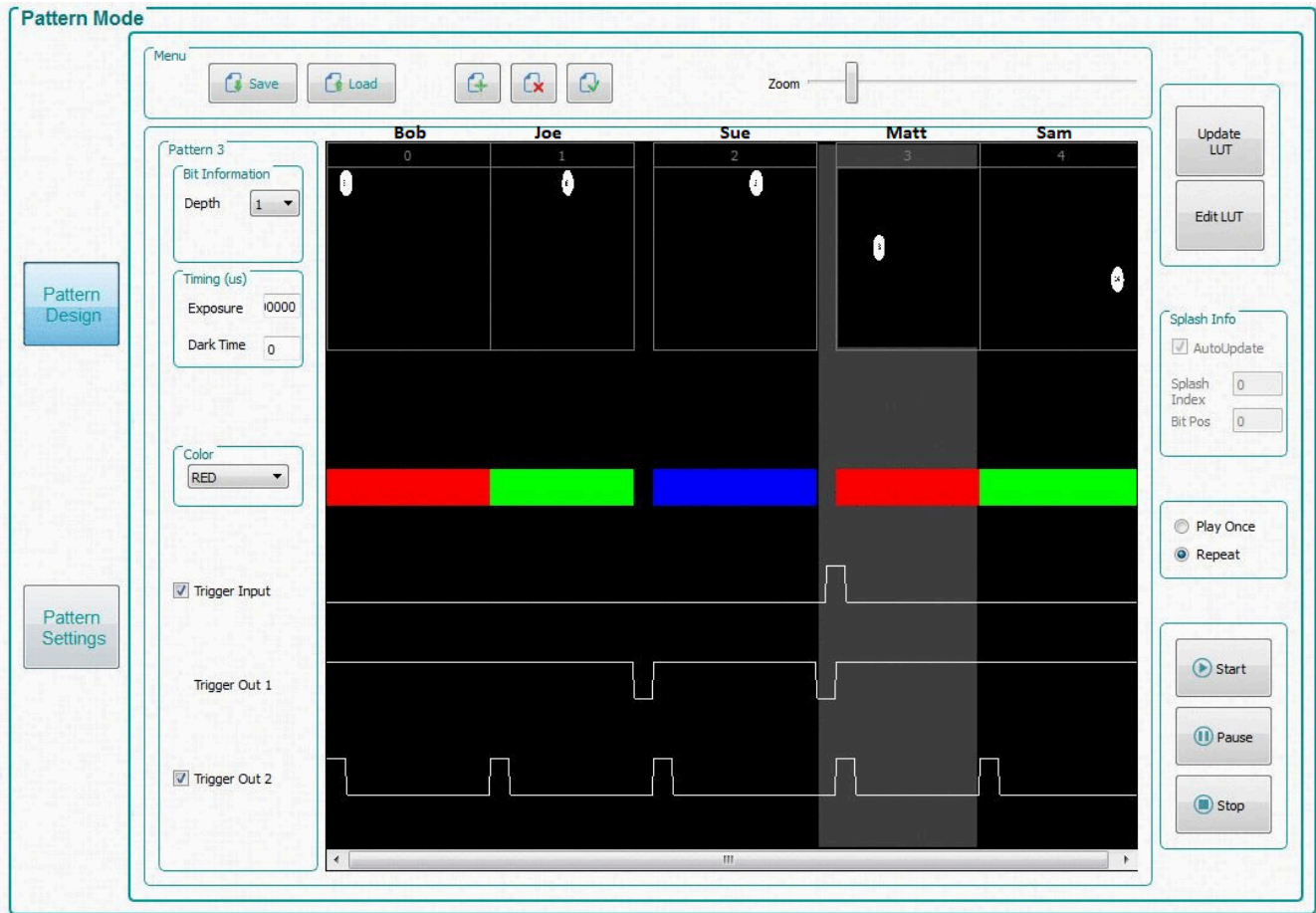

**Figure 7-11. Pattern Design Example**

The *LUT Editor* panel is shown in [Figure 7-12](#) where the column labeled “SNO” (i.e. Sequence Number) represents the pattern display slot numbers according to the order set (after clicking *Update LUT*) in the *Pattern Design* tab as shown in [Figure 7-11](#). The user can then reorder those patterns by either manually entering the pattern number of their choice into a row in the “LUT entry” column or loading a text file beginning with the word “Reorder” followed by the desired numerical pattern slots as shown in [Figure 7-13](#).

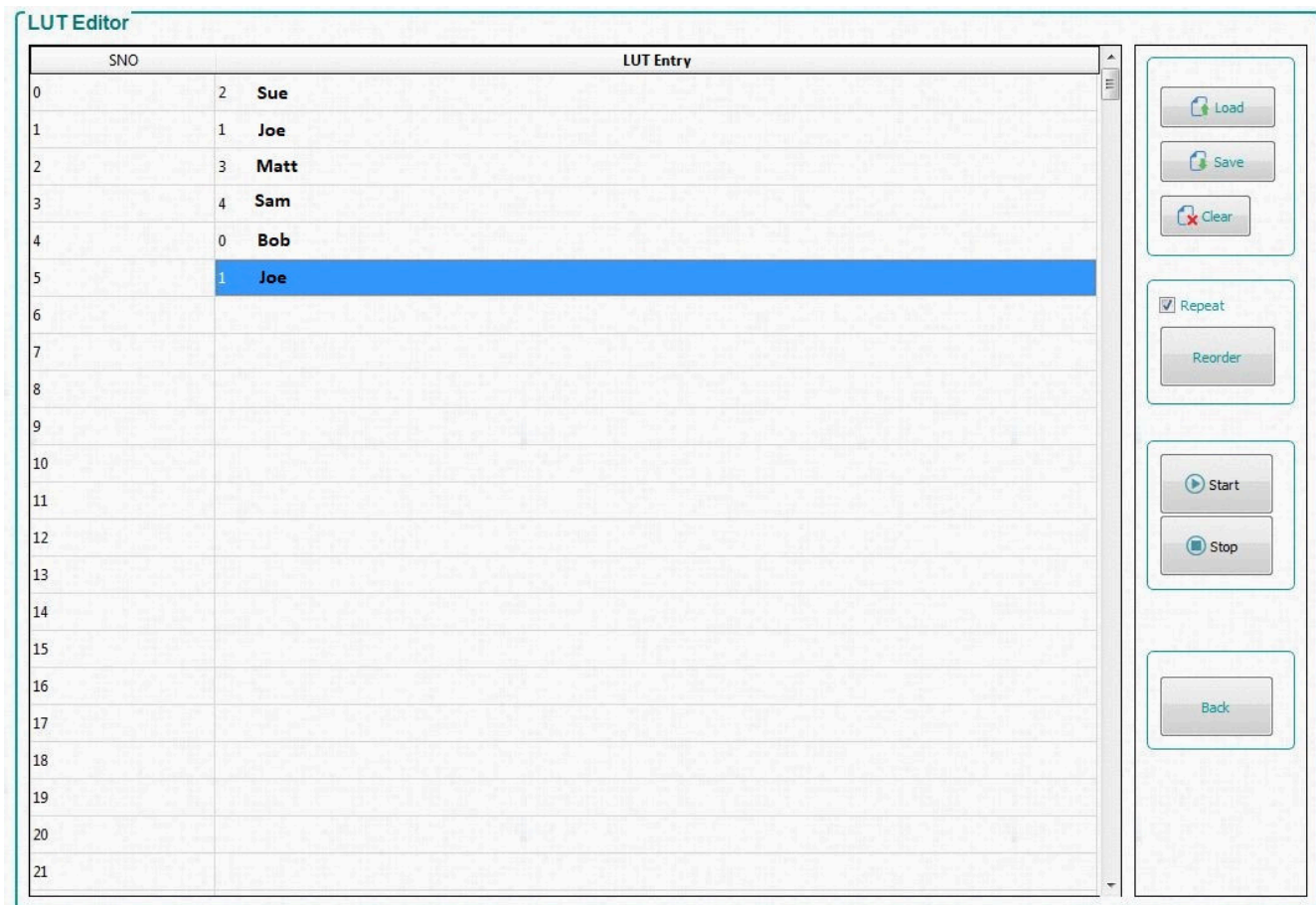

**Figure 7-12. LUT Editor Panel**

The following steps detail an example using the *Edit LUT* feature with five patterns in *Pattern On-The-Fly-Mode*:

1. By following the steps similar to [Section 7.6.2](#), load five patterns in *Pattern On-The-Fly-Mode* as shown in [Figure 7-11](#).
2. Set the exposure time to 1000000  $\mu$ s for ease of viewing.
3. Set an input trigger on Pattern 3 by checking the *Trigger Input* box.
4. Set all other user desired pattern property settings.
5. Click the *Update LUT* button and wait for all patterns to be uploaded to the EVM.
6. Click the *Start* button to view the pattern display order.
7. Click the *Edit LUT* button to open the *LUT Editor* panel as shown in [Figure 7-12](#). This panel initially opens with an empty "LUT Entry" column.
8. To reorder the patterns, enter a "2" in "LUT Entry" row 1, and subsequently a "1", "3", "4", "0", and "1" as shown in [Figure 7-12](#).
9. Click the *Stop* button to stop the pattern sequence even if it is not currently running.
10. Check the *Repeat* box for display repetition of the new pattern sequence and then click the *Reorder* button.
11. Click the *Start* button to view the new pattern display order.
12. Click the *Save* button to save the new pattern sequence as a text file for later use. Name the file **Reorderexample.txt** and save it in a directory of choice.
13. Browse to wherever the text file was saved, and open the file in a text editor program as shown in [Figure 7-13](#).
14. Notice at the top of the text file is the word "Reorder" which is required to successfully load a reorder file in the GUI. If desired, swap any of the pattern numbers to create a new pattern sequence and save the file.
15. Click the *Load* button and browse for **Reorderexample.txt**.
16. Click the *Start* button to view the new pattern display order.
17. Click the *Stop* button to stop the pattern sequence.
18. Click the *Back* button to return to the *Pattern Mode* tab.

### Note

When using the GUI interface, each pattern carries several items of information corresponding to the slot that it was inserted in the original LUT order. Therefore, when reordering a pattern to a different slot in the LUT, it retains its original assigned bit information, timing (exposure and dark time), LED color, and trigger information and NOT the information that is located in its reassigned slot in the LUT. For example, if pattern 3 contains a trigger input to begin the user’s execution in [Figure 7-11](#) and is reordered to slot 2 as shown in [Figure 7-12](#), the trigger input is now located at slot 3 in the LUT rather than slot 0.

In *Pre-Stored Pattern Mode*, reordering the LUT does not change the pattern locations as it does in *Pattern On-The-Fly Mode*. Only the requested bit information, timing, color, and trigger information are be reordered based on the user’s updated LUT. However, it is possible to manipulate the pattern information after reordering the sequence by manually editing the batch file commands uploaded to the EVM rather than using the GUI.

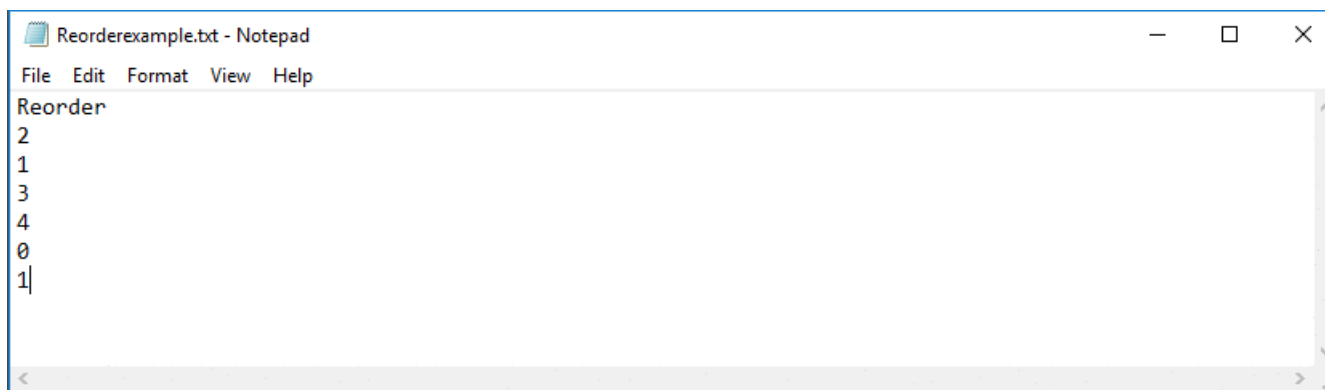

**Figure 7-13. Reorder Example**

It may be helpful to understand the *Edit LUT* feature by giving names to the patterns, as shown above the patterns in [Figure 7-11](#), and treating them as the batting order in a baseball game making it is easier to picture the distinction between the slot order numbers in the "SNO" column (the new batting order) and the patterns that are inserted into the "LUT Entry" column (the batters). For example, Bob retains his batting statistics independent of his batting position (i.e. bit information, timing, color, trigger), so if he originally bats first (slot 0 in [Figure 7-11](#)) but is moved to fifth in the new batting order (reorder LUT entry 4 in [Figure 7-12](#)) he retains all of his properties. The only difference is that now he does not bat (i.e. is not displayed) until after the four batters (patterns) preceding him (Sue, Joe, Matt, and Sam). Notice also that in our example Joe bats twice in the new batting order (SNO 2 and 5). There is only one Joe, who bats twice in the new batting order. In the same way, a pattern in the original pattern list can be displayed in many positions in the reordered display LUT, without adding or removing any patterns in DLPC900 memory. Therefore in terms of the system memory, it is only changed when using the *Update LUT* feature but never when using the *Edit LUT* (Reorder) feature in the [Figure 7-11](#).

#### 7.6.4.1 Special Considerations for Input Triggers when using the Edit LUT Feature

Input triggers have some special considerations when using the new *Edit LUT* Feature. As previously noted, Pattern 3 ("Matt") has an input trigger associated with it. When a trigger is added to a pattern, the pattern preceding it, Pattern 2 ("Sue") in this case, has an all-black pattern loaded at the very end of it so that while the sequence is waiting for the trigger it does not have a pattern displaying during the wait. This attribute follows Pattern 2 during a reorder. In our example the first entry (Pattern 2) in the new display order has a 105 μs dark pattern at the end of it. If Pattern 0 ("Bob") is placed in front of Pattern 3 ("Matt" - the triggered pattern) then the last bit-pattern of Pattern 0 ("Bob") continues to display in our new display order while waiting for the trigger in Pattern 3 ("Matt").

The unwanted trigger behavior can be compensated for by one the following methods:

- **Method 1:** Consider Pattern 2 and 3 ("Sue" and "Matt") as a set that must always be moved together in your new display order.

- Method 1 is the simplest, but the tradeoff is that these two patterns are not separable without the undesired trigger behavior described above.
- **Method 2:** Add a 1-bit all-black pattern with the shortest duration allowed for most DMDs preceding the trigger pattern. See Minimum Exposure in Any Pattern Mode in the [DLPC900 Programmer's Guide](#) for details. Now consider this pattern and the triggered pattern following it as a set that must always be moved together.
  - Method 2 is more versatile, but the pattern set must always contain a triggered pattern.
- **Method 3:** Add a 1-bit all-black pattern with the shortest duration allowed followed by a triggered 1-bit all-black pattern, and remove the trigger from the actual pattern of interest. These two patterns are now a versatile trigger set that can be used repeatedly wherever a trigger is desired. Note that since the triggered pattern is black, even if your exposure integration begins with the triggered black pattern there is no light contributing to your exposure.
  - Method 3 is the most versatile since this standalone trigger set only has to be placed in the Pattern Index set (on the Pattern Mode page) once but can be used in many positions when defining a new display order.

### 7.6.5 Creating a Pattern Sequence in Video Pattern Mode

Creating a *Video Pattern Mode* sequence is also similar to *Pattern On-The-Fly Mode*. The difference is that the patterns are streamed from the input video source. The user must create the video images and then input them through the RGB parallel interface. The input video source vertical sync is used as the triggering mechanism. The input video source must be stable and locked and continuously being applied, otherwise the firmware detects that the source was lost and a solid curtain is displayed. While the video source is stable and locked, the status box for *Locked to External Source* remains checked.

Follow these steps to create a *Video Pattern Mode* sequence.

1. Make sure the EVM is powered up and operating correctly, and the *Connected* radio-button is lit **green**.
2. Select *Video Mode* from the *Operating Mode* group box, and then select the *HDMI* radio-button from the *IT6535 Receiver* group box and finally click the *Set* button. (Select the *DisplayPort* radio-button if using this input connector). The *Locked to External Source* status box is checked after a few seconds.
3. Verify the video source is displayed. If no video source is displayed, then make sure the PC or host is supplying the correct resolution and frame rate. See [Video Support](#) for video support.
4. Select *Video Pattern Mode* from the *Operating Mode* group box, and then click the *Pattern Design* button so that the large black panel is displayed as shown in [Figure 7-6](#).
5. Click the *Add Pattern* button on the *Menu* bar and add 3 patterns. [Hover over buttons in the *Menu* bar to see their tool tip]
6. Click the *Select All Patterns* button to select all images.
7. Set exposure time to 1215  $\mu$ s and dark time to 0  $\mu$ s.
8. Select the first image and select a bit depth of 2, start bit G0, and color Green.
9. Select the second image and select a bit depth of 4, start bit R0, and color Red.
10. Select the third image and select a bit depth of 3, start bit B0, and color Blue
11. Click the *Select All Patterns* button.
12. Remove the check from the *Frame Change* box.
13. Select pattern 0 (first pattern) only and check the *Frame Change* box.
14. Click the *Update LUT* button.
15. Click the *Start* button to run the sequence. The system displays a green 2-bit sequence based on G0 - G1 for 1215  $\mu$ s, a red 4-bit sequence based on R0 - R3 for 1215  $\mu$ s, and a blue 3-bit sequence based on B0 - B2 for 1215  $\mu$ s with the remainder of the video frame time dark. This sequence repeats every frame with the new video data for that frame.
16. Click the *Stop* button to end this example.

See [Figure 7-14](#) after all settings have been applied.

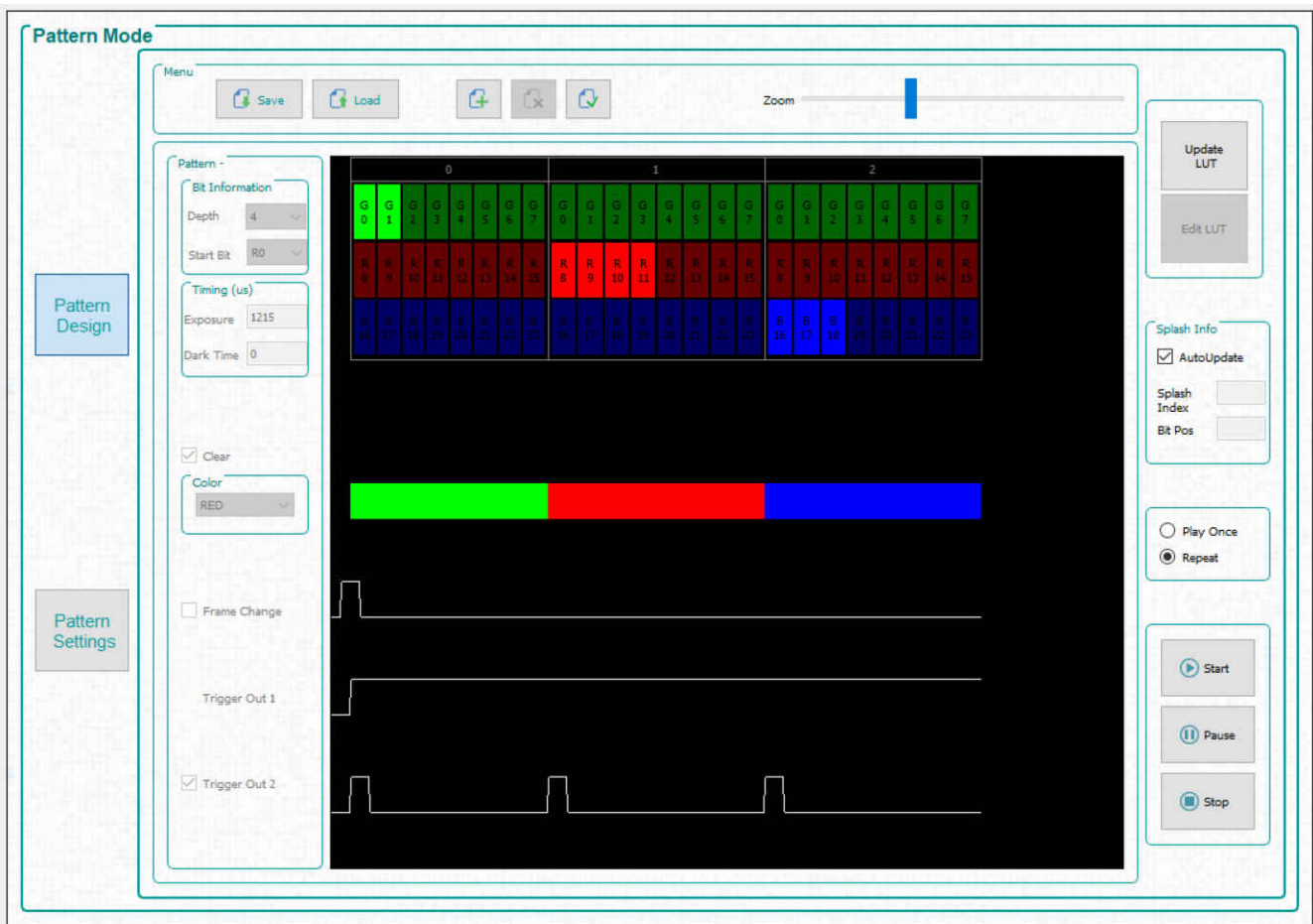

Figure 7-14. Video Pattern Mode



## 7.6.6 Creating a Pattern Sequence With DMD Block Load

Creating pattern sequences with DMD Block Load achieves higher pattern rates by using a subset of the DMD blocks. See DMD Block Load command in the DLPC900 Software Programmer's Guide ([DLPU018](#)) for a description of this command.

Follow these steps to create a *Pattern On-The-Fly* pattern sequence with only three DMD active blocks.

1. Make sure the EVM is powered up and operating correctly, and the *Connected* radio-button is lit **green**.
2. Select *Pattern On-The-Fly Mode* from the *Operating Mode* group box, and then select the *Pattern Design* button so that the large black panel is displayed as shown in [Figure 7-6](#).
3. Select the *Load* button from the menu bar and select the **Block\_Load.txt** file located in the sample images directory. Be sure to select the correct file for the EVM being used.
4. The pattern design looks similar to [Figure 7-15](#).
5. Select the *Pattern Settings* button.
6. Within the *DMD Active Blocks*, select 6 for the *Start Block* and select 8 for the *End Block*, and then Select *Set*.
7. Select the *Pattern Design* button.
8. Select the *Update LUT* button.
9. Select the *Start* button to run the sequence. The system only loads data in blocks 6, 7, and 8 regardless of the thumbnail image shown in the *Pattern Design* window and displays each pattern for 180,000  $\mu$ s.
10. Select the *Stop* button to end this example.

Notice that pattern 0 is displayed the same way as pattern 2 even though pattern 0 contains image data for all blocks showing that only blocks 6, 7, and 8 are active while all other blocks are in the off state.

---

### Note

The performance of the mirrors in the blocks that are not active are affected by prolonged use of being in the off state. Enable *DMD Idle Mode* as often as possible to optimize the mirrors. This mode provides a 50/50 duty cycle across the entire DMD mirror array, where the mirrors are continuously flipped between the on and off states. See *DMD Idle Mode* command in the DLPC900 Software Programmer's Guide ([DLPU018](#)) for a description of this command. The *DMD Idle Mode* command is located in [Section 7.6.7](#) within the *Pattern Mode* panel.

---



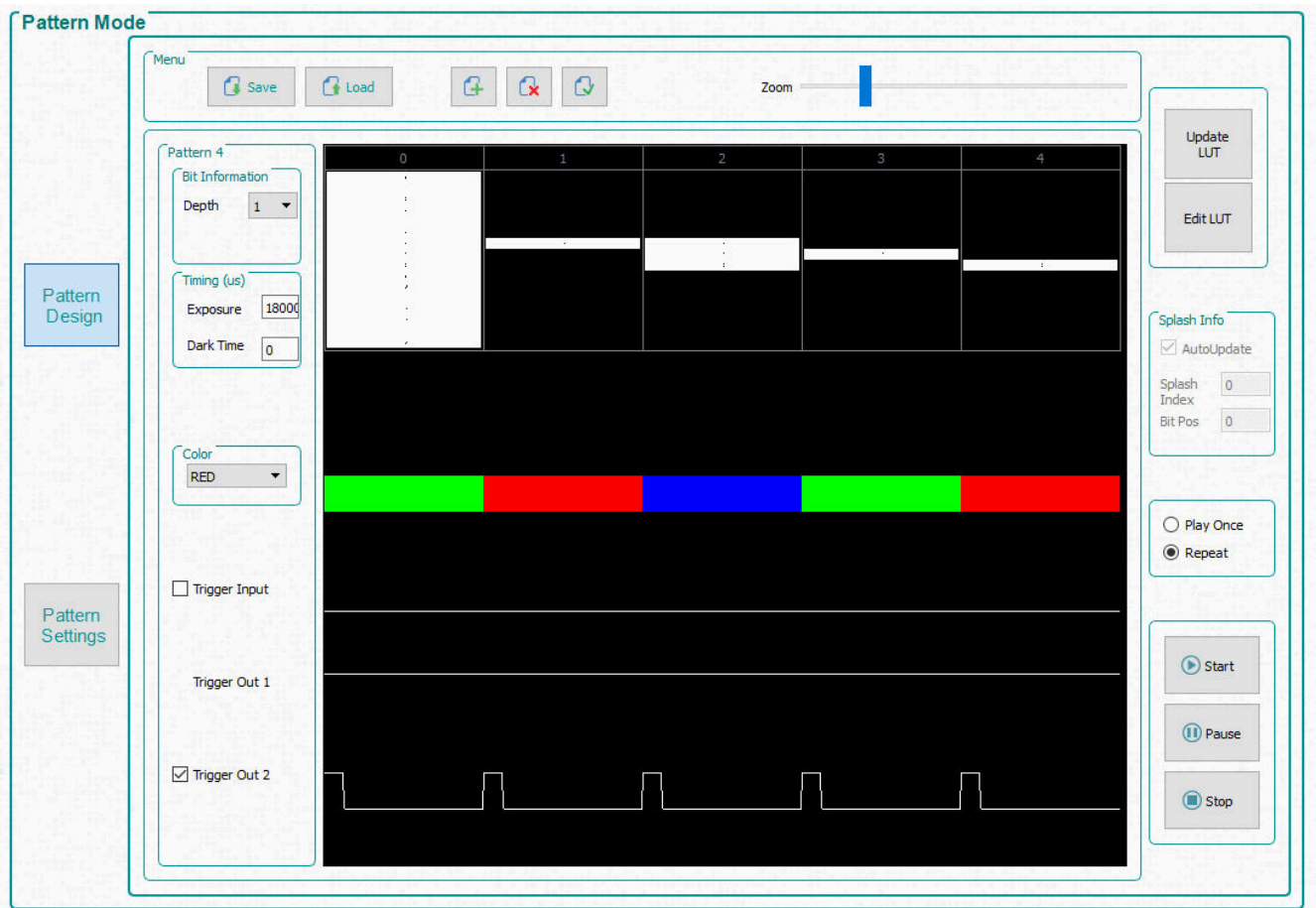

**Figure 7-15. DMD Block Load Pattern Sequence**

### 7.6.7 Pattern Settings

To configure the output or input triggers click the *Pattern Settings* button as shown in [Figure 7-16](#). Within this panel, the user can select the output delays of Trigger 1 and 2 and the input delay for Trigger In 1 and 2. The output delays are from the start of the pattern on the DMD.

Trigger In 1 and 2 can be delayed to have a later affect from when the external device performed the trigger. All signals can be inverted.

The LED controls can also be delayed. These delays are from the start of the pattern on the DMD.

Minimum LED Pulse Width control allows the system to have much higher pattern speeds. Input the minimum LED Pulse Width specific to your illumination system to achieve higher pattern speeds through illumination modulation. Illumination modulation occurs with 8-bit patterns at rates faster than 1031 Hz, by modulating the light source to shorten the shortest bits, therefore increasing the maximum pattern speed. The LED enable signals from the DLPC900 can be used to control the illumination modulation of the LEDs.

The *DMD Active Blocks* allows a subset of DMD blocks to be activated, while the mirrors in the non-selected blocks are set to the off state. See [Section 7.6.6](#) for an example of using this mode. **When operating with a subset of DMD blocks, enable the *DMD Idle Mode* as often as possible.** For example, whenever the system is idle, between exposures if the application allows for it, or when the exposure pattern sequence is stopped. To enable the *DMD Idle Mode*, the pattern sequence must be stopped. To restart the pattern sequence, the *DMD Idle Mode* must be disabled.

---

#### Note

To resume operation after disabling *DMD Idle Mode* issue an *Update LUT* command.

---

The *DMD Idle Mode* provides a 50/50 duty cycle across the entire DMD mirror array, where the mirrors are flipped between the on and off states to optimize the performance of the mirrors.

The *Image Compression* option allows for control of the compression type that occurs to the pattern images.

- The Uncompressed option does not attempt to compress the images.
- The Run Length Encoding (RLE) option is a lossless compression method that compresses the pattern data using horizontal pixel similarities.
- The Enhanced RLE option is a lossless compression method that compresses the pattern data using vertical and horizontal pixel similarities.
- The Auto option is capable of doing all three compression types and selects the method that takes up the smallest amount of data.

More information on these compression types can be found in the [DLPC900 Programmer's Guide](#).

Pattern Mode

Pattern Design

**DMD Active Blocks**

Start Block:

End Block:

**Minimum LED Pulse Width**

Pulse Width (us):

**DMD Idle Mode (50/50 Sequence)**

**Image compression**

**Trigger Control**

**Trigger Out 1 (us)**

Rising Edge Delay:

Falling Edge Delay:

Invert

**Trigger Out 2 (us)**

Rising Edge Delay:

Falling Edge Delay:

Invert

**Trigger In 1 (us)**

Delay (us):

Invert

**Trigger In 2**

Invert

**LED Delay Controls (us)**

Red LED Rising Edge Delay	<input type="text" value="0"/>	Green LED Rising Edge Delay	<input type="text" value="0"/>	Blue LED Rising Edge Delay	<input type="text" value="0"/>
Red LED Falling Edge Delay	<input type="text" value="0"/>	Green LED Falling Edge Delay	<input type="text" value="0"/>	Blue LED Falling Edge Delay	<input type="text" value="0"/>

Pattern Settings

**Figure 7-16. Pattern Settings Panel**

## 7.7 Batch Files

Click the *Batch Files* button at the top of the GUI to display the *Batch Command Sequence* panel as shown in [Figure 7-17](#). If the *Enable Command Logging* box is checked, the panel displays all the commands the user clicks on the GUI. When clicking the *Save Batch File* button, the content that is in the panel is saved to a text file containing the command descriptor followed by the command data. This batch file can then be reloaded at a later time using the *Load Batch File* button and executed or it can be added to the firmware to be executed using the *Batch files Stored in the EVM* group box. This group box lists all the batch files currently in the firmware.

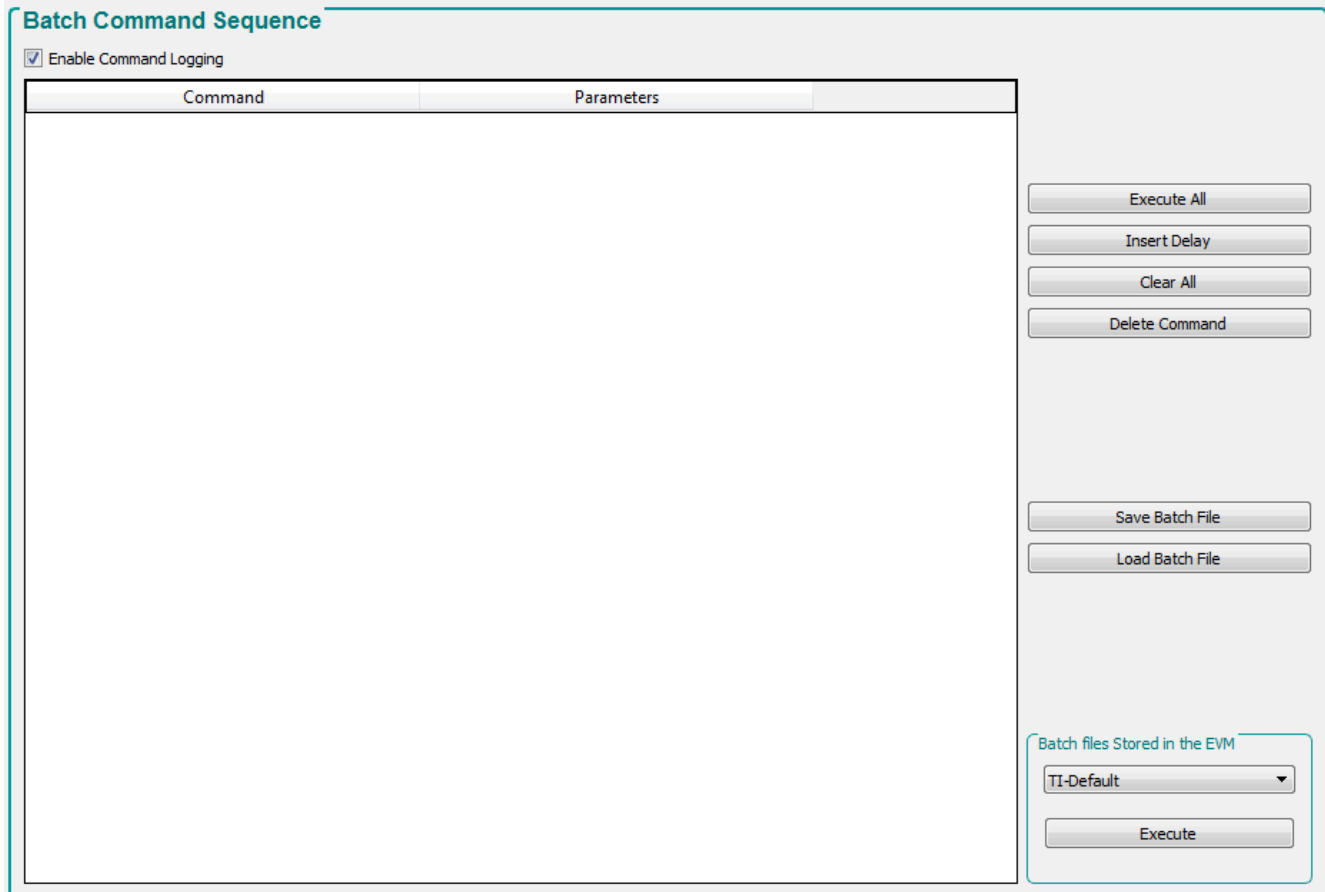

**Figure 7-17. Batch Files Panel**

### 7.7.1 Execute Batch File

The DLPC900 firmware has the option to store batch files within the firmware. These batch files contain commands that are executed to perform some sequence of settings without the user or host performing these commands. If the firmware contains batch files, the GUI queries the batch file names and list them in the *Batch Command Sequence* panel within the *Batch Files Stored in the EVM* group box. The user can then choose a batch file from the list to execute it.

The user can also designate a default batch file to be executed during the DLPC900 power-up sequence when the power is applied. For example, if the LEDs are to remain off after power has been applied to the EVM, a batch file can be created with the commands to turn the LEDs off, and then update the firmware with this batch file as the default. The updated firmware can then be uploaded to the EVM. The next time the power is applied to the EVM, the LEDs are disabled from turning on. See the [DLPC900 Programmer's Guide](#) for the batch file commands in Appendix B for a complete list of commands that can be used within a batch file.

**Note**

If an "IDX" error is received during execution of a batch file, this indicates that execution failed at the line number that follows IDX in the error message. POWER\_CONTROL (Power Mode) commands often result in an IDX error since the EVM can no longer communicate with the GUI because the power state has been changed.

---

## 7.7.2 Creating and Saving Batch Files

There are two methods to create and save batch files:

- Use the GUI
- Use a text editor

### 7.7.2.1 Creating and Saving a Batch File Using the GUI

This example contains the following set of commands:

1. Set the short axis image orientation.
2. Set the input channel swap to ABC->CBA.
3. Set the LED currents.

Follow these steps to add the commands and save to a text file

1. Power-up the EVM and verify that the *Connected* radio button is lit *green*.
2. Click the *Video Mode* button at the top of the GUI .
3. Select the *Parallel RGB* under *Source Select*.
4. Select *Video Mode* from the *Operating Mode* group box, and then select the *HDMI* radio-button from the *IT6535 Receiver* group box and finally click the *Set* button. (Select the *DisplayPort* radio-button if using this input connector).
5. Verify the EVM is displaying the input source correctly. If no video source is displayed, then make sure the PC or host is supplying the correct resolution and frame rate. See [Section 7.5.1](#) for video support.
6. Click the *Batch Files* button at the top of the GUI.
7. Check the *Enable Command Logging* box to enable logging.
8. Click the *Clear All* button to clear the contents of the list box.
9. Click the *System Settings* button at the top of the GUI.
10. Click the *Get* button within the *Image Orientation* group box.
11. Check the *North/South* checkbox and click the *Set* button within the group box. The image orientation of the displayed image is flipped on its short axis.
12. Click the *Video Mode* button at the top of the GUI.
13. Select ABC->CBA from the drop-down list box within the *Input Port Data Swap* group box.
14. Click the *Set* button within the box. The colors of the image are adjusted for the setting.
15. Click the *System Settings* button at the top of the GUI.
16. Click the *Get* button within the *LED Controls* group box.
17. Enter 100 for each of the LEDs within the *LED Current* group box and click the *Set* button. The LED brightness may change after setting the LED current.
18. Click the *Batch Files* button at the top of the GUI.
19. Within the list box, all the commands that were applied on previous steps are listed.
20. Click the *Save Batch File* button to save as text file.

[Figure 7-18](#) shows the contents of the list box. Notice that there are more than the three mentioned commands in the list box because when clicking the *Set* button for some commands in the GUI, multiple commands are combined. For example, when clicking the *Set* button for image orientation, both long and short axis commands are included.

Within the Batch File panel, each command can also be deleted or a delay can be inserted between commands.



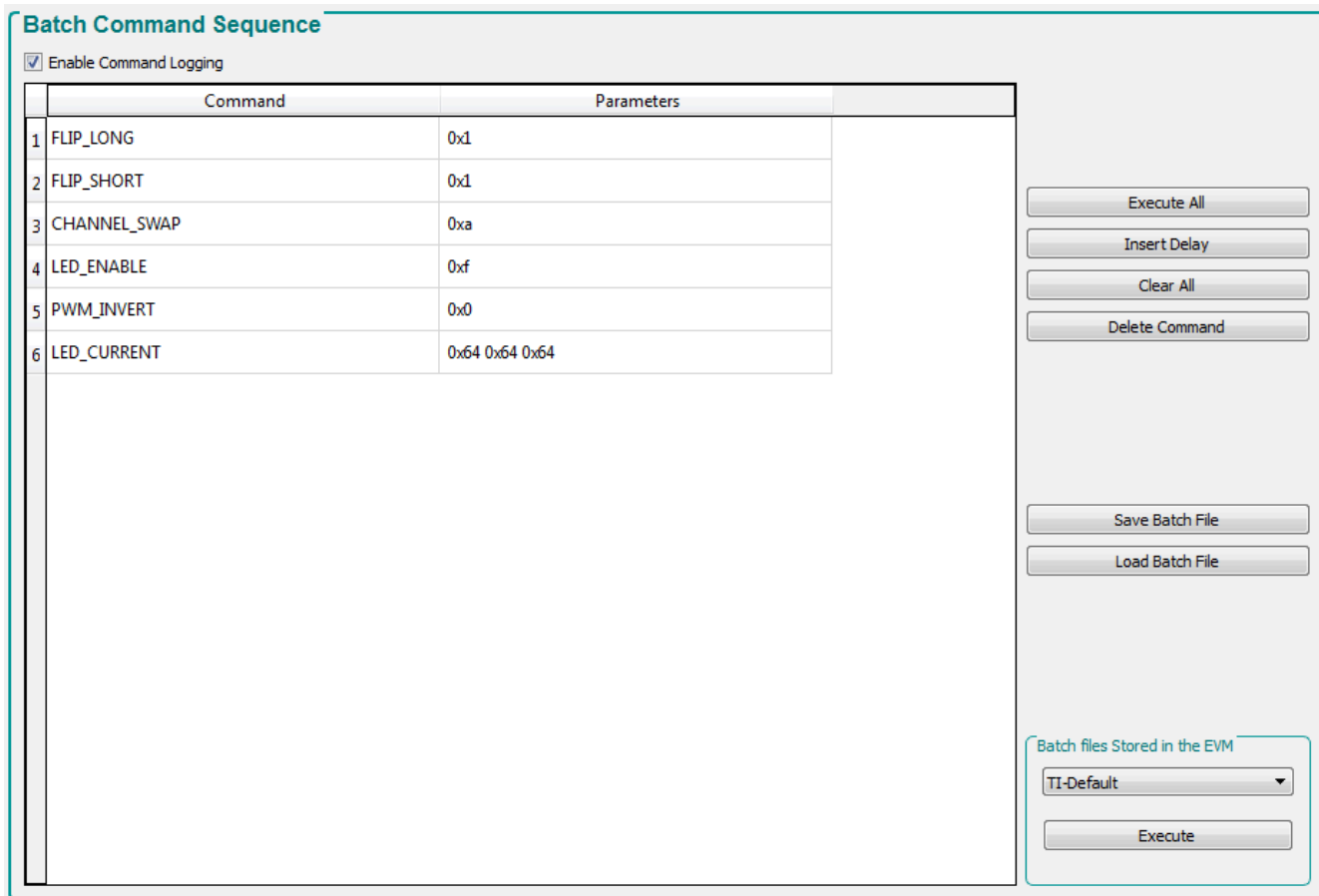

**Figure 7-18. Batch File Example**

**7.7.2.2 Creating a Batch File Using a Text Editor**

Use a text editor to add the same three commands in the previous example. Refer to Appendix B in the DLPC900 Programmer’s Guide for the list of command descriptors supported by the DLPC900.

When adding a command descriptor to the file, a colon must be between the descriptor and the parameters. Use a space between the colon and each parameter and use ‘0x’ for each byte in the parameter list. Remember that the parameters are least significant byte first. The lines below show what is to be in the text file.

```
FLIP_SHORT:           0x01
CHANNEL_SWAP:        0x0A
LED_CURRENT:         0x64 0x64 0x64
```

Once all three commands are added, save the file as a text file and use a name to describe what the batch file does.

**7.7.3 Loading a Batch File**

Once you have saved a batch file from either the GUI or a text editor, you can load the batch file into the GUI and execute the commands.

Use the button labeled **Load Batch File** (shown in [Figure 7-18](#)) on the right midway down, and navigate to and select a batch file. Once it is loaded, the commands can be executed or added to your firmware (see [Section 7.7.4](#))

### 7.7.4 Adding a Batch File to the Firmware

A batch file can be added to the firmware to be used as the default batch file to be executed during the power-up sequence of the DLPC900. Or a batch file can be added to be executed at any time after the power-up sequence has completed to perform some action. Some special considerations must be taken if adding pattern images and a batch file to the firmware image. See NOTE at end of [Section 7.9.1.2](#) for a description of these considerations. Follow these steps to add the example batch file from the previous section to the firmware.

#### CAUTION

The user must exercise caution when selecting the correct firmware file. Install DLP LightCrafter GUI version 5.x or later and select FW version 6.x or higher. Operating or updating the firmware on the DLPC900 LightCrafter GUI version 4.x (or earlier) renders the EVM inoperable. Note: The DLP5500 DMD is only supported by GUI version 5.2.x and FW version 6.2.0.

1. Power-up the EVM and verify it is operating as expected.
2. Start the GUI and verify the connection has been established with the EVM.
3. Click the *Batch File* button at the top of the GUI.
4. Check the *Enable Command Logging* box to enable logging.
5. Click the *Clear All* button to clear the contents.
6. Click the *Load Batch File* button and browse for the text file that was saved in [Section 7.7.2](#).
7. The panel displays the commands as they are in the file.
8. Click the *Firmware* button at the top of the GUI.
9. Click the *Browse* button and select the firmware file(s) for the EVM being used.

---

#### Note

When updating the firmware for the DLPC900 Single Controller EVM, there is only one firmware image file (\*.img).

---

10. Within the *Batch File and Patterns* group box, check the *Add Batch File* box.
11. In the *Batch File Name* edit box, enter a name for the batch file. Up to 16 characters are allowed without spaces and special characters.

---

#### Note

If the batch file is to be a default batch file to be executed during the power-up sequence, then continue to step 12, otherwise go to step 13.

---

12. Within the *Batch File and Patterns* group box, check the box next to *Set as Default Batch File*.
13. Click the *Update Firmware* button. The GUI displays a pop-up box providing the name of the updated firmware file.
14. Click the *Browse* button and locate the firmware file from step 13.
15. Click the *Upload* button. The GUI performs the necessary steps to update the firmware in the EVM.

---

#### Note

The name of the firmware file created by the GUI includes a timestamp, ensuring that new firmware does not overwrite any previously created firmware files.

---

## 7.8 Peripherals

Click the *Peripherals* button at the top of the GUI to display the *Peripherals* panel as shown in [Figure 7-19](#).



The screenshot shows the 'Peripherals' panel with the following sections:

- I2C Settings:** I2C Port (Port 1), Addressing Mode (7-Bit), Clock Rate (Hz) (100000). Buttons: Get, Set.
- I2C Read / Write:** I2C Port (Port 1), Device Address (hex), Write Data (hex), Read Data (hex), Bytes to Read (0). Buttons: Read, Write.
- GPIO Configuration:** GPIO Pin Select (GPIO 0), Output State (Pin Low), Direction (Input), Output Type (Normal). Buttons: Get, Set.
- Pulse Width Modulated (PWM) Control:** Enable checkbox, PWM Channel Select (PWM Channel 0 (GPIC)), Clock Period (µs), Duty Cycle (%). Buttons: Get, Set.
- Clock A Configuration:** Enable checkbox, Clock Divisor. Buttons: Get, Set.
- Busy GPIO:** Enable checkbox, GPIO Pin Select (GPIO 0). Buttons: Get, Set.

**Figure 7-19. Peripherals Panel**

- The I<sup>2</sup>C group box allows external I<sup>2</sup>C device to be controlled using one of the DLPC900 I<sup>2</sup>C interfaces. For example, if an LED driver requires I<sup>2</sup>C communications to enable the LEDs, then a command can be sent to the LED driver using this interface. When using the I<sup>2</sup>C interfaces, first configure the I<sup>2</sup>C port using the commands within the *I<sup>2</sup>C Settings* and then perform data transfers using the commands within the *I<sup>2</sup>C Read/Write*.
- The Clock A Configuration group box allows the user to enable and control the output frequency of OCLKA. The clock can be used as a source to some external logic.
- The GPIO Configuration group box allows the user to configure any of the nine available GPIOs. These GPIOs can be configured as inputs or outputs.
- The Pulse Width Modulate Control group box allows a user to configure any of the four available PWM outputs.

### Note

GPIO\_PWM\_00 – GPIO\_PWM\_03 are shared GPIO\PWM outputs.

## 7.9 Firmware

Click the *Firmware* button to display the Firmware panel as shown in [Figure 7-20](#). In this panel a user can update the firmware with patterns, batch files, and set start-up conditions.

Before uploading firmware, verify the EVM is powered-up, operating as expected and connection has been established with the GUI. To update the firmware on the EVM click the *Browse* button and locate the firmware file for the EVM type. Then click the *Upload* button.

Within the *Power up Defaults* group box, a user can select the default power-up state by checking the *Startup State* checkbox and then selecting the state from the drop-down list box.

If the IT6535 digital receiver is present on the hardware, then the user may enable the use of this receiver by checking the *HDMI/DP Receiver* checkbox.

If a default batch file is needed, then see the Batch File section in this guide.

The DLPC900 can also be controlled over the I<sup>2</sup>C interface on I<sup>2</sup>C port 0.

The GUI permits the user to perform a bus swap on the DMD by checking the *DMD Bus Swap* box and selecting between Channels A and B. This feature is a firmware configuration option that only takes effect after uploading the firmware onto the EVM. When using a LightCrafter Single DLPC900 EVM only check the Primary controller option as this EVM does not include a Secondary controller.

The GUI also permits the user to enable Spread Spectrum Clock Generator Support. The user can select from .5%, .75%, or 1% in the drop down menu. This option uses internally controlled clock spreading to help minimize EMI due to high-speed signals. More information on the spread spectrum feature and DMD bus swapping can be found in the [DLPC900 datasheet](#).

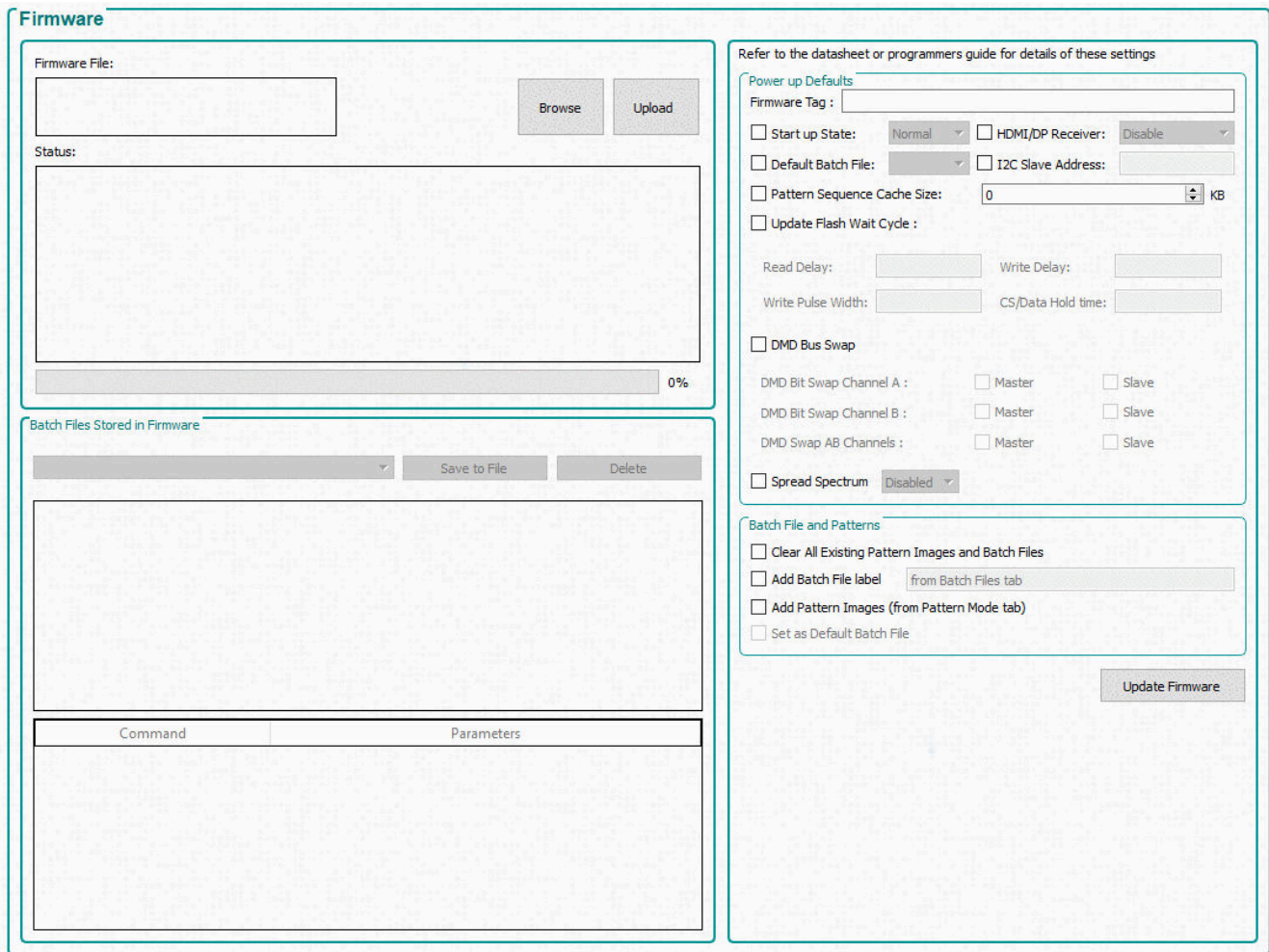

Figure 7-20. Firmware Panel

### 7.9.1 Adding or Removing Patterns from the Firmware

For most efficient storage and compression of images, the GUI packs the images into groups of 24-bit RGB bitmap images. If there are 1-bit black and white images, 8-bit gray scale images, or any other image bit-depth (up to 24-bit images), they are combined to create a composite image. For example, a composite image composed of 24 1-bit images, 3 8-bit images, or a combination of images of various bit-depths which add up to a 24-bit composite image.

#### Note

An image cannot span two 24-bit composite images. For example three 7-bit images can fit in a composite 24-bit image, but a fourth 7-bit image must go into a separate 24-bit image. Only a 3-bit or smaller image can be put into the remaining bits of the first composite 24-bit image.

The GUI then compresses each 24-bit image using the Enhanced Run-Length Encoding described in the DLPC900 Programmer's Guide. These compressed images are then decompressed as they are loaded into the DLPC900 internal memory when operating in *Pre-Stored Pattern Mode* or *Pattern On-The-Fly Mode*.

Based on the DMD connected, the EVM is capable of holding up to 400 1-bit binary/50 8-bit gray scale compressed patterns in **Flash Memory**, or 960 1-bit binary/120 8-bit gray scale patterns. Depending on the compression ratio, more than 400/960 patterns can be stored to have multiple pattern sets for multiple pattern sequences. These patterns are then loaded when the operating mode is set to *Pre-Stored Pattern Mode*. The remainder of this topic applies only to *Pre-Stored Pattern Mode*.

The DLPC900 Single Controller LightCrafter EVMs are pre-loaded with a pattern sequence that is displayed when power is applied to the EVMs. Since the GUI does not know the images that are stored in flash memory, it is advisable to delete all images from flash before storing new ones. When adding images to the *Pattern Design* panel, the GUI always begins with image index Zero. However, the GUI saves the images to the firmware by appending them to the end of the last image that is in the firmware if any.

For example, if there are already two 24-bit images stored in the firmware. These two images have index values of 0 and 1. If then a pattern sequence is created in the *Pattern Design* panel, where the GUI packs all the images into four 24-bit images, and then saved to the firmware, the four images are appended to the firmware and have index values of 2, 3, 4, and 5. When the firmware is uploaded to the EVM and the pattern sequence is started, the sequence of images is 0, 1, 2, 3 rather than 2, 3, 4, 5.

First begin by examining the images that are currently in the firmware.

1. Make sure the EVM is powered up and operating correctly, ensuring the *Connected* radio-button is lit green.
2. Display the pre-stored pattern sequence.
3. Select *Video Mode* from the *Operating Mode* group box.
4. Click the *Source Select* drop-down list box, and select *Images From Flash*.
5. Below the *Source Select* drop-down list box, select 0.
6. Click the *Set* button.
7. Continue to index through all the values until a new image is not displayed indicating that the end of the stored images has been reached.

The index value reached (plus one) represents the number of images that are stored in flash.

Return to the video source by selecting the *Parallel RGB* interface from the *Source Select* drop-down list box and click the *Set* button. If there is a video source connected to the EVM, the source is displayed, otherwise a solid curtain is displayed.

### 7.9.1.1 Deleting Images

When deleting images from flash, the flash device is erased and then updated with the firmware that contains the new images. In the event the flash is accidentally corrupted, follow the instructions under JTAG Flash Programming (see [Section 7.11](#)) to reload the original firmware. To remove accidental erasing or corruption of the flash device, it is recommended to operate in *Pattern On-The-Fly Mode*.

#### CAUTION

The user must exercise caution when selecting the correct firmware file. Ensure that firmware file is version 3.0 or later. Using version 2.0 or earlier renders the EVM inoperable. Version 6.0 or later is recommended.

Follow these steps to begin deleting images from the firmware file:

1. Make sure the EVM is powered up and operating correctly and the *Connected* radio-button is lit green.
2. Display the pre-stored pattern sequence.
3. Click the *Firmware* button on the top of the GUI.
4. Click the *Browse* button.
5. Select a suitable firmware file or the original firmware file that comes with the EVM.
6. Add a tag name for this updated firmware file by adding a name in the *Firmware Tag* box.
7. Check the box next to *Clear All Existing Patterns Images and Batch Files*.
8. Click the *Update Firmware* button.
9. The GUI displays a pop-up box providing the name of the updated firmware file.
10. Click the *Browse* button and select the firmware file from step 8.

The updated firmware file has no images. It is advisable to rename the updated firmware file with a specific name so that later it can be reused as a firmware file that has no images.



### 7.9.1.2 Adding Images

The bitmap images to be added to the firmware file **must have the native resolution of the DMD that is being used**. The GUI returns an error if it encounters an incorrect image size. Please be sure any images you add to the firmware are of the correct resolution.

1. Continuing from the previous set of steps, click the *Browse* button and select the firmware file in step 8 or the renamed version.
2. Select *Pre-Stored Pattern Mode* from the *Operating Mode* group box. The *Pattern Mode* panel is displayed.
3. In the menu bar click the *Load* button and select **add\_72.txt**. The file is typically stored in the folder named *C:\Texas Instruments-DLP\DLPC900REF-SW-x.x\DLPC900REF-GUI\Images and Batch files\*, then *LCR[DMD]\_Images\* folder depending on which DLPC900 DMD EVM is being used. Be sure to select the correct file for the DMD EVM being used. This file adds 72 1-bit images to the *Pattern Design* panel. See [Figure 7-10](#).
4. Click the *Select All Patterns* button from *Menu* bar to select all the images.
5. Under *Bit Information* select bit depth 1 for all images.
6. Enter 120000  $\mu$ s for the exposure time for all images.
7. Enter 10000  $\mu$ s for the dark time for all images.
8. Select color **Red** for all images.
9. Click the *Firmware* button at the top of the GUI.
10. Under *Batch File* check the box next to *Add Patterns Images* and *Clear Existing Patterns*. These patterns are from the *Pattern Design* panel. See [Figure 7-10](#).
11. Under power up defaults update the firmware tag (ex: dlp6500\_6.0.0\_72images)
12. Click the *Update Firmware* button.
13. The GUI displays a pop-up box providing the name of the updated firmware file.
14. Click the *Browse* button and select the firmware file from step 12.
15. Click the *Upload* button and allow firmware to be uploaded to the flash memory.

---

#### Note

When a firmware file is uploaded, a cached version of that file is created on the PC in its original folder location in a subdirectory named *FlashLoaderCache*. Each time a new firmware is uploaded the GUI compares it to the cache file on the PC and only reprograms the new sectors. The cache file is then updated to represent the latest firmware image. Caching leads to significant download speed improvements if the new firmware and the previous firmware are similar.

---

#### Note

If a full reprogramming of the flash is desired, delete the *FlashLoaderCache* folder or select a firmware image from a different file location that does not have a cached firmware. Programming the firmware to a different board requires deleting the *FlashLoaderCache*.

---

16. Once the EVM resets and displays a solid curtain, click the *Pre-Stored Pattern Mode* from the *Operating Mode* group box.
17. The *Pattern Design* panel (See [Figure 7-10](#)) is displayed which includes the pattern images that were added into the panel in step 3 with all the settings from steps 5-8. If the *Pattern Design* panel is not displayed, then click the *Pattern Mode* button at the top of the GUI. Press *Stop* if pattern sequence is currently playing.
18. Click the *Update LUT* button.
19. Click the *Start* button.
20. All 72 1-bit images are displayed with the settings that were entered in steps 5-8.

It is possible to add many images to the firmware without deleting all the images that are currently in the firmware, and then select which images and bit positions to choose for different pattern sequences. To do this requires editing the image index and the bit position in the *Pattern LUT Definition* that is sent to the EVM, and then using the *Batch File* method to upload the *Pattern LUT Definition* and *Configuration* settings to the EVM.

The following example shows how to choose different images and bit positions from the 72 1-bit images that are stored in the firmware.

Follow these steps to edit the image index and bit position of the images to be used for the pattern sequence.

1. Stop the pattern sequence if it is currently running.
2. Delete all images except for the first two in the *Pattern Design* panel. See [Figure 7-10](#).
3. Select the first image and set the color to Yellow.
4. Select the second image and set the color to Green.
5. Click the *Batch File* button at the top of the GUI.
6. Check the *Enable Command Logging* box, and then click the *Clear All* button.
7. Click the *Pattern Mode* button at the top of the GUI.
8. Click the *Update LUT* button.
9. Click the *Batch File* button at the top of the GUI.
10. [Figure 7-21](#) shows the *Pattern LUT Definition and Configuration* of the pattern sequence.
11. Click the *Save Batch File* button to save the contents to a file.
12. Click the *Pattern Mode* button at the top of the GUI.
13. Click the *Start* button and take note of the images that are displayed, and then Click the *Stop* button.
14. Click the *Batch File* button at the top of the GUI.
15. Click the *Clear All* button and uncheck the *Enable Command Logging* box.
16. Use Notepad or a similar editor to open and edit the batch file saved in step 11. The file is typically stored in the folder named *C:\Texas Instruments-DLP\DLPC900REF-SW-5.2.0\DLPC900REF-GUI\Images and Batch files\*, then *LCR[DMD]\_Images\* folder depending on which DLPC900 DMD EVM is being used. Change the image index and bit position as seen in [Figure 7-22](#). See the DLPC900 Programmer's Guide ([DLPU018](#)) for details of the *Pattern LUT Definition and Configuration* commands.
17. [Figure 7-22](#) shows the image index and the bit position of the images for the two patterns, where the values have been changed compared to the values in [Figure 7-21](#). Click the *Save* to save the new batch file.
18. In the *Batch File* tab click the *Clear All* button, and then click the *Load Batch File* button and load the file from step 17.
19. Click the *Execute All* button.
20. Click the *Pattern Mode* button at the top of the GUI.
21. Click the *Start* button.

Notice that two different images or bit positions are displayed compared to the images in step 13.

Therefore, many different images can be added to the firmware and knowing the image index and the bit positions of each image, the user can create different *Pattern LUT Definition and Configuration* batch files that select different images and bit positions from the images stored in the firmware.

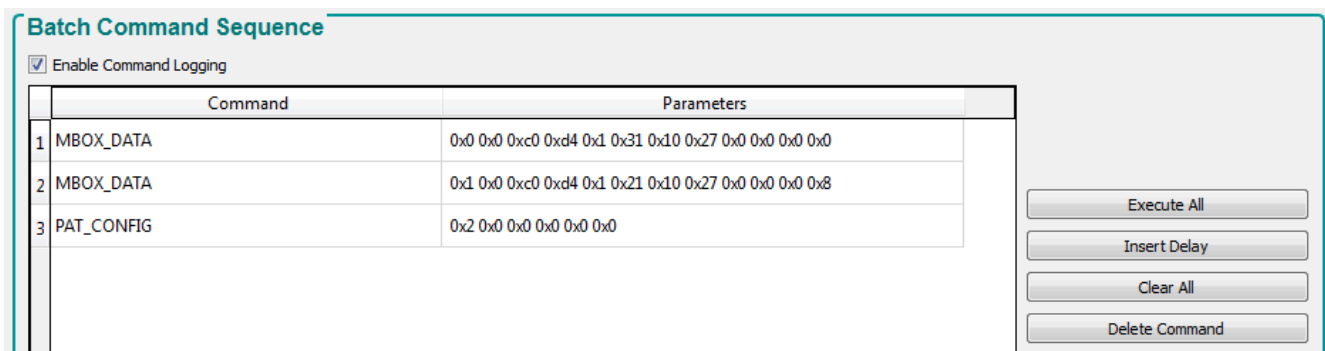

**Figure 7-21. Pattern LUT Definition and Configuration**

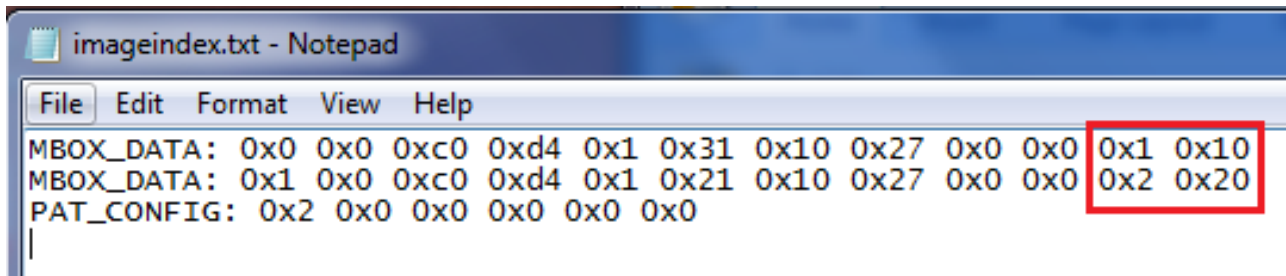

```

imageindex.txt - Notepad
File Edit Format View Help
MBOX_DATA: 0x0 0x0 0xc0 0xd4 0x1 0x31 0x10 0x27 0x0 0x0 0x1 0x10
MBOX_DATA: 0x1 0x0 0xc0 0xd4 0x1 0x21 0x10 0x27 0x0 0x0 0x2 0x20
PAT_CONFIG: 0x2 0x0 0x0 0x0 0x0 0x0
  
```

**Figure 7-22. Updating the Index and Bit Position**

### 7.9.1.3 Adding Both Images and Batch Files

This section covers how to add pattern images and a batch file to the firmware. These steps allow the user to add patterns to the flash and have them automatically uploaded to the DLPC900 upon power up. The GUI is not connected when starting this process.

1. Make sure the EVM is powered up and operating correctly, and the Connected radio-button is lit green.
2. Navigate to the Batch File page select Clear All and then check the Enable Command Log box.
3. In the operating mode box on the left of the GUI select **Pattern on-the-fly Mode**.
4. Navigate to the pattern mode tab and add images.
5. Adjust exposure settings and other pattern configurations to desired values.
6. Click the update LUT button.
7. Click the start button if it is desired for the pattern sequence to be running upon start-up.
8. Navigate to the Firmware Page and browse to select a firmware to be modified.
9. Check all four boxes in the Batch File and Patterns Box on the bottom right of the firmware page.
10. Type in a name for the Firmware Tag and Batch File label.
11. Press the Update Firmware button.

These steps generate a new firmware image containing the pattern images and batch file located in the pattern mode tab and the batch file tab respectively. This firmware file is ready to be uploaded to the system when connected. If the user desires to load a previously created batch file, ensure that the batch file begins with a DISP\_MODE : 0x03 command and ends with a PAT\_START\_STOP : 0x02 command in order to have the pre-stored patterns run upon start-up.

#### Note

An alternate method is to build a firmware adding only the images. Then add the batch file that updates the LUT and runs the images.

### 7.9.2 Reprogram Firmware for a Different Supported DMD

To reprogram the firmware to support a different DMD, perform the following:

1. Place the boot hold jumper onto the EVM.
2. Power up the EVM. Upon power up, the default DMD in the GUI is the DLP6500.
3. Select the new target device from the GUI menu.
4. In the Firmware tab, click the Browse button. Search for the firmware in the Texas Instruments-DLP\ directory that matches the target DMD. For the single controller EVM this is either the DLPLCR65EVM or the DLPLCR55EVM. Choose either the OOB image or a custom firmware that matches the target device.
5. Click the Upload button and wait for the process to complete.
6. Power down the EVM and remove the boot hold jumper.
7. Attach the new hardware and power on the EVM.

## 7.10 Flash Device Parameters

For EVM use with several different flash memory parts, the user can edit the FlashDeviceParameters.txt file to match the flash memory part that has been installed with the EVM. This file is located in the DLPC900REF-SW-x.x.x\DLPC900REF-GUI\Flash directory of the [DLPC900REF-SW](#) bundle. An example with the Infineon S70GL02GS part is shown in [Figure 7-23](#) where the user comments out all lines EXCEPT for the top line which includes the chosen Infineon flash part. More detailed information can be found in the comments at the top of the text file.

```
Version, 4
// Flash Device Information
// DLPC900 information updated 3/1/2023
//
// The GUI reads mfg ID and device ID in sequential order in this file.
// The device used in the hardware MUST be first in the list in the case that IDs are identical with another part.
//
// M29DW128G and JS28F128M parts are no longer available to purchase.
//
// Field Descriptions:
// Mfg - Manufacturer Name
// MgfID - Manufacturer ID
// LMgfID - Long Manufacturer ID
// Device - Part name
// DevID - Device ID
// LDevID - Long Device ID
// Mb - Flash size in Megabits
// Alg - Flash also should be set to 0
// Size - Flash size in bytes
// #sec - Total number of sectors
// Sector_Addresses - Starting address of each sector. Include the sector addresses up to 16MB.

// Mfg      MfgID  LMgfID,          Device  DevID  LDevID,          Mb Alg  Size #sec Sector_Addresses
"Infineon", 0x0001, 0x0000000000000001, "S70GL02GS", 0x227E, 0x000000000000227E, 128, 0, 0x100000, 128, 0x0, 0x2000, 0x40
0xBA0000, 0xBC0000, 0xBE0000, 0xC00000, 0xC20000, 0xC40000, 0xC60000, 0xC80000, 0xCA0000, 0xCC0000, 0xCE0000, 0xD00000, 0xD20000,
0xD40000, 0xD60000, 0xD80000, 0xDA0000, 0xDC0000, 0xDE0000, 0xE00000, 0xE20000, 0xE40000, 0xE60000, 0xE80000, 0xEA0000, 0xEC0000, 0xEE0000, 0xF00000, 0xF20000, 0xF40000, 0xF60000, 0xF80000, 0xFA0000, 0xFC0000, 0xFE0000, 0xFF0000
// "Micron", 0x0020, 0x0000000000000020, "M29DW128G", 0x227E, 0x000000000000227E, 128, 0, 0x100000, 70, 0, 0x10000, 0x2000
// "Micron", 0x0089, 0x0000000000000089, "JS28F032M", 0x227E, 0x000000000000227E, 32, 0, 0x100000, 128, 0x0, 0x10000, 0x2000
// "Micron", 0x0089, 0x0000000000000089, "JS28F064M", 0x227E, 0x000000000000227E, 64, 0, 0x100000, 128, 0x0, 0x10000, 0x2000
6D0000, 0x6E0000, 0x6F0000, 0x700000, 0x710000, 0x720000, 0x730000, 0x740000, 0x750000, 0x760000, 0x770000, 0x780000, 0x790000
// "Micron", 0x0089, 0x0000000000000089, "JS28F128M", 0x227E, 0x000000000000227E, 128, 0, 0x100000, 128, 0x0, 0x20000, 0x40
0xBA0000, 0xBC0000, 0xBE0000, 0xC00000, 0xC20000, 0xC40000, 0xC60000, 0xC80000, 0xCA0000, 0xCC0000, 0xCE0000, 0xD00000, 0xD20000,
0xD40000, 0xD60000, 0xD80000, 0xDA0000, 0xDC0000, 0xDE0000, 0xE00000, 0xE20000, 0xE40000, 0xE60000, 0xE80000, 0xEA0000, 0xEC0000, 0xEE0000, 0xF00000, 0xF20000, 0xF40000, 0xF60000, 0xF80000, 0xFA0000, 0xFC0000, 0xFE0000, 0xFF0000
// "Micron", 0x0089, 0x0000000000000089, "MT28EW512", 0x227E, 0x000000000000227E, 128, 0, 0x100000, 128, 0x0, 0x20000, 0x40
0xBA0000, 0xBC0000, 0xBE0000, 0xC00000, 0xC20000, 0xC40000, 0xC60000, 0xC80000, 0xCA0000, 0xCC0000, 0xCE0000, 0xD00000, 0xD20000,
0xD40000, 0xD60000, 0xD80000, 0xDA0000, 0xDC0000, 0xDE0000, 0xE00000, 0xE20000, 0xE40000, 0xE60000, 0xE80000, 0xEA0000, 0xEC0000, 0xEE0000, 0xF00000, 0xF20000, 0xF40000, 0xF60000, 0xF80000, 0xFA0000, 0xFC0000, 0xFE0000, 0xFF0000
// "Infineon", 0x0001, 0x0000000000000001, "S29GL064P", 0x227E, 0x000000000000227E, 64, 0, 0x800000, 128, 0x0, 0x10000, 0x2000
```

**Figure 7-23. Flash Device Parameters Text File**

## 7.11 JTAG Flash Programming

The DLPC900 JTAG Programmer Tool is included in the [DLPC900REF-SW](#) bundle allowing a user to program the bootloader image into the flash using the JTAG boundary scan connector if, for example, the bootloader becomes corrupted and the board is rendered inoperable. The tool can also be used for updating the entire firmware image. Programming the entire firmware image using this method may take a long time. It is suggested to program only the bootloader using this method, and then use the DLP LightCrafter DLPC900 GUI with a USB connection to upload the entire firmware image. The following steps are for programming only the bootloader image.

Before using JTAG to reload the bootloader, first install the BOOTHold jumper (J11) and turn the system on with the USB cable connected to the PC. The system will show as connected in the GUI but will not recognize the attached DMD. Manually select the button that matches the current DMD and navigate to the firmware tab. Select the correct firmware image and reprogram. Then power down, remove the BOOTHold jumper, and restart the system. Reprogramming in this manner often recovers a system without requiring to reload the bootloader through JTAG.

The DLPC900 JTAG Programmer Tool requires the UM232H module with modifications, which is manufactured by Future Technology Devices International Ltd (FTDI Chip). The UM232H module can be purchased from Digi-key with the following part number: 768-1103-ND. The driver can be downloaded from the FTDI website ([www.ftdichip.com](http://www.ftdichip.com)). Select the VCP CDM WHQL Certified driver for Windows.

Make the following modifications to the UM232H and use [Figure 7-24](#) and [Figure 7-25](#) as a guide.

### Connection Details

1. BUS power configuration
  - Short PIN #2 and PIN #3 of J1 (SYS PWR)
  - Short PIN #2 and PIN #3 of J2 (I/O PWR)
2. J2-6 → GND (PWR)
3. J2-7 → TCK (OUTPUT)
4. J2-8 → TDO1 (OUTPUT)
5. J2-9 → TDI (INPUT)
6. J2-10 → TMS1 (OUTPUT)
7. J2-11 → TRSTZ (OUTPUT)

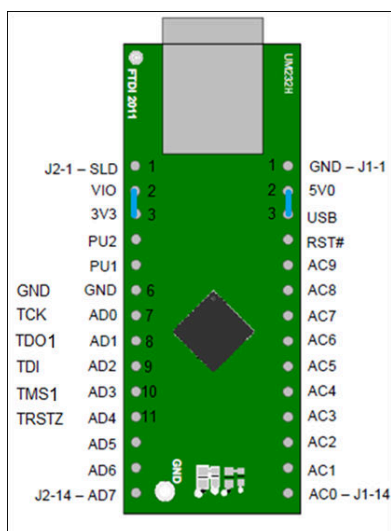

Figure 7-24. UM232H Module

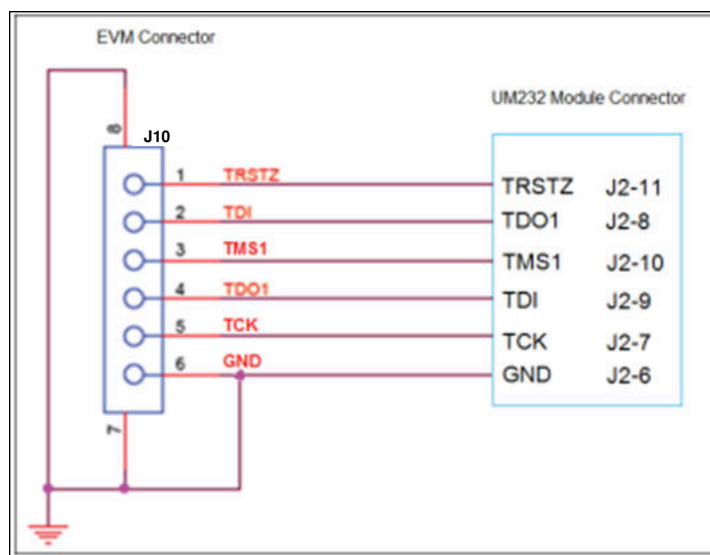

Figure 7-25. UM232H Wiring Diagram

Choose the driver found in the CDM WHQL Certified zip folder and allow driver installation to complete. Install a jumper at J9 and J11 on the DLP LightCrafter Single DLPC900 EVM. Connect the JTAG signals at J10 on the



DLP LightCrafter Single DLPC900 EVM to the UM232H module as shown in [Figure 7-25](#). Finally, connect the UM232H to the PC with USB cable.

---

**Note**

The JTAG programmer has its own copy of the FlashDeviceParameters.txt file which is located in the DLPC900REF-SW-x.x.x\DLPC900REF-JTAG directory of the [DLPC900REF-SW](#) bundle. Please see [Section 7.10](#) for instructions on how to edit this file to match your flash. If you have already made changes to the FlashDeviceParameters.txt file in the DLPC900REF-SW-x.x.x\DLPC900REF-GUI\Flash directory that work with the GUI, you may copy that file to the DLPC900REF-SW-x.x.x\DLPC900REF-JTAG directory

---

Start the DLPC900 Flash Programmer program and select the BoardFile.brd and the bootloader.bin included the install folder. Select USB as communication method from the Settings menu.

Power-up the EVM board and click the *Detect Chain* tool button. The tool detects the DLPC900 in JTAG chain. On the EVM notice the Red/Green LEDs (D5 & D6) light up to confirm the DLPC900 is currently connected.

Click the *Flash Info* button and confirm the correct flash part is detected by the tool. Using the *Flash Erase* button select the first sector(s) (to cover first 128 kilobytes) and erase these sector(s).

Once sector erase is complete, set the *Start Address* (HEX) to 0x00000000 and set the *Size* (HEX) to 0x20000. Then click the *Program Flash* button, and then wait until write is complete.

---

**Note**

Make sure that **verify is 100%** complete!

---

Finally remove the UM232H JTAG and remove jumper at J9 and J11, and then cycle the board power to the EVM. Plug in a USB cable between the EVM and the PC and allow the PC to detect the EVM USB connection.

## 7.12 Programming an EDID

The EDID can programmed through two methods.

To program the EDID though HDMI:

1. Remove power from the EVM and install the jumper on J3 and remove jumper on J4 on the EVM to enable the HDMI EDID.
2. Plug in the HDMI cable to the EVM. Plug other end of cable to a PC or video generator and apply power to the EVM.
3. Run the GUI and click the Batch Files button at the top of the GUI.
4. Click the Load Batch File button and browse for the correct HDMI\_EDID.txt file.
5. Click the Execute All button.
6. Remove power from the EVM and remove jumper from J3.

To program the EDID through Display Port:

1. Remove power from the EVM and install the jumper on J4 and remove jumper on J3 on the EVM to enable the Display Port EDID.
2. Remove the HDMI and Display Port cable from the EVM and apply power to the EVM.
3. Run the GUI and click the Batch Files button at the top of the GUI.
4. Click the Load Batch File button and browse for correct DP\_EDID.txt file.
5. Click the Execute All button.
6. Remove power from the EVM and remove the jumper from J4.



## 8 Connectors

This chapter describes the connector pins of the DLP LightCrafter Single DLPC900 EVM.

### 8.1 Input Trigger Connectors

The input trigger connector J20 on the DLP LightCrafter Single DLPC900 EVM pins are listed in [Table 8-1](#). The trigger inputs have hysteresis. Two matching six-pin, 1.25-mm connector part numbers are:

- Molex part number: 51021-0600
- Digi-Key part number: WM1724-ND

The corresponding connector terminal (crimp) part numbers are:

- Molex part number: 50079-8100
- Digi-Key part number: WM2023-ND

**Table 8-1. Trigger Input Connector Pins**

Description	Pin	Supply Range
Trigger In 1 Supply	1	External or internal 1.8 V and 3.3 V.
Trigger In 1	2	
Ground	3	Ground
Trigger In 2 Supply	4	External or internal 1.8 V and 3.3 V.
Trigger In 2	5	
Ground	6	Ground

### 8.2 Output Trigger Connectors

The output trigger connector J24 on the DLP LightCrafter Single DLPC900 EVM pins are listed in [Table 8-2](#). Two matching six-pin, 1.25-mm connector part numbers are:

- Molex part number: 51021-0600
- Digi-Key part number: WM1724-ND

The corresponding connector terminal (crimp) part numbers are:

- Molex part number: 50079-8100
- Digi-Key part number: WM2023-ND

**Table 8-2. Trigger Output Connector Pins**

Description	Pin	Supply Range
Trigger Out 1 Supply	1	External or internal 1.8 V and 3.3 V.
Trigger Out 1	2	
Ground	3	Ground
Trigger Out 2 Supply	4	External or internal 1.8 V and 3.3 V.
Trigger Out 2	5	
Ground	6	Ground

### 8.3 DLPC900 UART

The UART output connector J6 on the DLP LightCrafter Single DLPC900 EVM is shown in [Table 8-3](#) and is used solely for debug message output to a terminal. The TX out is 3.3 V LVTTTL level and requires on external transceiver to convert the LVTTTL level signals to RS232. The connector is a 6 pin header.

#### Note

This header **must** be included in any design for debug purposes.

**Table 8-3. UART Connector Pins**

Description	Pin	Supply Range
Ground	1	0 V

**Table 8-3. UART Connector Pins (continued)**

Description	Pin	Supply Range
RX	2	3.3 V
TX	3	3.3 V

## 8.4 DLPC900 I<sup>2</sup>C Port 0

The I<sup>2</sup>C\_0 connector J13 on the DLP LightCrafter Single DLPC900 EVM pins are shown in [Table 8-4](#). Two matching four-pin, 1.25-mm connector part numbers are:

- Molex part number: 51021-0400
- Digi-Key part number: WM1722-ND

The corresponding terminal (crimp) part numbers are:

- Molex part number: 50079-8100
- Digi-Key part number: WM2023-ND

**Table 8-4. I<sup>2</sup>C Port 0 Connector Pins**

Description	Pin	Supply Range
I <sup>2</sup> C SCL	1	3.3 V
I <sup>2</sup> C SDA	2	3.3 V
3.3 V supply	3	3.3 V
Ground	4	0 V

## 8.5 DLPC900 I<sup>2</sup>C Port 1

The I<sup>2</sup>C\_1 connector J14 pins are shown in [Table 8-5](#) (see note). Two matching four-pin, 1.25-mm connector part numbers are:

- Molex part number: 51021-0400
- Digi-Key part number: WM1722-ND

The corresponding terminal (crimp) part numbers are:

- Molex part number: 50079-8100
- Digi-Key part number: WM2023-ND

**Table 8-5. I<sup>2</sup>C Port 1 Connector Pins**

Description	Pin	Supply Range
I <sup>2</sup> C SCL	1	3.3 V
I <sup>2</sup> C SDA	2	3.3 V
3.3 V supply	3	3.3 V
Ground	4	0 V

## 8.6 DLPC900 I<sup>2</sup>C Port 2

The I<sup>2</sup>C\_2 connector J15 pins are shown in [Table 8-6](#). Two matching four-pin, 1.25-mm connector part numbers are:

- Molex part number: 51021-0400
- Digi-Key part number: WM1722-ND

The corresponding terminal (crimp) part numbers are:

- Molex part number: 50079-8100
- Digi-Key part number: WM2023-ND

**Table 8-6. I<sup>2</sup>C Port 2 Connector Pins**

Description	Pin	Supply Range
I <sup>2</sup> C SCL	1	3.3 V

**Table 8-6. I<sup>2</sup>C Port 2 Connector Pins (continued)**

Description	Pin	Supply Range
I <sup>2</sup> C SDA	2	3.3 V
3.3 V supply	3	3.3 V
Ground	4	0 V

## 8.7 JTAG Boundary Scan

The JTAG Boundary connector J10 on the DLP LightCrafter Single DLPC900 EVM pins are listed in [Table 8-7](#). Two matching six-pin, 1.25-mm connector part numbers are:

- Molex part number: 51021-0600
- Digi-Key part number: WM1724-ND

The corresponding terminal (crimp) part numbers are:

- Molex part number: 50079-8100
- Digi-Key part number: WM2023-ND

**Table 8-7. JTAG Boundary Scan Connector Pins**

Description	Pin	Supply Range
TRSTZ	1	3.3 V
TDI	2	3.3 V
TMS1	3	3.3 V
TDO1	4	3.3 V
TCK	5	3.3 V
Ground	6	Ground

## 8.8 GPIO and PWM

The GPIO and PWM connector J12 on the DLP LightCrafter Single DLPC900 EVM pins are listed in [Table 8-8](#). Two matching 14-pin, 2.00-mm connector part numbers are:

- Molex part number: 87832-1420
- Digi-Key part number: WM18641-ND

A corresponding mating connector part numbers are:

- Molex part number: 87568-1493
- Digi-Key part number: WM14314-ND

**Table 8-8. GPIO and PWM Connector Pins**

Description	Pin	Supply Range
3.3V	1	3.3 V
3.3V	2	3.3 V
GPIO_PWM_00	3	3.3 V
GPIO_04	4	3.3 V
GPIO_PWM_01	5	3.3 V
GPIO_05	6	3.3 V
GPIO_PWM_02	7	3.3 V
GPIO_06	8	3.3 V
GPIO_PWM_03	9	3.3 V
GPIO_07	10	3.3 V
GPIO_08	11	3.3 V
Ground	12	Ground
Ground	13	Ground

**Table 8-8. GPIO and PWM Connector Pins  
(continued)**

Description	Pin	Supply Range
Ground	14	Ground

## 8.9 Power

The power socket J17 on the DLP LightCrafter Single DLPC900 pins are shown in [Power Connector Pins for J17](#). Two matching connector part numbers are:

- Switchcraft part number: 760
- Digi-Key part number: SC1051-ND

**Table 8-9. Power Connector Pins for J17**

Description	Pin	Supply Range
Input Supply	1	12-V DC –5%/+10%
Ground	2	0 V
Ground	3	0 V

The power socket J18 on the DLP LightCrafter Single DLPC900 pins are shown in [Table 8-10](#). Two matching connector part numbers are:

- Molex part number: 39039062
- Digi-Key part number: WM12978-ND

**Table 8-10. Power Connector Pins for J18**

Description	Pin	Supply Range
Ground	1	0 V
Ground	2	0 V
Ground	3	0 V
Input Supply	4	12-V DC –5%/+10%
Input Supply	5	12-V DC –5%/+10%
Input Supply	6	12-V DC –5%/+10%

## 8.10 External Parallel Video Connector

The external parallel video connector J26 on the DLP LightCrafter Single DLPC900 EVM is an 120-pin connector header. A matching connector part number is:

- Samtec part number: QSH-060-01-L-D-A
- Digi-Key part number: SAM8181-ND

## 9 Power Supply Requirements

### 9.1 External Power Supply Requirements

The DLP LightCrafter Single DLPC900 EVM does not include a power supply. The external power supply requirements are:

- Nominal voltage: 12-V DC -5%/+10%
- Minimum current: 5 A
- Maximum Current: 7 A
- J17 DC connector size:
  - Inner diameter: 2.5 mm
  - Outer diameter: 5.5 mm
  - Shaft: 9.5-mm female, center positive
- A recommended power supply is [Digi-Key part number 102-3811-ND](#), or equivalent
- J18 matching connector part numbers:
  - Molex part number: 39039062
  - Digi-Key part number: WM12978-ND

---

#### Note

External Power Supply Regulatory Compliance Certifications: Recommend selection and use of an external power supply which meets TI's required minimum electrical ratings in addition to complying with applicable regional product regulatory and safety certification requirements such as (by example) UL, CSA, VDE, CCC, PSE, and so forth.

---

## 10 Safety

### 10.1 Caution Labels

CAUTION



To minimize the risk of fire or equipment damage, make sure that air is allowed to circulate freely around the DLP LightCrafter DLPC900 EVM board when operating.

CAUTION



The kit contains ESD-sensitive components. Handle with care to prevent permanent damage.

## 11 Revision History

NOTE: Page numbers for previous revisions may differ from page numbers in the current version.

### Changes from Revision B (July 2022) to Revision C (May 2023)

**Page**

• Fixed J23 pin 11 to correctly reflect 3.3V connection.....	9
• Added J26 to the table of pin connections.....	9
• Clarified the pulse length of trigger output 2 as 19.4 $\mu$ s.....	12
• Corrected that trigger input 1 advances to the next pattern waiting for a trigger input.....	12
• Added information regarding supported GUI and firmware versions for the DLP5500 DMD.....	15
• Added descriptions of items in DLPC900REF-SW.....	19
• Added DLPA200 fault to the list of descriptions of status indicators.....	23
• Added information about the DLPA200 fault conditions.....	24
• Added information that the Get command only reads values from the primary controller.....	26
• Added note that the EVM is connected only on Pixel Clock 1.....	26
• Added link to table in DLPC900 Programmer's Guide of minimum exposure times.....	35
• Added a note to the Caution statement regarding supported GUI and firmware versions for the DLP5500 DMD.....	46
• Added information about the number of patterns the EVM can hold in flash memory.....	49
• Added information to the caution note about the recommended firmware version.....	50
• Added new section to describe how to reprogram firmware to support a different DMD.....	53
• Updated <a href="#">Figure 7-23</a> changing Cypress to Infineon.....	54
• Added section describing how to program an EDID.....	56
• Added pin J18 table and description .....	60
• Created new section for pin J26.....	60
• Changed minimum current from 0 A to 5 A.....	61
• Added information about J18 matching connector.....	61

### Changes from Revision A (April 2022) to Revision B (July 2022)

**Page**

• Changed all instances of legacy terminology to "Primary" and "Secondary" throughout this guide.....	1
• Added Note: Heartbeat is present even if no DMD is present.....	9
• Changed J11 "HOLDBoot" jumper description to "BOOTHold" jumper.....	9
• Added Controller Board and DMD Board Assembly instructions.....	13
• Updated to Secondary terminology for <i>Secondary Present and Ready</i> Status item.....	23



## IMPORTANT NOTICE AND DISCLAIMER

TI PROVIDES TECHNICAL AND RELIABILITY DATA (INCLUDING DATA SHEETS), DESIGN RESOURCES (INCLUDING REFERENCE DESIGNS), APPLICATION OR OTHER DESIGN ADVICE, WEB TOOLS, SAFETY INFORMATION, AND OTHER RESOURCES "AS IS" AND WITH ALL FAULTS, AND DISCLAIMS ALL WARRANTIES, EXPRESS AND IMPLIED, INCLUDING WITHOUT LIMITATION ANY IMPLIED WARRANTIES OF MERCHANTABILITY, FITNESS FOR A PARTICULAR PURPOSE OR NON-INFRINGEMENT OF THIRD PARTY INTELLECTUAL PROPERTY RIGHTS.

These resources are intended for skilled developers designing with TI products. You are solely responsible for (1) selecting the appropriate TI products for your application, (2) designing, validating and testing your application, and (3) ensuring your application meets applicable standards, and any other safety, security, regulatory or other requirements.

These resources are subject to change without notice. TI grants you permission to use these resources only for development of an application that uses the TI products described in the resource. Other reproduction and display of these resources is prohibited. No license is granted to any other TI intellectual property right or to any third party intellectual property right. TI disclaims responsibility for, and you will fully indemnify TI and its representatives against, any claims, damages, costs, losses, and liabilities arising out of your use of these resources.

TI's products are provided subject to [TI's Terms of Sale](#) or other applicable terms available either on [ti.com](https://www.ti.com) or provided in conjunction with such TI products. TI's provision of these resources does not expand or otherwise alter TI's applicable warranties or warranty disclaimers for TI products.

TI objects to and rejects any additional or different terms you may have proposed.

Mailing Address: Texas Instruments, Post Office Box 655303, Dallas, Texas 75265  
Copyright © 2023, Texas Instruments Incorporated