

REVISIONS					
P	LTR	DESCRIPTION	DATE	DWN	APVD
	BA	NEW RELEASE	10JULY2010	PT	St.P
	BA1	ECR-13-018622	28NOV2013	KR	TN

FOR FURTHER INFORMATION SEE DATA SHEET FOR SERIES S - SMD MOULDED POWER RESISTOR

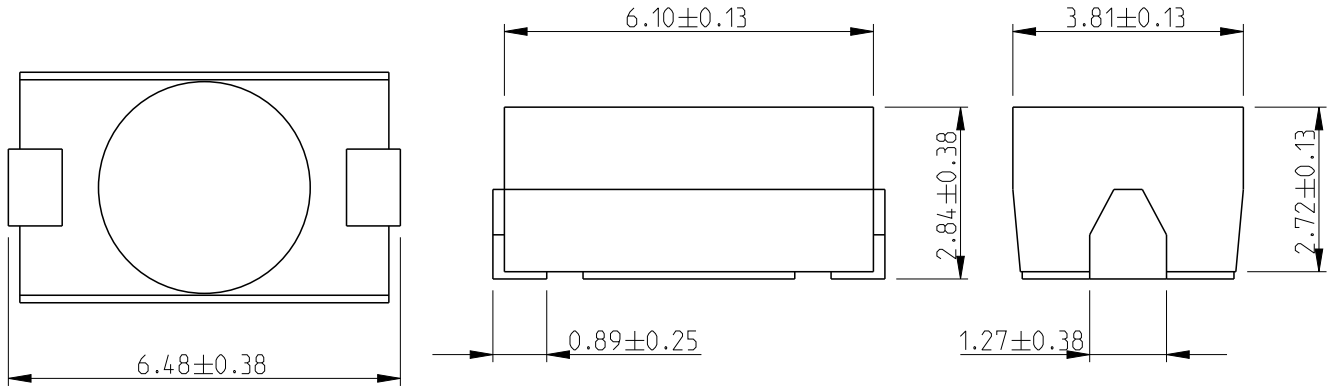

RECOMMENDED LAND PATTERN

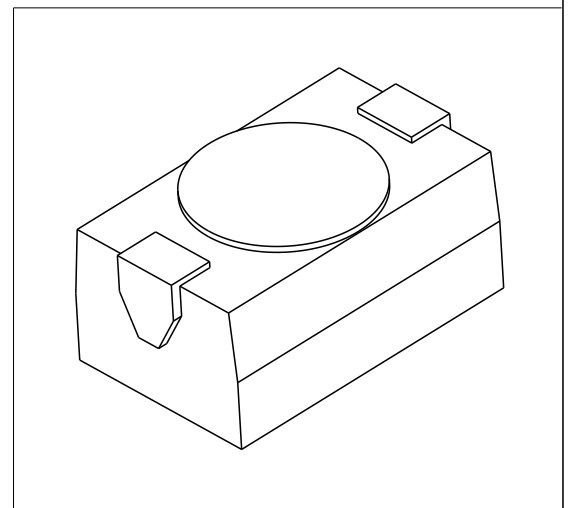
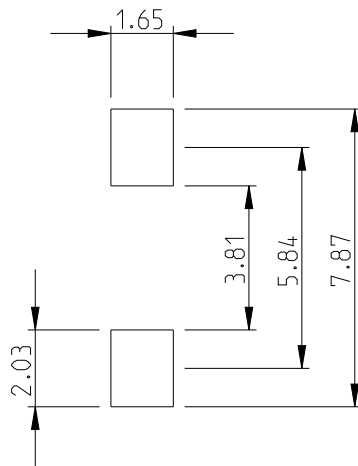

2008

RELEASED FOR PUBLICATION

ALL RIGHTS RESERVED.

THIS DRAWING IS UNPUBLISHED.

BY -

© COPYRIGHT 2008

DIMENSIONS: mm	DWN PARUSURAM.T 10JULY2010	MATERIAL -	FINISH -
TOLERANCES UNLESS OTHERWISE SPECIFIED:	CHK ALLAN.P 10JULY2010	 TE Connectivity	
0 PLC $\pm 0.2$ 1 PLC $\pm 0.1$ 2 PLC $\pm$ 3 PLC $\pm$ 4 PLC $\pm$ ANGLES $\pm 5^\circ$	APVD STEPHEN.P 10JULY2010		
	PRODUCT SPEC -	NAME SMD PRECISION CURRENT SENSE RESISTOR SERIES SL1	
	APPLICATION SPEC -	SIZE A 4	RESTRICTED TO -
	WEIGHT -	CAGE CODE 00779	DRAWING NO C=1624253
Customer Drawing		SCALE 8:1	SHEET 1 OF 1
		REV BA1	