

TPS23861EVM-612: Auto-Mode Evaluation Module for TPS23861

This user's guide describes the evaluation modules (EVM) for the TPS23861 (TPS23861EVM-612). The EVM contains evaluation and reference circuitry for the TPS23861. The TPS23861 is a Power-over-Ethernet (PoE) device for power sourcing equipment (PSE).

Contents

1	Description	3
2	Quick Start	3
3	General Use Features	8
4	TPS23861EVM-612 PI Commander GUI Setup	10
5	EVM Schematic, Layout Guidelines and PCB Assembly, Layer Plots	26
6	Bill of Materials	34
Appendix A	Revision A Schematic	37

List of Figures

1	Basic Test Setup	5
2	Basic Setup Using USB-TO-GPIO	6
3	Advanced Setup Using LaunchPad	7
4	PI Commander Device Menu Window	10
5	PI Commander Device Selection Window	10
6	Devices Found in Scan	11
7	Detected Devices Selection	11
8	Device Selector Approval	11
9	Telemetry Page	12
10	PD Detection	13
11	Telemetry Data Collection and Graphs	14
12	Telemetry Data Collection and Graphs, Device 2	15
13	High-Level Status, 2 Devices	15
14	I2C Register Page	16
15	Device Configuration Page	17
16	Configuration Wizard	17
17	Hit 'S' to Start	18
18	Program Started	19
19	Terminal Response with Connected Ports	19
20	TPS23861 POE Documentation	20
21	Overall System Software Structure	21
22	Power on Decision Flow Chart	23
23	System Power Monitor Flow Chart	24
24	TPS23861EVM-612 (Motherboard) Schematic: Control	26
25	TPS23861EVM-612 (Motherboard) Schematic: Power Ports	27
26	TPS23861EVM-613 (Daughterboard) Schematic	28
27	TPS23861EVM-612 (Motherboard) Top Side Assembly	29

28	TPS23861EVM-612 (Motherboard) Top Side Routing	30
29	TPS23861EVM-612 (Motherboard) Layer 2 Routing	30
30	TPS23861EVM-612 (Motherboard) Layer 3 Routing	31
31	TPS23861EVM-612 (Motherboard) Bottom Side Routing	31
32	TPS23861EVM-613 (Daughterboard) Top Side Assembly	32
33	TPS23861EVM-613 (Daughterboard) Top Side Routing	32
34	TPS23861EVM-613 (Daughterboard) Bottom Side Routing	33
35	TPS23861EVM-613 (Daughterboard) Bottom Side Assembly	33
36	TPS23861EVM-612 (Motherboard) Schematic: Control	37

List of Tables

1	TPS23861EVM-612 Voltage Rail Current Requirements	4
2	EVM Input/Output Connectors	8
3	EVM LEDs	8
4	EVM Test Points	9
5	EVM Jumpers	9
6	Terminology	22
7	State Definitions	22
8	Function Definitions	22
9	User Configurable Parameters	23
10	TPS23861EVM-612 Bill of Materials	34
11	TPS23861EVM-613 Bill of Materials.....	35

Trademarks

LaunchPad, Code Composer Studio are trademarks of Texas Instruments.

1 Description

The TPS23861EVM-612 features the quad port, TPS23861, IEEE 802.3at PoE PSE controller. The EVM consists of a motherboard (TPS23861EVM-612) and daughter board (TPS23861EVM-613) containing two TPS23861 devices. The TPS23861EVM-612 provides a multi-port base platform interface for TPS23861EVM-613, MSP-EXP430G2 (LaunchPad™), and USB-TO-GPIO (USB Interface Adapter).

1.1 Features

- TPS23861 PSE devices default to auto-mode operation so no operator interface over I²C is required.
- Four IEEE802.3at, Type 2 (30 W) ports with 1000BASE-T (gigabit Ethernet data pass through)
- Two non-standard, high power ports with 1000BASE-T (gigabit Ethernet data pass through)
- Fully certified using UNH-IOL Clause #33 PSE Conformance Test Suite
- Single DC power supply input
- On board 3.3-V regulator
- On board I²C interface to both TPS23861PW devices from either USB-TO-GPIO or MSP-EXP430G2.
- Port ON status LEDs
- User test points

1.2 Applications

- Ethernet switches and routers
- Surveillance VDRs
- High power PoE
- PoE pass-through systems

2 Quick Start

2.1 Input Power

2.1.1 Input Power (Labeled VPWR)

DC input voltage is provided through J1 (screw jack). A dc power supply or laptop adapter with sufficient current capacity can power the EVM.

CAUTION

Reverse voltage protection is not provided; ensure that the correct polarity is applied to J1.

This dc input is labeled *VPWR* in the schematics and is used for port *VBUS* as well as for the TPS23861 devices. The *VPWR* connections to the PoE ports are not fused. Each two pair port is capable of furnishing at least 30 W and each four pair port can furnish 60 W. The power supply requirements are summarized in [Table 1](#).

The minimum PSE port voltage is 44 VDC for type 1 and 50 V for type 2. The nominal dc voltage at *VPWR* is 48 VDC for a type 1 and 54 VDC for a type 2. During evaluation, choose the appropriate dc power supply for the type 1 or type 2 environment.

2.1.2 Local 3.3 V (Labeled 3.3V)

Local 3.3 V for local devices (labeled as 3.3V) is provided by the on-board LM5019 buck converter. The LM5019 provides a basic power-on sequence and provides a well-controlled and consistent startup in order to prevent erratic operation. This is described in detail in [SLVA723](#). In addition to 48 V, the TPS23861 requires 3.3 V for the digital circuitry and this is routed up to TPS23861EVM-613 over the connector interface. The current consumption is 25-mA typical and 30-mA maximum.

2.1.3 External 3.3 V (Labeled 3.3V_USB)

The TPS23861EVM-612 provides galvanic isolation between PoE power side and host side using digital isolators (ISO7241CD). The host side power is provided either from J2 (from USB-TO-GPIO) or J5 (from LaunchPad). The current consumption is 3-mA typical and 5-mA maximum.

CAUTION

Do not use USB-TO-GPIO and LaunchPad simultaneously.

Table 1. TPS23861EVM-612 Voltage Rail Current Requirements

Voltage Rail	Typical (mA)	Maximum (mA)
3.3V_USB	2.5	3
3.3V	25	30
VPWR (Miscellaneous)	35	57
VPWR (8x Type 1 Output Ports)	2992	3142
VPWR (8x Type 2 Output Ports)	5160	5418
VPWR Total (8x Type 1 Ports)	3027	3202
VPWR Total (8x Type 2 Ports)	5195	5478

2.2 PoE Port Interfaces

The TPS23861 devices are pre-configured to operate in auto mode and, as such, no external communication interface is required to enable or configure the TPS23861EVM-612. A standard PD can be plugged into ports 1–4 and be expected to operate automatically.

2.2.1 Standard 30 W, IEEE802.3at Type 2 ports

Four standard ports are provided at J19, J20, J8, and J7 for two pair ports 1, 2, 3, and 4 respectively. The power furnished is according to alternative A with MDI-X polarity.

2.2.2 Nonstandard 60-W Ports

Two non-standard ports are provided at J21 and J9 for four pair ports 1 and 2, respectively. The power furnished is according to alternative A with MDI-X polarity and alternative B on a single port connector. A standard PD may not power on at this interface, but a PD which can process power on all of the Ethernet conductors (refer to TI application report, [SLVA625](#)) can power on and consume up to 60 W.

2.3 I²C Interfaces

Two I²C interfaces to the TPS23861 are provided on the EVM.

2.3.1 USB-TO-GPIO

J2 provides an interface with the USB-TO-GPIO adapter when using a PC and GUI.

2.3.2 MSP-EXP430G2

J3, J4, and J5 provide an interface with the MSP-EXP430G2 or LaunchPad when using a PC to develop custom power management code.

2.4 Basic Test Setup (Out-of-the-box Auto-Mode Operation)

Figure 1 shows the basic test setup for the TPS23861EVM. All that is required is a dc power supply (44–57 VDC, 5 A), Ethernet patch cable, and any PD load.

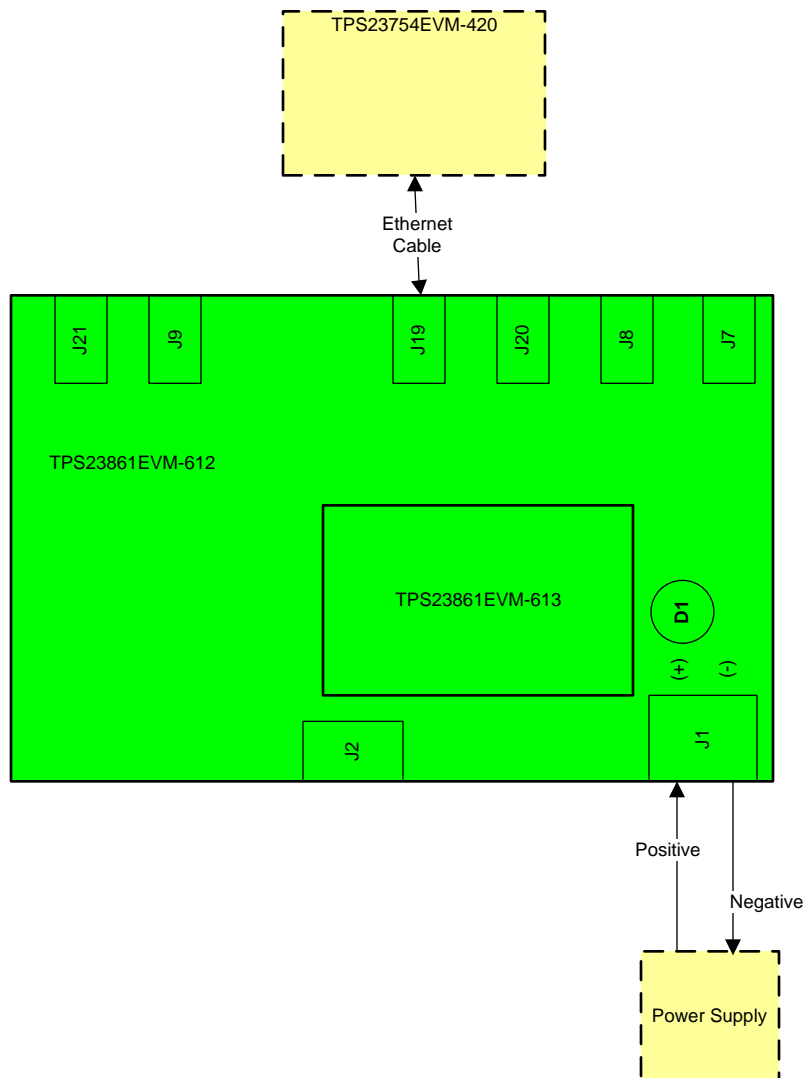

Figure 1. Basic Test Setup

2.5 Basic Test Setup Using USB-TO-GPIO for I²C Interface (Auto-Mode Operation with I²C Monitoring)

An I²C interface is provided through J2 to the TPS23861PW devices on the TPS23861EVM-613. The USB-TO-GPIO adapter (not included) can be used with any TI GUI which uses USB-TO-GPIO to read and write over an I²C bus. [Figure 2](#) illustrates the basic setup using USB-TO-GPIO.

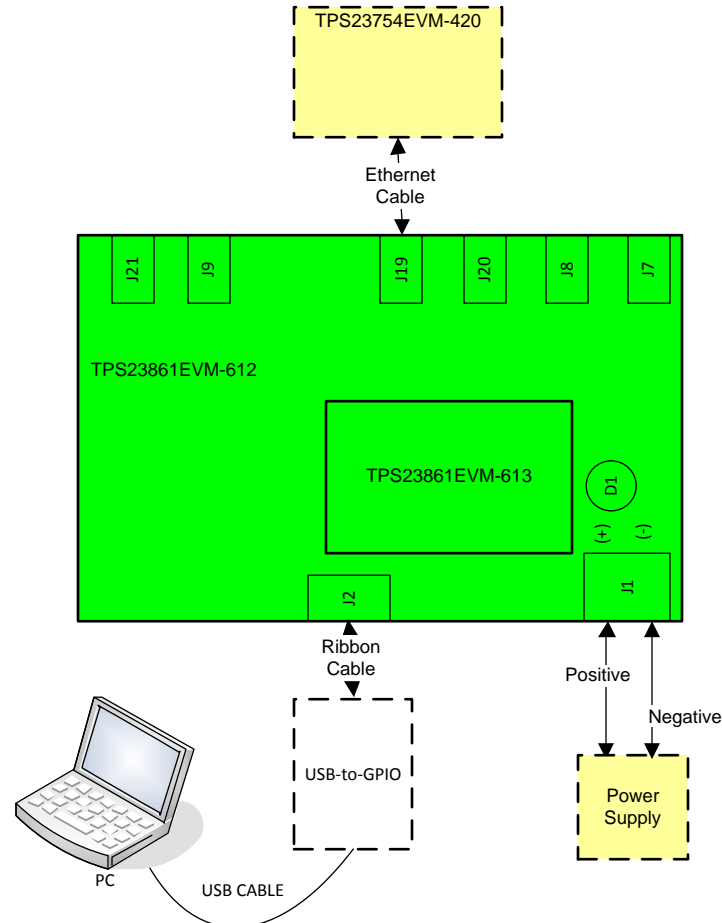

Figure 2. Basic Setup Using USB-TO-GPIO

2.6 Advanced Test Setup Using MSP-EX430G2 (LaunchPad)

The LaunchPad (not included) running a custom software program can communicate with the TPS23861PW devices on the TPS23861EVM-613. [Figure 3](#) shows the advanced setup using LaunchPad.

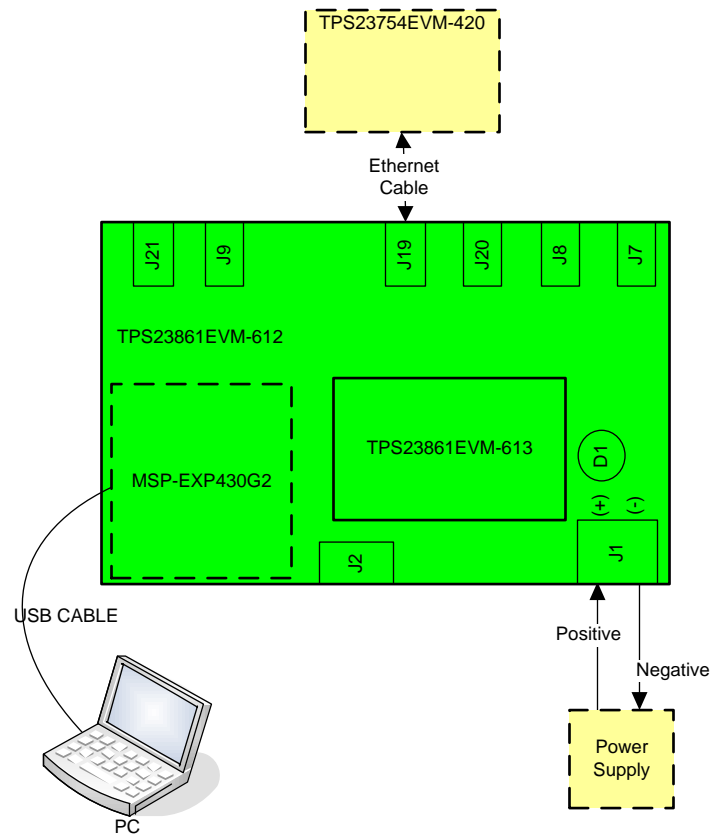

Figure 3. Advanced Setup Using LaunchPad

3 General Use Features

3.1 EVM Input/Output Connectors and Switches

Table 2 lists the EVM input and output connectors.

Table 2. EVM Input/Output Connectors

Connector/Switch	Label	Description
J1	J1	DC power supply screw jack. (44–57 VDC, 5 A). Use a 48 VDC (nominal) for type 1 and 54 VDC (nominal) for type 2 PSE operation.
J2	J2	Ribbon cable connection to USB-TO-GPIO adapter
J3	J3	LaunchPad Control (mates with LaunchPad J1)
J4	J4	LaunchPad I ² C (mates with LaunchPad J2)
J5	J5	LaunchPad Power (mates with LaunchPad J6)
J6	J6	TPS23861EVM-613 Control (mates with TPS23861EVM-613 J3)
J17	J17	TPS23861EVM-613 Port 5-8 (mates with TPS23861EVM-613 J2)
J18	J18	TPS23861EVM-613 Port 1-4 (mates with TPS23861EVM-613 J1)
J22	J22	Two-pair port 1 data only
J19	2 Pair Port 1	Two-pair port 1 power and data
J23	J23	Two-pair port 2 data only
J20	2 Pair Port 2	Two-pair port 2 power and data
J11	J11	Two-pair port 3 data only
J8	2 Pair Port 3	Two-pair port 3 power and data
J10	J10	Two-pair port 4 data only
J7	2 Pair Port 4	Two-pair port 4 power and data
J24	J24	Four-pair port 1 data only
J21	4 Pair Port 1	Four -pair port 1 power and data
J12	J12	Four -pair port 2 data only
J9	4 Pair Port 2	Four -pair port 2 power and data
J29	J29	Chassis ground tie point

3.2 EVM LEDs

Table 3 lists the EVM LEDs and their descriptions.

Table 3. EVM LEDs

LED	Color	Label	Description
D1	GREEN	48V	48-V ON indicator
D16	BLUE	D16	Two-pair port 1 power is ON. For J19 supplier #1 (see the bill of materials (BOM)), J19 internal port LED is active. For supplier #2, D16 is active.
D17	BLUE	D17	Two-pair port 2 power is ON. For J20 supplier #1 (see the BOM), J20 internal port LED is active. For supplier #2, D17 is active.
D13	BLUE	D13	Two-pair port 3 power is ON. For J8 supplier #1 (see the BOM), J8 internal port LED is active. For supplier #2, D13 is active.
D12	BLUE	D12	Two-pair port 4 power is ON. For J7 supplier #1 (see the BOM), J7 internal port LED is active. For supplier #2, D12 is active.
D18	BLUE	D18	Four-pair port 1A power is ON. For J21 supplier #1 (see the BOM), J21 internal port LED is active. For supplier #2, D18 is active.
D14	BLUE	D14	Four-pair port 2A power is ON. For J9 supplier #1 (see the BOM), J9 internal port LED is active. For supplier #2, D14 is active.

3.3 EVM Test Points

Table 4 lists and describes the EVM test points.

Table 4. EVM Test Points

TP	Color	Label	Description
Motherboard: TPS23861EVM-612			
TP1	RED	VPWR	Used for VPWR
TP2	RED	3.3V	Used for TPS23861 VDD
TP3	SMT	GND	VPWR ground
TP4	WHT	SDA	I ² C Data from LaunchPad and USB-TO-GPIO
TP5	WHT	SCL	I ² C Clock from LaunchPad and USB-TO-GPIO
TP6	WHT	PSE_SDAO	I ² C data out from TPS23861
TP7	WHT	PSE_SCL	I ² C clock to TPS23861
TP8	WHT	PSE_SDAI	I ² C data in to TPS23861
TP9	BLK	GND1	Ground from LaunchPad and USB-TO-GPIO
TP11	SMT	TP11	Chassis ground test point
TP14	SMT	GND	VPWR ground test point
TP15	SMT	GND	VPWR ground test point
TP16	SMT	GND	VPWR ground test point
Daughterboard: TPS23861EVM-613			
TP4	RED	2P4D	Two-pair port 4 DRAIN
TP12	WHT	2P4G	Two-pair port 4 GATE
TP5	WHT	4P1AG	Four-pair port 1A GATE
TP6	RED	4P1AD	Four-pair port 1A DRAIN
TP9	WHT	4P1BG	Four-pair port 1B GATE
TP10	RED	4P1BD	Four-pair port 1B DRAIN
TP1	BLK	GND	VPWR ground
TP8	SMT	GND	VPWR ground

3.4 EVM Test Jumpers

The EVM is equipped with shunts on the jumper positions identified in Table 5, in the Default Pin Position column. Shunts can be moved and removed, as required, during use.

Table 5. EVM Jumpers⁽¹⁾

Jumper	Default Pin Position	Label	Description
J27	1-2	P1	Two-pair port 1 LED bias
J28	1-2	P2	Two-pair port 2 LED bias
J16	1-2	P3	Two-pair port 3 LED bias
J15	1-2	P4	Two-pair port 4 LED bias
J26	1-2	P5	Four-pair port 1A LED bias
J25	1-2	P6	Four-pair port 1B LED bias
J14	1-2	P7	Four-pair port 2A LED bias
J13	1-2	P8	Four-pair port 2B LED bias

⁽¹⁾ Remove the jumpers listed in this table when doing SIFOS or UNH DC MPS testing.

4 TPS23861EVM-612 PI Commander GUI Setup

4.1 TPS23861EVM-612 GUI Installation

The Texas Instruments PI Commander graphical user interface (GUI) can be used with TPS23861EVM-612 to provide real time feedback on port telemetry. PI Commander (*PI Commander - TPS23861-setup.exe*) can be downloaded from the [TPS23861](#) product page in the Software section.

Follow the onscreen instructions to complete the installation. PI Commander uses the USB-TO-GPIO as an interface between the PC USB port and TPS23861EVM-612 J2 connector (I2C interface). Before starting PI Commander, make sure the USB-TO-GPIO is properly connected to TPS23861EVM-612 as shown in [Figure 2](#).

4.2 TPS23861EVM-612 GUI Operation

Start Texas Instruments PI Commander - TPS23861 by clicking START → All Programs → Texas Instruments → PI-Commander-n.n.n-n, then PI-Commander-PoE. A command window opens as the program starts and scans for devices (note that the *Scanning for devices* message displays in the window footer until the scan is complete). Once the scan is complete, click on the *UNKNOWN 30* device ([Figure 4](#)).

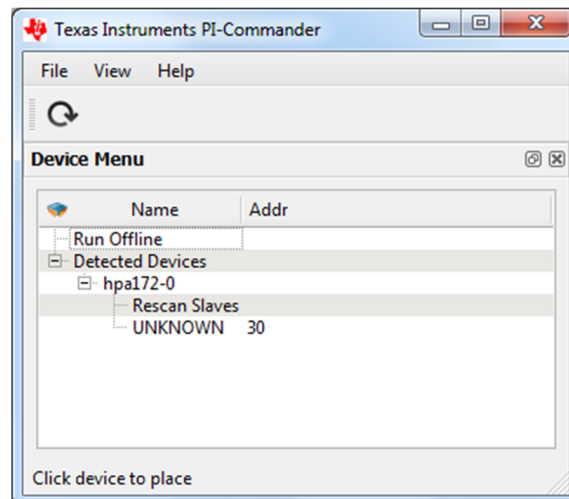

Figure 4. PI Commander Device Menu Window

TPS23861 shows up in the *Device Selector* window. Click the **OK** button.

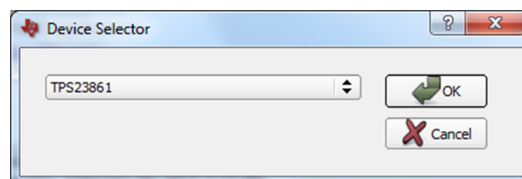

Figure 5. PI Commander Device Selection Window

As the program GUI starts, the window in [Figure 6](#) appears showing the devices found in the scan. Device #1 (two-pair ports 1-4) is at address 20 and device #2 (four-pair ports 1 and 2) is at address 28. Click the **OK** button.

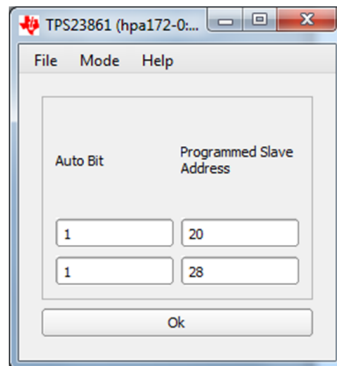

Figure 6. Devices Found in Scan

Choose device #1 (UNKNOWN 20) or device #2 (UNKNOWN 28).

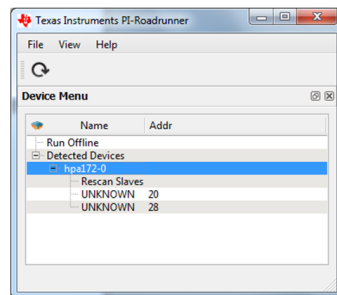

Figure 7. Detected Devices Selection

Once the following window pops up, click the **OK** button.

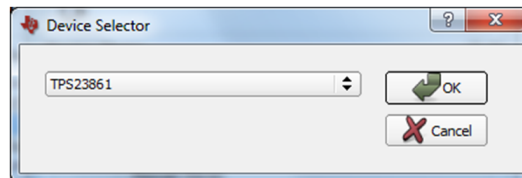

Figure 8. Device Selector Approval

PI Commander launches and starts the Telemetry Page as shown in Figure 9 for device #1. Note that more than one device window can be opened at the same time by choosing another device from the device menu.

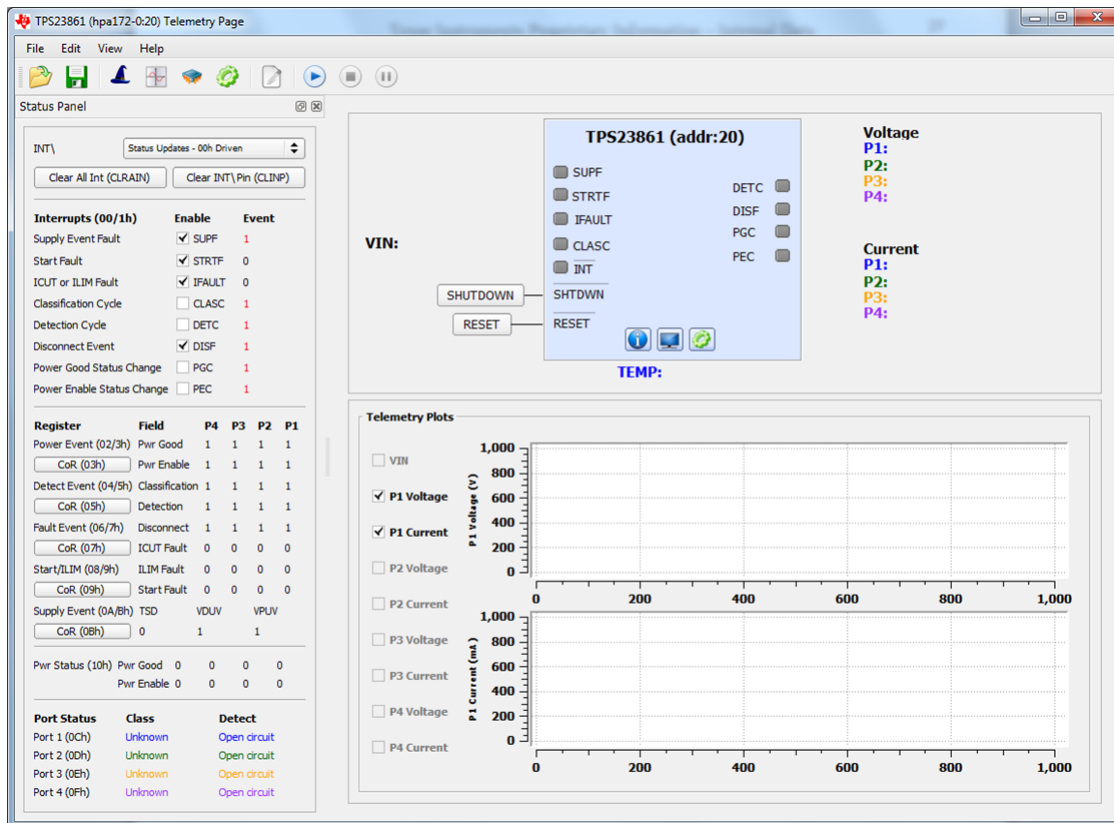

Figure 9. Telemetry Page

At any time, insert the ethernet cable connected to the PD load device into the two-pair port jacks. For the case in Figure 10, type two PDs are installed into ports 1, 2, 3, and 4 respectively and are successfully detected, classified, and powered up.

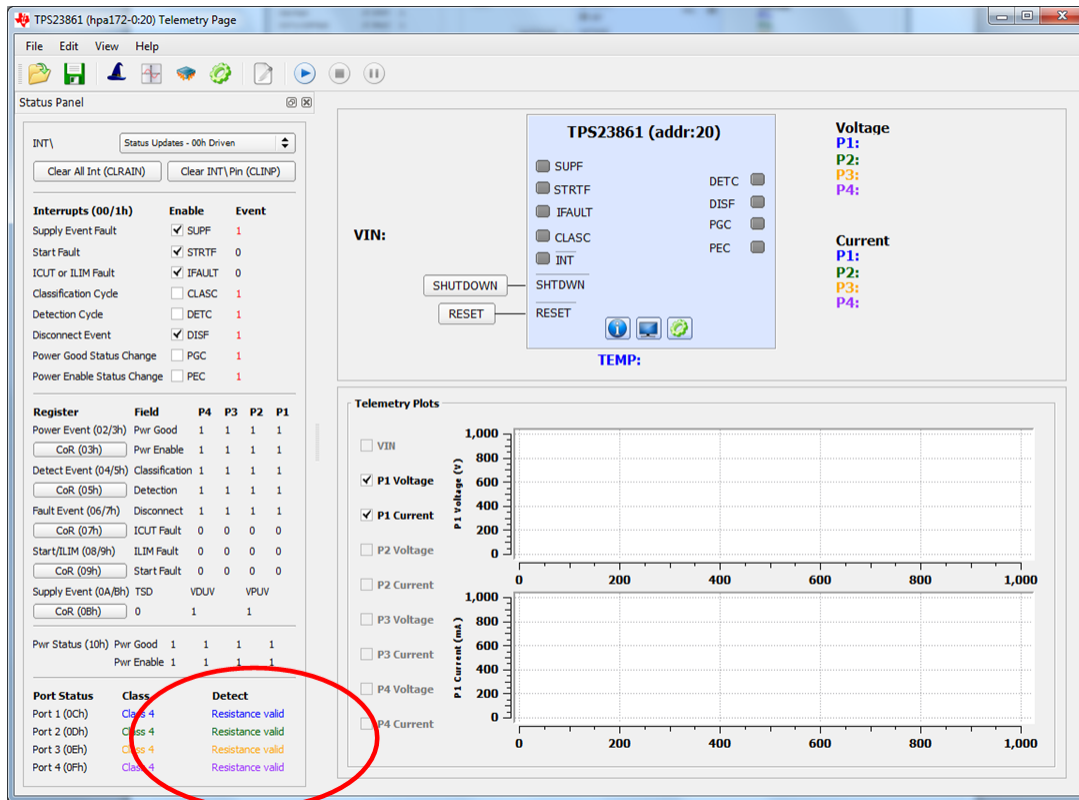

Figure 10. PD Detection

Clicking the **Run** button (blue arrow in the header bar) starts telemetry data collection and graphs (Figure 11).

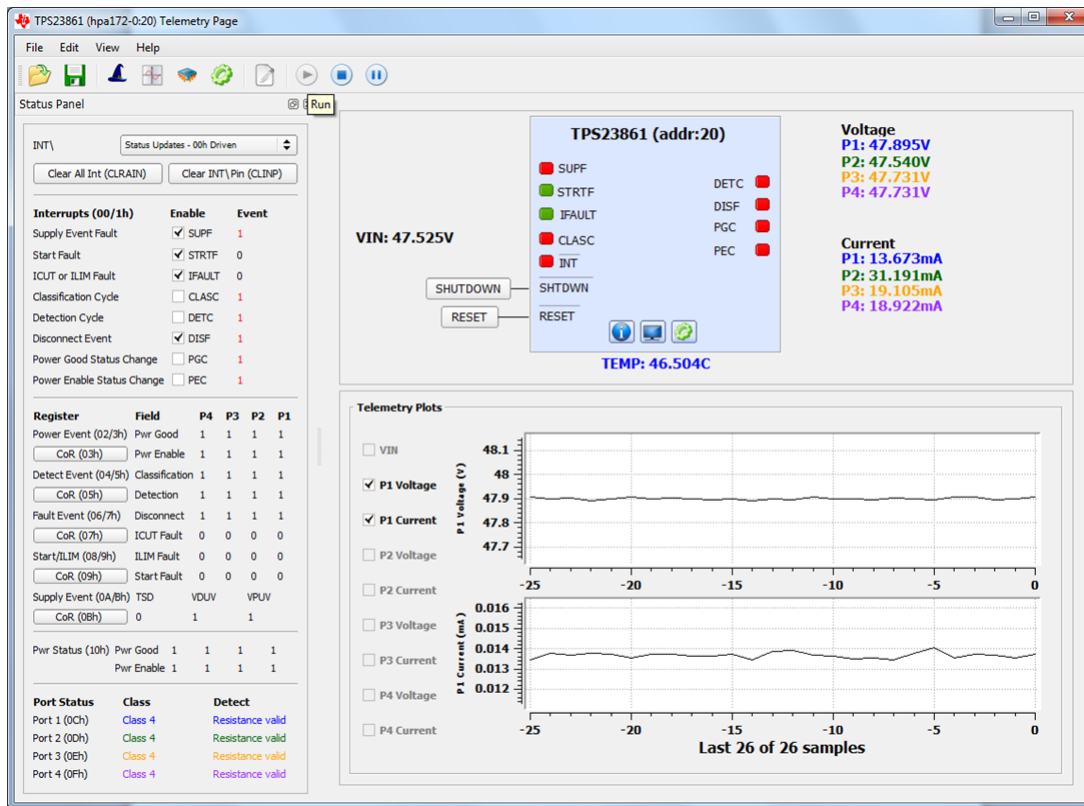

Figure 11. Telemetry Data Collection and Graphs

Following a similar procedure, device #2 can be viewed. For the case in Figure 12, two forced-four pair PDs are installed into ports 1 and 2 respectively and are successfully detected, classified, and powered up.

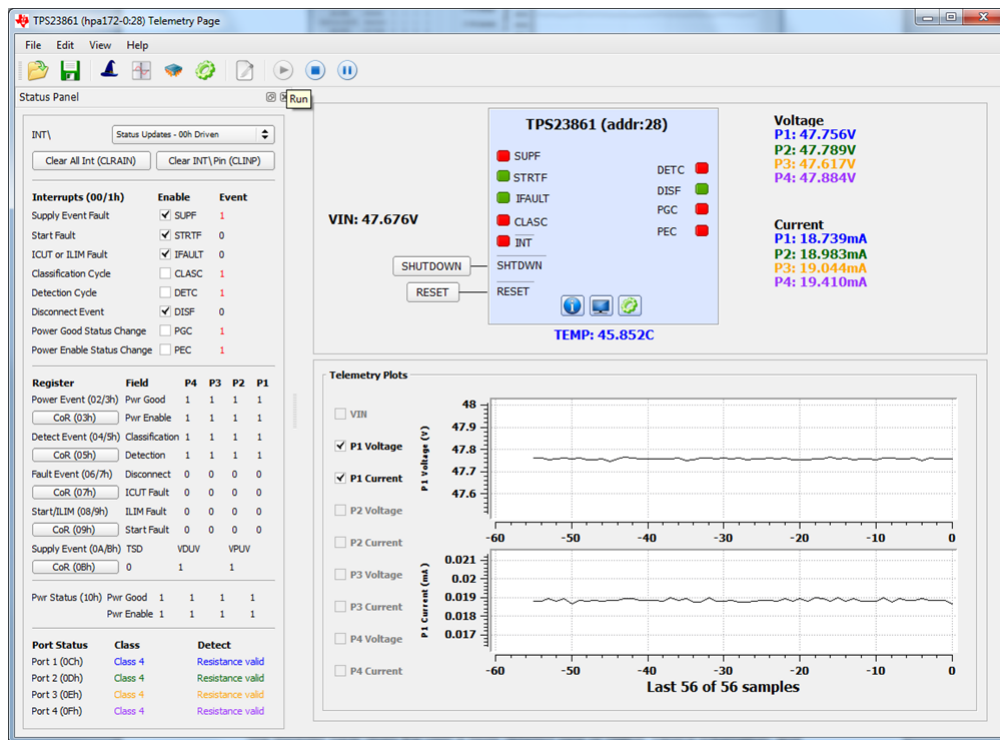

Figure 12. Telemetry Data Collection and Graphs, Device 2

The Dashboard window is also available showing a high level status (two devices shown).

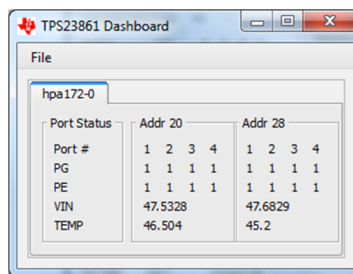

Figure 13. High-Level Status, 2 Devices

The I2C Register Page (Figure 14) provides a detailed view of Status, Device, and Telemetry information.

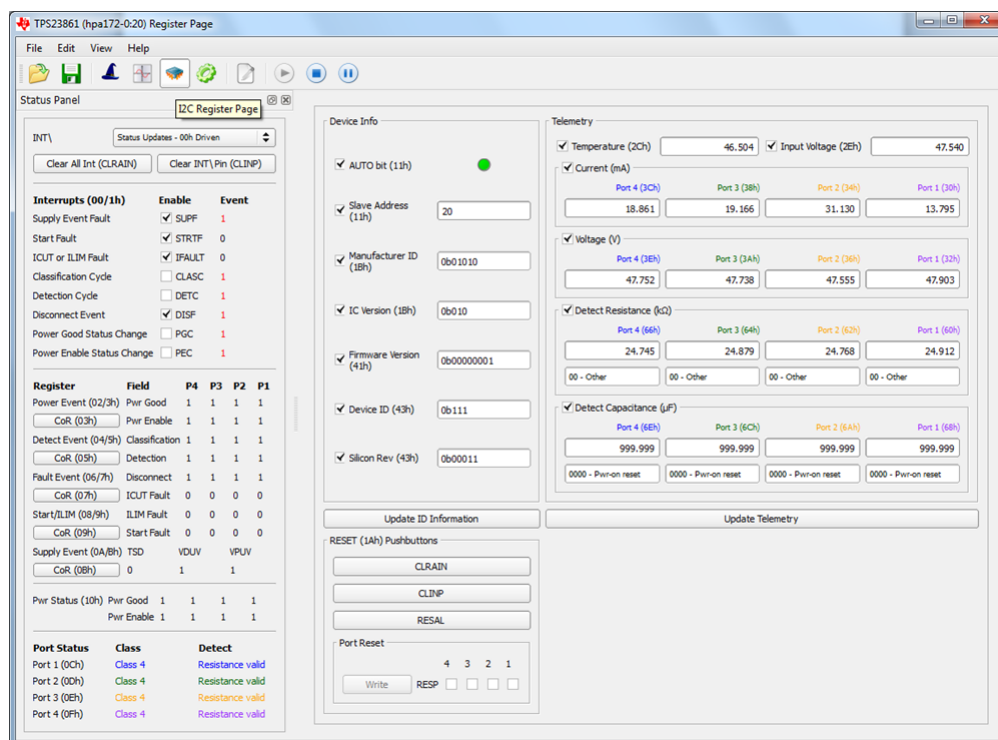

Figure 14. I2C Register Page

The Device Configuration Page provides users with an additional level of access.

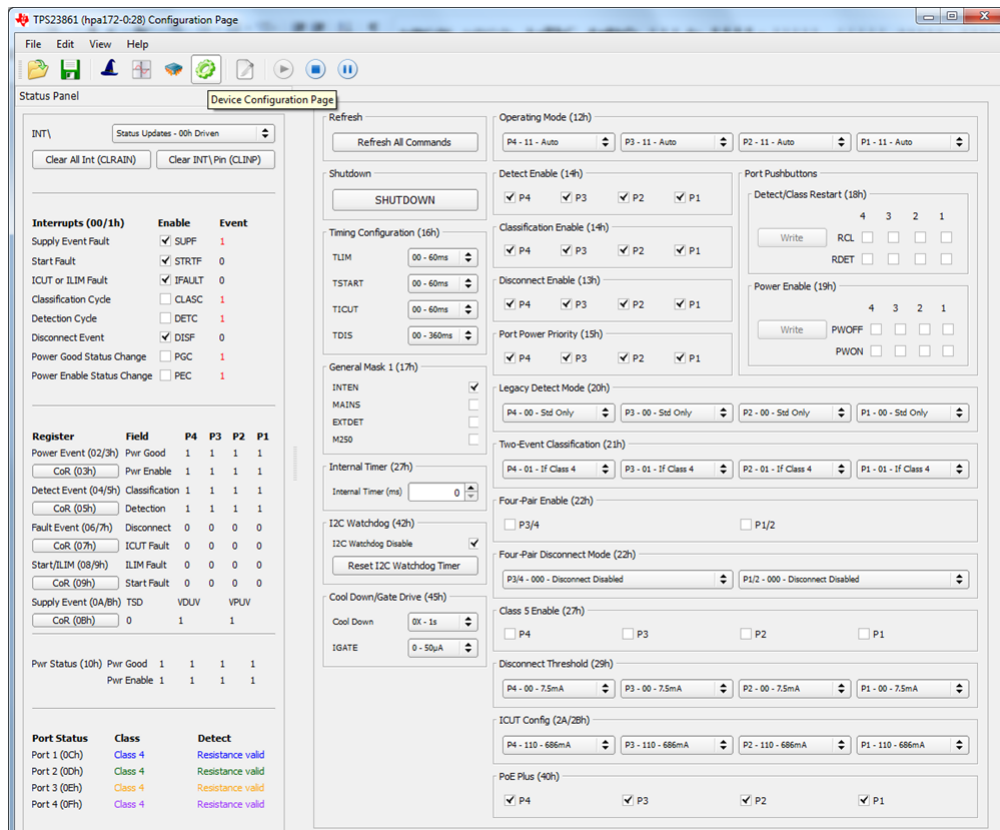

Figure 15. Device Configuration Page

The Configuration Wizard provides a quick way to set up ports in semi-auto or manual modes without much knowledge of the device register-specific details.

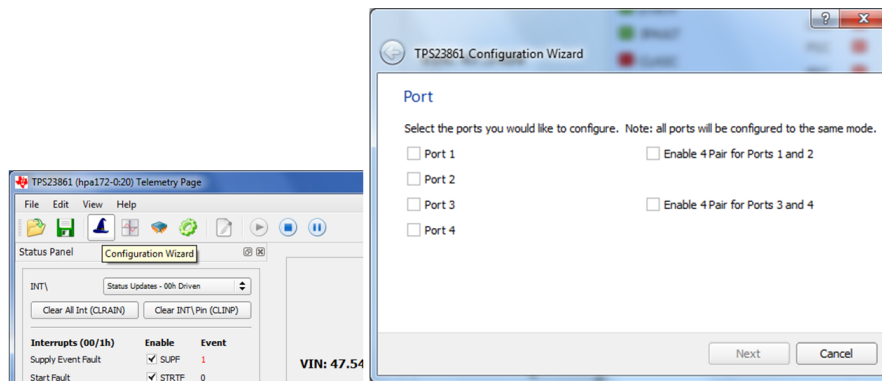

Figure 16. Configuration Wizard

4.3 MSP-EXP430G2 Details

The TPS23861EVM-612 accepts the MSP-EXP430G2 evaluation module when the application requires management of the TPS23861 devices with an external controller. Before inserting the MSP-EXP430G2 into the TPS23861EVM-612, make the following jumper changes and ensure that the target MSP430 (MSP430G2553) device is installed:

1. Remove the shunt on J5 in the P1.6 slot
2. Remove the shunts on J3 in the RXD and TXD slot. Re-install these in the vertical position as described in the MSP-EXP430G2 LaunchPad user guide ([SLAU318C](#), page 10).
3. Install MSP-EXP430G2 onto TPS23861EVM-612 and ensure that the USB-TO-GPIO ribbon cable is NOT installed into J2
4. Connect the PC to the LaunchPad as shown in [Figure 3](#).
5. The source code was developed for the MSP430 LaunchPad Development Kit (MSP-EXP430G2 <http://www.ti.com/tool/msp-exp430g2>) using the Code Composer Studio™ (CCS) version 5.3 (<http://www.ti.com/tool/ccstudio-msp430>) development environment. The target MSP430 can be programmed within this environment.
6. Once CCS is installed, then use the basic set of instructions listed in [Section 4.3.1](#) to import, build, and run the project. CCS version 5.3.0 is used in the following examples. Note that a terminal program such as HyperTerminal or Teraterm is required to view the output from the EVM when it is running.

4.3.1 Basic CCS and Terminal Setup

1. Launch the CCS program on the PC: Start → Texas Instruments → Code Composer Studio 5.3.0 → Code Composer Studio 5.3.0.
2. OK the workspace location and CCS starts
3. Import the project: File → Import Existing CCS Eclipse Project
4. Navigate to the project location, then click the **Finish** button
5. Set the active project: Project, Build Configurations, Set Active, Auto, Manual, or Semi-Auto
6. Build the project by clicking the hammer symbol
7. Launch debug session from CCS to activate the current project: Run, Debug (or F11).
8. Run the active project: Run, Resume (or play button, F8)
9. Determine the PC COM port connected to the LaunchPad by going into the Device Manager Ports (COM and LPT) section. Launch the terminal program.
10. Once the terminal program is properly connected to the LaunchPad running the POE firmware, then text similar to the following image appears

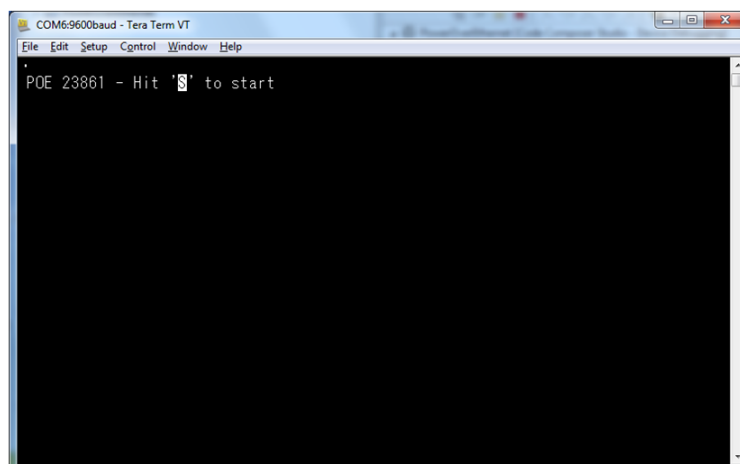

Figure 17. Hit 'S' to Start

- Pressing the “S” key on the keyboard starts the program



Figure 18. Program Started

- The TPS23861EVM-612 is now waiting for a PD load to be installed. As ports are installed, the firmware automatically detects, classifies, and powers up the port as shown in the following image. Port status is updated on the screen approximately every 8 seconds

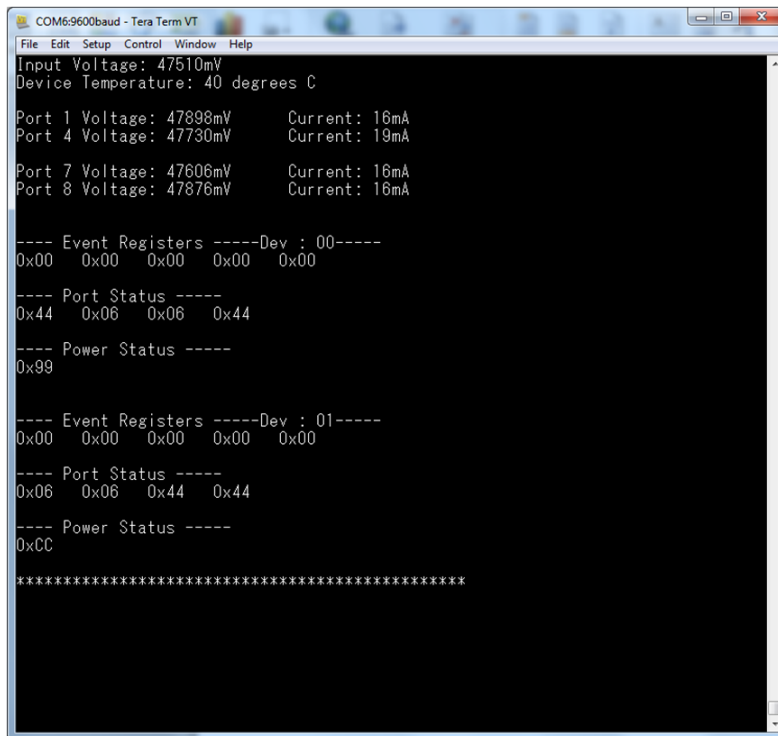

Figure 19. Terminal Response with Connected Ports

- In similar fashion, the builds for Semi-auto and auto mode operation can be configured and launched. The terminal welcome screen indicates which build is running on the LaunchPad.

4.3.2 Documentation

Figure 20 illustrates the documentation contained within the \POE-TPS23861\Document\doxy\html\index.html file.

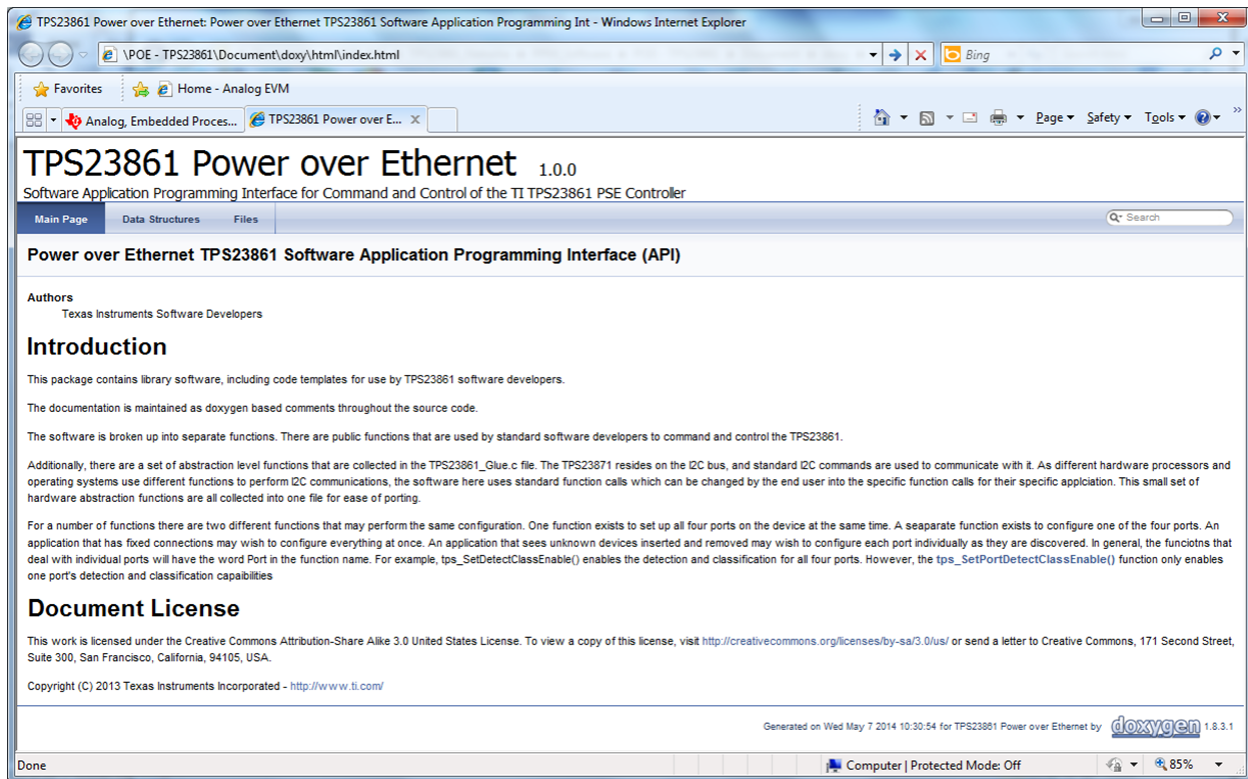

Figure 20. TPS23861 POE Documentation

4.4 MSP430 Reference Code

4.4.1 Overview

There are two versions of *MSP430 reference code* published on TI web. One is for basic applications and the other is focused on multi-port power management applications. The reference code for multi-port power management applications will be discussed in detail since it has more flexibility and complexity.

The system software supports the following features:

- Fully compliant to IEEE802.3at Power over Ethernet specification
- Device detection and classification
- DC disconnect
- Multi-port power management

The reference code can support PSE systems with up to 48 ports. It keeps track of all system level parameters as well as port level parameters for each TPS23861 device within the system.

The main actions are interrupts triggered. As long as MSP430 receives an interrupt signal from TPS23861 devices, it checks the interrupt status and proceeds with related actions.

The system software also keeps track of system and devices error conditions that occur, as well as any events that affect the port states. The MSP430 communicates with PC through UART, reporting port's parameters and status.

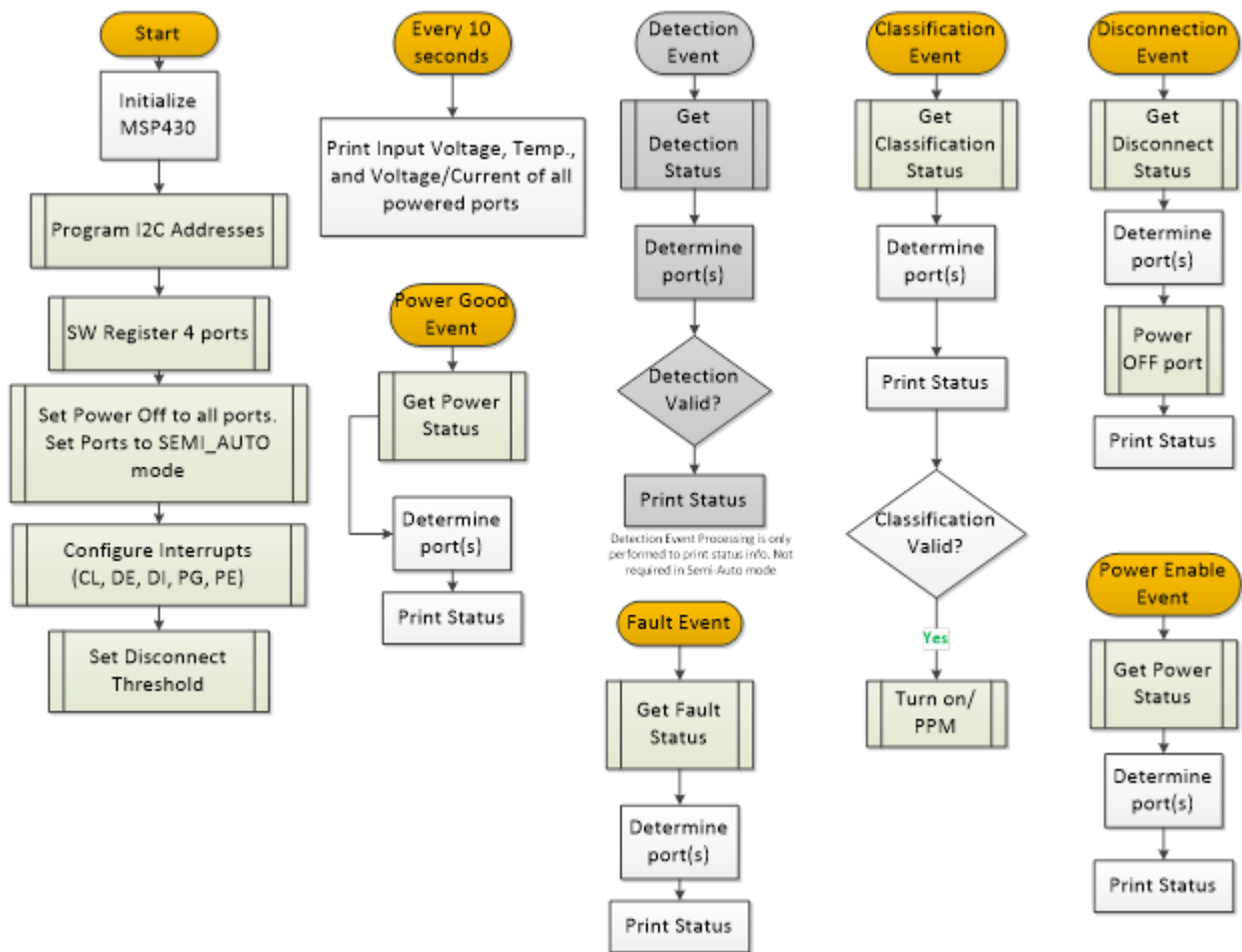

Figure 21. Overall System Software Structure

4.4.2 Multi-Port Power Management Module

Multi-Port Power Management methods are used to manage the distribution and prioritization of PDs. Power Management itself is not defined by the IEEE specification. Instead, it is a policy that takes advantage of the POE specification as it defines such terms as port and system power.

The goals of Multi-Port Power Management in a POE enabled system are two-fold:

- Power as many PDs as possible
- Limit power cycling of PDs

In many systems, the maximum system power available limits the total number of ports that may be powered. For example, each PD can draw a maximum of 30W, and a 48-port system can draw more than 1440W total system power. If the maximum system power available is less than 1440W then Power Management becomes necessary so that the available system power may be used in the most efficient manner while meeting the goals.

In this reference code, Multi-Port Power Management Module is implemented in Semi-Auto Mode reference code (main_semi-auto.c).

4.4.2.1 Definitions and Formulas

Table 6 defines terms used in the Power Management algorithm.

Table 6. Terminology

TERM	DEFINITION
sysPower	The current total power consumed by PDs
portPowerEstimate	The estimated power the current port(finished detection and classification) is going to consume
lowestPrioPort	The lowest priority port among all turned on ports
powerOffPort	Port will be powered off
powerOnPort	Port will be turned on

4.4.2.2 State Definitions

The Power Management algorithm operates as a state machine, whereby the algorithm is a certain state at any given point in time. Table 7 shows the state definitions for the algorithm.

Table 7. State Definitions

STATE	DEFINITION
PM_CHECK	Calculate existing ON ports' total power, get current port estimate power, compare total power + port estimate power and Power budget
PM_POWERUP	Power up current port
PM_OVERLIMIT	Power demand has exceeded the power budget. Calculate whether the remaining power is enough to turn on current port after turning off all lower priority ports
PM_POWERDOWN	Power down the lowest priority port. Entered from PM_OVERLIMIT

4.4.2.3 Function Definitions

The power management function is called after a valid classification is performed. It includes the functions below to implement the algorithm.

Table 8. Function Definitions

FUNCTION	DEFINITION
uint32_t PM_calSysPower(void)	Calculate current total power consumed by PDs
uint8_t PM_getActLowestPrioPort(void)	Find lowest priority port among all turned on ports
uint32_t PM_getPowerofPortsHigherPriority(uint8_t PM_sysPortNumber)	Calculate total power of ports that have the same or higher priority
uint32_t PM_getRequestPower(uint8_t PM_sysPortNumber)	Get estimate power of current port(finished detection and classification) is going to consume based on classification results
void PM_powerManagement(uint8_t PM_sysPortNumber)	Power management function called in main function
void PM_monitorSysPower(void) Note: running in background, software interrupt triggered	Real-time check if current total power consumed by PDs exceeds power budget (to prevent load step change on any ports).

4.4.2.4 User Configurable Parameters

The PPM module gives user some flexibility to configure. [Table 9](#) shows the user configurable parameters.

Table 9. User Configurable Parameters

TERM	DEFINITION	LOCATION
#define PM_EN	Enable PPM feature. Enable=1, disable=0.	power_manage.h
#define PM_POWER_BUDGET	Total system power budget. Unit: mW	power_manage.h
#define NUM_OF_TPS23861	Total number of TPS23861 in the system	system_init.h
#define PM_POWER_MONITOR_TIMER	The timer that host monitor the actual system power	system_init.h
#define PM_DETECT_CLASS_RESTART_TIMER	The timer that host restart detection/ classification of the ports which are turned off	system_init.h
uint8_t i2cAddList[NUM_OF_TPS23861]	I2C address of TPS23861s	system_init.c
TPS238x_On_Off_t autoMode[NUM_OF_TPS23861]	AUTO bit setting of each TPS23861	system_init.c
uint8_t PM_setPriority[NUM_OF_TPS23861 x PM_NUM_OF_PORT]	The port priority setting of each port	system_init.c

4.4.2.5 Design Flow

The Power Management algorithm is shown in [Figure 22](#), in the form of a flow chart.

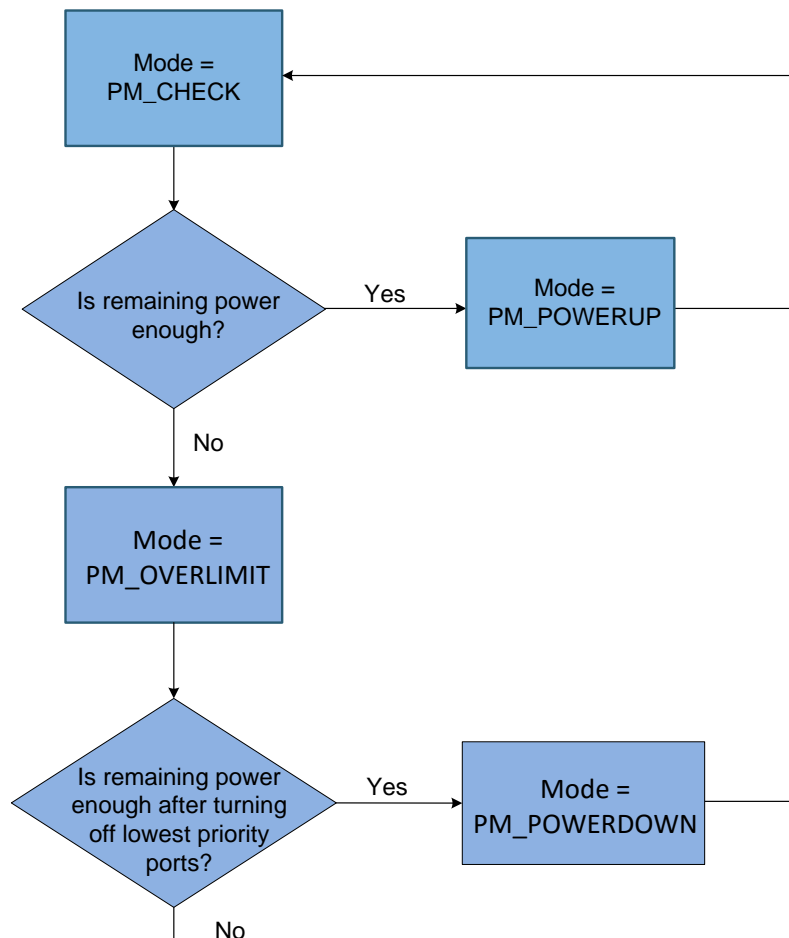

Figure 22. Power on Decision Flow Chart

Real-time system power monitor to protect the system when step change happening on any ports (1s timer triggered):

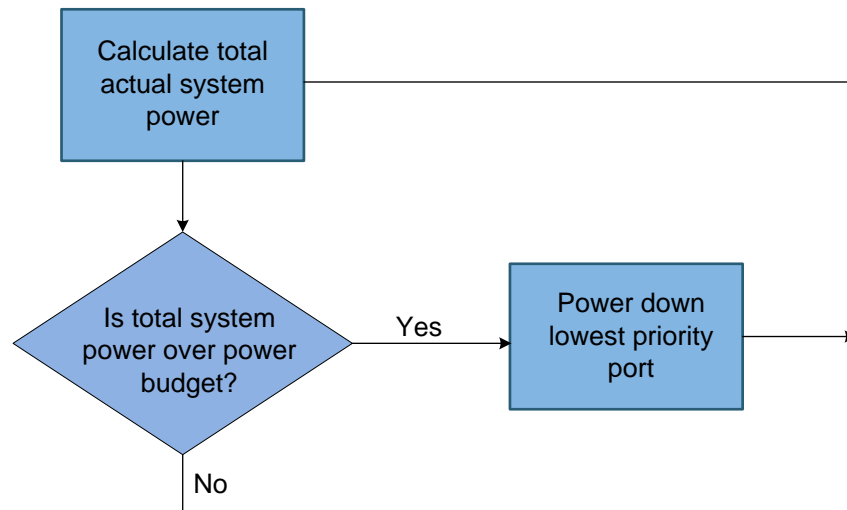

Figure 23. System Power Monitor Flow Chart

4.4.2.6 Pseudo-Code

The Power Management algorithm can also be represented by the following pseudo-code.

```
//This part is inserted after each port's successful classification

if (Mode == Check)
{
  Get RequesPortPower;
  Calculate SystemPower;
  if (systemPower + RequesPortPower > PowerBudget)
  {
    Mode = OverLimit;
  }
  else
  {
    Mode = PowerUP;
  }
}

if (Mode == OverLimit)
{
  //If the remaining power is enough to turn on current port after powering down all ports that
  have lower priority,
  //then turn off the lowest priority port; otherwise, wait for the next cycle
  if (powerofHigherPriorityPorts + RequesPortPower <= PowerBudget)
  {
    Mode = PowerDown;
  }
  else
  {
    Mode = Check
  }
}

if (Mode == PowerDown
{
  Power down the port with lowest priority;
  Restart port's detection/classification;
  Mode = Check;
}

if (Mode == PowerUp)
{
  Power on the port which is requesting power;
  Mode = Update;
}

//This part is inserted in a timer (every 1s or 2s) intrerrupt

if (system power > PowerBudget)
{
  Turn off the port with lowest priority;
  Restart port's detection/classification;
}
}
```

5 EVM Schematic, Layout Guidelines and PCB Assembly, Layer Plots

This section contains the TPS23861EVM-612 schematic, layout guidelines, and printed-circuit board (PCB) assembly and layer plots.

5.1 Schematic

Figure 24 through Figure 26 illustrate the TPS23861EVM-613 schematics.

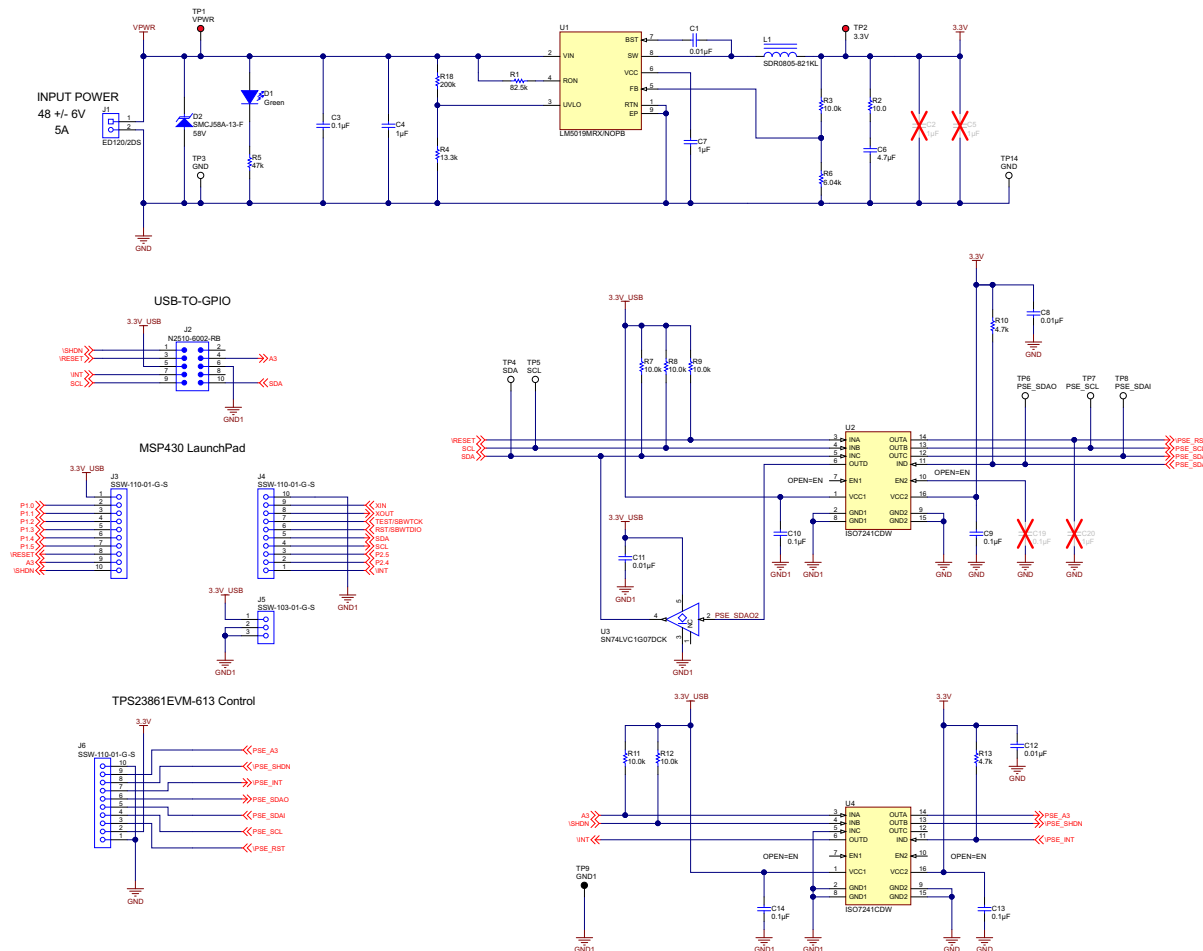

Figure 24. TPS23861EVM-612 (Motherboard) Schematic: Control

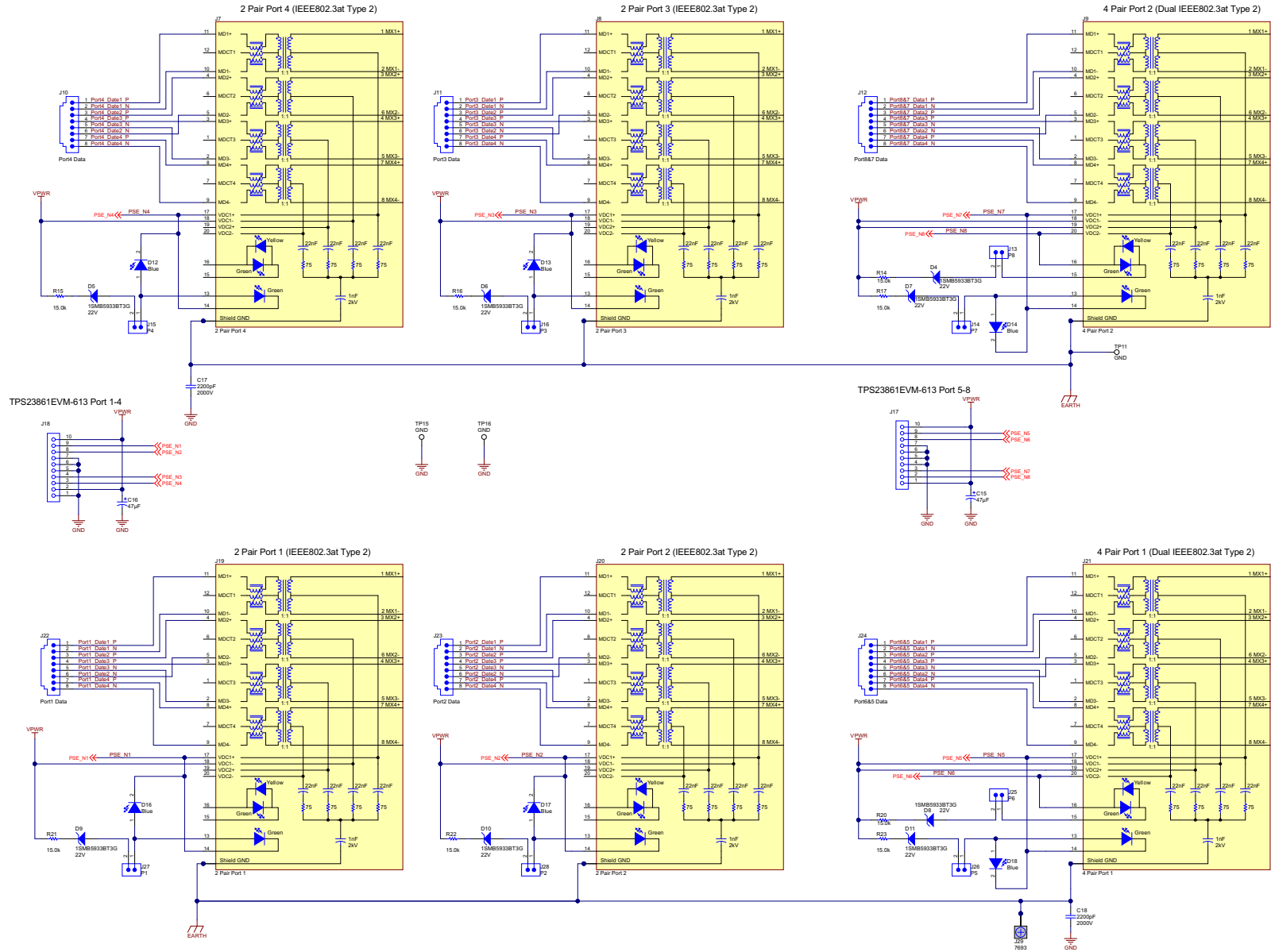

Figure 25. TPS23861EVM-612 (Motherboard) Schematic: Power Ports

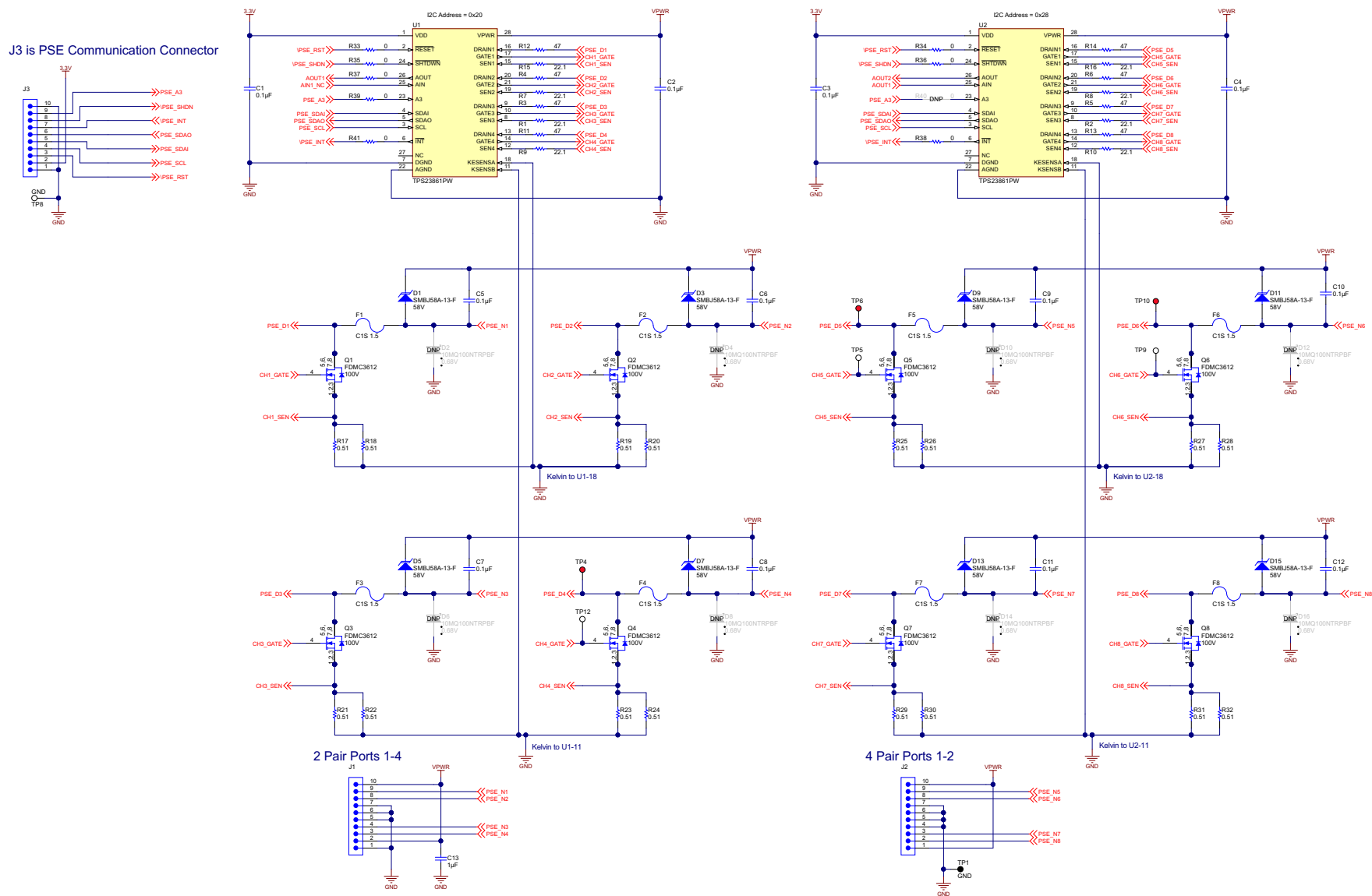

Figure 26. TPS23861EVM-613 (Daughterboard) Schematic

5.2 Layout Guidelines

5.2.1 Supply Voltage Decoupling

Provide power supply pin bypass to the TPS23861 device as follows:

- 0.1 μ F, 100 V, X7R ceramic at pin 28 (VPWR)
- 0.1 μ F, 50 V, X7R ceramic at pin 1 (VDD)

5.2.2 Port Current Kelvin Sensing

KSENSA is shared between SEN1 and SEN2, while KSENSB is shared between SEN3 and SEN4. In order to optimize the accuracy of the measurement, the PCB layout must be done carefully to minimize the impact of PCB trace resistance. Refer to [Figure 33](#) as an example.

5.2.3 Ground Plane Spacing and Isolation (GND, GND1, and EARTH nets)

Appropriate spacing should be provided between the GND, GND1, and EARTH nets as shown in [Figure 29](#).

5.3 PCB Drawings

[Figure 27](#) through [Figure 35](#) show the PCB layouts and assemblies for this EVM.

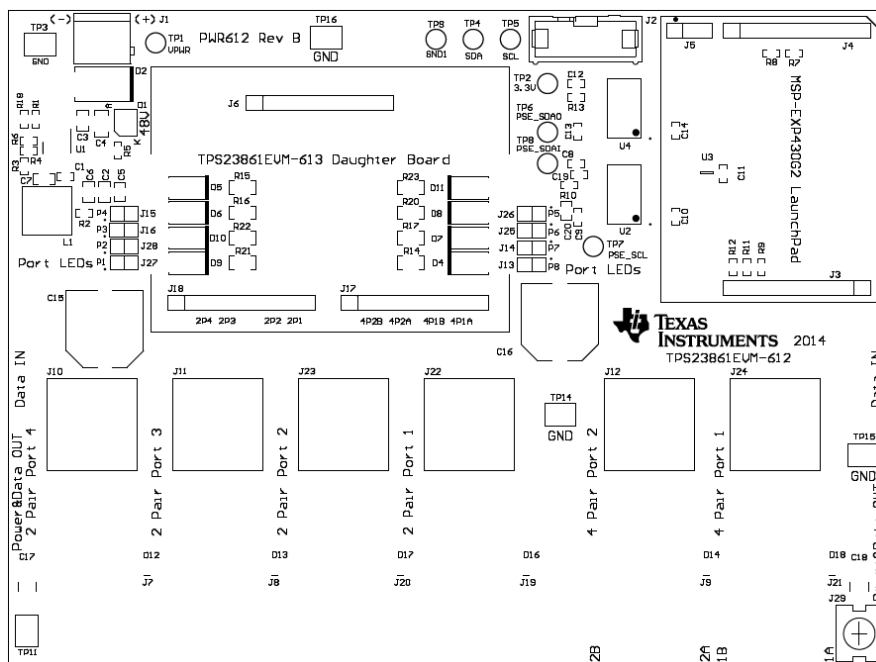

Figure 27. TPS23861EVM-612 (Motherboard) Top Side Assembly

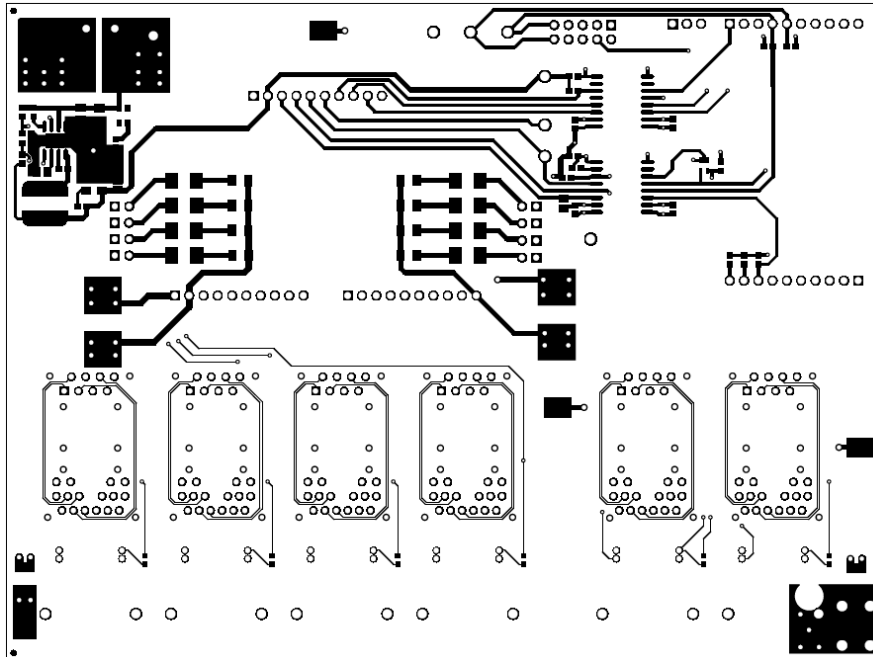

Figure 28. TPS23861EVM-612 (Motherboard) Top Side Routing

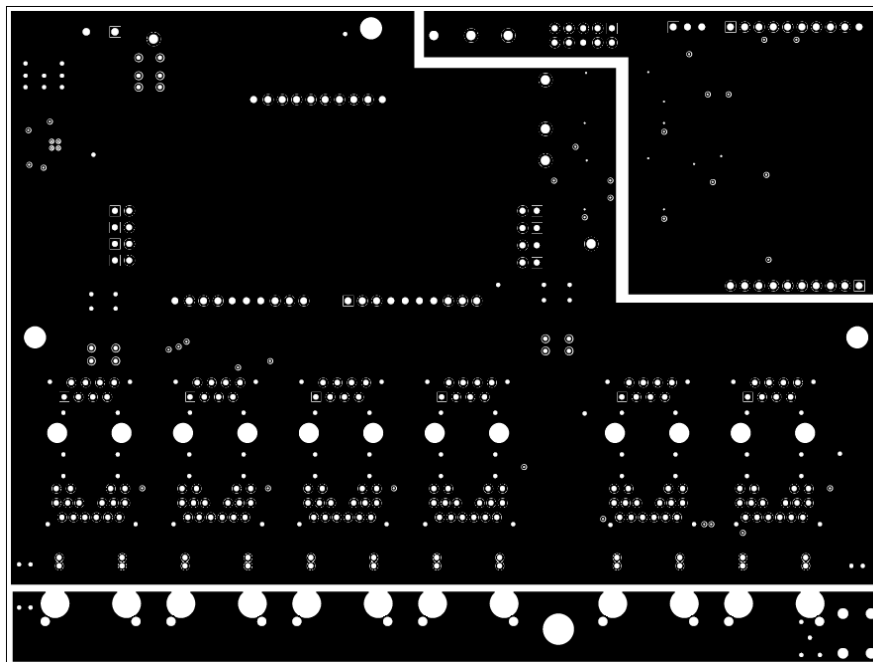

Figure 29. TPS23861EVM-612 (Motherboard) Layer 2 Routing

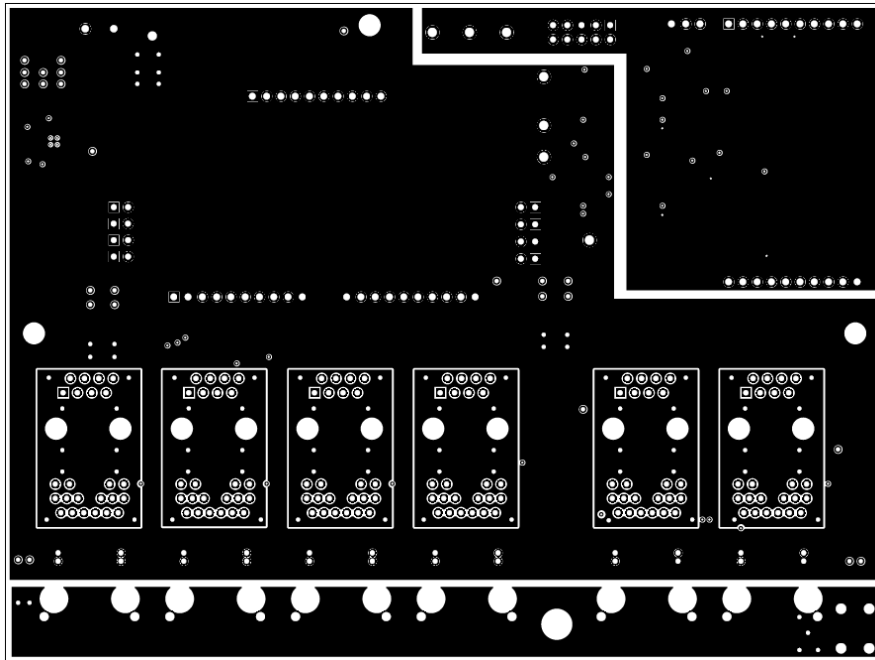

Figure 30. TPS23861EVM-612 (Motherboard) Layer 3 Routing

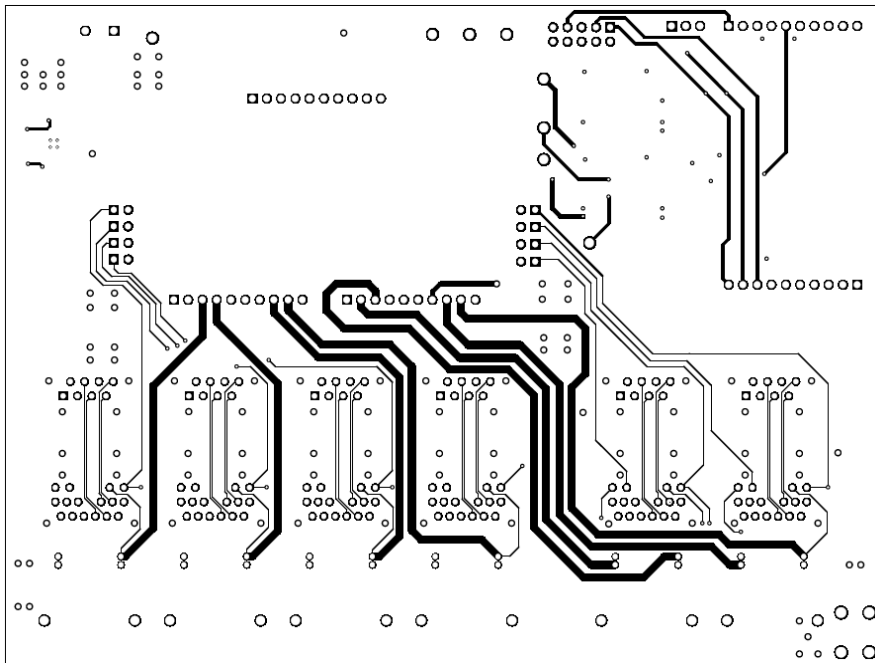

Figure 31. TPS23861EVM-612 (Motherboard) Bottom Side Routing

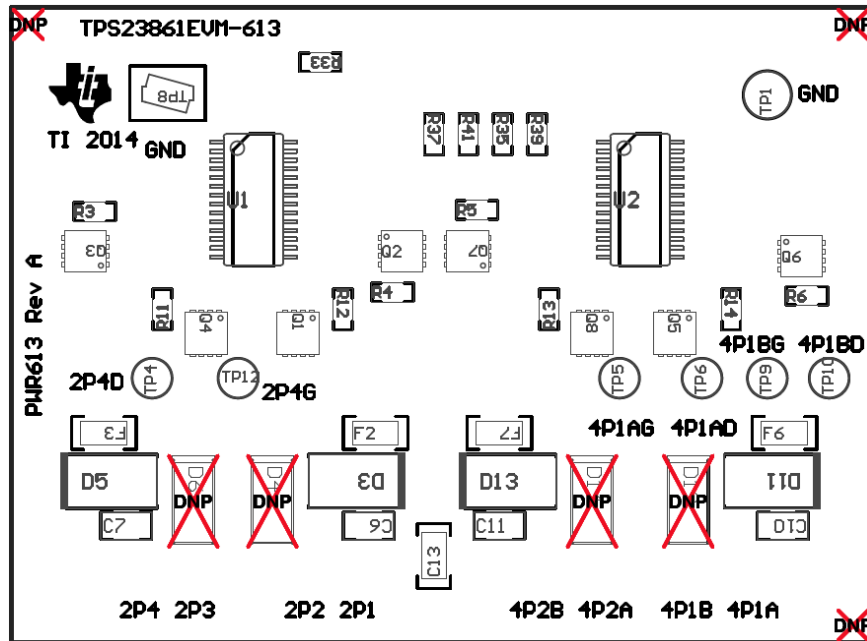

Figure 32. TPS23861EVM-613 (Daughterboard) Top Side Assembly

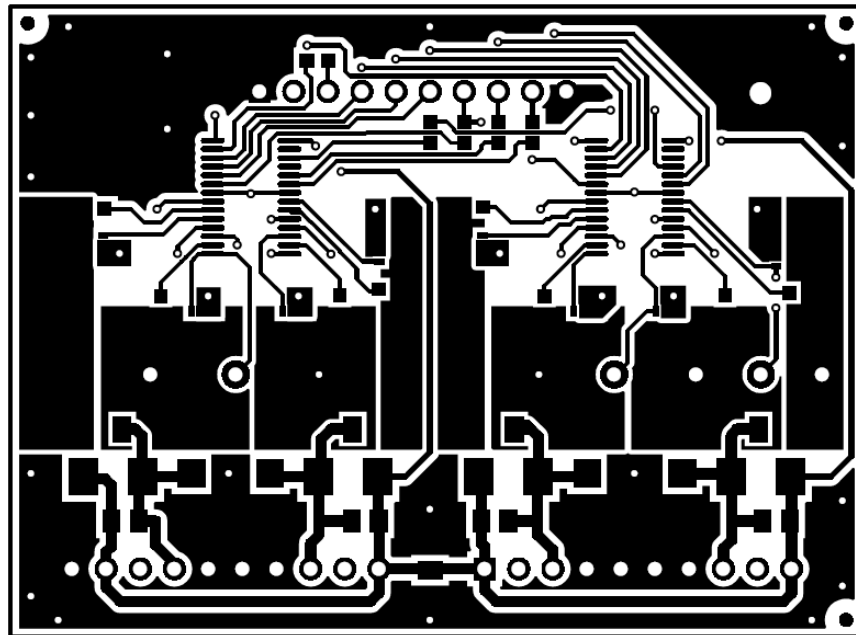

Figure 33. TPS23861EVM-613 (Daughterboard) Top Side Routing

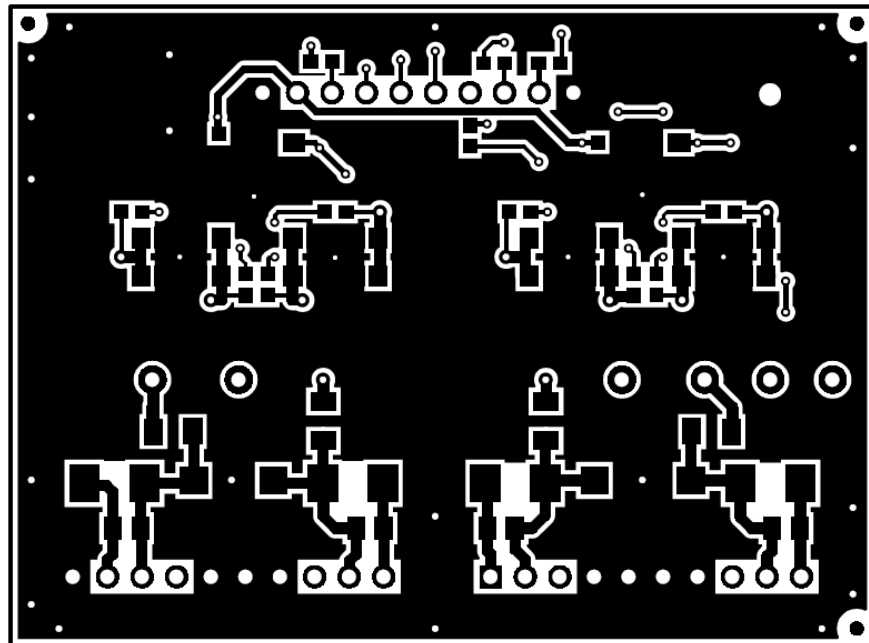

Figure 34. TPS23861EVM-613 (Daughterboard) Bottom Side Routing

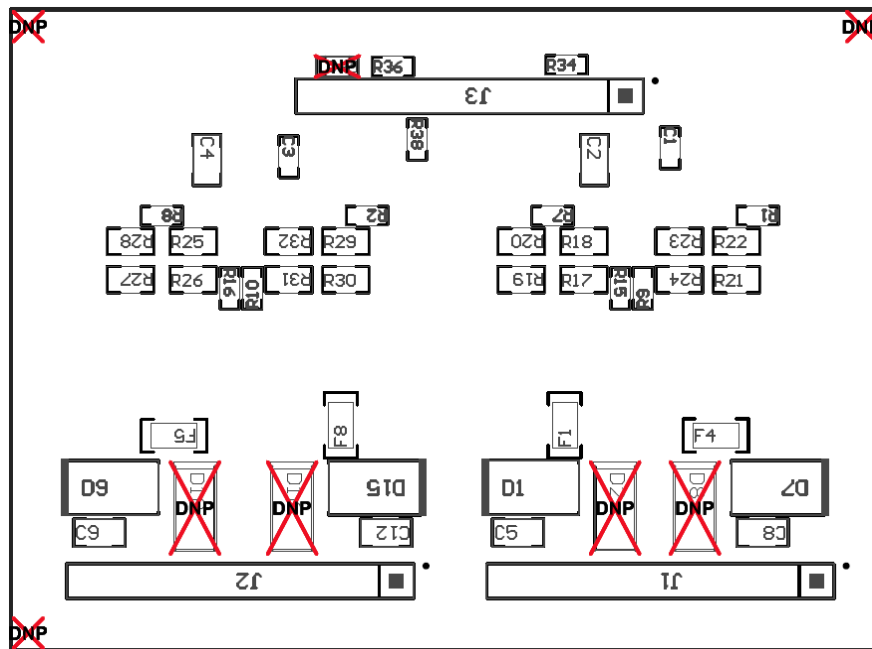

Figure 35. TPS23861EVM-613 (Daughterboard) Bottom Side Assembly

6 Bill of Materials

The BOMs for the TPS23861EVM-612 and TPS23861EVM-613 are listed in [Table 10](#) and [Table 11](#), respectively.

Table 10. TPS23861EVM-612 Bill of Materials⁽¹⁾

Designator	Qty	Value	Description	Package Reference	PartNumber	MFR	Alternate Part Number	Alternate MFR
IPCB	1		Printed Circuit Board		PWR612	Any		
C1, C8, C11, C12	4	0.01uF	CAP, CERM, 0.01uF, 100V, +/-10%, X7R, 0603	0603	06031C103KAT2A	AVX		
C3	1	0.1uF	CAP, CERM, 0.1uF, 100V, +/-10%, X7R, 0805	0805	C2012X7R2A104K	TDK		
C4	1	1uF	CAP, CERM, 1uF, 100V, +/-10%, X7R, 1206	1206	GRM31CR72A105KA01L	MuRata		
C6	1	4.7uF	CAP, CERM, 4.7 uF, 10 V, +/- 10%, X5R, 0805	0805	C0805C475K8PACTU	Kemet		
C7	1	1uF	CAP, CERM, 1uF, 10V, +/-10%, X7R, 0805	0805	0805ZC105KAT2A	AVX		
C9, C10, C13, C14	4	0.1uF	CAP, CERM, 0.1uF, 50V, +/-10%, X7R, 0603	0603	06035C104KAT2A	AVX		
C15, C16	2	47uF	CAP, AL, 47uF, 100V, +/-20%, 0.32 ohm, SMD	SMT Radial H13	EEV-FK2A470Q	Panasonic		
C17, C18	2	2200pF	CAP, CERM, 2200pF, 2000V, +/-10%, X7R, 1812	1812	C4532X7R3D222K	TDK		
D1	1	Green	LED, Green, SMD	Power TOPLED w/lens	LT E63C-CADB-35-L-Z	OSRAM		
D2	1	58V	Diode, TVS, Uni, 58V, 1500W, SMC	SMC	SMCJ58A-13-F	Diodes Inc.		
D4, D5, D6, D7, D8, D9, D10, D11	8	22V	Diode, Zener, 22V, 550mW, SMB	SMB	1SMB5933BT3G	ON Semiconductor		
D12, D13, D14, D16, D17, D18	6	Blue	LED, Blue, SMD	BLUE 0603 LED	LB Q39G-L2N2-35-1	OSRAM		
H1, H2, H3, H4, H5, H6, H7, H8, H9	9		Bumpon, Cylindrical, 0.312 X 0.200, Black	Black Bumpon	SJ61A1	3M		
J1	1		TERMINAL BLOCK 5.08MM VERT 2POS	TERM_BLK, 2pos, 5.08mm	ED120/2DS	On-Shore Technology, Inc.		
J2	1		Header (shrouded), 100mil, 5x2, High-Temperature, Gold, TH	5x2 Shrouded header	N2510-6002-RB	3M		
J3, J4, J6, J17, J18	5		Connector, Receptacle, 100mil, 10x1, Gold plated, TH	HEADER, RECEPTACLE, 100mil, 10x1	SSW-110-01-G-S	Samtec, Inc.		
J5	1		Receptacle 100mil 3x1, Gold, TH	Receptacle, 100mil, 3x1	SSW-103-01-G-S	Samtec, Inc.		
J7, J8, J9, J19, J20, J21	6		RJ-45 with integrated magnetics	RJ-45 Jack	JK0-0177NL	Pulse Engineering	7499511611 or 7499511611A	Würth Elektronik
J10, J11, J12, J22, J23, J24	6		RJ-45, Vertical, TH	RJ-45 Jack, 8Pos Right Angle	SS-7188V-A-NF	Stewart Connector		
J13, J14, J15, J16, J25, J26, J27, J28	8		Header, TH, 100mil, 2x1, Gold plated, 230 mil above insulator	TSW-102-07-G-S	TSW-102-07-G-S	Samtec, Inc.		
J29	1	15A	Terminal screw, vertical, snap-in	7693	7693	Keystone		
L1	1	820uH	Inductor, Drum Core, Ferrite, 820 uH, 0.23 A, 4 ohm, SMD	SDR0805	SDR0805-821KL	Bourns		
R1	1	82.5k	RES, 82.5 k, 1%, 0.1 W, 0603	0603	CRCW060382K5FKEA	Vishay-Dale		
R2	1	10.0	RES, 10.0, 1%, 0.1 W, 0603	0603	CRCW060310R0FKEA	Vishay-Dale		
R3, R7, R8, R9, R11, R12	6	10.0k	RES, 10.0k ohm, 1%, 0.1W, 0603	0603	CRCW060310K0FKEA	Vishay-Dale		
R4	1	13.3k	RES, 13.3k ohm, 1%, 0.1W, 0603	0603	CRCW060313K3FKEA	Vishay-Dale		
R5	1	47k	RES, 47k ohm, 5%, 0.1W, 0603	0603	CRCW060347K0JNEA	Vishay-Dale		

⁽¹⁾ Unless otherwise noted in the Alternate Part Number and/or Alternate Manufacturer columns, all parts may be substituted with equivalents.

Table 10. TPS23861EVM-612 Bill of Materials⁽¹⁾ (continued)

Designator	Qty	Value	Description	Package Reference	PartNumber	MFR	Alternate Part Number	Alternate MFR
R6	1	6.04k	RES, 6.04k ohm, 1%, 0.1W, 0603	0603	CRCW06036K04FKEA	Vishay-Dale		
R10, R13	2	4.7k	RES, 4.7k ohm, 5%, 0.1W, 0603	0603	CRCW06034K70JNEA	Vishay-Dale		
R14, R15, R16, R17, R20, R21, R22, R23	8	7.50k	RES, 7.50k ohm, 1%, 0.25W, 1206	1206	CRCW12067K50FKEA	Vishay-Dale		
R18	1	200k	RES, 200k ohm, 1%, 0.1W, 0603	0603	CRCW0603200KFKEA	Vishay-Dale		
SH-J1, SH-J2, SH-J3, SH-J4, SH-J5, SH-J6, SH-J7, SH-J8	8	1x2	Shunt, 100mil, Flash Gold, Black	Closed Top 100mil Shunt	SPC02SYAN	Sullins Connector Solutions		
TP1, TP2	2	Red	Test Point, Multipurpose, Red, TH	Keystone5010	5010	Keystone		
TP3, TP11, TP14, TP15, TP16	5	SMT	Test Point, Compact, SMT	Testpoint_Keystone_Compact	5016	Keystone		
TP4, TP5, TP6, TP7, TP8	5	White	Test Point, Multipurpose, White, TH	Keystone5012	5012	Keystone		
TP9	1	Black	Test Point, Multipurpose, Black, TH	Keystone5011	5011	Keystone		
U1	1		100V, 100mA Constant On-Time Synchronous Buck Regulator, DDA0008B	DDA0008B	LM5019MRX/NOPB	Texas Instruments	LM5019MR/NOPB	Texas Instruments
U2, U4	2		25 Mbps Quad Channels, 3 / 1, Digital Isolator, 3.3 V / 5 V, -40 to +125 degC, 16-pin SOIC (DW), Green (RoHS & no Sb/Br)	DW0016A	ISO7241CDW	Texas Instruments	Equivalent	None
U3	1		SINGLE BUFFER/DRIVER WITH OPEN-DRAIN OUTPUT, DCK0005A	DCK0005A	SN74LVC1G07DCK	Texas Instruments		None
PWR613	1		TPS23861EVM-613 Daughter Board	PWR613	PWR613	Texas Instruments		
C2, C5, C20	0	1uF	CAP, CERM, 1uF, 10V, +/-10%, X7R, 0805	0805	0805ZC105KAT2A	AVX		
C19	0	0.1uF	CAP, CERM, 0.1uF, 50V, +/-10%, X7R, 0603	0603	06035C104KAT2A	AVX		
H10, H11, H12, H13	0		Standoff, Hex, 1"L #6-32 Nylon, M-F	1" Nylon Hex Standoff	4820	Keystone		

Table 11. TPS23861EVM-613 Bill of Materials

QTY	RefDes	Value	Description	Size	Part Number	MFR
2	C1, C3	0.1uF	CAP, CERM, 0.1uF, 50V, +/-10%, X7R, 0603	0603	06035C104KAT2A	AVX
10	C2, C4, C5, C6, C7, C8, C9, C10, C11, C12	0.1uF	CAP, CERM, 0.1uF, 100V, +/-10%, X7R, 0805	0805	C2012X7R2A104K	TDK
1	C13	1uF	CAP, CERM, 1uF, 100V, +/-10%, X7R, 1206	1206	GRM31CR72A105KA01L	MuRata
8	D1, D3, D5, D7, D9, D11, D13, D15	58V	Diode, TVS, Uni, 58V, 600W, SMB	SMB	SMBJ58A-13-F	Diodes Inc.
8	F1, F2, F3, F4, F5, F6, F7, F8		Fuse, 1.5A, 63V, SMD	1206	C1S 1.5	Bel Fuse
3	J1, J2, J3		Header, TH, 100mil, 10x1, Gold plated, 230 mil above insulator	TSW-110-07-G-S	TSW-110-07-G-S	Samtec, Inc.
8	Q1, Q2, Q3, Q4, Q5, Q6, Q7, Q8	100V	MOSFET, N-CH, 100V, 3.3A, 3.3x1x3.3mm	3.3x1x3.3mm	FDMC3612	Fairchild Semiconductor
8	R1, R2, R7, R8, R9, R10, R15, R16	22.1	RES, 22.1 ohm, 1%, 0.1W, 0603	0603	CRCW060322R1FKEA	Vishay-Dale
8	R3, R4, R5, R6, R11, R12, R13, R14	47	RES, 47 ohm, 5%, 0.1W, 0603	0603	CRCW060347R0JNEA	Vishay-Dale
16	R17, R18, R19, R20, R21, R22, R23, R24, R25, R26, R27, R28, R29, R30, R31, R32	0.51	RES, 0.51 ohm, 1%, 0.25W, 0805	0805	CRM0805-FX-R510ELF	Bourns
8	R33, R34, R35, R36, R37, R38, R39, R41	0	RES, 0 ohm, 5%, 0.1W, 0603	0603	CRCW06030000Z0EA	Vishay-Dale
1	TP1	Black	Test Point, Multipurpose, Black, TH	Keystone5011	5011	Keystone
3	TP4, TP6, TP10	Red	Test Point, Miniature, Red, TH	Keystone5000	5000	Keystone
3	TP5, TP9, TP12	White	Test Point, Miniature, White, TH	Keystone5002	5002	Keystone

Table 11. TPS23861EVM-613 Bill of Materials (continued)

QTY	RefDes	Value	Description	Size	Part Number	MFR
1	TP8	SMT	Test Point, Compact, SMT	Testpoint_Keystone_Compact	5016	Keystone
2	U1, U2		QUAD IEEE 802.3at POWER-OVER-ETHERNET PSE CONTROLLER, PW0028A	PW0028A	TPS23861PW	Texas Instruments

Revision A Schematic

A.1

Figure 36 illustrates the revision A, TPS23861EVM-612 (Motherboard) schematic.

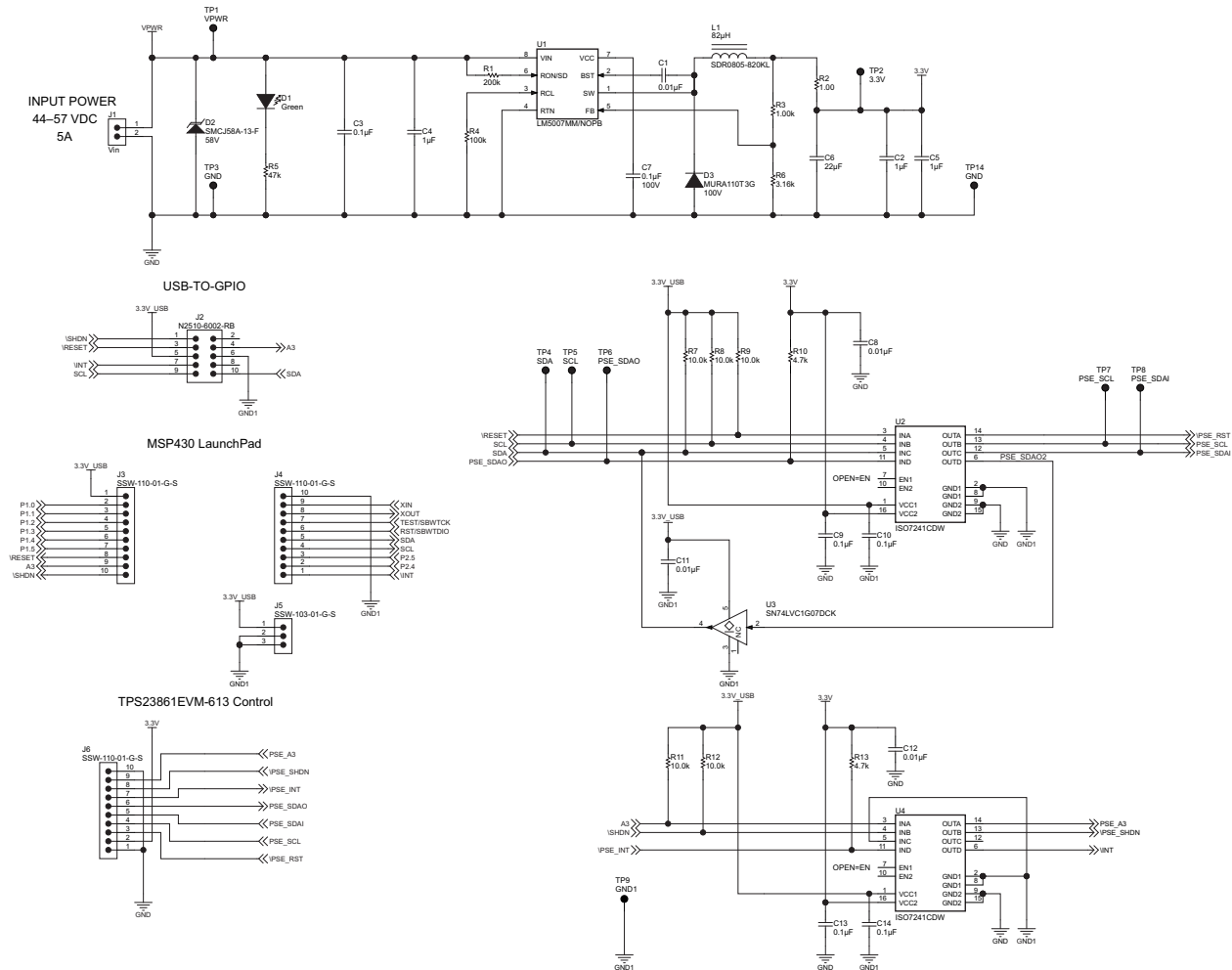

Figure 36. TPS23861EVM-612 (Motherboard) Schematic: Control

Revision History

Changes from Original (March 2014) to A Revision	Page
• Added bullet 4 to the <i>Features</i>	3
• Changed 48-VDC to just DC, globally.	3
• Added a paragraph to the end of the <i>Input Power</i> subsection.	3
• Changed third sentence in <i>Input Power (Labeled VPWR)</i> to a Caution.	3
• Changed last paragraph in <i>Input Power (Labeled VPWR)</i>	3
• Added current consumption information to the end of the <i>Local 3.3 V (Labeled 3.3V)</i> subsection.....	3
• Changed sentence to a Caution in <i>External 3.3 V (Labeled 3.3V_USB)</i>	4
• Changed content of first paragraph of <i>Basic Test Setup (Out-of-the-box Auto-Mode Operation)</i>	5
• Added <i>TPS23861EVM-612 PI Commander GUI Setup</i> section.	10

Revision History

Changes from A Revision (June 2014) to B Revision	Page
• Changed name on pin 18 to KSENSA on the daughterboard schematic.	28

Revision History

NOTE: Page numbers for previous revisions may differ from page numbers in the current version.

Changes from B Revision (June 2014) to C Revision	Page
• Changed text in <i>Local 3.3 V (Labeled 3.3V)</i> section and changed part number.	3
• Added table note on <i>EVM Jumpers</i> table and changed labels column from P0–P7 to P1–P8.	9
• Changed path for PI Commander start instructions.	10
• Changed <i>TPS23861EVM-612 (Motherboard) Schematic: Control</i> to Rev. B.	26
• Changed PCB Motherboard images, figures 24–28.....	29
• Changed BOM for PWR612B revision.	34
• Added appendix C.	37

Revision History

Changes from C Revision (November 2015) to D Revision	Page
• Added section <i>MSP430 Reference Code</i>	20

Revision History

Changes from D Revision (November 2016) to E Revision	Page
• Replaced Figure 24	26
• Replaced Figure 25	27
• Replaced Figure 26	28

STANDARD TERMS FOR EVALUATION MODULES

1. *Delivery:* TI delivers TI evaluation boards, kits, or modules, including any accompanying demonstration software, components, and/or documentation which may be provided together or separately (collectively, an "EVM" or "EVMs") to the User ("User") in accordance with the terms set forth herein. User's acceptance of the EVM is expressly subject to the following terms.
 - 1.1 EVMs are intended solely for product or software developers for use in a research and development setting to facilitate feasibility evaluation, experimentation, or scientific analysis of TI semiconductor products. EVMs have no direct function and are not finished products. EVMs shall not be directly or indirectly assembled as a part or subassembly in any finished product. For clarification, any software or software tools provided with the EVM ("Software") shall not be subject to the terms and conditions set forth herein but rather shall be subject to the applicable terms that accompany such Software
 - 1.2 EVMs are not intended for consumer or household use. EVMs may not be sold, sublicensed, leased, rented, loaned, assigned, or otherwise distributed for commercial purposes by Users, in whole or in part, or used in any finished product or production system.
2. *Limited Warranty and Related Remedies/Disclaimers:*
 - 2.1 These terms do not apply to Software. The warranty, if any, for Software is covered in the applicable Software License Agreement.
 - 2.2 TI warrants that the TI EVM will conform to TI's published specifications for ninety (90) days after the date TI delivers such EVM to User. Notwithstanding the foregoing, TI shall not be liable for a nonconforming EVM if (a) the nonconformity was caused by neglect, misuse or mistreatment by an entity other than TI, including improper installation or testing, or for any EVMs that have been altered or modified in any way by an entity other than TI, (b) the nonconformity resulted from User's design, specifications or instructions for such EVMs or improper system design, or (c) User has not paid on time. Testing and other quality control techniques are used to the extent TI deems necessary. TI does not test all parameters of each EVM. User's claims against TI under this Section 2 are void if User fails to notify TI of any apparent defects in the EVMs within ten (10) business days after delivery, or of any hidden defects with ten (10) business days after the defect has been detected.
 - 2.3 TI's sole liability shall be at its option to repair or replace EVMs that fail to conform to the warranty set forth above, or credit User's account for such EVM. TI's liability under this warranty shall be limited to EVMs that are returned during the warranty period to the address designated by TI and that are determined by TI not to conform to such warranty. If TI elects to repair or replace such EVM, TI shall have a reasonable time to repair such EVM or provide replacements. Repaired EVMs shall be warranted for the remainder of the original warranty period. Replaced EVMs shall be warranted for a new full ninety (90) day warranty period.
3. *Regulatory Notices:*
 - 3.1 *United States*
 - 3.1.1 *Notice applicable to EVMs not FCC-Approved:*

FCC NOTICE: This kit is designed to allow product developers to evaluate electronic components, circuitry, or software associated with the kit to determine whether to incorporate such items in a finished product and software developers to write software applications for use with the end product. This kit is not a finished product and when assembled may not be resold or otherwise marketed unless all required FCC equipment authorizations are first obtained. Operation is subject to the condition that this product not cause harmful interference to licensed radio stations and that this product accept harmful interference. Unless the assembled kit is designed to operate under part 15, part 18 or part 95 of this chapter, the operator of the kit must operate under the authority of an FCC license holder or must secure an experimental authorization under part 5 of this chapter.
 - 3.1.2 *For EVMs annotated as FCC – FEDERAL COMMUNICATIONS COMMISSION Part 15 Compliant:*

CAUTION

This device complies with part 15 of the FCC Rules. Operation is subject to the following two conditions: (1) This device may not cause harmful interference, and (2) this device must accept any interference received, including interference that may cause undesired operation.

Changes or modifications not expressly approved by the party responsible for compliance could void the user's authority to operate the equipment.

FCC Interference Statement for Class A EVM devices

NOTE: This equipment has been tested and found to comply with the limits for a Class A digital device, pursuant to part 15 of the FCC Rules. These limits are designed to provide reasonable protection against harmful interference when the equipment is operated in a commercial environment. This equipment generates, uses, and can radiate radio frequency energy and, if not installed and used in accordance with the instruction manual, may cause harmful interference to radio communications. Operation of this equipment in a residential area is likely to cause harmful interference in which case the user will be required to correct the interference at his own expense.

FCC Interference Statement for Class B EVM devices

NOTE: This equipment has been tested and found to comply with the limits for a Class B digital device, pursuant to part 15 of the FCC Rules. These limits are designed to provide reasonable protection against harmful interference in a residential installation. This equipment generates, uses and can radiate radio frequency energy and, if not installed and used in accordance with the instructions, may cause harmful interference to radio communications. However, there is no guarantee that interference will not occur in a particular installation. If this equipment does cause harmful interference to radio or television reception, which can be determined by turning the equipment off and on, the user is encouraged to try to correct the interference by one or more of the following measures:

- Reorient or relocate the receiving antenna.
- Increase the separation between the equipment and receiver.
- Connect the equipment into an outlet on a circuit different from that to which the receiver is connected.
- Consult the dealer or an experienced radio/TV technician for help.

3.2 Canada

3.2.1 For EVMs issued with an Industry Canada Certificate of Conformance to RSS-210 or RSS-247

Concerning EVMs Including Radio Transmitters:

This device complies with Industry Canada license-exempt RSSs. Operation is subject to the following two conditions:

(1) this device may not cause interference, and (2) this device must accept any interference, including interference that may cause undesired operation of the device.

Concernant les EVMs avec appareils radio:

Le présent appareil est conforme aux CNR d'Industrie Canada applicables aux appareils radio exempts de licence. L'exploitation est autorisée aux deux conditions suivantes: (1) l'appareil ne doit pas produire de brouillage, et (2) l'utilisateur de l'appareil doit accepter tout brouillage radioélectrique subi, même si le brouillage est susceptible d'en compromettre le fonctionnement.

Concerning EVMs Including Detachable Antennas:

Under Industry Canada regulations, this radio transmitter may only operate using an antenna of a type and maximum (or lesser) gain approved for the transmitter by Industry Canada. To reduce potential radio interference to other users, the antenna type and its gain should be so chosen that the equivalent isotropically radiated power (e.i.r.p.) is not more than that necessary for successful communication. This radio transmitter has been approved by Industry Canada to operate with the antenna types listed in the user guide with the maximum permissible gain and required antenna impedance for each antenna type indicated. Antenna types not included in this list, having a gain greater than the maximum gain indicated for that type, are strictly prohibited for use with this device.

Concernant les EVMs avec antennes détachables

Conformément à la réglementation d'Industrie Canada, le présent émetteur radio peut fonctionner avec une antenne d'un type et d'un gain maximal (ou inférieur) approuvé pour l'émetteur par Industrie Canada. Dans le but de réduire les risques de brouillage radioélectrique à l'intention des autres utilisateurs, il faut choisir le type d'antenne et son gain de sorte que la puissance isotrope rayonnée équivalente (p.i.r.e.) ne dépasse pas l'intensité nécessaire à l'établissement d'une communication satisfaisante. Le présent émetteur radio a été approuvé par Industrie Canada pour fonctionner avec les types d'antenne énumérés dans le manuel d'usage et ayant un gain admissible maximal et l'impédance requise pour chaque type d'antenne. Les types d'antenne non inclus dans cette liste, ou dont le gain est supérieur au gain maximal indiqué, sont strictement interdits pour l'exploitation de l'émetteur.

3.3 Japan

3.3.1 *Notice for EVMs delivered in Japan:* Please see http://www.tij.co.jp/lstds/ti_ja/general/eStore/notice_01.page 日本国内に輸入される評価用キット、ボードについては、次のところをご覧ください。
http://www.tij.co.jp/lstds/ti_ja/general/eStore/notice_01.page

3.3.2 *Notice for Users of EVMs Considered "Radio Frequency Products" in Japan:* EVMs entering Japan may not be certified by TI as conforming to Technical Regulations of Radio Law of Japan.

If User uses EVMs in Japan, not certified to Technical Regulations of Radio Law of Japan, User is required to follow the instructions set forth by Radio Law of Japan, which includes, but is not limited to, the instructions below with respect to EVMs (which for the avoidance of doubt are stated strictly for convenience and should be verified by User):

1. Use EVMs in a shielded room or any other test facility as defined in the notification #173 issued by Ministry of Internal Affairs and Communications on March 28, 2006, based on Sub-section 1.1 of Article 6 of the Ministry's Rule for Enforcement of Radio Law of Japan,
2. Use EVMs only after User obtains the license of Test Radio Station as provided in Radio Law of Japan with respect to EVMs, or
3. Use of EVMs only after User obtains the Technical Regulations Conformity Certification as provided in Radio Law of Japan with respect to EVMs. Also, do not transfer EVMs, unless User gives the same notice above to the transferee. Please note that if User does not follow the instructions above, User will be subject to penalties of Radio Law of Japan.

【無線電波を送信する製品の開発キットをお使いになる際の注意事項】 開発キットの中には技術基準適合証明を受けていないものがあります。技術適合証明を受けていないものご使用に際しては、電波法遵守のため、以下のいずれかの措置を取っていただく必要がありますのでご注意ください。

1. 電波法施行規則第6条第1項第1号に基づく平成18年3月28日総務省告示第173号で定められた電波暗室等の試験設備でご使用いただく。
2. 実験局の免許を取得後ご使用いただく。
3. 技術基準適合証明を取得後ご使用いただく。

なお、本製品は、上記の「ご使用にあたっての注意」を譲渡先、移転先に通知しない限り、譲渡、移転できないものとします。

上記を遵守頂けない場合は、電波法の罰則が適用される可能性があることをご留意ください。日本テキサス・インスツルメンツ株式会社
東京都新宿区西新宿 6 丁目 2 4 番 1 号
西新宿三井ビル

3.3.3 *Notice for EVMs for Power Line Communication:* Please see http://www.tij.co.jp/llds/ti_ja/general/eStore/notice_02.page
電力線搬送波通信についての開発キットをお使いになる際の注意事項については、次のところをご覧ください。 http://www.tij.co.jp/llds/ti_ja/general/eStore/notice_02.page

3.4 *European Union*

3.4.1 *For EVMs subject to EU Directive 2014/30/EU (Electromagnetic Compatibility Directive):*

This is a class A product intended for use in environments other than domestic environments that are connected to a low-voltage power-supply network that supplies buildings used for domestic purposes. In a domestic environment this product may cause radio interference in which case the user may be required to take adequate measures.

4 *EVM Use Restrictions and Warnings:*

4.1 EVMS ARE NOT FOR USE IN FUNCTIONAL SAFETY AND/OR SAFETY CRITICAL EVALUATIONS, INCLUDING BUT NOT LIMITED TO EVALUATIONS OF LIFE SUPPORT APPLICATIONS.

4.2 User must read and apply the user guide and other available documentation provided by TI regarding the EVM prior to handling or using the EVM, including without limitation any warning or restriction notices. The notices contain important safety information related to, for example, temperatures and voltages.

4.3 *Safety-Related Warnings and Restrictions:*

4.3.1 User shall operate the EVM within TI's recommended specifications and environmental considerations stated in the user guide, other available documentation provided by TI, and any other applicable requirements and employ reasonable and customary safeguards. Exceeding the specified performance ratings and specifications (including but not limited to input and output voltage, current, power, and environmental ranges) for the EVM may cause personal injury or death, or property damage. If there are questions concerning performance ratings and specifications, User should contact a TI field representative prior to connecting interface electronics including input power and intended loads. Any loads applied outside of the specified output range may also result in unintended and/or inaccurate operation and/or possible permanent damage to the EVM and/or interface electronics. Please consult the EVM user guide prior to connecting any load to the EVM output. If there is uncertainty as to the load specification, please contact a TI field representative. During normal operation, even with the inputs and outputs kept within the specified allowable ranges, some circuit components may have elevated case temperatures. These components include but are not limited to linear regulators, switching transistors, pass transistors, current sense resistors, and heat sinks, which can be identified using the information in the associated documentation. When working with the EVM, please be aware that the EVM may become very warm.

4.3.2 EVMs are intended solely for use by technically qualified, professional electronics experts who are familiar with the dangers and application risks associated with handling electrical mechanical components, systems, and subsystems. User assumes all responsibility and liability for proper and safe handling and use of the EVM by User or its employees, affiliates, contractors or designees. User assumes all responsibility and liability to ensure that any interfaces (electronic and/or mechanical) between the EVM and any human body are designed with suitable isolation and means to safely limit accessible leakage currents to minimize the risk of electrical shock hazard. User assumes all responsibility and liability for any improper or unsafe handling or use of the EVM by User or its employees, affiliates, contractors or designees.

4.4 User assumes all responsibility and liability to determine whether the EVM is subject to any applicable international, federal, state, or local laws and regulations related to User's handling and use of the EVM and, if applicable, User assumes all responsibility and liability for compliance in all respects with such laws and regulations. User assumes all responsibility and liability for proper disposal and recycling of the EVM consistent with all applicable international, federal, state, and local requirements.

5. *Accuracy of Information:* To the extent TI provides information on the availability and function of EVMs, TI attempts to be as accurate as possible. However, TI does not warrant the accuracy of EVM descriptions, EVM availability or other information on its websites as accurate, complete, reliable, current, or error-free.

6. *Disclaimers:*

6.1 EXCEPT AS SET FORTH ABOVE, EVMS AND ANY MATERIALS PROVIDED WITH THE EVM (INCLUDING, BUT NOT LIMITED TO, REFERENCE DESIGNS AND THE DESIGN OF THE EVM ITSELF) ARE PROVIDED "AS IS" AND "WITH ALL FAULTS." TI DISCLAIMS ALL OTHER WARRANTIES, EXPRESS OR IMPLIED, REGARDING SUCH ITEMS, INCLUDING BUT NOT LIMITED TO ANY EPIDEMIC FAILURE WARRANTY OR IMPLIED WARRANTIES OF MERCHANTABILITY OR FITNESS FOR A PARTICULAR PURPOSE OR NON-INFRINGEMENT OF ANY THIRD PARTY PATENTS, COPYRIGHTS, TRADE SECRETS OR OTHER INTELLECTUAL PROPERTY RIGHTS.

6.2 EXCEPT FOR THE LIMITED RIGHT TO USE THE EVM SET FORTH HEREIN, NOTHING IN THESE TERMS SHALL BE CONSTRUED AS GRANTING OR CONFERRING ANY RIGHTS BY LICENSE, PATENT, OR ANY OTHER INDUSTRIAL OR INTELLECTUAL PROPERTY RIGHT OF TI, ITS SUPPLIERS/LICENSORS OR ANY OTHER THIRD PARTY, TO USE THE EVM IN ANY FINISHED END-USER OR READY-TO-USE FINAL PRODUCT, OR FOR ANY INVENTION, DISCOVERY OR IMPROVEMENT, REGARDLESS OF WHEN MADE, CONCEIVED OR ACQUIRED.

7. *USER'S INDEMNITY OBLIGATIONS AND REPRESENTATIONS.* USER WILL DEFEND, INDEMNIFY AND HOLD TI, ITS LICENSORS AND THEIR REPRESENTATIVES HARMLESS FROM AND AGAINST ANY AND ALL CLAIMS, DAMAGES, LOSSES, EXPENSES, COSTS AND LIABILITIES (COLLECTIVELY, "CLAIMS") ARISING OUT OF OR IN CONNECTION WITH ANY HANDLING OR USE OF THE EVM THAT IS NOT IN ACCORDANCE WITH THESE TERMS. THIS OBLIGATION SHALL APPLY WHETHER CLAIMS ARISE UNDER STATUTE, REGULATION, OR THE LAW OF TORT, CONTRACT OR ANY OTHER LEGAL THEORY, AND EVEN IF THE EVM FAILS TO PERFORM AS DESCRIBED OR EXPECTED.

8. *Limitations on Damages and Liability:*

8.1 *General Limitations.* IN NO EVENT SHALL TI BE LIABLE FOR ANY SPECIAL, COLLATERAL, INDIRECT, PUNITIVE, INCIDENTAL, CONSEQUENTIAL, OR EXEMPLARY DAMAGES IN CONNECTION WITH OR ARISING OUT OF THESE TERMS OR THE USE OF THE EVMS, REGARDLESS OF WHETHER TI HAS BEEN ADVISED OF THE POSSIBILITY OF SUCH DAMAGES. EXCLUDED DAMAGES INCLUDE, BUT ARE NOT LIMITED TO, COST OF REMOVAL OR REINSTALLATION, ANCILLARY COSTS TO THE PROCUREMENT OF SUBSTITUTE GOODS OR SERVICES, RETESTING, OUTSIDE COMPUTER TIME, LABOR COSTS, LOSS OF GOODWILL, LOSS OF PROFITS, LOSS OF SAVINGS, LOSS OF USE, LOSS OF DATA, OR BUSINESS INTERRUPTION. NO CLAIM, SUIT OR ACTION SHALL BE BROUGHT AGAINST TI MORE THAN TWELVE (12) MONTHS AFTER THE EVENT THAT GAVE RISE TO THE CAUSE OF ACTION HAS OCCURRED.

8.2 *Specific Limitations.* IN NO EVENT SHALL TI'S AGGREGATE LIABILITY FROM ANY USE OF AN EVM PROVIDED HEREUNDER, INCLUDING FROM ANY WARRANTY, INDEMNITY OR OTHER OBLIGATION ARISING OUT OF OR IN CONNECTION WITH THESE TERMS, EXCEED THE TOTAL AMOUNT PAID TO TI BY USER FOR THE PARTICULAR EVM(S) AT ISSUE DURING THE PRIOR TWELVE (12) MONTHS WITH RESPECT TO WHICH LOSSES OR DAMAGES ARE CLAIMED. THE EXISTENCE OF MORE THAN ONE CLAIM SHALL NOT ENLARGE OR EXTEND THIS LIMIT.

9. *Return Policy.* Except as otherwise provided, TI does not offer any refunds, returns, or exchanges. Furthermore, no return of EVM(s) will be accepted if the package has been opened and no return of the EVM(s) will be accepted if they are damaged or otherwise not in a resalable condition. If User feels it has been incorrectly charged for the EVM(s) it ordered or that delivery violates the applicable order, User should contact TI. All refunds will be made in full within thirty (30) working days from the return of the components(s), excluding any postage or packaging costs.

10. *Governing Law:* These terms and conditions shall be governed by and interpreted in accordance with the laws of the State of Texas, without reference to conflict-of-laws principles. User agrees that non-exclusive jurisdiction for any dispute arising out of or relating to these terms and conditions lies within courts located in the State of Texas and consents to venue in Dallas County, Texas. Notwithstanding the foregoing, any judgment may be enforced in any United States or foreign court, and TI may seek injunctive relief in any United States or foreign court.

IMPORTANT NOTICE FOR TI DESIGN INFORMATION AND RESOURCES

Texas Instruments Incorporated ("TI") technical, application or other design advice, services or information, including, but not limited to, reference designs and materials relating to evaluation modules, (collectively, "TI Resources") are intended to assist designers who are developing applications that incorporate TI products; by downloading, accessing or using any particular TI Resource in any way, you (individually or, if you are acting on behalf of a company, your company) agree to use it solely for this purpose and subject to the terms of this Notice.

TI's provision of TI Resources does not expand or otherwise alter TI's applicable published warranties or warranty disclaimers for TI products, and no additional obligations or liabilities arise from TI providing such TI Resources. TI reserves the right to make corrections, enhancements, improvements and other changes to its TI Resources.

You understand and agree that you remain responsible for using your independent analysis, evaluation and judgment in designing your applications and that you have full and exclusive responsibility to assure the safety of your applications and compliance of your applications (and of all TI products used in or for your applications) with all applicable regulations, laws and other applicable requirements. You represent that, with respect to your applications, you have all the necessary expertise to create and implement safeguards that (1) anticipate dangerous consequences of failures, (2) monitor failures and their consequences, and (3) lessen the likelihood of failures that might cause harm and take appropriate actions. You agree that prior to using or distributing any applications that include TI products, you will thoroughly test such applications and the functionality of such TI products as used in such applications. TI has not conducted any testing other than that specifically described in the published documentation for a particular TI Resource.

You are authorized to use, copy and modify any individual TI Resource only in connection with the development of applications that include the TI product(s) identified in such TI Resource. NO OTHER LICENSE, EXPRESS OR IMPLIED, BY ESTOPPEL OR OTHERWISE TO ANY OTHER TI INTELLECTUAL PROPERTY RIGHT, AND NO LICENSE TO ANY TECHNOLOGY OR INTELLECTUAL PROPERTY RIGHT OF TI OR ANY THIRD PARTY IS GRANTED HEREIN, including but not limited to any patent right, copyright, mask work right, or other intellectual property right relating to any combination, machine, or process in which TI products or services are used. Information regarding or referencing third-party products or services does not constitute a license to use such products or services, or a warranty or endorsement thereof. Use of TI Resources may require a license from a third party under the patents or other intellectual property of the third party, or a license from TI under the patents or other intellectual property of TI.

TI RESOURCES ARE PROVIDED "AS IS" AND WITH ALL FAULTS. TI DISCLAIMS ALL OTHER WARRANTIES OR REPRESENTATIONS, EXPRESS OR IMPLIED, REGARDING TI RESOURCES OR USE THEREOF, INCLUDING BUT NOT LIMITED TO ACCURACY OR COMPLETENESS, TITLE, ANY EPIDEMIC FAILURE WARRANTY AND ANY IMPLIED WARRANTIES OF MERCHANTABILITY, FITNESS FOR A PARTICULAR PURPOSE, AND NON-INFRINGEMENT OF ANY THIRD PARTY INTELLECTUAL PROPERTY RIGHTS.

TI SHALL NOT BE LIABLE FOR AND SHALL NOT DEFEND OR INDEMNIFY YOU AGAINST ANY CLAIM, INCLUDING BUT NOT LIMITED TO ANY INFRINGEMENT CLAIM THAT RELATES TO OR IS BASED ON ANY COMBINATION OF PRODUCTS EVEN IF DESCRIBED IN TI RESOURCES OR OTHERWISE. IN NO EVENT SHALL TI BE LIABLE FOR ANY ACTUAL, DIRECT, SPECIAL, COLLATERAL, INDIRECT, PUNITIVE, INCIDENTAL, CONSEQUENTIAL OR EXEMPLARY DAMAGES IN CONNECTION WITH OR ARISING OUT OF TI RESOURCES OR USE THEREOF, AND REGARDLESS OF WHETHER TI HAS BEEN ADVISED OF THE POSSIBILITY OF SUCH DAMAGES.

You agree to fully indemnify TI and its representatives against any damages, costs, losses, and/or liabilities arising out of your non-compliance with the terms and provisions of this Notice.

This Notice applies to TI Resources. Additional terms apply to the use and purchase of certain types of materials, TI products and services. These include; without limitation, TI's standard terms for semiconductor products (<http://www.ti.com/sc/docs/stdterms.htm>), [evaluation modules](#), and [samples](http://www.ti.com/sc/docs/sampterm.htm) (<http://www.ti.com/sc/docs/sampterm.htm>).

Mailing Address: Texas Instruments, Post Office Box 655303, Dallas, Texas 75265
Copyright © 2018, Texas Instruments Incorporated