

OLGA-WAS

Asymmetric beam for wall-washing. Assembly with holder and installation tape.

SPECIFICATION:

Dimensions	Ø 32.0 mm
Height	20.8 mm
Fastening	tape
ROHS compliant	yes ⓘ



MATERIALS:

Component	Type	Material	Colour	Finish
OLGA-WAS	Single lens	PMMA	clear	
OLGA-HLD	Holder	PC	black	
SPUTNIK-TAPE3	Tape	Acrylic foam	black	



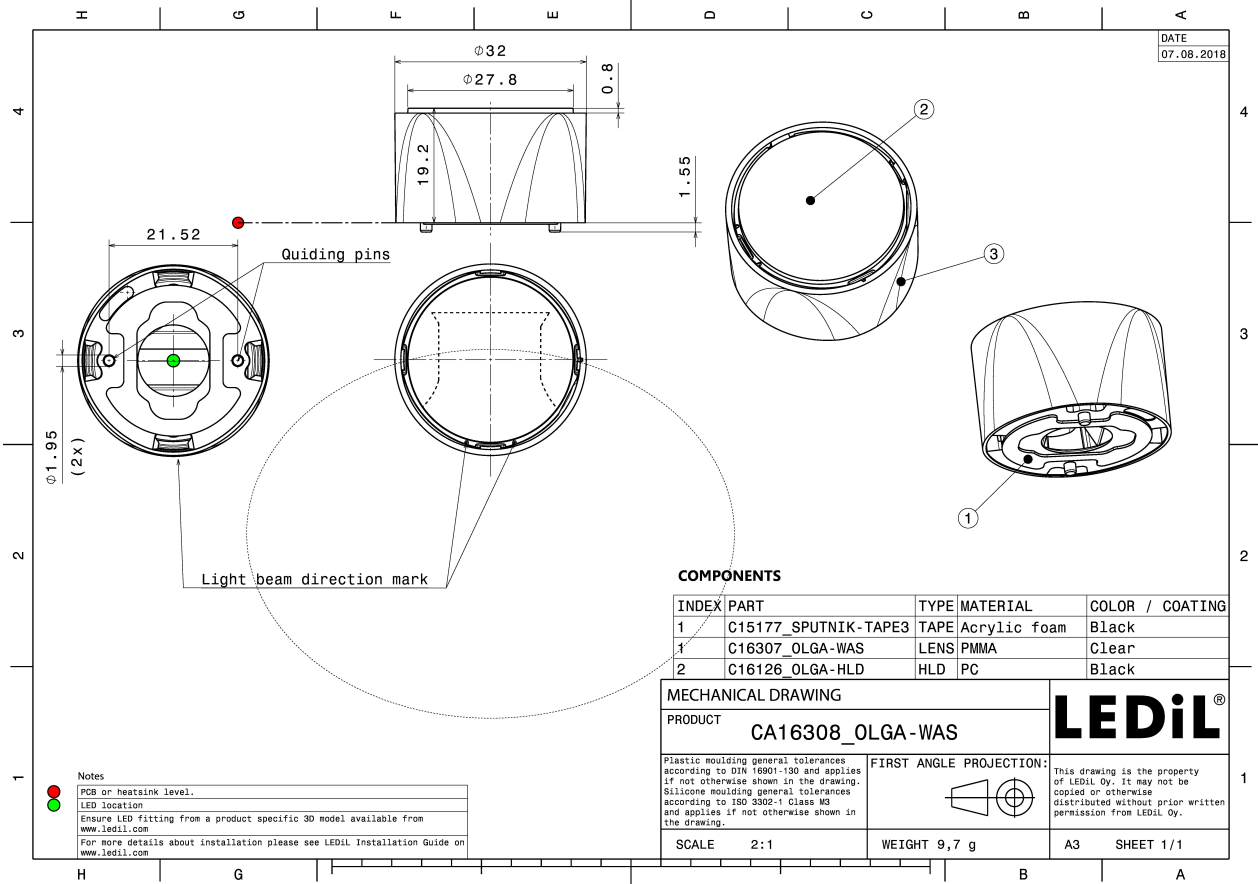

ORDERING INFORMATION:

Component	Type	Qty in box	MOQ	MPQ	Box weight (kg)
CA16308_OLGA-WAS	Single lens	792	132	66	9.0
» Box size: 476 x 273 x 292 mm					

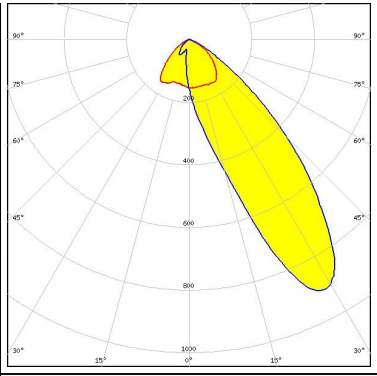

See also our general installation guide: www.ledil.com/installation_guide

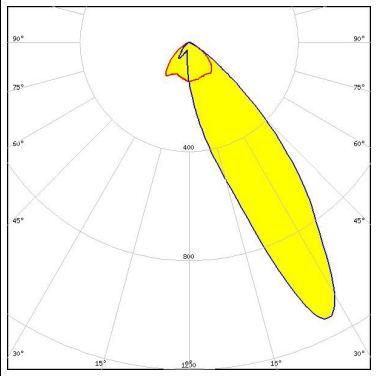
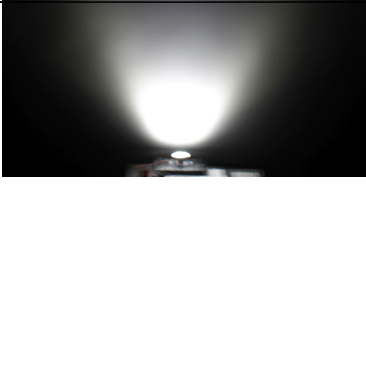
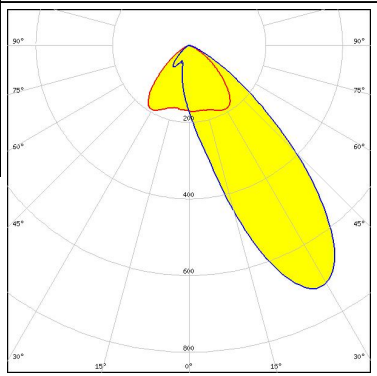
OPTICAL RESULTS (MEASURED):

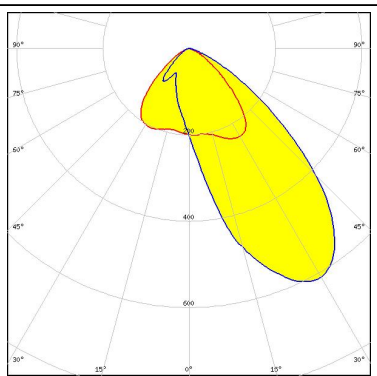
<p>CREE → LED</p> <p>LED XHP35 HD FWHM / FWTM Asymmetric Efficiency 73 % Peak intensity 0.9 cd/lm LEDs/each optic 1 Light colour White Required components:</p>		
<p>CREE → LED</p> <p>LED XHP35 HI FWHM / FWTM Asymmetric Efficiency 76 % Peak intensity 1.1 cd/lm LEDs/each optic 1 Light colour White Required components:</p>		
<p>CREE → LED</p> <p>LED XHP50.2 FWHM / FWTM Asymmetric Efficiency 67 % Peak intensity 0.7 cd/lm LEDs/each optic 1 Light colour White Required components:</p>		
<p>CREE → LED</p> <p>LED XHP70.2 FWHM / FWTM Asymmetric Efficiency 70 % Peak intensity 0.6 cd/lm LEDs/each optic 1 Light colour White Required components:</p>		

OPTICAL RESULTS (MEASURED):

CREE LED

LED XM-L3
 FWHM / FWTM Asymmetric
 Efficiency 72 %
 Peak intensity 0.9 cd/lm
 LEDs/each optic 1
 Light colour White
 Required components:

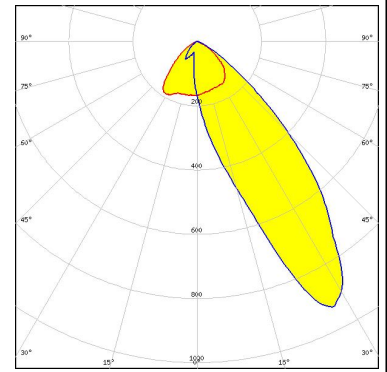

CREE LED

LED XP-E2
 FWHM / FWTM Asymmetric
 Efficiency 76 %
 Peak intensity 1.3 cd/lm
 LEDs/each optic 1
 Light colour White
 Required components:

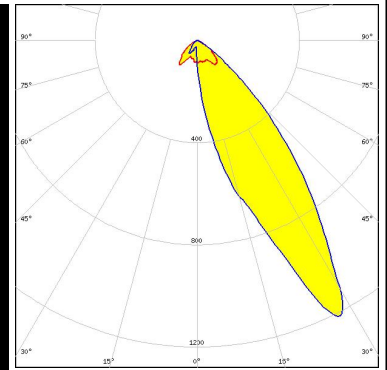
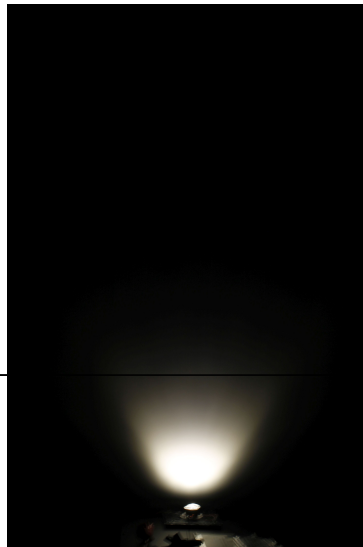

CREE LED

LED XP-G2
 FWHM / FWTM Asymmetric
 Efficiency 76 %
 Peak intensity 1.2 cd/lm
 LEDs/each optic 1
 Light colour White
 Required components:

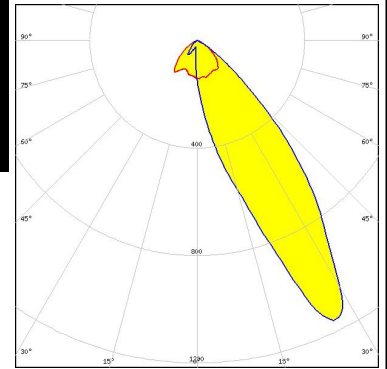



CREE LED

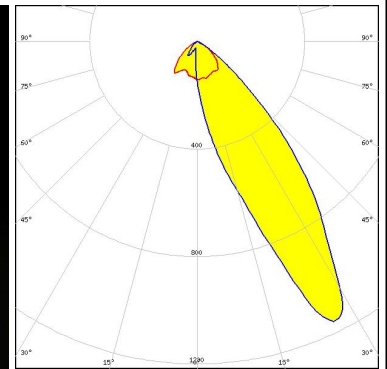
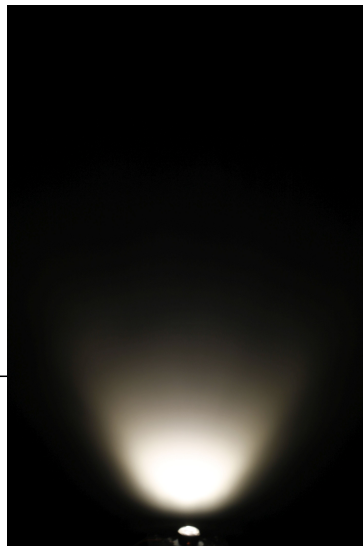

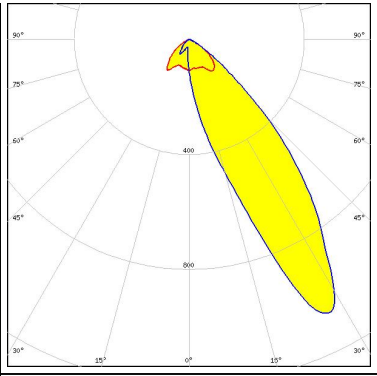
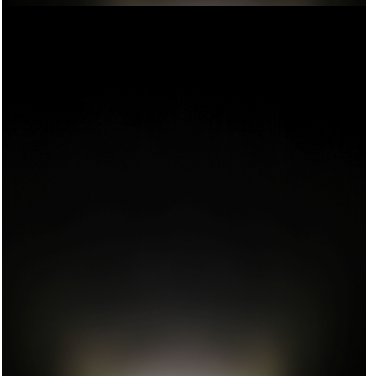
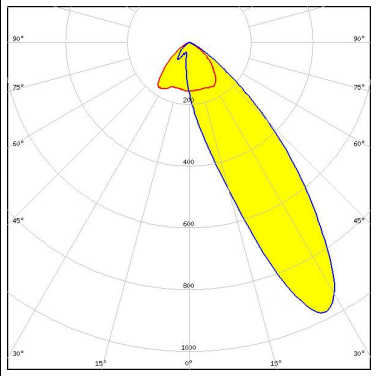
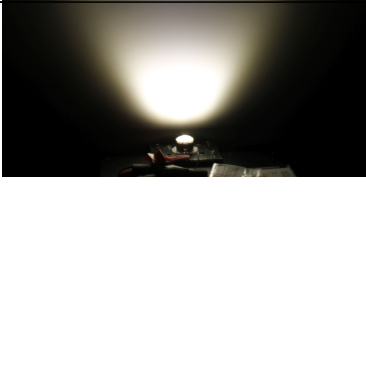
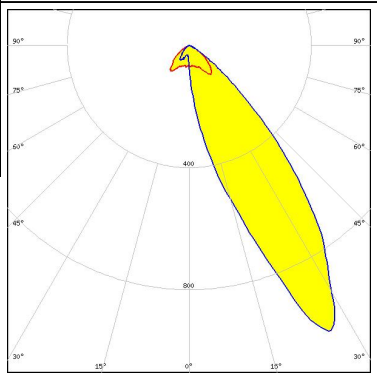

LED XP-G2
 FWHM / FWTM Asymmetric
 Efficiency 75 %
 Peak intensity 1.2 cd/lm
 LEDs/each optic 1
 Light colour White
 Required components:

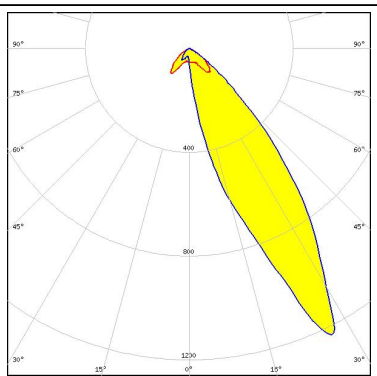

OPTICAL RESULTS (MEASURED):

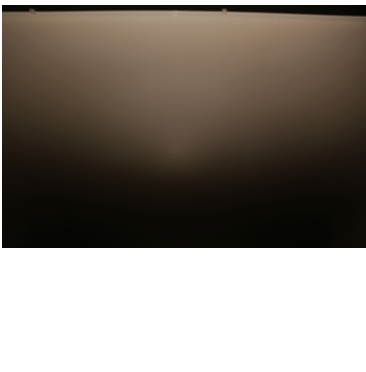
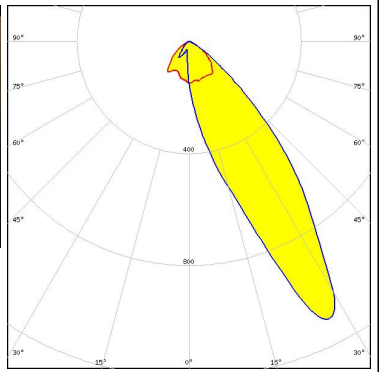
<p>CREE → LED</p> <p>LED XP-G3 FWHM / FWTM Asymmetric Efficiency 72 % Peak intensity 1.1 cd/lm LEDs/each optic 1 Light colour White Required components:</p>		
<p>CREE → LED</p> <p>LED XP-L2 FWHM / FWTM Asymmetric Efficiency 72 % Peak intensity 1 cd/lm LEDs/each optic 1 Light colour White Required components:</p>		
<p>CREE → LED</p> <p>LED XQ-E HD FWHM / FWTM Asymmetric Efficiency 67 % Peak intensity 1.1 cd/lm LEDs/each optic 1 Light colour White Required components:</p>		
<p>CREE → LED</p> <p>LED XQ-E HI FWHM / FWTM Asymmetric Efficiency 72 % Peak intensity 1.3 cd/lm LEDs/each optic 1 Light colour White Required components:</p>		

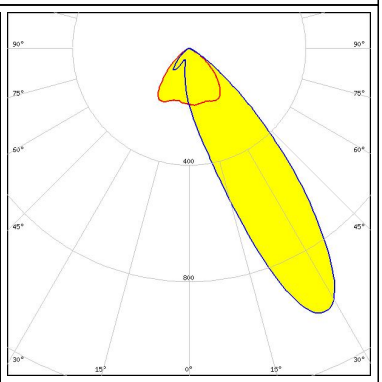
OPTICAL RESULTS (MEASURED):

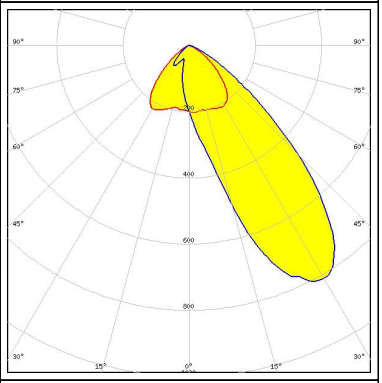
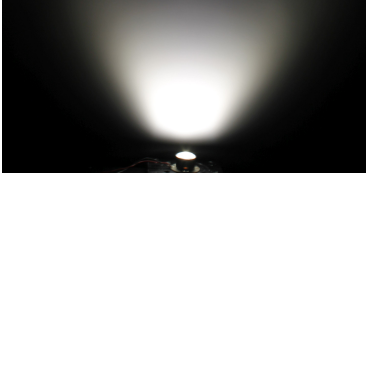
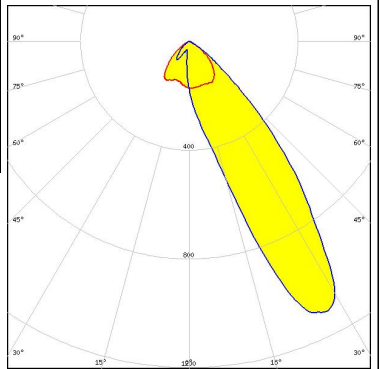
<p>CREE LED</p> <p>LED XT-E FWHM / FWTM Asymmetric Efficiency 71 % Peak intensity 1.1 cd/lm LEDs/each optic 1 Light colour White Required components:</p>		
<p>LUMILEDS</p> <p>LED LUXEON 5050 Round LES FWHM / FWTM Asymmetric Efficiency 75 % Peak intensity 1 cd/lm LEDs/each optic 1 Light colour White Required components:</p>		
<p>LUMILEDS</p> <p>LED LUXEON M/MX FWHM / FWTM Asymmetric Efficiency 75 % Peak intensity 0.8 cd/lm LEDs/each optic 1 Light colour White Required components:</p>		
<p>LUMILEDS</p> <p>LED LUXEON MZ FWHM / FWTM Asymmetric Efficiency 75 % Peak intensity 1.1 cd/lm LEDs/each optic 1 Light colour White Required components:</p>		

OPTICAL RESULTS (MEASURED):

LUMILEDS

LED LUXEON TX
 FWHM / FWTM Asymmetric
 Efficiency 72 %
 Peak intensity 1.2 cd/lm
 LEDs/each optic 1
 Light colour White
 Required components:

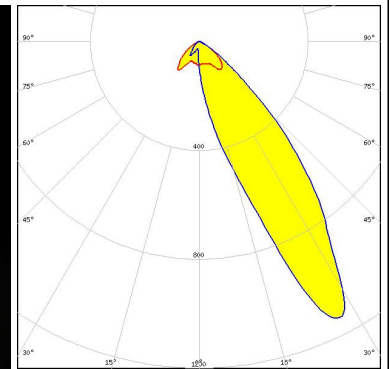
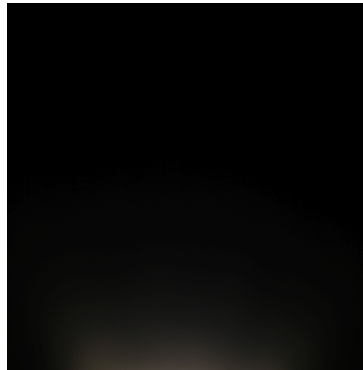

LUMILEDS

LED LUXEON V
 FWHM / FWTM Asymmetric
 Efficiency 73 %
 Peak intensity 1 cd/lm
 LEDs/each optic 1
 Light colour White
 Required components:

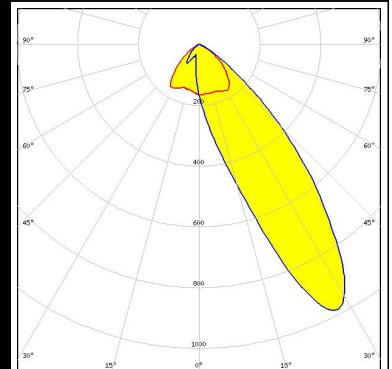
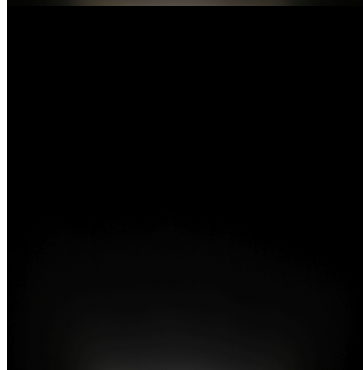

LUMILEDS

LED LUXEON Z ES
 FWHM / FWTM Asymmetric
 Efficiency 76 %
 Peak intensity 1.4 cd/lm
 LEDs/each optic 1
 Light colour White
 Required components:

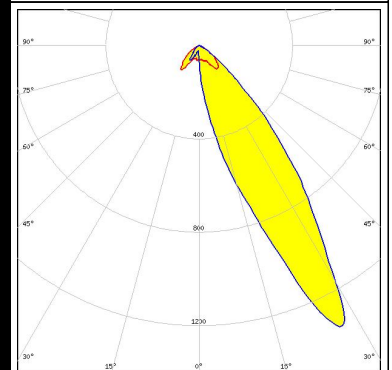
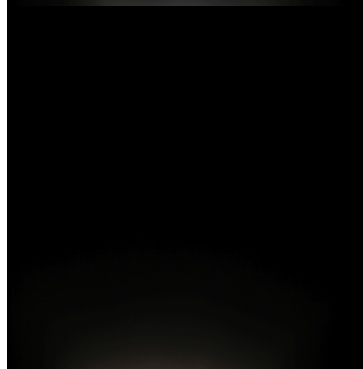

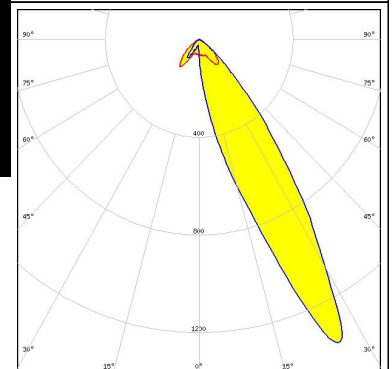

NICHIA

LED NCSxE17A
 FWHM / FWTM Asymmetric
 Efficiency 72 %
 Peak intensity 1.4 cd/lm
 LEDs/each optic 1
 Light colour White
 Required components:

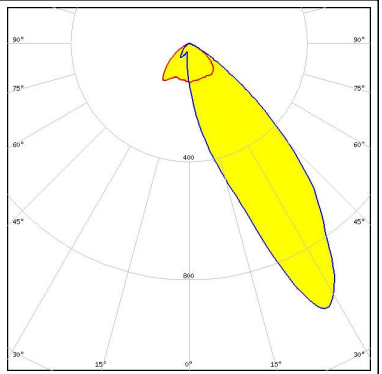
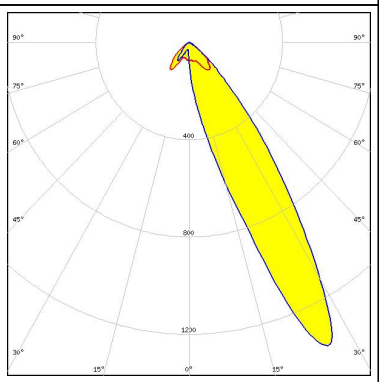

OPTICAL RESULTS (MEASURED):

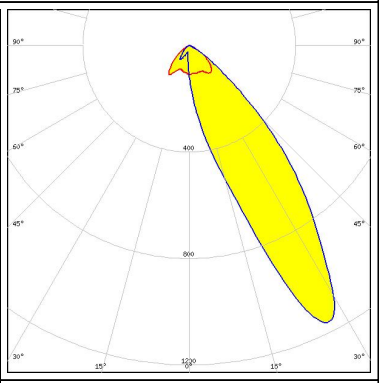
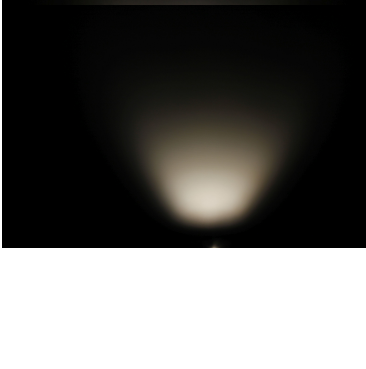
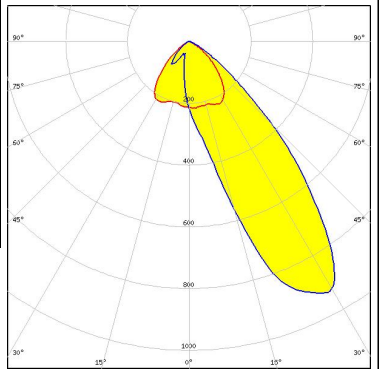
<p>NICHIA</p> <p>LED NVSW319B FWHM / FWTM Asymmetric Efficiency 75 % Peak intensity 1 cd/lm LEDs/each optic 1 Light colour White Required components:</p>		
<p>NICHIA</p> <p>LED NVSxE21A FWHM / FWTM Asymmetric Efficiency 72 % Peak intensity 1.4 cd/lm LEDs/each optic 1 Light colour White Required components:</p>		
<p>NICHIA</p> <p>LED NVSxx19B/NVSxx19C FWHM / FWTM Asymmetric Efficiency 75 % Peak intensity 1.2 cd/lm LEDs/each optic 1 Light colour White Required components:</p>		
<p>OSRAM <small>Opto Semiconductors</small></p> <p>LED Duris S8 FWHM / FWTM Asymmetric Efficiency 75 % Peak intensity 0.9 cd/lm LEDs/each optic 1 Light colour White Required components:</p>		

OPTICAL RESULTS (MEASURED):

OSRAM

Opto Semiconductors

LED OSCONIQ P 3737 (2W version)
 FWHM / FWTM Asymmetric
 Efficiency 75 %
 Peak intensity 1.3 cd/lm
 LEDs/each optic 1
 Light colour White
 Required components:

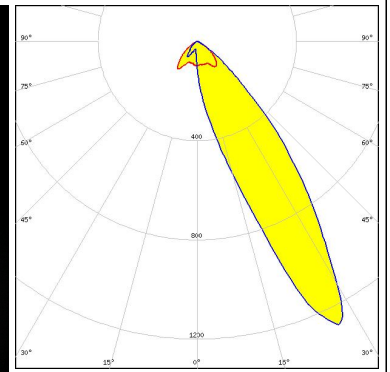
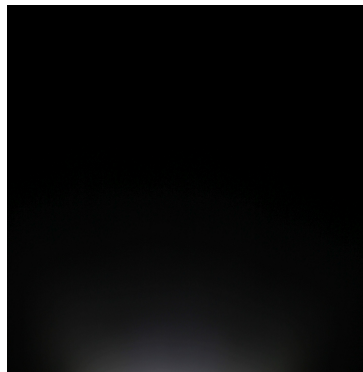

OSRAM

Opto Semiconductors

LED OSCONIQ P 3737 (3W version)
 FWHM / FWTM Asymmetric
 Efficiency 75 %
 Peak intensity 1.2 cd/lm
 LEDs/each optic 1
 Light colour White
 Required components:

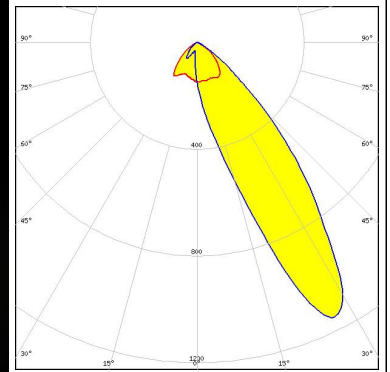
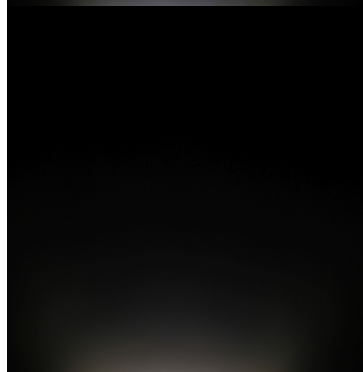

OSRAM

Opto Semiconductors

LED OSLON Square CSSRM2/CSSRM3
 FWHM / FWTM Asymmetric
 Efficiency 76 %
 Peak intensity 1.2 cd/lm
 LEDs/each optic 1
 Light colour White
 Required components:

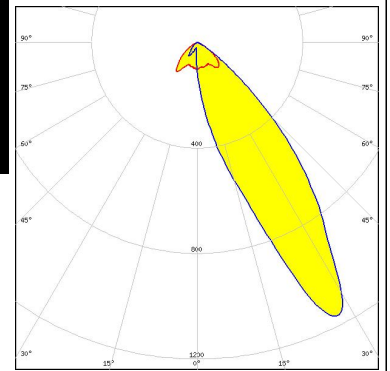

OSRAM

Opto Semiconductors

LED OSLON SSL 150
 FWHM / FWTM Asymmetric
 Efficiency 71 %
 Peak intensity 1.1 cd/lm
 LEDs/each optic 1
 Light colour White
 Required components:

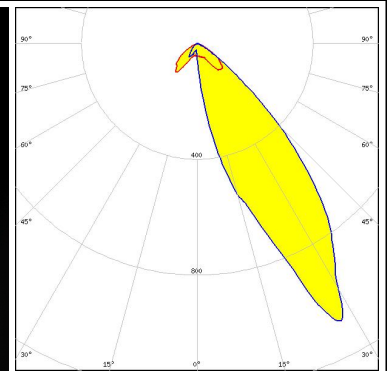
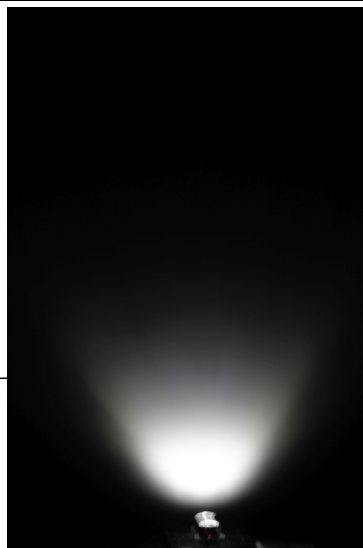

OPTICAL RESULTS (MEASURED):

OSRAM

Opto Semiconductors

LED OSTAR Stage (S2WN)
 FWHM / FWTM Asymmetric
 Efficiency 76 %
 Peak intensity 1.2 cd/lm
 LEDs/each optic 1
 Light colour RGBW
 Required components:

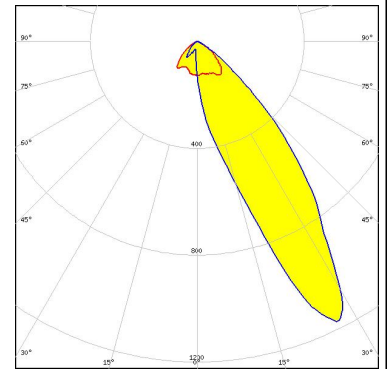

SAMSUNG

LED LH231B
 FWHM / FWTM Asymmetric
 Efficiency 74 %
 Peak intensity 1.3 cd/lm
 LEDs/each optic 1
 Light colour White
 Required components:

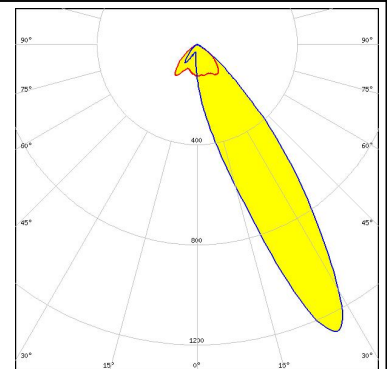

SAMSUNG

LED LH351B
 FWHM / FWTM Asymmetric
 Efficiency 78 %
 Peak intensity 1.2 cd/lm
 LEDs/each optic 1
 Light colour White
 Required components:

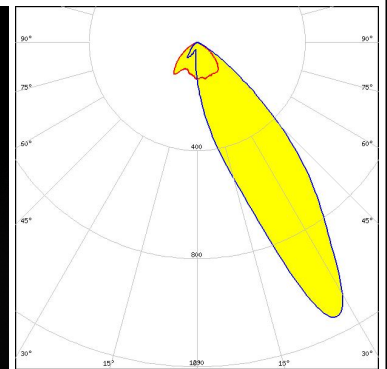

SAMSUNG

LED LH351C
 FWHM / FWTM Asymmetric
 Efficiency 79 %
 Peak intensity 1.2 cd/lm
 LEDs/each optic 1
 Light colour White
 Required components:

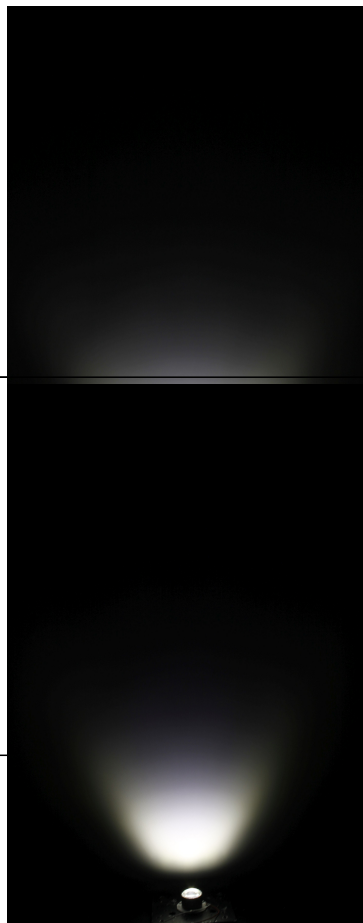
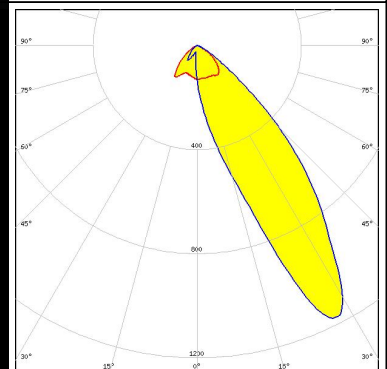

OPTICAL RESULTS (MEASURED):

SAMSUNG

LED LH351D
 FWHM / FWTM Asymmetric
 Efficiency 77 %
 Peak intensity 1 cd/lm
 LEDs/each optic 1
 Light colour White
 Required components:

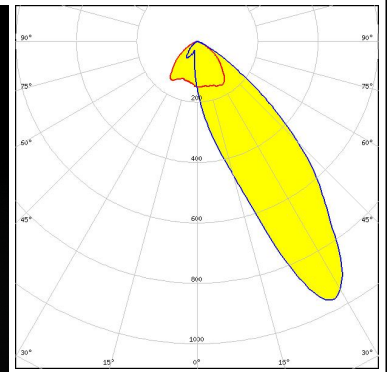
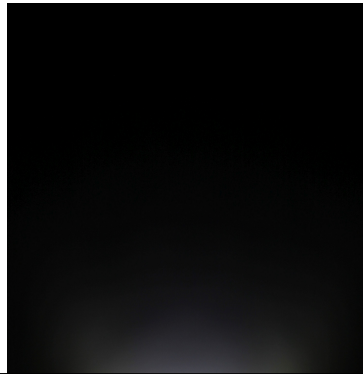

SAMSUNG

LED LH508A
 FWHM / FWTM Asymmetric
 Efficiency 75 %
 Peak intensity 1 cd/lm
 LEDs/each optic 1
 Light colour White
 Required components:

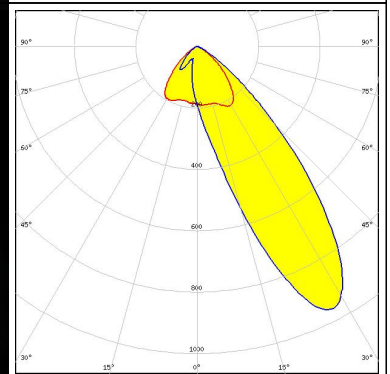

SEOUL SEMICONDUCTOR

LED WICOP 5050
 FWHM / FWTM Asymmetric
 Efficiency 69 %
 Peak intensity 0.7 cd/lm
 LEDs/each optic 1
 Light colour White
 Required components:

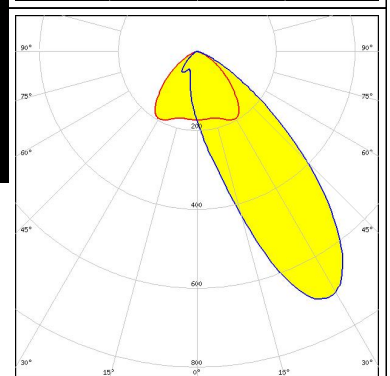





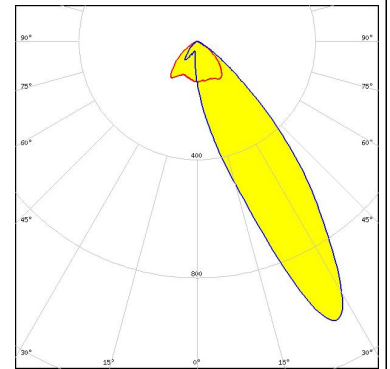

SEOUL SEMICONDUCTOR

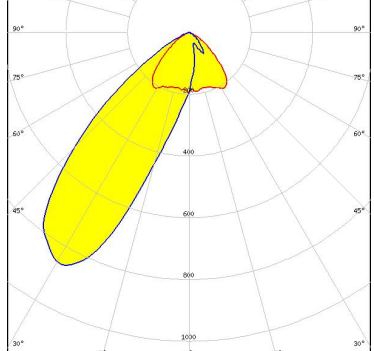
LED Z5M3
 FWHM / FWTM Asymmetric
 Efficiency 71 %
 Peak intensity 1.1 cd/lm
 LEDs/each optic 1
 Light colour White
 Required components:

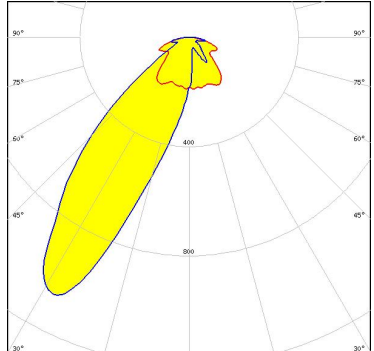

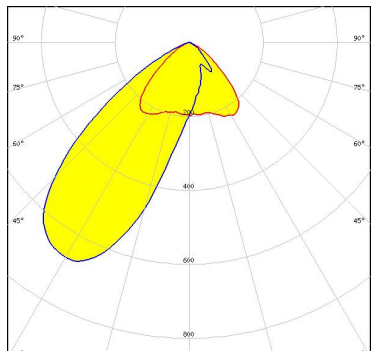
OPTICAL RESULTS (SIMULATED):

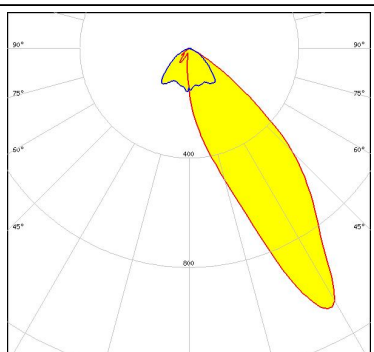
	<p>LED XHP50.3 HD FWHM / FWTM Asymmetric Efficiency 77 % Peak intensity 0.9 cd/lm LEDs/each optic 1 Light colour White Required components:</p>	
	<p>LED XHP50.3 HI FWHM / FWTM Asymmetric Efficiency 96 % Peak intensity 1.1 cd/lm LEDs/each optic 1 Light colour White Required components:</p>	
	<p>LED XHP70.3 HD FWHM / FWTM Asymmetric Efficiency 76 % Peak intensity 0.7 cd/lm LEDs/each optic 1 Light colour White Required components:</p>	
	<p>LED XP-G2 HE FWHM / FWTM Asymmetric Efficiency 79 % Peak intensity 1.1 cd/lm LEDs/each optic 1 Light colour White Required components:</p>	

OPTICAL RESULTS (SIMULATED):



LED: XP-L HI
 FWHM / FWTM: Asymmetric
 Efficiency: 80 %
 Peak intensity: 1.2 cd/lm
 LEDs/each optic: 1
 Light colour: White
 Required components:

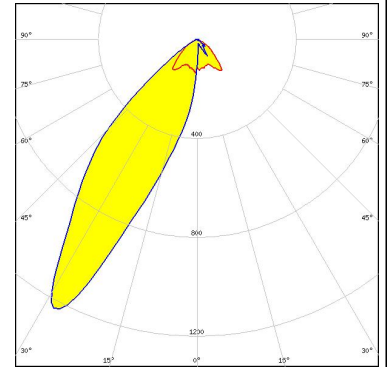

LED: LUXEON 7070
 FWHM / FWTM: Asymmetric
 Efficiency: 95 %
 Peak intensity: 0.8 cd/lm
 LEDs/each optic: 1
 Light colour: White
 Required components:

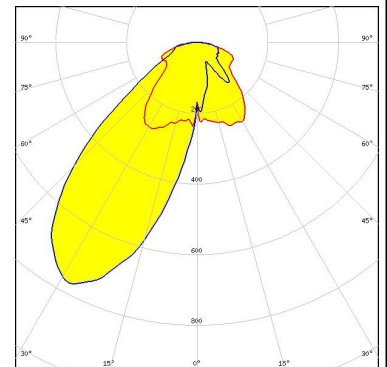

LED: SST-70X-WCS
 FWHM / FWTM: Asymmetric
 Efficiency: 77 %
 Peak intensity: 1 cd/lm
 LEDs/each optic: 1
 Light colour: White
 Required components:

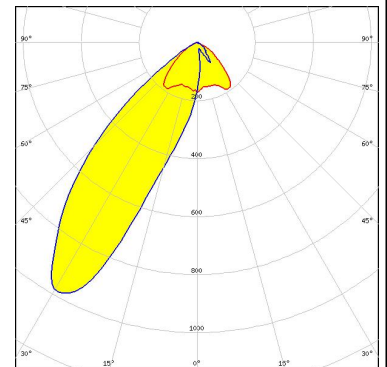

LED: NV4WB35AM
 FWHM / FWTM: Asymmetric
 Efficiency: 78 %
 Peak intensity: 1.1 cd/lm
 LEDs/each optic: 1
 Light colour: White
 Required components:

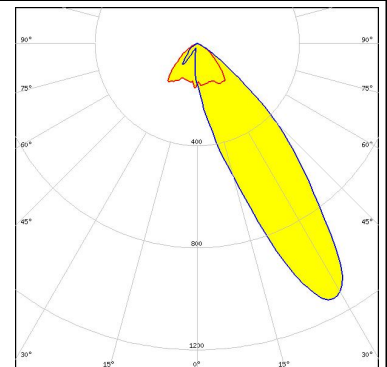

OPTICAL RESULTS (SIMULATED):



LED	NV4x144A
FWHM / FWTM	Asymmetric
Efficiency	78 %
Peak intensity	0.8 cd/lm
LEDs/each optic	1
Light colour	White
Required components:	

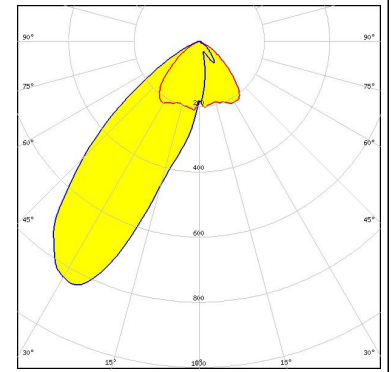

GENERAL INFORMATION:

NOTE: The typical beam angle will be changed by different color, chip size and chip position tolerance. The typical total beam angle is the full angle measured where the luminous intensity is half of the peak value.

MATERIALS:

As part of our continuous research and improvement processes, and to ensure the best possible quality and availability of our products, LEDiL reserves the right to change material grades without notice.

PRODUCT DATA USER AGREEMENT AND DISCLAIMER:

The measured data in the provided downloadable LEDiL Product Datasheets and Mechanical 2D-Drawings is rounded and provided as reference for planning. LEDiL Oy's optical specifications have been verified by conducting performance testing of the products in accordance with the company's quality system. The reported data are averaged results of multiple measurements with typical variation. LEDiL Oy reserves the right to without prior notification make changes and improvements to its products.

LEDiL Oy assumes neither warranty, nor guarantee nor any other liability of any kind for the contents and correctness of the provided data. The provided data has been generated with highest diligence but the provided data may in reality not represent the complete possible variation range of all intrinsic parameters. Therefore, in certain cases a deviation from the provided data could occur.

LEDiL Oy reserves the right to undertake technical changes of its products without further notification which could lead to changes in the provided data. LEDiL Oy assumes no liability of any kind for the possible deviation from any provided data or any other damage resulting from the usage of the provided data.

The user agrees to this disclaimer and user agreement with the download or usage of the provided files.

LEDiL Oy

Joensuunkatu 13
FI-24240 SALO
Finland

LEDiL Inc.

228 West Page Street
Suite D
Sycamore IL 60178
USA

Ledil Optics Technology (Shenzhen) Co., Ltd.

405 , Block B
Casic Motor Building
Shenzhen 518057
P.R.CHINA

Local sales and technical support

[www.ledil.com/
where_to_buy](http://www.ledil.com/where_to_buy)

Shipping locations

Salo, Finland
Hong Kong, China

Distribution Partners

[www.ledil.com/
where_to_buy](http://www.ledil.com/where_to_buy)