

Data sheet | Item number: 750-962

INTERBUS fieldbus connector (OUT); with D-sub male connector; 9-pole

www.wago.com/750-962

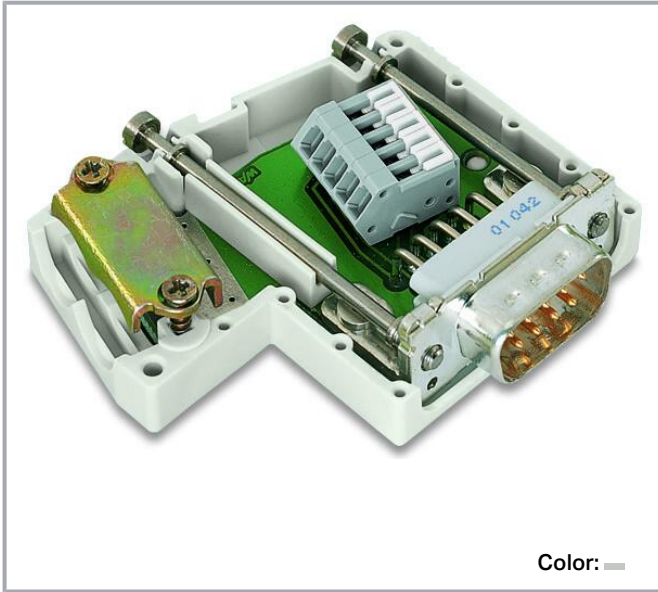

Color: —

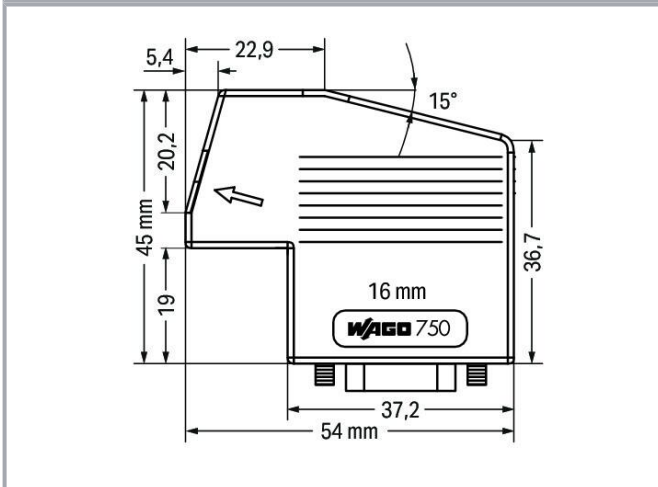
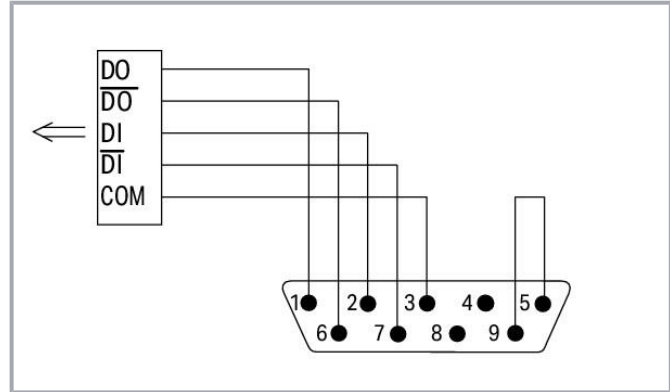

Item description

This fieldbus connector links an INTERBUS device to an INTERBUS line.

The fieldbus connector has the following features:

Subject to changes. Please also observe the further product documentation!

WAGO GmbH & Co. KG
Hansastr. 27
32423 Minden
Phone: +49571 887-0 | Fax: +49571 887-169
Email: info.de@wago.com | Web: www.wago.com

Do you have any questions about our products?
We are always happy to take your call at +49 (571) 887-44222.



- Fast and maintenance-free CAGE CLAMP® connection – a locking slide keeps the clamping unit in its open position

Data

Technical data

Connection type	D-sub 9 socket
Pole number	9
Communication/fieldbus	INTERBUS
Baud rate	2 MBd (per INTERBUS specification)

Connection data

Connection type 1	CAGE CLAMP® terminal strip with locking slide (218 Series)
Solid conductor	0.08 ... 0.5 mm ² / 28 ... 20 AWG
Strip length	5 ... 6 mm / 0.2 ... 0.24 inches

Physical data

Width	45 mm / 1.772 inches
Height	16 mm / 0.63 inches
Depth	54 mm / 2.126 inches

Mechanical Data

Connectable sheathed cable diameter	4.5 ... 9.5 mm
Housing material	PA66-105-V2
Weight	33.1 g
Color	light gray

Environmental requirements

Ambient temperature (operation)	0 ... +60 °C
Ambient temperature (storage)	-25 ... +85 °C
Protection type	IP20
Relative humidity (without condensation)	95 %
Fire load	0.286 MJ

Commercial data

Product Group	15 (I/O System)
---------------	-----------------

Subject to changes. Please also observe the further product documentation!



eCl@ss 10.0	27-24-26-92
eCl@ss 9.0	27-24-26-92
ETIM 8.0	EC002584
ETIM 7.0	EC002584
PU (SPU)	1 pcs
Packaging type	bag
Country of origin	DE
GTIN	4017332810715
Customs tariff number	85366990990

Environmental Product Compliance

RoHS Compliance Status	Compliant, No Exemption
------------------------	-------------------------

Approvals / Certificates

General approvals

Logo	Approval	Additional Approval Text	Certificate name
	CCC CNEX	CNCA-C23-01	2020312310000213 (Ex ec IIC T4 Gc)
	UL Underwriters Laboratories Inc. (ORDINARY LOCATIONS)	UL 508	E175199 Sec.1

Declarations of conformity and manufacturer's declarations



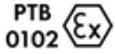

Logo	Approval	Additional Approval Text	Certificate name
	EU-Declaration of Conformity WAGO GmbH & Co. KG	-	-

Approvals for hazardous areas

Logo	Approval	Additional Approval Text	Certificate name
	ATEX TUEV Nord Cert GmbH	EN 60079-0	TUEV_14_ATEX_148929_X (II 3 G Ex ec IIC T4 Gc)
	CCC CNEX	CNCA-C23-01	2020312310000213 (Ex ec IIC T4 Gc)

Subject to changes. Please also observe the further product documentation!



	EAC Brjansker Zertifizierungsstelle	TP TC 012/2011	EAC RU C-DE.AM02.B.00163 /19 (2Ex nA IIC T4 Gc X)
	IECEX TUEV Nord Cert GmbH	IEC 60079-0	IECEX TUN 14.0035 X (Ex ec IIC T4 Gc)
	INMETRO TÜV Rheinland do Brasil Ltda.	IEC 60079-0	BR-Ex_TÜV 12.1297 X
	UKEx WAGO GmbH & Co. KG	EN 60079-0	UKCA_WAGO22UKEX003X_ec

Downloads

Documentation

Manual

System Manual WAGO I/O System 750/753 Decentralized Automation Technology	V 3.3.0 2023 May 4	pdf 8.8 MB	Download
--	-----------------------	---------------	--------------------------

Bid Text

750-962 X81 - Datei	2019 Feb 19	xml 4.0 kB	Download
750-962 doc - Datei	2017 Oct 6	doc 25.1 kB	Download

Instruction Leaflet

CCC Ex (Additional information) WAGO-I/O-SYSTEM *750-****/*	2023 Apr 26	pdf 163.6 kB	Download
--	-------------	-----------------	--------------------------

Additional Information

Subject to changes. Please also observe the further product documentation!

WAGO GmbH & Co. KG
 Hansastr. 27
 32423 Minden
 Phone: +49571 887-0 | Fax: +49571 887-169
 Email: info.de@wago.com | Web: www.wago.com

Do you have any questions about our products?
 We are always happy to take your call at +49 (571) 887-44222.



Disposal and Recycling Electrical and electronic equipment, Batteries, Packaging	V 1.1.0 2022 Aug 18	pdf 2.2 MB	Download
---	------------------------	---------------	----------

System Description

Overview on WAGO-I/O-SYSTEM 750 approvals		pdf 789.0 kB	Download
---	--	-----------------	----------

CAD/CAE-Data

CAE data

EPLAN Data Portal 750-962		URL	Download
WSCAD Universe 750-962		URL	Download

Environmental Product Compliance

Compliance Search

Environmental Product Compliance 750-962 INTERBUS fieldbus connector (OUT); with D-sub male connector; 9-pole		URL	Download
--	--	-----	----------

Installation Notes

Subject to changes. Please also observe the further product documentation!