

A50PF12202660J

Aliases (50PF12202660J)

A50, Film, Metallized Polyester, Automotive Grade, 2200 pF, 5%, 220 VAC, 630 VDC, 85°C

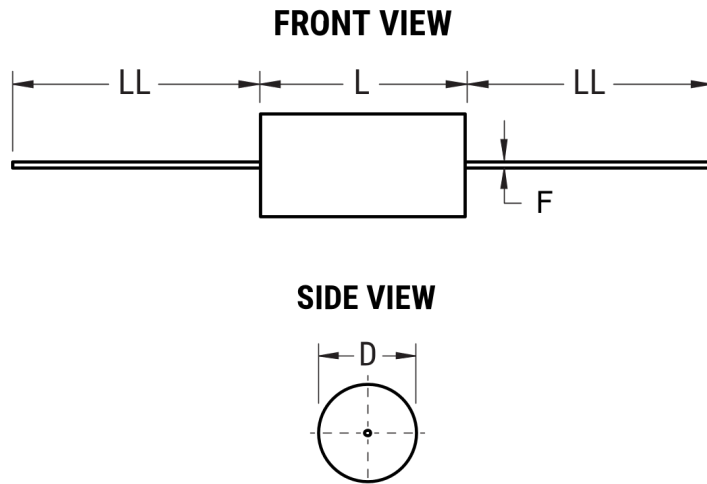

Click [here](#) for the 3D model.

Dimensions	
D	5mm MAX
L	11mm MAX
LL	20mm MIN
F	0.6mm +/-0.05mm

Packaging Specifications	
Packaging	T&R
Packaging Quantity	3000

General Information	
Series	A50
Dielectric	Metallized Polyester
Style	Axial
Features	Automotive Grade
RoHS	Yes
Lead	Wire Leads
Qualifications	AEC-Q200
AEC-Q200	Yes
Component Weight	0.4 g
Miscellaneous	Above 85C DC And AC Voltage Derating Is 1.25%/C. maxK0 = 25000.

Specifications	
Capacitance	2200 pF
Capacitance Tolerance	5%
Voltage AC	220 VAC
Voltage DC	630 VDC, 472.5 VDC (105C)
Temperature Range	-55/+105°C
Rated Temperature	85°C
Dissipation Factor	0.8% 1kHz, 1.2% 10kHz, 2.5% 100kHz
Insulation Resistance	30 GOhms
Max dV/dt	20 V/us
Inductance	7 nH

Statements of suitability for certain applications are based on our knowledge of typical operating conditions for such applications, but are not intended to constitute - and we specifically disclaim - any warranty concerning suitability for a specific customer application or use. This information is intended for use only by customers who have the requisite experience and capability to determine the correct products for their application. Any technical advice inferred from this information or otherwise provided by us with reference to the use of our products is given gratis, and we assume no obligation or liability for the advice given or results obtained.