

C & D CASES

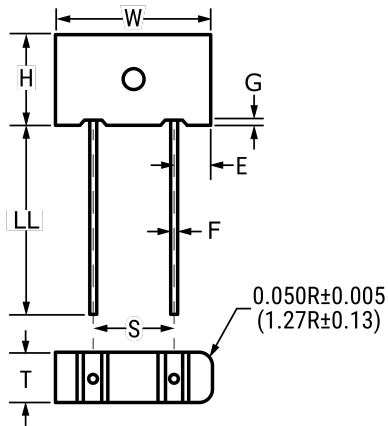

Click [here](#) for the 3D model.

General Information

Series	T330
Dielectric	MnO ₂ Tantalum
Style	Radial Molded
Description	Radial, Solid Tantalum, Molded
Features	Low Leakage
RoHS	No
Prop 65	⚠ WARNING: Cancer and reproductive harm - http://www.p65warnings.ca.gov .
SCIP Number	a3b4e2e1-63ea-439e-a89a-743225502a7d
Termination	Lead (SnPb)
AEC-Q200	No
Construction	Molded
Notes	Longest Lead Is Positive.
Shelf Life	156 Weeks

Dimensions

W	8.26mm +/-0.38mm
H	8.26mm +/-0.38mm
T	4.32mm +/-0.38mm
S	5.08mm +/-0.127mm
LL	12.7mm +/-3.18mm
F	0.64mm +/-0.03mm
E	1.57mm +/-0.25mm
G	0.38mm +/-0.13mm

Specifications

Capacitance	4.7 uF
Capacitance Tolerance	10%
Voltage DC	35 VDC (85C), 23 VDC (125C), 0.35 VDC (125C Reverse)
Temperature Range	-55/+125°C
Dissipation Factor	6%
Leakage Current	1 uA

Packaging Specifications

Packaging	Bulk, Bag
Packaging Quantity	200

Statements of suitability for certain applications are based on our knowledge of typical operating conditions for such applications, but are not intended to constitute - and we specifically disclaim - any warranty concerning suitability for a specific customer application or use. This information is intended for use only by customers who have the requisite experience and capability to determine the correct products for their application. Any technical advice inferred from this information or otherwise provided by us with reference to the use of our products is given gratis, and we assume no obligation or liability for the advice given or results obtained.