



Operating the thermal transfer printer **THERMOMARK ROLLMASTER**

User manual

User manual

Operating the thermal transfer printer

THERMOMARK ROLLMASTER

UM EN THERMOMARK ROLLMASTER, revision 00

2017-06-15

This user manual is valid for:

Designation	Revision	Order No.
THERMOMARK ROLLMASTER 300		0804501
THERMOMARK ROLLMASTER 600		0804663

Table of contents

1	For your safety	5
1.1	Labeling of warning notes	5
1.2	Qualification of users	5
1.3	Field of application.....	6
1.4	Safety notes.....	6
2	Starting up the printer	8
2.1	Unpacking and setup	8
2.2	Overview of the device	9
2.3	Connecting device	10
2.3.1	Connecting the power supply unit	10
2.3.2	Connecting a printer via USB	11
2.3.3	Connecting a printer via WLAN	12
2.3.4	Connecting a printer via Ethernet	12
2.4	Loading media and printing	13
2.4.1	Loading media	13
2.4.2	Inserting Leporello labels	14
2.4.3	Loading ink ribbon	15
2.4.4	Printing	16
2.4.5	Creating print jobs	16
3	Operating the printer	17
3.1	Touchscreen display.....	17
3.1.1	Operating the display	17
3.1.2	Changing the language	17
3.1.3	Start screen	18
3.2	Operation via the menu.....	18
3.3	Configuration via the website.....	25
3.4	Printing via FTP	26
3.4.1	FTP login	26
3.4.2	Printing via FTP	26
3.4.3	FTP access to storage media	27
3.4.4	FTP firmware update	27

4	Maintenance and troubleshooting	28
4.1	Cleaning the device	28
4.2	Cleaning the photoelectric barrier for labels.....	28
4.3	Cleaning the printhead and pressure roller	29
4.4	Replacing the pressure roller	30
4.5	Troubleshooting.....	31
4.6	Error messages	32
4.7	Repairs	33
4.8	Storage and disposal	33
A	Appendix	34
A 1	Ordering data.....	34
A 2	Technical data	37
A 3	FCC	38
B	Index.....	39

1 For your safety

Read this user manual carefully and keep it for future reference.

1.1 Labeling of warning notes



This symbol indicates hazards that could lead to personal injury. There are three signal words that indicate the severity of a potential injury.

DANGER

Indicates a hazard with a high risk level. If this hazardous situation is not avoided, it will result in death or serious injury.

WARNING

Indicates a hazard with a medium risk level. If this hazardous situation is not avoided, it could result in death or serious injury.

CAUTION

Indicates a hazard with a low risk level. If this hazardous situation is not avoided, it could result in minor or moderate injury.



This symbol together with the **NOTE** signal word alerts the reader to a situation which may cause damage or malfunction to the device, hardware/software, or surrounding property.



Here you will find additional information or detailed sources of information.

1.2 Qualification of users

This user manual is addressed to persons who are familiar with the relevant safety concepts for handling electrical machines. The persons must be able to recognize dangers.

1.3 Field of application

The THERMOMARK ROLLMASTER is a thermal transfer printer for the industrial sector. With the thermal transfer printer, you can print continuous media such as labels and shrink sleeves.

With thermal transfer printing, heat causes the color layer of an ink ribbon to be transferred onto the print media.

The print result essentially depends on a suitable combination of print media and ink ribbon. A low-quality ink ribbon can lead to premature wear on the printhead and result in a poor print image. Use only print media from Phoenix Contact.

You may only use the thermal transfer printer with print media from Phoenix Contact which are intended for the THERMOMARK ROLLMASTER. The use of other media can result in damage to the unit.

1.4 Safety notes

Life-threatening danger from mains voltage

Never open the housing of the unit or power supply unit.

Risk of injury

If you operate the device with the cover open, rotating parts are exposed. The moving parts can catch onto loose clothing, jewelry or hair.

Risk of crush injuries from cover

Make sure you do not crush yourself with the cover.

Risk of burns

During operation, the print line can get hot. Allow the print line to cool down before you change the print media or modify the device.

Risk to operational reliability

Incorrect operation or modifications to the device can endanger your safety or damage the device. Do not repair the device yourself. If the device is defective, please contact Phoenix Contact.

Damage to the device

- Only operate the device in dry locations that are protected from spray and as dust-free as possible.
- Protect the device and media from humidity, damp, and dirt.
- Do not expose the device to direct sunlight.
- To operate the device on the power grid, only use the supplied wide-range power supply unit. The device is designed for alternating voltage from 100 V to 240 V. The electrical connection conditions must comply with the details on the rating plate.

Radio interference

This is a Class A item of equipment (EN 55022). When used in residential areas, the equipment may cause radio interference. In this case, the operator is obligated to implement appropriate measures.

Notes on the printhead

The printhead is the most sensitive part of your printer. Improper handling can damage the printhead.

During printing, always make sure that there is no dirt on the media as this could be pulled underneath the printhead. This can damage the printhead.

The ink ribbon must be at least 5 mm wider than the media. Direct contact between the printhead and the media can lead to increased wear on the printhead.

2 Starting up the printer

2.1 Unpacking and setup

Scope of supply

- Printer
- Power cable (Euro and US)
- USB cable
- WLAN stick
- Empty film core (possibly already mounted on the take-up hub)
- Label roll EML (20X8)R/TL
- THERMOMARK RIBBON 110/50 ink ribbon
- Data medium with driver and the CLIP PROJECT advanced software. The data medium also contains this user manual in several languages
- User manual in German and English

Unpacking

- Check the device for damage which may have occurred during transport.
- Retain the original packaging for subsequent transport.

Requirements for the installation location

**NOTE: Damage to the device**

Only operate the device in dry locations that are protected from spray and as dust-free as possible. Protect the device and media from humidity, damp, and dirt. Do not expose the device to direct sunlight.

- Place the device on a level surface.

Removing the transportation safeguards

- Open the cover.
- **Remove the foam transportation safeguards near the printheads.**
- Retain the transportation safeguard for subsequent transport.

2.2 Overview of the device

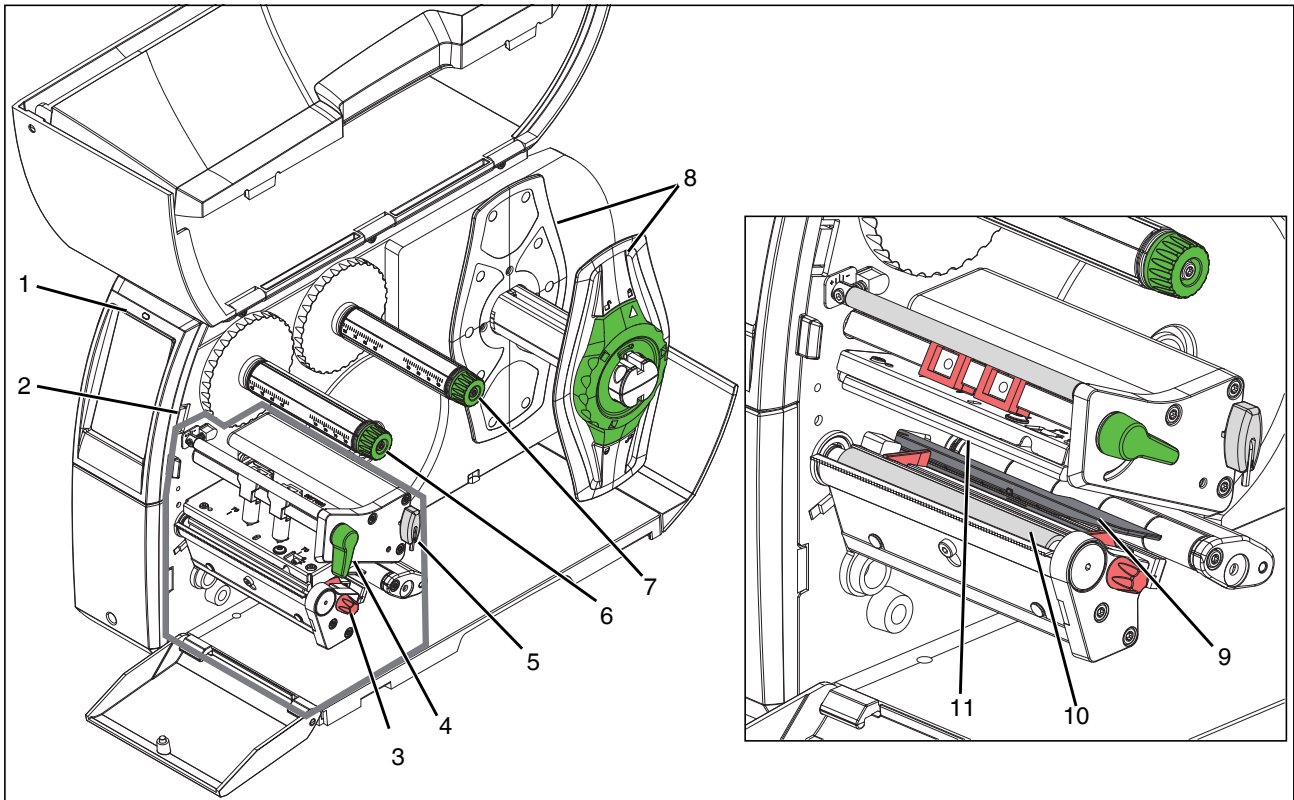

Figure 2-1 Overview

- 1 **Display**, lights when ready to operate
- 2 **WLAN connection**, behind a cover
- 3 **Guide**, can be set to the width of the print media
- 4 **Lever**, for locking printhead
- 5 **Allen key**, for maintenance work
- 6 **Take-up hub**, for winding the ink ribbon
- 7 **Supply hub**, for supplying the ink ribbon
- 8 **Margin stop**, for fastening the media roll
- 9 **Photoelectric barrier**, for label detection
- 10 **Pressure roller**
- 11 **Print line**

2.3 Connecting device

Mains and computer connections

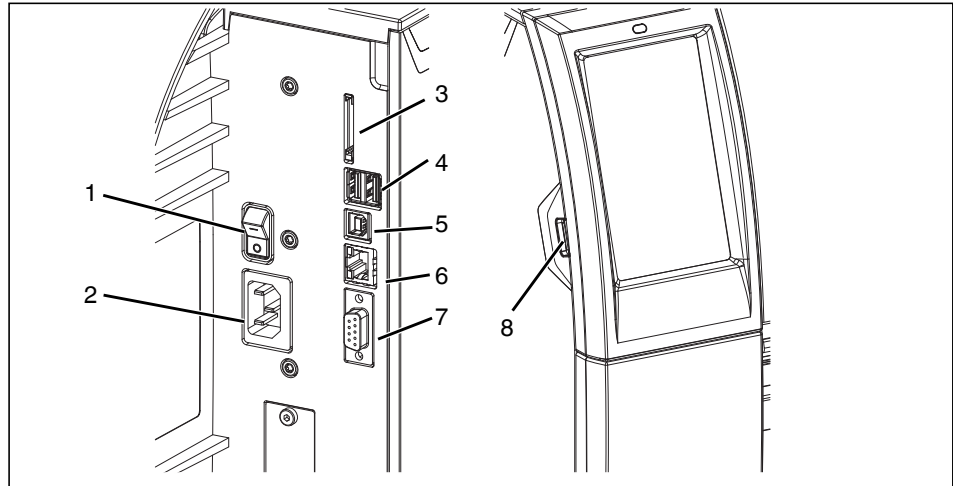

Figure 2-2 Connections on the rear of the device

- 1 Power supply switch
- 2 Mains socket
- 3 SD card slot
- 4 Two USB master interfaces for keyboard, scanner, USB memory and Bluetooth adapter
- 5 USB slave interface, full-speed
- 6 Ethernet 10/100 Base T
- 7 RS-232 interface
- 8 USB master interface for keyboard, scanner, USB memory and Bluetooth adapter

Ensure that when establishing electrical connections, all devices (printer, computer etc.) are switched off. If you disconnect devices, the devices should again be switched off.

2.3.1 Connecting the power supply unit

The THERMOMARK ROLLMASTER is designed for power grids from 100 to 240 V AC. Only use the supplied wide-range power supply unit.

- Slide the appropriate adapter onto the power supply unit.
- Insert the connecting cable of the power supply unit into the socket of the device.
- Connect the power supply unit to a socket.

2.3.2 Connecting a printer via USB



NOTE: Errors during operation due to insufficient or missing shielding
Ensure that all the connection cables connected to the device are shielded.

A driver must be installed if a USB interface is to be used for connection. You will find the driver on the data carrier that is supplied within the scope of delivery or on the Internet at phoenixcontact.net/qr/0804501.

- Switch on the computer.
- Exit all programs that are currently running.
- Switch on the device.
- Connect the computer and device with the supplied USB cable.
- Insert the data carrier containing the driver software. A window opens automatically. You can select the language at the top right of this window.
- Click on "Install".
- Follow the on-screen instructions.

Following successful installation, an icon for the THERMOMARK ROLLMASTER "TRM 300" or "TRM 600" appears in the Windows "Devices and Printers" system folder.

- Open the CLIP PROJECT marking software.
- Open "File, Print Setup" and under "Thermo, THERMOMARK ROLLMASTER", create a new device.

You can find instructions on CLIP PROJECT marking at phoenixcontact.net/qr/5146040.

- Set up the device in CLIP PROJECT marking.

2.3.3 Connecting a printer via WLAN

Installing a WLAN stick

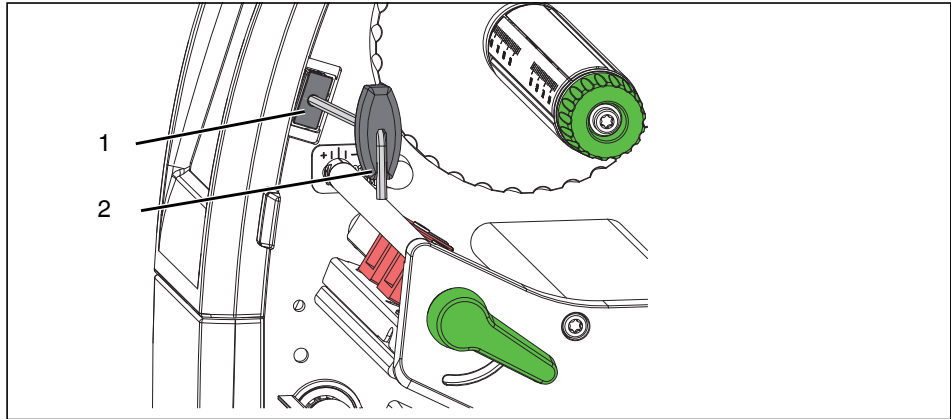

Figure 2-3 Installing a WLAN stick

- Remove the cover (1) with the Allen key (2).
- Insert the WLAN stick into the USB interface on the right of the display.

Setting up the WLAN connection

- Activate the WLAN interface via the menu (see page 21).
- Select Access Point. The search for available access points starts. The available access points, including hidden access points, are shown on the display.
- Select the access point. To use a hidden access point, enter its SSID.
- Assign the addresses (DHCP or IP address, subnet mask and gateway).
When you configure a WLAN connection via the website, do not change the "IP" and "Gateway" parameters. Otherwise the connection with the printer will be lost.
- For protected networks, the network key is requested. Enter the network key. The connection is established. Network name and IP address are displayed.

2.3.4 Connecting a printer via Ethernet

To connect a printer via the Ethernet interface, use a cable with RJ45 plugs for 10Base-T or 100Base-T. Always use a shielded cable.

- Connect the printer to a network socket or a computer.
- Set up the Ethernet interface via the menu (see page 21).

When you configure a WLAN connection via the website, do not change the "IP" and "Gateway" parameters. Otherwise the connection with the printer will be lost.

2.4 Loading media and printing

2.4.1 Loading media

Positioning media roll on the media hub

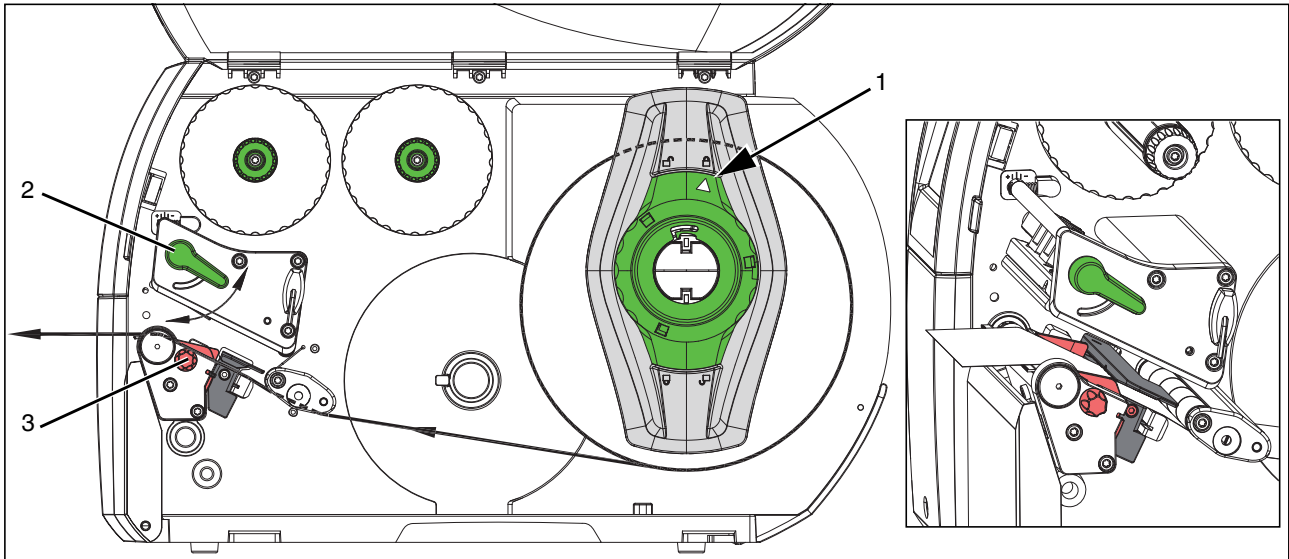



Figure 2-4 Inserting media roll

Inserting media roll

- Open the cover.
- Release the margin stop (1). To do this, turn the green adjustable ring counterclockwise until the arrow points to the  symbol.
- Pull the margin stop out of the media hub.
- Push the media roll onto the media hub in such a way that the media side to be printed faces upwards.
- Put the margin stop back on. Push it until both margin stops are touching the media roll. Here a definite resistance can be felt when pushing.
- Clamp down the margin stop. To do this, turn the adjustable ring clockwise until the arrow points to the  symbol.
- Unwind a lengthy strip of the print media.

Loading media into the printhead

- To lift the printhead, turn the green lever (2) counterclockwise.
- Turn the red knurled screw (3) until the media fits between the red guides.
- Push the media toward the printing unit.
- Move the guides close to the edges of the media. The print media must not get stuck, however.
- Close the printhead.

2.4.2 Inserting Leporello labels

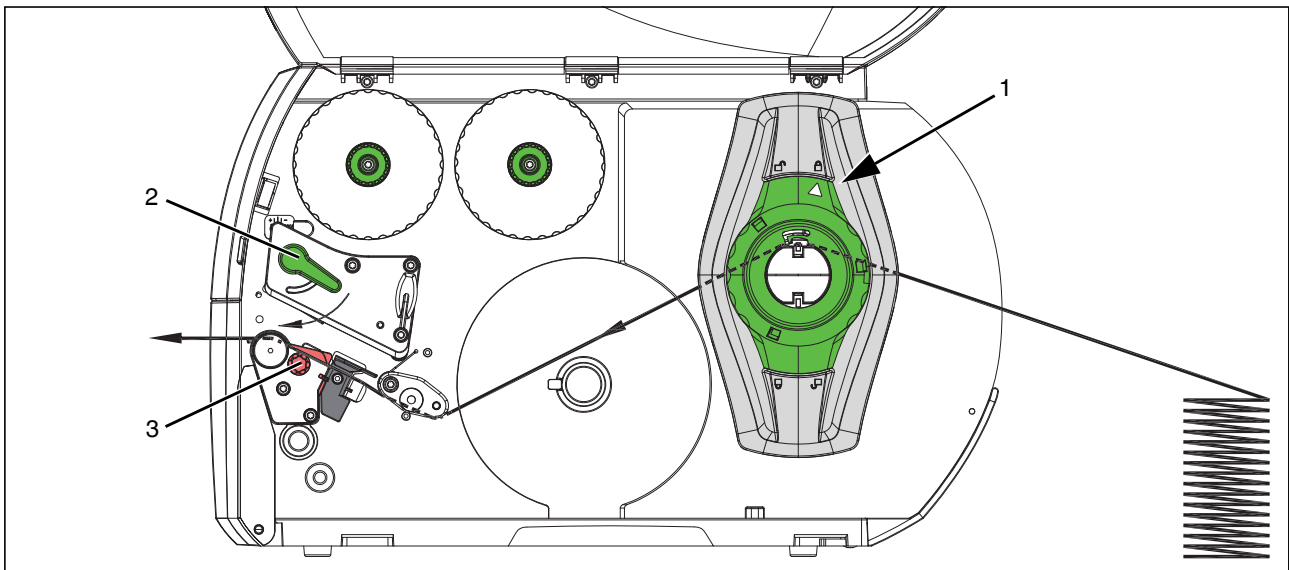



Figure 2-5 Media feed path with Leporello labels

Inserting Leporello labels

- Open the cover.
- Release the margin stop (1). To do this, turn the green adjustable ring counterclockwise until the arrow points to the  symbol.
- Position the margin stop in such a way that the media fits between the two margin stops.
- Place the label stack behind the printer. Make sure that the media side to be printed is facing upwards.
- Guide the Leporello labels over the holder for the media roll
- Check the position of the margin stop. The media must make contact on both sides without getting clamped.
- Clamp down the margin stop. To do this, turn the adjustable ring clockwise until the arrow points to the  symbol.

Loading media into the printhead

- To lift the printhead, turn the green lever (2) counterclockwise.
- Turn the red knurled screw (3) until the media fits between the red guides.
- Push the media toward the printing unit.
- Move the guides close to the edges of the media. The print media must not get stuck, however.
- Close the printhead.

2.4.3 Loading ink ribbon

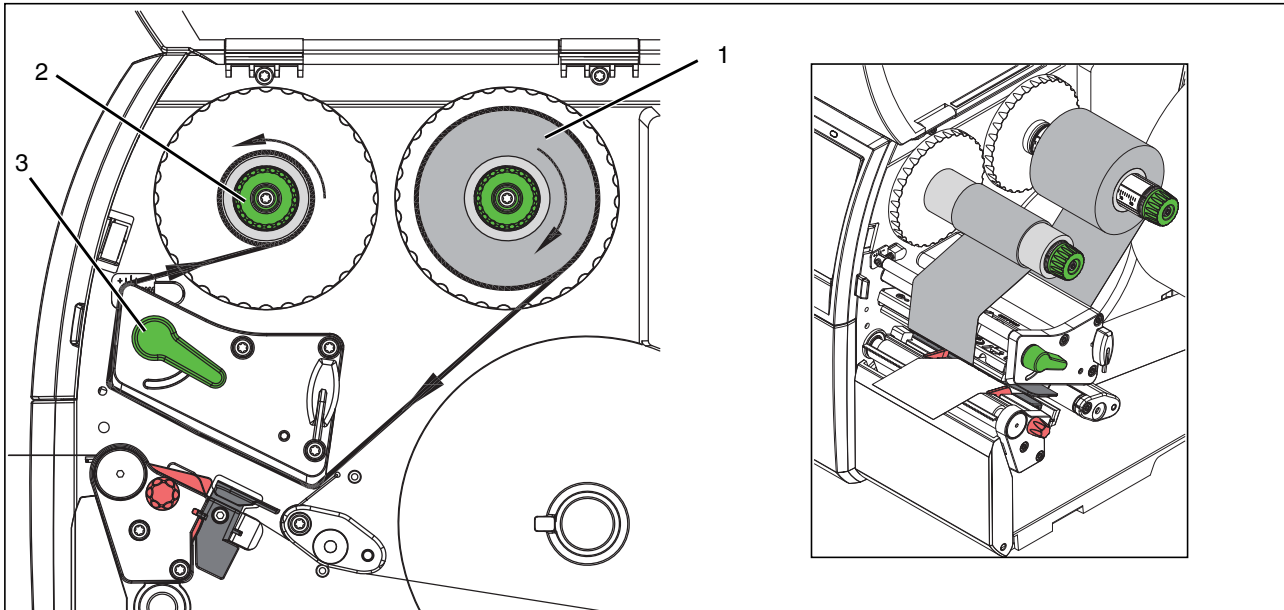

Figure 2-6 Feed path of the ink ribbon

Loading the ink ribbon

- To lift the printhead, turn the green lever (3) counterclockwise.
- Push the ink ribbon roll onto the supply hub (1) so that the color coating of the film faces downwards during unwinding.
The ink ribbon rolls for this printer from Phoenix Contact have the color coating on the outside of the winding. Observe the unwinding direction shown in Figure 2-6. **If the color coating is positioned incorrectly, the film will stick to the printhead.**
- Align the ink ribbon in the center using the printed scales.
- Fix the ink ribbon roll in place on the supply hub. To do this, hold the ink ribbon roll in place. Then turn the green knob counterclockwise.
- Push the empty core of an ink ribbon roll onto the take-up hub (2) and fix it in place.
- Guide the ink ribbon through the printing unit as shown in Figure 2-6.
- Fix the start of the ink ribbon onto the take-up hub with adhesive tape. Observe the counterclockwise running direction of the take-up hub.
- To tighten the feed path of the ink ribbon, turn the take-up hub counterclockwise.
- To close the printhead, turn the green lever clockwise.

2.4.4 Printing

The THERMOMARK ROLLMASTER is ready for operation when all connections have been established, the media and ink ribbon have been loaded, and the printhead is locked.

Tear-off plate

After the printing has been completed, the media strips are detached by hand. For this purpose, the printer is equipped with a tear-off plate.

Cutter or perforator

A cutter which automatically cuts off labels is available as an accessory (THERMOMARK ROLLMASTER-CUTTER, 0804502).

A perforator is available for shrink sleeves (THERMOMARK ROLLMASTER-CUTTER/P, 0804503).

2.4.5 Creating print jobs

Create the print jobs using the CLIP PROJECT marking software.

CLIP PROJECT marking can be used to create markings on a computer, which are tailored to the Phoenix Contact marking material.

Select the THERMOMARK ROLLMASTER as the output device. You will be provided with a list of media that are suitable for this device.

The CLIP PROJECT marking software is supplied with the device. CLIP PROJECT marking can also be downloaded at phoenixcontact.net/qr/5146053.

3 Operating the printer

3.1 Touchscreen display

You can use the touchscreen to change the basic settings of the printer, for example:

- Pausing, continuing or canceling print jobs
- Configuring interfaces
- Setting language and time
- Updating the firmware



Use only CLIP PROJECT software to modify print jobs.

3.1.1 Operating the display

- To select a menu item, briefly touch the corresponding symbol.
- Move your finger up and down the display to scroll the list.

3.1.2 Changing the language

The language is set at the initial startup of the printer. To later select a different language, proceed as follows:



- Touch this symbol.



- Touch this symbol.









- Touch this symbol.



- Touch this symbol.
- Touch the desired language.

3.1.3 Start screen

-  Open menu
-  Pause print job
-  Continue print job
-  Repeat print job
-  Delete all print jobs
-  Feed an empty label forward

3.2 Operation via the menu

Table 3-1 Menu structure























	Menu	Setting option	Default
	Information about the printer	Printer type, version number and firmware creation date, serial number of CPU, operating time and number of printed labels, printed length, IP and MAC addresses	–
	Access to the storage medium		–
	Only visible when an external storage medium is present		–
		Open saved print jobs from an external storage medium (SD card, USB stick)	–
		Create list of files available on an external storage medium (SD card, USB stick)	–
		Copy files between different storage media (SD card, USB stick)	–
	Select default storage medium	Specify storage medium to be accessed via the interfaces and FTP management. For other functions, all storage media can be selected but the default storage medium is offered first.	USB storage
	External storage media <ul style="list-style-type: none"> – USB storage – SD cards Internal storage media <ul style="list-style-type: none"> – Approx. 50 MB flash drive in the printer (IFFS) 		

Table 3-1 Menu structure

	Menu	Setting option [...]	Default
		<p>Settings</p> <p>Changing printing parameters</p> <p> Set heat level When the printing quality is inadequate, you can change the value. We recommend first raising the heat level via CLIP PROJECT (at: "File, Print Setup"). Only change the setting in the printer after this has been done. It results in an additional increase.</p> <p> Move print position horizontally This can also be modified via CLIP PROJECT (at: "File, Print Setup"). The values from the printer and from CLIP PROJECT are added together.</p> <p> Move print position vertically This can also be modified via CLIP PROJECT (at: "File, Print Setup"). The values from the printer and from CLIP PROJECT are added together.</p> <p> Print on request Off: The next label is printed immediately On: The next label will only be printed when the corresponding button is pressed on the touchscreen.</p> <p> Repeat print by pressing the button There are several setting options. You can repeat the identical print job or first query the variable data</p>	<p>0</p> <p>0.0 mm</p> <p>0.0 mm</p> <p>Off </p> <p>Edit</p>
		<p>Label detection</p> <p> Change procedure for detection of label sensor If you are printing with media from Phoenix Contact, no adjustment is necessary. Continuous media is automatically detected</p> <p> Extrapolate labels This functions prevents the first labels from remaining un-printed. In the default setting, this function is on.</p>	<p>Gap sensor</p> <p>On </p>
		<p>Warning before end of ink ribbon</p> <p> Switch on/off the warning that the ink ribbon is almost at its end If the remaining diameter of the ink ribbon roll is 32 to 74 mm, a warning appears on the display</p>	<p>Off </p>

THERMOMARK ROLLMASTER

Table 3-1 Menu structure































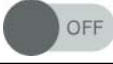



	Menu	Setting option [...]	Default	
		Changing tear-off mode and position		
			Position of the label media for tearing off on the tear-off plate On: After the last printed label, the label gap is positioned on the tear-off plate Off: Label feed stops once the last label has completely passed the print line	On 
			Shift tear-off position If this value is positive, the label is transported further out of the printer.	0.0 mm
		Cutting settings Only visible when a cutter or perforator is present		
			Shift cutting position (reference: rear edge of label)	0.0 mm
			Increase perforation degree	0

Table 3-1 Menu structure

	Menu	Setting option [...]	Default	
		Setting up interfaces		
		Ethernet setup		
			Enter host name	phoenix...
			DHCP, method of assigning IP address On: Dynamic assignment of IP address by the DHCP server Off: Direct assignment of IP address by the operator	On 
			Enter IP address IP address of the label printer. Only valid when no DHCP server is active	-
			Enter network mask Subnet mask of local network	-
			Switch on gateway Connection between local and other networks	Off 
		Setting up WLAN		
		Only visible when a WLAN stick is inserted		
			Activate WLAN interface	Off 
			Search and selection of access point to be used to establish the WLAN connection	-
			DHCP, method of assigning IP address On: Dynamic assignment of IP address by the DHCP server Off: Direct assignment of IP address by the operator	On 
		Network services		
			Website Activate the HTTP protocol for access to the printer-internal website (see „Configuration via the website“)	On 
		Printer behavior in case of error messages		
			On: After an error message the last label is repeated Off: After an error message the next label is printed	On 
		Printer goes into error status when there are problems with the network connection	On 	

THERMOMARK ROLLMASTER

Table 3-1 Menu structure







































	Menu	Setting option [...]	Default
		Setting language and country	
		 Set language	English
		 Set country Setting of the country-specific date and time formats	Germany
		 Set keyboard layout when using an external keyboard When you select the automatic setting, the keyboard setting depends on the setting of the „Set country“ parameter.	Automatic
		Setting time and date	
		 Set time zone. The time zone is indicated in reference to UTC.	UTC+1
		 Select the daylight savings time of a region. The time is automatically reset	EU
		 Set date in the DD.MM.YYYY format The print output of the date is in the format set via the „Set country“ parameter.	–
		Adjusting the display	
		 Adjust brightness of the display	8
		Test print	
		 Test print on EML(20x8)R	–

Table 3-1 Menu structure

	Menu	Setting option [...]	Default
	Security		
		Activate PIN protection, password for protection of print parameter changes via the display (default: 0000)	Off
		Password for printing via FTP (see page 26) FTP login as ftpprint	print
		Password for FTP access to a storage medium, such as a USB stick, SD card, IFFS FTP login as ftpcard	card
		Password for FTP firmware update FTP login as ftpadmin	admin
		Password for setting parameters via the website Login as admin	admin
	Extras		
		Update firmware Copy firmware file into the /misc directory of the storage medium. Insert storage medium into the printer. Then click on this button. Select a file. The printer re-starts after the update.	-
		Save your settings Save current printer configuration as an .xml file on a storage medium	-
		Load settings Load printer configuration from a storage medium onto the printer	-
		Restore settings With the exception of the passwords, all configuration settings are reset to the default values	-
		Set cleaning interval Message for printhead cleaning when a specified amount of the media has been used up. The message is not displayed until the ink ribbon or the media has also been used up. Confirm the message "Clean printhead". Thereafter, the error message for the error that occurred is displayed.	1000 m
		Licenses and software libraries for the third-party components used in the firmware	-

THERMOMARK ROLLMASTER

Table 3-1 Menu structure

	Menu	Setting option [...]	Default
	Watching help videos		
		Video on how to load the ink ribbon	–
		Video on how to load the print media	–
		Video on how to install the cutter	–
		Video on how to change the pressure roller	–
		Video on maintenance	–
		Video on firmware update	–

3.3 Configuration via the website

All the parameters which are accessible via the display can also be configured via a website. The website is contained in the printer's firmware. Use a browser (e.g. Microsoft Internet Explorer or Mozilla Firefox) with activated JavaScript.

Access the website via the Ethernet or WLAN interface.

Opening website

To configure settings via the website, you must enter the user name "admin" and a password. The default value for the password is also "admin".

You can change the password via the website.

- Start the browser.
- Open the website. Enter the IP address via HTTP (e.g. `http://192.168.9.10`).
A start screen appears.
- Click on the buttons with the mouse. In this way, you can operate the printer just like with the touchscreen on the device.
- You can use the computer keyboard to enter variable printing data, for example. To do this, select the printer display with the mouse.

Tabs on the website

The structure of the website corresponds to the menu structure of the printer.

- Reading status of printer
- Setting configuration parameters which are also accessible via the display in the „Settings“ menu (see page 19)
- Setting passwords
- Viewing lists of hardware and optional components
- Viewing overview of available fonts
- Opening auxiliary functions

3.4 Printing via FTP

With the File Transfer Protocol (FTP), you can manage and transfer files in the network via the Ethernet or WLAN interface. For printer management, you need an FTP program (FTP client) which supports the “binary” transfer mode. The printer acts as an FTP server.

The FTP printer management has four functions:

- Direct printing by copying from JScript or ZPL files
- Management of the storage media installed on the label printer
- Management of the internal printer storage IFFS
- Firmware update

3.4.1 FTP login

To establish an FTP connection, the client must be logged in to the server. The type of login depends on the client. You must enter the following information in all cases:

- IP address of the printer
- User name and password

Access to the printer management functions depends on the user name:

Table 3-2 Factory-default passwords

Function	User name	Default password ¹
Printing via FTP	ftpprint	print
Access to storage medium via FTP	ftpcard	card
Firmware update via FTP	ftpadmin	admin

¹ Change the passwords via the printer menu (see page 23).

After logging in, you can access the FTP server in the same way you would a Windows folder.

3.4.2 Printing via FTP

You can print out the print data in JScript format or in ZPL format via an FTP connection.

- Establish an FTP connection with the printer with the user name ftpprint and the specified password (default: print). An empty folder of the FTP server is displayed.
- Copy the label file in JScript or the ZPL format into the folder of the FTP server. The label file starts printing immediately. After the print job is complete, the associated file is automatically deleted.
- End the FTP connection.

3.4.3 FTP access to storage media

Via FTP, you can edit files that are available on an installed storage medium.

- Establish an FTP connection with the printer with the user name ftpcard and the specified password (default: card).
The content of the storage medium is displayed. The files are divided into several subfolders by file type.
- Edit the files as necessary. When you copy files onto the FTP server, the files are automatically sorted into subfolders by file type.
- End the FTP connection.

3.4.4 FTP firmware update

You can carry out a firmware update via FTP.

- Establish an FTP connection with the printer with the user name ftpadmin and the specified password (default: admin). An empty folder of the FTP server is displayed.
- Copy a valid firmware file (e. g. 500_6714.cfw) into the folder of the FTP server.
While the firmware is being copied, a progress indicator appears on the display. After copying has been completed, the printer automatically re-starts.
- End the FTP connection.

You can check in the status display whether the firmware update was successful.

4 Maintenance and troubleshooting



DANGER: Risk of electric shock

Disconnect the device from the power grid before carrying out any maintenance work.

4.1 Cleaning the device

- Protect the device from dust and other contaminants. If the device is not being used, cover it.
- Wipe down the device with a duster. The duster can either be dry or dampened with a mild cleaning agent.
- Remove dust and paper fluff in the printing area with a soft brush or vacuum cleaner.

4.2 Cleaning the photoelectric barrier for labels

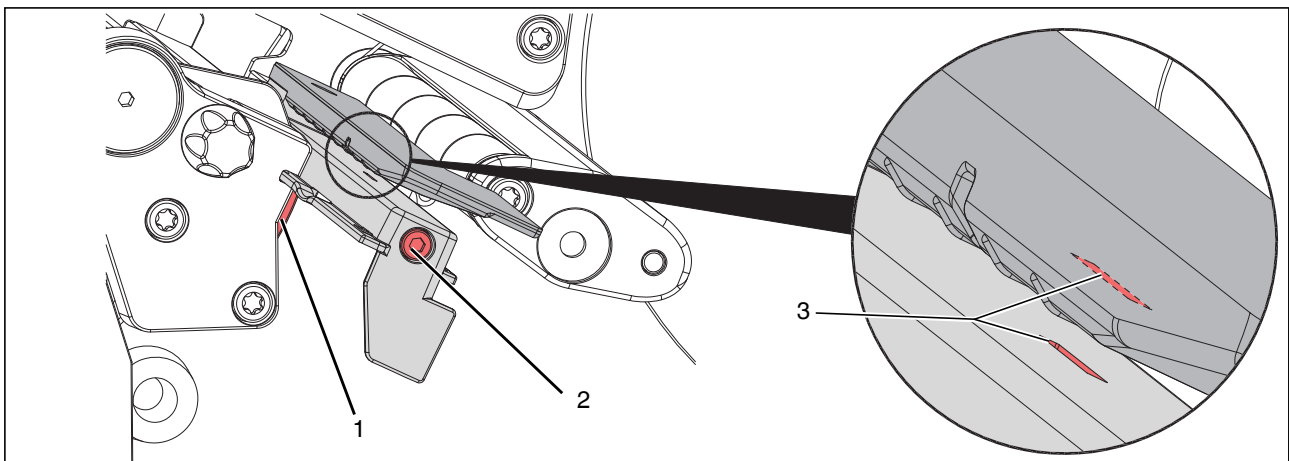

Figure 4-1 Cleaning photoelectric barrier for labels

- Remove the print media and the ink ribbon from the printer.
- Loosen the screw (2) with the supplied Allen key.
- Press and hold down the button (1).
- Slowly pull the photoelectric label barrier outwards by the handle. Make sure not to tension the photoelectric barrier cable.
- Clean the photoelectric label barrier and the sensor slit (3) with a cotton bud that has been soaked with alcohol.
- Hold the photoelectric label barrier by the handle and push it back as far as it will go.
- Retighten the screw.
- Reload the print media and the ink ribbon.

4.3 Cleaning the printhead and pressure roller

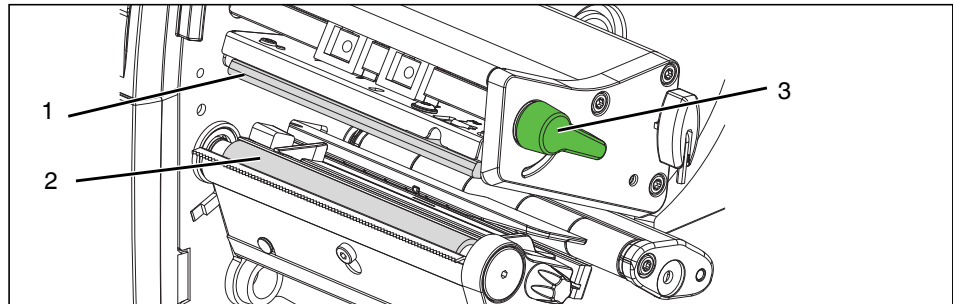

Figure 4-2 Cleaning the printhead line and pressure roller

During printing, dirt can collect on the printhead and reduce the print quality.

Dirt on the pressure roller can adversely affect the print image and interfere with media transport.



WARNING: Risk of burns

The print mechanism can become hot during printing. Do not touch it during operation and let it cool down before changing media or removing and adjusting components.



NOTE: Damage to the printhead

- Do not use sharp items (knives, screwdrivers etc.) to clean the printhead.
 - The printhead has a protective layer at the top. Do not touch this protective layer with your hand.
- Switch off the device.
 - Make sure that the print mechanism has cooled down.
 - To lift the printhead, turn the green lever (3) counterclockwise.
 - Remove the print media and the ink ribbon from the printer.
 - Clean the printhead line (1) with a cotton bud that has been soaked with alcohol.
 - Remove the deposits on the pressure roller (2) with a cloth that has been soaked with pure alcohol.
 - Let the printhead dry for 2 to 3 minutes.

4.4 Replacing the pressure roller

Poor quality printing may result if the pressure roller is damaged or worn. In this case, you must replace the pressure roller.



If large amounts of sleeve media are to be processed, it may lead to denting in the pressure roller. The pressure roller often recovers after a few hours.

We recommend using separate pressure rollers for sleeves and for labels.

- Pressure roller, standard, TRM-PRESSURE ROLLER STANDARD, 0804655
- Pressure roller for continuous shrink sleeve, TRM-PRESSURE ROLLER 4-50, 0804656

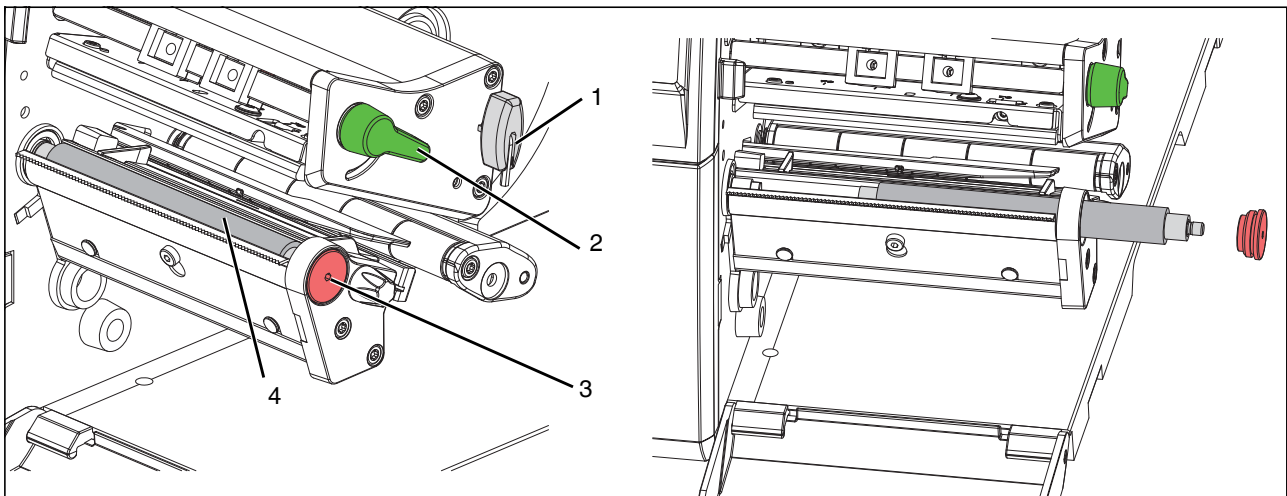

Figure 4-3 Removing and fitting the pressure roller

Removing and fitting the pressure roller

- To lift the printhead, turn the green lever (2) counterclockwise.
- Remove the print media and the ink ribbon from the printer.
- Loosen the screw on the pressure roller (3) with the supplied Allen key (1).
- Remove the pressure roller (4) and replace it.
- Retighten the screw.
- Reload the print media and the ink ribbon.

4.5 Troubleshooting

Table 4-1 Troubleshooting

Problem	Cause	Remedy	Page
Ink ribbon wrinkles	Printhead is dirty	Clean printhead	29
Print image is blurred or missing in places	Printhead is dirty	Clean printhead	29
	Pressure roller is dirty	Clean pressure roller	29
	Pressure roller damaged	Replace pressure roller	30
	Temperature too high	Reduce temperature via the display	
Printer transports the labels but they are not printed.	Ink ribbon not loaded correctly	Correct feed path of ink ribbon	15
Printer feeds the print media but not the ink ribbon	Ink ribbon is not loaded correctly	Load ink ribbon	15
	Unfavorable combination of ink ribbon and media	Check suitability of ink ribbon for the media	–
Printer only prints every second label	Format set too large in the software	Change format in CLIP PROJECT	–
Vertical white lines in the print image	Printhead is dirty	Clean printhead	29
	Printhead is defective	Contact Phoenix Contact	–
Print image lighter on one side	Printhead is dirty	Clean printhead	29

4.6 Error messages

Table 4-2 Troubleshooting

Error message	Cause	Remedy	Page
"Printhead open"	Printhead is open.	Close printhead.	13
"Printhead too hot"	Printhead is too hot.	The print job continues automatically after a pause.	–
"Out of ribbon"	Ink ribbon used up.	Load new ink ribbon.	15
	Ink ribbon melted during printing.	Cancel print job. Clean printhead Load ink ribbon. Re-start print job.	29 15
	Ink ribbon supply roll is not secured to the ribbon supply hub.	Secure ink ribbon roll.	15
"No label found"	There are several labels missing on the media.	Press the  pause button repeatedly until printer recognizes the next label.	–
	The label size defined in the format sent to the printer does not match the actual media size	Cancel print job. Change label format in CLIP PROJECT. Re-start print job	–
"Cutter jammed"	Cutter does not cut through media, but can return to initial position	Cancel print job. Load new print media.	–
"Cutter blocked"	Cutter remains stuck in the print media.	Switch off printer. Remove jammed media.	–
	No cutter function	Switch printer off and on again. If this problem occurs again, contact Phoenix Contact.	–
"Out of paper"	Label roll or shrink sleeve has been used up.	Load media (see page 13)	13
	Error in media flow	Check media flow.	13
"Voltage error"	Hardware fault	Switch printer off and on again. If this problem occurs again, contact Phoenix Contact.	–
"Syntax error"	Printer has received an unknown or incorrect command.	Skip command or cancel print job.	–

4.7 Repairs



WARNING: Risk to operational reliability

Incorrect operation or modifications to the device can endanger your safety or damage the device. Do not repair the device yourself. If the device is defective, please contact Phoenix Contact.

4.8 Storage and disposal

Transporting the device

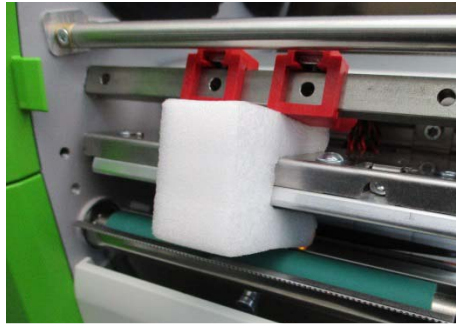

Figure 4-4 Mount transportation safeguards near printheads

- **Attach the foam transportation safeguards near the printheads.**
- Remove the print media and the ink ribbon.
- Package the device in the original packing for shipping.

Storage

- Only store the device in dry surroundings.
- Store the device in such a way as to avoid any potential damage.
- Store the device complete with individual parts and accessories. Otherwise, key components could be missing when restarting.

Disposal



The device contains valuable recyclable materials, which should be utilized. The electronic circuit board is fitted with a lithium battery. Dispose of the device separately from other waste, i.e., via an appropriate collection site.

A Appendix

A 1 Ordering data

Thermal transfer printer

Description	Type	Order No.	Pcs./Pkt.
Thermal transfer printer for labels and shrink sleeve, including connecting leads, Windows printer driver and marking software, 300 dpi	THERMOMARK ROLLMASTER 300	0804501	1
Thermal transfer printer for labels and shrink sleeve, including connecting leads, Windows printer driver and marking software, 600 dpi	THERMOMARK ROLLMASTER 600	0804663	1

Accessories

Description	Type	Order No.	Pcs./Pkt.
Cutter	THERMOMARK ROLLMASTER-CUTTER	0804502	1
Perforator	THERMOMARK ROLLMASTER-CUTTER/P	0804503	1
Adapter screw for using the existing THERMOMARK X1.2 CUTTER und THERMOMARK X1.2 CUTTER/P	TRM-ADAPTER SCREW	0804653	1
External media hub , for roll diameters of 150 to 400 mm	THERMOMARK ROLL-ERH	5146448	
External media hub , for roll diameters of up to 500 mm	THERMOMARK-ERH 500	5146309	
Pressure roller , standard	TRM-PRESSURE ROLLER STANDARD	0804655	
Pressure roller , for continuous shrink sleeve	TRM-PRESSURE ROLLER 4-50	0804656	
Transport case	THERMOMARK ROLLMASTER-CASE	0804643	1

Ink ribbon

Description	Type	Order No.	Pcs./Pkt.
Ink ribbon , length: 50 m, width: 110 mm, color: black	THERMOMARK-RIBBON 110/50	0800687	1
Ink ribbon , length: 240 m, width: 110 mm, color: white	TM-RIBBON 110-TC/TR WH	1014402	1
Ink ribbon , length: 300 m, width: 110 mm, color: black	THERMOMARK-RIBBON 110	5145384	1
Ink ribbon , length: 300 m, width: 110 mm, color: blue	THERMOMARK-RIBBON 110 BU	0829544	1
Ink ribbon , length: 300 m, width: 110 mm, color: green	THERMOMARK-RIBBON 110 GN	0829542	1

Ink ribbon

Description	Type	Order No.	Pcs./Pkt.
Ink ribbon , length: 300 m, width: 110 mm, color: red	THERMOMARK-RIBBON 110 RD	0829543	1
Ink ribbon , specifically for EMT, TMT, WMTB HF, length: 300 m, width: 110 mm, color: black	THERMOMARK-RIBBON 110-WMTB HF	5148007	1
Ink ribbon , specifically for WMTB HF, length: 300 m, width: 110 mm, color: white	TM-RIBBON 110-WMTB HF WH	0802990	1
Ink ribbon , for high-temperature EML-HT labels, length: 300 m, width 110 mm, color: black	THERMOMARK-RIBBON 110-EML-HT	0800342	1
Ink ribbon , specifically for WMS... shrink sleeves, length: 300 m, width: 110 mm, color: black	THERMOMARK-RIBBON 110-WMSU	0801358	1
Ink ribbon , specifically for WMS... shrink sleeves, length: 300 m, width: 110 mm, color: white	THERMOMARK-RIBBON 110-WMSU WH	0801359	1
Ink ribbon , specifically for WMS... shrink sleeves, length: 300 m, width: 64 mm, color: black	THERMOMARK-RIBBON 64-WMSU	0801360	1
Ink ribbon , specifically for WMS... shrink sleeves, length: 300 m, width: 64 mm, color: white	THERMOMARK-RIBBON 64-WMSU WH	0801361	1

Materials

Description	Type	Order No.	Pcs./Pkt.
Terminal block marker			
Markers for terminals blocks , mounting type: latching into universal marker groove, latching into flat marker groove	TMT ... R		1
Marking foil for zack marker strip, mounting type: adhesive	TML (..X..)R		1
Marker strip for terminal blocks, mounting type: adhesive	SK .. (..X..)R		1
Wire marking			
Cable marker , mounting type: adhesive	WML.. (..X..)R		1
Cable marker , halogen-free, mounting type: adhesive	WML HF .. (..X..)R		1
Cable marking flags	WML-FLAG .. (..X..)R		1
Insert label , mounting type: latching in marker carrier	EMT (..x..)R		1
Cable marker , mounting type: threading	WMT .. (..X..)R		1
Cable markers , mounting type: cable binder assembly	WMTB (..X..)R		1
Cable markers , halogen-free, mounting type: cable binder assembly	WMTB HF (..X..)R		1
Shrink sleeve	WMS .. (..X..)R		1
Shrink sleeve , halogen-free	WMS-2 HF .. (..X..)R		1
Equipment marking			
Labels , mounting type: adhesive	EML (..X..)R		1

THERMOMARK ROLLMASTER

Materials

Description	Type	Order No.	Pcs./Pkt.
Labels for sensitive components , mounting type: adhesive	EML-ESD (..X..)R		1
Labels for rough surfaces , mounting type: adhesive	EML-HA (..X..)R		1
Labels for high-temperature applications , mounting type: adhesive	EML-HT (..X..)R		1
Removable labels , mounting type: adhesive	EML-RM (..X..)R		1
Labels offering particular flexibility , adhesive over corners, mounting type: adhesive	EMLC (..X..)R		1
Labels offering particular flexibility , for rough surfaces, mounting type: adhesive	EMLF (..X..)R		1
Plastic label , mounting type: adhesive	EMLP (..X..)R		1
Safety label with special adhesive, mounting type: adhesive	EMLS (..X..)R		1
Insert label , mounting type: latching in marker carrier	EMT (..X..)R		1
Plant marking			
Hazardous substances label , mounting type: adhesive	PML-GHS100 (..X..)R		1
Mandatory label , mounting type: adhesive	PML-M.. (..X..)R		1
Prohibition sign , mounting type: adhesive	PML-P.. (..X..)R		1
Warning label , mounting type: adhesive	PML-W.. (..X..)R		1
Pipeline marker , mounting type: adhesive	PML-T.. (..X..)R		1
Magnetic sign , mounting type: magnetic adhesion,	PMM (..X..)R		1

A 2 Technical data

Printhead		THERMOMARK ROLLMASTER 300	THERMOMARK ROLLMASTER 600
Printing method		Thermal transfer	Thermal transfer
Print resolution		300 dpi	600 dpi
Print speed		Maximum 300 mm/s	Maximum 150 mm/s
Print width		Up to 105.7 mm	Up to 105.7 mm
Print length		Maximum 2000 mm	Maximum 2000 mm
Media			
Media		Labels on rolls or with Leporello folds, textile, flat-pressed shrink sleeves, hard PVC strips	
Supply roll			
Core diameter		40 mm	
Label winding		Outside or inside	
Ink ribbon			
Ink side		Outside	
Core diameter		25.4 mm	
Ribbon length		Up to 450 m	
Width		Up to 114 mm	
Printer dimensions			
Dimensions (W x H x D)		252 mm x 288 mm x 460 mm	
Weight		10 kg	
Electronics			
High-speed processor, 32 bits, ColdFire			
Clock speed		800 MHz	
RAM		265 MB	
Program memory (ROM)		50 MB	
Slot for SD memory card (SDHC, SDXC)		Up to 512 GB	
Interfaces			
Serial RS-232 C		1200 to 230400 baud/8 bit	
USB 2.0		High-speed slave for PC connection	
USB host		2 x on the back, up to 500 mA	
USB host		1 x on the control panel, up to 500 mA	

THERMOMARK ROLLMASTER

Interfaces	
Ethernet	LPD, IPv4, IPv6, RawIP printing, DHCP, HTTP, FTP, SMTP, SNMP, TIME, NTP, Zeroconf, SOAP web service
WLAN	WLAN 802.11b, g, n, Access Point Mode or Station Mode 2.4 GHz
I/O interface IEC/EN 61131-2	Integrated
Software	
Windows driver	Windows Vista, Windows 7, Windows 8, Windows 8.1, Windows 10, Server 2003, Server 2008, Server 2008 R2, Server 2012, Server 2012 R2, stand-alone operation
Planning and marking software	CLIP PROJECT advanced / professional
Operating data	
Voltage	100 V AC ... 240 V AC, 50/60 Hz
Power consumption	Maximum 300 W
Operating temperature	+10°C ... +40°C
Humidity	10 % ... 85 %, non-condensing

A 3 FCC

NOTE: This equipment has been tested and found to comply with the limits for a Class A digital device, pursuant to Part 15 of the FCC Rules.

These limits are designed to provide reasonable protection against harmful interference when the equipment is operated in a commercial environment. The equipment generates, uses, and can radiate radio frequency and, if not installed and used in accordance with the instruction manual, may cause harmful interference to radio communications.

Operation of this equipment in a residential area is likely to cause harmful interference in which case the user may be required to correct the interference at his own expense.

B Index

C		
Changing the language	17	
Cleaning		
Device	28	
Photoelectric label barrier	28	
Pressure roller	29	
Printhead	29	
Cleaning interval	23	
Cleaning photoelectric label barrier	28	
Connecting the power supply unit	10	
Connecting the printer	11	
Connections	10	
Creating print jobs	16	
D		
Display	17	
Disposal	33	
E		
Error causes	32	
Error messages	32, 33	
Ethernet	12	
Exchanging roller	30	
F		
Field of application	6	
FTP	26	
I		
IFFS (Internal Flash File System)	18	
Ink ribbon		
Loading		
Ink ribbon ordering data	34	
Inserting Leporello labels	14	
Installation location	8	
Intended use	6	
L		
Loading label strips into printhead	13, 14	
Loading labels	13	
Loading labels from a roll	13	
loading marker sleeve	13	
loading print media	13	
loading shrink sleeve	13	
Loading the print media	13	
O		
Ordering data	34	
P		
Pressure roller		
Cleaning	29	
Exchanging	30	
Pressure roller, see pressure roller		
Printhead		
Cleaning	29	
Notes	7	
R		
Radio interference	7	
S		
Safety notes	6	
Scope of supply	8	
T		
Target group	5	
Technical data	37	
Transfer film, see ink ribbon		
Transport	33	
Transportation safeguard	8	
Troubleshooting	32	
U		
Unpacking	8	
W		
Website	25	
WLAN	12	

Please observe the following notes

General terms and conditions of use for technical documentation

Phoenix Contact reserves the right to alter, correct, and/or improve the technical documentation and the products described in the technical documentation at its own discretion and without giving prior notice, insofar as this is reasonable for the user. The same applies to any technical changes that serve the purpose of technical progress.

The receipt of technical documentation (in particular user documentation) does not constitute any further duty on the part of Phoenix Contact to furnish information on modifications to products and/or technical documentation. You are responsible to verify the suitability and intended use of the products in your specific application, in particular with regard to observing the applicable standards and regulations. All information made available in the technical data is supplied without any accompanying guarantee, whether expressly mentioned, implied or tacitly assumed.

In general, the provisions of the current standard Terms and Conditions of Phoenix Contact apply exclusively, in particular as concerns any warranty liability.

This manual, including all illustrations contained herein, is copyright protected. Any changes to the contents or the publication of extracts of this document is prohibited.

Phoenix Contact reserves the right to register its own intellectual property rights for the product identifications of Phoenix Contact products that are used here. Registration of such intellectual property rights by third parties is prohibited.

Other product identifications may be afforded legal protection, even where they may not be indicated as such.

How to contact us

Internet

Up-to-date information on Phoenix Contact products and our Terms and Conditions can be found on the Internet at:

phoenixcontact.com

Make sure you always use the latest documentation.

It can be downloaded at:

phoenixcontact.net/products

Subsidiaries

If there are any problems that cannot be solved using the documentation, please contact your Phoenix Contact subsidiary.

Subsidiary contact information is available at phoenixcontact.com.

Published by

PHOENIX CONTACT GmbH & Co. KG

Flachmarktstraße 8

32825 Blomberg

GERMANY

Should you have any suggestions or recommendations for improvement of the contents and layout of our manuals, please send your comments to:

tecdoc@phoenixcontact.com