

## Item description

### Male connector/plug *WINSTA*<sup>®</sup> MIDI A coding

Use effective pluggable connections instead of laborious screw connections: With the *WINSTA*<sup>®</sup> MIDI male connector/plug rated current 25 A. The pluggable installation connectors with spring pressure connection technology work without screw connections. They allow resource-efficient, error-free installation in a large number of applications. For greater protection in electrical installations, the pluggable installation connector is provided with mechanical protection against mismatching. The pluggable installation connector is protected against ingress by solid objects in accordance with protection type IP20 (When mated and secured with a strain relief housing: IP2xC (These compact connectors are not designed for use in open, easily accessible areas!)). Thanks to the color coding and mechanical A coding of *WINSTA*<sup>®</sup> MIDI pluggable installation connectors, you can clearly distinguish different circuits. This pluggable installation connector can be used for electrical currents up to 25 A. Thus the product is especially suitable for high power loads. The *WINSTA*<sup>®</sup> MIDI product line achieves total flexibility for the installation. Through its Push-in CAGE CLAMP<sup>®</sup> spring pressure connection technology, it achieves time-saving, error-free installation and offers flexibility for meeting all installation requirements.

### *WINSTA*<sup>®</sup> MIDI solutions for your electrical installation – protected against mismatching and maintenance-free

*WINSTA*<sup>®</sup> is the pluggable connection system that is optimally tailored to the strict requirements of electrical installation. It allows error-free

Subject to changes. Please also observe the further product documentation!



installation of cables and components, quickly and reliably. Choose durability and quality – the WINSTA® MIDI pluggable installation connector with protection type IP20 from WAGO makes the installation of electrical components significantly easier.

- 
- pluggable installation connectors with protection against mismatching
- for automation controllers
- with A coding for use in many general mains applications
- flexible installation to save space
- convenient installation and commissioning

## Data

### Electrical data

#### Ratings per IEC/EN

Ratings per	IEC/EN 60664-1
Nominal voltage (III/3)	250 V
Rated impulse voltage (III/3)	4 kV
Rated current	25 A
Legend (ratings)	(III / 3) ≙ Overvoltage category III / Pollution degree 3

#### Ratings per UL 1977

Note for the US market	Some versions may also be used for current interruption in accordance with the UL certificate in select applications with currents below 16 A and voltages up to 600 V. For further information, please contact your local sales office.
Rated voltage (UL 1977)	600 V
Rated current UL 1977	23 A

### General

Note on contact resistance	approx. 1 mΩ of contact resistance approx. 0.25 mΩ contact transition plug/socket
----------------------------	--

### Connection data

Connection points	6
Total number of potentials	3
PE function	Preceding PE contact

Subject to changes. Please also observe the further product documentation!



## Connection 1

Connection technology	Push-in CAGE CLAMP®
Actuation type	Operating tool Push-in
Nominal cross-section	4 mm <sup>2</sup> / 12 AWG
Solid conductor	0.5 ... 4 mm <sup>2</sup> / 20 ... 12 AWG
Solid conductor; push-in termination	1.5 ... 4 mm <sup>2</sup> / 16 ... 12 AWG
Stranded conductor	0.5 ... 2.5 mm <sup>2</sup> / 20 ... 14 AWG
Fine-stranded conductor	0.5 ... 4 mm <sup>2</sup> / 20 ... 12 AWG
Fine-stranded conductor; with insulated ferrule	0.25 ... 1.5 mm <sup>2</sup> / 20 ... 16 AWG
Fine-stranded conductor; with uninsulated ferrule	0.25 ... 2.5 mm <sup>2</sup> / 20 ... 14 AWG
Fine-stranded conductor; with ferrule; push-in termination	1.5 mm <sup>2</sup> / 16 AWG
Strip length	9 mm / 0.35 inches
Pole number	3
Conductor entry direction to mating direction	0°

## Physical data

Pin spacing	10 mm / 0.394 inches
Width	30 mm / 1.181 inches
Height	12.9 mm / 0.508 inches
Depth	37.5 mm / 1.476 inches

## Mechanical Data

Application	General mains applications
Coding	A
Variable coding	Yes
Marking	N ⊥ L
Potential marking	N ⊥ L
Mating force of a plug-in connection	approx. 20 ... 70 N (depending on pole number)
Retention force of a plug-in connection	Locked: > 80 N
Unmating force of a plug-in connection	Unlocked: approx. 20 ... 70 N (depending on pole number)
Number of mating cycles	200, without resistive load
Protection type	IP20; When mated and secured with a strain relief housing: IP2xC (These compact connectors are not designed for use in open, easily accessible areas!)

Subject to changes. Please also observe the further product documentation!



## Plug-in connection

Contact type (pluggable connector)	Male connector/plug
Connector (connection type)	for conductor
Mismating protection	Yes
Note on mismating protection	All <i>WINSTA</i> <sup>®</sup> components are 100% protected against mismating when: a.) plugging different numbers of poles b.) plugging while rotated 180 c.) plugging while laterally staggered d.) plugging one pole
Locking lever	Can be retrofitted
Locking of plug-in connection	locking lever
Note on locking system	All connectors for mounted installations (snap-in versions for lighting fixtures or devices, all types of PCB and distribution connectors) are factory-equipped with locking levers to ensure plugs and sockets are securely locked. Additional locking levers are only required for flying leads (plug/socket).

## Material Data

Note (material data)	Information on material specifications can be found here
Color	white
Cover color	gray
Material group	I
Insulation material	Polyamide (PA66)
Flammability class per UL94	V0
Clamping spring material	Chrome-nickel spring steel (CrNi)
Contact material	Copper or copper alloy; surface-treated
Contact plating	Tin
Fire load	0.21 MJ
Weight	9.9 g

## Environmental requirements

Processing temperature	-5 ... +40 °C
Continuous operating temperature	-35 ... +85 °C
Note on continuous operating temperature	Insulating parts for temperatures ≤ 105 °C

Subject to changes. Please also observe the further product documentation!

WAGO GmbH & Co. KG  
Hansastr. 27  
32423 Minden  
Phone: +49571 887-0 | Fax: +49571 887-169  
Email: [info.de@wago.com](mailto:info.de@wago.com) | Web: [www.wago.com](http://www.wago.com)

Do you have any questions about our products?  
We are always happy to take your call at +49 (571) 887-44222.

## Commercial data



Product Group	20 (Winsta)
eCl@ss 10.0	27-44-06-05
eCl@ss 9.0	27-44-06-05
ETIM 8.0	EC002560
ETIM 7.0	EC002560
PU (SPU)	100 pcs
Packaging type	box
Country of origin	DE
GTIN	4044918254182
Customs tariff number	85366990990

## Environmental Product Compliance

RoHS Compliance Status	Compliant, No Exemption
------------------------	-------------------------

## Approvals / Certificates

### General approvals

Logo	Approval	Additional Approval Text	Certificate name
	CCA DEKRA Certification B.V.	EN 61535	71- 123228
	CCA DEKRA Certification B.V.	IEC 61535	NL -84761
	cURus Underwriters Laboratories Inc.	UL 1977	E45171
	VDE VDE Prüf- und Zertifizierungsinstitut	EN 61984	40002889

### Declarations of conformity and manufacturer's declarations

Logo	Approval	Additional Approval Text	Certificate name
	EU-Declaration of Conformity WAGO GmbH & Co. KG	-	-



Subject to changes. Please also observe the further product documentation!

WAGO GmbH & Co. KG  
Hansastr. 27  
32423 Minden  
Phone: +49571 887-0 | Fax: +49571 887-169  
Email: [info.de@wago.com](mailto:info.de@wago.com) | Web: [www.wago.com](http://www.wago.com)







Do you have any questions about our products?  
We are always happy to take your call at +49 (571) 887-44222.



## Approvals for marine applications

Logo	Approval	Additional Approval Text	Certificate name
	<b>ABS</b> American Bureau of Shipping	-	19- HG1868589- PDA
	<b>DNV GL</b> Det Norske Veritas, Germanischer Lloyd	-	TAE00001Z6
	<b>LR</b> Lloyds Register	IEC 61984	LR22429487TA

## Counterpart

	<b>Item no.770-123</b> Socket; with strain relief housing; 3-pole; Cod. A; 4,00 mm <sup>2</sup> ; white	<a href="http://www.wago.com/770-123">www.wago.com/770-123</a>
	<b>Item no.770-223</b> Socket; 3-pole; Cod. A; 4,00 mm <sup>2</sup> ; white	<a href="http://www.wago.com/770-223">www.wago.com/770-223</a>
	<b>Item no.770-223/035-050</b> Socket; with strain relief housing; 3-pole; Cod. A; 4,00 mm <sup>2</sup> ; white	<a href="http://www.wago.com/770-223/035-050">www.wago.com/770-223/035-050</a>
	<b>Item no.770-6223</b> Linect® T-connector; 3-pole; Cod. A; 1 input; 2 outputs; white	<a href="http://www.wago.com/770-6223">www.wago.com/770-6223</a>
	<b>Item no.770-656</b> T-distribution connector; 3-pole; Cod. A; 1 input; 2 outputs; 2 locking levers; white	<a href="http://www.wago.com/770-656">www.wago.com/770-656</a>
	<b>Item no.770-658</b> 5-way distribution connector; 3-pole; Cod. A; 1 input; 5 outputs; white	<a href="http://www.wago.com/770-658">www.wago.com/770-658</a>

Subject to changes. Please also observe the further product documentation!



**Item no.770-657**  
3-way distribution connector; 3-pole; Cod. A; 1 input; 3 outputs; white

[www.wago.com/770-657](http://www.wago.com/770-657)



**Item no.770-661**  
Three-phase to single-phase distribution connector; with phase selection; 5-pole/3-pole; Cod. A; 1 input; 2 outputs; with cable connection on the input side; white

[www.wago.com/770-661](http://www.wago.com/770-661)



**Item no.770-665**  
T-distribution connector; 3-pole; Cod. A; 1 input; 2 outputs; 3 locking levers; for flying leads; white

[www.wago.com/770-665](http://www.wago.com/770-665)



**Item no.770-683**  
h-distribution connector; 3-pole; Cod. A; 1 input; 2 outputs; outputs on both sides; 2 locking levers; white

[www.wago.com/770-683](http://www.wago.com/770-683)



**Item no.770-685**  
h-distribution connector; 3-pole; Cod. A; 1 input; 2 outputs; outputs on both sides; 3 locking levers; for flying leads; white

[www.wago.com/770-685](http://www.wago.com/770-685)



**Item no.770-684**  
h-distribution connector; 3-pole; Cod. A; 1 input; 2 outputs; outputs on one side; 2 locking levers; white

[www.wago.com/770-684](http://www.wago.com/770-684)



**Item no.770-686**  
h-distribution connector; 3-pole; Cod. A; 1 input; 2 outputs; outputs on one side; 3 locking levers; for flying leads; white

[www.wago.com/770-686](http://www.wago.com/770-686)



**Item no.770-687**  
Distribution connector for switches; Single-pole switch and series circuit; 3-pole; Cod. A/S; 1 input; 5 outputs; white

[www.wago.com/770-687](http://www.wago.com/770-687)



**Item no.770-690**  
Three-phase to single-phase distribution connector; with phase selection; 5-pole/3-pole; Cod. A; 1 input; 5 outputs; white

[www.wago.com/770-690](http://www.wago.com/770-690)



**Item no.770-688**  
Distribution connector for switches; Single-pole and throttle two-way circuit; 3-pole; Cod. A/S; 1 input; 5 outputs; white

[www.wago.com/770-688](http://www.wago.com/770-688)



**Item no.770-723**  
Snap-in socket; 3-pole; Cod. A; 4,00 mm<sup>2</sup>; white

[www.wago.com/770-723](http://www.wago.com/770-723)

Subject to changes. Please also observe the further product documentation!

WAGO GmbH & Co. KG

Hansastr. 27

32423 Minden

Phone: +49571 887-0 | Fax: +49571 887-169

Email: [info.de@wago.com](mailto:info.de@wago.com) | Web: [www.wago.com](http://www.wago.com)

Do you have any questions about our products?

We are always happy to take your call at +49 (571) 887-44222.



**Item no.770-723/009-000**

Snap-in socket; with protruding mating face; 3-pole; Cod. A; 4,00 mm<sup>2</sup>; white

[www.wago.com/770-723/009-000](http://www.wago.com/770-723/009-000)



**Item no.770-823**

Socket for PCBs; straight; 3-pole; Cod. A; white

[www.wago.com/770-823](http://www.wago.com/770-823)



**Item no.770-823/011-000**

Socket for PCBs; angled; 3-pole; Cod. A; white

[www.wago.com/770-823/011-000](http://www.wago.com/770-823/011-000)

## Required accessories

### Locking levers

Locking system



**Item no.: 770-121**

Locking lever; for flying leads; for manual operation; white

[www.wago.com/770-121](http://www.wago.com/770-121)



**Item no.: 770-131**

Locking lever; for flying leads; for tool operation; white

[www.wago.com/770-131](http://www.wago.com/770-131)



**Item no.: 770-101**

Locking lever; for flying leads; for manual operation; black

[www.wago.com/770-101](http://www.wago.com/770-101)



**Item no.: 770-111**

Locking lever; for flying leads; for tool operation; black

[www.wago.com/770-111](http://www.wago.com/770-111)

## Optional accessories

### Coding

Coding



**Item no.: 770-401**

Coding pin; for plugs; Plastic; gray

[www.wago.com/770-401](http://www.wago.com/770-401)

### Cover

Cover



**Item no.: 770-360**

Lockout cap; for plugs; 5-pole; separable; yellow

[www.wago.com/770-360](http://www.wago.com/770-360)

### Mounting

Snap-in frame

Subject to changes. Please also observe the further product documentation!

WAGO GmbH & Co. KG

Hansastr. 27

32423 Minden

Phone: +49571 887-0 | Fax: +49571 887-169

Email: [info.de@wago.com](mailto:info.de@wago.com) | Web: [www.wago.com](http://www.wago.com)

Do you have any questions about our products?

We are always happy to take your call at +49 (571) 887-44222.





Item no.: 770-318

Snap-in frame; 3-pole; 1.0 ... 3.0 mm; black

[www.wago.com/770-318](http://www.wago.com/770-318)



Item no.: 770-338

Snap-in frame; 3-pole; 1.0 ... 3.0 mm; white

[www.wago.com/770-338](http://www.wago.com/770-338)

### Shield termination

Shield termination



Item no.: 770-523

Shield connecting plate; 3-pole; for sockets and plugs; silver-colored

[www.wago.com/770-523](http://www.wago.com/770-523)

### Marking accessories

Marker



Item no.: 770-450/000-002

Marker card; Plastic; yellow

[www.wago.com/770-450/000-002](http://www.wago.com/770-450/000-002)



Item no.: 770-450/000-001

Marker card; Plastic; green

[www.wago.com/770-450/000-001](http://www.wago.com/770-450/000-001)



Item no.: 770-450/000-005

Marker card; Plastic; red

[www.wago.com/770-450/000-005](http://www.wago.com/770-450/000-005)



Item no.: 770-450

Marker card; Plastic; white

[www.wago.com/770-450](http://www.wago.com/770-450)



Item no.: 770-450/000-006

Marker card; Plastic; blue

[www.wago.com/770-450/000-006](http://www.wago.com/770-450/000-006)



Item no.: 770-450/000-012

Marker card; Plastic; orange

[www.wago.com/770-450/000-012](http://www.wago.com/770-450/000-012)

### Strain relief

Strain relief housing



Item no.: 770-503

Strain relief housing; 3-pole; for 2 cables; 8.0 ... 11.5 mm; 55 mm; black

[www.wago.com/770-503](http://www.wago.com/770-503)

Subject to changes. Please also observe the further product documentation!

WAGO GmbH & Co. KG

Hansastr. 27

32423 Minden

Phone: +49571 887-0 | Fax: +49571 887-169

Email: [info.de@wago.com](mailto:info.de@wago.com) | Web: [www.wago.com](http://www.wago.com)

Do you have any questions about our products?

We are always happy to take your call at +49 (571) 887-44222.



**Item no.: 770-503/023-000**

Strain relief housing; 3-pole; for 2 cables; 4.5 ... 8.0 mm; 55 mm; black

[www.wago.com/770-503/023-000](http://www.wago.com/770-503/023-000)



**Item no.: 770-503/021-000**

Strain relief housing; 3-pole; for 1 cable; 9.0 ... 13.0 mm; 71 mm; black

[www.wago.com/770-503/021-000](http://www.wago.com/770-503/021-000)



**Item no.: 770-503/035-000**

Strain relief housing; 3-pole; with locking clip; for 1 cable; 7.0 ... 11.5 mm; 48 mm; black

[www.wago.com/770-503/035-000](http://www.wago.com/770-503/035-000)



**Item no.: 770-503/038-000**

Strain relief housing; 3-pole; with locking clip; for 1 cable; 7.0 ... 11.5 mm; 48 mm; black

[www.wago.com/770-503/038-000](http://www.wago.com/770-503/038-000)



**Item no.: 770-503/032-000**

Strain relief housing; 3-pole; with locking clip; for 2 cables; 8.0 ... 11.5 mm; 55 mm; black

[www.wago.com/770-503/032-000](http://www.wago.com/770-503/032-000)



**Item no.: 770-513/038-000**

Strain relief housing; 3-pole; with locking clip; for 1 cable; 7.0 ... 11.5 mm; 48 mm; white

[www.wago.com/770-513/038-000](http://www.wago.com/770-513/038-000)



**Item no.: 770-513**

Strain relief housing; 3-pole; for 2 cables; 8.0 ... 11.5 mm; 55 mm; white

[www.wago.com/770-513](http://www.wago.com/770-513)



**Item no.: 770-513/021-000**

Strain relief housing; 3-pole; for 1 cable; 9.0 ... 13.0 mm; 71 mm; white

[www.wago.com/770-513/021-000](http://www.wago.com/770-513/021-000)



**Item no.: 770-513/032-000**

Strain relief housing; 3-pole; for 2 cables; 8.0 ... 11.5 mm; 55 mm; white

[www.wago.com/770-513/032-000](http://www.wago.com/770-513/032-000)



**Item no.: 770-513/035-000**

Strain relief housing; 3-pole; with locking clip; for 1 cable; 7.0 ... 11.5 mm; 48 mm; white

[www.wago.com/770-513/035-000](http://www.wago.com/770-513/035-000)



**Item no.: 770-513/023-000**

Strain relief housing; 3-pole; for 2 cables; 4.5 ... 8.0 mm; 55 mm; white

[www.wago.com/770-513/023-000](http://www.wago.com/770-513/023-000)

## Tool

Operating tool

Subject to changes. Please also observe the further product documentation!

WAGO GmbH & Co. KG

Hansastr. 27

32423 Minden

Phone: +49571 887-0 | Fax: +49571 887-169

Email: [info.de@wago.com](mailto:info.de@wago.com) | Web: [www.wago.com](http://www.wago.com)

Do you have any questions about our products?

We are always happy to take your call at +49 (571) 887-44222.



**Item no.: 210-719**

Operating tool; Blade: 2.5 x 0.4 mm; with a partially insulated shaft

[www.wago.com/210-719](http://www.wago.com/210-719)



**Item no.: 770-383**

Operating tool; 3-way; green

[www.wago.com/770-383](http://www.wago.com/770-383)

## Downloads

### Documentation

#### Bid Text

770-233 X81 - Datei	2019 Feb 19	xml 3.1 kB	Download
770-233 doc - Datei	2015 Jun 8	doc 24.1 kB	Download

## CAD/CAE-Data

### CAE data

EPLAN Data Portal 770-233	URL	Download
WSCAD Universe 770-233	URL	Download
ZUKEN Portal 770-233	URL	Download

### CAD data

2D/3D Models 770-233	URL	Download
----------------------	-----	----------

## Environmental Product Compliance

### Compliance Search

Environmental Product Compliance 770-233 Plug; 3-pole; Cod. A; 4,00 mm <sup>2</sup> ; white	URL	Download
--	-----	----------

## Installation Notes

Subject to changes. Please also observe the further product documentation!

WAGO GmbH & Co. KG  
Hansastr. 27  
32423 Minden  
Phone: +49571 887-0 | Fax: +49571 887-169  
Email: [info.de@wago.com](mailto:info.de@wago.com) | Web: [www.wago.com](http://www.wago.com)

Do you have any questions about our products?  
We are always happy to take your call at +49 (571) 887-44222.

### Conductor termination

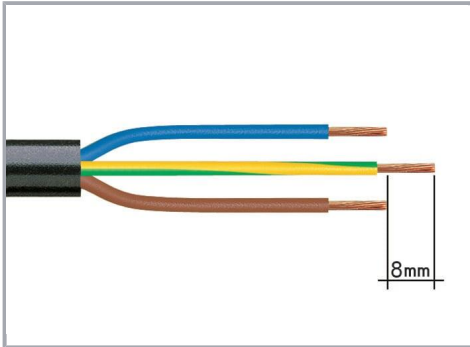

1. Strip length, outer insulation = 35 mm (2-pole), 55 mm (3- to 5-pole)

2. Strip length = 9 mm

3. Extended ground conductor = 8 mm

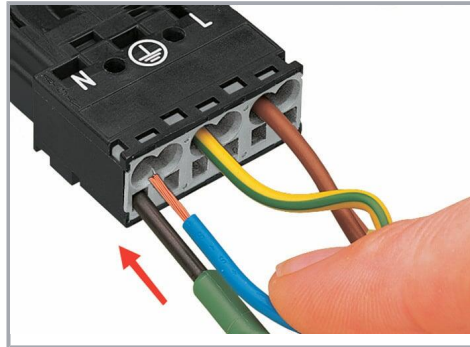

To terminate fine-stranded conductors, open the clamping unit via screwdriver (2.5 mm blade width) and insert a stripped conductor until it hits the backstop.

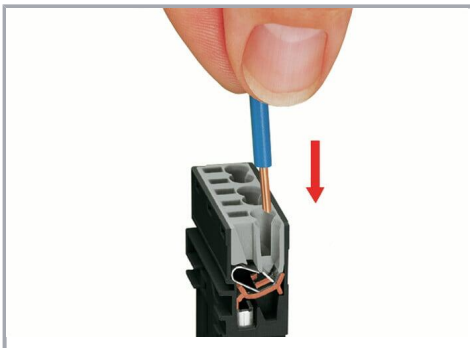

Insert the stripped solid conductor until it hits the backstop.

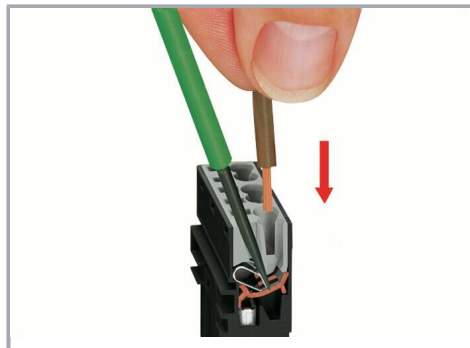

To terminate fine-stranded conductors, open the clamping unit via screwdriver (2.5 mm blade width) and insert a stripped conductor until it hits the backstop.

### Conductor removal

Subject to changes. Please also observe the further product documentation!

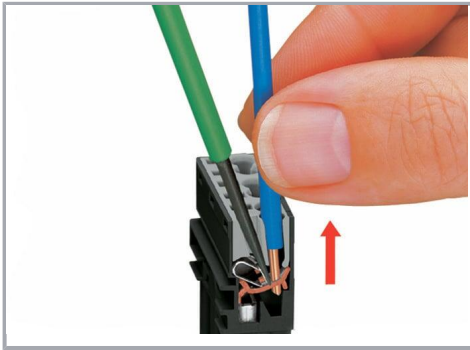

To remove the conductor, actuate the clamp via screwdriver (2.5 mm blade width) and pull out the conductor.

### Installation

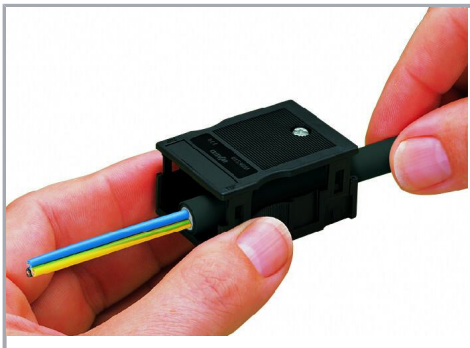

We recommend pulling the pre-latched strain relief housing over the cable prior to termination. However, the strain relief can be mounted at a later time as well.

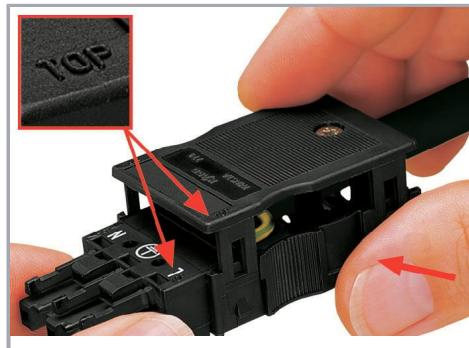

Latch the strain relief housing onto the plug /socket. Note the "TOP" inscription.

Subject to changes. Please also observe the further product documentation!

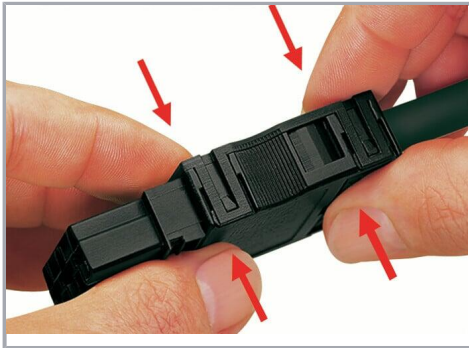

Prepare strain relief housing by snapping together upper and bottom part.



Tighten strain relief screw with screwdriver (2.5 mm blade width).

## Product family

**WINSTA® MIDI**

[Show all products from the family](#)

Subject to changes. Please also observe the further product documentation!