

Data sheet | Item number: 792-805

Surge suppression module for signal technology; Nominal voltage: 5 VDC;
for 2 signal paths with common surge arrester; for interfaces with high baud
rate; Two-stage; Width: 6 mm; 2,50 mm²

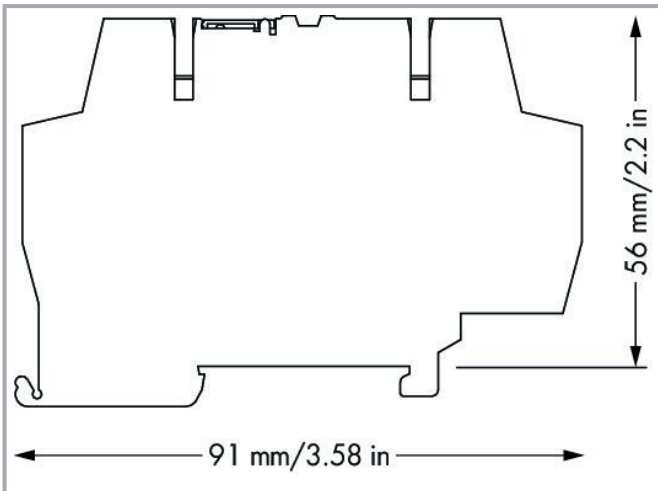

www.wago.com/792-805

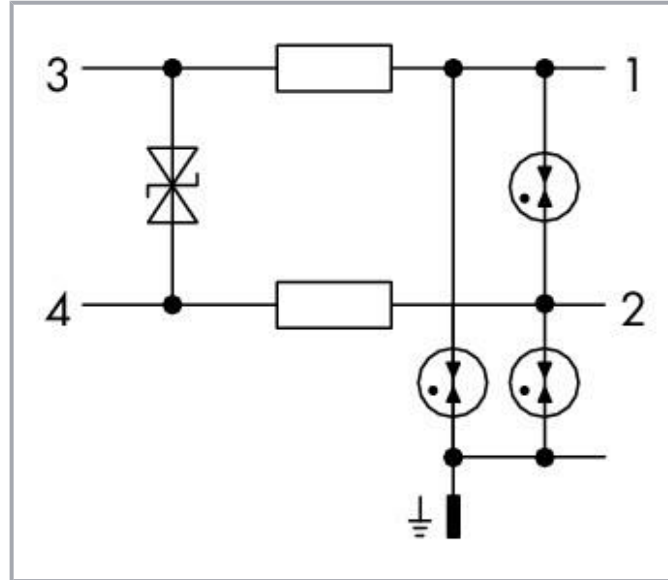
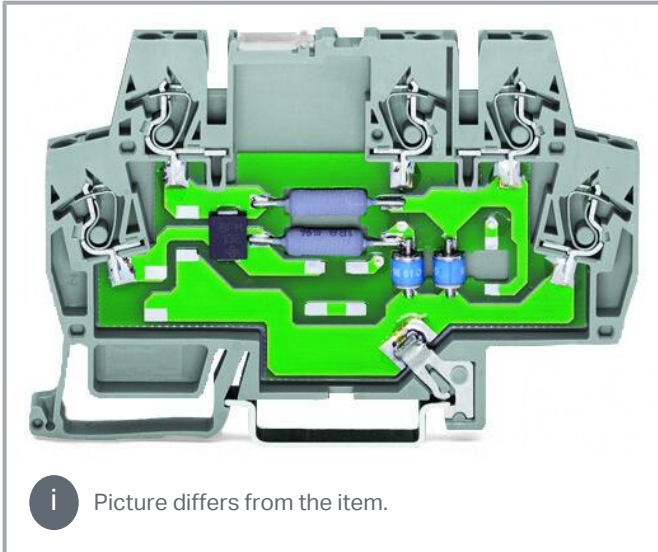

Item description

Short description:

Provides surge protection for IT systems and devices in the voltage range up to 60 V (except custom solutions, e.g., telephone systems with ringing voltage).

Subject to changes. Please also observe the further product documentation!

WAGO GmbH & Co. KG
Hansastr. 27
32423 Minden
Phone: +49571 887-0 | Fax: +49571 887-169
Email: info.de@wago.com | Web: www.wago.com

Do you have any questions about our products?
We are always happy to take your call at +49 (571) 887-44222.



Overvoltage protection is also possible for DIN-35 rail-mount terminal blocks. Multi-stage surge arresters in rail-mount terminal blocks (792-80x Series) of just 6 mm width ensure cost-effective protection for control and bus technology (e.g., LON[®] network, PROFIBUS network, binary signals).

Features:

- Protect your system against overvoltage
- Slim, space-saving design
- Control operational costs by preventing expensive, unplanned downtime
- High operational reliability and system uptime

Data

Notes

Note	The coordination characteristics of the surge arrester provide information about its discharge capacity and protection capability.
------	--

Electrical data

Nominal operating voltage	DC 5 V
Highest continuous voltage	AC 4.2 V / DC 6 V
Nominal current	0.1 A
Nominal discharge current (8/20 μs) (line)	5 kA
Nominal discharge current (8/20 μs) (total)	10 kA
Protection level (line/line) (cat. C2 at I_N)	≤ 27 V
Protection level (line/protected ground) (cat. C2 at I_N)	≤ 50 V
Protection level (line/line) (cat. C3 at I_N)	≤ 14 V
Protection level (line/protected ground) (cat. C3 at I_N)	≤ 14 V
Limit frequency (line/line)	250 MHz
Limit frequency (line/protected ground)	180 MHz
Impedance	1 Ω

Safety and protection

Protection type	IP00; IP20 with end and intermediate plate
-----------------	--

Connection data

Connections (number)	5
----------------------	---

Subject to changes. Please also observe the further product documentation!



Connection technology	CAGE CLAMP®
Solid conductor	0.08 ... 2.5 mm ² / 28 ... 14 AWG
Fine-stranded conductor	0.08 ... 2.5 mm ² / 28 ... 14 AWG
Strip length	5 ... 6 mm / 0.2 ... 0.24 inches

Physical data

Width	6 mm / 0.236 inches
Height from upper-edge of DIN-rail	56 mm / 2.205 inches
Depth	91 mm / 3.583 inches

Mechanical Data

Mounting type	DIN-35 rail DIN-35 rail
---------------	----------------------------

Material Data

Weight	38 g
--------	------

Environmental requirements

Ambient temperature (operation)	-40 ... +80 °C
Ambient temperature (storage)	-40 ... +80 °C

Standards and specifications

Standards/specifications	IEC 61643-21 IEC 61131-3
--------------------------	-----------------------------

Commercial data

Product Group	21 (Special Products Electronic)
eCl@ss 10.0	27-13-08-05
eCl@ss 9.0	27-13-08-05
ETIM 8.0	EC000943
ETIM 7.0	EC000943
PU (SPU)	1 pcs
Packaging type	Box
Country of origin	DE
GTIN	4017332843737
Customs tariff number	85363010900

Subject to changes. Please also observe the further product documentation!

Environmental Product Compliance

RoHS Compliance Status

Compliant, No Exemption

Approvals / Certificates

General approvals



Logo	Approval	Additional Approval Text	Certificate name
	EAC Brjansker Zertifizierungsstelle	TP TC 004/2011	EAC RU C-DE.AM02. B.00122 /19

Declarations of conformity and manufacturer's declarations

Logo	Approval	Additional Approval Text	Certificate name
	EU-Declaration of Conformity WAGO GmbH & Co. KG	-	-

Optional accessories

Jumpers

Jumper		
	Item no.: 859-408 Jumper; for jumper slot; 8-way; insulated; light gray	www.wago.com/859-408
	Item no.: 859-404/000-005 Jumper; for jumper slot; 4-way; insulated; red	www.wago.com/859-404/000-005
	Item no.: 859-404/000-006 Jumper; for jumper slot; 4-way; insulated; blue	www.wago.com/859-404/000-006
	Item no.: 859-405/000-005 Jumper; for jumper slot; 5-way; insulated; red	www.wago.com/859-405/000-005
	Item no.: 859-405/000-029 Jumper; for jumper slot; 5-way; insulated; yellow	www.wago.com/859-405/000-029

Subject to changes. Please also observe the further product documentation!

WAGO GmbH & Co. KG
Hansastr. 27
32423 Minden
Phone: +49571 887-0 | Fax: +49571 887-169
Email: info.de@wago.com | Web: www.wago.com

Do you have any questions about our products?
We are always happy to take your call at +49 (571) 887-44222.



Item no.: 859-405

Jumper; for jumper slot; 5-way; insulated; light gray

www.wago.com/859-405



Item no.: 859-404/000-029

Jumper; for jumper slot; 4-way; insulated; yellow

www.wago.com/859-404/000-029



Item no.: 859-406

Jumper; for jumper slot; 6-way; insulated; light gray

www.wago.com/859-406



Item no.: 859-405/000-006

Jumper; for jumper slot; 5-way; insulated; blue

www.wago.com/859-405/000-006



Item no.: 859-406/000-005

Jumper; for jumper slot; 6-way; insulated; red

www.wago.com/859-406/000-005



Item no.: 859-409/000-029

Jumper; for jumper slot; 9-way; insulated; yellow

www.wago.com/859-409/000-029



Item no.: 859-410/000-005

Jumper; for jumper slot; 10-way; insulated; red

www.wago.com/859-410/000-005



Item no.: 859-410/000-029

Jumper; for jumper slot; 10-way; insulated; yellow

www.wago.com/859-410/000-029



Item no.: 859-410

Jumper; for jumper slot; 10-way; insulated; light gray

www.wago.com/859-410

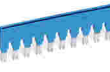

Item no.: 859-410/000-006

Jumper; for jumper slot; 10-way; insulated; blue

www.wago.com/859-410/000-006



Item no.: 859-403/000-005

Jumper; for jumper slot; 3-way; insulated; red

www.wago.com/859-403/000-005



Item no.: 859-402/000-029

Jumper; for jumper slot; 2-way; insulated; yellow

www.wago.com/859-402/000-029



Item no.: 859-403/000-029

Jumper; for jumper slot; 3-way; insulated; yellow

www.wago.com/859-403/000-029



Subject to changes. Please also observe the further product documentation!

WAGO GmbH & Co. KG

Hansastr. 27

32423 Minden

Phone: +49571 887-0 | Fax: +49571 887-169

Email: info.de@wago.com | Web: www.wago.com

Do you have any questions about our products?

We are always happy to take your call at +49 (571) 887-44222.

Item no.: 859-403/000-006

Jumper; for jumper slot; 3-way; insulated; blue

www.wago.com/859-403/000-006



Item no.: 859-408/000-005

Jumper; for jumper slot; 8-way; insulated; red

www.wago.com/859-408/000-005



Item no.: 859-408/000-029

Jumper; for jumper slot; 8-way; insulated; yellow

www.wago.com/859-408/000-029



Item no.: 859-409

Jumper; for jumper slot; 9-way; insulated; light gray

www.wago.com/859-409



Item no.: 859-408/000-006

Jumper; for jumper slot; 8-way; insulated; blue

www.wago.com/859-408/000-006



Item no.: 859-403

Jumper; for jumper slot; 3-way; insulated; light gray

www.wago.com/859-403



Item no.: 859-409/000-005

Jumper; for jumper slot; 9-way; insulated; red

www.wago.com/859-409/000-005



Item no.: 859-404

Jumper; for jumper slot; 4-way; insulated; light gray

www.wago.com/859-404



Item no.: 859-409/000-006

Jumper; for jumper slot; 9-way; insulated; blue

www.wago.com/859-409/000-006



Item no.: 859-402/000-006

Jumper; for jumper slot; 2-way; insulated; blue

www.wago.com/859-402/000-006



Item no.: 859-402

Jumper; for jumper slot; 2-way; insulated; light gray

www.wago.com/859-402



Item no.: 859-402/000-005

Jumper; for jumper slot; 2-way; insulated; red

www.wago.com/859-402/000-005



Item no.: 859-406/000-006

Jumper; for jumper slot; 6-way; insulated; blue

www.wago.com/859-406/000-006



Item no.: 859-406/000-029

Jumper; for jumper slot; 6-way; insulated; signal yellow

www.wago.com/859-406/000-029

Subject to changes. Please also observe the further product documentation!

WAGO GmbH & Co. KG

Hansastr. 27

32423 Minden

Phone: +49571 887-0 | Fax: +49571 887-169

Email: info.de@wago.com | Web: www.wago.com

Do you have any questions about our products?

We are always happy to take your call at +49 (571) 887-44222.



Item no.: 859-407/000-006
Jumper; for jumper slot; 7-way; insulated; blue

www.wago.com/859-407/000-006



Item no.: 859-407/000-005
Jumper; for jumper slot; 7-way; insulated; red

www.wago.com/859-407/000-005



Item no.: 859-407/000-029
Jumper; for jumper slot; 7-way; insulated; yellow

www.wago.com/859-407/000-029



Item no.: 859-407
Jumper; for jumper slot; 7-way; insulated; light gray

www.wago.com/859-407

End plate

Intermediate plate



Item no.: 859-525
End and intermediate plate; 1 mm thick; gray

www.wago.com/859-525

Marking accessories

Marking devices



Item no.: 210-110
Fiber-tip pen

www.wago.com/210-110

Marker



Item no.: 2009-145
Mini-WSB Inline; for Smart Printer; 1700 pieces on roll; stretchable 5 - 5.2 mm; plain; snap-on type; white

www.wago.com/2009-145



Item no.: 248-451
Mini-WSB marking card; as card; MARKED; K11 - K20 (10x); not stretchable; Horizontal marking; snap-on type; white

www.wago.com/248-451



Item no.: 248-455
Mini-WSB marking card; as card; MARKED; U 100 (10x); not stretchable; Horizontal marking; snap-on type; white

www.wago.com/248-455



Item no.: 248-450
Mini-WSB marking card; as card; MARKED; K1 - K10 (10x); not stretchable; Horizontal marking; snap-on type; white

www.wago.com/248-450



Item no.: 248-452
Mini-WSB marking card; as card; MARKED; K (100x); not stretchable; Horizontal marking; snap-on type; white

www.wago.com/248-452



Item no.: 248-453
Mini-WSB marking card; as card; MARKED; U1, ... U10 (10x); not stretchable; Horizontal marking; snap-on type; white

www.wago.com/248-453



Item no.: 248-454
Mini-WSB marking card; as card; MARKED; U11 - U20 (10x); not stretchable; Horizontal marking; snap-on type; white

www.wago.com/248-454

Item no.: 248-566

Subject to changes. Please also observe the further product documentation!



Mini-WSB marking card; as card; MARKED; 1 ... 50 (2x); not stretchable; Horizontal marking; snap-on type; white

www.wago.com/248-566



Item no.: 248-501

Mini-WSB marking card; as card; not stretchable; plain; snap-on type; white

www.wago.com/248-501



Item no.: 248-504

Mini-WSB marking card; as card; MARKED; 21 ... 30 (10x); not stretchable; Horizontal marking; snap-on type; white

www.wago.com/248-504

Tool

Operating tool



Item no.: 210-720

Operating tool; Blade: 3.5 x 0.5 mm; with a partially insulated shaft; multicoloured

www.wago.com/210-720

Downloads

Documentation

Bid Text

792-805 X81 - Datei	2019 Feb 19	xml 4.5 kB	Download
792-805 doc - Datei	2015 Feb 11	doc 28.7 kB	Download

Additional Information

Disposal and Recycling Electrical and electronic equipment, Batteries, Packaging	V 1.1.0 2022 Aug 18	pdf 2.2 MB	Download
---	------------------------	---------------	----------

CAD/CAE-Data

CAE data

EPLAN Data Portal 792-805	URL	Download
WSCAD Universe 792-805	URL	Download
ZUKEN Portal 792-805	URL	Download

CAD data

2D/3D Models 792-805

Subject to changes. Please also observe the further product documentation!



[URL](#)

[Download](#)

Environmental Product Compliance

Compliance Search

Environmental Product Compliance 792-805

[URL](#)

[Download](#)

Surge suppression module for signal technology; Nominal voltage: 5 VDC; for 2 signal paths with common surge arrester; for interfaces with high baud rate; Two-stage; Width: 6 mm; 2,50 mm²

Installation Notes

Subject to changes. Please also observe the further product documentation!

WAGO GmbH & Co. KG

Hansastr. 27

32423 Minden

Phone: +49571 887-0 | Fax: +49571 887-169

Email: info.de@wago.com | Web: www.wago.com

Do you have any questions about our products?

We are always happy to take your call at +49 (571) 887-44222.