

LINNEA-UP-PMMA

Asymmetric beam for uplighting optimized for 1.0 mm metal sheet or profile. Variant made from PMMA.

TECHNICAL SPECIFICATIONS:

Dimensions	285.0 x 40.0 mm
Height	10.3 mm
Fastening	clips
ROHS compliant	yes ⓘ

MATERIAL SPECIFICATIONS:

Component	Type	Material	Colour	Finish
LINNEA-UP-PMMA	Linear lens	PMMA	clear	

ORDERING INFORMATION:

Component	Qty in box	MOQ	MPQ	Box weight (kg)
F16845_LINNEA-UP-PMMA » Box size: 398 x 298 x 265 mm	162	36	36	7.6

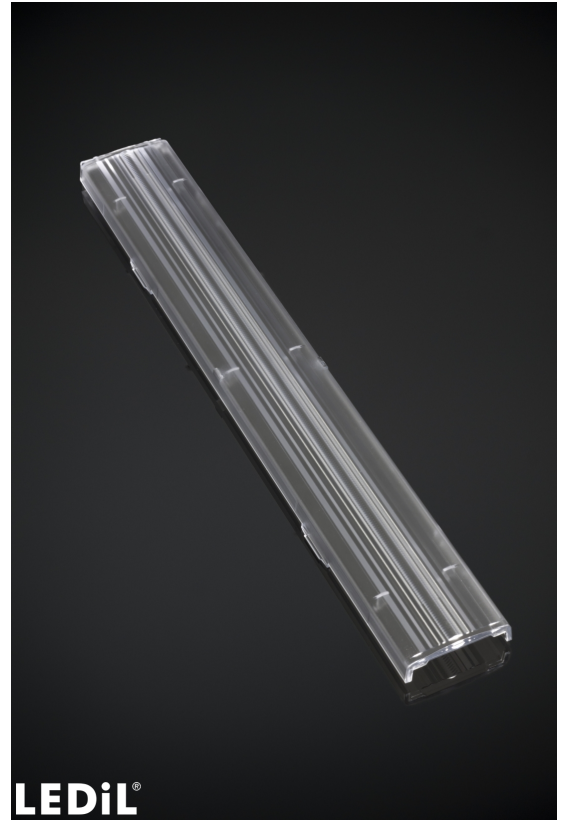

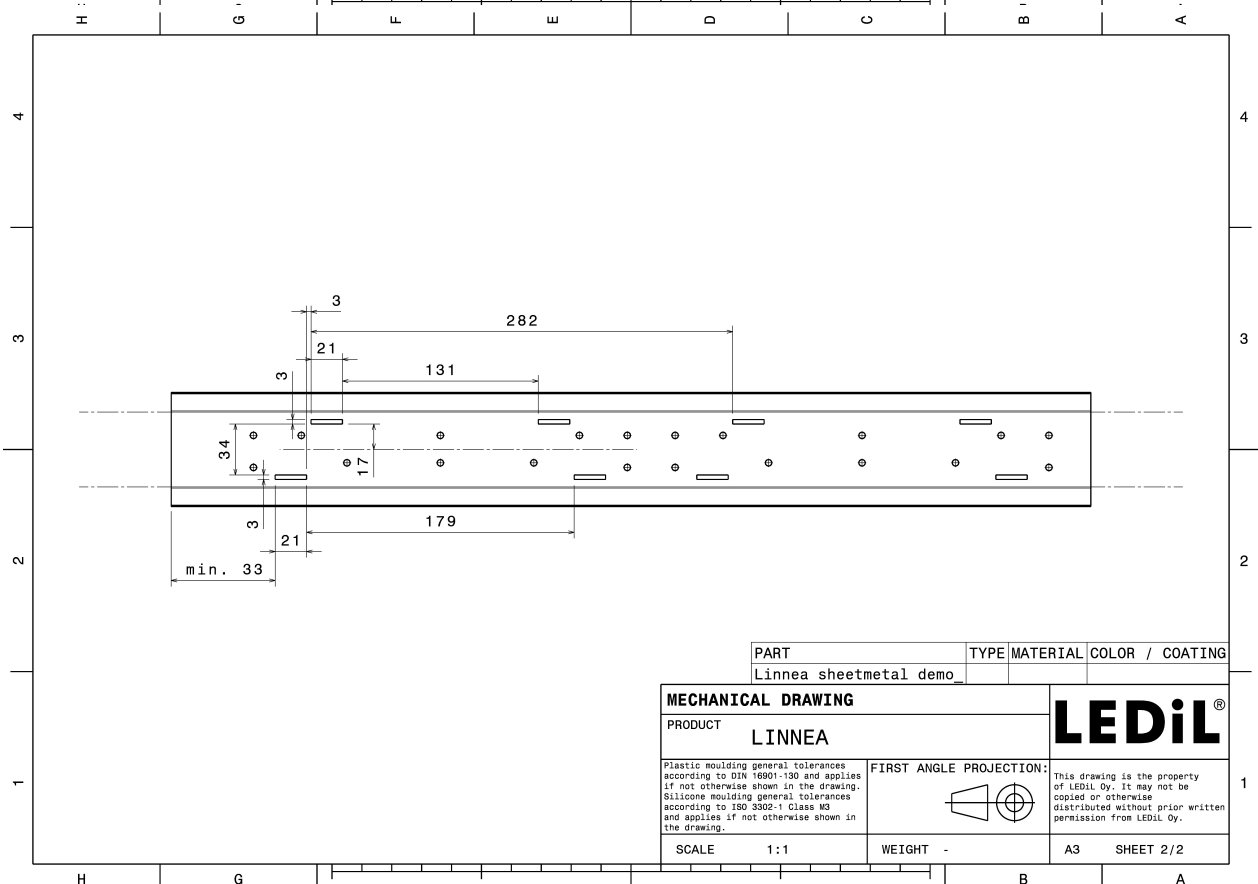
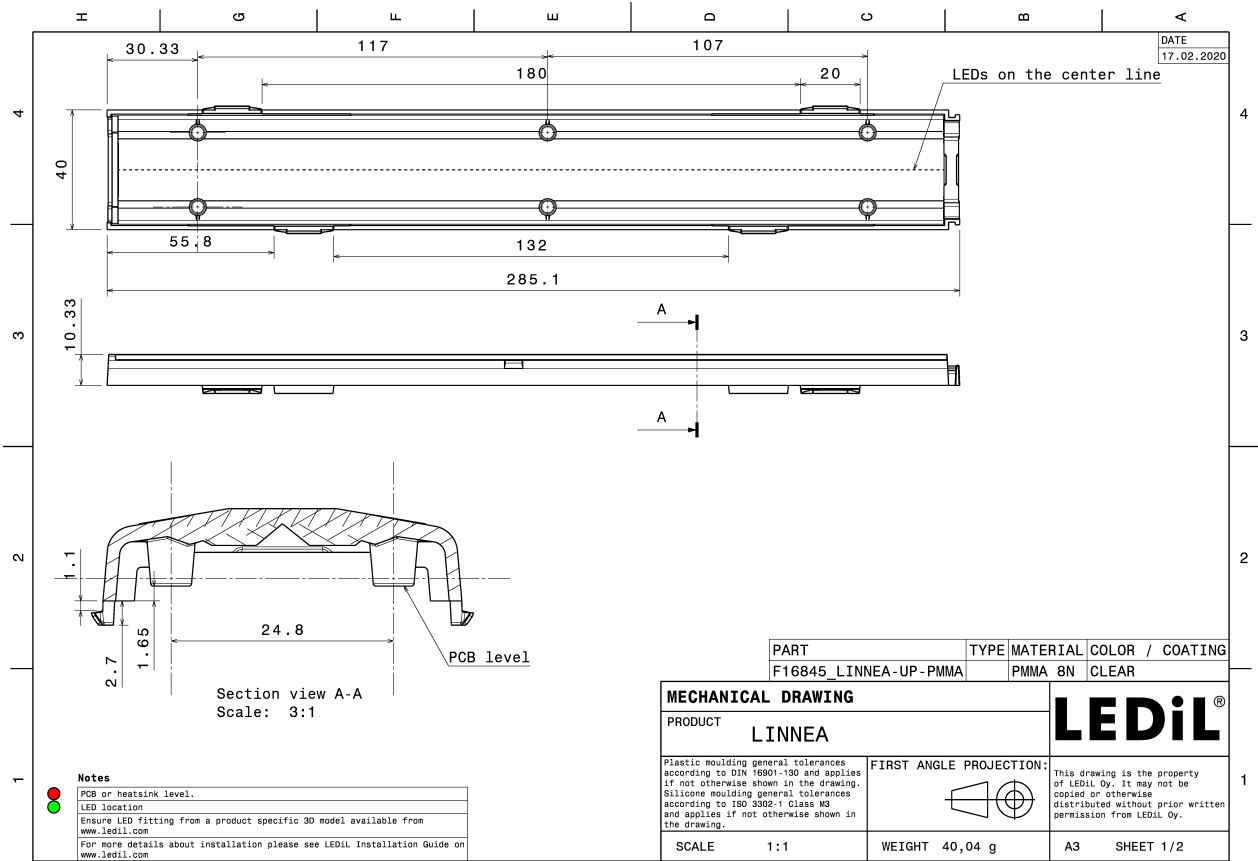

See also our general installation guide: www.ledil.com/installation_guide

PHOTOMETRIC DATA (MEASURED):

Helvar

LED LP-282-840-009A 60/300
 FWHM / FWTM Asymmetric
 Efficiency 85 %
 Peak intensity 0.3 cd/lm
 LEDs/each optic 1
 Light colour White
 Required components:

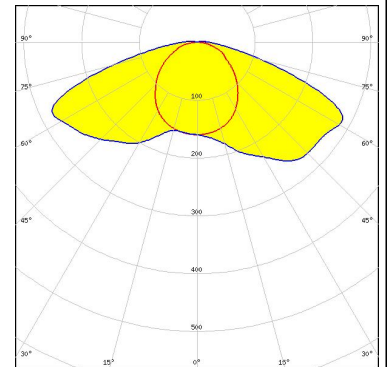

Helvar

LED LS-282-840-011A
 FWHM / FWTM Asymmetric
 Efficiency 85 %
 Peak intensity 0.3 cd/lm
 LEDs/each optic 1
 Light colour White
 Required components:

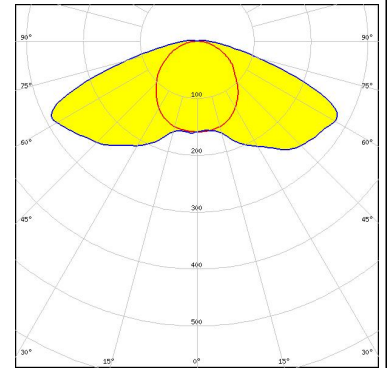

Helvar

LED LX-282-840-023A
 FWHM / FWTM Asymmetric
 Efficiency 85 %
 Peak intensity 0.3 cd/lm
 LEDs/each optic 1
 Light colour White
 Required components:

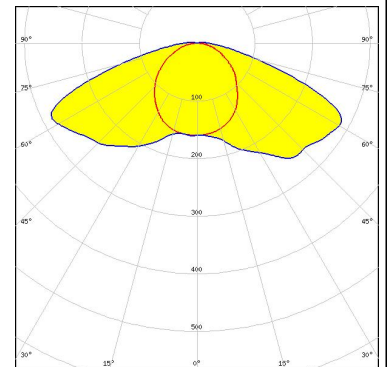

NICHIA

LED NF2x757G
 FWHM / FWTM Asymmetric
 Efficiency 90 %
 Peak intensity 0.3 cd/lm
 LEDs/each optic 1
 Light colour White
 Required components:

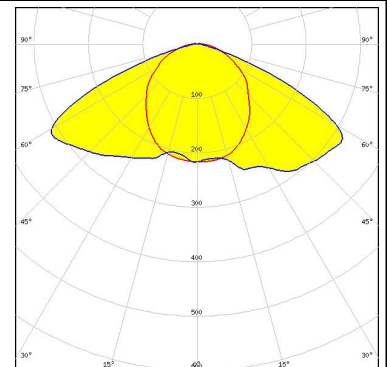

PHOTOMETRIC DATA (MEASURED):

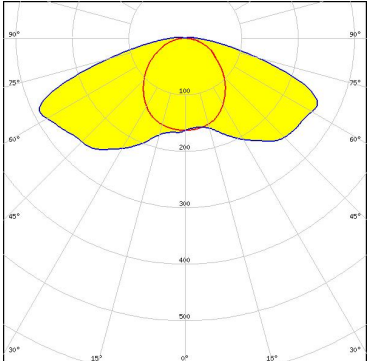
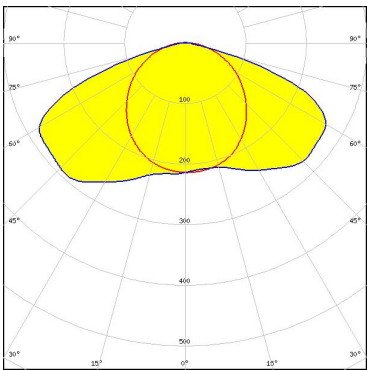
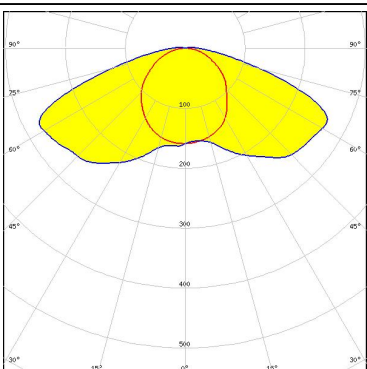
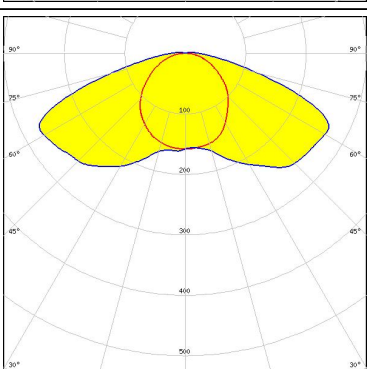
<p>NICHIA</p> <p>LED NFSW757H FWHM / FWTM Asymmetric Efficiency 85 % Peak intensity 0.3 cd/lm LEDs/each optic 1 Light colour White Required components:</p>	
<p>OSRAM</p> <p>LED PL-LIN-IND-Z1 2800 560x24 FWHM / FWTM Asymmetric Efficiency 90 % Peak intensity 0.3 cd/lm LEDs/each optic 1 Light colour White Required components:</p>	
<p>OSRAM</p> <p>LED PL-LIN-Z5 1100 280x20 FWHM / FWTM Asymmetric Efficiency 84 % Peak intensity 0.3 cd/lm LEDs/each optic 1 Light colour White Required components:</p>	
<p>OSRAM</p> <p>LED PL-LIN-Z5 2000 280x20 FWHM / FWTM Asymmetric Efficiency 84 % Peak intensity 0.3 cd/lm LEDs/each optic 1 Light colour White Required components:</p>	

PHOTOMETRIC DATA (MEASURED):

OSRAM

Opto Semiconductors

LED Duris E 2835
 FWHM / FWTM Asymmetric
 Efficiency 87 %
 Peak intensity 0.3 cd/lm
 LEDs/each optic 1
 Light colour White
 Required components:

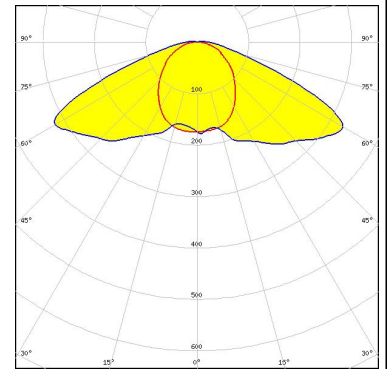

OSRAM

Opto Semiconductors

LED Duris S5 (Single chip)
 FWHM / FWTM Asymmetric
 Efficiency 87 %
 Peak intensity 0.3 cd/lm
 LEDs/each optic 1
 Light colour White
 Required components:

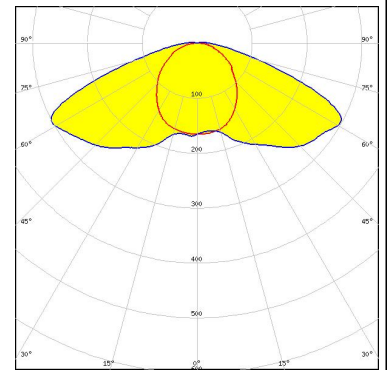

PHILIPS

LED Fortimo LED Strip 1ft 1100lm FC HV4 & LV4
 FWHM / FWTM Asymmetric
 Efficiency 85 %
 Peak intensity 0.3 cd/lm
 LEDs/each optic 1
 Light colour White
 Required components:

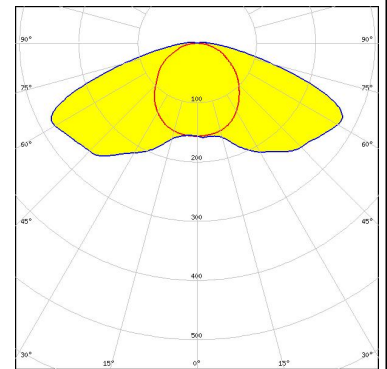

PHILIPS

LED Fortimo LED Strip 1ft 650lm FC HV4 & LV4
 FWHM / FWTM Asymmetric
 Efficiency 84 %
 Peak intensity 0.3 cd/lm
 LEDs/each optic 1
 Light colour White
 Required components:

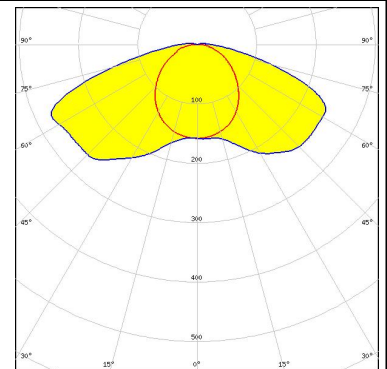

PHOTOMETRIC DATA (MEASURED):

SAMSUNG

LED LM28xB Series
 FWHM / FWTM Asymmetric
 Efficiency 87 %
 Peak intensity 0.3 cd/lm
 LEDs/each optic 1
 Light colour White
 Required components:

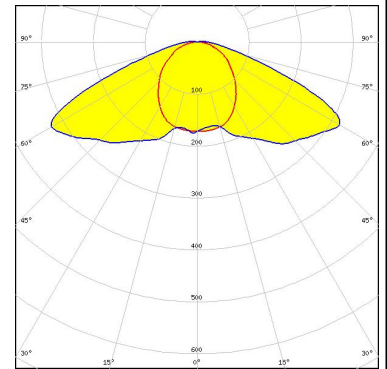

SAMSUNG

LED LM301B
 FWHM / FWTM Asymmetric
 Efficiency 86 %
 Peak intensity 0.3 cd/lm
 LEDs/each optic 1
 Light colour White
 Required components:

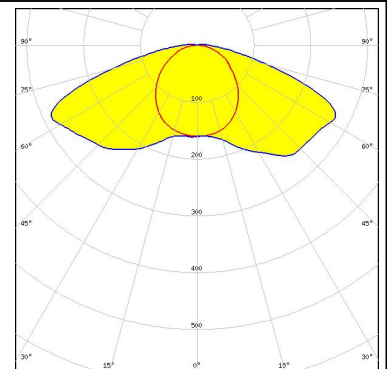

SAMSUNG

LED LM561B Plus
 FWHM / FWTM Asymmetric
 Efficiency 85 %
 Peak intensity 0.3 cd/lm
 LEDs/each optic 1
 Light colour White
 Required components:

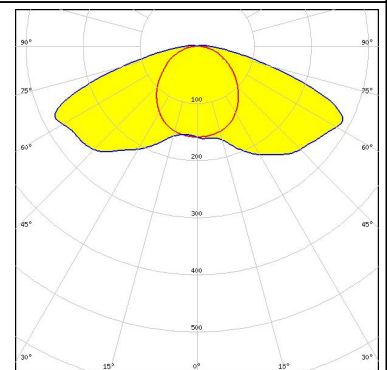

SAMSUNG

LED LT-H282C
 FWHM / FWTM Asymmetric
 Efficiency 85 %
 Peak intensity 0.3 cd/lm
 LEDs/each optic 1
 Light colour White
 Required components:

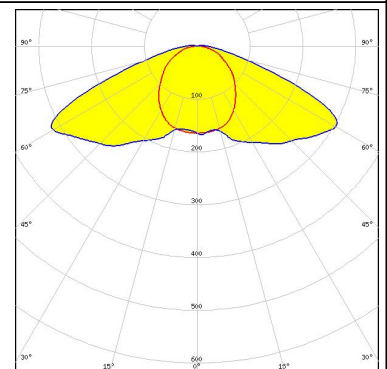

PHOTOMETRIC DATA (MEASURED):

SAMSUNG

LED LT-Q282B
FWHM / FWTM Asymmetric
Efficiency 87 %
Peak intensity 0.3 cd/lm
LEDs/each optic 1
Light colour White
Required components:

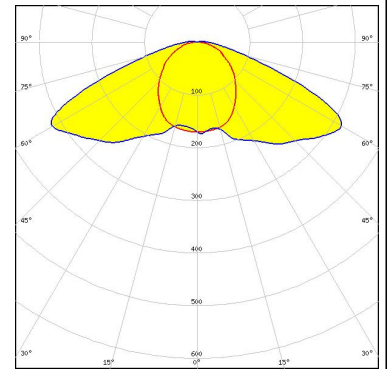

SAMSUNG

LED LT-V282E
FWHM / FWTM Asymmetric
Efficiency 87 %
Peak intensity 0.3 cd/lm
LEDs/each optic 1
Light colour White
Required components:

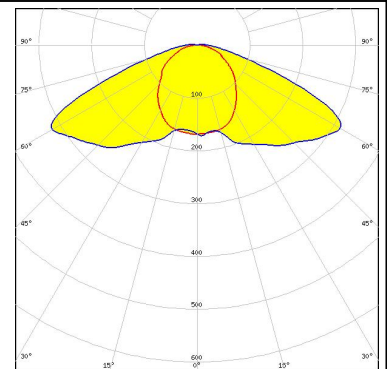

TRIDONIC

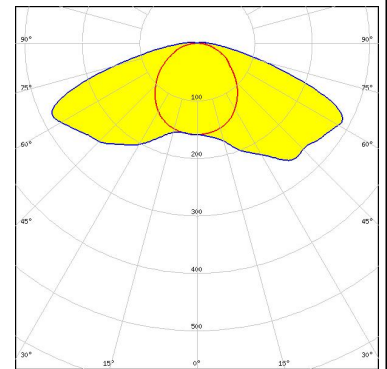

LED LLE 24x280mm 1250lm HV ADV5
FWHM / FWTM Asymmetric
Efficiency 85 %
Peak intensity 0.3 cd/lm
LEDs/each optic 1
Light colour White
Required components:



TRIDONIC

LED LLE 24x280mm 650lm HV ADV5
FWHM / FWTM Asymmetric
Efficiency 85 %
Peak intensity 0.3 cd/lm
LEDs/each optic 1
Light colour White
Required components:

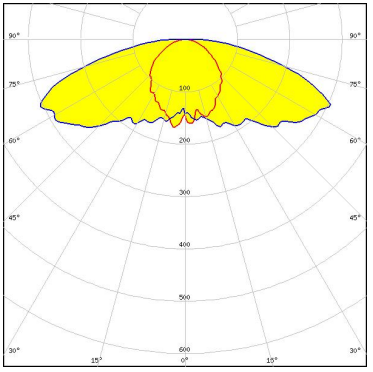
PHOTOMETRIC DATA (SIMULATED):

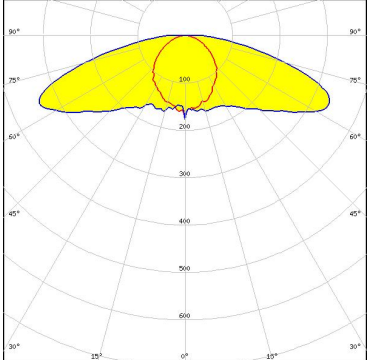
<p> SEOUL SEMICONDUCTOR</p> <p>LED: SEOUL 5630D</p> <p>FWHM / FWTM: Asymmetric</p> <p>Efficiency: 83 %</p> <p>Peak intensity: 0.3 cd/lm</p> <p>LEDs/each optic: 1</p> <p>Light colour: White</p> <p>Required components:</p>	
<p> SEOUL SEMICONDUCTOR</p> <p>LED: SEOUL DC 3030C</p> <p>FWHM / FWTM: Asymmetric</p> <p>Efficiency: 85 %</p> <p>Peak intensity: 0.3 cd/lm</p> <p>LEDs/each optic: 1</p> <p>Light colour: White</p> <p>Required components:</p>	

GENERAL INFORMATION:

NOTE: The typical beam angle will be changed by different color, chip size and chip position tolerance. The typical total beam angle is the full angle measured where the luminous intensity is half of the peak value.

MATERIALS:

As part of our continuous research and improvement processes, and to ensure the best possible quality and availability of our products, LEDiL reserves the right to change material grades without notice.

PRODUCT DATA USER AGREEMENT AND DISCLAIMER:

The measured data in the provided downloadable LEDiL Product Datasheets and Mechanical 2D-Drawings is rounded and provided as reference for planning. LEDiL Oy's optical specifications have been verified by conducting performance testing of the products in accordance with the company's quality system. The reported data are averaged results of multiple measurements with typical variation. LEDiL Oy reserves the right to without prior notification make changes and improvements to its products.

LEDiL Oy assumes neither warranty, nor guarantee nor any other liability of any kind for the contents and correctness of the provided data. The provided data has been generated with highest diligence but the provided data may in reality not represent the complete possible variation range of all intrinsic parameters. Therefore, in certain cases a deviation from the provided data could occur.

LEDiL Oy reserves the right to undertake technical changes of its products without further notification which could lead to changes in the provided data. LEDiL Oy assumes no liability of any kind for the possible deviation from any provided data or any other damage resulting from the usage of the provided data.

The user agrees to this disclaimer and user agreement with the download or usage of the provided files.

LEDiL Oy

Joensuunkatu 13
FI-24240 SALO
Finland

LEDiL Inc.

228 West Page Street
Suite D
Sycamore IL 60178
USA

Ledil Optics Technology (Shenzhen) Co., Ltd.

405 , Block B
Casic Motor Building
Shenzhen 518057
P.R.CHINA

Local sales and technical support

[www.ledil.com/
where_to_buy](http://www.ledil.com/where_to_buy)

Shipping locations

Salo, Finland
Hong Kong, China

Distribution Partners

[www.ledil.com/
where_to_buy](http://www.ledil.com/where_to_buy)