

DATE	REV	ECN	APP'D. BY
8-11-17	A2	11061	TRM
8-16-17	A3	11066	TRM
9-11-19	A4	11444	ADB

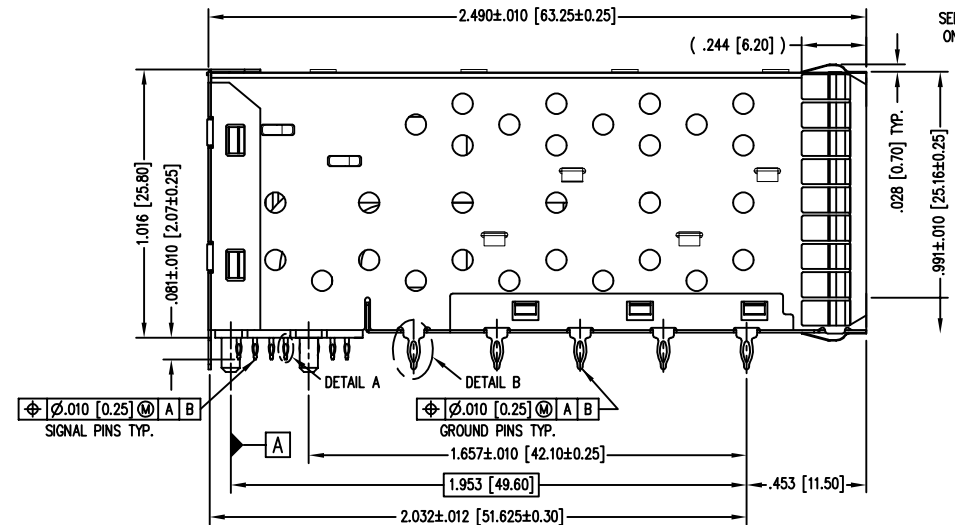

SEE DETAIL C ON SHEET 2

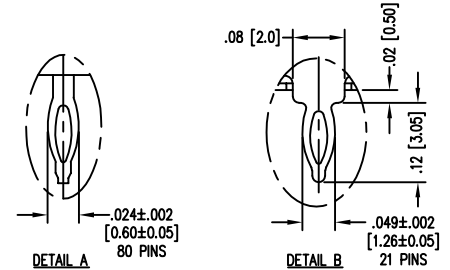
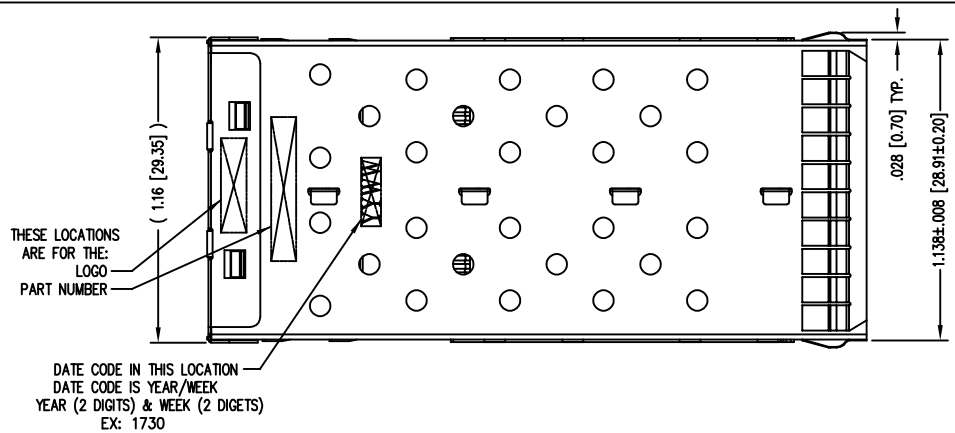
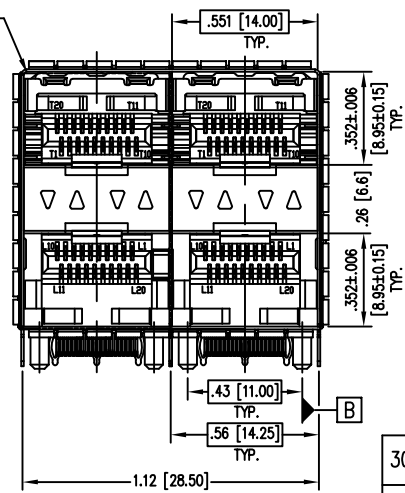

30 MICRO-INCHES [0.76um]	SS-79100-011	WITH LIGHT PIPE
30 MICRO-INCHES [0.76um]	SS-79100-012	WITHOUT LIGHT PIPE
CONTACT PLATING IN MATING AREA	PART NUMBER	

- NOTES:
- MATERIALS:
CONTACT: PHOSPHOR BRONZE
CONNECTOR HOUSING: LCP UL 94V-0 COLOR: BLACK
MOLDED INSERT: HIGH TEMP PLASTIC UL 94V-0 COLOR: BLACK
CAGE: COPPER ALLOY
LIGHT PIPES: POLYCARBONATE UL 94V-0 COLOR: CLEAR
LIGHT PIPE HOUSING: PBT UL 94V-0 COLOR: BLACK
EMI SPRINGS: COPPER ALLOY
 - PLATING:
PCB PINS: 0.0001 [2.54um] MINIMUM MATTE TIN OVER 0.00005 [1.27um] MINIMUM NICKEL
CAGE: NICKEL
 - TEMPERATURE:
OPERATIONAL: -40°C~+85°C
STORAGE: -55°C~+105°C
 - FOR PRODUCT SPECIFICATIONS SEE PR043-01.
 - MATES WITH SFP MSA COMPLIANT TRANSCEIVERS.



THIRD ANGLE PROJECTION

DRAWING IS SUBJECT TO CHANGE WITHOUT NOTICE

UNLESS OTHERWISE SPECIFIED DIMENSIONS INCHES [METRIC]

TOLERANCES ARE:

ANGLES ± 2°

1 PLG. DEC. ±.010" [±0.25]

2 PLG. DEC. ±.005" [±0.13]

3 PLG. DEC. ±.004" [±0.10]

DO NOT SCALE DRAWING

SHEET NO. 1 OF 4

11118 Susquehanna Trail South
Glen Rock, PA 17327-9199
(717) 235-7512
<http://www.stewartconnector.com>

TITLE: SFP+ 2X2 CAGE WITH EMI CLIP, PRESS FIT
SFP+ 2X2 CAGE W/LIGHT PIPES, PRESS FIT

THIS DRAWING AND THE SUBJECT MATTER SHOWN THEREON ARE CONFIDENTIAL AND THE PROPRIETARY PROPERTY OF STEWART CONNECTOR AND SHALL NOT BE REPRODUCED, COPIED, OR USED IN ANY MANNER WITHOUT PRIOR WRITTEN CONSENT OF STEWART CONNECTOR. ONE OR MORE U.S. PATENTS MAY APPLY TO THIS PRODUCT. FOR DETAILS, PLEASE VISIT: [HTTP://BELFUSE.COM/STEWART/STEWART_PATENTS/](http://BELFUSE.COM/STEWART/STEWART_PATENTS/)

DRN BY: TRM	DATE: 6-14-17
APPD BY: DHG	DATE: 6-30-17
DWG NO. CT790011	REV. A4

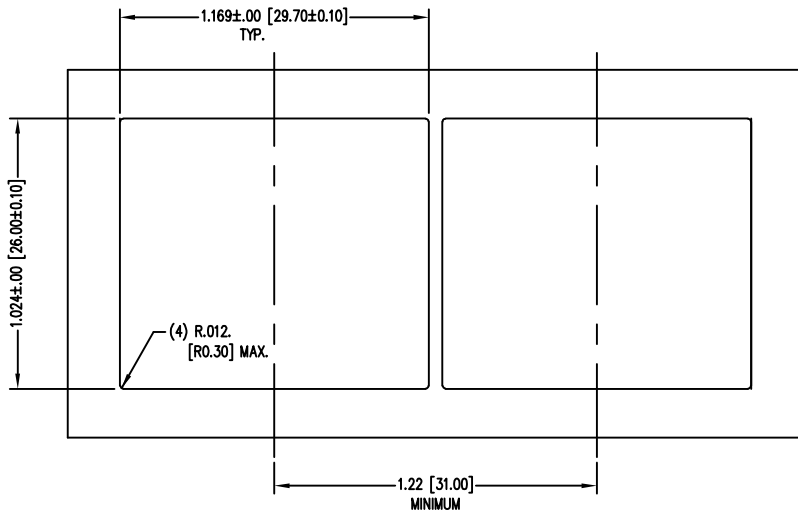

BEZEL CUT-OUT CENTER SPACING DETAIL
BEZEL THICKNESS: .03 [0.8] - .10 [2.6]

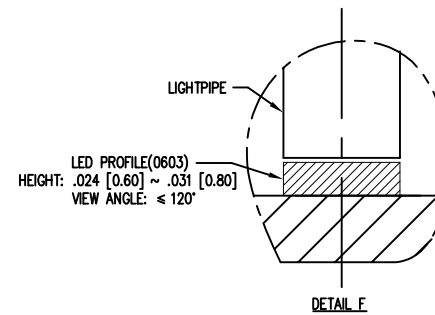
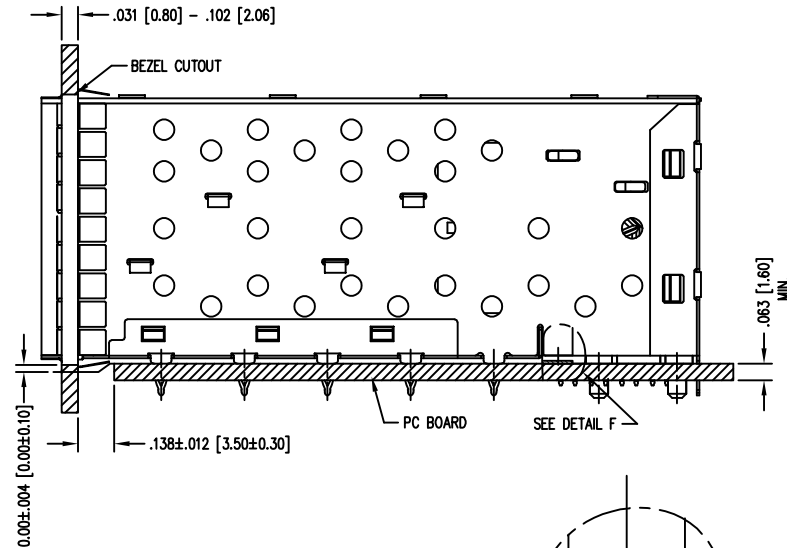

DETAIL F

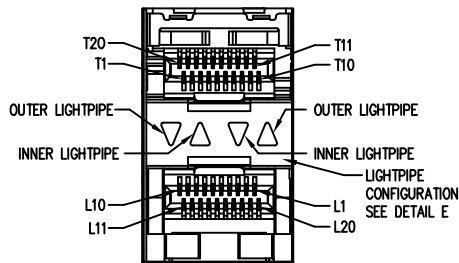

DETAIL C

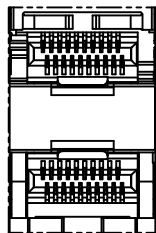

NO LIGHTPIPES
SS-79100-012

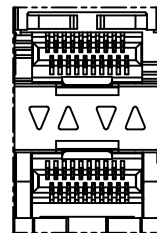

4 LIGHTPIPES
SS-79100-011

DETAIL E



THIRD ANGLE PROJECTION

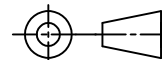

DRAWING IS SUBJECT TO CHANGE WITHOUT NOTICE

UNLESS OTHERWISE SPECIFIED DIMENSIONS INCHES [METRIC]

TOLERANCES ARE:

- ANGLES ± 2°
- 1 PLC. DEC. ±.010" [±0.25]
- 2 PLC. DEC. ±.005" [±0.13]
- 3 PLC. DEC. ±.004" [±0.10]

DO NOT SCALE DRAWING

SHEET NO. 2 OF 4

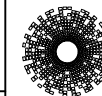

stewart
CONNECTOR
a bel group

11118 Susquehanna Trail South
Glen Rock, PA 17327-9199
(717) 235-7512

<http://www.stewartconnector.com>

TITLE: SFP+ 2X2 CAGE WITH EMI CLIP, PRESS FIT
SFP+ 2X2 CAGE W/LIGHT PIPES, PRESS FIT

THIS DRAWING AND THE SUBJECT MATTER SHOWN THEREON ARE CONFIDENTIAL AND THE PROPRIETARY PROPERTY OF STEWART CONNECTOR AND SHALL NOT BE REPRODUCED, COPIED, OR USED IN ANY MANNER WITHOUT PRIOR WRITTEN CONSENT OF STEWART CONNECTOR. ONE OR MORE U.S. PATENTS MAY APPLY TO THIS PRODUCT. FOR DETAILS, PLEASE VISIT: [HTTP://BELFUSE.COM/STEWART/STEWART_PATENTS/](http://BELFUSE.COM/STEWART/STEWART_PATENTS/)

DRN BY: TRM DATE 6-14-17

APPD BY: DHG DATE 6-30-17

DWG NO. CT790011 REV. A4

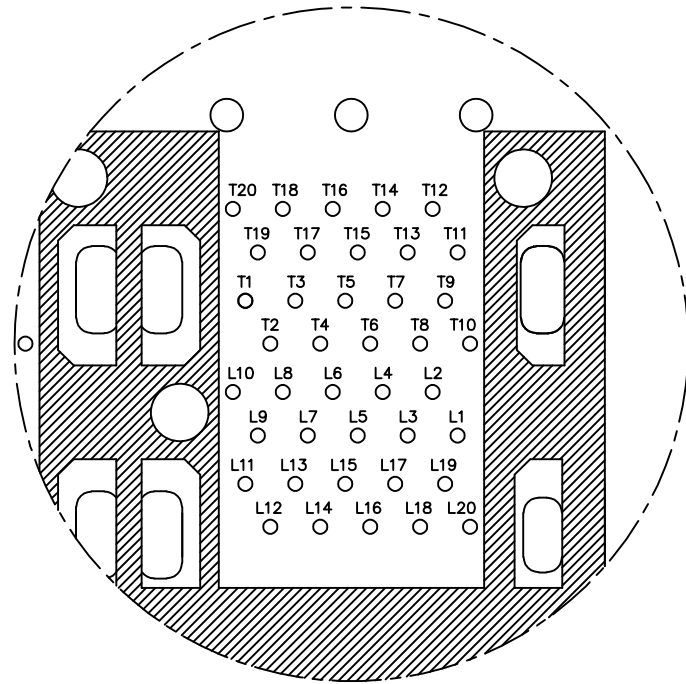
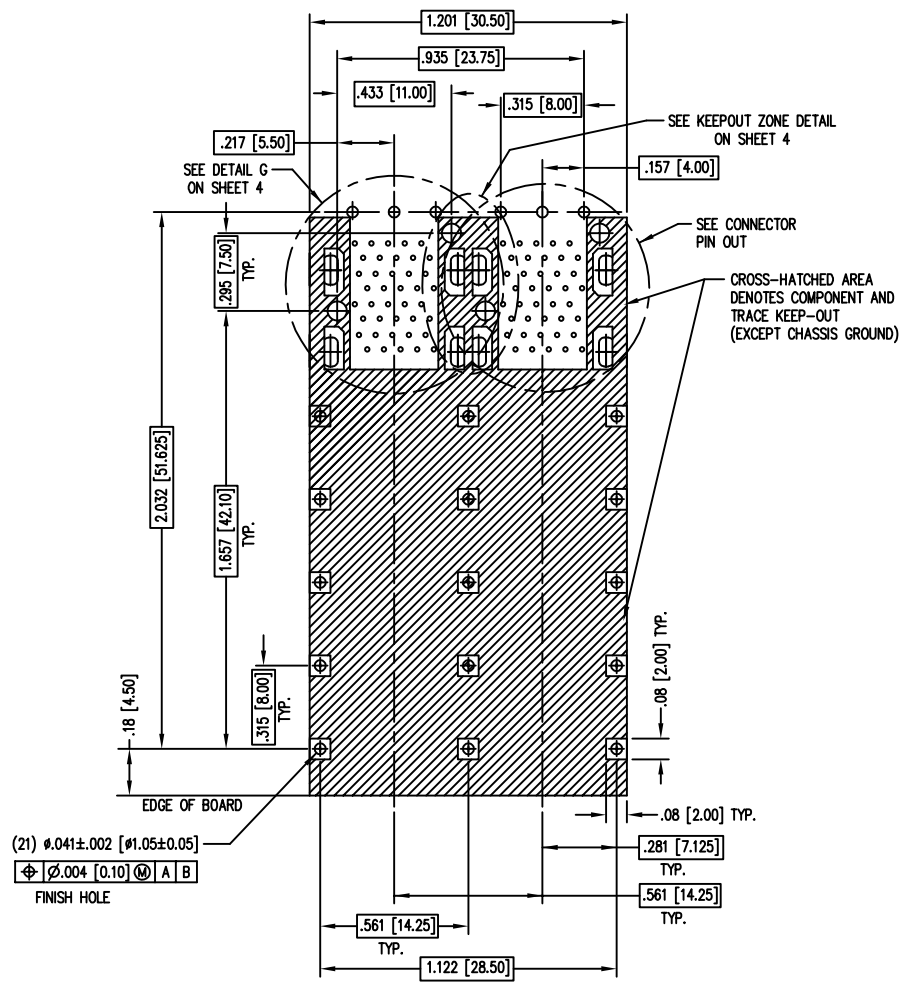

CONNECTOR PIN-OUT
COMPONENT SIDE OF BOARD

RECOMMENDED PCB LAYOUT - COMPONENT SIDE
 RECOMMENDED PCB THICKNESS - .104 [2.63]
 THE ENTIRE AREA OF THE CONNECTOR FOOTPRINT
 TO BE CONSIDERED THE KEEP OUT AREA FOR COMPONENTS
 (OTHER THAN LIGHTPIPE LEADS)
 THIS AREA IS INDICATED BY THE DASHED LINE



THIRD ANGLE PROJECTION 		11118 Susquehanna Trail South Glen Rock, PA 17327-9199 (717) 235-7512 http://www.stewartconnector.com	
		TITLE: SFP+ 2X2 CAGE WITH EMI CLIP, PRESS FIT SFP+ 2X2 CAGE W/LIGHT PIPES, PRESS FIT	
DRAWING IS SUBJECT TO CHANGE WITHOUT NOTICE UNLESS OTHERWISE SPECIFIED DIMENSIONS INCHES [METRIC] TOLERANCES ARE: ANGLES ± 2° 1 PL.C. DEC. ±.010" [±0.25] 2 PL.C. DEC. ±.005" [±0.13] 3 PL.C. DEC. ±.004" [±0.10] DO NOT SCALE DRAWING		DRN BY: TRM APPD BY: DHG DWG NO. CT790011	DATE 6-14-17 DATE 6-30-17 REV. A4
SHEET NO. 3 OF 4		THIS DRAWING AND THE SUBJECT MATTER SHOWN THEREON ARE CONFIDENTIAL AND THE PROPRIETARY PROPERTY OF STEWART CONNECTOR AND SHALL NOT BE REPRODUCED, COPIED, OR USED IN ANY MANNER WITHOUT PRIOR WRITTEN CONSENT OF STEWART CONNECTOR. ONE OR MORE U.S. PATENTS MAY APPLY TO THIS PRODUCT. FOR DETAILS, PLEASE VISIT: HTTP://BELFUSE.COM/STEWART/STEWART_PATENTS/	

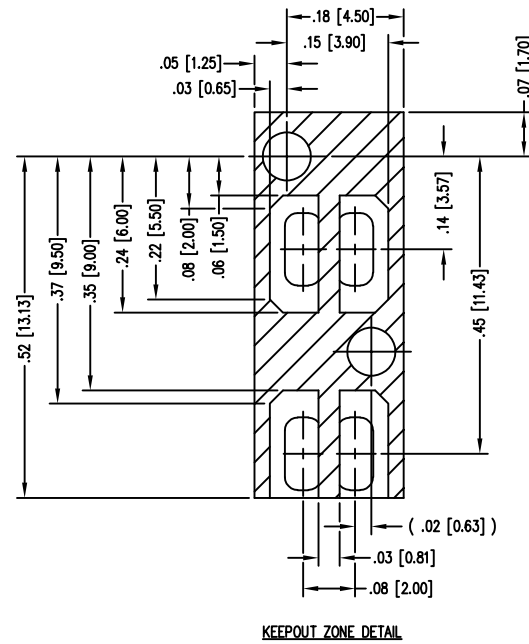
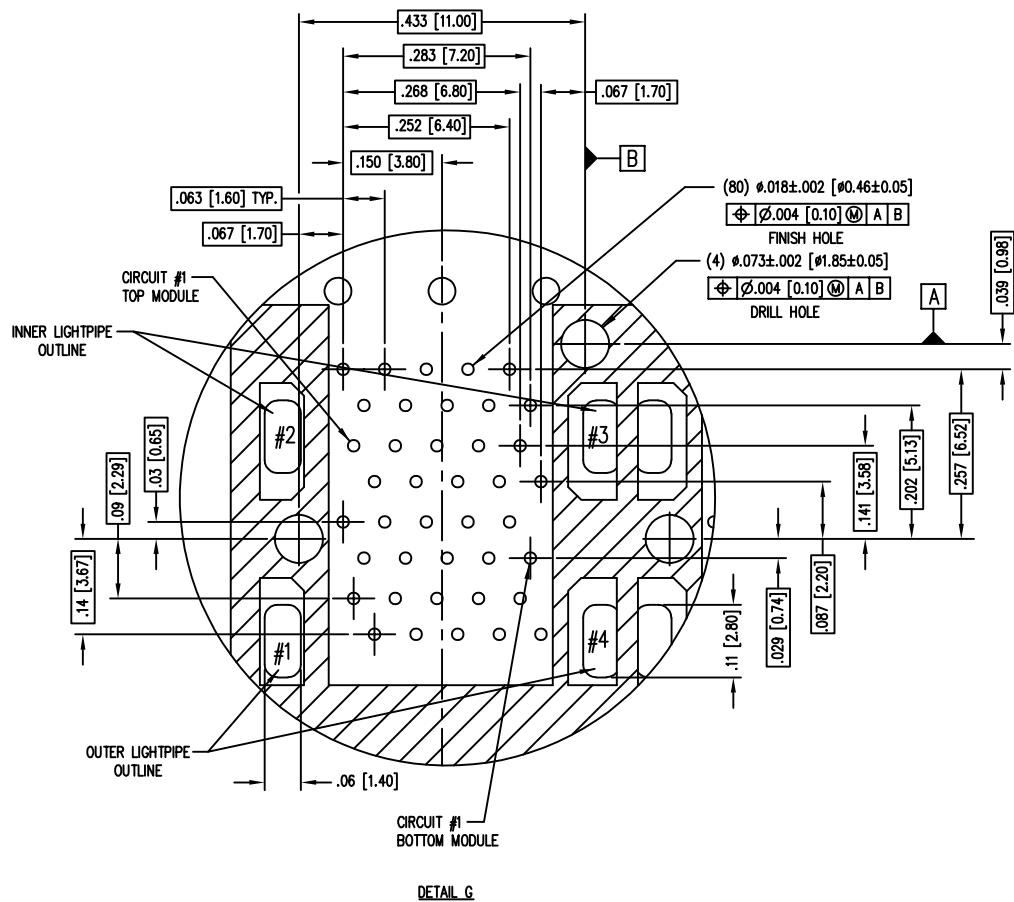

THIRD ANGLE PROJECTION

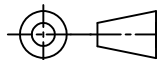

DRAWING IS SUBJECT TO CHANGE WITHOUT NOTICE

UNLESS OTHERWISE SPECIFIED DIMENSIONS INCHES [METRIC]

TOLERANCES ARE:
 ANGLES ± 2°
 1 PLG. DEC. ±.010" [±0.25]
 2 PLG. DEC. ±.005" [±0.13]
 3 PLG. DEC. ±.004" [±0.10]
 DO NOT SCALE DRAWING

SHEET NO. 4 OF 4



stewart
 CONNECTOR
 a bel group

11118 Susquehanna Trail South
 Glen Rock, PA 17327-9199
 (717) 235-7512

<http://www.stewartconnector.com>

TITLE: SFP+ 2X2 CAGE WITH EMI CLIP, PRESS FIT
 SFP+ 2X2 CAGE W/LIGHT PIPES, PRESS FIT

THIS DRAWING AND THE SUBJECT MATTER SHOWN THEREON ARE CONFIDENTIAL AND THE PROPRIETARY PROPERTY OF STEWART CONNECTOR AND SHALL NOT BE REPRODUCED, COPIED, OR USED IN ANY MANNER WITHOUT PRIOR WRITTEN CONSENT OF STEWART CONNECTOR. ONE OR MORE U.S. PATENTS MAY APPLY TO THIS PRODUCT. FOR DETAILS, PLEASE VISIT: [HTTP://BELFUSE.COM/STEWART/STEWART_PATENTS/](http://BELFUSE.COM/STEWART/STEWART_PATENTS/)

DRN BY: TRM DATE 6-14-17

APPD BY: DHG DATE 6-30-17

DWG NO. CT790011 REV. A4

