

## General Specifications

Motor Type: DC Brushless Motor

Motor Protection: Auto Restart/Polarity Protection

Motor withstands reverse connection for positive and negative leads.

Insulation Resistance:

10M  $\Omega$  or over with a DC500V Megger

Dielectric Withstand Voltage:

AC 700V 1s or 500V 1min

Allowable Ambient Temperature Range:

-10°C ~ +70°C (Operating)

-40°C ~ +70°C (Storage)

(non-condensing environment)

## Characteristics Curves

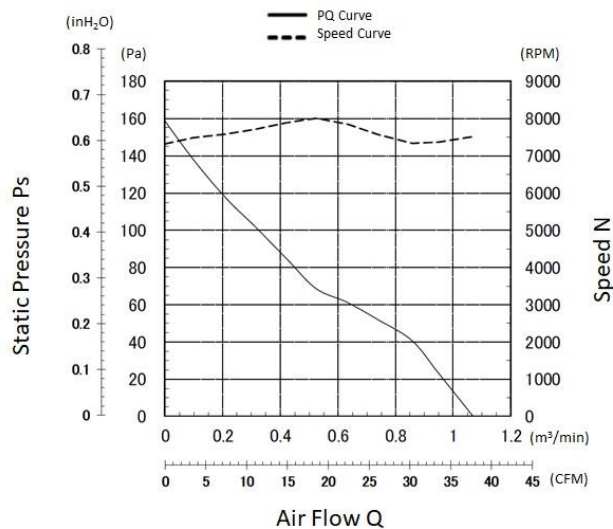

## PWM Benefits & Applications

### PWM Benefits

- Increased Life Expectancy
- Energy Saving
- Lower Vibration
- Lower Noise
- Current Spike Prevention

### PWM Applications

- Routers
- Switches
- Storage
- Data Centers
- Optical Repeaters
- Broadcast Equipment
- Inverters
- UPS
- Battery Chargers
- Fuel Cells
- Industrial Power Supplies
- Welders
- Plasma Cutters
- Instrumentation
- Test Equipment
- Enclosures and more

- Customized fan performances at multiple operating points.
- Peak efficiency resulting in lower total ownership costs.
- Cost effective and better reliability.

## Life Expectancy L10

25°C 90,000 Hours

## Specifications

MODEL	Rated Voltage	Operating Voltage	Current		Input Power		Speed	Max. Air Flow		Max. Static Pressure		Noise	Mass
	(V)	(V)	Avg	Max	Avg	Max		(CFM)	( $m^3/min$ )	(inH <sub>2</sub> O)	(Pa)		
	(V)	(V)	(A) <sup>*1</sup>	(A) <sup>*1</sup>	(W) <sup>*1</sup>	(W) <sup>*1</sup>	( $min^{-1}$ ) <sup>*1</sup>	(CFM)	( $m^3/min$ )	(inH <sub>2</sub> O)	(Pa)	(dB) <sup>*1</sup>	(g)
06025SA-12T-AU-D3	12	10.8 ~ 13.2	0.43	0.66	5.16	7.92	7500	37.8	1.07	0.64	158.5	47.0	65

\*1: Values in Free Air

## PWM Specifications

### PWM CONTROL CONNECTION

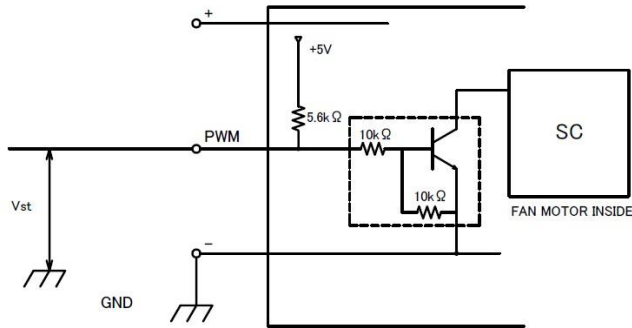

#### 1. PWM Control

- V<sub>st</sub> = Low Level (0V~0.4V) → Low Speed(On Duty 0%)
- V<sub>st</sub> = High Level (4.0V~5.0V) → Full Speed(On Duty 100%)
- V<sub>st</sub> = Open → Full Speed

#### 2. PWM Duty & PWM Input Pulse

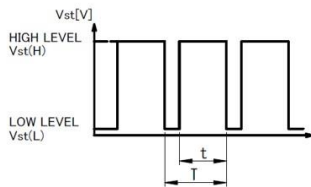

PWM Duty means that a ration of high level time (t)/PWM Input Pulse(T).

$$(t/T) \times 100 : \text{On Duty } 0\% \sim 100\%$$

PWM Frequency  $f = 25[\text{kHz}]$

## TACHO Specifications

### TACHOMETER SIGNAL

1. OUTPUT CIRCUIT : OPEN COLLECTOR
2. SPECIFICATION  
T<sub>a</sub>=25°C  
Absolute Maximum Ratings at T<sub>a</sub>=25°C  
V<sub>CE</sub> max : +15V  
I<sub>c</sub> max : 5mA [V<sub>CE(sat)</sub>max = 0.5V]

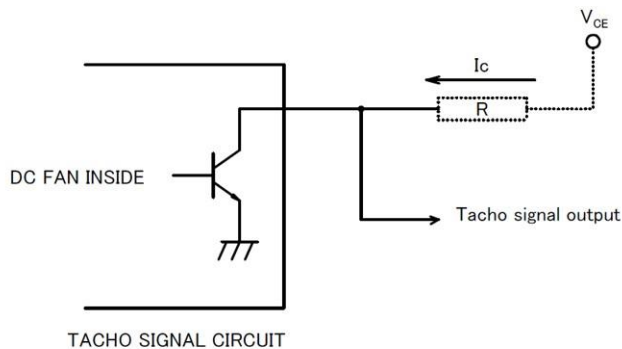

## PWM Characteristics Curve

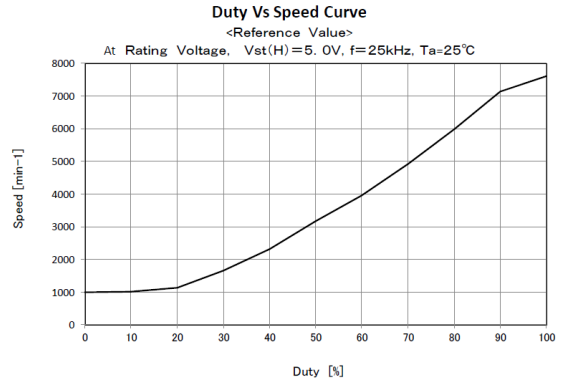

#### 3. The condition for PWM control are as follows.

- When you use this under PWM control, always be sure the motor's operation under practical mounting state.
- Fan motor may not start up caused by PWM control at very low speed condition.
- To run at Rating Voltage.

#### 3. OUTPUT WAVEFORM : AT RATED VOLTAGE

##### OUTPUT SIGNAL VOLTAGE

##### 3-1 Case-1

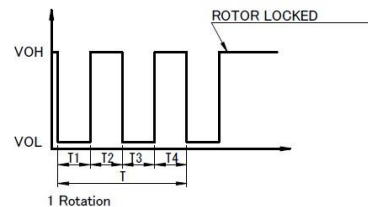

##### 3-2 Case-2

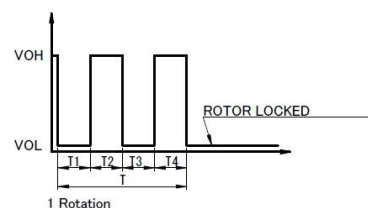

- 1) When the rotor is locked at VOH position of signal, signal keeps VOH position.
- 2) When the rotor is locked at VOL position of signal, signal keeps VOL position.
- 3)  $T = T1 + T2 + T3 + T4 = 60/m$  / m = 1 rotation

m : min - 1

Tach Duty Cycle = 50% ± 10%

## Panel Cut-Outs

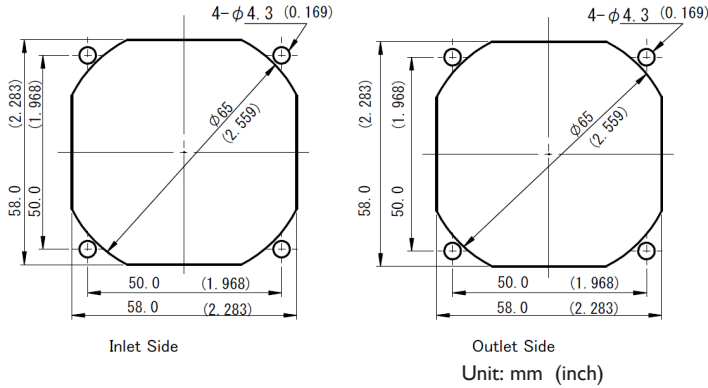

## Materials

- Casing : Plastic (Black UL94V-0)
- Impeller : Plastic (Black UL94V-0)
- Bearing : Ball Bearing
- Lead Wire : UL10368 AWG26
  - (+) : Red (-) : Black
  - PWM : Brown Tach : White

## Outline

Name Plate

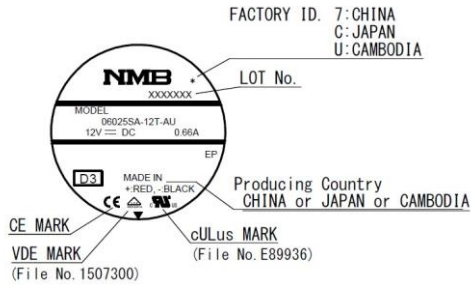

## RIB TYPE

