

Sensor/actuator cable - SAC-4P-M 8MS-M12FS/.../... - 1506697

Please be informed that the data shown in this PDF Document is generated from our Online Catalog. Please find the complete data in the user's documentation. Our General Terms of Use for Downloads are valid (<http://phoenixcontact.com/download>)



Sensor/actuator cable, 4-position, Variable cable type, Plug straight M8, on Socket straight M12, A-coded, cable length: Free input (0.2 ... 40.0 m)

Your advantages

- ✓ Easy and safe: 100% electrically tested plug-in components
- ✓ Flexible solutions - configurable materials with variable cable types and cable lengths

Key Commercial Data

| | |
|------------------------|-------|
| Packing unit | 1 pc |
| Minimum order quantity | 25 pc |

Technical data

Dimensions

| | |
|-----------------|-----------------------------|
| Length of cable | Free input (0.2 ... 40.0 m) |
|-----------------|-----------------------------|

Ambient conditions

| | |
|---------------------------------|----------------------------------|
| Ambient temperature (operation) | -25 °C ... 90 °C (Plug / socket) |
| Degree of protection | IP65/IP67 |

General

| | |
|------------------------------|-------------------------------|
| Rated current at 40°C | 4 A |
| Rated voltage | 48 V AC |
| | 60 V DC |
| Number of positions | 4 |
| Insulation resistance | ≥ 100 MΩ |
| Coding | A - standard |
| Standards/regulations | M12 connector IEC 61076-2-101 |
| | M8 connector IEC 61076-2-104 |
| Status display | No |
| Protective circuit/component | unwired |
| Overvoltage category | II |
| Degree of pollution | 3 |
| Insertion/withdrawal cycles | ≥ 100 |
| Torque | 0.4 Nm (M12 connector) |

Sensor/actuator cable - SAC-4P-M 8MS-M12FS/.../... - 1506697

Technical data

General

| | |
|--|------------------------|
| | 0.2 Nm (M8 connectors) |
|--|------------------------|

Material

| | |
|--|---|
| Flammability rating according to UL 94 | HB |
| Contact material | CuSn |
| Contact surface material | Ni/Au |
| Contact carrier material | TPU GF |
| Material of grip body | TPU, hardly inflammable, self-extinguishing |
| Material, knurls | Zinc die-cast, nickel-plated |
| Sealing material | NBR |

Line characteristics

| | |
|------|---|
| Note | This item is a sensor/actuator cable with a freely selectable cable type. The technical data for all possible cable types is listed in the table below. |
|------|---|

Standards and Regulations

| | |
|--|-----------------|
| Standard designation | M12 connector |
| Standards/regulations | IEC 61076-2-101 |
| Standard designation | M8 connector |
| Standards/regulations | IEC 61076-2-104 |
| Flammability rating according to UL 94 | HB |

PUR halogen-free black [PUR]

| | |
|---|---------------------------------------|
| Cable type | PUR halogen-free black |
| Cable type (abbreviation) | PUR |
| Cable abbreviation | Li9Y11Y-HF |
| Conductor cross section | 4x 0.25 mm ² (Signal line) |
| AWG signal line | 24 |
| Conductor structure signal line | 32x 0.10 mm |
| Core diameter including insulation | 1.17 mm ±0.02 mm (Signal line) |
| Thickness, insulation | ≥ 0.21 mm (Core insulation) |
| | approx. 0.5 mm (Outer cable sheath) |
| Wire colors | brown, white, blue, black |
| Overall twist | 4 wires, twisted |
| External sheath, color | black-gray RAL 7021 |
| External cable diameter D | 3.95 mm ±0.15 mm |
| Smallest bending radius, fixed installation | 20 mm |
| Smallest bending radius, movable installation | 40 mm |
| Number of bending cycles | 10000000 |
| Bending radius | 44 mm |
| Traversing path | 10 m |
| Traversing rate | 3 m/s |
| Acceleration | 5 m/s ² |

Sensor/actuator cable - SAC-4P-M 8MS-M12FS/.../... - 1506697

Technical data

PUR halogen-free black [PUR]

| | |
|---------------------------------|---|
| Cable weight | 23 kg/km |
| Outer sheath, material | PUR |
| Material conductor insulation | PP |
| Conductor material | Bare Cu litz wires |
| Insulation resistance | ≥ 100 GΩ*km (at 20 °C) |
| Conductor resistance | max. 78 Ω/km (at 20 °C) |
| Nominal voltage, cable | ≤ 300 V |
| Test voltage, cable | ≥ 3000 V |
| Special properties | Flexible cable conduit capable |
| | Silicone-free |
| | Free of substances which would hinder coating with paint or varnish |
| Flame resistance | in accordance with UL 758/1581 FT2 |
| | DIN EN 60332-2-2 (20 s) |
| Halogen-free | in accordance with DIN VDE 0472 part 815 |
| Resistance to oil | in accordance with DIN EN 60811-2-1 |
| Other resistance | Highly resistant to acids, alkaline solutions and solvents |
| | hydrolysis and microbe resistant |
| | partly UV-resistant in accordance with DIN EN ISO 4892-2-A |
| Ambient temperature (operation) | -40 °C ... 80 °C (cable, fixed installation) |
| | -25 °C ... 80 °C (cable, flexible installation) |

PUR/PVC gray [100]

| | |
|---|---------------------------------------|
| Cable type | PUR/PVC gray |
| Cable type (abbreviation) | 100 |
| Cable abbreviation | LiYY-11Y |
| Conductor cross section | 0.25 mm ² |
| AWG signal line | 24 |
| Conductor structure signal line | 32x 0.10 mm |
| Core diameter including insulation | 1.32 mm ±0.02 mm |
| Thickness, insulation | ≥ 0.23 mm (Core insulation) |
| | ≥ 0.38 mm (Outer cable sheath) |
| | approx. 3.8 mm ±0.1 mm (Inner sheath) |
| Wire colors | brown, white, blue, black |
| Overall twist | 4 wires, twisted |
| External sheath, color | gray RAL 7001 |
| External cable diameter D | 4.7 mm ±0.2 mm |
| Smallest bending radius, fixed installation | 47 mm |
| Smallest bending radius, movable installation | 47 mm |
| Number of bending cycles | 2000000 |
| Bending radius | 47 mm |
| Traversing path | 5 m |

Sensor/actuator cable - SAC-4P-M 8MS-M12FS/.../... - 1506697

Technical data

PUR/PVC gray [100]

| | |
|---------------------------------|--|
| Traversing rate | 3 m/s |
| Cable weight | 32 kg/km |
| Outer sheath, material | PUR |
| Material, inner sheath | PVC |
| Material conductor insulation | PVC |
| Conductor material | Bare Cu litz wires |
| Insulation resistance | ≥ 100 MΩ*km (at 20 °C) |
| Conductor resistance | max. 78 Ω/km (at 20 °C) |
| Nominal voltage, cable | ≤ 300 V |
| Test voltage, cable | ≥ 3000 V |
| Flame resistance | in accordance with DIN UL-Style 20549 |
| Ambient temperature (operation) | -25 °C ... 80 °C (cable, fixed installation) |
| | -5 °C ... 80 °C (cable, flexible installation) |

PUR halogen-free yellow [240]

| | |
|---|---------------------------------------|
| Cable type | PUR halogen-free yellow |
| Cable type (abbreviation) | 240 |
| Cable abbreviation | Li9Y11Y |
| UL AWM style | 20549 |
| Conductor cross section | 4x 0.25 mm ² (Signal line) |
| AWG signal line | 24 |
| Conductor structure signal line | 32x 0.10 mm |
| Core diameter including insulation | 1.17 mm ±0.02 mm |
| Thickness, insulation | ≥ 0.21 mm |
| Wire colors | brown, white, blue, black |
| Overall twist | 4 wires, twisted |
| Length of twist, overall twist | 45 mm |
| External sheath, color | yellow |
| Outer sheath thickness | approx. 0.75 mm |
| External cable diameter D | 4.4 mm ±0.15 mm |
| Minimum bending radius, fixed installation | 5 x D |
| Minimum bending radius, flexible installation | 10 x D |
| Number of bending cycles | 4000000 |
| Minimum bending radius, drag chain applications | 10 x D |
| Traversing path | 10 m |
| Traversing rate | 3 m/s |
| Acceleration | 10 m/s ² |
| Cable weight | 25 kg/km |
| Outer sheath, material | PUR |
| Material conductor insulation | PP |
| Conductor material | Bare Cu litz wires |

Sensor/actuator cable - SAC-4P-M 8MS-M12FS/.../... - 1506697

Technical data

PUR halogen-free yellow [240]

| | |
|---------------------------------|---|
| Insulation resistance | ≥ 1 GΩ*km (at 20 °C) |
| Conductor resistance | 78 Ω/km (at 20 °C) |
| Nominal voltage, cable | ≤ 300 V AC |
| Test voltage, cable | ≥ 3000 V AC (Spark test) |
| Flame resistance | in accordance with UL 758/1581 FT2 |
| Halogen-free | in accordance with DIN VDE 0472 part 815 |
| | According to EN 50267-2-1 |
| Resistance to oil | According to DIN EN 60811-2-1, 168 h at 100°C |
| | According to UL 758, 168 h at 60°C |
| Other resistance | hydrolysis and microbe resistant |
| | Resistant to salt water |
| | abrasion-resistant |
| | Low adhesion |
| Ambient temperature (operation) | -40 °C ... 80 °C (cable, fixed installation) |
| | -25 °C ... 80 °C (cable, flexible installation) |

PUR halogen-free orange [180]

| | |
|------------------------------------|--|
| Cable type | PUR halogen-free orange |
| Cable type (abbreviation) | 180 |
| Cable abbreviation | Li9Y-11Y |
| UL AWM style | 20549 |
| Conductor cross section | 4x 0.25 mm ² (Signal line) |
| AWG signal line | 24 |
| Conductor structure signal line | 32x 0.10 mm |
| Core diameter including insulation | 1.17 mm ±0.02 mm (Signal line) |
| Thickness, insulation | ≥ 0.21 mm (Core insulation) |
| | 0.75 mm (Outer cable sheath) |
| Wire colors | brown, white, blue, black |
| Overall twist | 4 wires, twisted |
| External sheath, color | orange RAL 2003 |
| External cable diameter D | 4.4 mm ±0.15 mm |
| Cable weight | 25 kg/km |
| Outer sheath, material | PUR |
| Material conductor insulation | PP |
| Conductor material | Bare Cu litz wires |
| Insulation resistance | ≥ 10 GΩ*km (at 20 °C) |
| Conductor resistance | max. 78 Ω/km (at 20 °C) |
| Nominal voltage, cable | ≤ 300 V |
| Test voltage, cable | ≥ 3000 V |
| Flame resistance | in accordance with DIN UL-Style 20549 |
| Halogen-free | in accordance with DIN VDE 0472 part 815 |

Sensor/actuator cable - SAC-4P-M 8MS-M12FS/.../... - 1506697

Technical data

PUR halogen-free orange [180]

| | |
|---------------------------------|--------------------------|
| Ambient temperature (operation) | -25 °C ... 80 °C (Cable) |
|---------------------------------|--------------------------|

PVC black [PVC]

| | |
|------------------------------------|--|
| Cable type | PVC black |
| Cable type (abbreviation) | PVC |
| Cable abbreviation | LiYY |
| Conductor cross section | 4x 0.25 mm ² (Signal line) |
| AWG signal line | 24 |
| Conductor structure signal line | 32x 0.10 mm |
| Core diameter including insulation | 1.25 mm ±0.02 mm |
| Thickness, insulation | ≥ 0.23 mm (Core insulation) |
| | ≥ 0.76 mm (Outer cable sheath) |
| Wire colors | brown, white, blue, black |
| Overall twist | 4 wires, twisted |
| External sheath, color | black RAL 9005 |
| External cable diameter D | 4.7 mm ±0.15 mm |
| Cable weight | 33 kg/km |
| Outer sheath, material | PVC |
| Material conductor insulation | PVC |
| Conductor material | Bare Cu litz wires |
| Insulation resistance | ≥ 100 MΩ*km (at 20 °C) |
| Conductor resistance | max. 78 Ω/km (at 20 °C) |
| Nominal voltage, cable | ≤ 300 V |
| Test voltage, cable | ≥ 3000 V |
| Flame resistance | As per UL-Style 2464 |
| Ambient temperature (operation) | -25 °C ... 80 °C (cable, fixed installation) |
| | -5 °C ... 80 °C (cable, flexible installation) |

PVC gray [500]

| | |
|------------------------------------|--------------------------------|
| Cable type | PVC gray |
| Cable type (abbreviation) | 500 |
| Cable abbreviation | LiYY |
| Conductor cross section | 0.25 mm ² |
| AWG signal line | 24 |
| Conductor structure signal line | 32x 0.10 mm |
| Core diameter including insulation | 1.25 mm ±0.02 mm |
| Thickness, insulation | ≥ 0.23 mm (Core insulation) |
| | ≥ 0.76 mm (Outer cable sheath) |
| Wire colors | brown, white, blue, black |
| Overall twist | 4 wires, twisted |
| External sheath, color | gray RAL 7001 |
| External cable diameter D | 4.7 mm ±0.15 mm |

Sensor/actuator cable - SAC-4P-M 8MS-M12FS/.../... - 1506697

Technical data

PVC gray [500]

| | |
|---------------------------------|--|
| Cable weight | 33 kg/km |
| Outer sheath, material | PVC |
| Material conductor insulation | PVC |
| Conductor material | Bare Cu litz wires |
| Insulation resistance | ≥ 1 GΩ*km (at 20 °C) |
| Conductor resistance | max. 78 Ω/km (at 20 °C) |
| Nominal voltage, cable | ≤ 300 V |
| Test voltage, cable | ≥ 3000 V |
| Flame resistance | As per UL-Style 2464 |
| Ambient temperature (operation) | -25 °C ... 80 °C (cable, fixed installation) |
| | -5 °C ... 80 °C (cable, flexible installation) |

Gray, highly flexible PUR [800]

| | |
|---|--|
| Note | Due to the extremely robust outer sheath, this cable should only be stripped in 5 cm increments. |
| Cable type | Gray, highly flexible PUR |
| Cable type (abbreviation) | 800 |
| Cable abbreviation | Lil2Y11Y-HF |
| UL AWM style | 20233 |
| Conductor cross section | 4x 0.25 mm ² (Signal line) |
| AWG signal line | 24 |
| Conductor structure signal line | 32x 0.10 mm |
| Core diameter including insulation | 1.15 mm ±0.05 mm (Signal line) |
| Wire colors | brown, white, blue, black |
| Overall twist | 4 wires, twisted |
| External sheath, color | gray RAL 7001 |
| External cable diameter D | 4.5 mm ±0.2 mm |
| Minimum bending radius, fixed installation | 4 x D |
| Minimum bending radius, flexible installation | 7.5 x D |
| Number of bending cycles | 10000000 |
| Minimum bending radius, drag chain applications | 7,5 x D |
| Traversing path | 5 m |
| Traversing rate | 3.3 m/s |
| Acceleration | 5 m/s ² |
| Number of bending cycles | 15000000 |
| Bending radius | 50 mm |
| Traversing path | 0.9 m |
| Traversing rate | 5 m/s |
| Acceleration | 30 m/s ² |
| Torsion force | ± 360 °/m (1 000 000 torsion cycles) |
| Cable weight | 27.1 kg/km |

Sensor/actuator cable - SAC-4P-M 8MS-M12FS/.../... - 1506697

Technical data

Gray, highly flexible PUR [800]

| | |
|---------------------------------|--|
| Outer sheath, material | PUR |
| Material conductor insulation | PES |
| Conductor material | Bare Cu litz wires |
| Insulation resistance | ≥ 20 MΩ*km |
| Conductor resistance | approx. 76 Ω/km |
| Nominal voltage, cable | 300 V |
| Test voltage, cable | 1200 V |
| Special properties | Cable jacket is welding spark-resistant, recyclable, matt, low-adhesion, abrasion-resistant, flame-retardant, and self-extinguishing |
| | Free from silicone and cadmium |
| | Free of substances which would hinder coating with paint or varnish |
| Flame resistance | according to IEC 60332-1-2 |
| | according to UL 758/1581 VW-1 |
| | according to UL 758/1581 FT1 |
| Halogen-free | in accordance with DIN VDE 0472 part 815 |
| Resistance to oil | According to HD 22.10 |
| | in accordance with DIN EN 60811-404 (external sheath) |
| Other resistance | Highly resistant to acids, alkaline solutions and solvents |
| | Silicone-free |
| Ambient temperature (operation) | -40 °C ... 90 °C (cable, fixed installation) |
| | -30 °C ... 90 °C (cable, flexible installation) |
| | to 120 °C (for 3000 h) |

PUR halogen-free black [PUR]

| | |
|---|---|
| Cable type | PUR halogen-free black |
| Cable type (abbreviation) | PUR |
| UL AWM style | 20549 |
| Conductor cross section | 5x 0.34 mm ² (Signal line) |
| AWG signal line | 22 |
| Conductor structure signal line | 42x 0.10 mm |
| Core diameter including insulation | 1.27 mm ±0.02 mm (Signal line) |
| Thickness, insulation | approx. 0.5 mm |
| Wire colors | brown, white, blue, black, green-yellow |
| External sheath, color | black-gray RAL 7021 |
| External cable diameter D | 4.55 mm ±0.15 mm |
| Smallest bending radius, fixed installation | 23 mm |
| Smallest bending radius, movable installation | 46 mm |
| Number of bending cycles | 10000000 |
| Bending radius | 50 mm |
| Traversing path | 10 m |
| Traversing rate | 3 m/s |

Sensor/actuator cable - SAC-4P-M 8MS-M12FS/.../... - 1506697

Technical data

PUR halogen-free black [PUR]

| | |
|---|---|
| Acceleration | 10 m/s ² |
| Cable weight | 33 kg/km |
| Outer sheath, material | PUR |
| Material conductor insulation | PP |
| Conductor material | Bare Cu litz wires |
| Insulation resistance | ≥ 16 GΩ*km (at 20 °C) |
| Conductor resistance | max. 58 Ω/km (at 20 °C) |
| Nominal voltage, cable | 300 V |
| Test voltage, cable | 3000 V |
| Special properties | Flexible cable conduit capable |
| | Silicone-free |
| | Free of substances which would hinder coating with paint or varnish |
| | flexible |
| Flame resistance | in accordance with UL 758/1581 FT2 |
| | DIN EN 60332-2-2 (20 s) |
| Halogen-free | in accordance with DIN VDE 0472 part 815 |
| Resistance to oil | in accordance with DIN EN 60811-2-1 |
| Other resistance | Highly resistant to acids, alkaline solutions and solvents |
| | hydrolysis and microbe resistant |
| | Resistant to salt water |
| | partly UV-resistant in accordance with DIN EN ISO 4892-2-A |
| Ambient temperature (operation) | -40 °C ... 80 °C (cable, fixed installation) |
| | -25 °C ... 80 °C (cable, flexible installation) |
| Cable type | PUR halogen-free black |
| Cable type (abbreviation) | PUR |
| Cable abbreviation | Li9Y11Y-HF |
| UL AWM style | 20549 |
| Conductor cross section | 3x 0.25 mm ² |
| AWG signal line | 24 |
| Conductor structure signal line | 32x 0.10 mm |
| Core diameter including insulation | 1.17 mm ±0.02 mm |
| Thickness, insulation | ≥ 0.21 mm (Core insulation) |
| Wire colors | brown, blue, black |
| Overall twist | 3 wires, twisted |
| Length of twist, overall twist | 40 mm |
| External sheath, color | black-gray RAL 7021 |
| Outer sheath thickness | approx. 0.5 mm |
| External cable diameter D | 3.6 mm ±0.15 mm |
| Smallest bending radius, fixed installation | 18 mm |
| Smallest bending radius, movable installation | 36 mm |

Sensor/actuator cable - SAC-4P-M 8MS-M12FS/.../... - 1506697

Technical data

PUR halogen-free black [PUR]

| | |
|---------------------------------|---|
| Number of bending cycles | 10000000 |
| Bending radius | 44 mm |
| Traversing path | 10 m |
| Traversing rate | 3 m/s |
| Acceleration | 10 m/s ² |
| Cable weight | 18 kg/km |
| Outer sheath, material | PUR |
| Material conductor insulation | PP |
| Conductor material | Bare Cu litz wires |
| Insulation resistance | ≥ 100 GΩ*km (at 20 °C) |
| Conductor resistance | ≤ 78 Ω/km (at 20 °C) |
| Nominal voltage, cable | ≤ 300 V |
| Test voltage, cable | ≥ 3000 V |
| Special properties | Flexible cable conduit capable |
| | Silicone-free |
| | Free of substances which would hinder coating with paint or varnish |
| Flame resistance | in accordance with UL 758/1581 FT2 |
| | DIN EN 60332-2-2 (20 s) |
| Halogen-free | in accordance with DIN VDE 0472 part 815 |
| Resistance to oil | in accordance with DIN EN 60811-2-1 |
| Other resistance | hydrolysis and microbe resistant |
| | Highly resistant to acids, alkaline solutions and solvents |
| | Resistant to salt water |
| | partly UV-resistant in accordance with DIN EN ISO 4892-2-A |
| Ambient temperature (operation) | -40 °C ... 80 °C (cable, fixed installation) |
| | -25 °C ... 80 °C (cable, flexible installation) |

Environmental Product Compliance

| | |
|------------|---|
| REACH SVHC | Lead 7439-92-1 |
| China RoHS | Environmentally Friendly Use Period = 50 |
| | For details about hazardous substances go to tab "Downloads", Category "Manufacturer's declaration" |

Drawings

Sensor/actuator cable - SAC-4P-M 8MS-M12FS/.../... - 1506697

Dimensional drawing

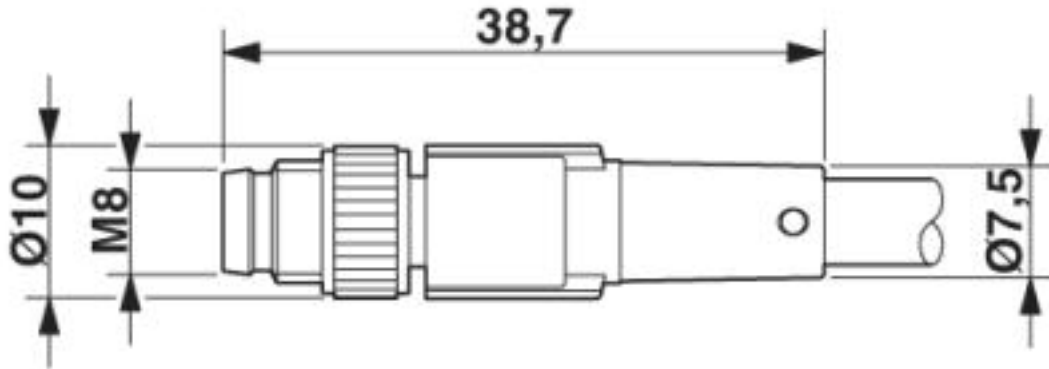

M8 x 1 male plug, straight version

Dimensional drawing

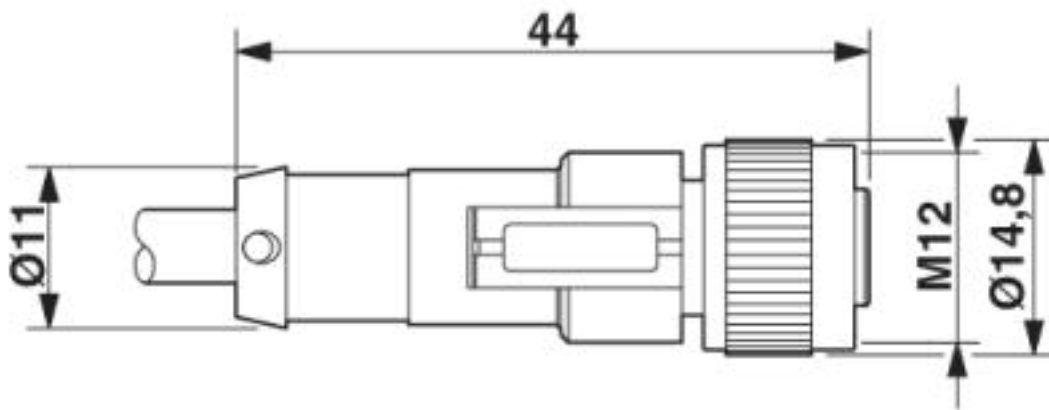

M12 x 1 socket, straight

Sensor/actuator cable - SAC-4P-M 8MS-M12FS/.../... - 1506697

Circuit diagram

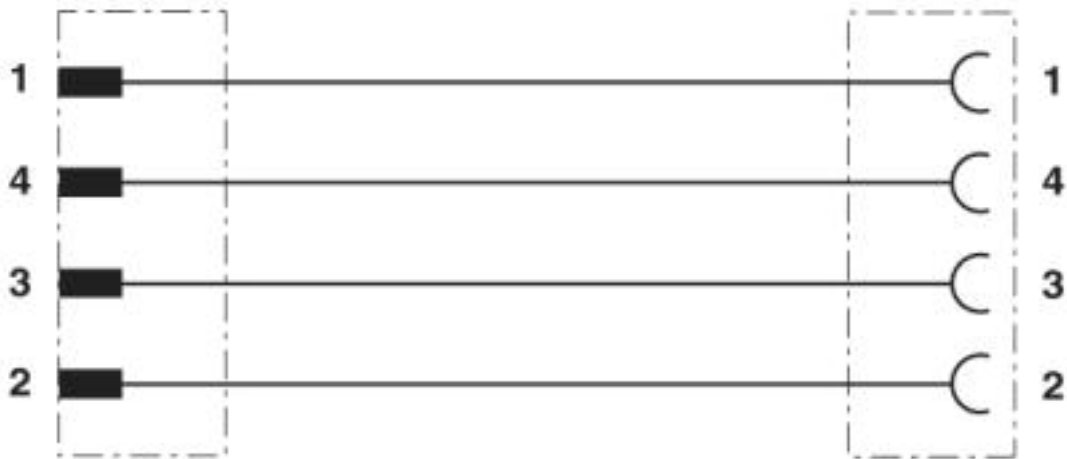

Contact assignment of M8 plugs / M12 sockets

Sensor/actuator cable - SAC-4P-M 8MS-M12FS/.../... - 1506697

Schematic diagram

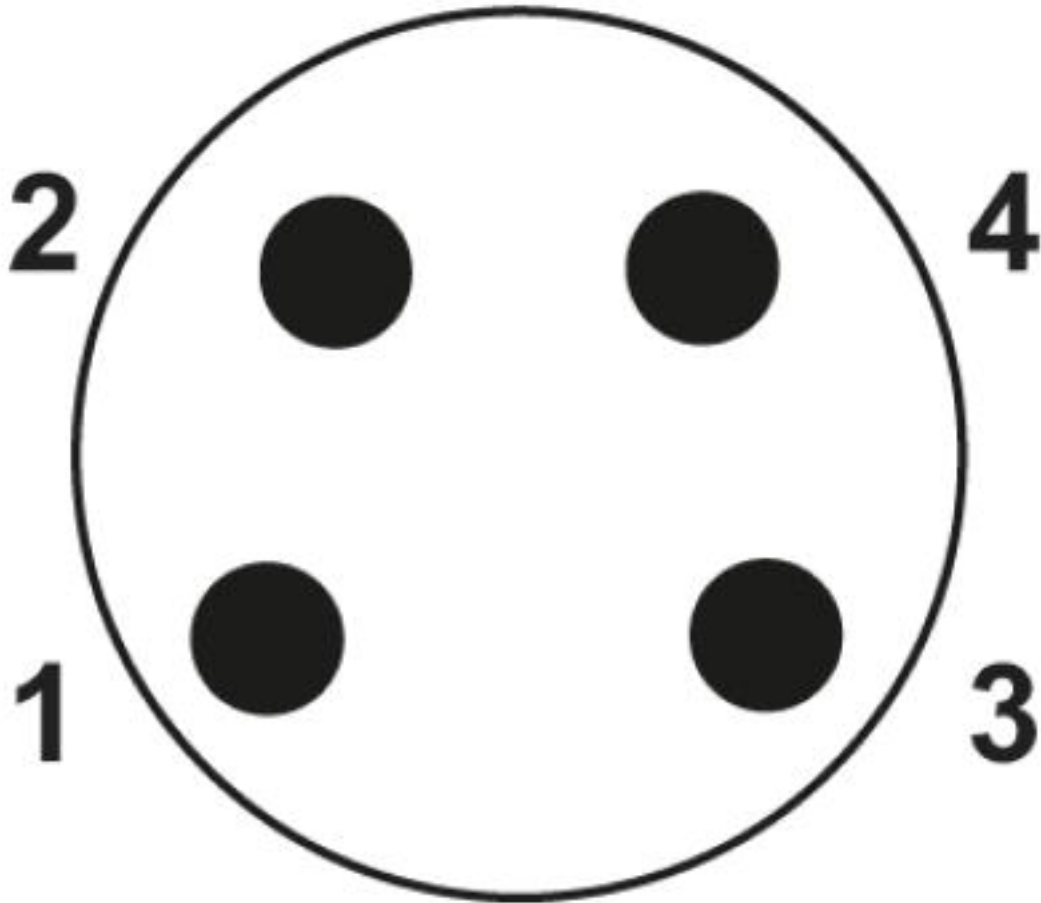

Pin assignment M8 plug, 4-pos., view male side

Sensor/actuator cable - SAC-4P-M 8MS-M12FS/.../... - 1506697

Schematic diagram

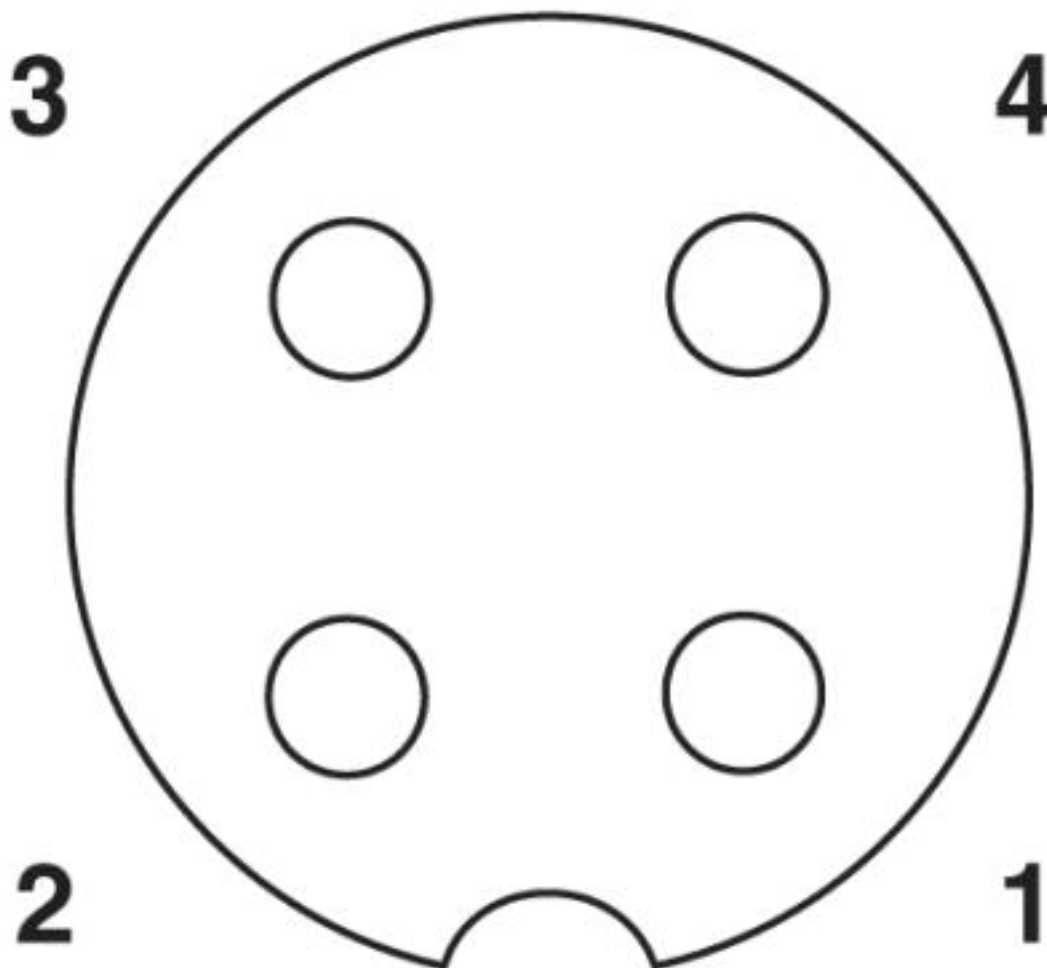

Pin assignment M12 socket, 4-pos., A-coded, view female side

Sensor/actuator cable - SAC-4P-M 8MS-M12FS/.../... - 1506697

Cable cross section

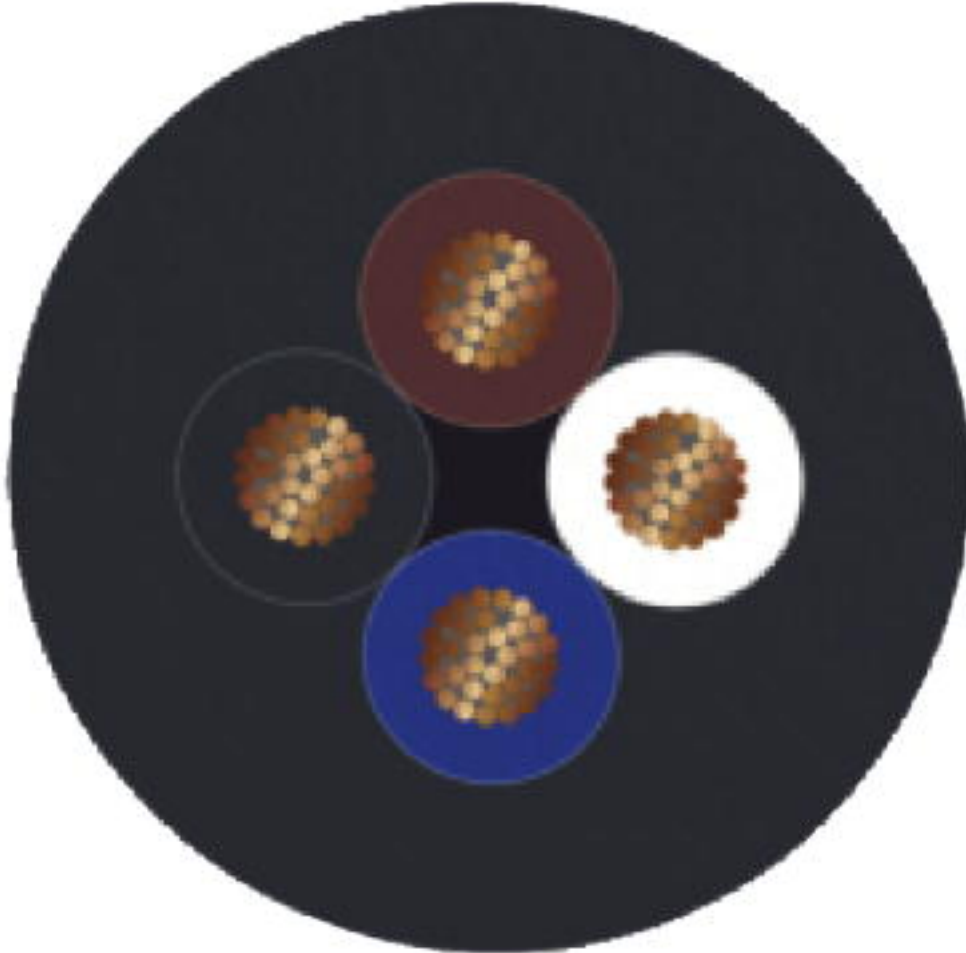

PUR halogen-free black [PUR]

Sensor/actuator cable - SAC-4P-M 8MS-M12FS/.../... - 1506697

Cable cross section

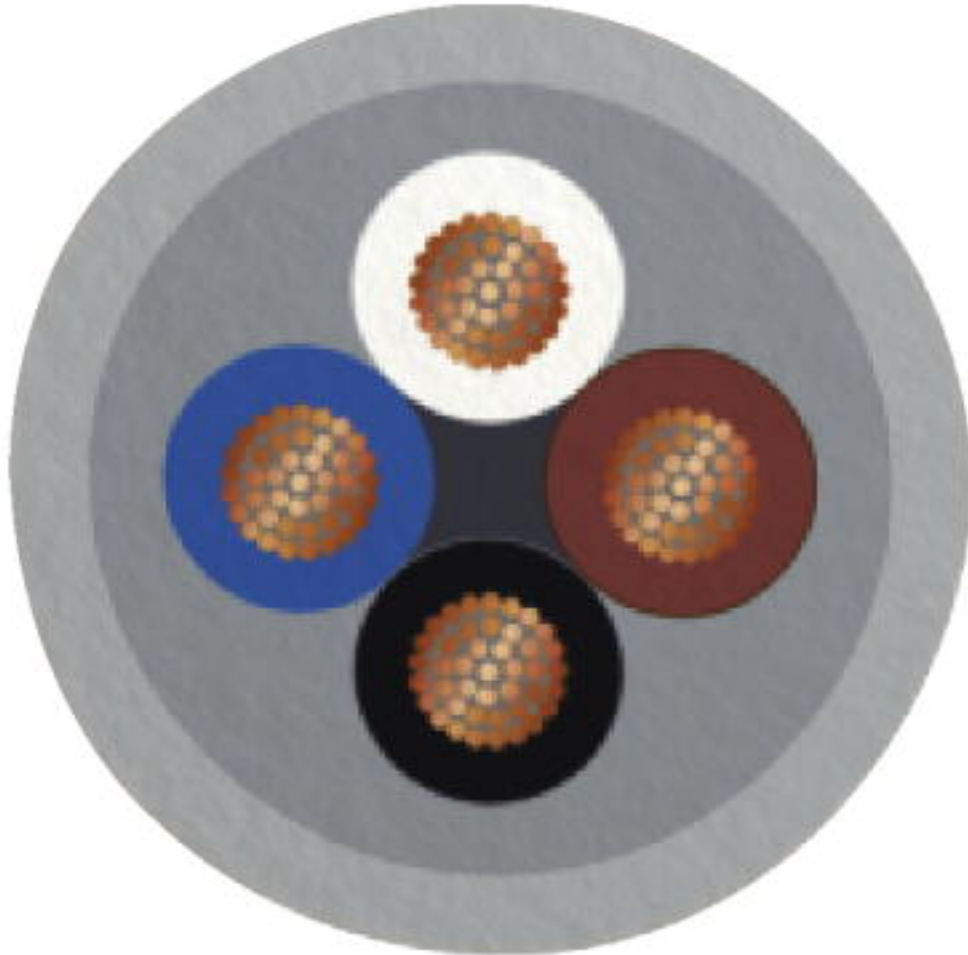

PUR/PVC gray [100]

Sensor/actuator cable - SAC-4P-M 8MS-M12FS/.../... - 1506697

Cable cross section

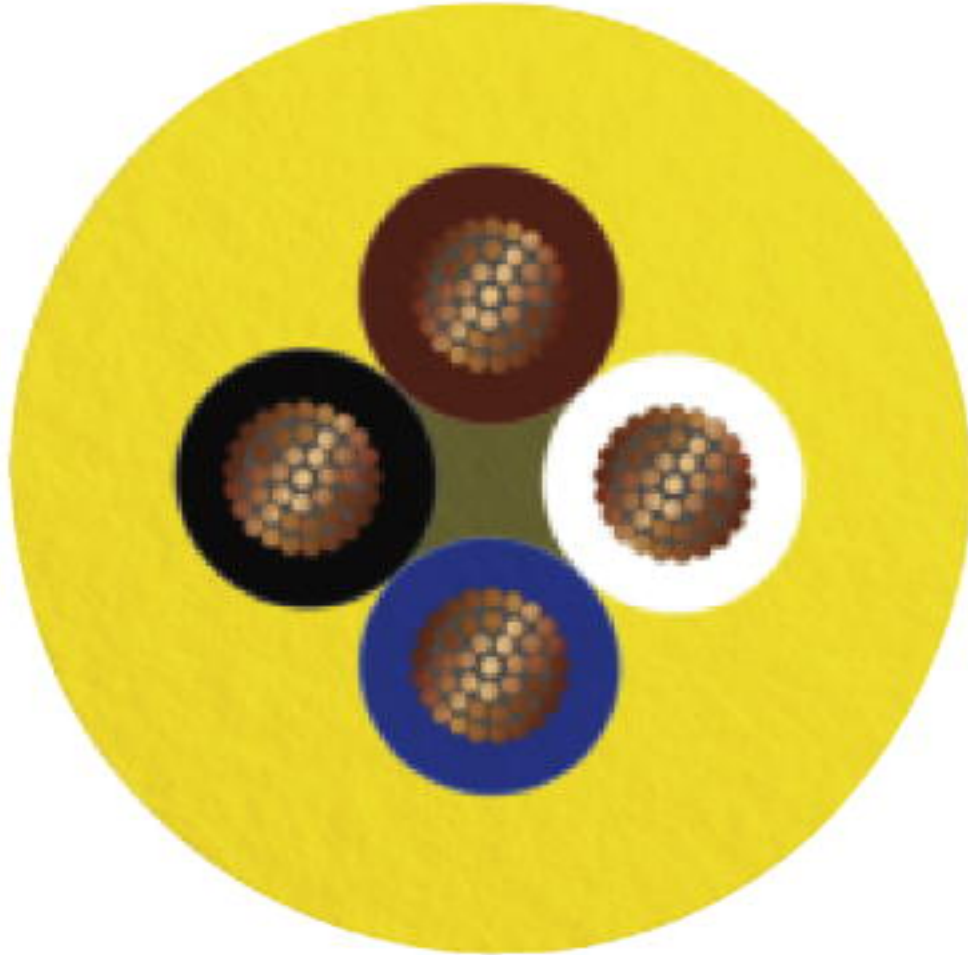

PUR halogen-free yellow [240]

Sensor/actuator cable - SAC-4P-M 8MS-M12FS/.../... - 1506697

Cable cross section

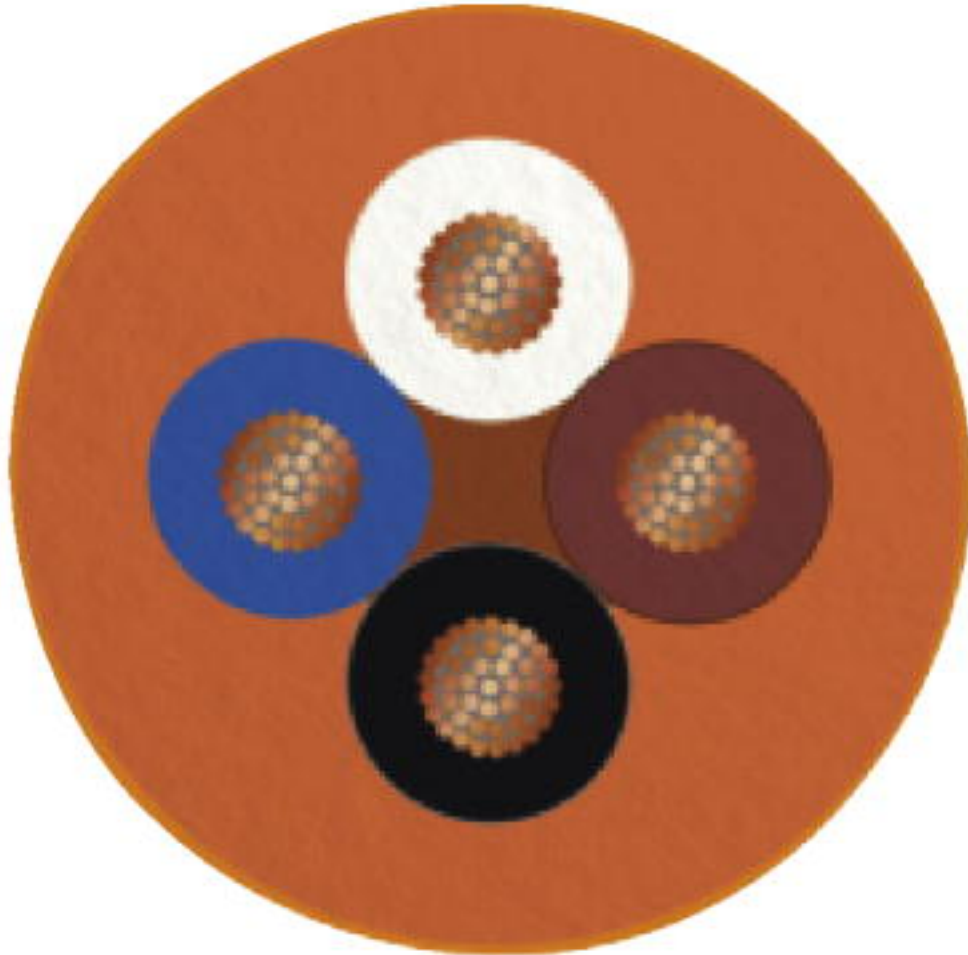

PUR halogen-free orange [180]

Sensor/actuator cable - SAC-4P-M 8MS-M12FS/.../... - 1506697

Cable cross section

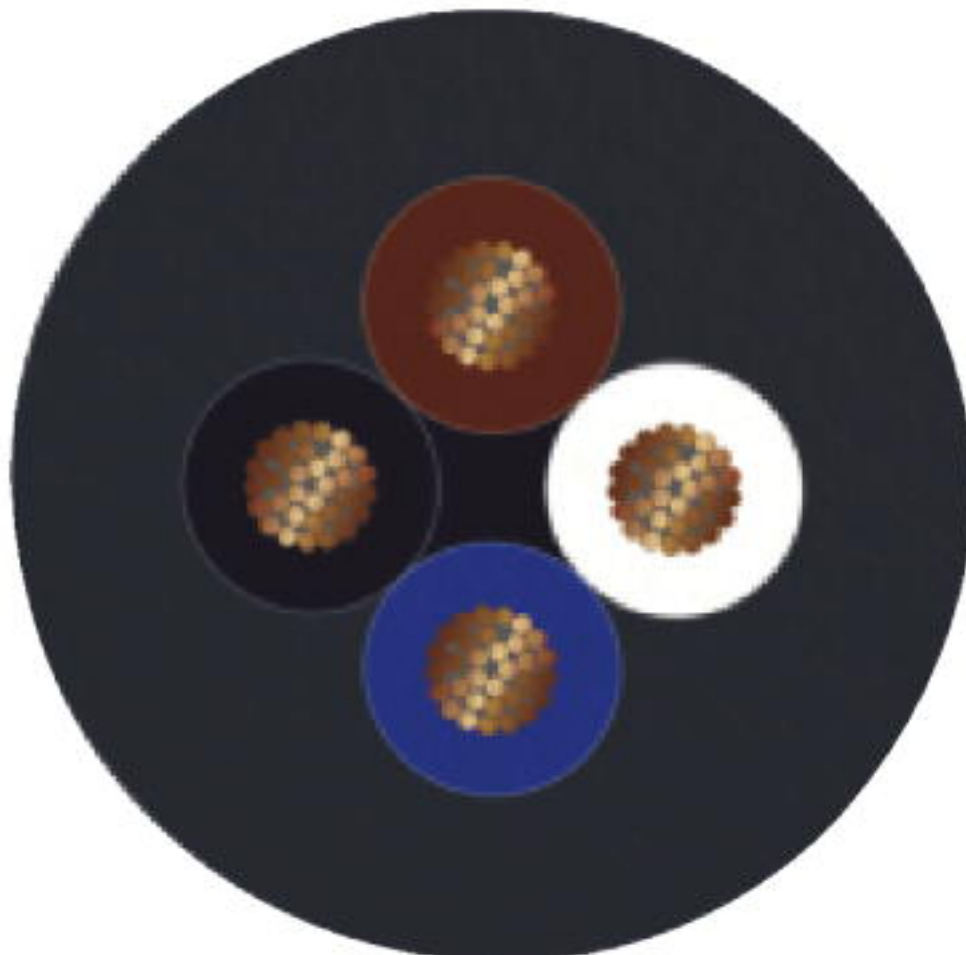

PVC black [PVC]

Sensor/actuator cable - SAC-4P-M 8MS-M12FS/.../... - 1506697

Cable cross section

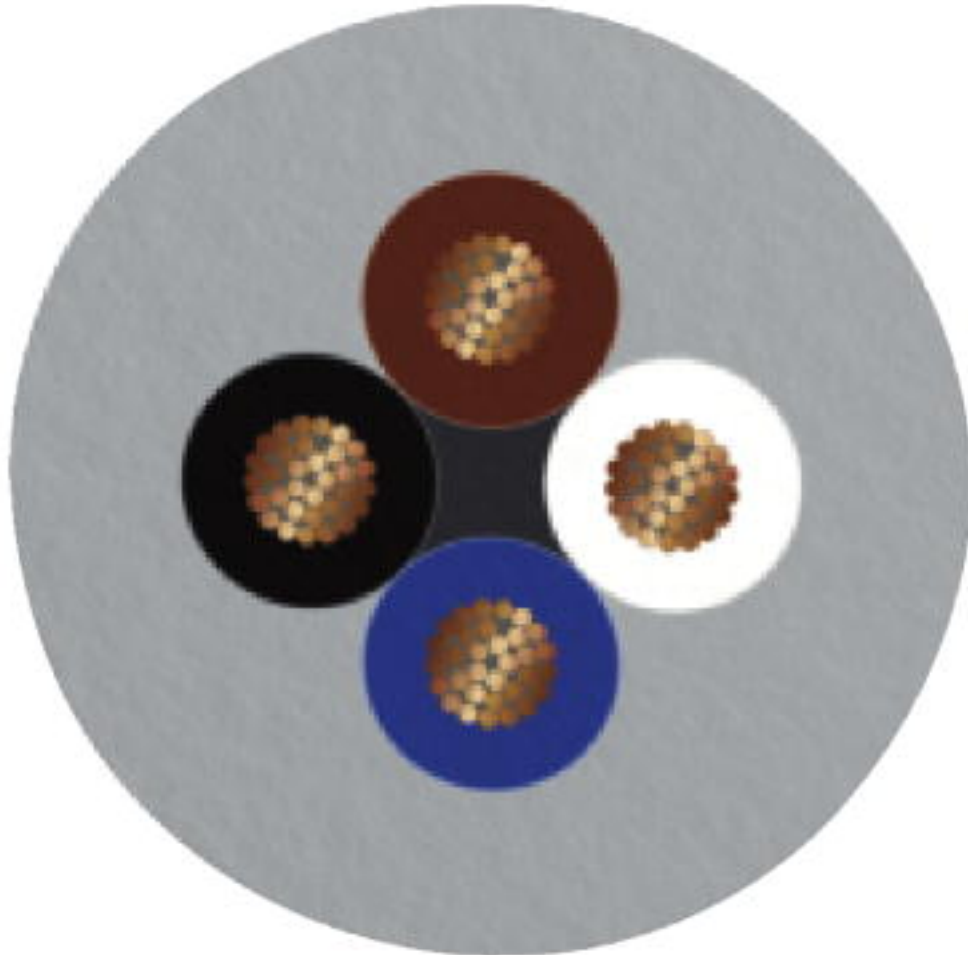

PVC gray [500]

Sensor/actuator cable - SAC-4P-M 8MS-M12FS/.../... - 1506697

Cable cross section

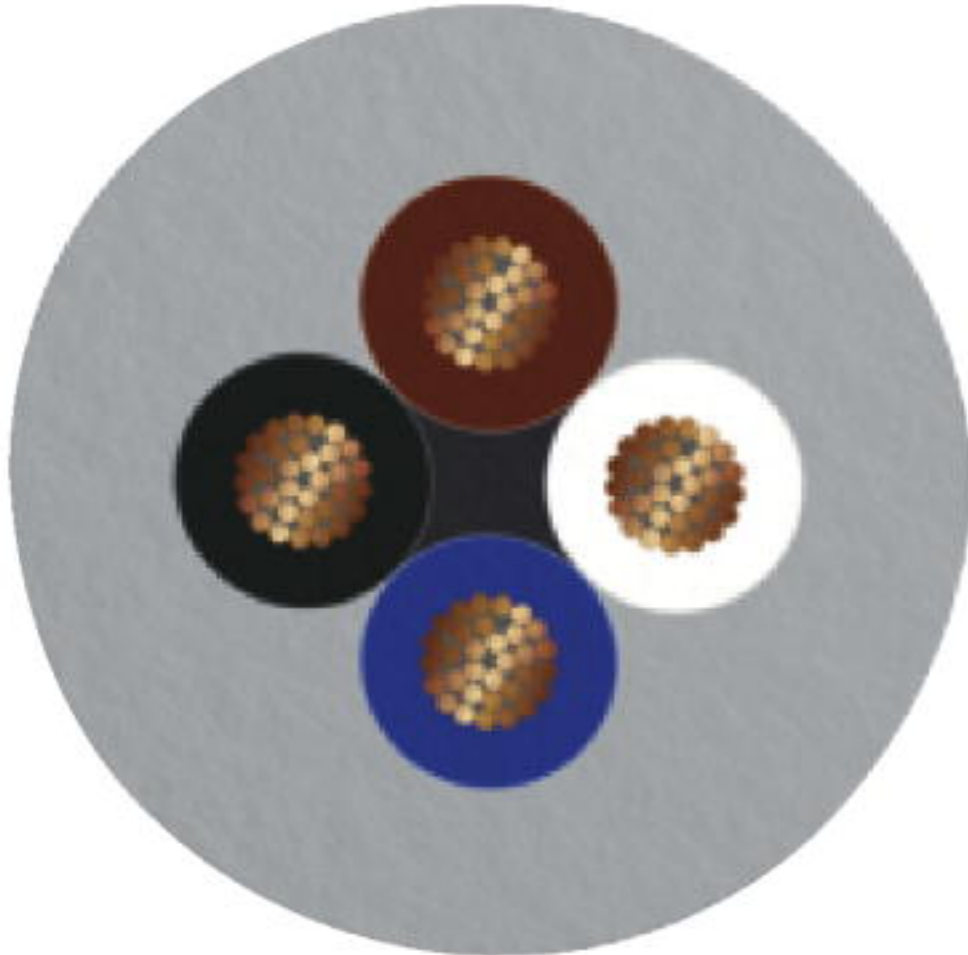

Gray, highly flexible PUR [800]

Sensor/actuator cable - SAC-4P-M 8MS-M12FS/.../... - 1506697

Cable cross section

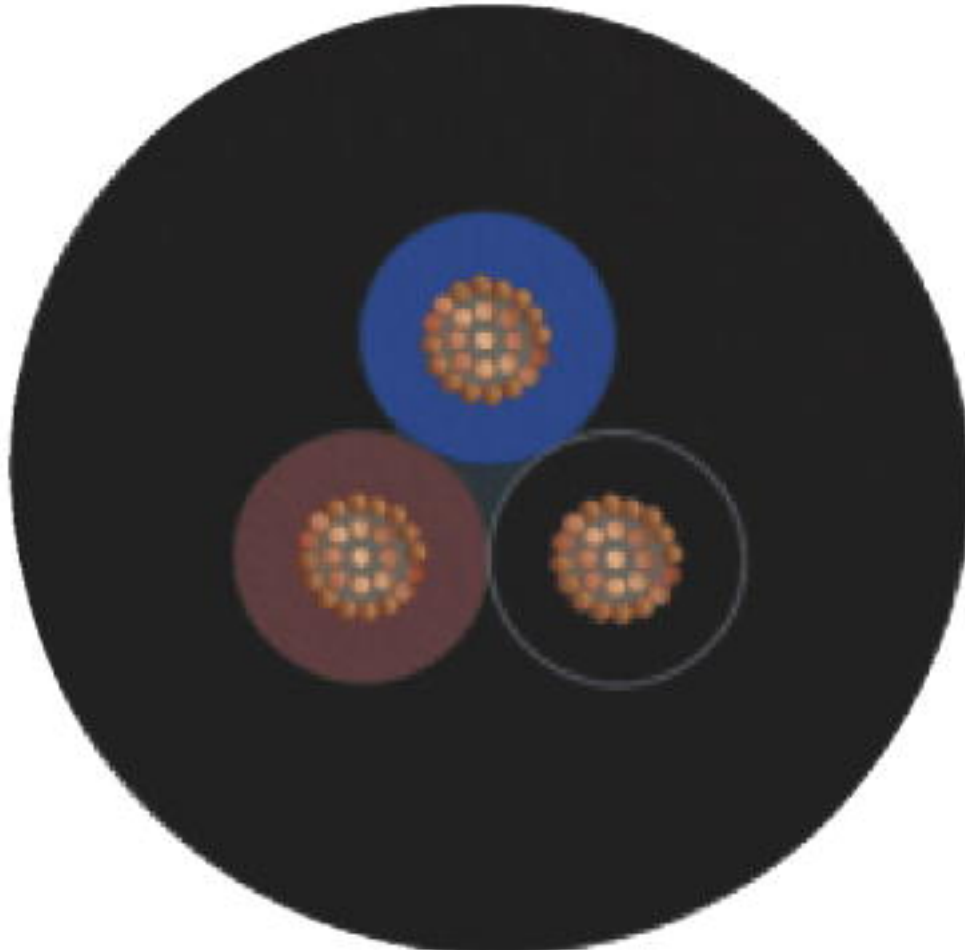

PUR halogen-free black [PUR]

Approvals

Approvals

Approvals

UL Listed / cUL Listed / EAC / EAC / cULus Listed

Ex Approvals

Approval details

Sensor/actuator cable - SAC-4P-M 8MS-M12FS/.../... - 1506697

Approvals

| | | | |
|--------------------|---|---|---------------|
| UL Listed |  | http://database.ul.com/cgi-bin/XYV/template/LISEXT/1FRAME/index.htm | FILE E 221474 |
| Nominal voltage UN | | 30 V | |
| Nominal current IN | | 4 A | |

| | | | |
|--------------------|---|---|---------------|
| cUL Listed |  | http://database.ul.com/cgi-bin/XYV/template/LISEXT/1FRAME/index.htm | FILE E 221474 |
| Nominal voltage UN | | 30 V | |
| Nominal current IN | | 4 A | |

| | | |
|-----|--|---------------|
| EAC |  | EAC-Zulassung |
|-----|--|---------------|

| | | |
|-----|---|--------------------------|
| EAC |  | RU C- DE.BL08.B.00286 |
|-----|---|--------------------------|

| | | |
|--------------|---|--|
| cULus Listed |  | |
|--------------|---|--|

Phoenix Contact 2019 © - all rights reserved
<http://www.phoenixcontact.com>

PHOENIX CONTACT GmbH & Co. KG
 Flachsmarktstr. 8
 32825 Blomberg
 Germany
 Tel. +49 5235 300
 Fax +49 5235 3 41200
<http://www.phoenixcontact.com>