

Data sheet | Item number: 2022-1804

4-pin carrier terminal block; for DIN-rail 35 x 15 and 35 x 7.5; blue

www.wago.com/2022-1804

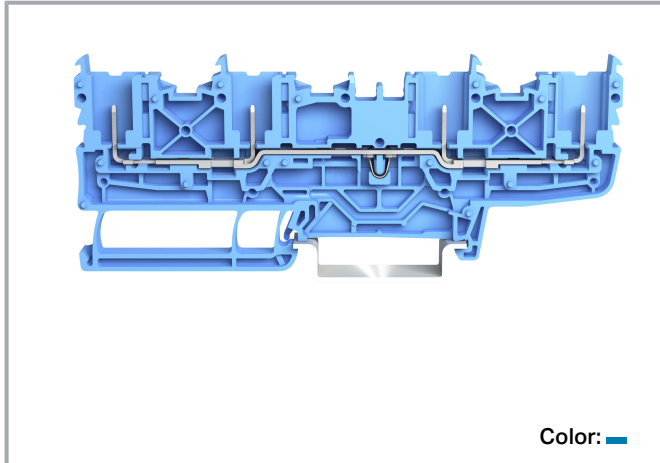

Color: 

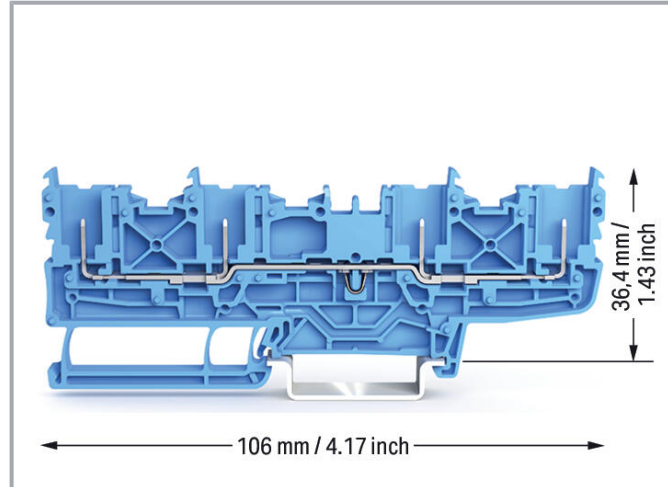

Data

Electrical data

Ratings per IEC/EN

Ratings per	IEC/EN 60947-7-1
Nominal voltage (III/3)	690 V
Rated impulse voltage (III/3)	6 kV
Rated current	24 A
Current at conductor cross-section (max.) mm ²	27 A
Legend (ratings)	(III / 3) ≙ Overvoltage category III / Pollution degree 3

Ratings per UL 1059

Approvals per	UL 1059
Rated voltage UL (Use Group B)	600 V
Rated current UL (Use Group B)	20 A
Rated voltage UL (Use Group C)	600 V
Rated current UL (Use Group C)	20 A

Subject to changes. Please also observe the further product documentation!

WAGO GmbH & Co. KG
Hansastr. 27
32423 Minden
Phone: +49571 887-0 | Fax: +49571 887-169
Email: info.de@wago.com | Web: www.wago.com

Do you have any questions about our products?
We are always happy to take your call at +49 (571) 887-44222.



Ratings per CSA

Approvals per	CSA 22.2 No 158
Rated voltage CSA (Use Group C)	600 V
Rated current CSA (Use Group C)	20 A

Power loss

Power loss, per pole (potential)	0.766 W
Rated current I_N for specified power loss	24 A

Connection data

Female plug slots	4
Total number of potentials	1
Number of levels	1

Physical data

Width	5.2 mm / 0.205 inches
Height	106 mm / 4.173 inches
Depth from upper-edge of DIN-rail	32.5 mm / 1.28 inches

Mechanical Data

Design	horizontal type
Mounting type	DIN-35 rail
Marking level	Center/side marking

Material Data

Note (material data)	Information on material specifications can be found here
Color	blue
Material group	I
Insulation material	Polyamide (PA66)
Flammability class per UL94	V0
Fire load	0.242 MJ
Weight	11.8 g

Subject to changes. Please also observe the further product documentation!

Environmental requirements

Continuous operating temperature -60 ... +105 °C

Commercial data





ETIM 8.0	EC000897
ETIM 7.0	EC000897
PU (SPU)	50 pcs
Packaging type	Box
Country of origin	CN
GTIN	4055143926683
Customs tariff number	85366990990

Environmental Product Compliance

RoHS Compliance Status Compliant, No Exemption



Approvals / Certificates

General approvals

Logo	Approval	Additional Approval Text	Certificate name
	CCA DEKRA Certification B.V.	C22.2 No. 158	2437422
	CCA DEKRA Certification B.V.	EN 60947	NTR CCA NL-7864
	KEMA/KEUR DEKRA Certification B.V.	EN 60947	71- 116567
	UL Underwriters Laboratories Inc.	UL 1059	E45172



Subject to changes. Please also observe the further product documentation!

Counterpart

	Item no.2022-101 1-conductor female connector; Push-in CAGE CLAMP®; 4 mm ² ; Pin spacing 5.2 mm; 1-pole; 4,00 mm ² ; gray	www.wago.com/2022-101
	Item no.2022-101/000-006 1-conductor female connector; Push-in CAGE CLAMP®; 4 mm ² ; Pin spacing 5.2 mm; 1-pole; 4,00 mm ² ; blue	www.wago.com/2022-101/000-006







Required accessories

End plate

End plate		
	Item no.: 2022-1891 End plate; 1 mm thick; gray	www.wago.com/2022-1891
	Item no.: 2022-1892 End plate; 1 mm thick; orange	www.wago.com/2022-1892

Optional accessories

Carrier rail

Mounting accessories		
	Item no.: 210-197 Steel carrier rail; 35 x 15 mm; 1.5 mm thick; 2 m long; slotted; similar to EN 60715; silver-colored	www.wago.com/210-197
	Item no.: 210-198 Copper carrier rail; 35 x 15 mm; 2.3 mm thick; 2 m long; unslotted; according to EN 60715; copper-colored	www.wago.com/210-198
	Item no.: 210-113 Steel carrier rail; 35 x 7.5 mm; 1 mm thick; 2 m long; unslotted; according to EN 60715; silver-colored	www.wago.com/210-113
	Item no.: 210-118 Steel carrier rail; 35 x 15 mm; 2.3 mm thick; 2 m long; unslotted; according to EN 60715; silver-colored	www.wago.com/210-118
	Item no.: 210-112 Steel carrier rail; 35 x 7.5 mm; 1 mm thick; 2 m long; slotted; according to EN 60715; "Hole width 25 mm; silver-colored	www.wago.com/210-112
	Item no.: 210-114 Steel carrier rail; 35 x 15 mm; 1.5 mm thick; 2 m long; unslotted; similar to EN 60715; silver-colored	www.wago.com/210-114
	Item no.: 210-115 Steel carrier rail; 35 x 7.5 mm; 1 mm thick; 2 m long; slotted; according to EN 60715; "Hole width 18 mm; silver-colored	www.wago.com/210-115

Subject to changes. Please also observe the further product documentation!

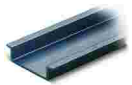

Item no.: 210-196

Aluminum carrier rail; 35 x 8.2 mm; 1.6 mm thick; 2 m long; unslotted; similar to EN 60715; silver-colored

www.wago.com/210-196

Tool

Operating tool



Item no.: 210-720

Operating tool; Blade: 3.5 x 0.5 mm; with a partially insulated shaft; multicoloured

www.wago.com/210-720

Marking accessories

Marking strip



Item no.: 2009-110

Marking strips; for Smart Printer; on reel; not stretchable; plain; snap-on type; white

www.wago.com/2009-110

Marker carrier



Item no.: 2009-198

Adaptor; gray

www.wago.com/2009-198



Item no.: 2002-161

Adaptor; gray

www.wago.com/2002-161

Marker



Item no.: 2009-145

Mini-WSB Inline; for Smart Printer; 1700 pieces on roll; stretchable 5 - 5.2 mm; plain; snap-on type; white

www.wago.com/2009-145



Item no.: 2009-115

WMB-Inline; for Smart Printer; 1500 pieces on roll; stretchable 5 - 5.2 mm; plain; snap-on type; white

www.wago.com/2009-115



Item no.: 248-501

Mini-WSB marking card; as card; not stretchable; plain; snap-on type; white

www.wago.com/248-501



Item no.: 793-5501

WMB marking card; as card; for terminal block width 5 - 17.5 mm; stretchable 5 - 5.2 mm; plain; snap-on type; white

www.wago.com/793-5501

Group marker carrier



Item no.: 2009-193

Group marker carrier; gray

www.wago.com/2009-193



Item no.: 2009-192

Group marker carrier; gray

www.wago.com/2009-192



Item no.: 2009-191

Group marker carrier; gray

www.wago.com/2009-191

Jumpers

Jumper

Subject to changes. Please also observe the further product documentation!

WAGO GmbH & Co. KG

Hansastr. 27















32423 Minden

Phone: +49571 887-0 | Fax: +49571 887-169

Email: info.de@wago.com | Web: www.wago.com

Do you have any questions about our products?

We are always happy to take your call at +49 (571) 887-44222.

	Item no.: 2002-402 Jumper; 2-way; insulated; light gray	www.wago.com/2002-402
	Item no.: 2002-402/000-005 Jumper; 2-way; insulated; red	www.wago.com/2002-402/000-005
	Item no.: 2002-400 Continuous jumper; 2-way; insulated; light gray	www.wago.com/2002-400
	Item no.: 2002-403 Jumper; 3-way; insulated; light gray	www.wago.com/2002-403
	Item no.: 2002-404/000-005 Jumper; 4-way; insulated; red	www.wago.com/2002-404/000-005
	Item no.: 2002-403/000-006 Jumper; 3-way; insulated; blue	www.wago.com/2002-403/000-006
	Item no.: 2002-404/000-006 Jumper; 4-way; insulated; blue	www.wago.com/2002-404/000-006
	Item no.: 2002-403/000-005 Jumper; 3-way; insulated; red	www.wago.com/2002-403/000-005
	Item no.: 2002-405/000-005 Jumper; 5-way; insulated; red	www.wago.com/2002-405/000-005
	Item no.: 2002-402/000-006 Jumper; 2-way; insulated; blue	www.wago.com/2002-402/000-006
	Item no.: 2002-405/000-006 Jumper; 5-way; insulated; blue	www.wago.com/2002-405/000-006
	Item no.: 2002-404 Jumper; 4-way; insulated; light gray	www.wago.com/2002-404
	Item no.: 2002-406/000-006 Jumper; 6-way; insulated; blue	www.wago.com/2002-406/000-006
	Item no.: 2002-406/000-005 Jumper; 6-way; insulated; red	www.wago.com/2002-406/000-005

Subject to changes. Please also observe the further product documentation!



Item no.: 2002-406/020-000
Delta jumper; insulated; light gray

www.wago.com/2002-406/020-000



Item no.: 2002-405
Jumper; 5-way; insulated; light gray

www.wago.com/2002-405



Item no.: 2002-407/000-005
Jumper; 7-way; insulated; red

www.wago.com/2002-407/000-005



Item no.: 2002-408
Jumper; 8-way; insulated; light gray

www.wago.com/2002-408



Item no.: 2002-408/000-006
Jumper; 8-way; insulated; blue

www.wago.com/2002-408/000-006



Item no.: 2002-405/011-000
Star point jumper; 3-way; insulated; light gray

www.wago.com/2002-405/011-000



Item no.: 2002-407/000-006
Jumper; 7-way; insulated; blue

www.wago.com/2002-407/000-006



Item no.: 2002-408/000-005
Jumper; 8-way; insulated; red

www.wago.com/2002-408/000-005



Item no.: 2002-407
Jumper; 7-way; insulated; light gray

www.wago.com/2002-407



Item no.: 2002-406
Jumper; 6-way; insulated; light gray

www.wago.com/2002-406



Item no.: 2002-410/000-005
Jumper; 10-way; insulated; red

















www.wago.com/2002-410/000-005



Item no.: 2002-410/000-006
Jumper; 10-way; insulated; blue

www.wago.com/2002-410/000-006

Subject to changes. Please also observe the further product documentation!

	Item no.: 2002-410 Jumper; 10-way; insulated; light gray	www.wago.com/2002-410
	Item no.: 2002-409/000-006 Jumper; 9-way; insulated; blue	www.wago.com/2002-409/000-006
	Item no.: 2002-409/000-005 Jumper; 9-way; insulated; red	www.wago.com/2002-409/000-005
	Item no.: 2002-409 Jumper; 9-way; insulated; light gray	www.wago.com/2002-409
	Item no.: 2002-423/000-006 Continuous jumper; from 1 to 3; insulated; blue	www.wago.com/2002-423/000-006
	Item no.: 2002-423 Continuous jumper; from 1 to 3; insulated; light gray	www.wago.com/2002-423
	Item no.: 2002-433 Jumper; from 1 to 3; insulated; light gray	www.wago.com/2002-433
	Item no.: 2002-434 Jumper; from 1 to 4; insulated; light gray	www.wago.com/2002-434
	Item no.: 2002-423/000-005 Continuous jumper; from 1 to 3; insulated; red	www.wago.com/2002-423/000-005
	Item no.: 2002-435 Jumper; from 1 to 5; insulated; light gray	www.wago.com/2002-435
	Item no.: 2002-436 Jumper; from 1 to 6; insulated; light gray	www.wago.com/2002-436
	Item no.: 2002-437 Jumper; from 1 to 7; insulated; light gray	www.wago.com/2002-437
	Item no.: 2002-438 Jumper; from 1 to 8; insulated; light gray	www.wago.com/2002-438
	Item no.: 2002-439 Jumper; from 1 to 9; insulated; light gray	www.wago.com/2002-439
	Item no.: 2002-440 Jumper; from 1 to 10; insulated; light gray	www.wago.com/2002-440
	Item no.: 2002-472	www.wago.com/2002-472

Subject to changes. Please also observe the further product documentation!

Staggered jumper; 2-way; insulated; light gray



Item no.: 2002-473

Staggered jumper; 3-way; insulated; light gray

www.wago.com/2002-473



Item no.: 2002-475/011-000

Staggered jumper; 3-way; insulated; light gray

www.wago.com/2002-475/011-000



Item no.: 2002-475

Staggered jumper; 5-way; insulated; light gray

www.wago.com/2002-475



Item no.: 2002-476

Staggered jumper; 6-way; insulated; light gray

www.wago.com/2002-476



Item no.: 2002-474

Staggered jumper; 4-way; insulated; light gray

www.wago.com/2002-474



Item no.: 2002-477

Staggered jumper; 7-way; insulated; light gray

www.wago.com/2002-477

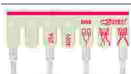

Item no.: 2002-473/011-000

Staggered jumper; 2-way; from 1 to 3; insulated; light gray

www.wago.com/2002-473/011-000



Item no.: 2002-479

Staggered jumper; 9-way; insulated; light gray

www.wago.com/2002-479



Item no.: 2002-478

Staggered jumper; 8-way; insulated; light gray

www.wago.com/2002-478



Item no.: 2002-479/011-000

Staggered jumper; insulated; light gray

www.wago.com/2002-479/011-000



Item no.: 2002-480

Staggered jumper; 10-way; insulated; light gray

www.wago.com/2002-480



Item no.: 2002-477/011-000

Staggered jumper; insulated; light gray

www.wago.com/2002-477/011-000



Item no.: 2002-481/011-000

Staggered jumper; insulated; light gray

www.wago.com/2002-481/011-000



Item no.: 2002-481

Staggered jumper; 11-way; insulated; light gray

www.wago.com/2002-481



Item no.: 2002-482

Staggered jumper; 12-way; insulated; light gray

www.wago.com/2002-482

Subject to changes. Please also observe the further product documentation!

WAGO GmbH & Co. KG

Hansastr. 27

32423 Minden

Phone: +49571 887-0 | Fax: +49571 887-169

Email: info.de@wago.com | Web: www.wago.com

Do you have any questions about our products?

We are always happy to take your call at +49 (571) 887-44222.



Item no.: 2002-424/000-006
Continuous jumper; from 1 to 4; insulated; blue

www.wago.com/2002-424/000-006

Push-in type wire jumper

Jumper



Item no.: 2009-412
Push-in type wire jumper; insulated; 60 mm long; black

www.wago.com/2009-412



Item no.: 2009-414
Push-in type wire jumper; 1.5 mm²; insulated; 110 mm long; black

www.wago.com/2009-414



Item no.: 2009-416
Push-in type wire jumper; 1.5 mm²; insulated; 250 mm long; black

www.wago.com/2009-416



Item no.: 2009-414/000-005
Push-in type wire jumper; 1.5 mm²; insulated; 110 mm long; black

www.wago.com/2009-414/000-005



Item no.: 2009-414/000-006
Push-in type wire jumper; insulated; 110 mm long; black

www.wago.com/2009-414/000-006

Coding

Coding



Item no.: 2022-100
Carrier with 6 coding pins; for coding of female plugs; orange

www.wago.com/2022-100

Downloads

Documentation

Bid Text

2022-1804 docx - Datei	2019 May 20	docx 15.5 kB	Download
2022-1804 X81 - Datei	2019 May 20	xml 4.4 kB	Download

Additional Information

Technical Section Technical explanations		pdf 2.2 MB	Download
---	--	---------------	----------

Subject to changes. Please also observe the further product documentation!

CAD/CAE-Data

CAD data

2D/3D Models 2022-1804	URL	Download
------------------------	---------------------	--------------------------

CAE data

ZUKEN Portal 2022-1804	URL	Download
------------------------	---------------------	--------------------------

Environmental Product Compliance

Compliance Search

Environmental Product Compliance 2022-1804	URL	Download
--	---------------------	--------------------------

4-pin carrier terminal block; for DIN-rail 35 x 15 and 35 x 7.5; blue

Installation Notes

Installation

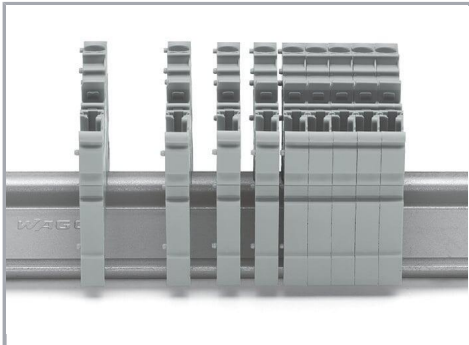

Snap individual carrier terminal blocks onto the DIN-rail and slide together.

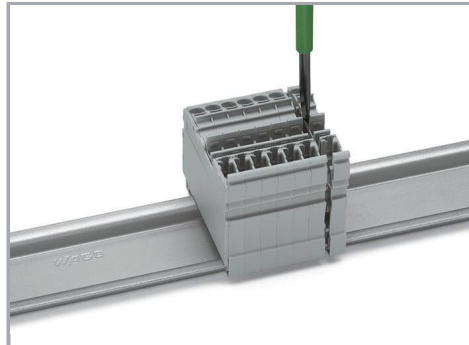

Open the assembly by laterally sliding a block via operating tool (3.5 x 0.5 mm blade).

Subject to changes. Please also observe the further product documentation!

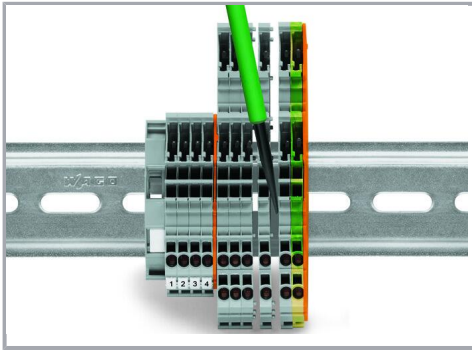

Separate terminal block assembly and slide individual terminal blocks laterally using an operating tool.

Commoning

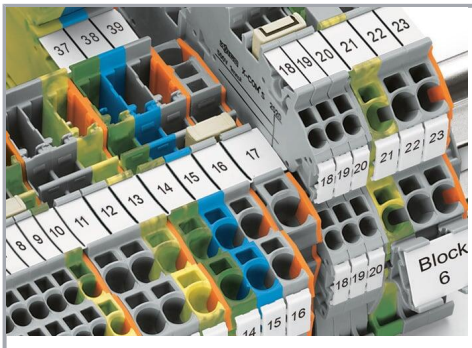

Commoning X-COM®S-SYSTEM Terminal Blocks using jumpers for TOPJOB® S Terminal Blocks. An end plate provides connection to TOPJOB® S Terminal Blocks. 2020 and 2022 Series Terminal Blocks are combinable. Jumper slots are on the same level for both series.

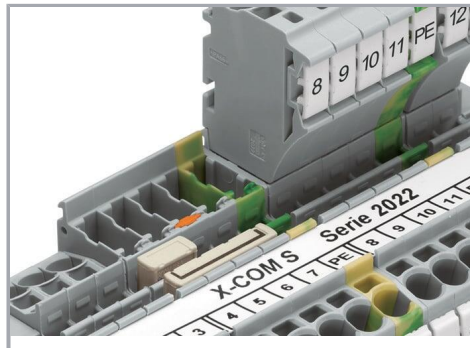

Pairing push-in comb style jumpers.

Subject to changes. Please also observe the further product documentation!

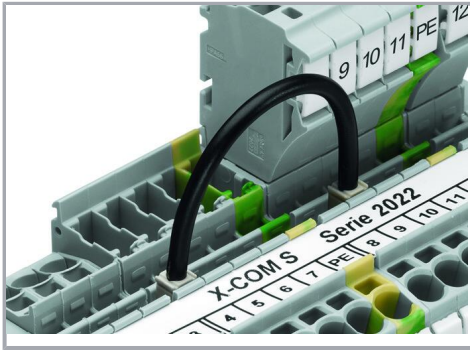

Commoning with push-in type wire jumper.

Testing

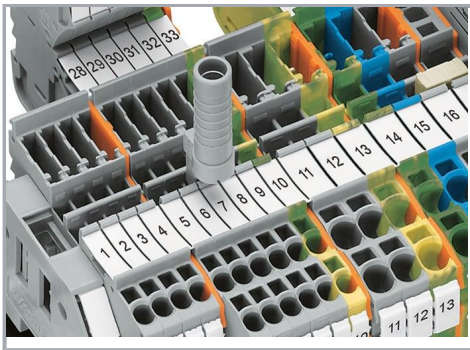

Test plug adapter (2009-174) for 4 mm test plugs or banana plugs – also suitable for X-COM®S-SYSTEM-MINI Terminal Blocks.

Coding

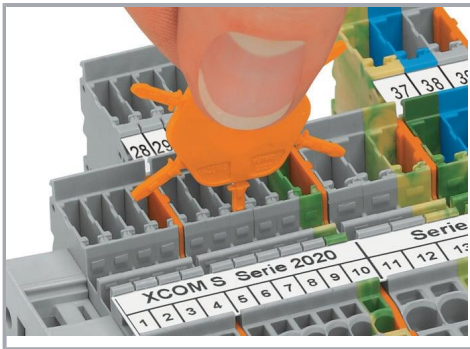

Insert coding pin into the corresponding slot and twist it off.

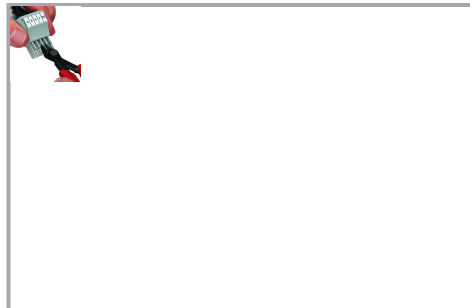

Coding a female plug: remove coding finger using a suitable tool.

Subject to changes. Please also observe the further product documentation!



Insert a coding pin (2022-100) into the corresponding location of the carrier terminal block.

Marking

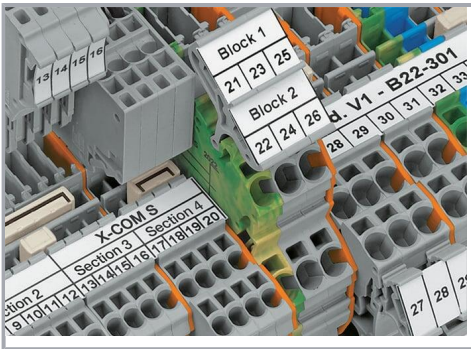

Clear marking via large marking area

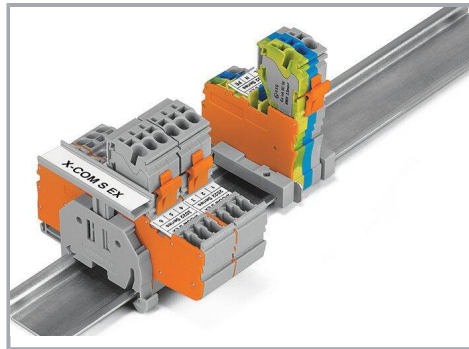

Group marking with height-adjustable group marker carrier (2009-163)

Security

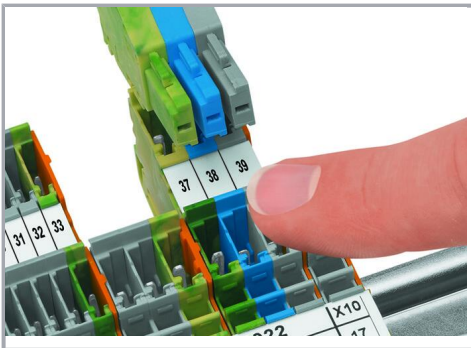

Carrier terminal blocks and female plugs are touch-proof.

Product family

Subject to changes. Please also observe the further product documentation!



X-COM S

[Show all products from the family](#)

Subject to changes. Please also observe the further product documentation!

WAGO GmbH & Co. KG
Hansastr. 27
32423 Minden
Phone: +49571 887-0 | Fax: +49571 887-169
Email: info.de@wago.com | Web: www.wago.com

Do you have any questions about our products?
We are always happy to take your call at +49 (571) 887-44222.