

## N-Channel MOSFET

Power MOS 8™ is a high speed, high voltage N-channel switch-mode power MOSFET. A proprietary planar stripe design yields excellent reliability and manufacturability. Low switching loss is achieved with low input capacitance and ultra low  $C_{rss}$  "Miller" capacitance. The intrinsic gate resistance and capacitance of the poly-silicon gate structure help control slew rates during switching, resulting in low EMI and reliable paralleling, even when switching at very high frequency. Reliability in flyback, boost, forward, and other circuits is enhanced by the high avalanche energy capability.

 IS OTO P\*  
**APT58M50J**

Single die MOSFET

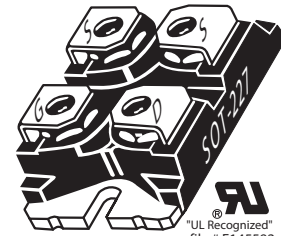
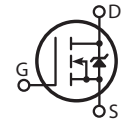

### FEATURES

- Fast switching with low EMI/RFI
- Low  $R_{DS(on)}$
- Ultra low  $C_{rss}$  for improved noise immunity
- Low gate charge
- Avalanche energy rated
- RoHS compliant 

### TYPICAL APPLICATIONS

- PFC and other boost converter
- Buck converter
- Two switch forward (asymmetrical bridge)
- Single switch forward
- Flyback
- Inverters

### Absolute Maximum Ratings

Symbol	Parameter	Ratings	Unit
$I_D$	Continuous Drain Current @ $T_C = 25^\circ\text{C}$	58	A
	Continuous Drain Current @ $T_C = 100^\circ\text{C}$	37	
$I_{DM}$	Pulsed Drain Current <sup>①</sup>	270	
$V_{GS}$	Gate-Source Voltage	±30	V
$E_{AS}$	Single Pulse Avalanche Energy <sup>②</sup>	1845	mJ
$I_{AR}$	Avalanche Current, Repetitive or Non-Repetitive	42	A

### Thermal and Mechanical Characteristics

Symbol	Characteristic	Min	Typ	Max	Unit
$P_D$	Total Power Dissipation @ $T_C = 25^\circ\text{C}$			540	W
$R_{\theta JC}$	Junction to Case Thermal Resistance			0.23	°C/W
$R_{\theta CS}$	Case to Sink Thermal Resistance, Flat, Greased Surface		0.15		
$T_J, T_{STG}$	Operating and Storage Junction Temperature Range	-55		150	°C
$V_{Isolation}$	RMS Voltage (50-60Hz Sinusoidal Waveform from Terminals to Mounting Base for 1 Min.)	2500			V
$W_T$	Package Weight		1.03		oz
			29.2		g
Torque	Terminals and Mounting Screws.			10	in·lbf
				1.1	N·m

**Static Characteristics**
**T<sub>J</sub> = 25°C unless otherwise specified**
**APT58M50J**

Symbol	Parameter	Test Conditions	Min	Typ	Max	Unit
V <sub>BR(DSS)</sub>	Drain-Source Breakdown Voltage	V <sub>GS</sub> = 0V, I <sub>D</sub> = 250μA	500			V
ΔV <sub>BR(DSS)}/ΔT<sub>J</sub></sub>	Breakdown Voltage Temperature Coefficient	Reference to 25°C, I <sub>D</sub> = 250μA		0.60		V/°C
R <sub>DS(on)</sub>	Drain-Source On Resistance <sup>③</sup>	V <sub>GS</sub> = 10V, I <sub>D</sub> = 42A		0.055	0.065	Ω
V <sub>GS(th)</sub>	Gate-Source Threshold Voltage	V <sub>GS</sub> = V <sub>DS</sub> , I <sub>D</sub> = 2.5mA	3	4	5	V
ΔV <sub>GS(th)}/ΔT<sub>J</sub></sub>	Threshold Voltage Temperature Coefficient			-10		mV/°C
I <sub>DSS</sub>	Zero Gate Voltage Drain Current	V <sub>DS</sub> = 500V V <sub>GS</sub> = 0V			100	μA
		T <sub>J</sub> = 25°C			500	
		T <sub>J</sub> = 125°C				
I <sub>GSS</sub>	Gate-Source Leakage Current	V <sub>GS</sub> = ±30V			±100	nA

**Dynamic Characteristics**
**T<sub>J</sub> = 25°C unless otherwise specified**

Symbol	Parameter	Test Conditions	Min	Typ	Max	Unit
g <sub>fs</sub>	Forward Transconductance	V <sub>DS</sub> = 50V, I <sub>D</sub> = 42A		65		S
C <sub>iss</sub>	Input Capacitance	V <sub>GS</sub> = 0V, V <sub>DS</sub> = 25V f = 1MHz		13500		pF
C <sub>rss</sub>	Reverse Transfer Capacitance			185		
C <sub>oss</sub>	Output Capacitance			1455		
C <sub>o(cr)</sub> <sup>④</sup>	Effective Output Capacitance, Charge Related	V <sub>GS</sub> = 0V, V <sub>DS</sub> = 0V to 333V		845		pF
C <sub>o(er)</sub> <sup>⑤</sup>	Effective Output Capacitance, Energy Related			425		
Q <sub>g</sub>	Total Gate Charge	V <sub>GS</sub> = 0 to 10V, I <sub>D</sub> = 42A, V <sub>DS</sub> = 250V		340		nC
Q <sub>gs</sub>	Gate-Source Charge			75		
Q <sub>gd</sub>	Gate-Drain Charge			155		
t <sub>d(on)</sub>	Turn-On Delay Time	<b>Resistive Switching</b> V <sub>DD</sub> = 333V, I <sub>D</sub> = 42A R <sub>G</sub> = 2.2Ω <sup>⑥</sup> , V <sub>GG</sub> = 15V		60		ns
t <sub>r</sub>	Current Rise Time			70		
t <sub>d(off)</sub>	Turn-Off Delay Time			155		
t <sub>f</sub>	Current Fall Time			50		

**Source-Drain Diode Characteristics**

Symbol	Parameter	Test Conditions	Min	Typ	Max	Unit
I <sub>S</sub>	Continuous Source Current (Body Diode)	MOSFET symbol showing the integral reverse p-n junction diode (body diode)			58	A
I <sub>SM</sub>	Pulsed Source Current (Body Diode) <sup>①</sup>				270	
V <sub>SD</sub>	Diode Forward Voltage	I <sub>SD</sub> = 42A, T <sub>J</sub> = 25°C, V <sub>GS</sub> = 0V			1.0	V
t <sub>rr</sub>	Reverse Recovery Time	I <sub>SD</sub> = 42A <sup>②</sup>		720		ns
Q <sub>rr</sub>	Reverse Recovery Charge	di <sub>SD</sub> /dt = 100A/μs, T <sub>J</sub> = 25°C		20		μC
dv/dt	Peak Recovery dv/dt	I <sub>SD</sub> ≤ 42A, di/dt ≤ 1000A/μs, V <sub>DD</sub> = 100V, T <sub>J</sub> = 125°C			8	V/ns

① Repetitive Rating: Pulse width and case temperature limited by maximum junction temperature.

② Starting at T<sub>J</sub> = 25°C, L = 2.08mH, R<sub>G</sub> = 2.2Ω, I<sub>AS</sub> = 42A.

③ Pulse test: Pulse Width < 380μs, duty cycle < 2%.

④ C<sub>o(cr)</sub> is defined as a fixed capacitance with the same stored charge as C<sub>OSS</sub> with V<sub>DS</sub> = 67% of V<sub>(BR)DSS</sub>.

⑤ C<sub>o(er)</sub> is defined as a fixed capacitance with the same stored energy as C<sub>OSS</sub> with V<sub>DS</sub> = 67% of V<sub>(BR)DSS</sub>. To calculate C<sub>o(er)</sub> for any value of V<sub>DS</sub> less than V<sub>(BR)DSS</sub>, use this equation: C<sub>o(er)</sub> = -3.14E-7/V<sub>DS</sub><sup>2</sup> + 7.31E-8/V<sub>DS</sub> + 2.09E-10.

⑥ R<sub>G</sub> is external gate resistance, not including internal gate resistance or gate driver impedance. (MIC4452)

Microsemi reserves the right to change, without notice, the specifications and information contained herein.

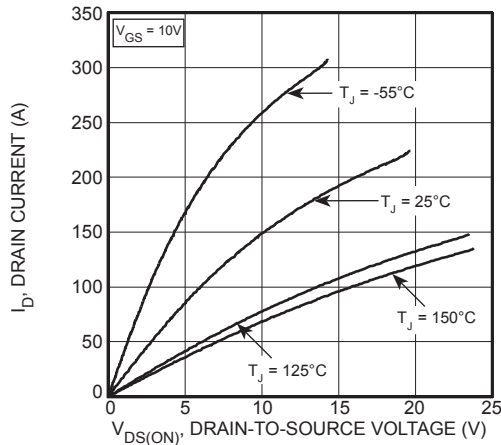

Figure 1, Output Characteristics

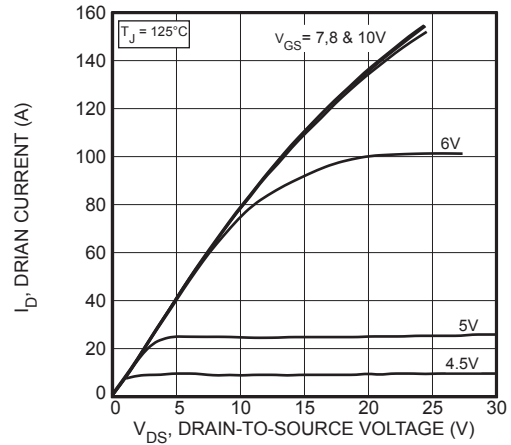

Figure 2, Output Characteristics

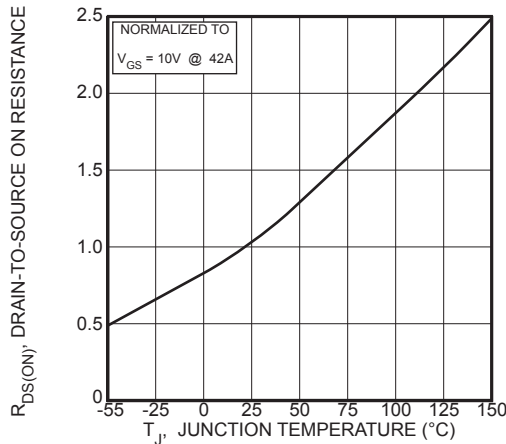

Figure 3,  $R_{DS(ON)}$  vs Junction Temperature

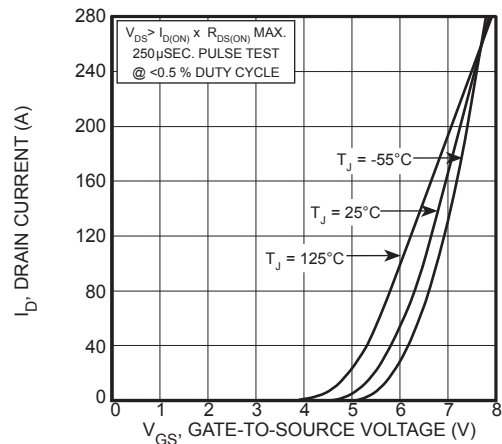

Figure 4, Transfer Characteristics

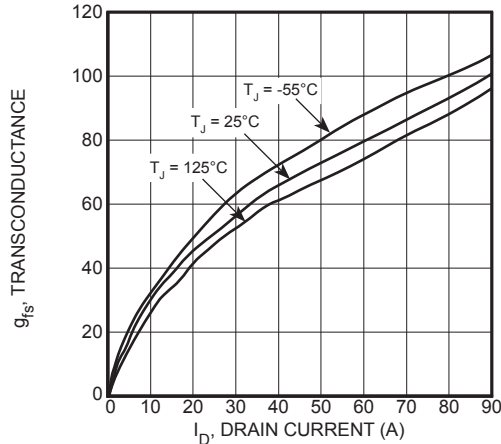

Figure 5, Gain vs Drain Current

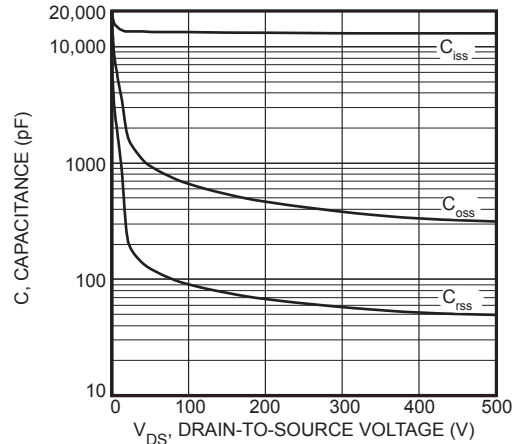

Figure 6, Capacitance vs Drain-to-Source Voltage

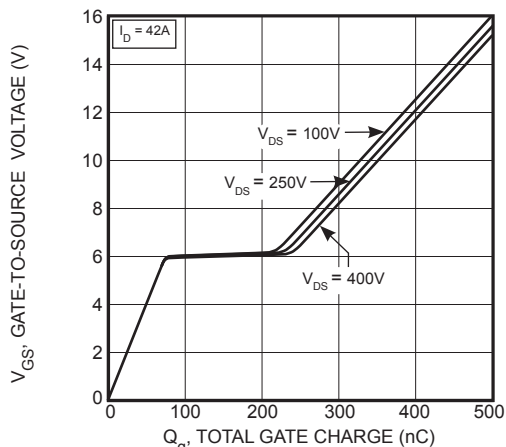

Figure 7, Gate Charge vs Gate-to-Source Voltage

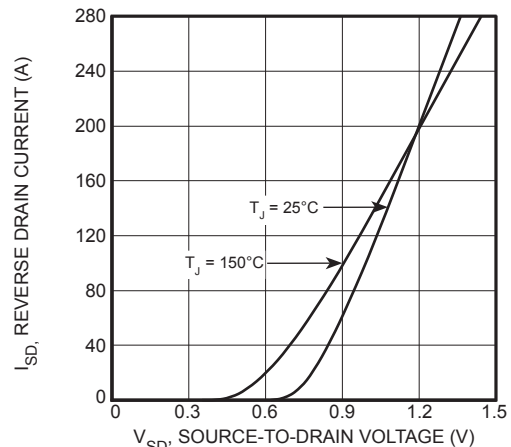

Figure 8, Reverse Drain Current vs Source-to-Drain Voltage

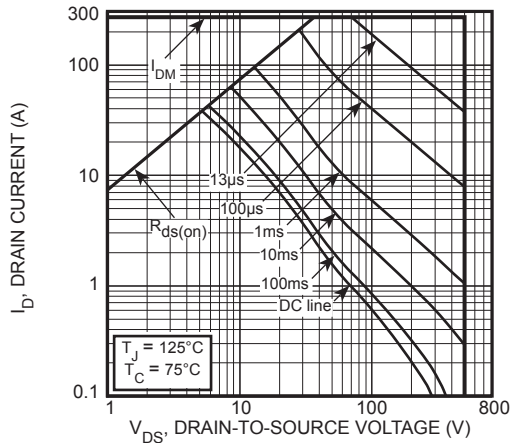

Figure 9, Forward Safe Operating Area

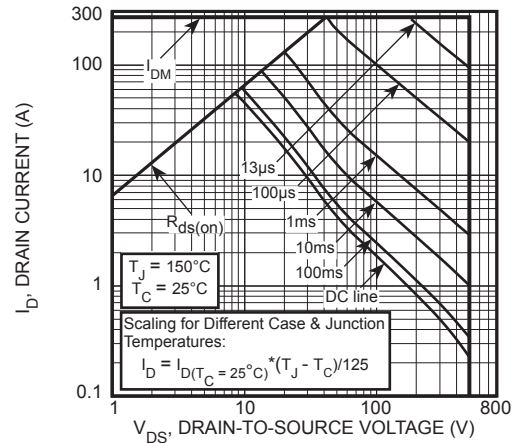

Figure 10, Maximum Forward Safe Operating Area

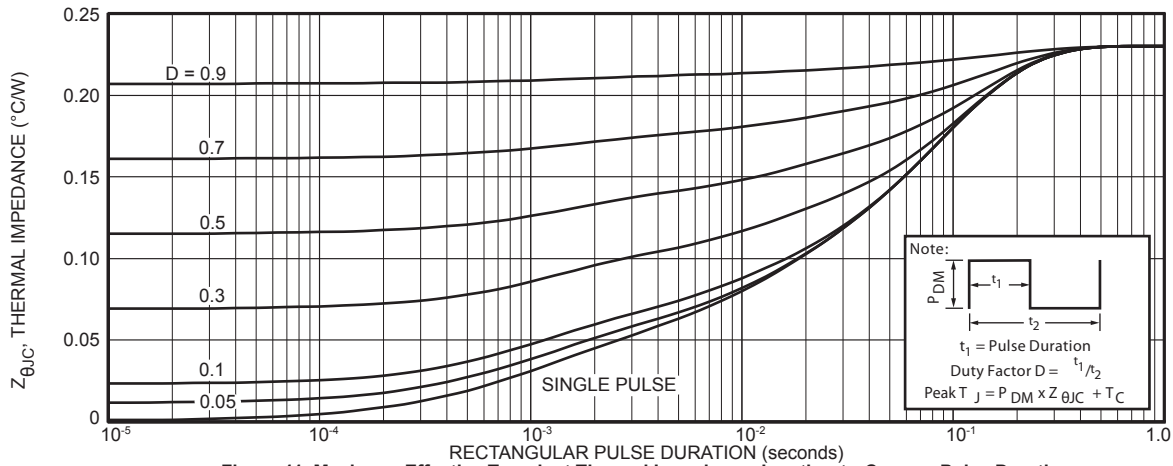
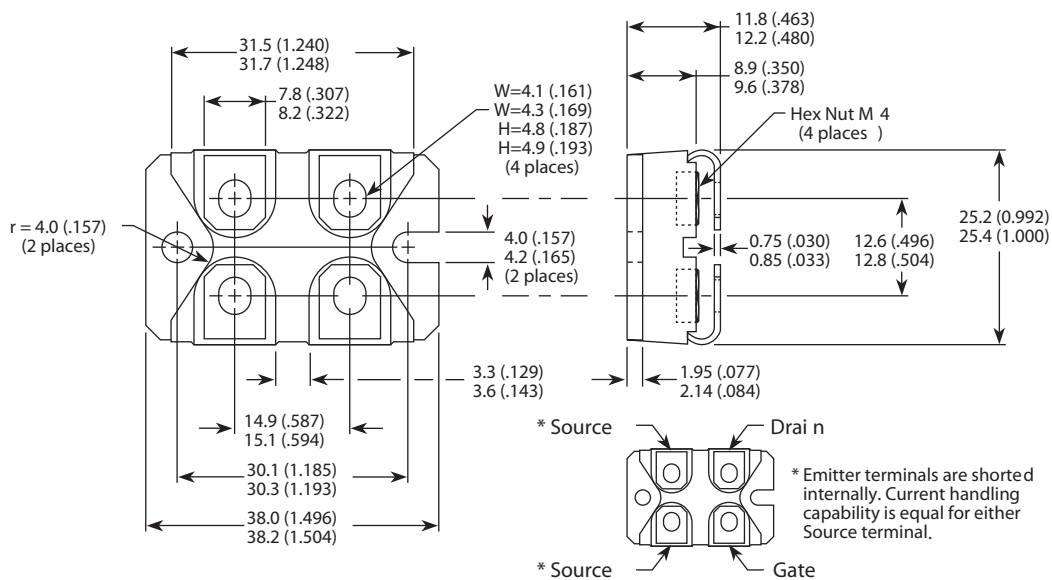

Figure 11. Maximum Effective Transient Thermal Impedance Junction-to-Case vs Pulse Duration

SOT-227 (ISOTOP®) Package Outline



Dimensions in Millimeters and (Inches)