

REV	CHANGE	DATE	DRN	CHK
	Drawn	12/28/16	SJ	T

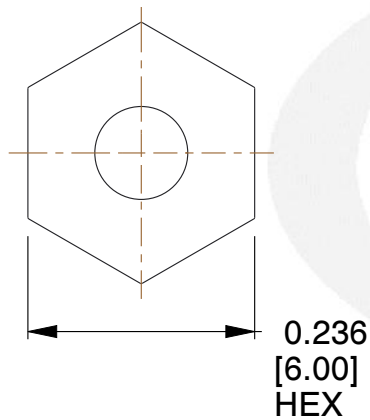

THREAD  
M3X0.5  
THRU

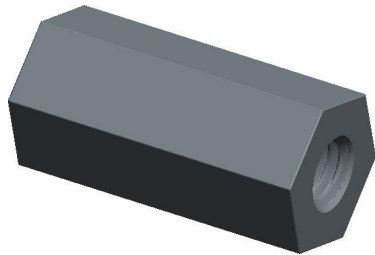
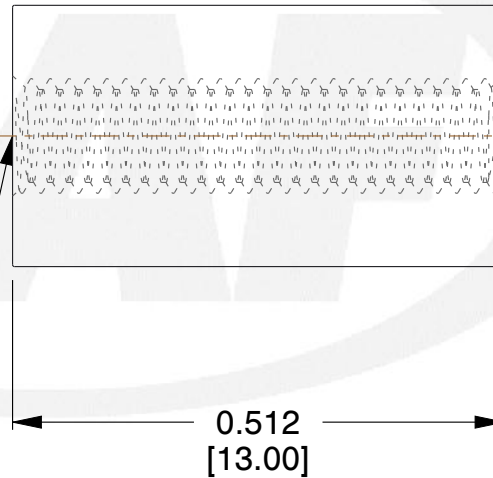

**NOTES:**

1. Material : Brass
2. Finish :
3. ASME Y14.5M - 2009
4. All Drawing Dimensions are in Inches [mm]
5. Unless otherwise specified; Edge Breaks, Radii or Countersinks 0.005-0.015



95 Silvermine Rd., Seymour CT 06483  
Tel: 203-888-2133, Fax: 203-888-9860

This Drawing is the Property of RAF.  
It contains confidential, proprietary information that is RAF property. Do not disclose to or duplicate for others except as authorized by RAF.

TOLERANCES  
ALL DIMENSIONS ARE INCHES (UNLESS OTHERWISE SPECIFIED)  
METALLIC  
LENGTHS <= 6 INCHES ± 0.005  
LENGTH > 6 INCHES ± 0.010  
DIAMETERS: ± 0.005  
NON-METALLIC  
LENGTH: ± 0.010 DIAMETERS: ± 0.010  
INTERNAL THREADS:  
MINIMUM THREAD DEPTH

COMPONENT	STANDOFFS
M1310-3005-B  6 MM HEX FEMALE STANDOFFS	<b>SCALE</b>
	5.00
	<b>SHEET</b>
	1 of 1