



TAOGLAS®



Datasheet

Genesis 4 in 1 High Temperature

Part No:
MA244.LBIC.002

Description:

High Temperature Genesis 4 in 1 antenna 1*GNSS, 2*5G/4G MIMO, 1* Dual Band Wi-Fi
With 1m RG-174 & TGC-200 and SMA(M)

Features:

Adhesive Mount High Temperature (Up to 85°C) Combination Antenna

1* GPS-GLONASS: 1 meter RG-174 SMA(M)

2 * LTE: 1 meter Low loss TGC-200 SMA(M)

1 * Wi-Fi: 1 meter Low loss TGC-200 RP-SMA(M)

IP65 Rated Enclosure

Dimensions: 205.8 x 68 x 12.4mm

RoHS & Reach Compliant

1. Introduction	3
2. Specifications	4
3. Antenna Characteristics	9
4. Radiation Patterns	17
5. Mechanical Drawing	44
6. Packaging	45
7. Application Note	46
<hr/>	
Changelog	53

Taoglas makes no warranties based on the accuracy or completeness of the contents of this document and reserves the right to make changes to specifications and product descriptions at any time without notice. Taoglas reserves all rights to this document and the information contained herein. Reproduction, use or disclosure to third parties without express permission is strictly prohibited.



1. Introduction



The Taoglas Genesis MA244 is a 4in1 combination, adhesive mount lightweight antenna, ideal for use in telematics, transportation and remote monitoring applications. This unique antenna delivers powerful 5G/4G MIMO antenna technology for cellular, covering a number of 5G FR1 bands and worldwide LTE, GPS/GLONASS/Galileo and dual-band Wi-Fi.

The GPS/GLONASS/GALILEO antenna has been carefully designed to work equally well on both GPS/GALILEO and GLONASS bands, leading to higher location accuracy and stability of tracking in urban environments. Both 2.4 and 5.8GHz are covered on the Wi-Fi antenna which exhibits a peak gain of greater than 4dBi and efficiency of up to 64%. The omnidirectional cellular antennas show efficiency of up to 72% depending on the bands used.

The robust PC/ABS enclosure is fully IP65 rated and designed to withstand the high temperatures of up to +85c normally associated with transportation and telematics applications.

The MA244 is an ideal solution for next-generation wireless technology systems, such as Telematics, Transportation, Fleet Management and Autonomous Robotics, all use cases that demand reliable, high-speed data uplink and downlink. High efficiency and high gain MIMO antennas are necessary to achieve the required signal to noise ratio and throughput required in these challenging applications.

Supplied with 1m of low loss TGC-200 cable and SMA(M) connectors as standard, cable length and connector types are fully customizable. Contact your regional Taoglas Customer support team for more information.

2. Specifications

GNSS Frequency Bands Covered							
GPS/QZSS	L1 1575.42MHz	L2 1227.6MHz	L5 1176.45MHz	L6 1278.75MHz			
	■	□	□	□			
GLONASS	L5R 1176.45MHz	L3PT 1201.5MHz	L2PT 1246MHz	L1CR 1575.42MHz	L1PT 1602MHz		
	□	□	□	□	■		
Galileo	E5a 1176.45MHz	E5b 1201.5MHz	E4 1215MHz	E3 1256MHz	E6 1278.75MHz	E2 1561MHz	L1 1575.42MHz
	□	□	□	□	□	□	■
BeiDou	B1 1561MHz	B2 1207.14MHz	B3 1268.52MHz				
	□	□	□				
Compass	E5B(B2)/ E6(B3) 1268.56MHz	E2(B1) 1561MHz					
	□	□					
SBAS	Omnistar 1542.5MHz	WAAS/EGN OS 1575.42MHz					
	□	■					

GNSS Electrical		
Frequency (MHz)	1575.42	1602
VSWR (max.)	2.0:1	2.0:1
Passive Antenna Efficiency (%) (Without cable loss)	63.14	67.16
Passive Antenna Average Gain (dB) (Without cable loss)	-2	-1.73
Passive Antenna Peak Gain (Without cable loss)	2.14	2.24
Polarization	RHCP	
Impedance	50Ω	
Cable	1m RG-174	
Connector	SMA(M) Straight	

LNA and Filter Electrical Properties		
Frequency (MHz)	1575.42	1602
VSWR (max.)	<1.5:1	<1.5:1
Impedance	50Ω	
Return Loss	10 dB Min.	
Gain (at 3.3V)	30dB	
Input Voltage	3.3V	
Noise Figure (at 3.3V)	1.7dB	
Current Consumption (at 3.3V)	15mA	

5G/4G MIMO Antenna										
Frequency (MHz)		LTE700	GSM 850/900	5G Band 74, 75, 76	DCS	PCS	UMTS1	LTE2600	5G Band 77, 78, 79	5G Band 42,43
		698 ~806	824 ~960	1427 ~1518	1710 ~1880	1850 ~1990	1920 ~2170	2300 ~2690	3300 ~3500	3400 ~3800
Efficiency (%)										
MIMO 1	1m	63.96	65.29	18.72	45.68	60.61	67.73	64.55	39.1	42.27
MIMO 2	1m	53.18	57.75	14.45	51.02	71.45	71.03	72.65	46.06	33.09
Average Gain (dB)										
MIMO 1	1m	-1.94	-2.02	-7.3	-3.4	-2.17	-1.49	-1.9	-4.08	-3.94
MIMO 2	1m	-2.74	-2.48	-8.45	-2.92	-1.46	-1.69	-1.39	-3.37	-4.90
Peak Gain (dBi)										
MIMO 1	1m	4.14	2.76	-2.77	2.54	3.74	4.28	4.75	3.03	1.20
MIMO 2	1m	4.45	2.7	-4.83	3.39	5	5	5.02	2.57	1.81
Impedance		50Ω								
Polarization		Linear								
VSWR		<5.8								
Radiation Pattern		Omni-Directional								
Envelope Correlation Coefficient		696MHz-960MHz <0.5 1700MHz-3500MHz <0.3								

5G/4G Bands			
Band Number	5G NR / FR1 / LTE / LTE-Advanced / WCDMA / HSPA / HSPA+ / TD-SCDMA		
	Uplink	Downlink	Covered
1	UL: 1920 to 1980	DL: 2110 to 2170	✓
2	UL: 1850 to 1910	DL: 1930 to 1990	✓
3	UL: 1710 to 1785	DL: 1805 to 1880	✓
4	UL: 1710 to 1755	DL: 2110 to 2155	✓
5	UL: 824 to 849	DL: 869 to 894	✓
7	UL: 2500 to 2570	DL: 2620 to 2690	✓
8	UL: 880 to 915	DL: 925 to 960	✓
9	UL: 1749.9 to 1784.9	DL: 1844.9 to 1879.9	✓
11	UL: 1427.9 to 1447.9	DL: 1475.9 to 1495.9	✓
12	UL: 699 to 716	DL: 729 to 746	✓
13	UL: 777 to 787	DL: 746 to 756	✓
14	UL: 788 to 798	DL: 758 to 768	✓
17	UL: 704 to 716	DL: 734 to 746 (LTE only)	✓
18	UL: 815 to 830	DL: 860 to 875 (LTE only)	✓
19	UL: 830 to 845	DL: 875 to 890	✓
20	UL: 832 to 862	DL: 791 to 821	✓
21	UL: 1447.9 to 1462.9	DL: 1495.9 to 1510.9	✗
22	UL: 3410 to 3490	DL: 3510 to 3590	✓
23	UL: 2000 to 2020	DL: 2180 to 2200 (LTE only)	✓
24	UL: 1625.5 to 1660.5	DL: 1525 to 1559 (LTE only)	✓
25	UL: 1850 to 1915	DL: 1930 to 1995	✓
26	UL: 814 to 849	DL: 859 to 894	✓
27	UL: 807 to 824	DL: 852 to 869 (LTE only)	✓
28	UL: 703 to 748	DL: 758 to 803 (LTE only)	✓
29	UL: -	DL: 717 to 728 (LTE only)	✓
30	UL: 2305 to 2315	DL: 2350 to 2360 (LTE only)	✓
31	UL: 452.5 to 457.5	DL: 462.5 to 467.5 (LTE only)	✗
32	UL: -	DL: 1452 - 1496	✗
35		1850 to 1910	✓
38		2570 to 2620	✓
39		1880 to 1920	✓
40		2300 to 2400	✓
41		2496 to 2690	✓
42		3400 to 3600	✓
43		3600 to 3800	✓
48		3550 to 3700	✓
66	UL: 1710-1780	DL: 2110-2200	✓
71		617 to 698	✗
74/75/76		1427 to 1518	✗
78		3300 to 3800	✓
79		4400 to 5000	✗

*Covered bands represent greater than 20% Efficiency

Wi-Fi		
Frequency (MHz)	2400~2500	4900~5850
Efficiency (%)		
1m	64.4	52.81
Average Gain (dB)		
1m	-1.91	-2.77
Peak Gain (dBi)		
1m	4.06	4.03
Impedance	50 Ω	
Polarization	Linear	
VSWR	< 5.8	

Mechanical	
Dimension	205.8 x 68 x 12.4 mm
Casing	PC+ABS
Cable	GNSS: 1m RG-174 2*Cellular: 1m TGC-200 Wi-Fi: 1m TGC-200
Connector	GNSS: SMA(M)ST 2*Cellular: SMA(M)ST Wi-Fi: RP-SMA(M)ST
Weight	330g
Environmental	
Protection	IP65
Operating Temperature	-40°C to 85°C
Storage Temperature	-40°C to 90°C
Humidity	Non-condensing 65°C 95% RH

3. Antenna Characteristics

3.1 Return Loss - GNSS

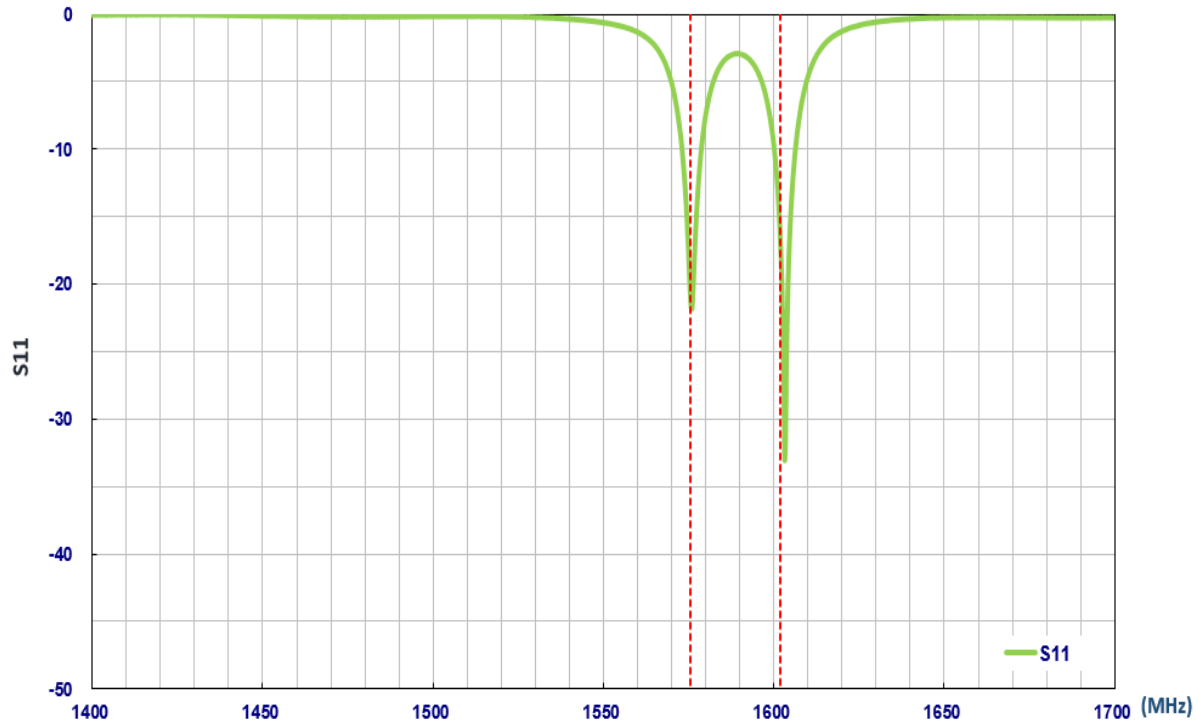

3.2 Efficiency - GNSS

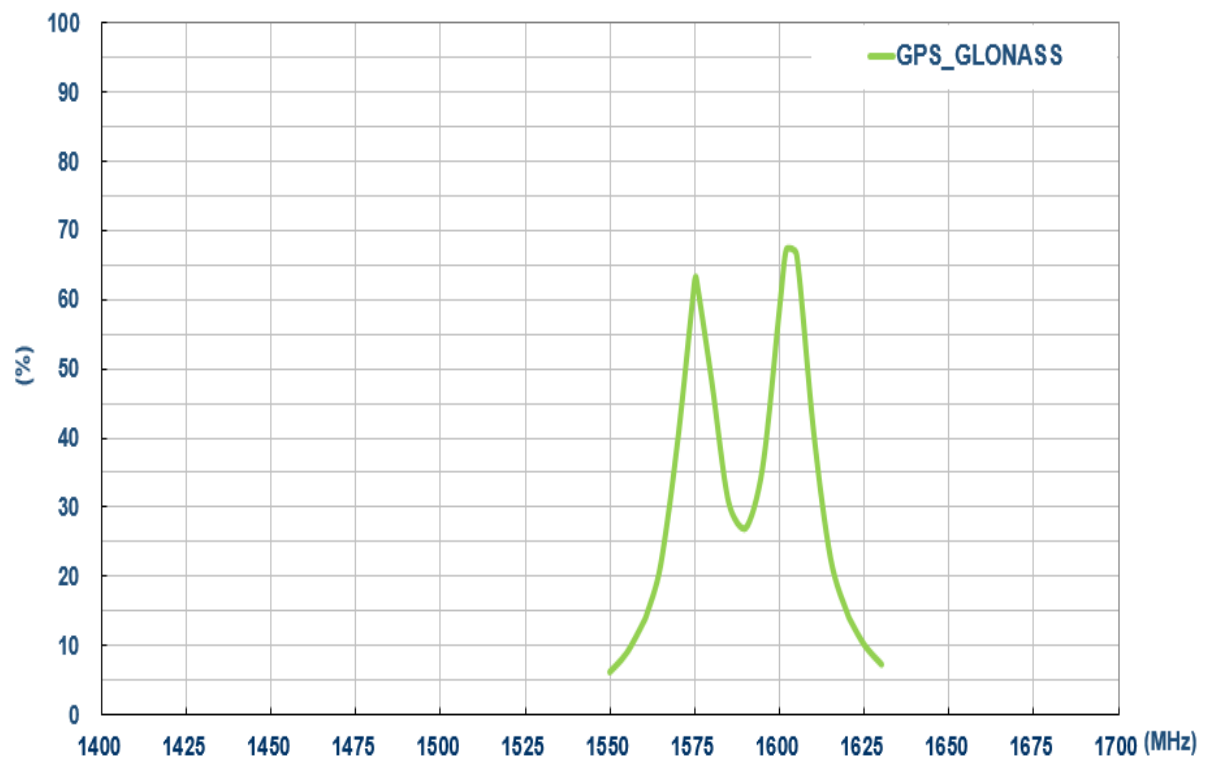

3.3 Average Gain - GNSS

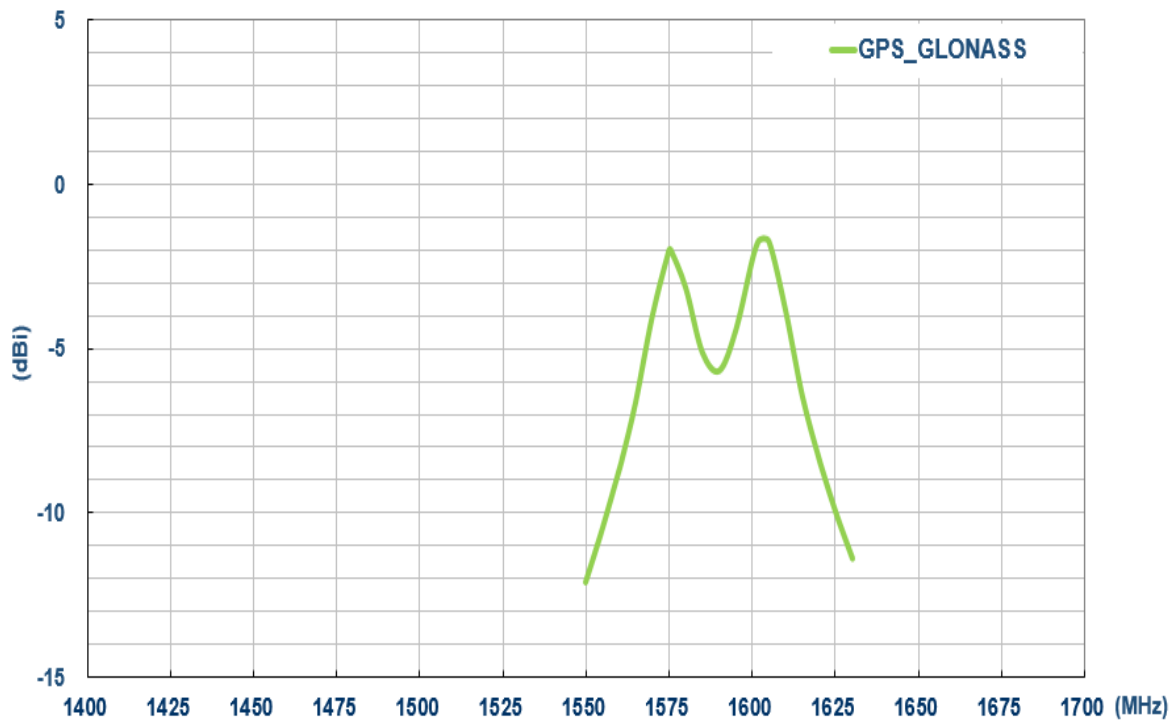

3.4 Peak Gain - GNSS

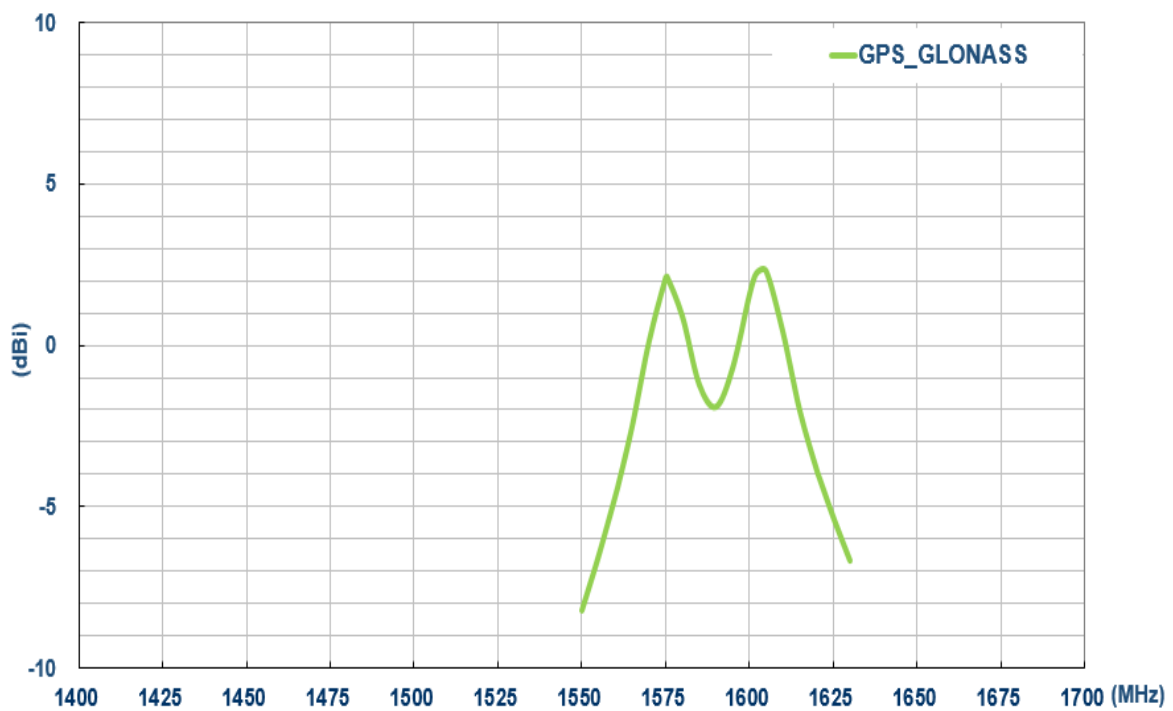

3.5 Smith Chart - GNSS

— Smith Chart

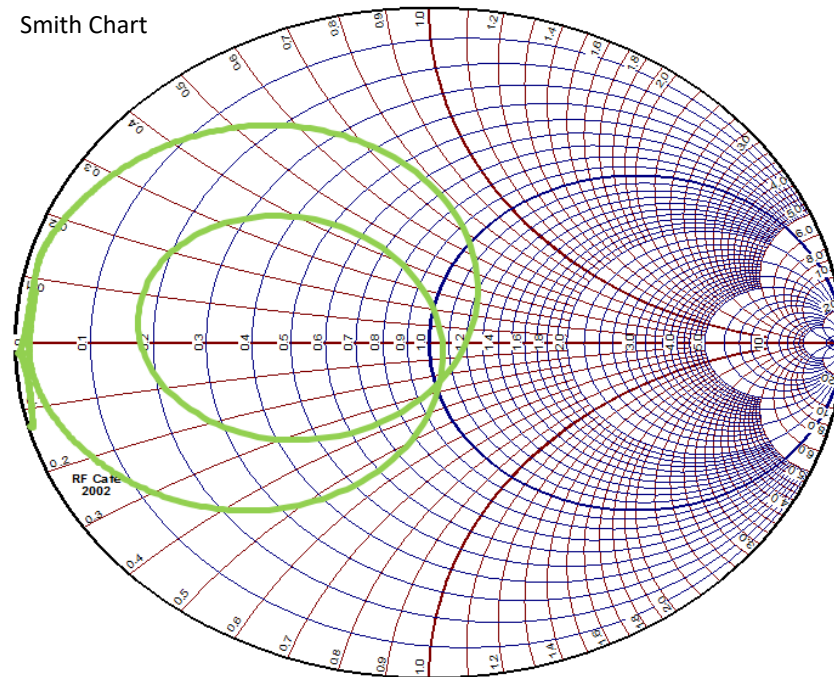

3.6 Axial Ratio - GNSS

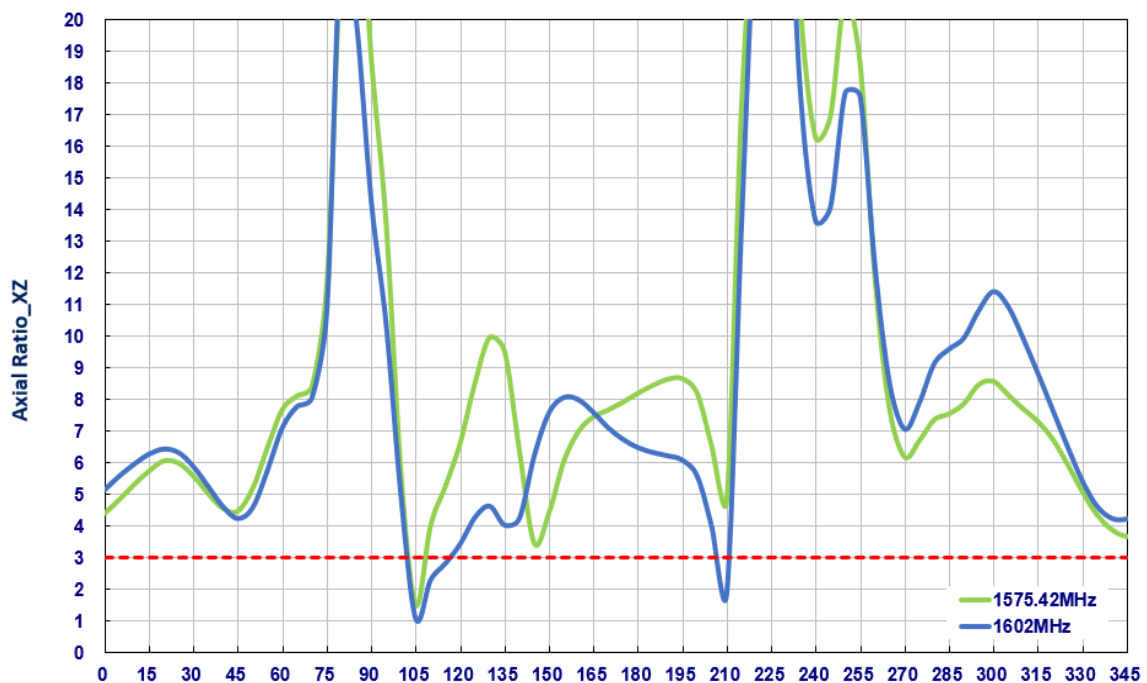

3.7 LNA Noise Figure - GNSS

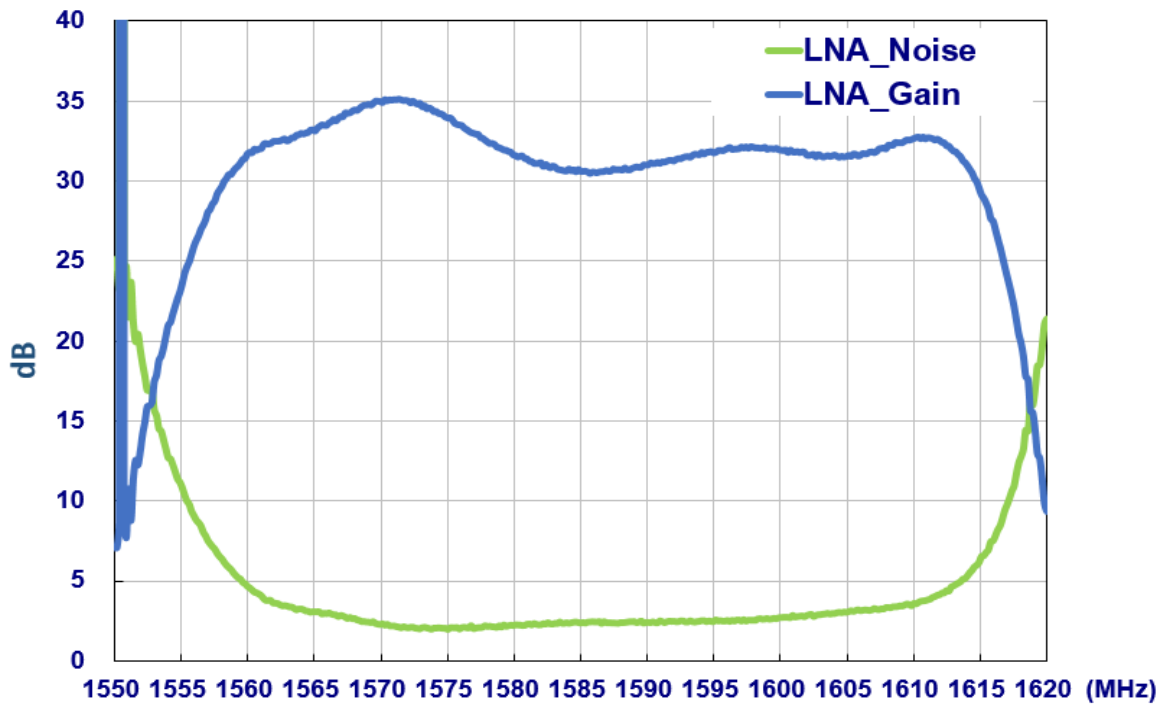

3.8 Out-of-Band Rejection - GNSS

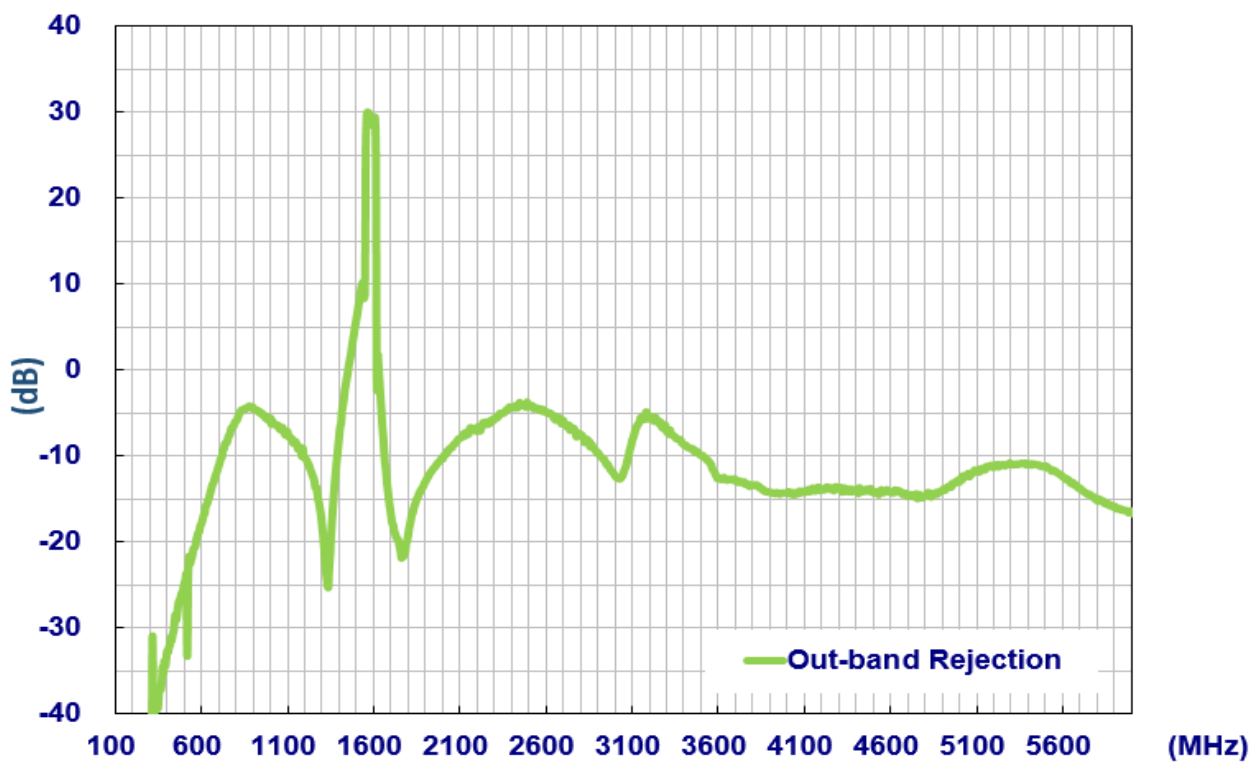

3.9 Return Loss – Cellular

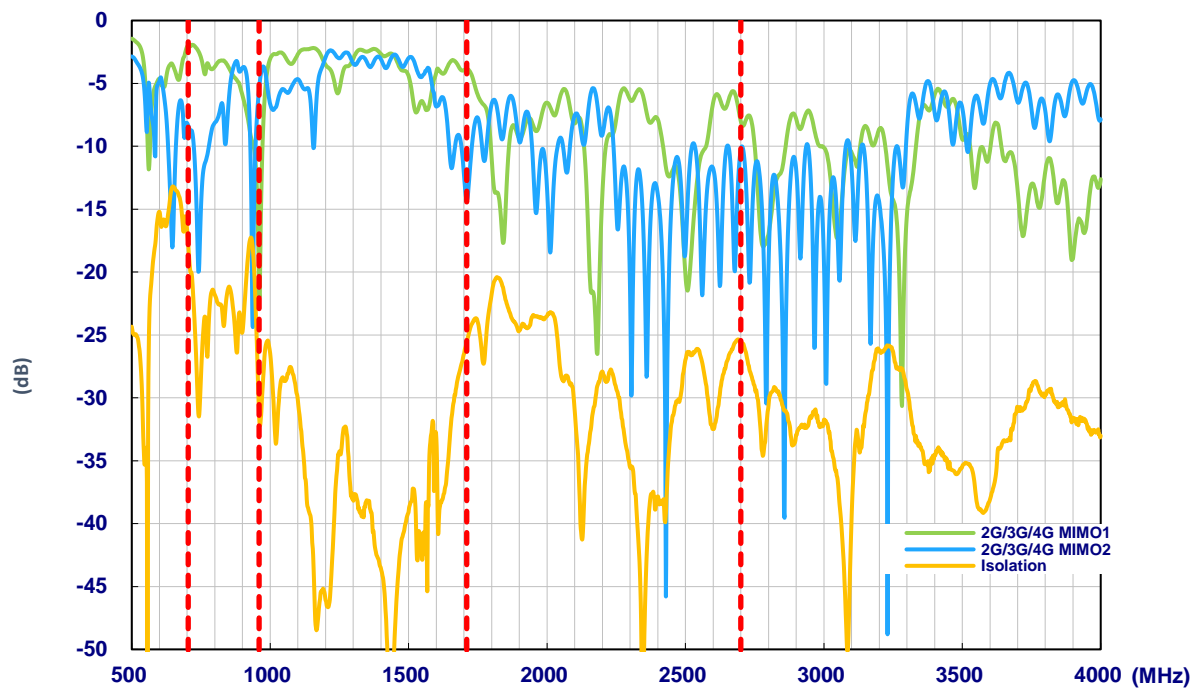

3.10 Efficiency - Cellular

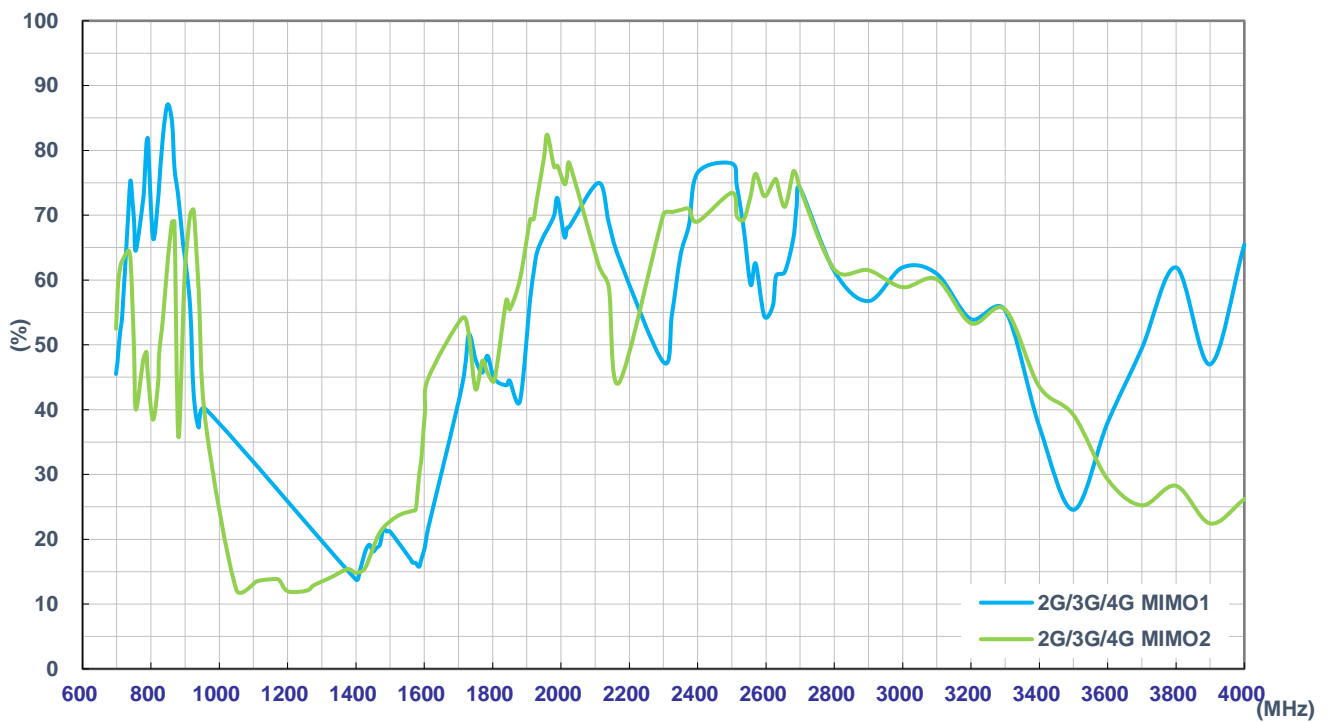

3.11 Average Gain - Cellular

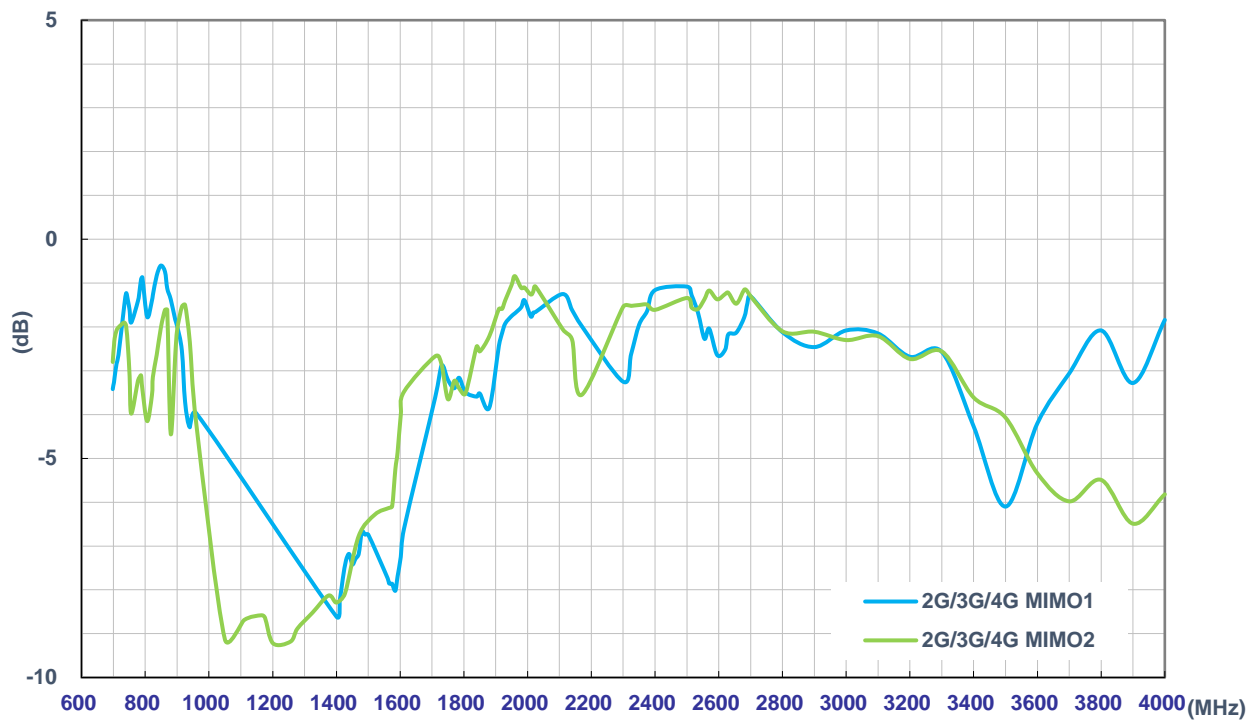

3.12 Peak Gain - Cellular

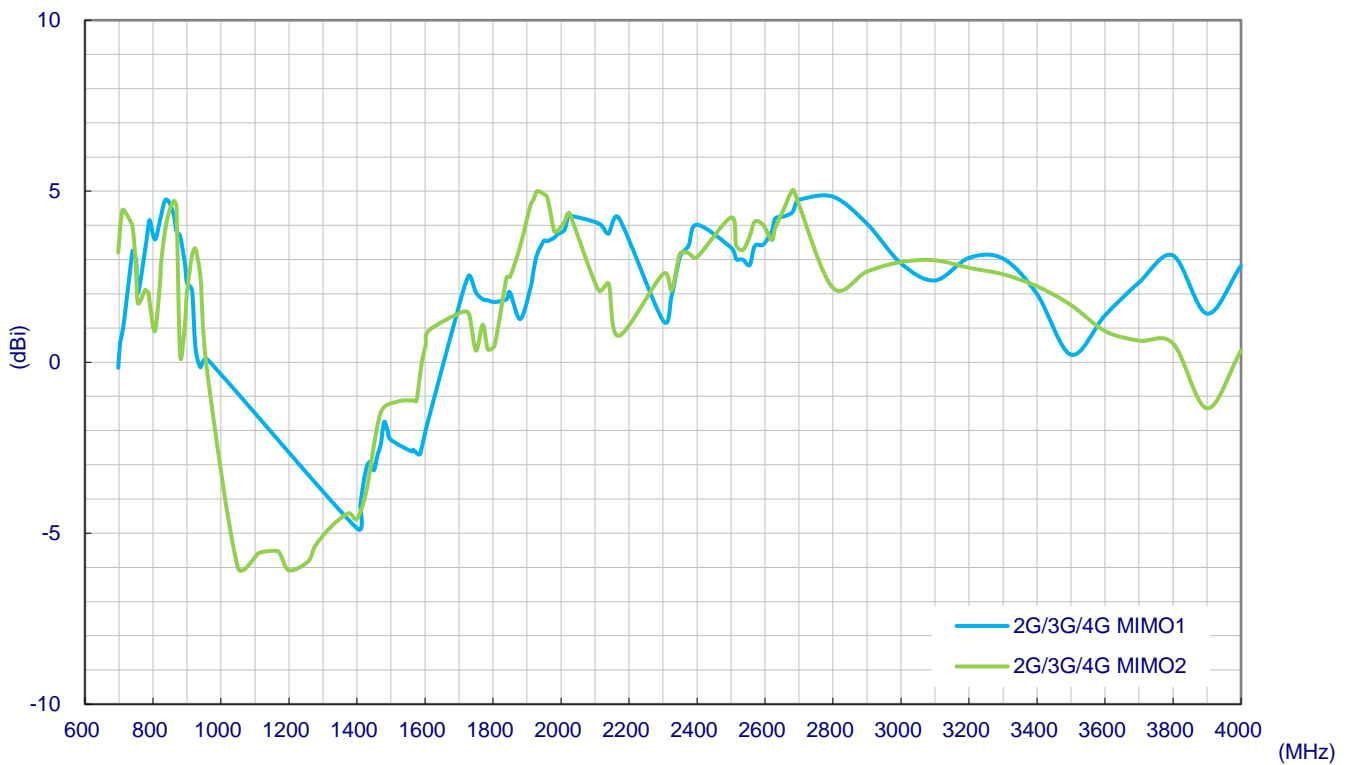

3.13 Return Loss – Wi-Fi

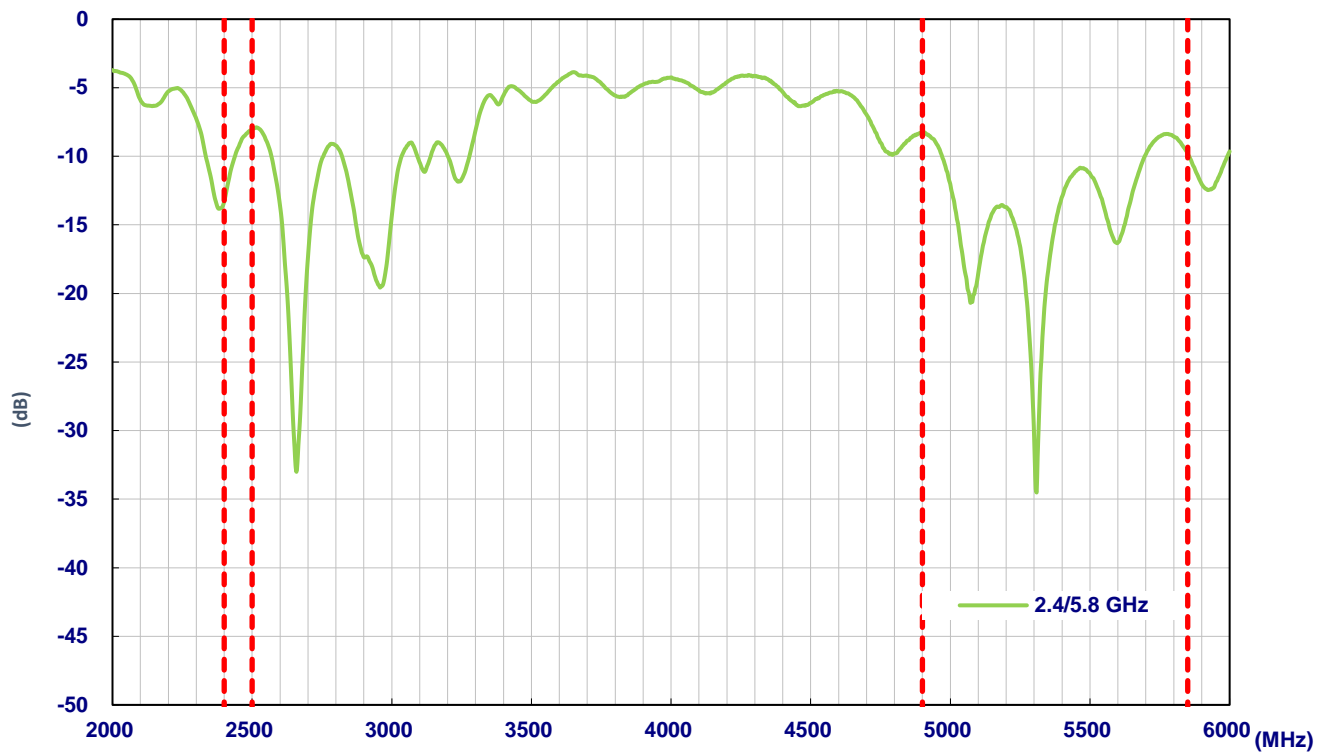

3.14 Efficiency – Wi-Fi

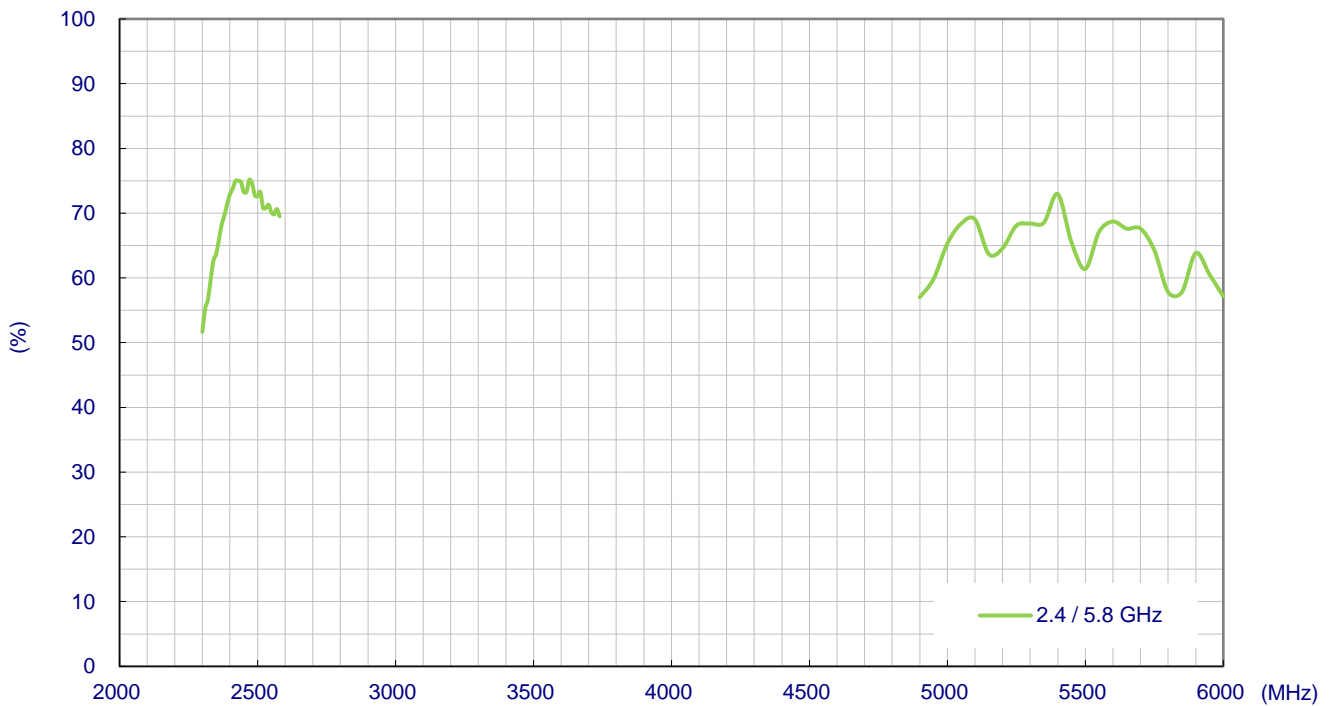

3.15 Average Gain – Wi-Fi

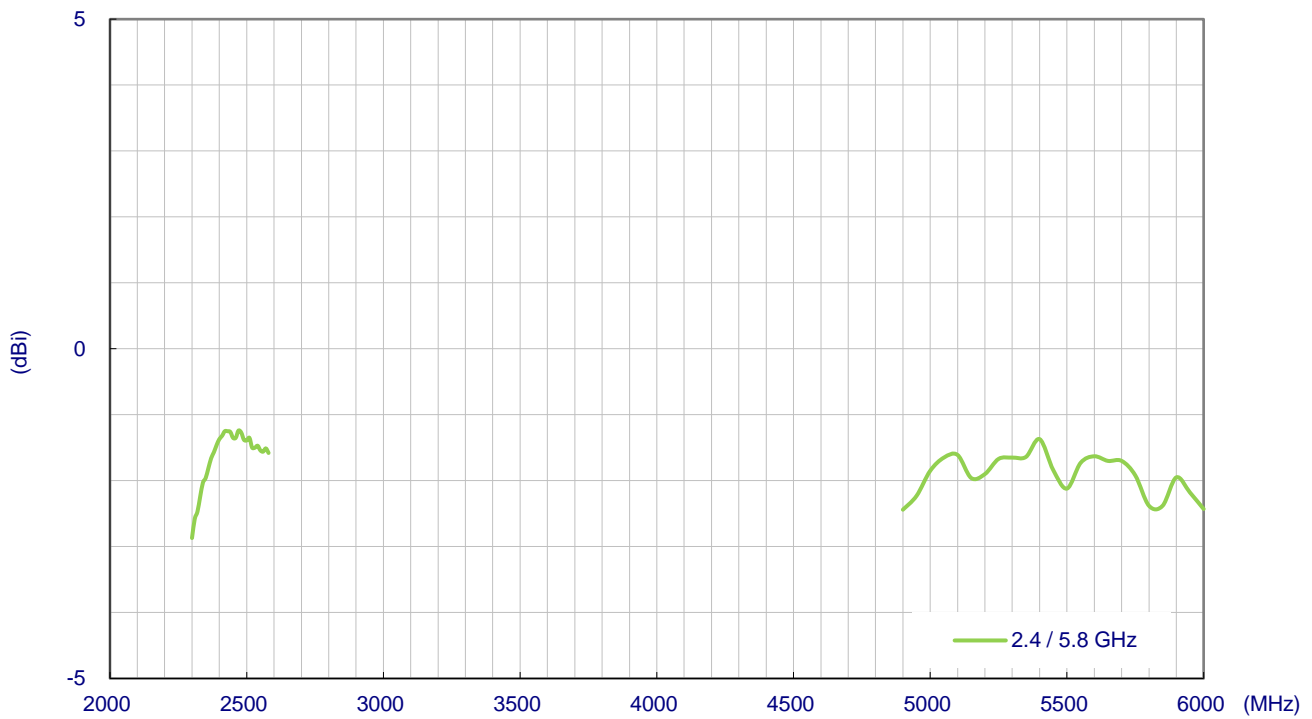

3.16 Peak Gain – Wi-Fi

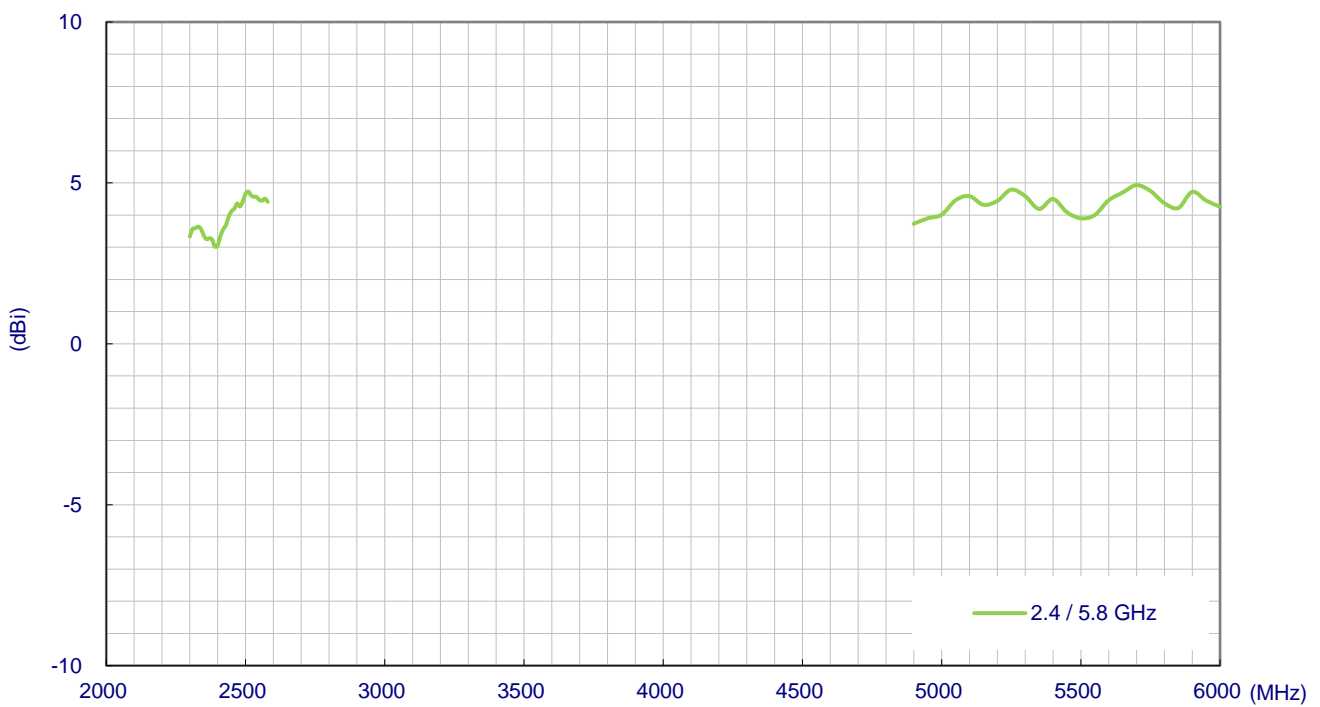

4. Radiation Patterns

4.1 Test Setup



Free space

4.2 GNSS 3D and 2D Radiation Patterns

1575.42MHz

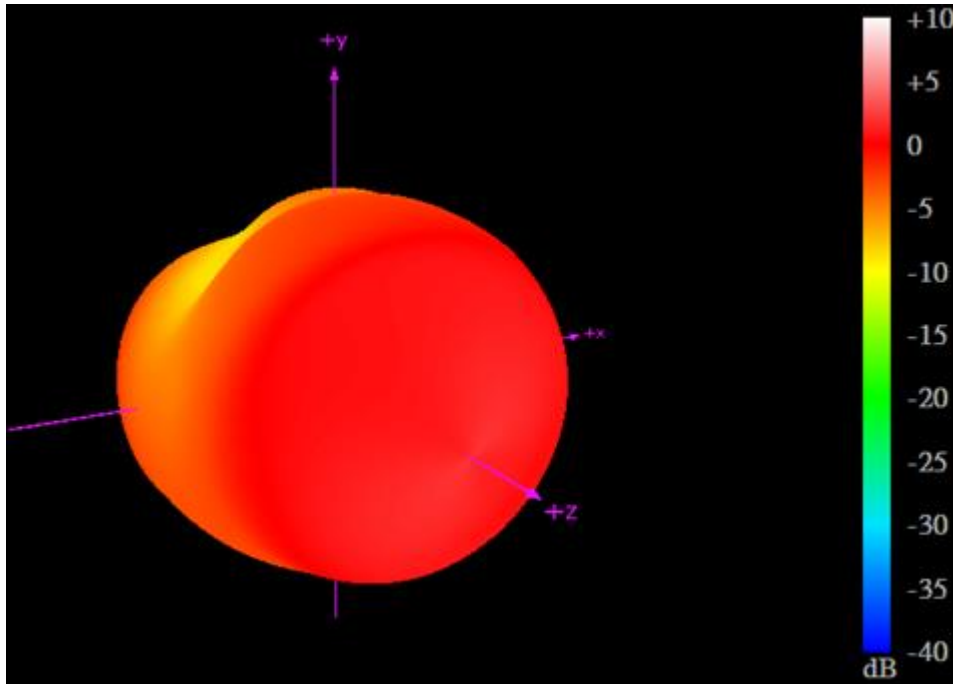

XY Plane

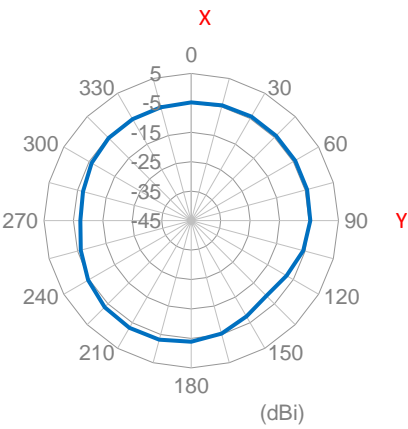

XZ Plane

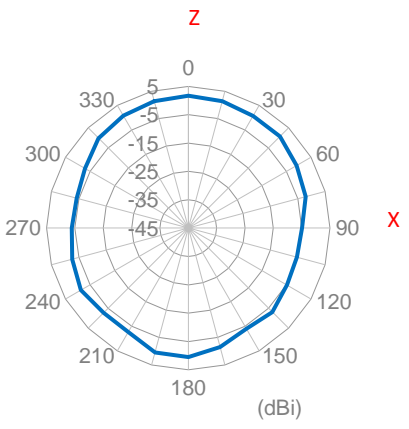

YZ Plane

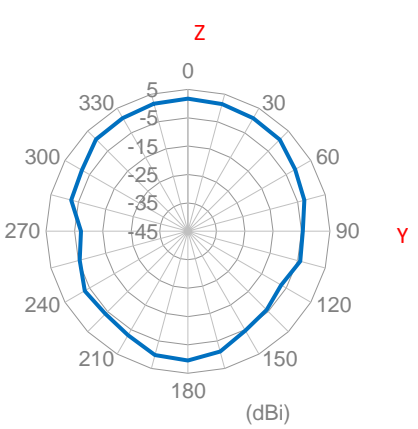

1602MHz

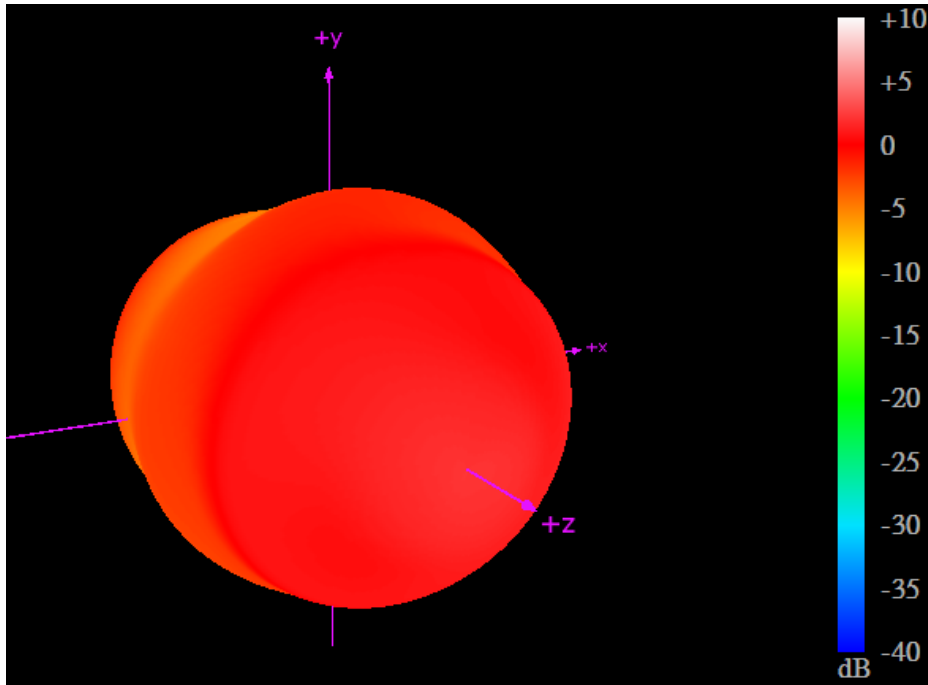

XY Plane

XZ Plane

YZ Plane

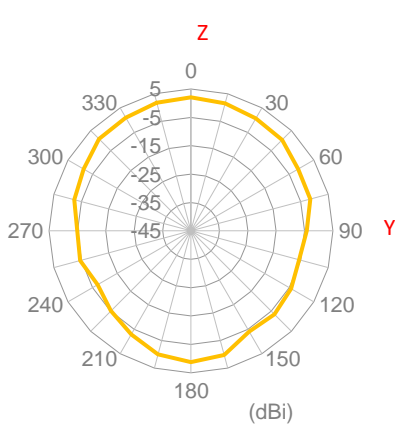
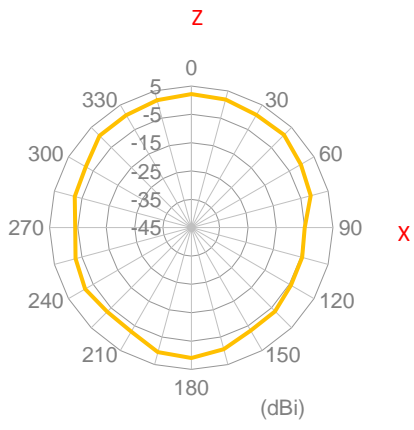
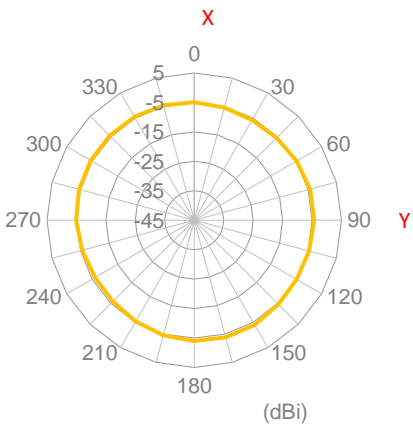

4.3 5G/4G MIMO 1 3D and 2D Radiation Patterns

704MHz

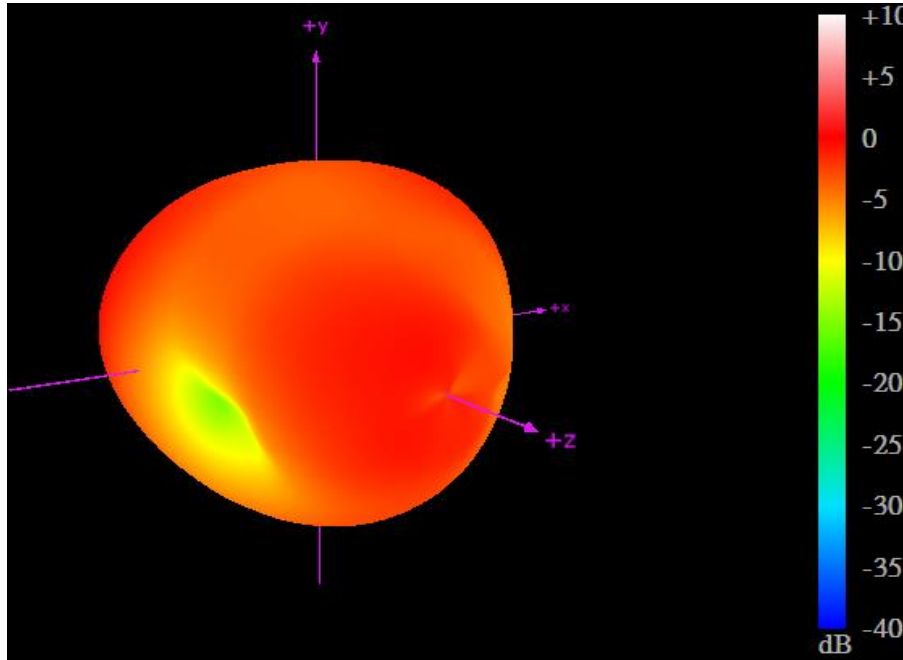

XY Plane XZ Plane YZ Plane

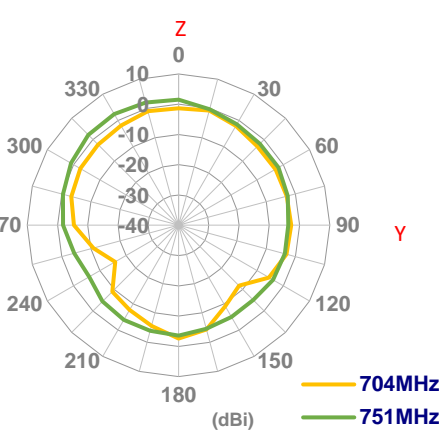
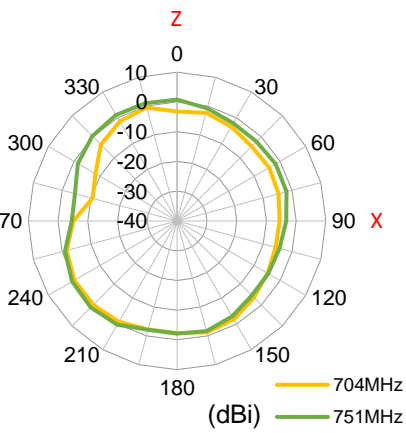
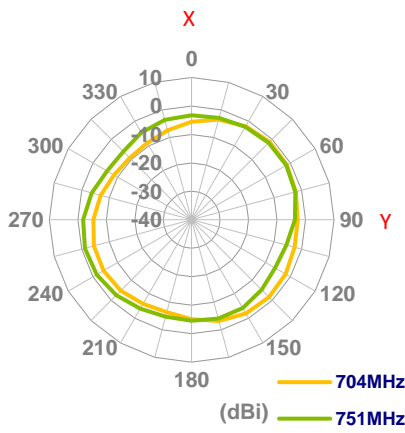

824MHz

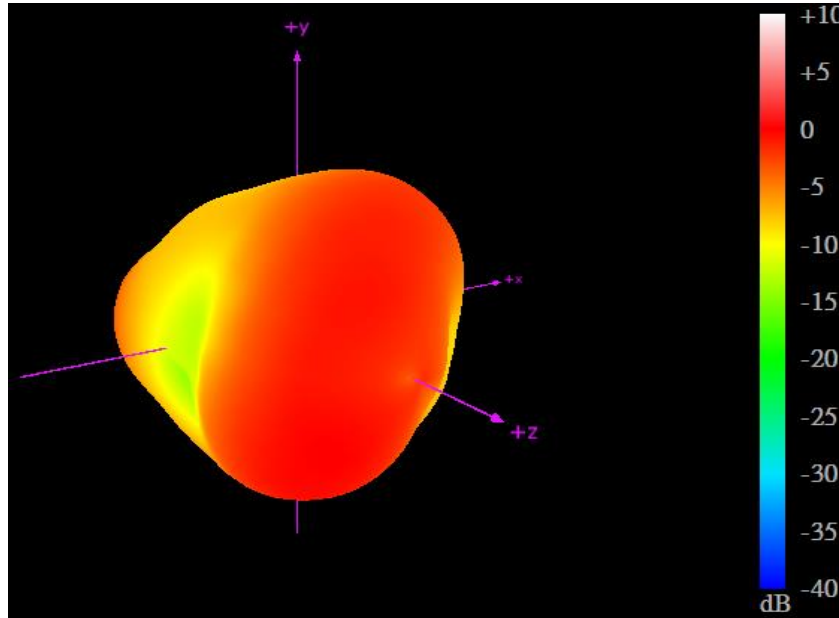

XY Plane

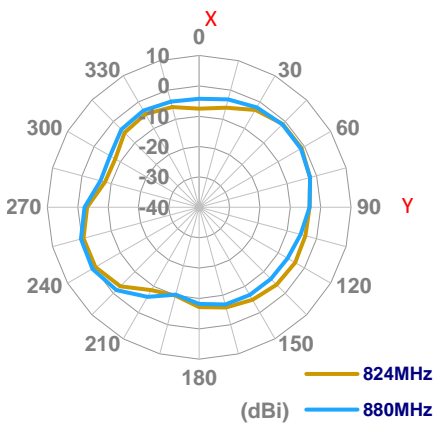

XZ Plane

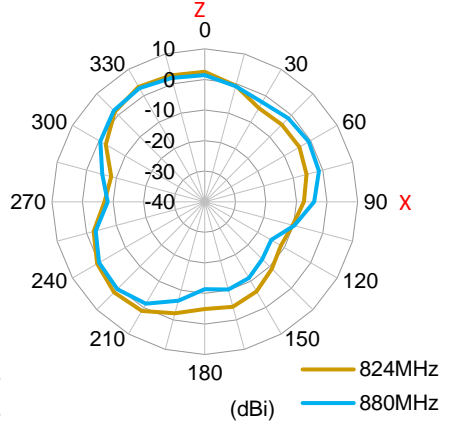

YZ Plane

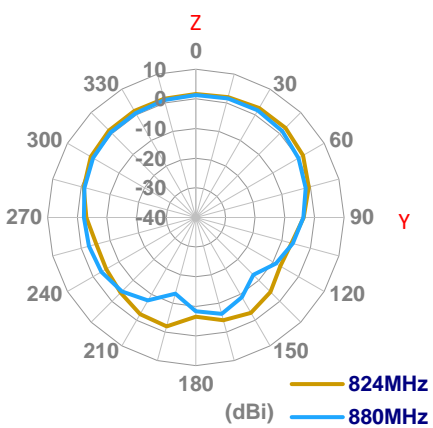

960MHz

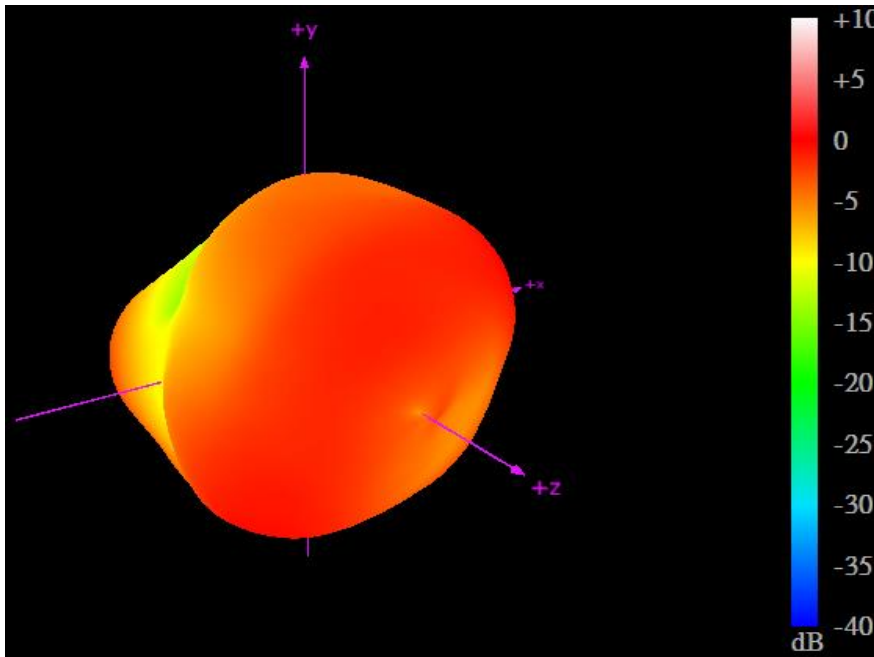

XY Plane

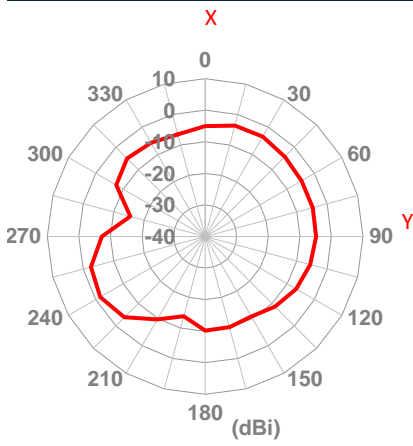

XZ Plane

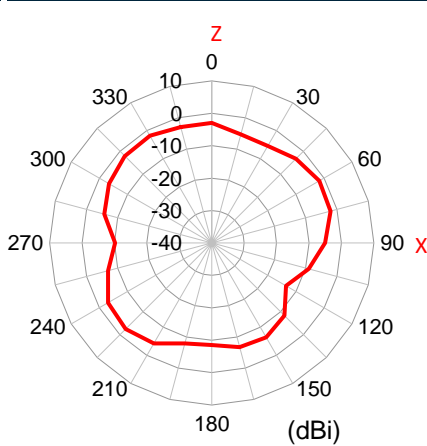

YZ Plane

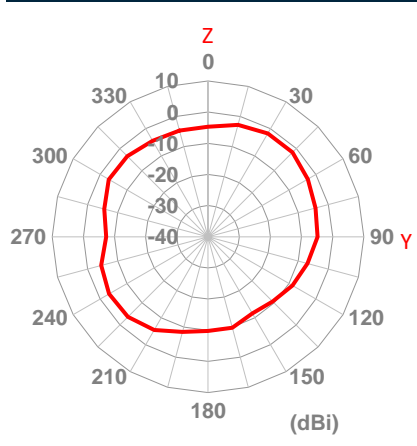

1710MHz

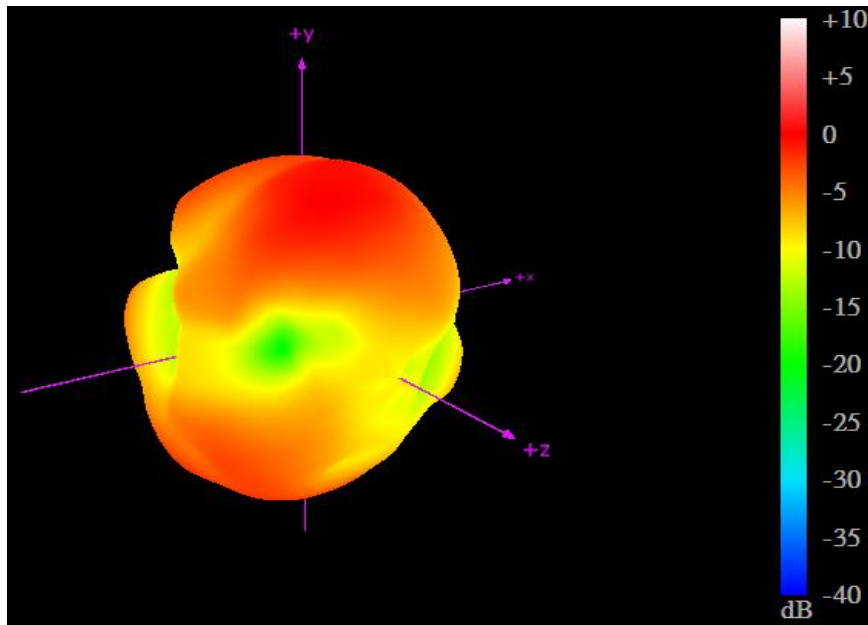

XY Plane

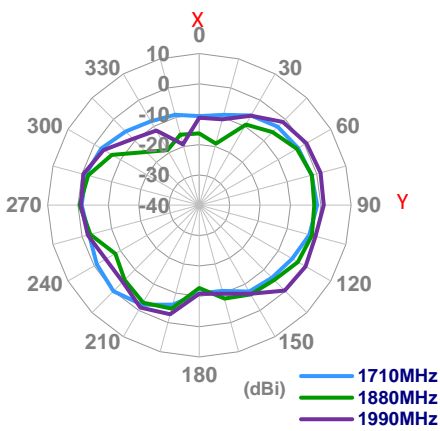

XZ Plane

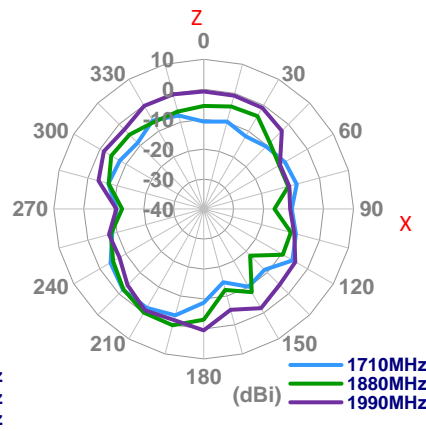

YZ Plane

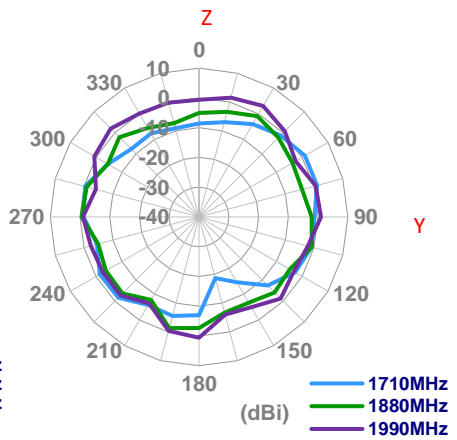

2170MHz

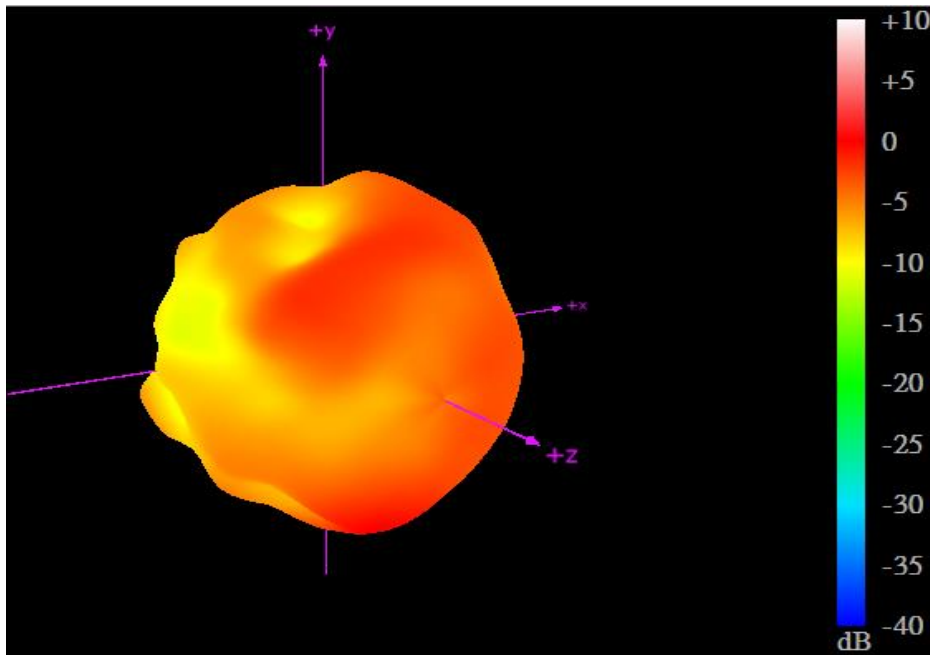

XY Plane

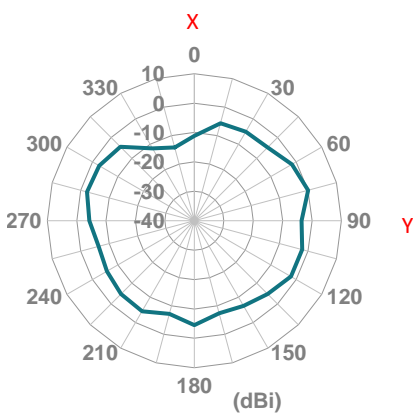

XZ Plane

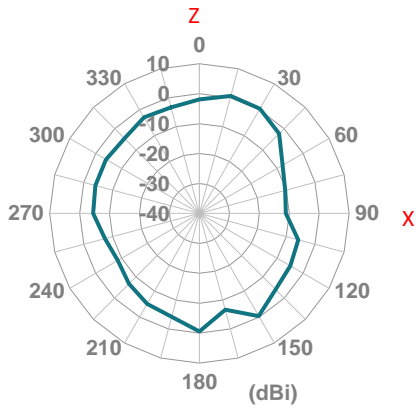

YZ Plane

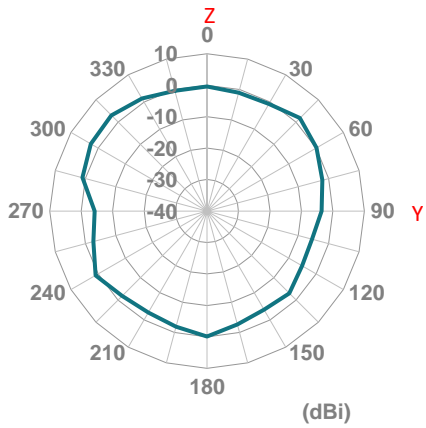

2300MHz

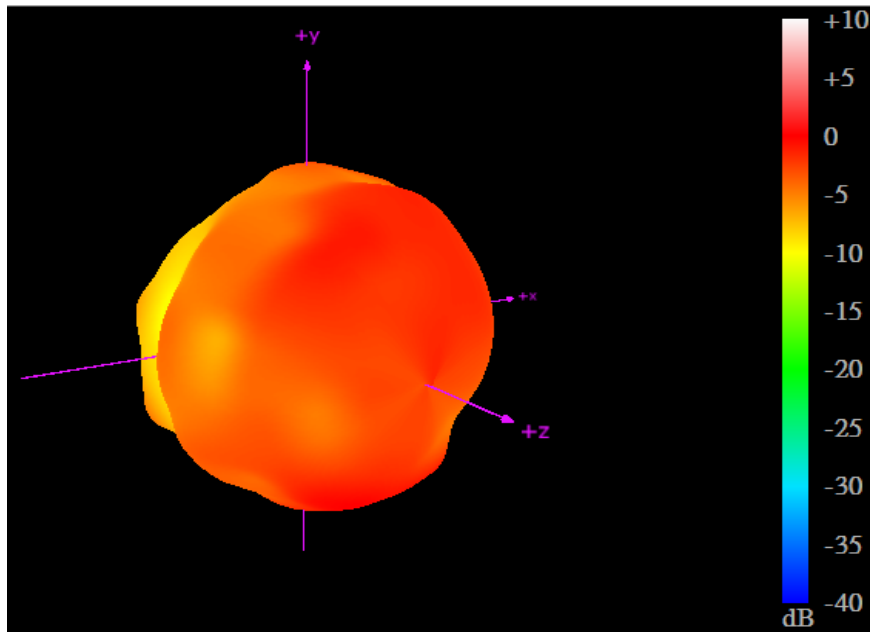

XY Plane

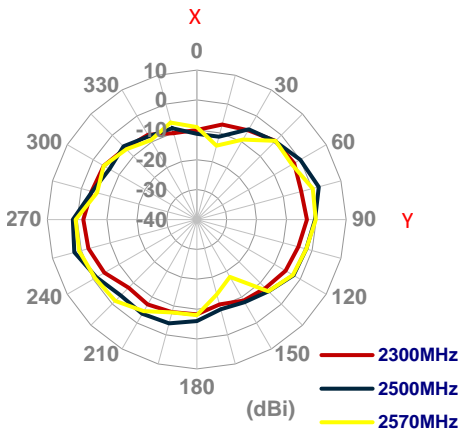

XZ Plane

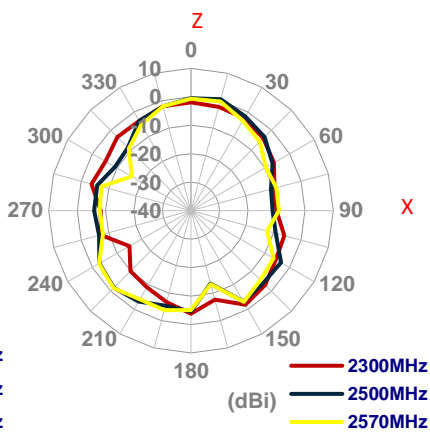

YZ Plane

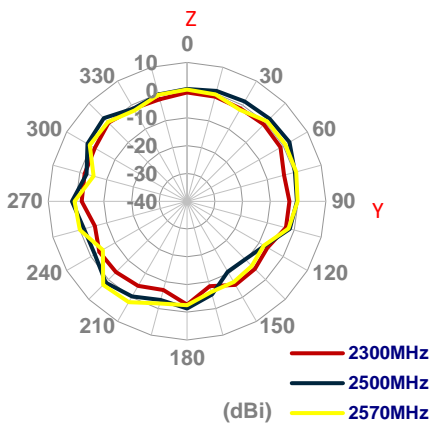

2700MHz

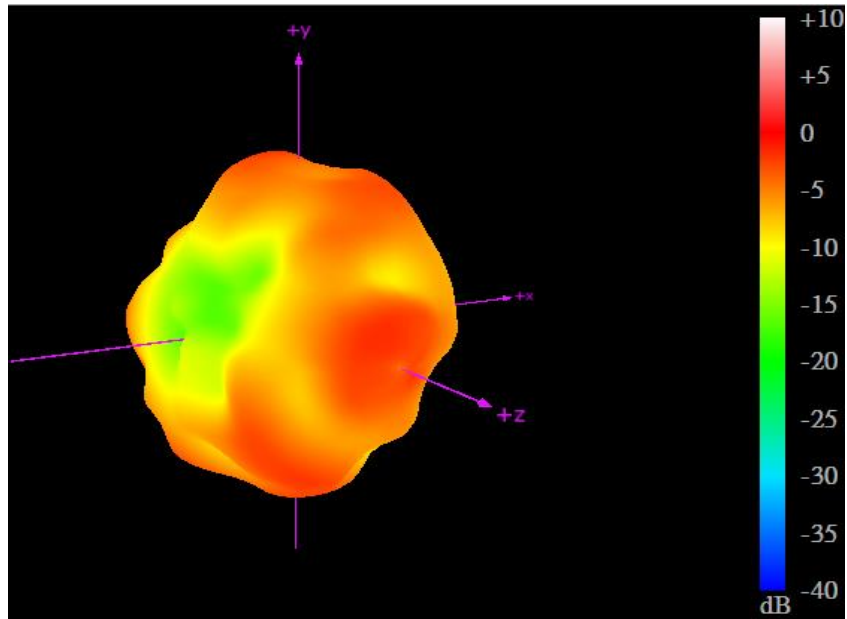

XY Plane

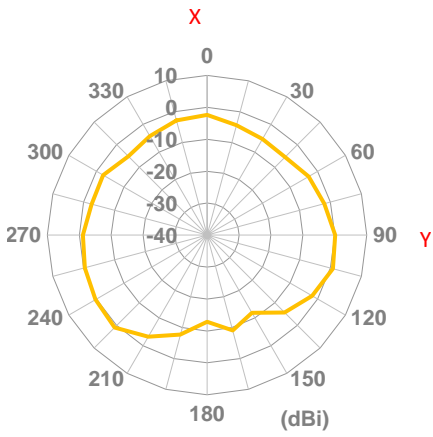

XZ Plane

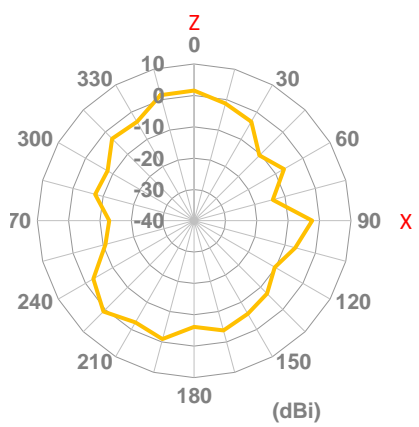

YZ Plane

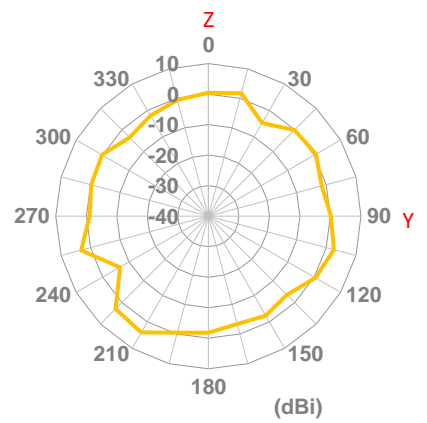

3300MHz

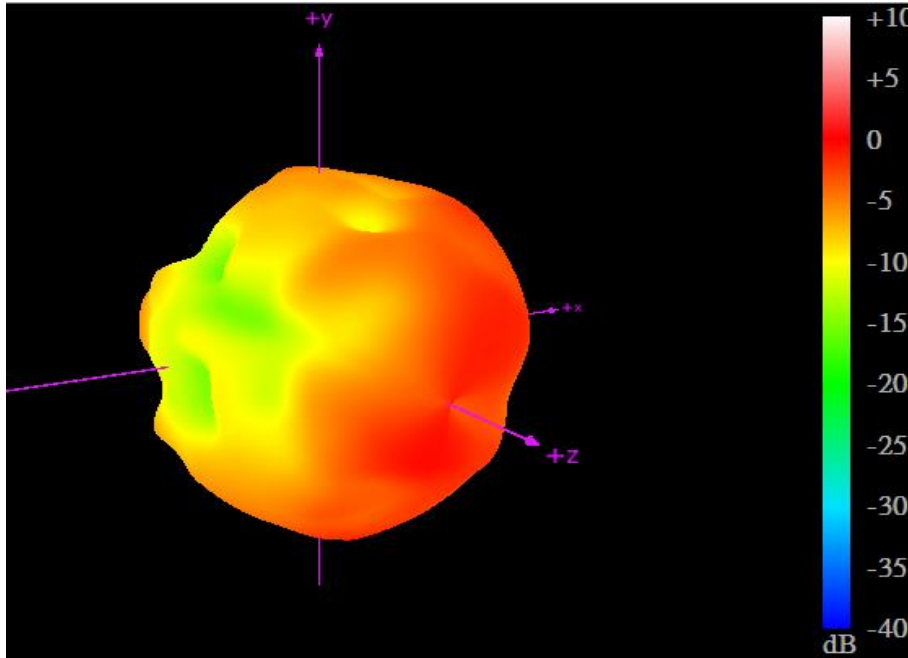

XY Plane

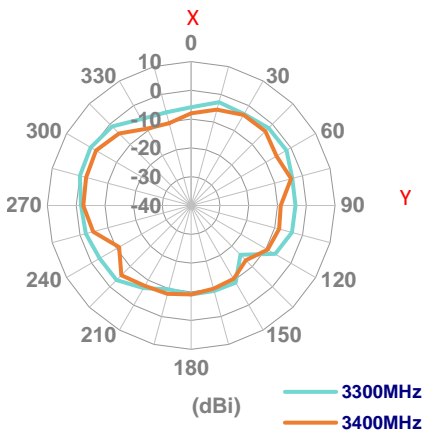

XZ Plane

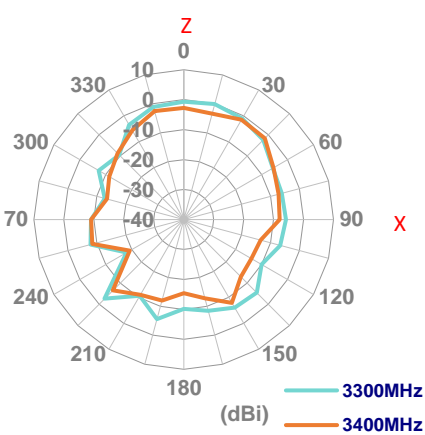

YZ Plane

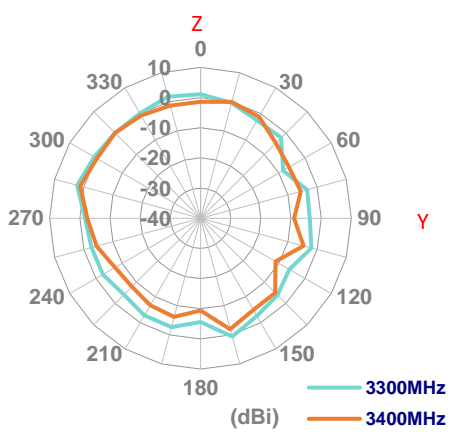

3500MHz

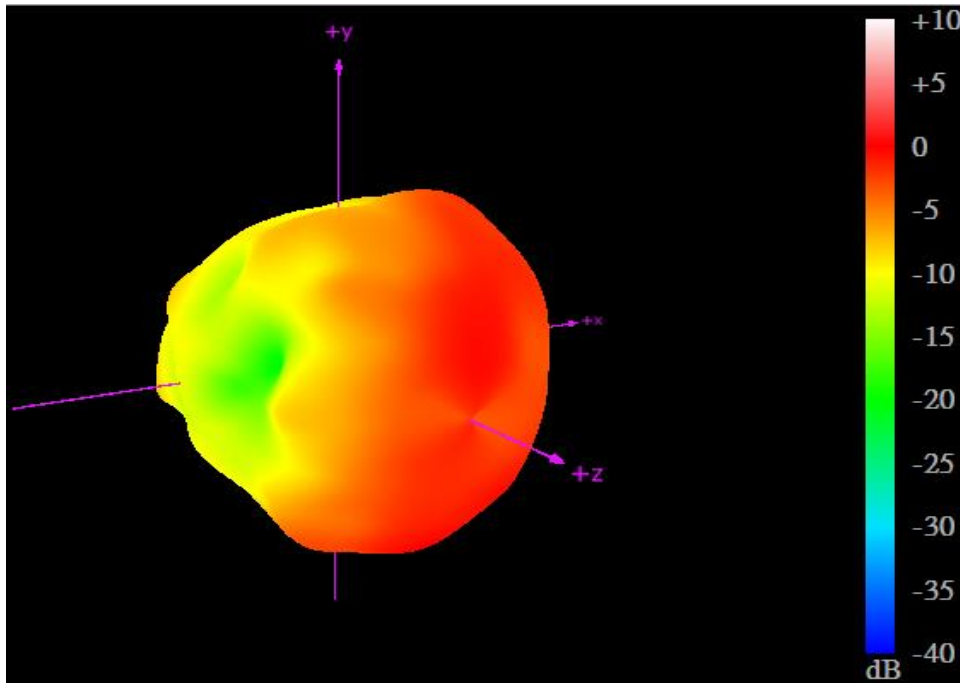

XY Plane

XZ Plane

YZ Plane

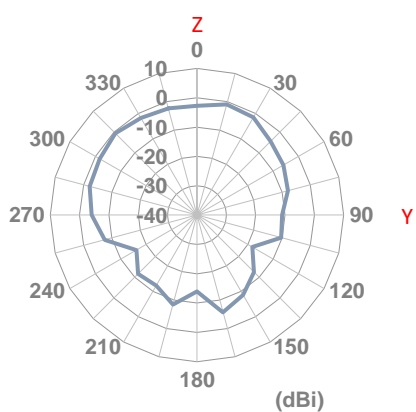
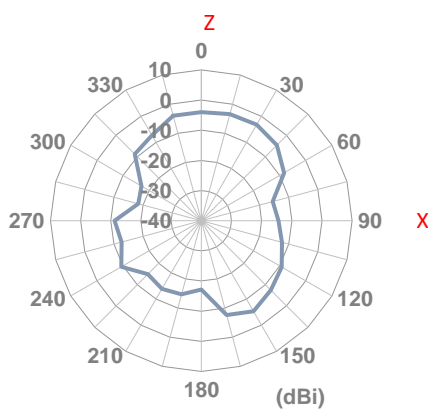
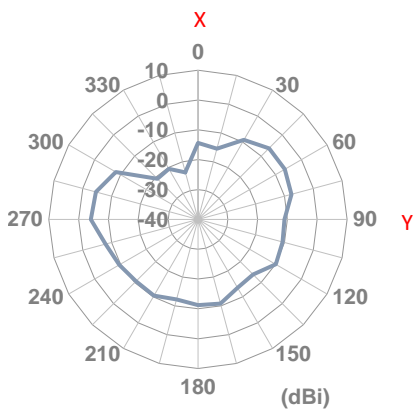

4.4 5G/4G MIMO 2 3D and 2D Radiation Patterns

704MHz

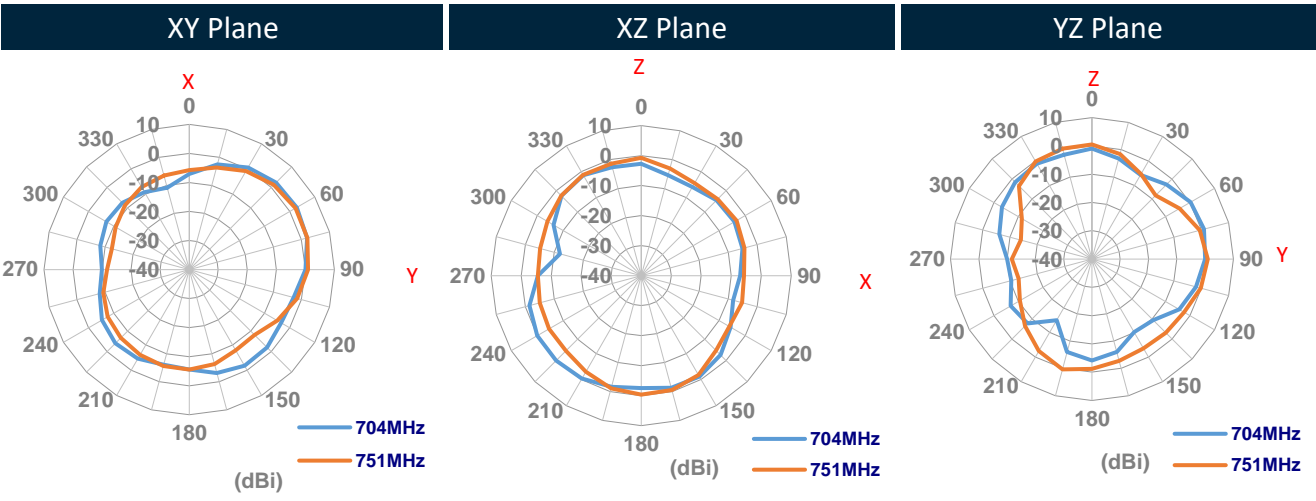
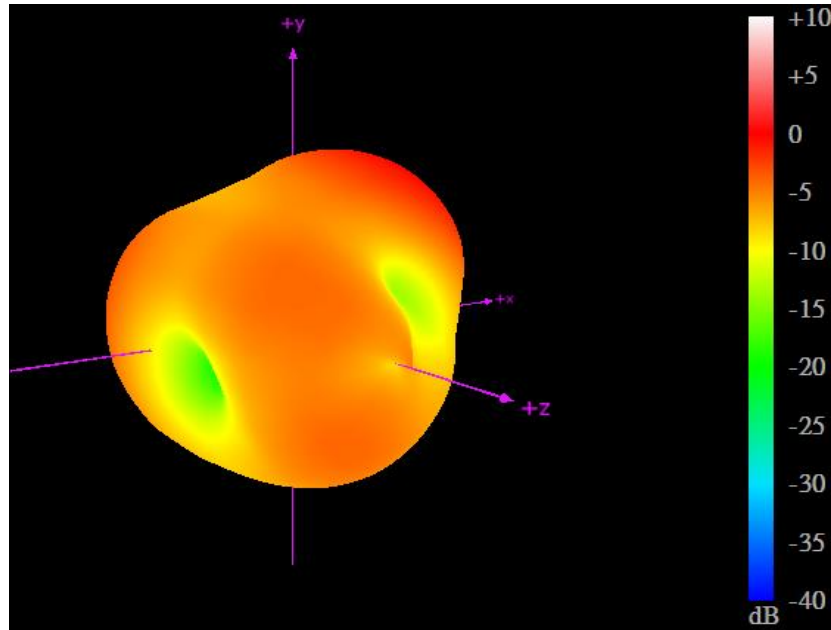

824MHz

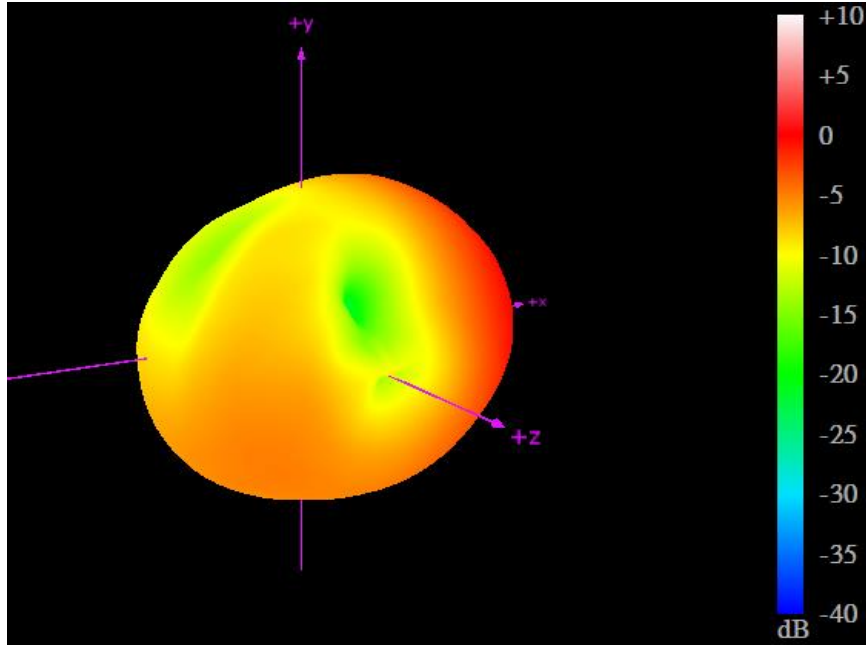

XY Plane

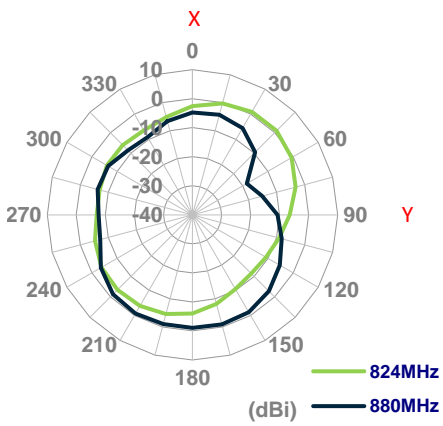

XZ Plane

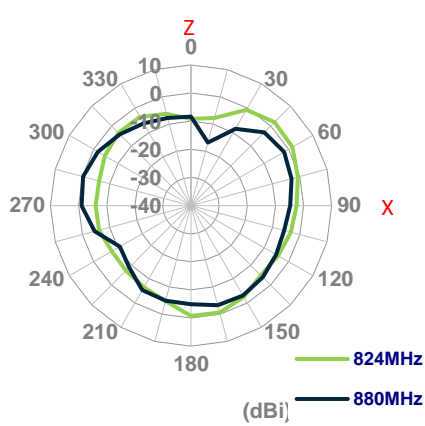

YZ Plane

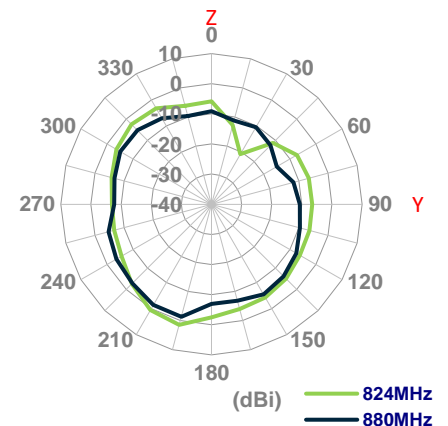

960MHz

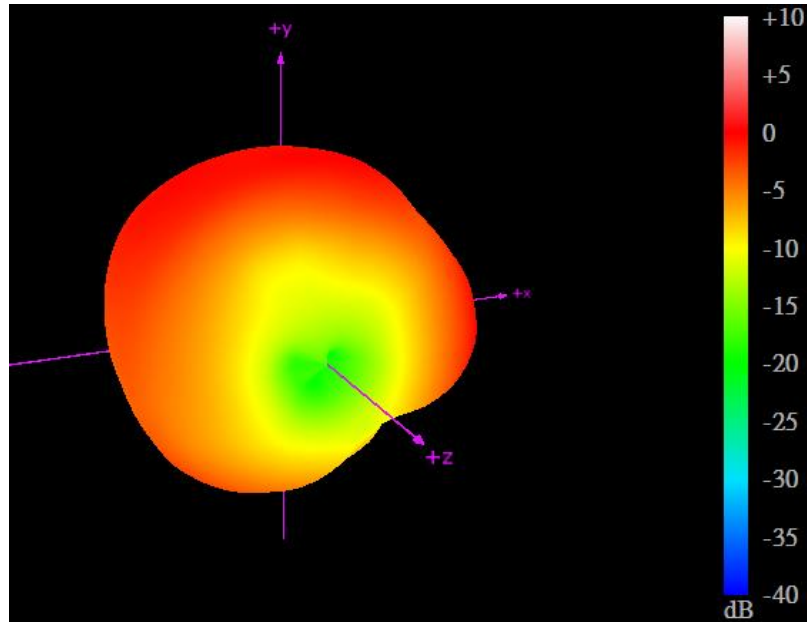

XY Plane

XZ Plane

YZ Plane

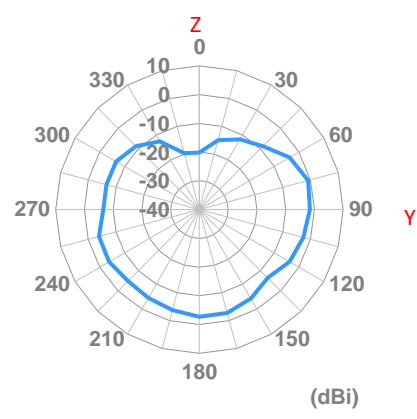
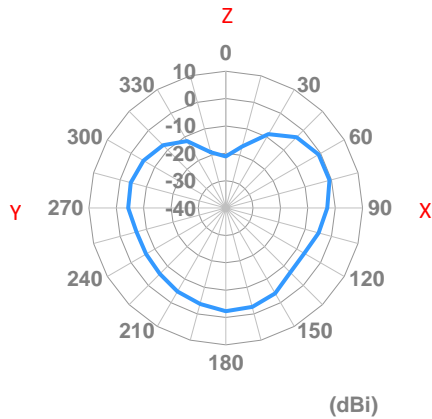
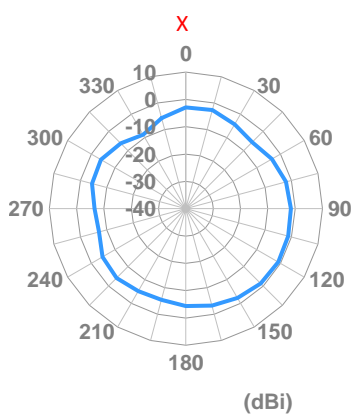

1710MHz

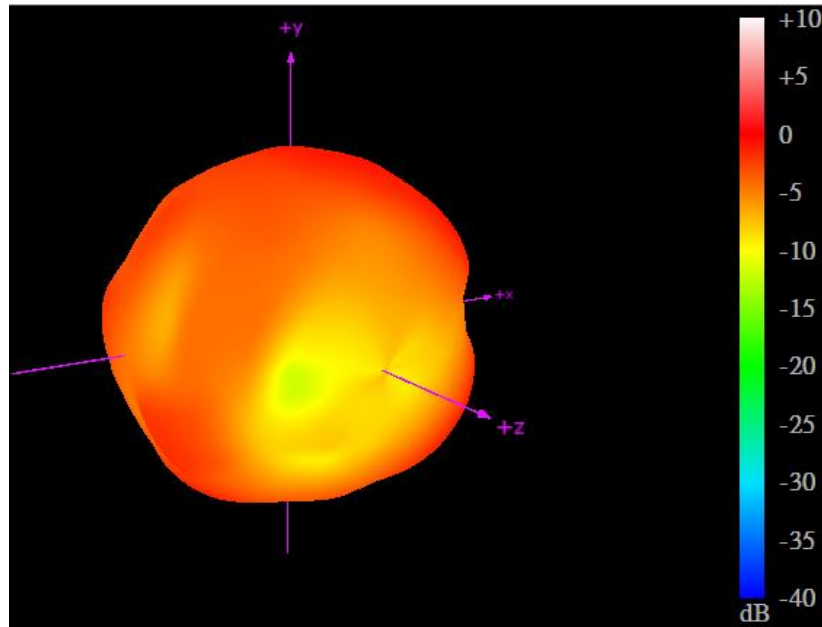

XY Plane

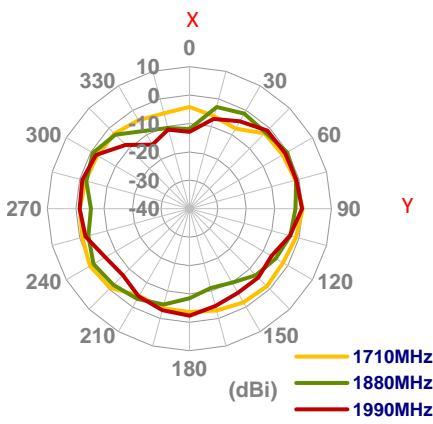

XZ Plane

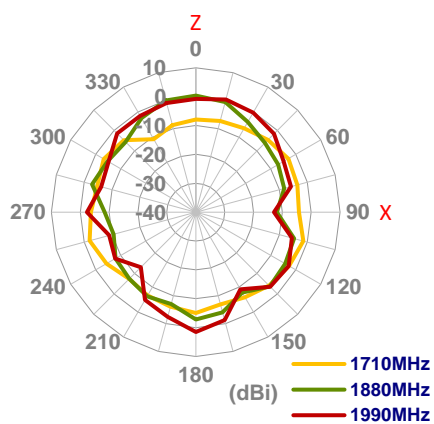

YZ Plane

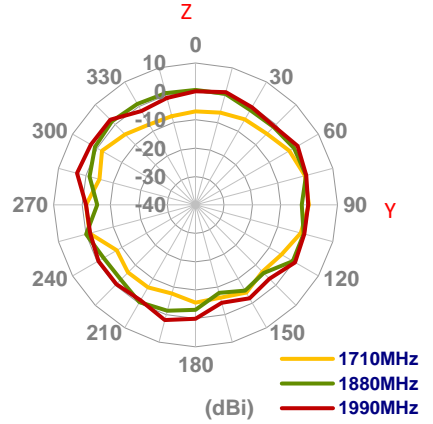

2170MHz

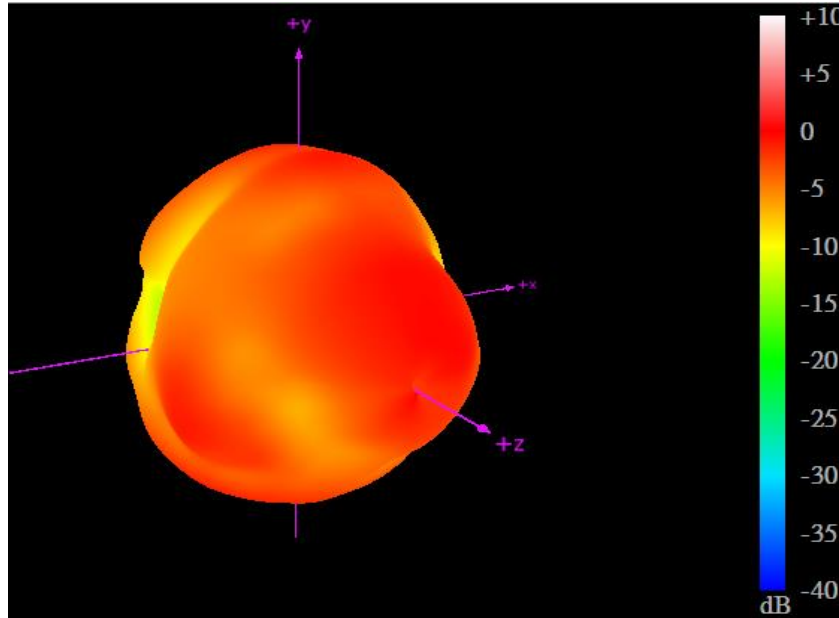

XY Plane

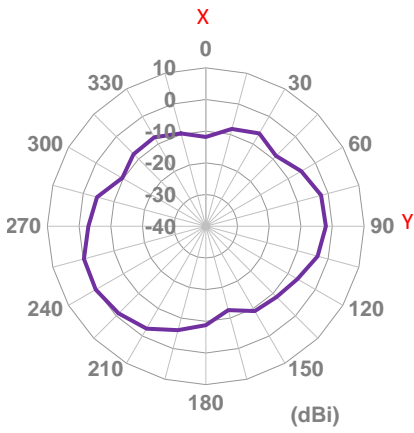

XZ Plane

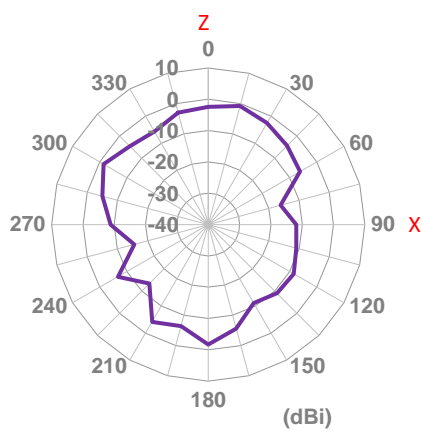

YZ Plane

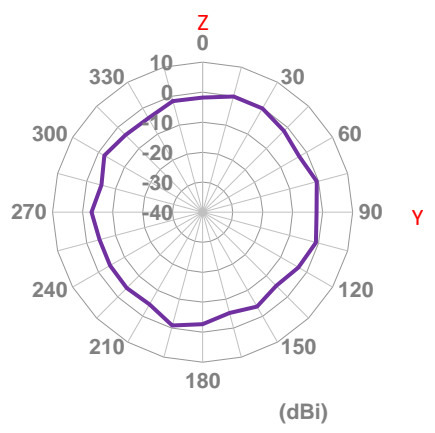

2300MHz

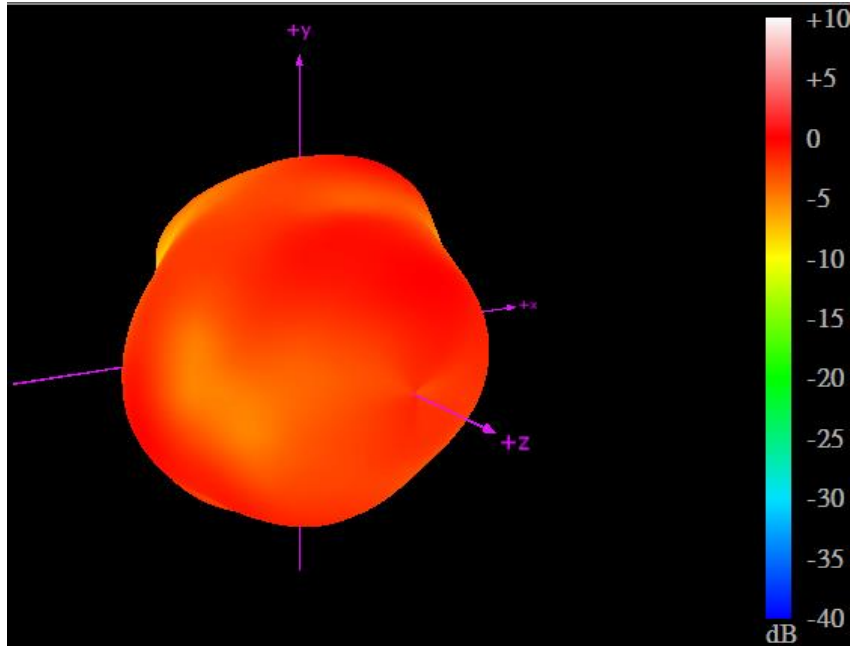

XY Plane

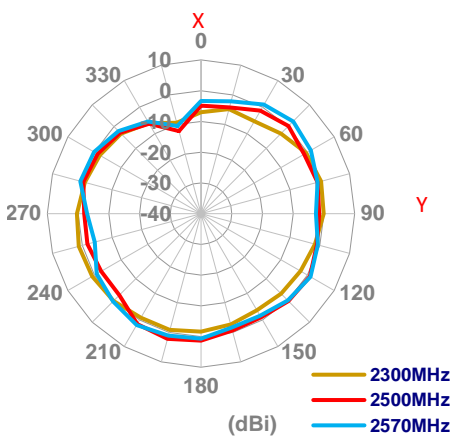

XZ Plane

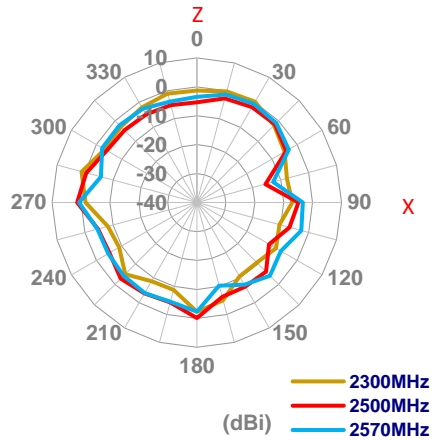

YZ Plane

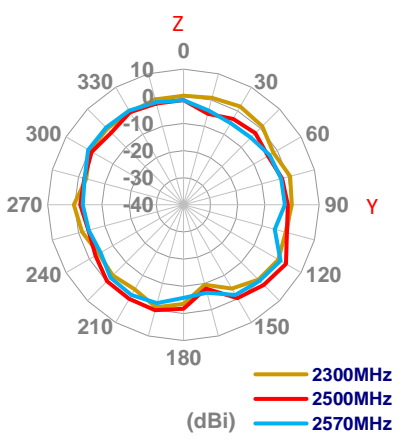

2700MHz

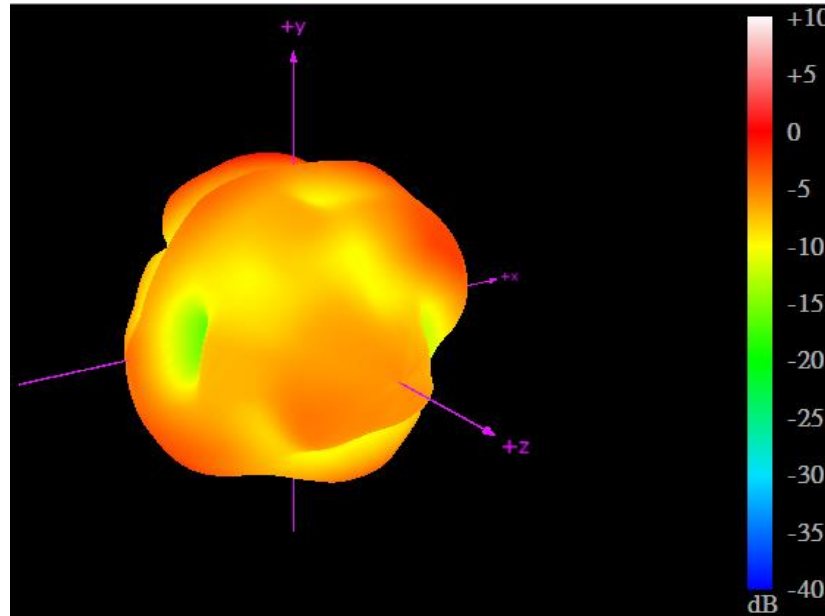

XY Plane

XZ Plane

YZ Plane

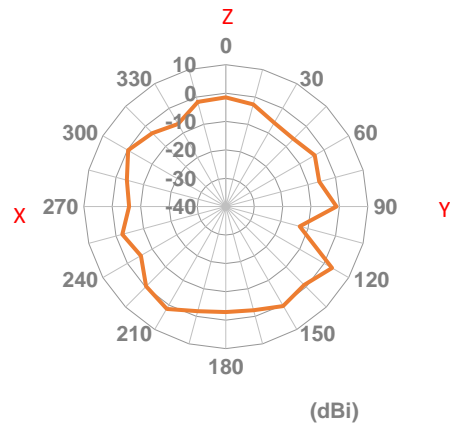
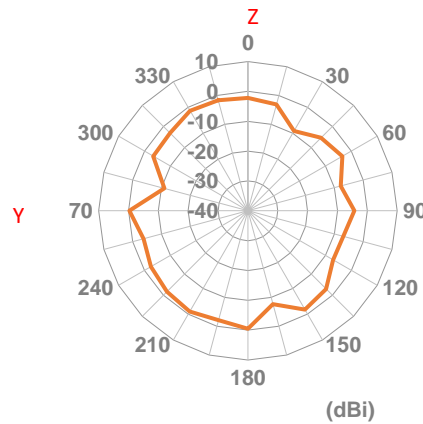
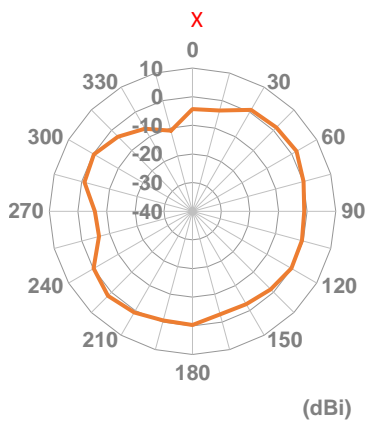

3300MHz

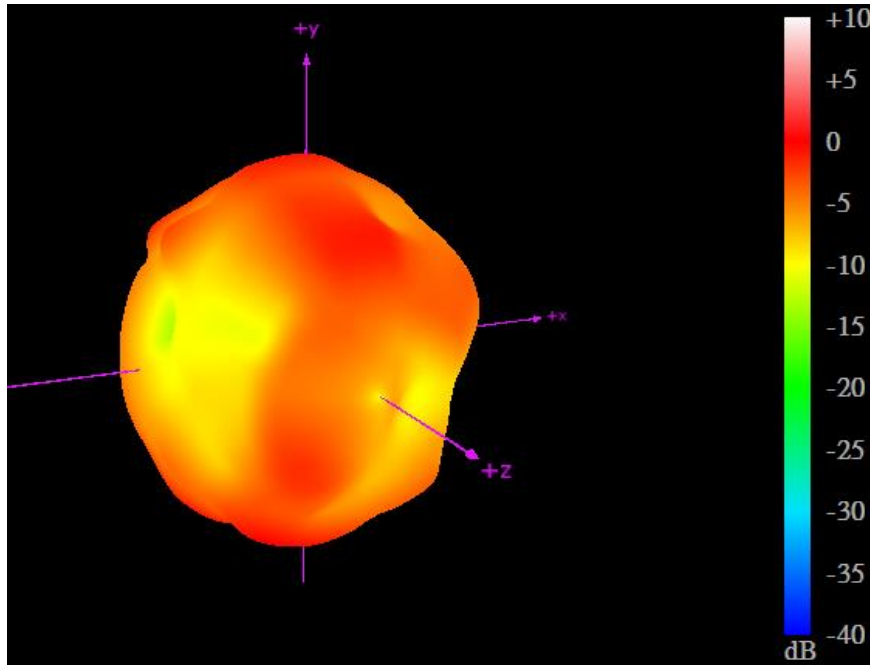

XY Plane

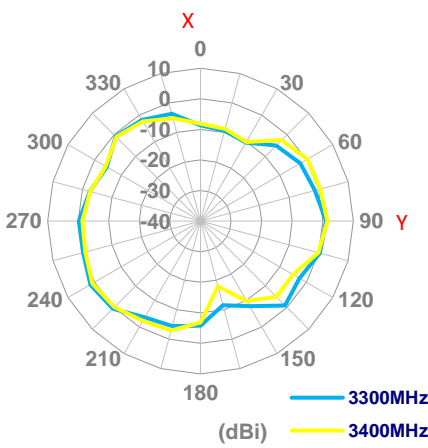

XZ Plane

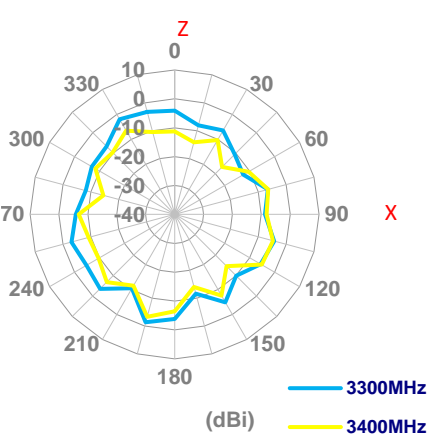

YZ Plane

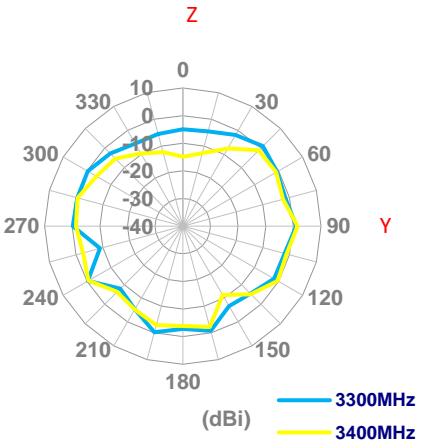

3500MHz

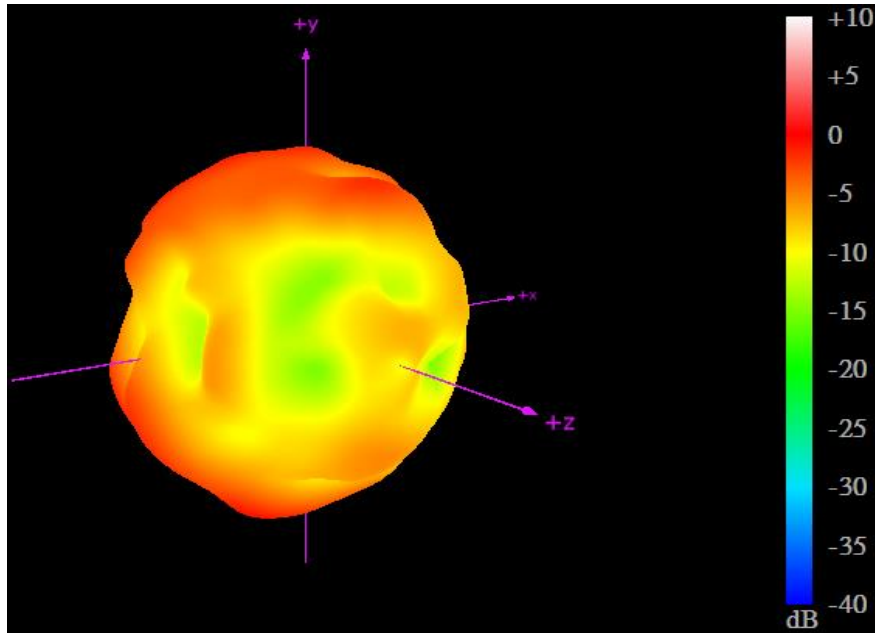

XY Plane

XZ Plane

YZ Plane

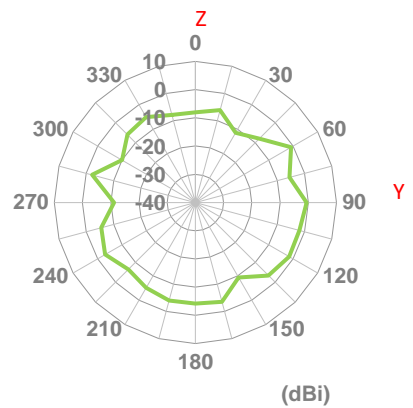
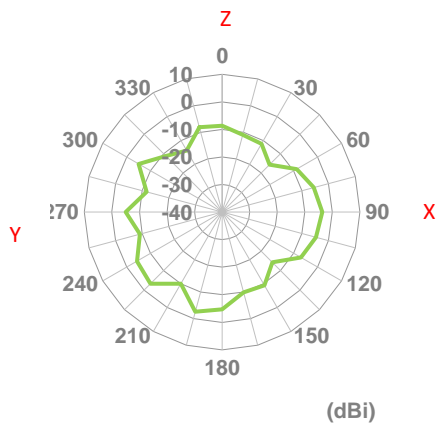
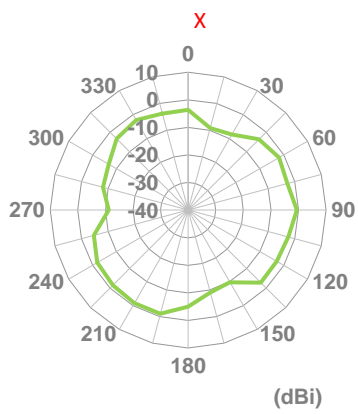

4.5 Wi-Fi 3D and 2D Radiation Patterns

2400MHz

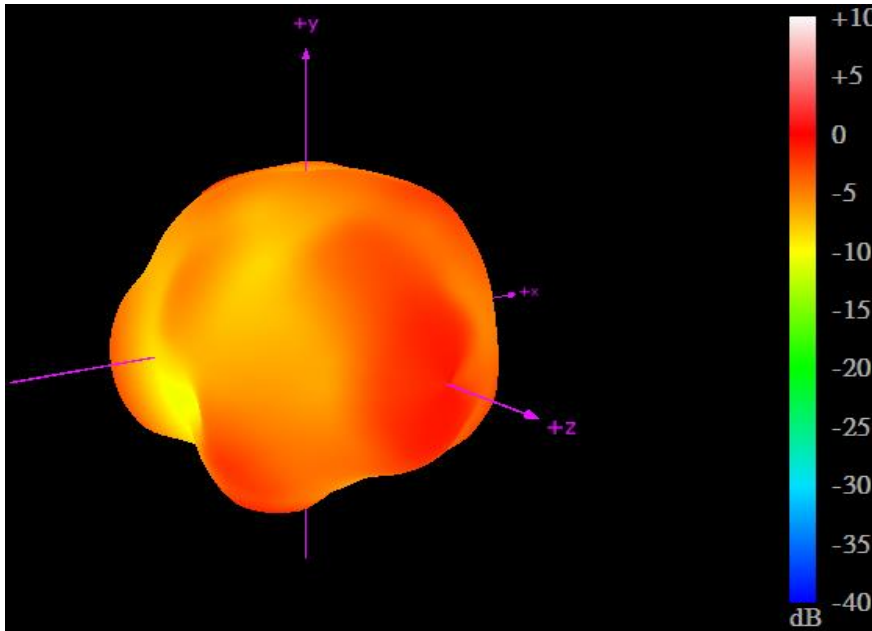

XY Plane XZ Plane YZ Plane

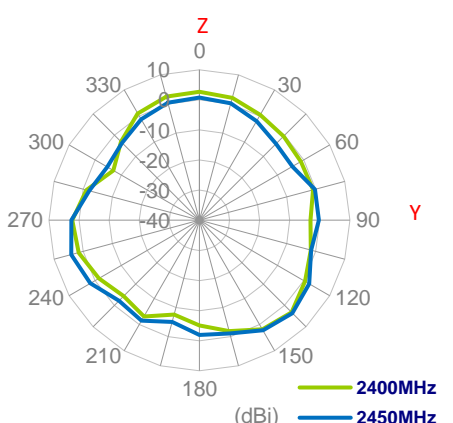
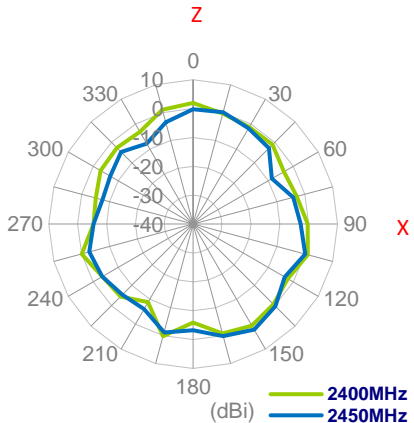
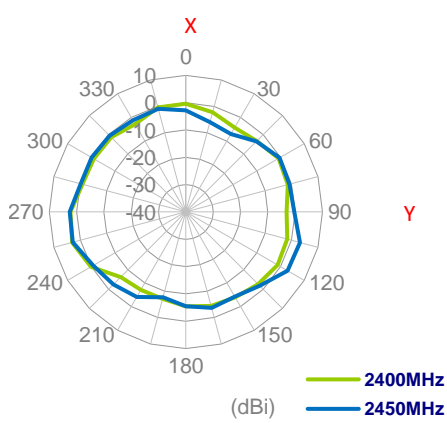

2500MHz

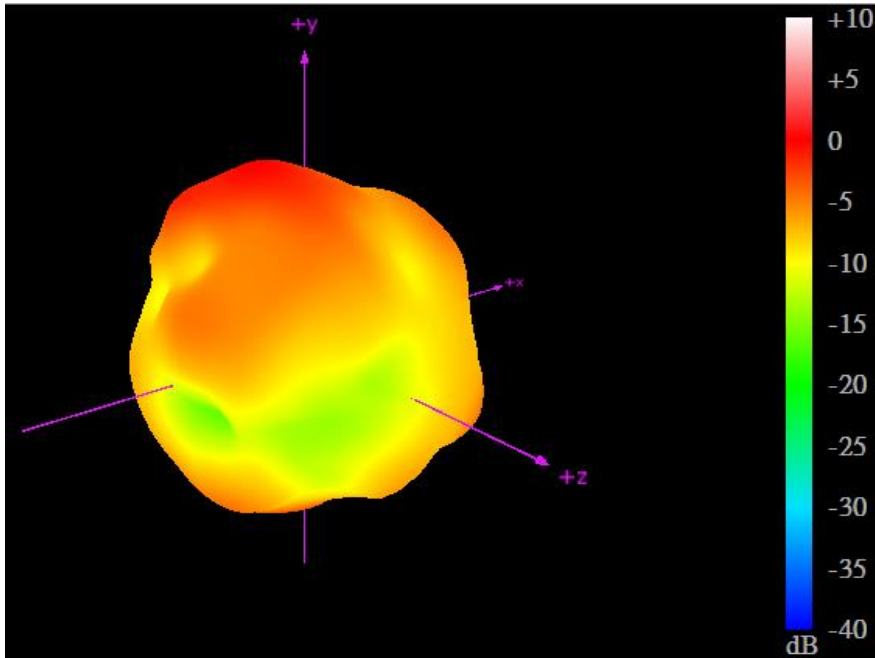

XY Plane

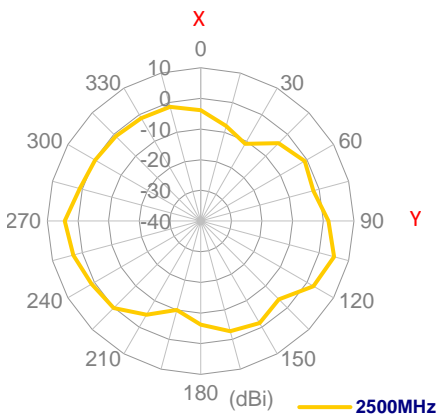

XZ Plane

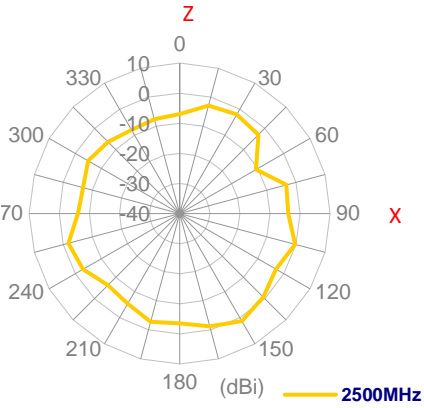

YZ Plane

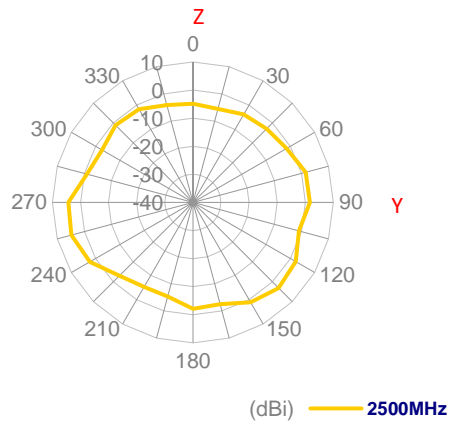

4900MHz

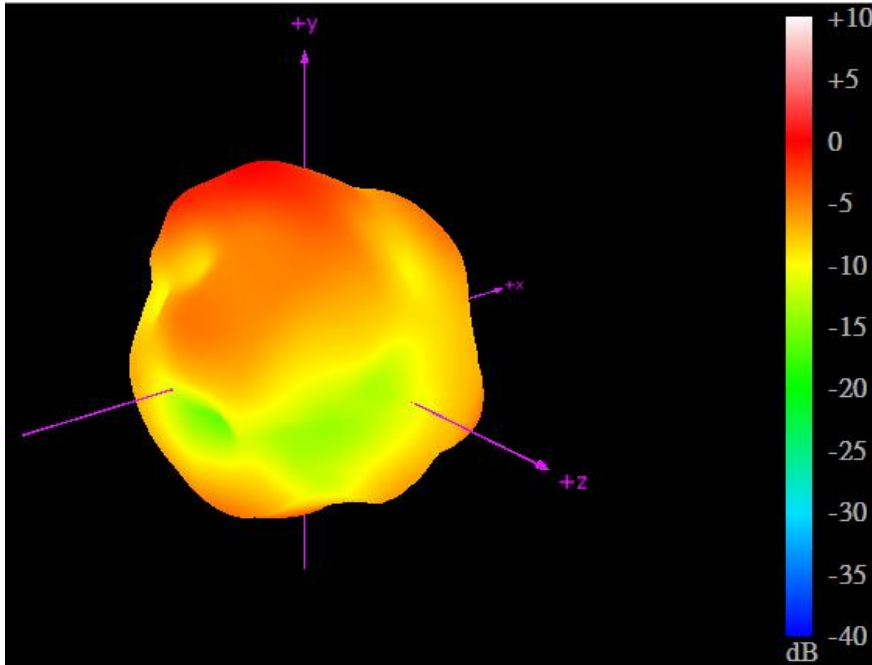

XY Plane

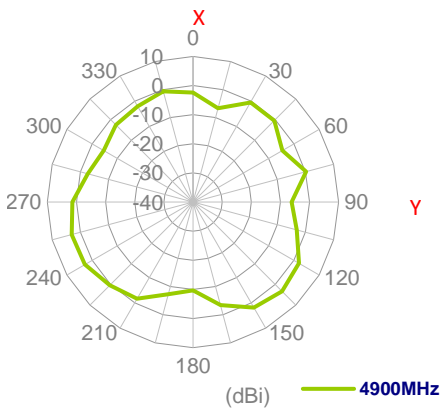

XZ Plane

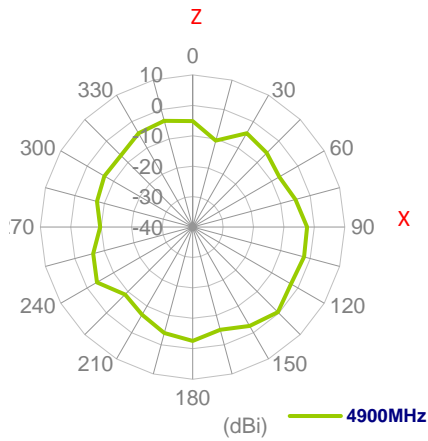

YZ Plane

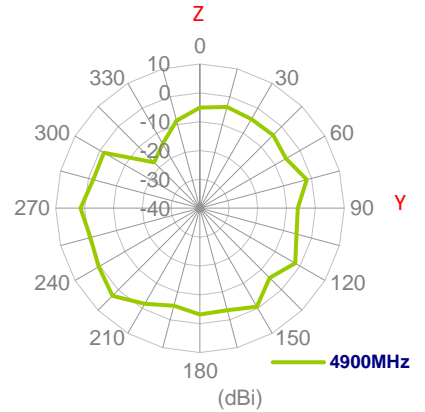

5150MHz

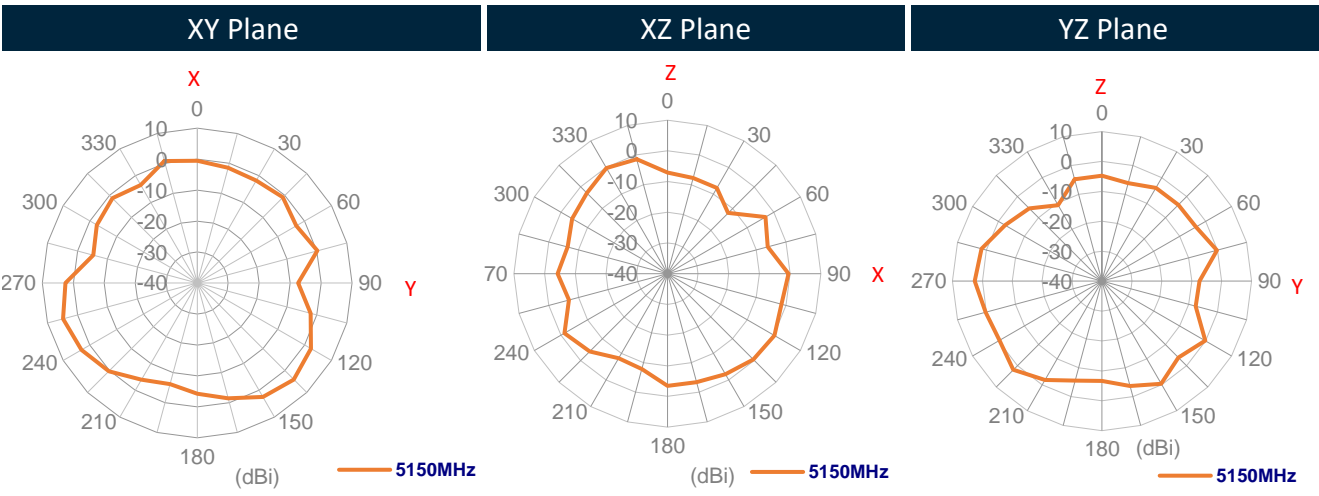
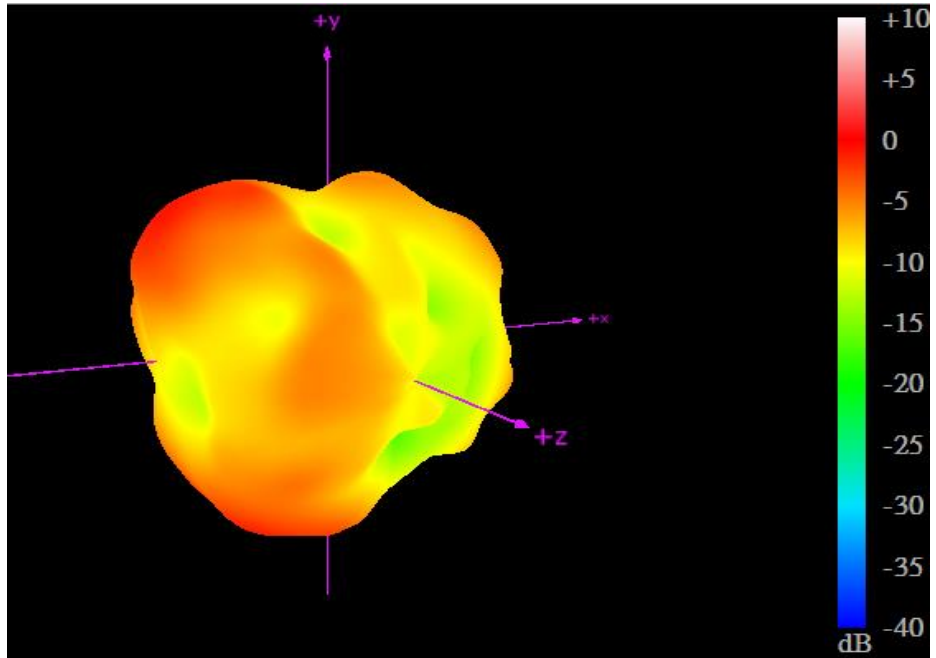

5550MHz

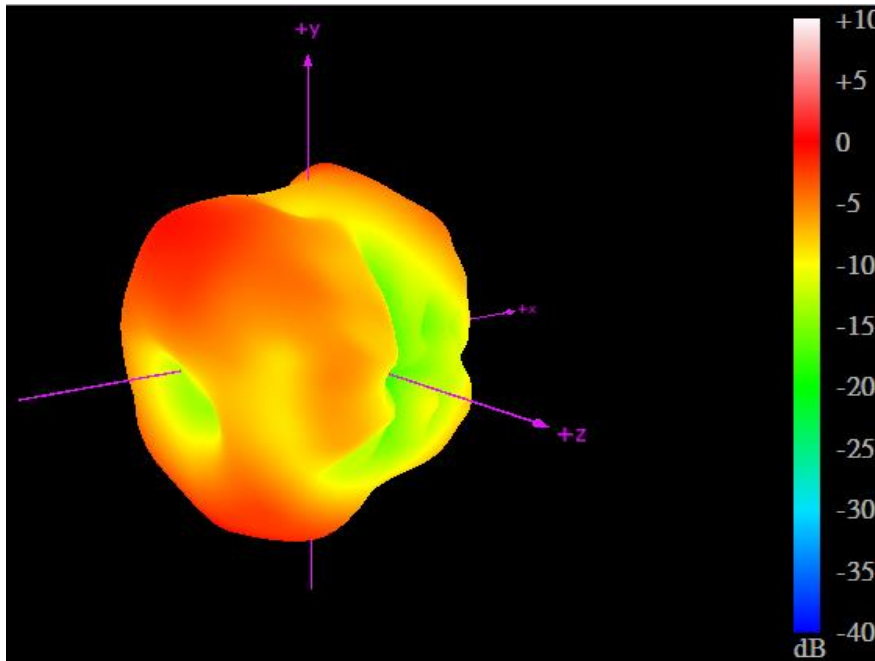

XY Plane

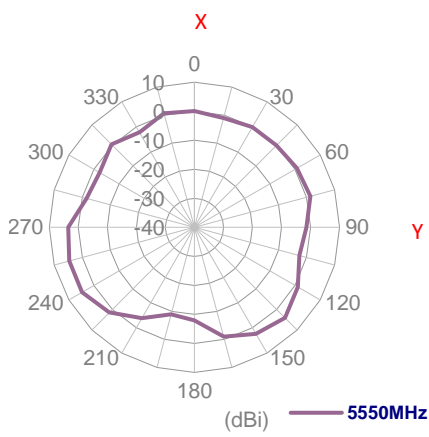

XZ Plane

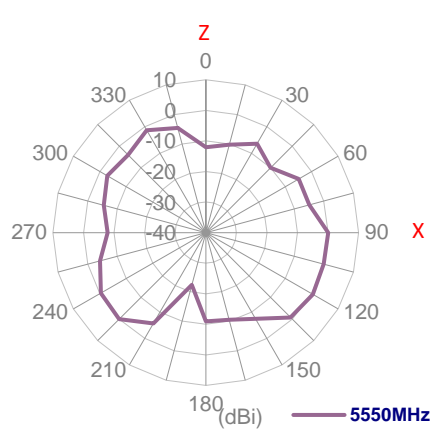

YZ Plane

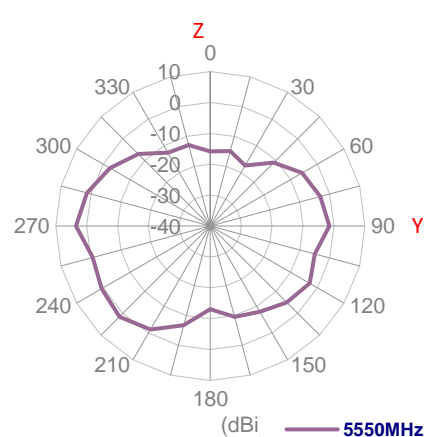

5850MHz

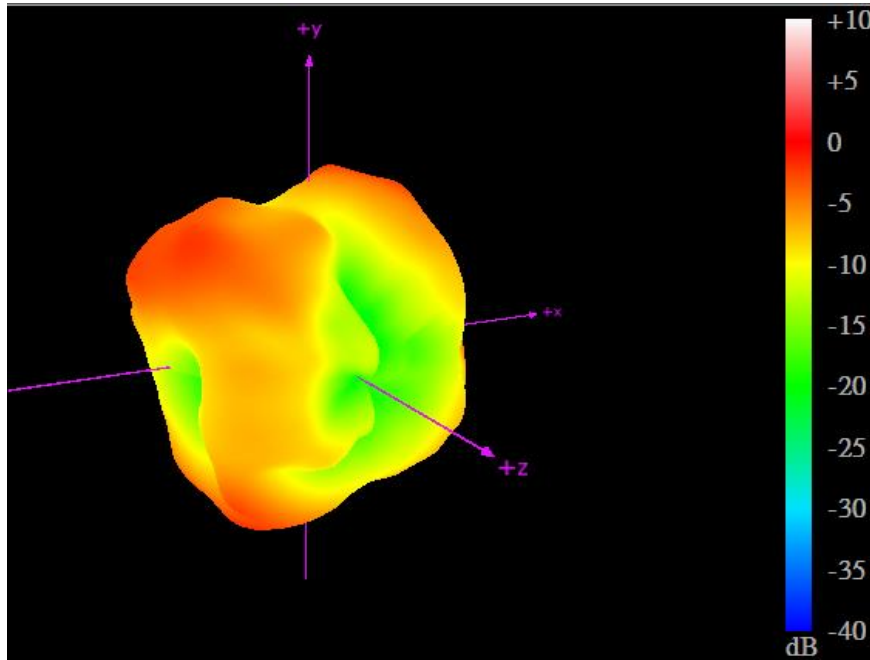

XY Plane

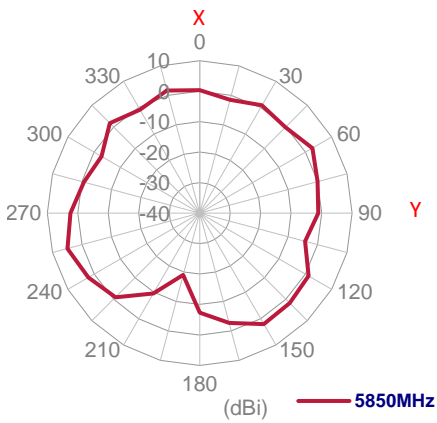

XZ Plane

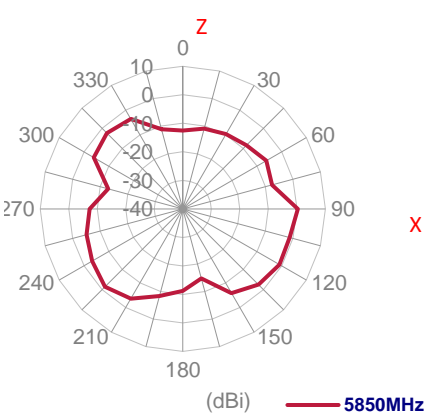

YZ Plane

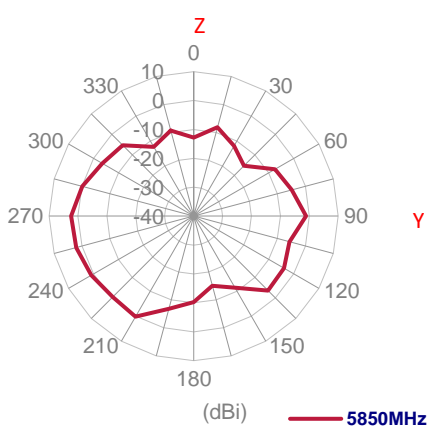

5. Mechanical Drawing (Units: mm)

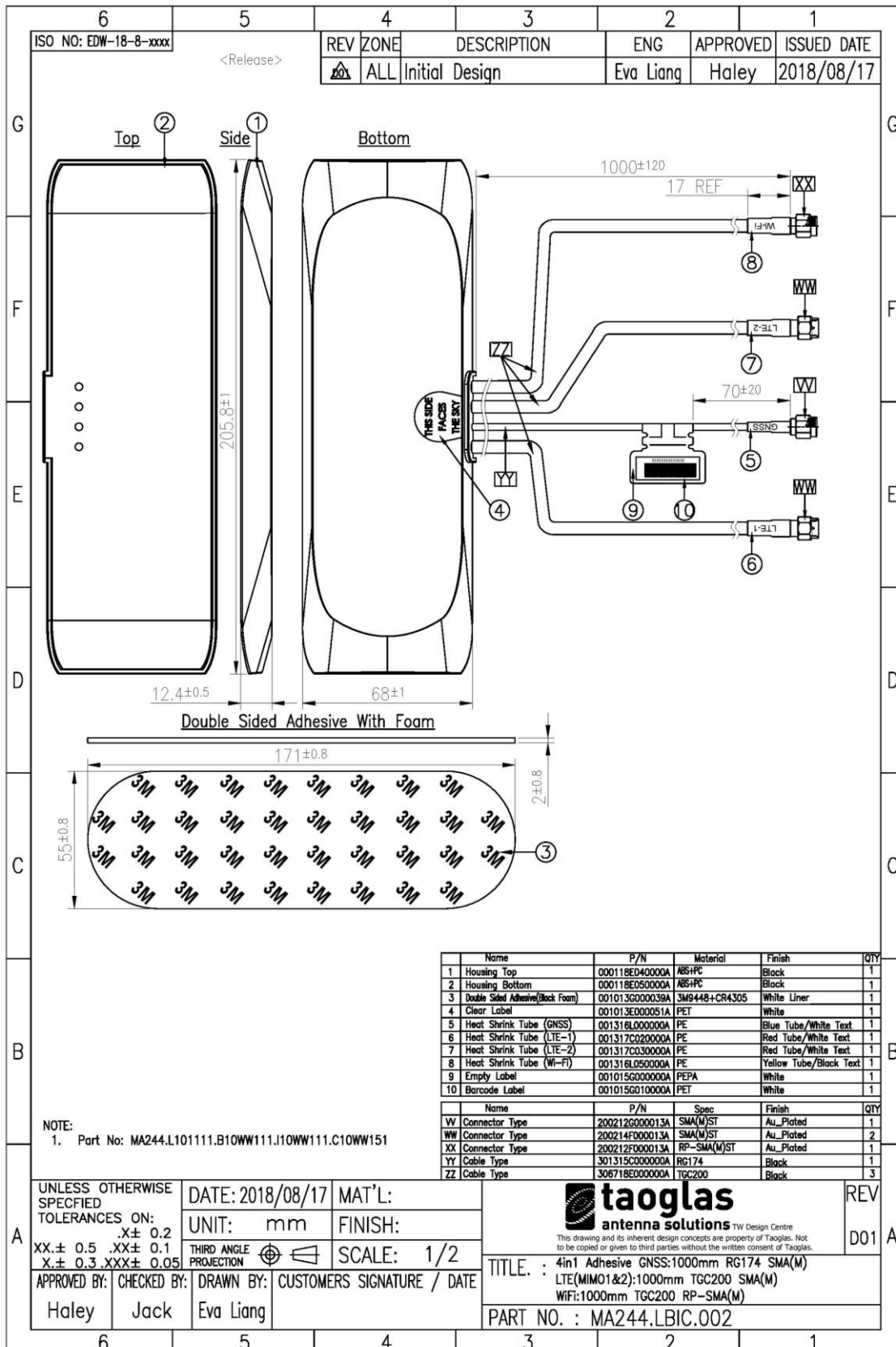

6. Packaging

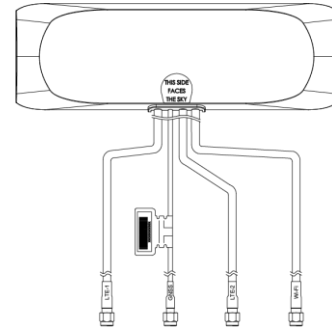

1pc MA244.LBIC.002 per Large PE Bag
 Dimensions: 450*280mm
 Weight: 250g

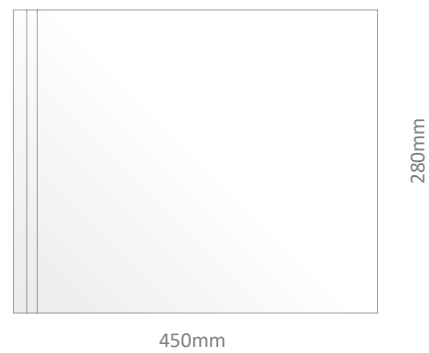

10pcs MA244.LBIC.002 per Carton
 Carton Dimensions: 390*260*330mm
 Weight: 2.8Kg

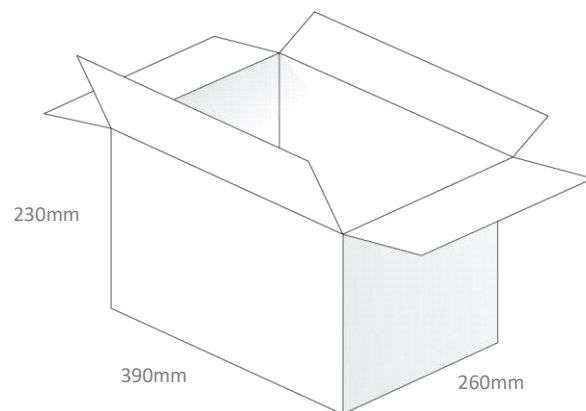

Pallet Dimensions:
 1200*1000*1190mm
 27 Cartons per Pallet
 9 Cartons per layer, 3 Layers

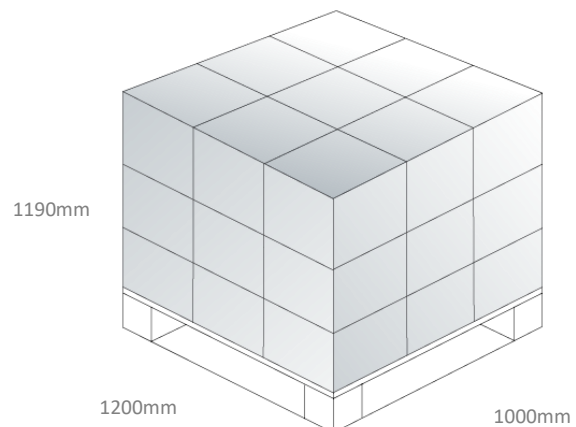

7. Application Note

The MA244.LBIC.002 antenna performance measured with different cable lengths

7.1 Return Loss – GNSS

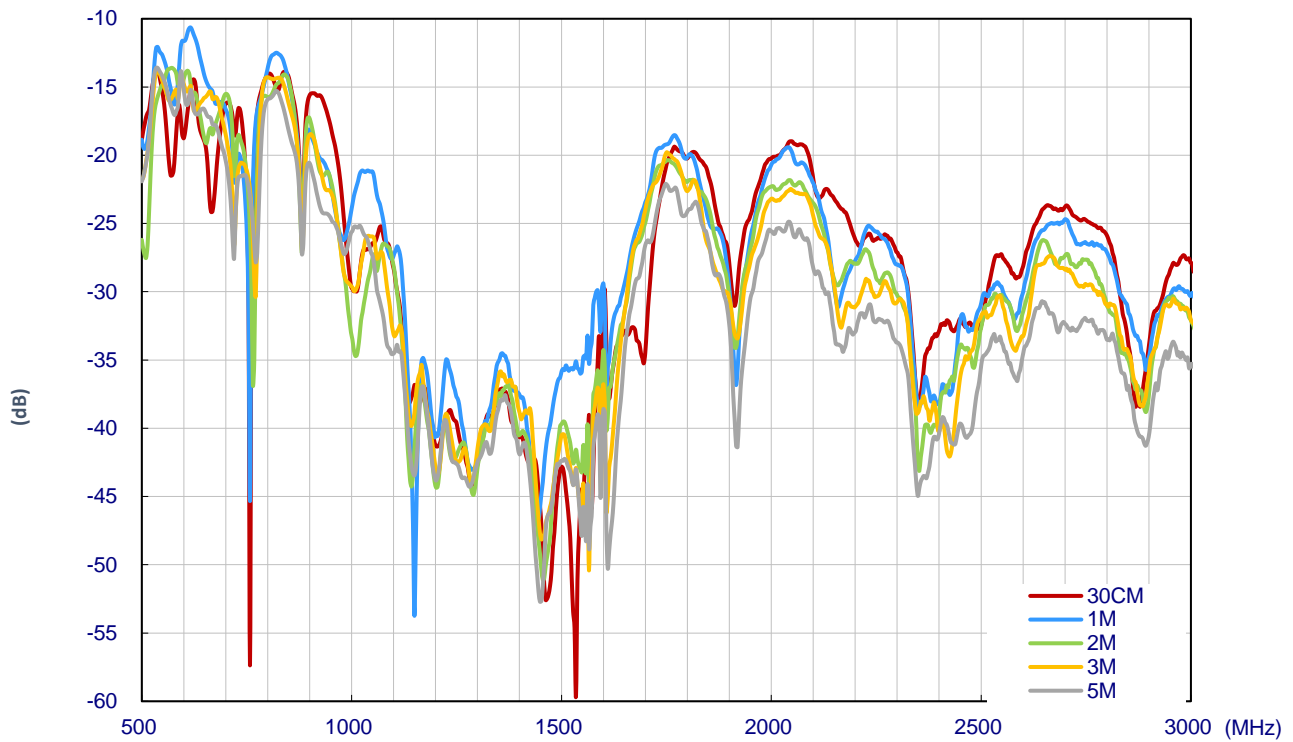

7.2 Return Loss – 5G/4G

5G/4G MIMO 1

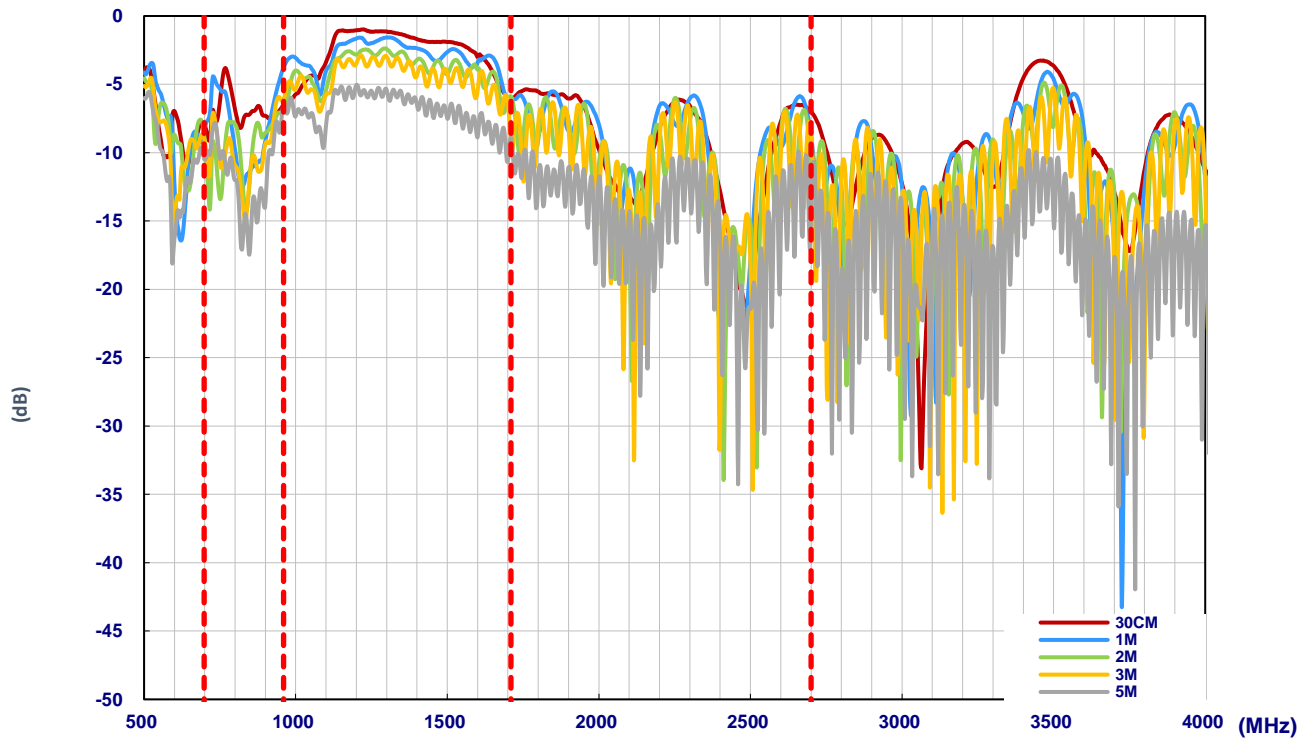

5G/4G MIMO 2

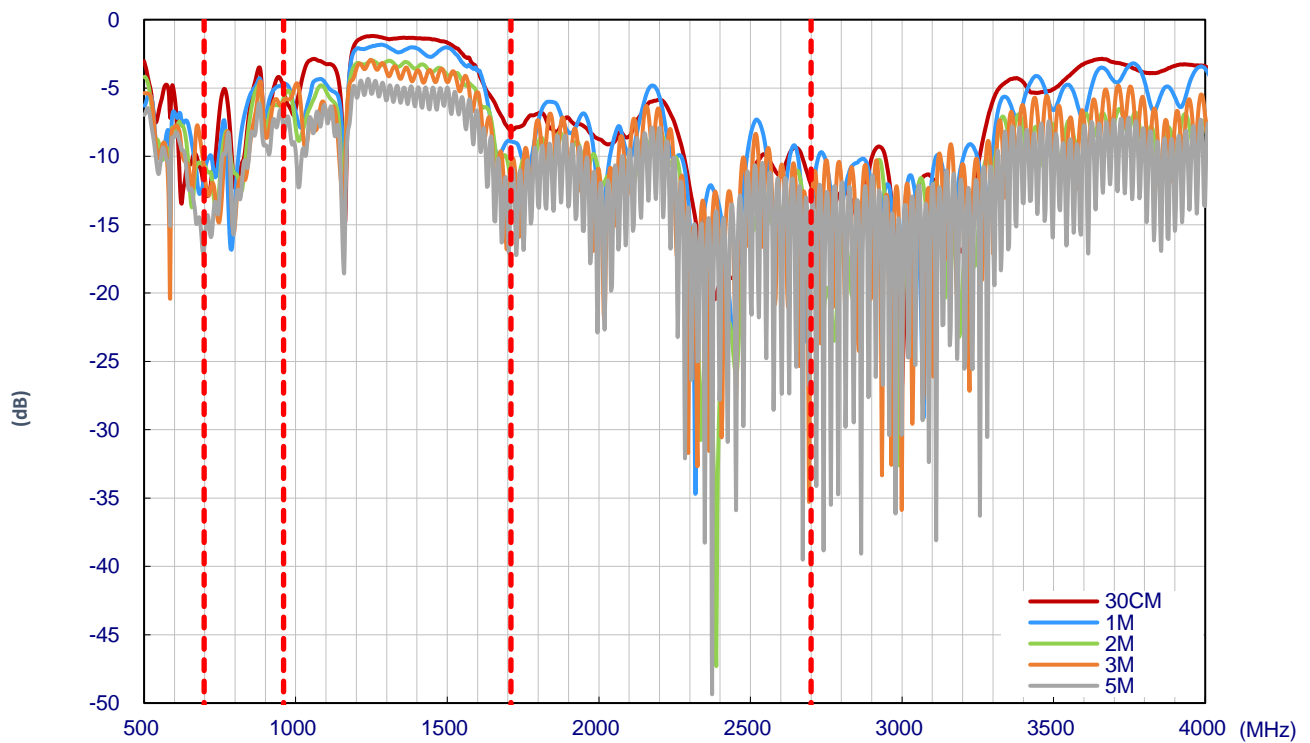

7.3 Efficiency In Free Space – 5G/4G

5G/4G MIMO 1

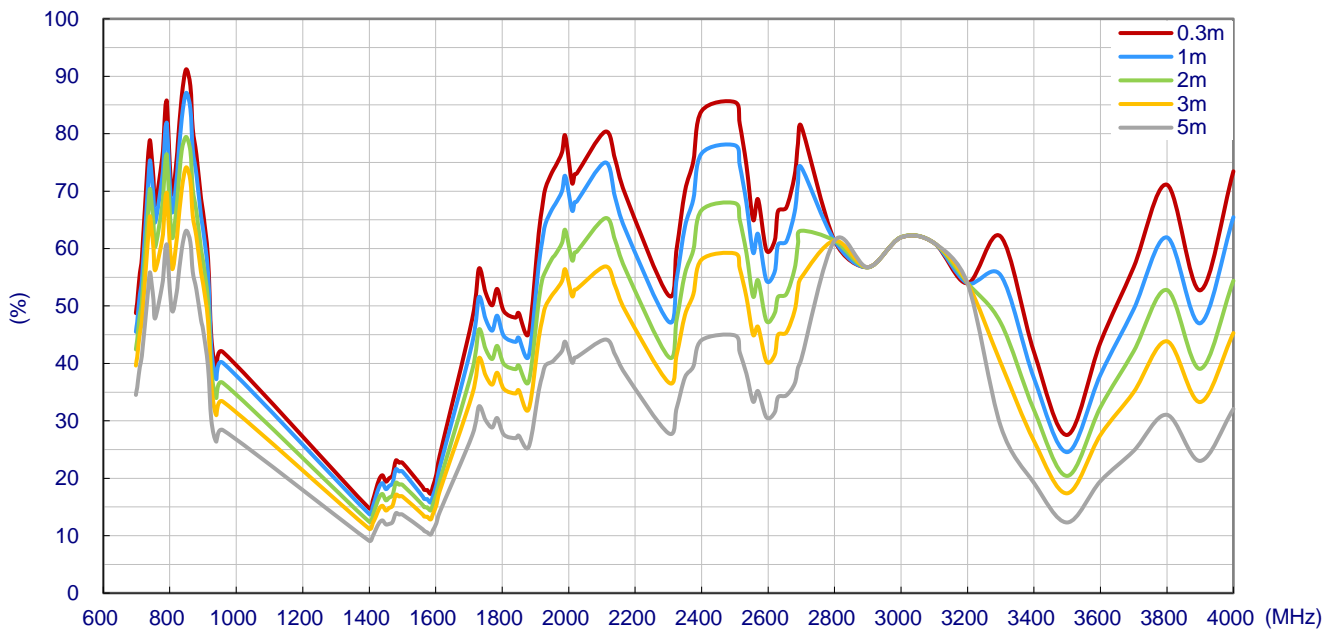

5G/4G MIMO 2

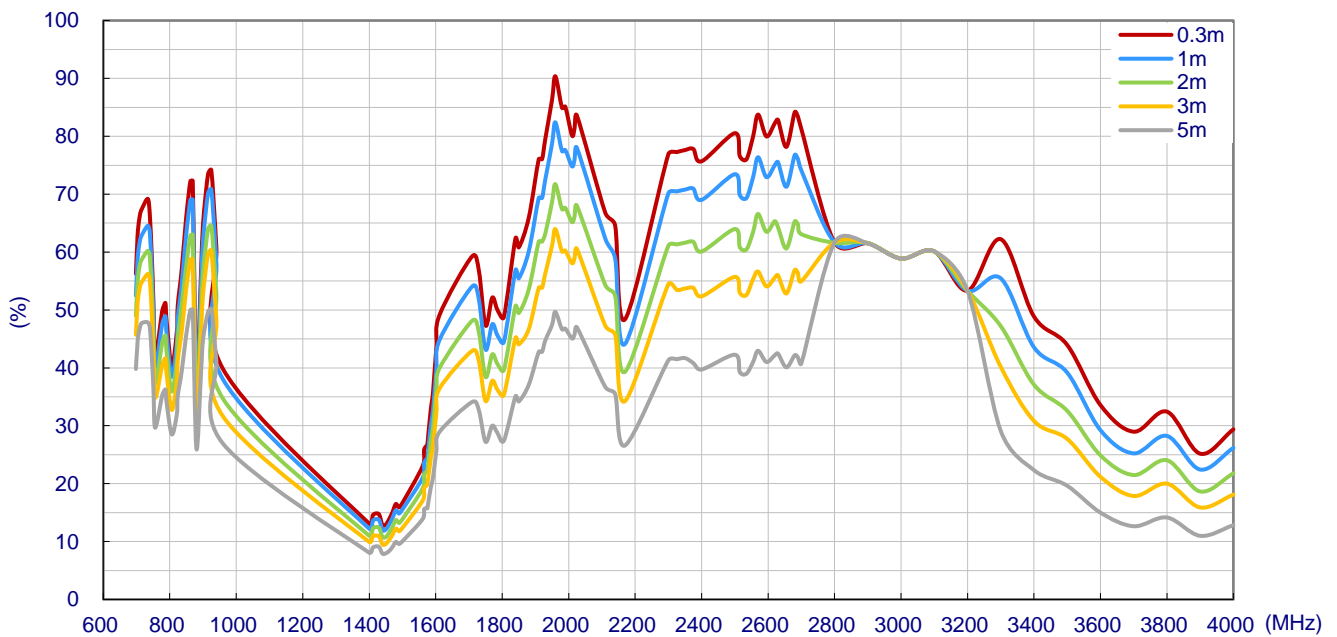

7.4 Average Gain In Free Space – 5G/4G

5G/4G MIMO 1

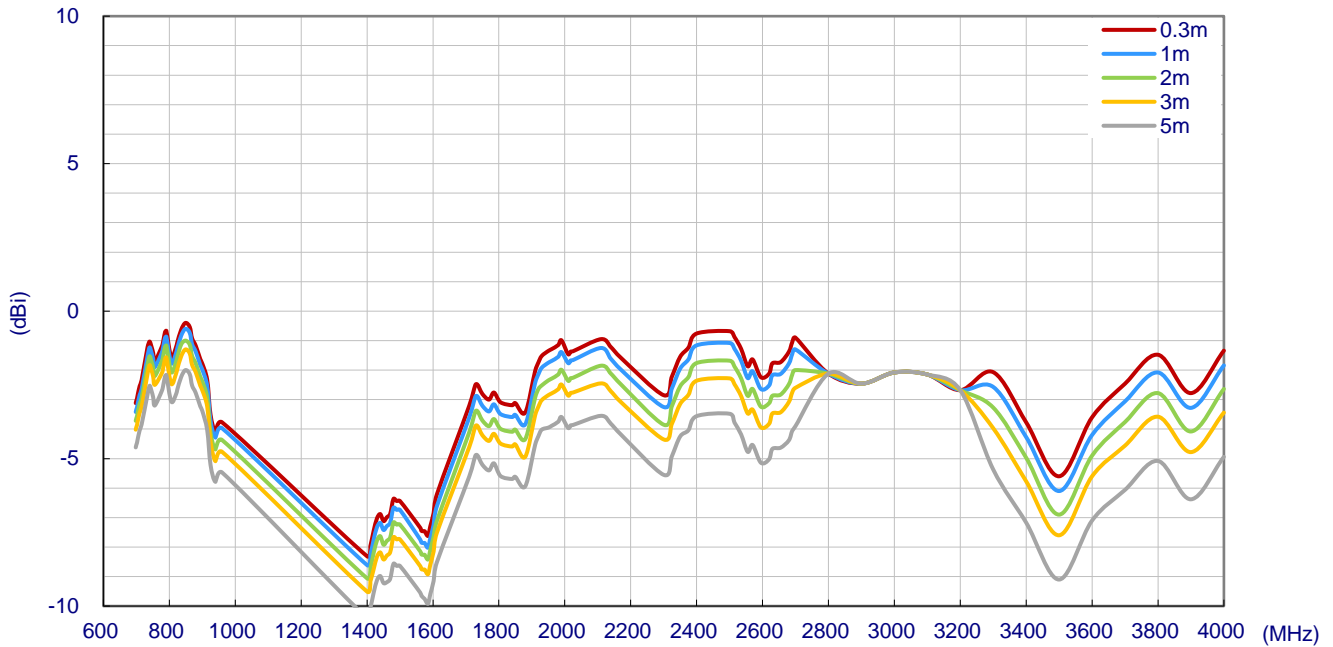

5G/4G MIMO 2

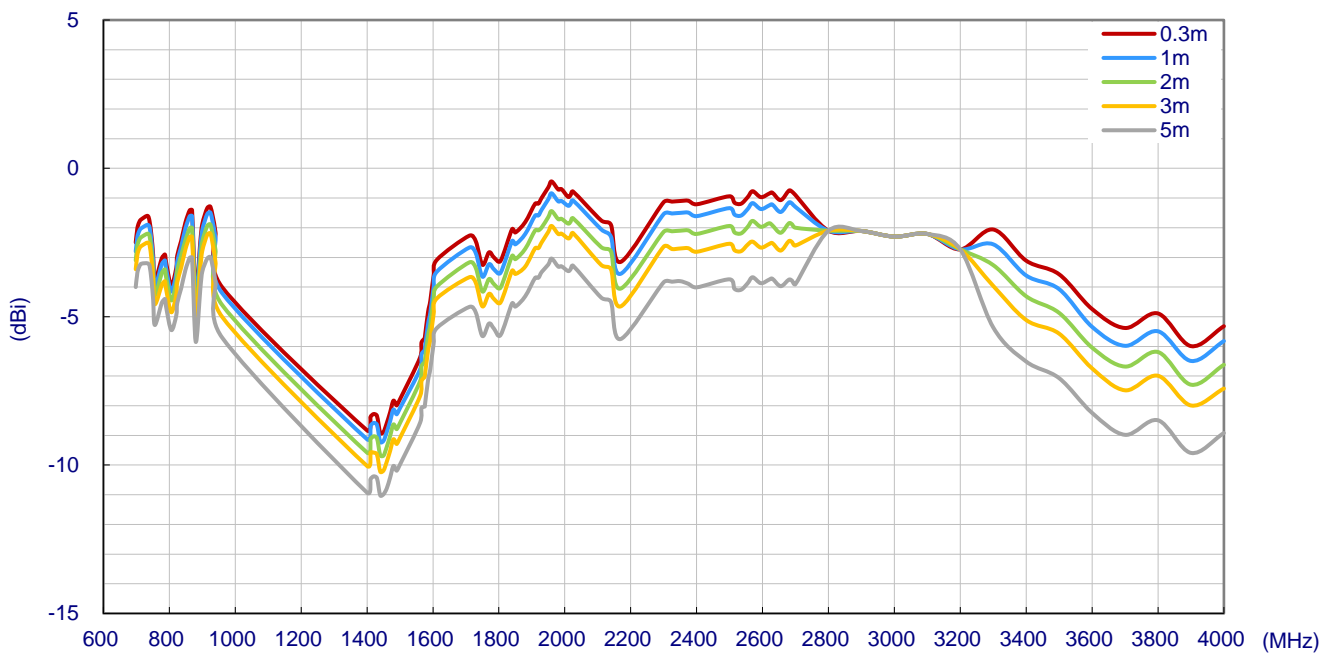

7.5 Peak Gain In Free Space – 5G/4G

5G/4G MIMO 1

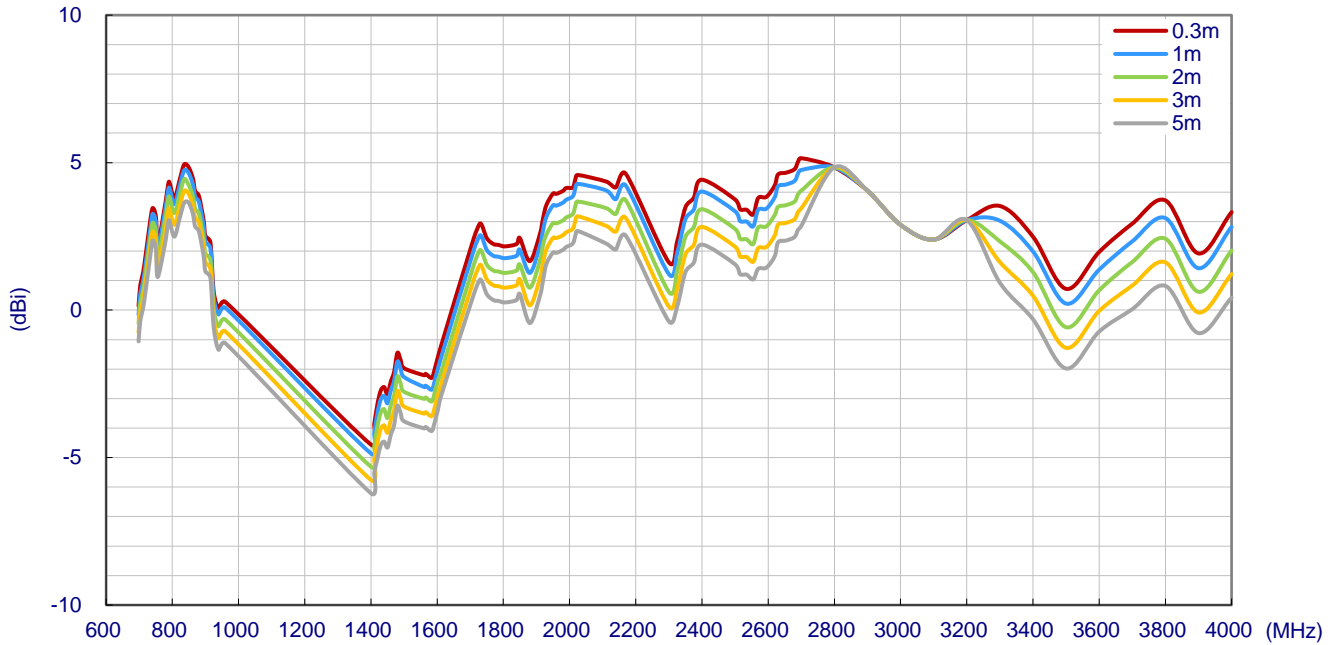

5G/4G MIMO 2

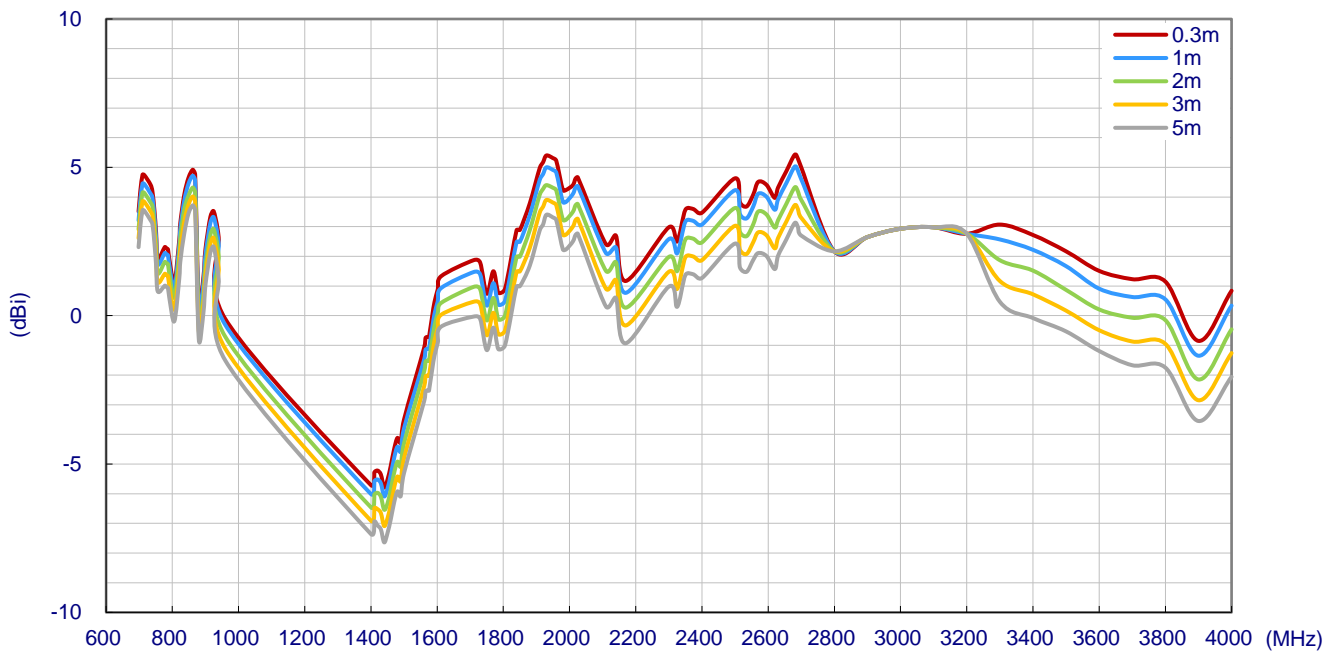

7.6 Return Loss – Wi-Fi

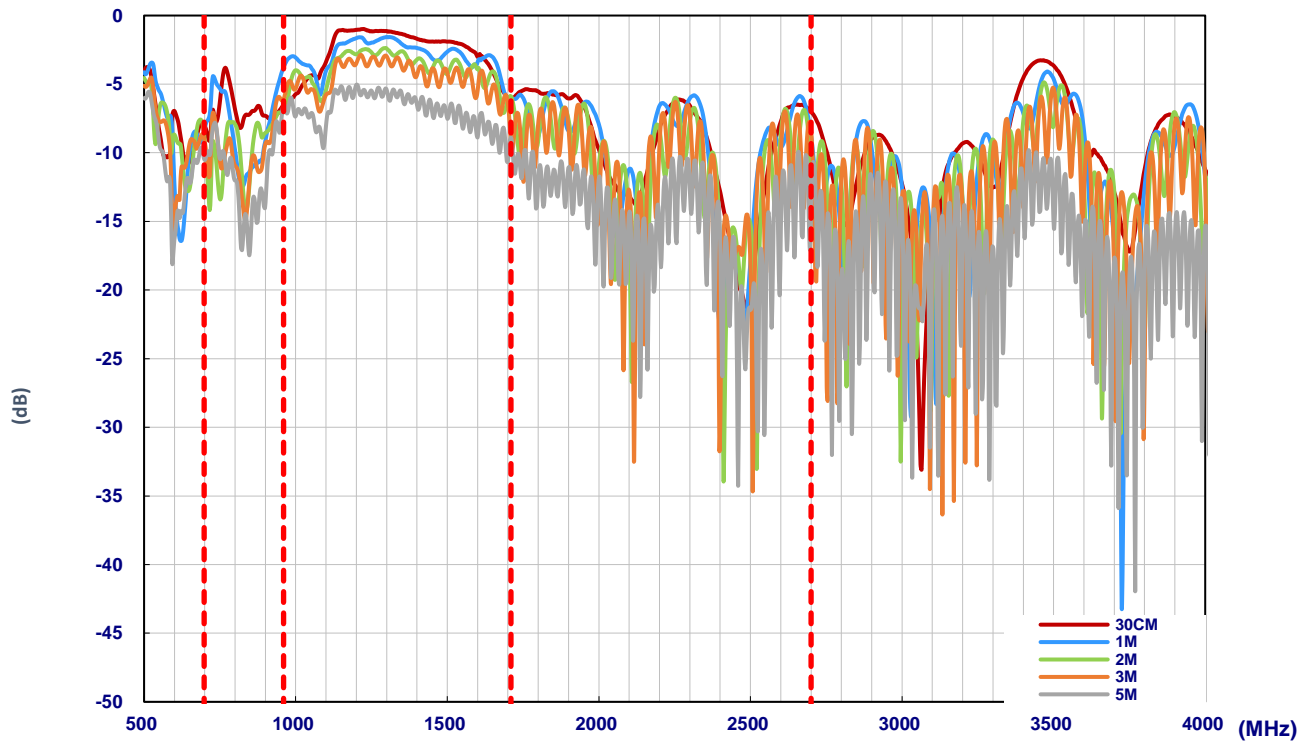

7.7 Efficiency – Wi-Fi

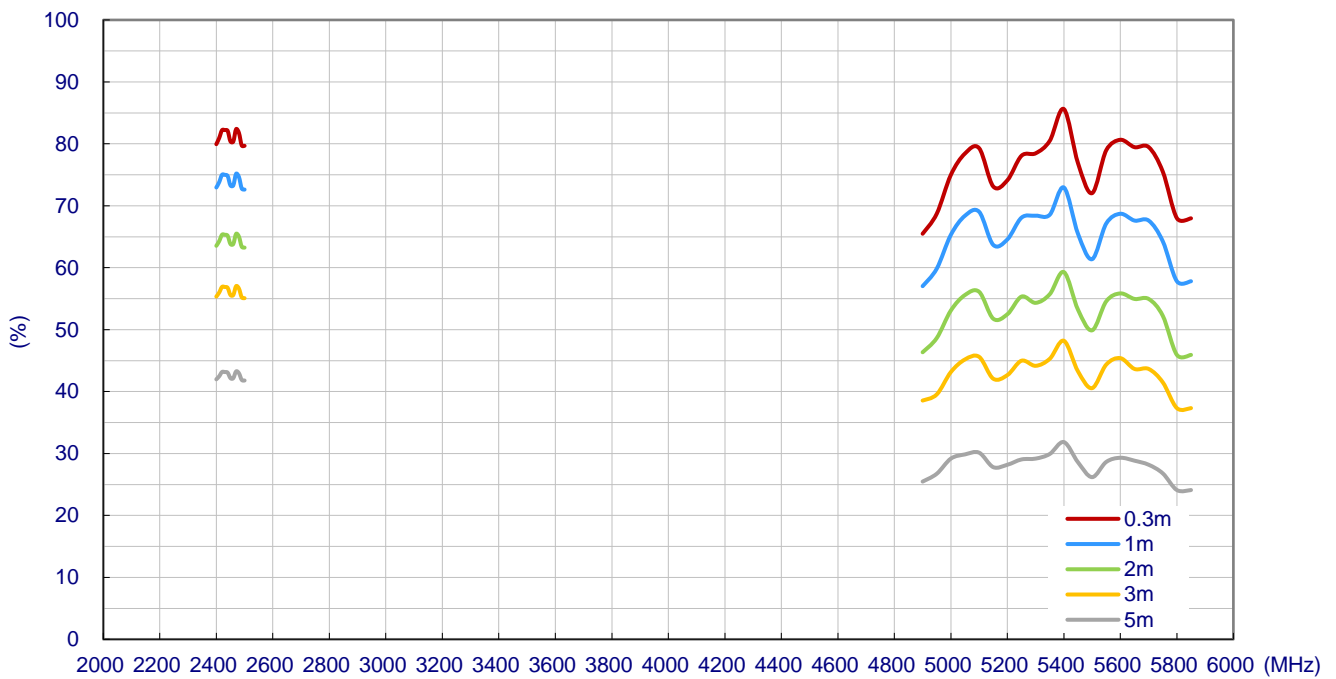

7.8 Average Gain – Wi-Fi

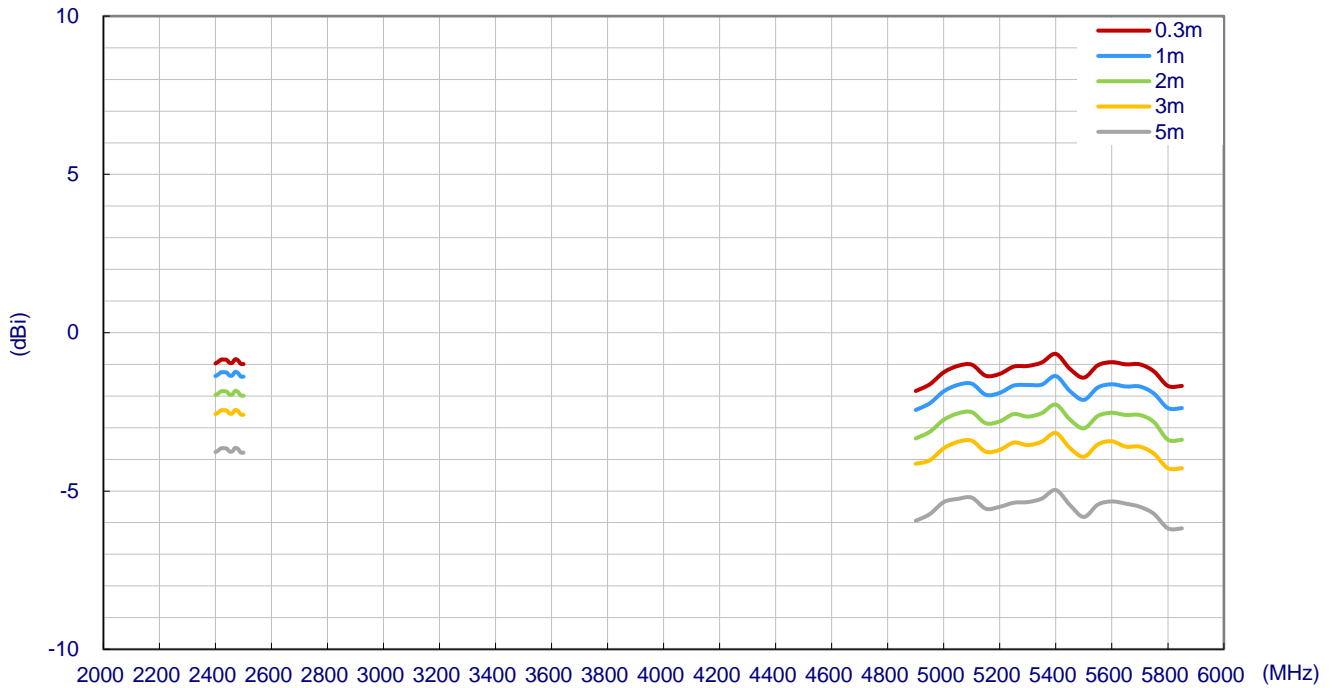

7.9 Peak Gain – Wi-Fi

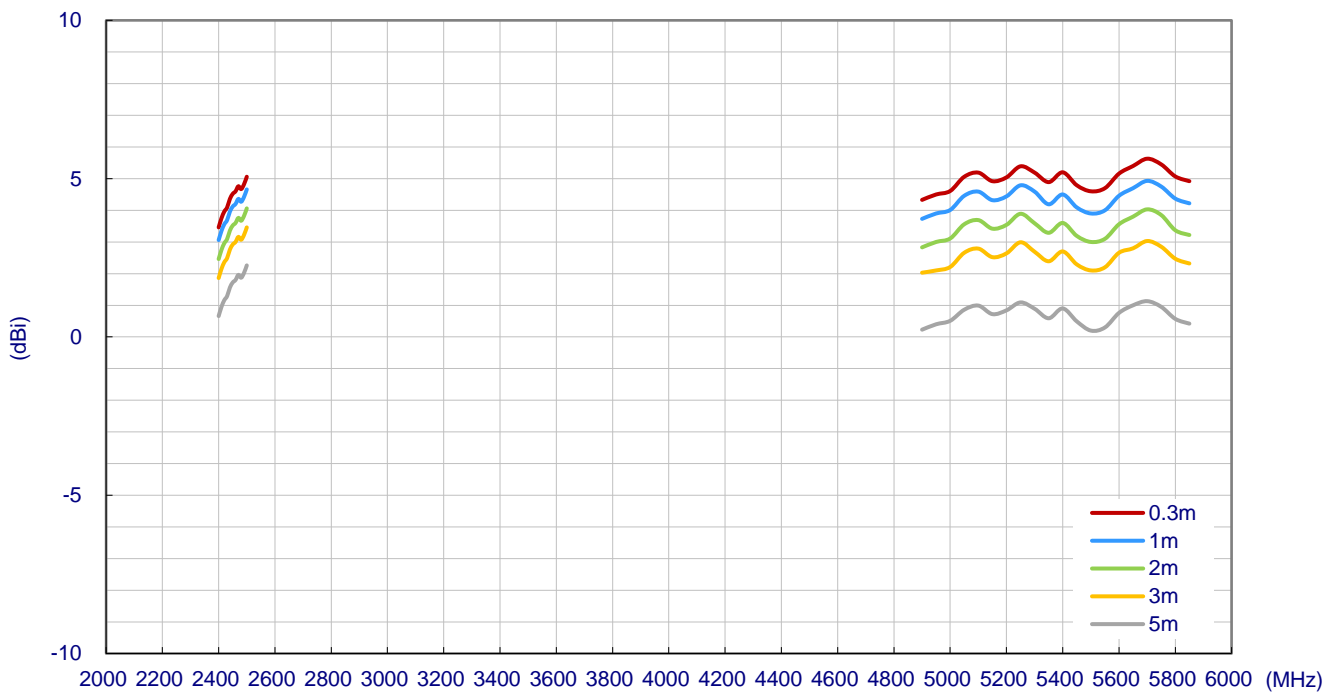

Changelog for the datasheet

SPE-19-8-109 – MA244.LBIC.002

Revision: A (Original First Release)

Date:	2019-08-15
Notes:	Initial Release
Author:	Jack Conroy

Previous Revisions



TAOGLAS®

www.taoglas.com

