



Spacial Thalassa ClimaSys Actassi

Catalogue 2022

Universal Enclosures

More than 60 years protecting your equipment



se.com/enclosures

Life Is On

Schneider
Electric

Life Is On

Contents

Overview	4
Services / Software / General Information	8
Selection Guide (Reference overview)	10
Spacial	
1 Steel Industrial Boxes	32
2 Steel wall-mounted enclosures	44
3 Steel floor-standing enclosures	108
4 Stainless-Steel Industrial Boxes	148
5 Stainless-steel wall-mounted enclosures	160
6 Stainless-steel floor-standing enclosures	172
Thalassa	
7 Insulated boxes	182
8 Insulated wall-mounted enclosures	212
9 Insulated floor-standing enclosures	230
Accessories	
10 Accessories	258
Applicative solutions	
11 Applicative solutions	342
Customized solutions	
12 Customized solutions	546
Actassi	
13 Actassi	554
ClimaSys	
14 Thermal management system	632
Technical guides	
15 Technical guides and spare parts	710
Index	
16 Index of references	744



Green Premium™

More than 75% of our product sales offer superior transparency on the material content, regulatory information and environmental impact of our products:

- RoHS compliance
- REACh substance information
- Industry leading # of PEP's*
- Circularity instructions

*PEP: Product Environmental Profile (i.e. Environmental Product Declaration)

Discover what we mean by green!
Check your products!



Scan or click

The Green Premium program stands for our commitment to deliver customer-valued sustainable performance. It has been upgraded with recognized environmental claims and extended to cover all offers including products, services and solutions.

CO₂ and P&L impact through... resource performance

Green Premium brings improved resource efficiency throughout an asset's lifecycle. This includes efficient use of energy and natural resources, along with the minimization of CO₂ emissions.

Cost of ownership optimization through... circular performance

We're helping our customers optimize the total cost of ownership of their assets. To do this, we provide IoT-enabled solutions, as well as upgrade, repair, retrofit, and remanufacture services.

Peace of mind through... health performance

Green Premium products are RoHS and REACh compliant. We're going beyond regulatory compliance with step-by-step substitution of certain materials and substances from our products.

Improved sales through... differentiation

Green Premium delivers strong value propositions through third-party labels and services. By collaborating with third-party organizations we can support our customers in meeting their sustainability goals such as green-building certifications.

How to define an enclosure solution?

Invariables

Switchgear and Controlgear are the cornerstone of any electrical system - in industry, infrastructure, building, energy, transport or any other segment. The correct enclosure and thermal management selection is crucial to guarantee the targeted performance. Safeguards of equipment installed inside ensure service continuity.

Correct selection of enclosure and thermal solution

Many influences must be considered when defining an enclosure system.

Three groups may be distinguished:

- Protection (equipment and people)
- Thermal management
- Solution profitability

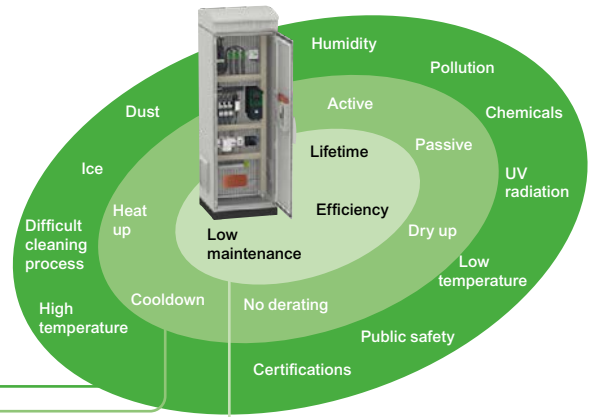

Ambient conditions and enclosure

The table below is only indicative and not binding. It shows, in a general concept, the optimized performance of the ranges of Universal Enclosures according to the ambient conditions, taking into account technical and commercial criteria:

- Highly recommended
- Recommended
- Not suitable

Ambient condition	Enclosure material						
	Steel	Steel Heavy-Duty	Stainless-steel 304L	Stainless-steel 316L	Stainless-steel 316L Paint	Polyester	Polyester Heavy-Duty
Indoor clean environment ⁽¹⁾	■■■	■	■	■	■	■	■
Difficult cleaning process ⁽²⁾	-	-	■■■	■■■	-	-	-
Outdoor (no public access)	-	■■■	■	■	■	■■■	■■■
Outdoor (public access)	-	■	■	■	■	■	■■■
Harsh chemicals	-	■	■■■	■■■	■■■	■■■	■■■
Solar radiation	-	■■■	-	■ ⁽⁴⁾	■ ⁽⁴⁾	■■■	■■■
Sand storms	-	-	■■■	■■■	-	■	■
Temperature > 40 °C ⁽³⁾	■■■	■■■	■■■	■■■	■■■	■■■	■■■
Temperature < 5 °C ⁽³⁾	■■■	■■■	■■■	■■■	■■■	■■■	■■■
Salty environment	-	-	-	■■■	■■■	■■■	■■■
Sea water splashes	-	-	-	■■■	■■■	■■■	■■■
Humidity > 70% ⁽³⁾	-	■■■	■■■	■■■	■■■	■■■	■■■
Impact	■■■	■■■	■■■	■■■	■■■	■■■	■■■
Vandalism	-	■■■	■	■	■	■	■■■
Burglary	-	■■■	■	■	■	■	■■■
Strong pollution	■	■■■	■■■	■■■	■■■	■■■	■■■
Vibration (marine application)	■■■	-	■■■	■■■	■■■	■■■	-
Seismic activity	■■■	-	-	-	-	-	-
Electro-magnetic interference	■■■	-	-	-	-	-	-

⁽¹⁾ Not considering F&B process

⁽²⁾ e.g. F&B process

⁽³⁾ Always using ClimaSys solutions

⁽⁴⁾ Marine solar plants

Thermal management

The thermal management system must ensure the temperature and humidity controlled inside the enclosure.

The correct solution must be based on a robust process starting with the diagnosis of the ambient conditions, going to the parameters calculations and defining the best architecture (enclosures + equipment installed + thermal solution).

ClimaSys is the definitive solution based on ClimaSys DT/EffiClima/ProClima.

Universal Enclosures

Our ranges, solutions for each application

Spacial



Metal enclosures and boxes

From our small boxes to large suitable floor-standing enclosures, the range of Spacial products offers the perfect fit for your applications. Our extensive range of easy-to-use accessories helps you save time during your projects. Select between steel or stainless-steel to better suit the installation environment. Our stainless-steel products represent the optimal solution where cleanliness is required, or for highly corrosive environments.

Thalassa



Insulated enclosures

Operating the equipment under adverse ambient conditions may expose your installation to chemical or aggressive substances. Our Thalassa range, from boxes to floor-standing enclosures, has been developed to efficiently protect your equipment. The products are made of fiberglass-reinforced polyester to resist harsh conditions and outdoor use. The Thalassa industrial boxes in ABS or polycarbonate are strong, easy to install and designed to be used in highly demanding environments.

ClimaSys



Thermal management

Maintaining the right temperature inside your enclosure is vital for maximising the lifetime of your installed devices. Our ClimaSys range offers you the right solution: airing, cooling or heating, including control units for temperature, humidity and many other parameters.

Actassi



19" Enclosures designed for all cabling + network applications

With the Actassi system you can create a seamless end-to-end network connectivity solution for all needs. Installations in small, medium or critical buildings, for edge computing (micro data centers) or small offices have specific demands and represent different operating conditions. To this end, the Actassi system offers a variety of sizes of wall-mounted and floor-standing enclosures, from 6 to 47 units in different widths, depths, colors, with customized configurations. You can always find an Actassi enclosure with aesthetic design and accessories easy to use for all Cabling and Networking applications.

Industry and Infrastructure Offer

A material for every environment

Steel



Indoor non-clean industrial environment

The industrial environment in mechanical plants is especially demanding as regards the protection of electric and electronic components against dust, splashing with oil and impacts. Such ambient conditions require a range that is suited to the application and easy to implement.

- Standard range for industrial applications.
- E.M.C. just available for WM (S3HF)
- Range of ATEX enclosures, for potentially explosive atmospheres.

Solution:

The Spacial range in steel
(wall-mounted, monobloc and suitable floor-standing enclosures).

304L - 316L stainless-steel



Demanding industrial environment

Food and beverage, pharmaceutical, petrochemical and infrastructure industries are particularly demanding in terms of hygiene and resistance to corrosion. Our products are available with two grades of stainless-steel:

- 304L stainless-steel:
Corrosion resistance and cleanability
(often used in food production).
- 316L stainless-steel: Also known as "marine stainless-steel".
Very high resistance to corrosion (saline or chlorinated environment).

Solution:

The Spacial range in stainless-steel
(wall-mounted, monobloc and suitable floor-standing enclosures).

Insulated polyester and plastic materials (ABS, polycarbonate)



Infrastructures and industrial environments

Outdoor infrastructures and electrical installations are exposed to direct sunlight, rain, saline mist, extreme temperatures, oil splashes, chemical and corrosive agents.

- Standard range for industry and infrastructures.

Solution:

The Thalassa range
(boxes, wall-mounted and floor-standing enclosures).

Heavy-Duty materials



Severe outdoor environments, generally requested by OEMs, the telecommunication, water treatment and transportation industry

Heavy-Duty polyester units are suitable for outdoor public areas thanks to its multiple benefits:

- Resistant against pressure and shock (IEC 61439-5: 2010),
 - Door with ribbed surface against posting,
 - Insulated (prepared for Class II according to IEC 61439-1: 2011).
- Heavy-Duty steel enclosures are designed for outdoor private areas:
- Resistant against aggressive environments (anti-corrosion certification class C4H, ISO 12944:2018).

Solution:

The Thalassa PHD and Spacial S3HD and SFHD ranges
(wall-mounted and floor-standing).



Selection Tools

www.se.com

Our web site allows you to access all Schneider Electric products with just two clicks with direct links to:

- A complete library of technical documents, catalogues, FAQs brochures, etc.
- Certificates.
- 2D and 3D drawings.
- Selection Guides from the e-catalogue.
- Product discovery sites.

You may also find illustrated overviews, news to which you can subscribe, a list of contacts in your country and other useful information.

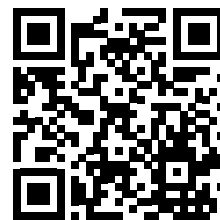

Scan or click

Digital Offer

ProClima

Find the best thermal solution for your enclosure

Select and calculate your thermal management requirements according to the environment and the electrical/electronic devices installed in the enclosure.



Digital Rules

Find the accessories that suit your enclosure

The digital rules allow you to select the best components from the current product range. There will be no risk of mistake since product and accessory selection take place automatically, saving you time and money.



Spacial.Conf

Get your enclosure pre-engineered for your special needs

The Spacial.Conf software gives you total autonomy to configure and quote enclosures with services (cut-outs, painting, accessory mounting) in less than 3 minutes. Spacial.Conf is designed to create orders quickly and conveniently, without any errors.



Have a smartphone or a tablet? Scan this:

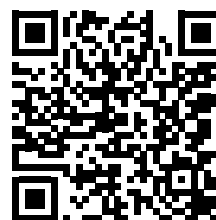

Scan or click

The Customized Solutions

Over 60 years of experience, knowledge and expertise to give you the best enclosure for your needs.

Two offer levels to cover your different requirements

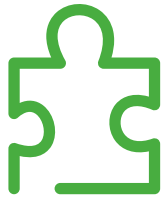

Configured to order (CTO):

[The enriched standard offer](#)

Feasibility is automatically guaranteed when using the Spatial.conf configurator, giving you autonomy and flexibility to quickly define your customized enclosure.

Delivery date information.



Engineered to Order (ETO):

[The co-developed offer](#)

For all your custom dimensions, accessories and logistic needs. Participate in the entire development process of your tailor-made solution.

According to joint development specifications.



Time-saving

Delivered with cut-outs and painting: no waste of time



Logistics

Flexible management of your logistic option (scheduled delivery service for on-going orders), special packaging)



Simplified installation

Enclosures delivered with cut-outs: No special tools required



Ergonomic design

Customized project dedicated to your personal requirements



Extended lifetime

Cut-outs done before painting ensures better corrosion protection and sealing, painting enhances protection



Higher quality level

No burrs on edges or cut-outs, guaranteed machining tolerances



Aesthetics

Large choice of colors, external surfaces with no scratches



Higher performances

Adapted thermal management, upgraded stainless-steel type

	Steel	Stainless-steel	Insulated material
Boxes	● ○	○	● ○
Wall-mounted	● ○	● ○	● ○
Compact floor-standing	● ○	● ○	● ○
Modular floor-standing	● ○	● ○	● ○

● CTO: Configured To Order

○ ETO: Engineered To Order



Technical changes reserved. Information provided without guarantee. Images are for illustrative purposes only.

Metal junction boxes SDB IP55, low cover models

External dimensions (mm)			Models without knock-outs	Models with knock-outs, n° of drill holes, knock-outs and group		Internal dimensions (mm)			Plain mounting plate	Weight (kg)	
Height (A)	Width (B)	Depth (C)	References	References	Height (A)	Width (B)	D	E	F	References	
85	85	49	NSYDBN88	NSYDB88M	1 n° 1	1 n° 1	58	58	-		0.18
105	105	49	NSYDBN1010	NSYDB1010M	2 n° 1	1 n° 1	76	76	-		0.25
155	105	61	NSYDBN1510	NSYDB1510M	3 n° 1	1 n° 1	124	74	56	NSYPMD1510	0.38
206	156	83	NSYDBN2015	NSYDB2015M	3 n° 2	2 n° 2	172	122	78	NSYPMD2015	1.00
256	206	93	NSYDBN2520	-	-	-	220	170	88	NSYPMD2520	1.5
307	257	116	NSYDBN3025	-	-	-	268	218	110	NSYPMD3025	3.3

Metal modular boxes

External dimensions (mm)			SBM
Height	Width	Depth	References
150	150	80	NSYSBM15158
150	150	120	NSYSBM151512
150	200	80	NSYSBM15208
150	200	120	NSYSBM152012
150	300	80	NSYSBM15308
150	300	120	NSYSBM153012
150	400	80	NSYSBM15408
150	400	120	NSYSBM154012
200	200	80	NSYSBM20208
200	200	120	NSYSBM202012
200	300	80	NSYSBM20308
200	300	120	NSYSBM203012
200	400	80	NSYSBM20408
200	400	120	NSYSBM204012
200	500	80	NSYSBM20508
200	500	120	NSYSBM205012
200	600	80	NSYSBM20608
200	600	120	NSYSBM206012
200	800	120	NSYSBM208012
300	300	120	NSYSBM303012
300	400	120	NSYSBM304012
300	500	120	NSYSBM305012
300	600	120	NSYSBM306012
300	800	120	NSYSBM308012
400	400	120	NSYSBM404012
400	500	120	NSYSBM405012
400	600	120	NSYSBM406012
400	800	120	NSYSBM408012

Accessories and mounting plates for metal modular boxes:

For further information about accessories and mounting plates see [page 40](#)

Spacial SBX Flat boxes

Dimensions (mm)			SBX
Height	Width	Depth	References
150	150	80	NSYSBX15158
150	300	80	NSYSBX15308
200	200	80	NSYSBX20208
200	300	80	NSYSBX20308
200	400	120	NSYSBX204012
300	300	120	NSYSBX303012

Universal boxes with IP66

Overall external dimensions						Overall internal dimensions				Universal boxes with IP66			
Height (mm)	Width (mm)	Depth (mm)	Height (mm)	Width (mm)	Depth (mm)	Body (mm)	Cover (mm)	Minor pack.	Cover screw	ABS IP66 IK07		PC-UL IP66 IK08	
										References	References	References	References
74	74	54	65	65	47	37	10	5	Metal	NSYTBS775	-	NSYTBP775	-
89	89	54	80	80	47	37	10	5	Metal	NSYTBS885	-	NSYTBP885	-
116	74	62	105	65	55	45	10	5	Metal	NSYTBS1176	-	NSYTBP1176	-
116	74	94	105	65	85	45	40	3	Metal	NSYTBS1179H	-	-	-
116	116	62	105	105	55	45	10	5	Plastic	NSYTBS11116	-	NSYTBP11116	-
116	116	133	105	105	125	45	80	2	Plastic	NSYTBS111113H	-	-	-
138	93	72	125	80	65	45	20	2	Plastic	NSYTBS1397	NSYTBS1397T	NSYTBP1397	NSYTBP1397T
164	121	87	150	105	80	60	20	2	Plastic	NSYTBS16128	NSYTBS16128T	NSYTBP16128	NSYTBP16128T
192	121	87	175	105	80	60	20	2	Plastic	NSYTBS19128	NSYTBS19128T	NSYTBP19128	NSYTBP19128T
192	121	105	175	105	100	60	40	2	Plastic	NSYTBS191210H	NSYTBS191210HT	NSYTBP191210H	NSYTBP191210HT
192	164	87	175	150	80	60	20	1	Plastic	NSYTBS19168	NSYTBS19168T	NSYTBP19168	NSYTBP19168T
192	164	105	175	150	100	60	40	1	Plastic	NSYTBS191610H	NSYTBS191610HT	NSYTBP191610H	NSYTBP191610HT
241	194	87	225	175	80	60	20	1	Plastic	NSYTBS24198	NSYTBS24198T	NSYTBP24198	NSYTBP24198T
241	194	107	225	175	100	80	20	1	Plastic	NSYTBS241910	NSYTBS241910T	NSYTBP241910	NSYTBP241910T
241	194	107	225	175	100	60	40	1	Plastic	NSYTBS241910H	NSYTBS241910HT	NSYTBP241910H	NSYTBP241910HT
241	194	127	225	175	120	80	40	1	Plastic	NSYTBS241912H	NSYTBS241912HT	NSYTBP241912H	NSYTBP241912HT
291	241	88	275	225	80	60	20	1	Plastic	NSYTBS29248	NSYTBS29248T	NSYTBP29248	NSYTBP29248T
291	241	128	275	225	120	100	20	1	Plastic	NSYTBS292412	NSYTBS292412T	NSYTBP292412	NSYTBP292412T
291	241	128	275	225	120	60	60	1	Plastic	NSYTBS292412H	NSYTBS292412HT	NSYTBP292412H	NSYTBP292412HT
291	241	168	275	225	160	100	60	1	Plastic	NSYTBS292416H	NSYTBS292416HT	NSYTBP292416H	NSYTBP292416HT
341	291	128	325	275	120	100	20	1	Plastic	NSYTBS342912	NSYTBS342912T	NSYTBP342912	NSYTBP342912T
341	291	168	325	275	160	100	60	1	Plastic	NSYTBS342916H	NSYTBS342916HT	NSYTBP342916H	NSYTBP342916HT

Accessories and mounting plates for universal boxes with IP66:

For further information about accessories and mounting plates see [page 188](#)

Universal boxes with IP66







Dimensions			Complete box				
Height (mm)	Width (mm)	Depth (mm)	Transparent cover		Opaque cover		Polyester cover
			References	References	References	References	
180	270	180	NSYPLS1827G	NSYPLSC1827G	NSYPLSP1827G		
270	270	180	NSYPLS2727G	NSYPLSC2727G	NSYPLSP2727G		
270	270	230	NSYPLS2727AG	NSYPLSC2727AG	-		
270	360	180	NSYPLS2736G	NSYPLSC2736G	NSYPLSP2736G		
270	360	230	NSYPLS2736AG	NSYPLSC2736AG	-		
270	540	180	NSYPLS2754G	NSYPLSC2754G	NSYPLSP2754G		
270	540	230	NSYPLS2754AG	NSYPLSC2754AG	-		
360	360	180	NSYPLS3636G	NSYPLSC3636G	NSYPLSP3636G		
360	540	180	NSYPLS3654G	NSYPLSC3654G	NSYPLSP3654G		
360	540	230	NSYPLS3654AG	NSYPLSC3654AG	-		
360	720	230	NSYPLS3672AG	NSYPLSC3672AG	-		
540	540	180	NSYPLS5454G	NSYPLSC5454G	NSYPLSP5454G		
540	540	230	NSYPLS5454AG	NSYPLSC5454AG	-		
540	720	230	NSYPLS5472AG	NSYPLSC5472AG	-		

Accessories and mounting plates for modular boxes:

For further information about accessories and mounting plates see [page 202](#)

Technical changes reserved. Information provided without guarantee. Images are for illustrative purposes only.

CRN Steel Wall-Mounted Enclosures

Dimensions						Enclosures			Mounting plates				
Height (A) (mm)	Width (B) (mm)	Depth (C) (mm)	Doors	IP	Weight (kg) ⁽¹⁾								
						with plain door, with mounting plate	with plain door, without mounting plate	with glazed door, with mounting plate	Plain	Silkscreened	Micro-perforated	Telequick	
200	200	150	1	66	2.5	-	NSYCRN22150 ⁽²⁾	-	NSYMM22	-	-	-	
200	300	150	1	66	3.9	-	NSYCRN23150 ⁽²⁾	-	NSYMM32	-	NSYMF32	-	
250	200	150	1	66	3.2	NSYCRN252150P	NSYCRN252150	-	NSYMM2520	-	-	-	
300	250	150	1	66	4.2	NSYCRN325150P	NSYCRN325150	NSYCRN325150T	NSYMM3025	-	-	NSYMR3025	
300	250	200	1	66	4.9	NSYCRN325200P	NSYCRN325200	NSYCRN325200T	NSYMM3025	-	-	NSYMR3025	
300	300	150	1	66	5.0	NSYCRN33150P	NSYCRN33150	NSYCRN33150T	NSYMM33	-	NSYMF33	NSYMR33	
300	300	200	1	66	6.0	NSYCRN33200P	NSYCRN33200	NSYCRN33200T	NSYMM33	-	NSYMF33	NSYMR33	
300	400	200	1	66	6.4	-	NSYCRN34200	NSYCRN34200T	NSYMM43	NSYMS43	NSYMF43	NSYMR34	
300	450	150	1	66	6.7	-	NSYCRN345150	-	NSYMM3045	-	-	-	
400	300	150	1	66	6.0	NSYCRN43150P	NSYCRN43150	NSYCRN43150T	NSYMM43	NSYMS43	NSYMF43	NSYMR43	
400	300	200	1	66	6.8	NSYCRN43200P	NSYCRN43200	NSYCRN43200T	NSYMM43	NSYMS43	NSYMF43	NSYMR43	
400	400	200	1	66	8.0	NSYCRN44200P	NSYCRN44200	NSYCRN44200T	NSYMM44	NSYMS44	NSYMF44	NSYMR44	
400	600	250	1	66	10.0	NSYCRN46250P	NSYCRN46250	NSYCRN46250T	NSYMM64	NSYMS64	NSYMF64	NSYMR46	
400	600	300	1	66	11.2	-	NSYCRN46300	NSYCRN46300T	NSYMM64	NSYMS64	NSYMF64	NSYMR46	
500	400	150	1	66	8.7	NSYCRN54150P	NSYCRN54150	NSYCRN54150T	NSYMM54	NSYMS54	NSYMF54	NSYMR54	
500	400	200	1	66	9.8	NSYCRN54200P	NSYCRN54200	NSYCRN54200T	NSYMM54	NSYMS54	NSYMF54	NSYMR54	
500	400	250	1	66	11.0	NSYCRN54250P	NSYCRN54250	NSYCRN54250T	NSYMM54	NSYMS54	NSYMF54	NSYMR54	
500	500	250	1	66	12.8	NSYCRN55250P	NSYCRN55250	NSYCRN55250T	NSYMM55	NSYMS55	NSYMF55	NSYMR55	
600	400	150	1	66	9.3	NSYCRN64150P	NSYCRN64150	NSYCRN64150T	NSYMM64	NSYMS64	NSYMF64	NSYMR64	
600	400	200	1	66	10.8	NSYCRN64200P	NSYCRN64200	NSYCRN64200T	NSYMM64	NSYMS64	NSYMF64	NSYMR64	
600	400	250	1	66	12.3	NSYCRN64250P	NSYCRN64250	NSYCRN64250T	NSYMM64	NSYMS64	NSYMF64	NSYMR64	
600	500	150	1	66	11.3	NSYCRN65150P	NSYCRN65150	NSYCRN65150T	NSYMM65	-	NSYMF65	NSYMR65	
600	500	200	1	66	14.3	NSYCRN65200P	NSYCRN65200	NSYCRN65200T	NSYMM65	-	NSYMF65	NSYMR65	
600	500	250	1	66	16.2	NSYCRN65250P	NSYCRN65250	NSYCRN65250T	NSYMM65	-	NSYMF65	NSYMR65	
600	600	200	1	66	16.3	NSYCRN66200P	NSYCRN66200	NSYCRN66200T	NSYMM66	NSYMS66	NSYMF66	NSYMR66	
600	600	250	1	66	18.2	NSYCRN66250P	NSYCRN66250	NSYCRN66250T	NSYMM66	NSYMS66	NSYMF66	NSYMR66	
600	600	300	1	66	19.8	NSYCRN66300P	NSYCRN66300	NSYCRN66300T	NSYMM66	NSYMS66	NSYMF66	NSYMR66	
600	800	300	1	66	26.0	-	NSYCRN68300	NSYCRN68300T	NSYMM86	NSYMS86	NSYMF86	NSYMR68	
700	500	200	1	66	17.3	NSYCRN75200P	NSYCRN75200	NSYCRN75200T	NSYMM75	NSYMS75	NSYMF75	NSYMR75	
700	500	250	1	66	19.3	NSYCRN75250P	NSYCRN75250	NSYCRN75250T	NSYMM75	NSYMS75	NSYMF75	NSYMR75	
800	600	200	1	66	21.8	NSYCRN86200P	NSYCRN86200	NSYCRN86200T	NSYMM86	NSYMS86	NSYMF86	NSYMR86	
800	600	250	1	66	24.8	NSYCRN86250P	NSYCRN86250	NSYCRN86250T	NSYMM86	NSYMS86	NSYMF86	NSYMR86	
800	600	300	1	66	26.3	NSYCRN86300P	NSYCRN86300	NSYCRN86300T	NSYMM86	NSYMS86	NSYMF86	NSYMR86	
800	800	200	1	66	29.5	NSYCRN88200P	NSYCRN88200	NSYCRN88200T	NSYMM88	-	NSYMF88	NSYMR88	
800	800	300	1	66	32.5	NSYCRN88300P	NSYCRN88300	NSYCRN88300T	NSYMM88	-	NSYMF88	NSYMR88	
1000	600	250	1	66	28.4	NSYCRN106250P	NSYCRN106250	NSYCRN106250T	NSYMM106	-	NSYMF106	NSYMR106	
1000	600	300	1	66	30.6	NSYCRN106300P	NSYCRN106300	NSYCRN106300T	NSYMM106	-	NSYMF106	NSYMR106	
1000	800	250	1	66	34.5	NSYCRN108250P	NSYCRN108250	NSYCRN108250T	NSYMM108	-	NSYMF108	NSYMR108	
1000	800	300	1	66	37.4	NSYCRN108300P	NSYCRN108300	NSYCRN108300T	NSYMM108	-	NSYMF108	NSYMR108	

⁽¹⁾ Enclosure without mounting plate.

⁽²⁾ Two cable gland plates, one on the top, one on the bottom.

Cable entries								Dimensions		
Bakelite	DIN rail chassis	Aluminum vertical rails ⁽³⁾	Fig.	Type of cable entry	Cable gland plate standard	Cable gland plate insulated	Height (A) (mm)	Width (B) (mm)	Depth (C) (mm)	
-	-	-	1	0	NSYTLCRNO	-	200	200	150	
NSYMB32	-	-	1	B	NSYTLCRNB	-	200	300	150	
-	-	-	1	0	NSYTLCRNO	-	250	200	150	
NSYMB3025	-	NSYMDVR3	1	A	NSYTLCRNB	NSYTSACRNB	300	250	150	
NSYMB3025	-	NSYMDVR3	1	A	NSYTLCRNB	NSYTSACRNB	300	250	200	
NSYMB33	NSYMD33	NSYMDVR3	1	B	NSYTLCRNB	NSYTSACRNB	300	300	150	
NSYMB33	NSYMD33	NSYMDVR3	1	B	NSYTLCRNB	NSYTSACRNB	300	300	200	
NSYMB43	-	NSYMDVR3	1	C	NSYTLCRNC	NSYTSACRNC	300	400	200	
NSYMB43	-	NSYMDVR3	1	B	NSYTLCRNB	NSYTSACRNB	300	450	150	
NSYMB43	NSYMD43	NSYMDVR4	1	B	NSYTLCRNB	NSYTSACRNB	400	300	150	
NSYMB43	NSYMD43	NSYMDVR4	1	B	NSYTLCRNB	NSYTSACRNB	400	300	200	
-	-	NSYMDVR4	1	C	NSYTLCRNC	NSYTSACRNC	400	400	200	
NSYMB64	-	NSYMDVR4	1	D	NSYTLCRND	NSYTSACRND	400	600	250	
NSYMB64	-	NSYMDVR4	1	D	NSYTLCRND	NSYTSACRND	400	600	300	
NSYMB54	NSYMD54	NSYMDVR5	2	B	NSYTLCRNB	NSYTSACRNB	500	400	150	
NSYMB54	NSYMD54	NSYMDVR5	2	C	NSYTLCRNC	NSYTSACRNC	500	400	200	
NSYMB54	NSYMD54	NSYMDVR5	2	C	NSYTLCRNC	NSYTSACRNC	500	400	250	
-	-	NSYMDVR5	2	D	NSYTLCRND	NSYTSACRND	500	500	250	
NSYMB64	NSYMD64	NSYMDVR6	2	B	NSYTLCRNB	NSYTSACRNB	600	400	150	
NSYMB64	NSYMD64	NSYMDVR6	2	C	NSYTLCRNC	NSYTSACRNC	600	400	200	
NSYMB64	NSYMD64	NSYMDVR6	2	C	NSYTLCRNC	NSYTSACRNC	600	400	250	
NSYMB65	-	NSYMDVR6	2	B	NSYTLCRNB	NSYTSACRNB	600	500	150	
NSYMB65	-	NSYMDVR6	2	D	NSYTLCRND	NSYTSACRND	600	500	200	
NSYMB65	-	NSYMDVR6	2	D	NSYTLCRND	NSYTSACRND	600	500	250	
-	NSYMD66	NSYMDVR6	2	D	NSYTLCRND	NSYTSACRND	600	600	200	
-	NSYMD66	NSYMDVR6	2	D	NSYTLCRND	NSYTSACRND	600	600	250	
-	NSYMD66	NSYMDVR6	2	D	NSYTLCRND	NSYTSACRND	600	600	300	
-	-	NSYMDVR6	2	E	NSYTLCRNC ⁽⁴⁾	NSYTSACRNC ⁽⁵⁾	600	800	300	
NSYMB75	NSYMD75	NSYMDVR7	2	D	NSYTLCRND	NSYTSACRND	700	500	200	
NSYMB75	NSYMD75	NSYMDVR7	2	D	NSYTLCRND	NSYTSACRND	700	500	250	
NSYMB86	NSYMD86	NSYMDVR8	2	D	NSYTLCRND	NSYTSACRND	800	600	200	
NSYMB86	NSYMD86	NSYMDVR8	2	D	NSYTLCRND	NSYTSACRND	800	600	250	
NSYMB86	NSYMD86	NSYMDVR8	2	D	NSYTLCRND	NSYTSACRND	800	600	300	
-	-	NSYMDVR8	2	E	NSYTLCRNC ⁽⁴⁾	NSYTSACRNC ⁽⁵⁾	800	800	200	
-	-	NSYMDVR8	2	E	NSYTLCRNC ⁽⁴⁾	NSYTSACRNC ⁽⁵⁾	800	800	300	
NSYMB106	-	NSYMDVR10	2	D	NSYTLCRND	NSYTSACRND	1000	600	250	
NSYMB106	-	NSYMDVR10	2	D	NSYTLCRND	NSYTSACRND	1000	600	300	
NSYMB108	NSYMD108	NSYMDVR10	2	E	NSYTLCRNC ⁽⁴⁾	NSYTSACRNC ⁽⁵⁾	1000	800	250	
NSYMB108	NSYMD108	NSYMDVR10	2	E	NSYTLCRNC ⁽⁴⁾	NSYTSACRNC ⁽⁵⁾	1000	800	300	

⁽³⁾ Order NSYAMCSF, NSYMDVR12 in steel.

⁽⁴⁾ With two holes.

⁽⁵⁾ Flange openings of type E require two NSYTSACRNC

S3D Steel Wall-Mounted Enclosures

Dimensions ⁽¹⁾			Door					Mounting plates			
Height (mm)	Width (mm)	Depth (mm)	Doors	IP	Weight (kg) ⁽²⁾	Plain without mounting plate	Plain with mounting plate	Glazed without mounting plate	Plain	Silkscreened ⁽³⁾	Microperforated
300	200	150	1	66	3.02	NSYS3D3215	NSYS3D3215P	-	NSYMM32	-	NSYMF32
300	250	150	1	66	3.48	NSYS3D32515	NSYS3D32515P	NSYS3D32515T	NSYMM3025	-	-
300	300	150	1	66	3.90	NSYS3D3315	NSYS3D3315P	NSYS3D3315T	NSYMM33	-	NSYMF33
300	300	200	1	66	4.50	NSYS3D3320	NSYS3D3320P	NSYS3D3320T	NSYMM33	-	NSYMF33
300	400	150	1	66	4.82	NSYS3D3415	NSYS3D3415P	NSYS3D3415T	NSYMM43	NSYMS43	NSYMF43
300	400	200	1	66	5.60	NSYS3D3420	NSYS3D3420P	NSYS3D3420T	NSYMM43	NSYMS43	NSYMF43
400	300	150	1	66	4.90	NSYS3D4315	NSYS3D4315P	NSYS3D4315T	NSYMM43	NSYMS43	NSYMF43
400	300	200	1	66	5.00	NSYS3D4320	NSYS3D4320P	NSYS3D4320T	NSYMM43	NSYMS43	NSYMF43
400	400	200	1	66	6.50	NSYS3D4420	NSYS3D4420P	NSYS3D4420T	NSYMM44	NSYMS44	NSYMF44
400	600	200	1	66	10.50	NSYS3D4620	NSYS3D4620P	NSYS3D4620T	NSYMM64	NSYMS64	NSYMF64
400	600	250	1	66	12.00	NSYS3D4625	NSYS3D4625P	NSYS3D4625T	NSYMM64	NSYMS64	NSYMF64
500	300	200	1	66	7.50	NSYS3D5320	NSYS3D5320P	NSYS3D5320T	NSYMM53	NSYMS53	NSYMF53
500	400	200	1	66	9.30	NSYS3D5420	NSYS3D5420P	NSYS3D5420T	NSYMM54	NSYMS54	NSYMF54
500	400	250	1	66	10.20	NSYS3D5425	NSYS3D5425P	NSYS3D5425T	NSYMM54	NSYMS54	NSYMF54
500	500	200	1	66	11.18	NSYS3D5520	NSYS3D5520P	NSYS3D5520T	NSYMM55	NSYMS55	NSYMF55
500	500	250	1	66	12.06	NSYS3D5525	NSYS3D5525P	NSYS3D5525T	NSYMM55	NSYMS55	NSYMF55
600	400	200	1	66	11.00	NSYS3D6420	NSYS3D6420P	NSYS3D6420T	NSYMM64	NSYMS64	NSYMF64
600	400	250	1	66	12.00	NSYS3D6425	NSYS3D6425P	NSYS3D6425T	NSYMM64	NSYMS64	NSYMF64
600	500	250	1	66	16.20	NSYS3D6525	NSYS3D6525P	NSYS3D6525T	NSYMM65	-	NSYMF65
600	600	200	1	66	14.00	NSYS3D6620	NSYS3D6620P	NSYS3D6620T	NSYMM66	NSYMS66	NSYMF66
600	600	250	1	66	15.00	NSYS3D6625	NSYS3D6625P	NSYS3D6625T	NSYMM66	NSYMS66	NSYMF66
600	600	300	1	66	17.00	NSYS3D6630	NSYS3D6630P	NSYS3D6630T	NSYMM66	NSYMS66	NSYMF66
600	600	400	1	66	19.00	NSYS3D6640	NSYS3D6640P	NSYS3D6640T	NSYMM66	NSYMS66	NSYMF66
600	800	300	1	66	25.50	NSYS3D6830	NSYS3D6830P	NSYS3D6830T	NSYMM86	NSYMS86	NSYMF86
700	500	250	1	66	15.00	NSYS3D7525	NSYS3D7525P	NSYS3D7525T	NSYMM75	NSYMS75	NSYMF75
800	600	200	1	66	21.00	NSYS3D8620	NSYS3D8620P	NSYS3D8620T	NSYMM86	NSYMS86	NSYMF86
800	600	250	1	66	23.00	NSYS3D8625	NSYS3D8625P	NSYS3D8625T	NSYMM86	NSYMS86	NSYMF86
800	600	300	1	66	25.00	NSYS3D8630	NSYS3D8630P	NSYS3D8630T	NSYMM86	NSYMS86	NSYMF86
800	600	400	1	66	29.00	NSYS3D8640	NSYS3D8640P	NSYS3D8640T	NSYMM86	NSYMS86	NSYMF86
800	800	250	1	66	30.00	NSYS3D8825	NSYS3D8825P	NSYS3D8825T	NSYMM88	-	NSYMF88
800	800	300	1	66	32.00	NSYS3D8830	NSYS3D8830P	NSYS3D8830T	NSYMM88	-	NSYMF88
800	1000	300	1	66	38.00	NSYS3D81030	NSYS3D81030P	-	NSYMM108	-	NSYMF108
800	1000	300	2	55	43.50	NSYS3D81030D	NSYS3D81030DP	-	NSYMM108	-	NSYMF108
800	1200	300	2	55	46.00	NSYS3D81230D	NSYS3D81230DP	-	NSYMM128	-	NSYMF128
1000	600	250	1	66	28.00	NSYS3D10625	NSYS3D10625P	NSYS3D10625T	NSYMM106	-	NSYMF106
1000	600	300	1	66	30.60	NSYS3D10630	NSYS3D10630P	NSYS3D10630T	NSYMM106	-	NSYMF106
1000	600	400	1	66	33.00	NSYS3D10640	NSYS3D10640P	NSYS3D10640T	NSYMM106	-	NSYMF106
1000	800	250	1	66	35.00	NSYS3D10825	NSYS3D10825P	NSYS3D10825T	NSYMM108	-	NSYMF108
1000	800	300	1	66	38.00	NSYS3D10830	NSYS3D10830P	NSYS3D10830T	NSYMM108	-	NSYMF108
1000	800	400	1	66	42.00	NSYS3D10840	NSYS3D10840P	NSYS3D10840T	NSYMM108	-	NSYMF108
1000	1000	300	1	66	46.00	NSYS3D101030	NSYS3D101030P	NSYS3D101030T	NSYMM1010	-	NSYMF1010
1000	1000	300	2	55	46.00	NSYS3D101030D	NSYS3D101030DP	NSYS3D101030DT	NSYMM1010	-	NSYMF1010
1000	1200	300	2	55	53.00	NSYS3D101230D	NSYS3D101230DP	-	NSYMM1210	-	NSYMF1210
1000	1200	400	2	55	60.00	NSYS3D101240D	NSYS3D101240DP	-	NSYMM1210	-	NSYMF1210
1200	600	300	1	66	37.00	NSYS3D12630	NSYS3D12630P	NSYS3D12630T	NSYMM126	-	NSYMF126
1200	600	400	1	66	42.00	NSYS3D12640	NSYS3D12640P	NSYS3D12640T	NSYMM126	-	NSYMF126
1200	800	300	1	66	45.00	NSYS3D12830	NSYS3D12830P	NSYS3D12830T	NSYMM128	-	NSYMF128
1200	800	400	1	66	49.00	NSYS3D12840	NSYS3D12840P	NSYS3D12840T	NSYMM128	-	NSYMF128
1200	1000	300	1	66	53.00	NSYS3D121030	NSYS3D121030P	NSYS3D121030T	NSYMM1210	-	NSYMF1210
1200	1000	300	2	55	54.00	NSYS3D121030D	NSYS3D121030DP	NSYS3D121030DT	NSYMM1210	-	NSYMF1210
1200	1000	400	2	55	61.00	NSYS3D121040D	NSYS3D121040DP	-	NSYMM1210	-	NSYMF1210
1200	1200	300	2	55	64.00	NSYS3D121230D	NSYS3D121230DP	-	NSYMM1212	-	2x NSYMF126 ⁽⁴⁾
1200	1200	400	2	55	90.00	NSYS3D121240D	NSYS3D121240DP	-	NSYMM1212	-	2x NSYMF126 ⁽⁴⁾
1400	1000	300	2	55	80.00	NSYS3D141030D	NSYS3D141030DP	-	NSYMM1410	-	-

⁽¹⁾ For other dimensions see our application offer on page 16.

⁽²⁾ Enclosure without mounting plate.

⁽³⁾ In inverted use, the marking is inverted.

⁽⁴⁾ Order NSYCRNGSDR for double mounting of the mounting plates

⁽⁵⁾ Order nuts ref. NSYAMCSF. Steel siderail ref. NSYMDVR12.

⁽⁶⁾ Possible assembling to ref. NSYDLM84 or NSYDLM112.

Modular mounting plate						Cross-rails				Dimensions ⁽¹⁾		
Telequick	Bakelite	Module	Modular chassis DLM Steel	Modular chassis DLA Insulated	DIN rail chassis	Typ	Aluminum vertical rails ⁽⁶⁾	Door cross-rails	Height (mm)	Width (mm)	Depth (mm)	
NSYMR32	NSYMB32	-	-	-	-	-	NSYMDVR3	-	300	200	150	
NSYMR3025	NSYMB3025	-	-	-	-	-	NSYMDVR3	-	300	250	150	
NSYMR33	NSYMB33	-	-	-	-	NSYMD33	B	NSYMDVR3	300	300	150	
NSYMR33	NSYMB33	-	-	-	-	NSYMD33	B	NSYMDVR3	300	300	200	
NSYMR34	NSYMB43	-	-	-	-	-	-	NSYMDVR3	300	400	150	
NSYMR34	NSYMB43	-	-	-	-	-	-	NSYMDVR3	300	400	200	
NSYMR43	NSYMB43	24	NSYDLM24	-	NSYMD43	B	NSYMDVR4	-	400	300	150	
NSYMR43	NSYMB43	24	NSYDLM24	NSYDLA24G	NSYMD43	B	NSYMDVR4	-	400	300	200	
NSYMR44	-	-	-	-	-	-	NSYMDVR4	NSYTFPCR4	400	400	200	
NSYMR46	NSYMB64	-	-	-	-	-	NSYMDVR4	NSYTFPCR6	400	600	200	
NSYMR46	NSYMB64	-	-	-	-	-	NSYMDVR4	NSYTFPCR6	400	600	250	
NSYMR53	-	-	-	-	-	-	NSYMDVR5	-	500	300	200	
NSYMR54	NSYMB54	48	NSYDLM48	NSYDLA48G	NSYMD54	B	NSYMDVR5	NSYTFPCR4	500	400	200	
NSYMR54	NSYMB54	48	NSYDLM48	-	NSYMD54	B	NSYMDVR5	NSYTFPCR4	500	400	250	
NSYMR55	-	-	-	-	-	-	NSYMDVR5	NSYTFPCR5	500	500	200	
NSYMR55	-	-	-	-	-	-	NSYMDVR5	NSYTFPCR5	500	500	250	
NSYMR64	NSYMB64	48	NSYDLM48P	NSYDLA48PG	NSYMD64	B	NSYMDVR6	NSYTFPCR4	600	400	200	
NSYMR64	NSYMB64	48	NSYDLM48P	NSYDLA48PG	NSYMD64	B	NSYMDVR6	NSYTFPCR4	600	400	250	
NSYMR65	NSYMB65	-	-	-	-	-	NSYMDVR6	-	600	500	250	
NSYMR66	-	84	NSYDLM84P	-	NSYMD66	A	NSYMDVR6	NSYTFPCR6	600	600	200	
NSYMR66	-	84	NSYDLM84P	-	NSYMD66	A	NSYMDVR6	NSYTFPCR6	600	600	250	
NSYMR66	-	84	NSYDLM84P	-	NSYMD66	A	NSYMDVR6	NSYTFPCR6	600	600	300	
NSYMR66	-	84	NSYDLM84P	-	NSYMD66	A	NSYMDVR6	NSYTFPCR6	600	600	400	
NSYMR68	NSYMB86	-	-	-	NSYMD86	A	NSYMDVR6	NSYTFPCR8	600	800	300	
NSYMR75	NSYMB75	66	NSYDLM66	NSYDLA66G	NSYMD75	B	NSYMDVR7	NSYTFPCR5	700	500	250	
NSYMR86	NSYMB86	84 ⁽⁶⁾	NSYDLM84	NSYDLA84G / NSYDLA112G	NSYMD86	A	NSYMDVR8	NSYTFPCR6	800	600	200	
NSYMR86	NSYMB86	112 ⁽⁶⁾	NSYDLM112	NSYDLA84G / NSYDLA112G	NSYMD86	A	NSYMDVR8	NSYTFPCR6	800	600	250	
NSYMR86	NSYMB86	112 ⁽⁶⁾	NSYDLM112	NSYDLA84G / NSYDLA112G	NSYMD86	A	NSYMDVR8	NSYTFPCR6	800	600	300	
NSYMR86	NSYMB86	112 ⁽⁶⁾	NSYDLM112	NSYDLA84G / NSYDLA112G	NSYMD86	A	NSYMDVR8	NSYTFPCR6	800	600	400	
NSYMR88	-	-	-	-	-	-	NSYMDVR8	NSYTFPCR8	800	800	250	
NSYMR88	-	-	-	-	-	-	NSYMDVR8	NSYTFPCR8	800	800	300	
NSYMR810	NSYMB108	-	-	-	-	-	NSYMDVR8	NSYTFPCR10	800	1000	300	
NSYMR810	NSYMB108	-	-	-	-	-	NSYMDVR8	-	800	1000	300	
2x NSYMR86 ⁽⁴⁾	2x NSYMB86 ⁽⁴⁾	-	-	-	2x NSYMD86 ⁽⁴⁾	A	NSYMDVR8	-	800	1200	300	
NSYMR106	NSYMB106	168	NSYDLM168	-	-	-	NSYMDVR10	NSYTFPCR6	1000	600	250	
NSYMR106	NSYMB106	168	NSYDLM168	-	-	-	NSYMDVR10	NSYTFPCR6	1000	600	300	
NSYMR106	NSYMB106	168	NSYDLM168	-	-	-	NSYMDVR10	NSYTFPCR6	1000	600	400	
NSYMR108	NSYMB108	234	NSYDLM240	NSYDLA234G	NSYMD108	A	NSYMDVR10	NSYTFPCR8	1000	800	250	
NSYMR108	NSYMB108	234	NSYDLM240	NSYDLA234G	NSYMD108	A	NSYMDVR10	NSYTFPCR8	1000	800	300	
NSYMR108	NSYMB108	234	NSYDLM240	NSYDLA234G	NSYMD108	A	NSYMDVR10	NSYTFPCR8	1000	800	400	
NSYMR1012	-	-	-	-	-	-	NSYMDVR10	NSYTFPCR10	1000	1000	300	
NSYMR1012	-	-	-	-	-	-	NSYMDVR10	-	1000	1000	300	
NSYMR1012	NSYMB1210	-	-	-	-	-	NSYMDVR10	-	1000	1200	300	
NSYMR1012	NSYMB1210	-	-	-	-	-	NSYMDVR10	-	1000	1200	400	
-	-	-	-	-	-	-	NSYMDVR12	-	1200	600	300	
-	-	-	-	-	-	-	NSYMDVR12	-	1200	600	400	
NSYMR128	-	-	-	-	NSYMD128	A	NSYMDVR12	NSYTFPCR8	1200	800	300	
NSYMR128	-	-	-	-	NSYMD128	A	NSYMDVR12	NSYTFPCR8	1200	800	400	
NSYMR1210	NSYMB1210	-	-	-	-	-	NSYMDVR12	NSYTFPCR10	1200	1000	300	
NSYMR1210	NSYMB1210	-	-	-	-	-	NSYMDVR12	-	1200	1000	300	
NSYMR1210	NSYMB1210	-	-	-	-	-	NSYMDVR12	-	1200	1000	400	
2x NSYMR126 ⁽⁴⁾	-	-	-	-	-	-	NSYMDVR12	-	1200	1200	300	
2x NSYMR126 ⁽⁴⁾	-	-	-	-	-	-	NSYMDVR12	-	1200	1200	400	
NSYMR1410	-	-	-	-	-	-	-	-	1400	1000	300	

Wall fixing lugs: [Page 57](#)
 Steel: **NSYAEFPFSC**
 Stainless-steel: **NSYAEFPFXSC**

Reinforcement for heavy loads: [Page 57](#)
NSYAEFAHLBSC
 Locking accessories: [Page 63](#)

Door accessories: [Page 318](#)
 Clip-on nuts: [Page 290](#)
 Self-tapping screw: **NSYS13M5HS** / [Page 291](#)

Applicative and Customized Solutions













Dimensions			Doors	IP	Basic enclosures Empty application enclosures		Basic enclosures 19" enclosure with glazed door (Plain door, please consult us.)					
Height (mm)	Width (mm)	Depth (mm)			S3DB terminal enclosures	S3DM modular enclosures with glazed door	VDM steel enclosures with 19" swing rack	No. of U	1-body 19" fixed rack	No. of U	2 parts with 19" fixed rack	No. of U
200	300	150	1	66	-	-	-	-	-	-	-	
250	300	150	1	66	NSYS3DB25315	-	-	-	-	-	-	
250	400	150	1	66	NSYS3DB25415	-	-	-	-	-	-	
250	500	150	1	66	NSYS3DB25515	-	-	-	-	-	-	
300	300	150	1	66	NSYS3DB3315	-	-	-	-	-	-	
300	300	170	1	66	-	-	-	-	-	-	-	
300	400	150	1	66	NSYS3DB3415	-	-	-	-	-	-	
300	400	170	1	66	-	-	-	-	-	-	-	
300	500	150	1	66	NSYS3DB3515	-	-	-	-	-	-	
300	500	200	1	66	-	-	-	-	-	-	-	
300	600	150	1	66	NSYS3DB3615	-	-	-	-	-	-	
300	600	400	1	66	-	-	NSYVDM4U4P	4	NSYVDM5U4F	5	NSYVD2M5U4	
300	600	500	1	66	-	-	-	-	-	-	NSYVD2M5U5	
400	300	150	1	66	NSYS3DB4315	NSYS3DM4315T	-	-	-	-	-	
400	300	170	1	66	-	-	-	-	-	-	-	
400	600	400	1	66	-	-	NSYVDM7U4P	7	NSYVDM8U4F	8	NSYVD2M8U4	
400	600	500	1	66	-	-	-	-	-	-	NSYVD2M8U5	
400	800	150	1	66	NSYS3DB4815	-	-	-	-	-	-	
500	400	150	1	66	NSYS3DB5415	NSYS3DM5415T	-	-	-	-	-	
500	600	400	1	66	-	-	NSYVDM9U4P	9	NSYVDM10U4F	10	NSYVD2M10U4	
500	600	500	1	66	-	-	-	-	-	-	NSYVD2M10U5	
600	400	150	1	66	NSYS3DB6415	NSYS3DM6415T	-	-	-	-	-	
600	600	150	1	66	-	NSYS3DM6615T	-	-	-	-	-	
700	500	150	1	66	-	-	-	-	-	-	-	
700	500	150	1	66	-	NSYS3DM7515T	-	-	-	-	-	
700	600	400	1	66	-	-	NSYVDM13U4P	13	NSYVDM14U4F	14	NSYVD2M14U4	
700	600	500	1	66	-	-	-	-	-	-	NSYVD2M14U5	
800	600	150	1	66	-	-	-	-	-	-	-	
800	600	150	1	66	-	NSYS3DM8615T	-	-	-	-	-	
800	600	400	1	66	-	-	NSYVDM16U4P	16	NSYVDM17U4F	17	NSYVD2M17U4	
800	600	500	1	66	-	-	-	-	-	-	NSYVD2M17U5	
1000	600	150	1	66	-	NSYS3DM10615T	-	-	-	-	-	
1000	800	150	1	66	-	NSYS3DM10815T	-	-	-	-	-	
Details					see page 345		see page 348		see page 469		see page 469	

Wall fixing lugs: [Page 57](#)
 Steel: **NSYAEFPFSC**
 Stainless-steel: **NSYAEFPFXSC**

Reinforcement for heavy loads: [Page 57](#)
NSYAEFAHLBSC
 Locking accessories: [Page 63](#)

Door accessories: [Page 318](#)
 Clip-on nuts: [Page 290](#)
 Self-tapping screw: **NSYS13M5HS** / [Page 291](#)

Accessories Electricity distribution		Accessories Automatism							
									
Modular mounting chassis (metal)	No. of modul	DIN rail support and DIN rail	Plain mounting plate	Telequick mounting plate	Aluminum vertical rails	Dimensions			
						Height (mm)	Width (mm)	Depth (mm)	
-	-	NSYAMRD2030	NSYMM32	-	-	200	300	150	
-	-	NSYAMRD2530	NSYMM3025	-	-	250	300	150	
-	-	NSYAMRD2540	NSYMM2540	-	-	250	400	150	
-	-	NSYAMRD2550	NSYMM2550	-	-	250	500	150	
-	-	NSYAMRD3030	NSYMM33	NSYMR33	NSYMDVR3	300	300	150	
-	-	NSYAMRD3030	NSYMM33	NSYMR33	-	300	300	170	
-	-	NSYAMRD3040	NSYMM43	NSYMR34	NSYMDVR3	300	400	150	
-	-	NSYAMRD3040	NSYMM43	NSYMR34	-	300	400	170	
-	-	NSYAMRD3050	NSYMM53	-	NSYMDVR3	300	500	150	
-	-	NSYAMRD3050	NSYMM53	-	NSYMDVR3	300	500	200	
-	-	NSYAMRD36	NSYMM36	-	NSYMDVR3	300	600	150	
-	-	NSYAMRD36	NSYMM36	-	NSYMDVR3	300	600	400	
-	-	NSYAMRD36	NSYMM36	-	NSYMDVR3	300	600	500	
NSYDLM24	24	NSYAMRD43	NSYMM43	NSYMR43	NSYMDVR4	400	300	150	
-	-	NSYAMRD43	NSYMM43	NSYMR43	-	400	300	170	
-	-	-	NSYMM64	NSYMR46	NSYMDVR4	400	600	400	
-	-	NSYAMRD48	NSYMM64	NSYMR46	NSYMDVR4	400	600	500	
-	-	NSYAMRD54	NSYMM48	-	NSYMDVR4	400	800	150	
NSYDLM48	48	-	NSYMM54	NSYMR54	NSYMDVR5	500	400	150	
-	-	-	NSYMM65	-	NSYMDVR5	500	600	400	
-	-	-	NSYMM65	-	NSYMDVR5	500	600	500	
NSYDLM48P	48	NSYAMRD64	NSYMM64	NSYMR64	NSYMDVR6	600	400	150	
NSYDLM84P	84	-	NSYMM66	NSYMR66	NSYMDVR6	600	600	150	
NSYDLM66	66	-	NSYMM75	NSYMR75	NSYMDVR7	700	500	150	
NSYDLM88	88	-	NSYMM75	NSYMR75	NSYMDVR7	700	500	150	
-	-	-	NSYMM76	NSYMR76	NSYMDVR7	700	600	400	
-	-	-	NSYMM76	NSYMR76	NSYMDVR7	700	600	500	
NSYDLM84	84	-	NSYMM86	NSYMR86	NSYMDVR8	800	600	150	
NSYDLM112	112	-	NSYMM86	NSYMR86	NSYMDVR8	800	600	150	
-	-	-	NSYMM86	NSYMR86	NSYMDVR8	800	600	400	
-	-	-	NSYMM86	NSYMR86	NSYMDVR8	800	600	500	
NSYDLM168	168	-	NSYMM106	NSYMR106	NSYMDVR10	1000	600	150	
NSYDLM240	234	-	NSYMM108	NSYMR108	NSYMDVR10	1000	800	150	
see page 349					see page 260		see page 264		

Dimensions				Enclosures			Plinth (H 100 mm)	
Height (mm)	Width (mm)	Depth (mm)	Doors					
				Plain door, without mounting plate	Plain door, with mounting plate	Transparent door, without mounting plate	Front kit (corners + front panels)	Side panels, 2 u.
1200	800	300	1	NSYSM12830	NSYSM12830P	-	NSYSPPF8100	NSYSPPS3100
1200	1000	300	2	NSYSM1210302D	NSYSM1210302DP	-	NSYSPPF10100	NSYSPPS3100
1200	1200	400	2	NSYSM1212402D	NSYSM1212402DP	-	NSYSPPF12100	NSYSPPS4100
1400	600	300	1	NSYSM14630	NSYSM14630P	-	NSYSPPF6100	NSYSPPS3100
1400	600	400	1	NSYSM14640	NSYSM14640P	-	NSYSPPF6100	NSYSPPS4100
1400	800	300	1	NSYSM14830	NSYSM14830P	-	NSYSPPF8100	NSYSPPS3100
1400	800	400	1	NSYSM14840	NSYSM14840P	NSYSM14840T	NSYSPPF8100	NSYSPPS4100
1400	1000	400	2	NSYSM1410402D	NSYSM1410402DP	-	NSYSPPF10100	NSYSPPS4100
1400	1200	400	2	NSYSM1412402D	NSYSM1412402DP	-	NSYSPPF12100	NSYSPPS4100
1600	600	300	1	NSYSM16630	NSYSM16630P	-	NSYSPPF6100	NSYSPPS3100
1600	600	400	1	NSYSM16640	NSYSM16640P	NSYSM16640T	NSYSPPF6100	NSYSPPS4100
1600	800	300	1	NSYSM16830	NSYSM16830P	NSYSM16830T	NSYSPPF8100	NSYSPPS3100
1600	800	400	1	NSYSM16840	NSYSM16840P	NSYSM16840T	NSYSPPF8100	NSYSPPS4100
1600	1000	300	2	NSYSM1610302D	NSYSM1610302DP	-	NSYSPPF10100	NSYSPPS3100
1600	1000	400	2	NSYSM1610402D	NSYSM1610402DP	-	NSYSPPF10100	NSYSPPS4100
1600	1200	300	2	NSYSM1612302D	NSYSM1612302DP	-	NSYSPPF12100	NSYSPPS3100
1600	1200	400	2	NSYSM1612402D	NSYSM1612402DP	-	NSYSPPF12100	NSYSPPS4100
1800	600	300	1	NSYSM18630	NSYSM18630P	-	NSYSPPF6100	NSYSPPS3100
1800	600	400	1	NSYSM18640	NSYSM18640P	NSYSM18640T	NSYSPPF6100	NSYSPPS4100
1800	600	500	1	NSYSM18650	NSYSM18650P	-	NSYSPPF6100	NSYSPPS5100
1800	800	300	1	NSYSM18830	NSYSM18830P	NSYSM18830T	NSYSPPF8100	NSYSPPS3100
1800	800	400	1	NSYSM18840	NSYSM18840P	NSYSM18840T	NSYSPPF8100	NSYSPPS4100
1800	800	500	1	NSYSM18850	NSYSM18850P	NSYSM18850T	NSYSPPF8100	NSYSPPS5100
1800	800	600	1	NSYSM18860	NSYSM18860P	-	NSYSPPF8100	NSYSPPS6100
1800	1000	400	1	NSYSM181040	NSYSM181040P	-	NSYSPPF10100	NSYSPPS4100
1800	1000	400	2	NSYSM1810402D	NSYSM1810402DP	-	NSYSPPF10100	NSYSPPS4100
1800	1000	500	2	NSYSM1810502D	NSYSM1810502DP	-	NSYSPPF10100	NSYSPPS5100
1800	1200	400	2	NSYSM1812402D	NSYSM1812402DP	-	NSYSPPF12100	NSYSPPS4100
1800	1200	500	2	NSYSM1812502D	NSYSM1812502DP	-	NSYSPPF12100	NSYSPPS5100
1800	1600	400	2	NSYSM1816402D	NSYSM1816402DP	-	NSYSPPF16100	NSYSPPS4100
1800	1600	500	2	NSYSM1816502D	NSYSM1816502DP	-	NSYSPPF16100	NSYSPPS5100
2000	600	300	1	NSYSM20630	NSYSM20630P	-	NSYSPPF6100	NSYSPPS3100
2000	600	400	1	NSYSM20640	NSYSM20640P	NSYSM20640T	NSYSPPF6100	NSYSPPS4100
2000	600	500	1	NSYSM20650	NSYSM20650P	-	NSYSPPF6100	NSYSPPS5100
2000	800	300	1	NSYSM20830	NSYSM20830P	NSYSM20830T	NSYSPPF8100	NSYSPPS3100
2000	800	400	1	NSYSM20840	NSYSM20840P	NSYSM20840T	NSYSPPF8100	NSYSPPS4100
2000	800	500	1	NSYSM20850	NSYSM20850P	NSYSM20850T	NSYSPPF8100	NSYSPPS5100
2000	800	600	1	NSYSM20860	NSYSM20860P	NSYSM20860T	NSYSPPF8100	NSYSPPS6100
2000	1000	400	2	NSYSM2010402D	NSYSM2010402DP	-	NSYSPPF10100	NSYSPPS4100
2000	1000	500	2	NSYSM2010502D	NSYSM2010502DP	-	NSYSPPF10100	NSYSPPS5100
2000	1200	400	2	NSYSM2012402D	NSYSM2012402DP	-	NSYSPPF12100	NSYSPPS4100
2000	1200	500	2	NSYSM2012502D	NSYSM2012502DP	-	NSYSPPF12100	NSYSPPS5100
2000	1200	600	2	NSYSM2012602D	NSYSM2012602DP	-	NSYSPPF12100	NSYSPPS6100
2000	1600	400	2	NSYSM2016402D	NSYSM2016402DP	-	NSYSPPF16100	NSYSPPS4100
2000	1600	500	2	NSYSM2016502D	NSYSM2016502DP	-	NSYSPPF16100	NSYSPPS5100
2000	1600	600	2	NSYSM2016602D	NSYSM2016602DP	-	NSYSPPF16100	NSYSPPS6100

Plinth (H 200 mm)		Inner door	Mounting plate	Vertical uprights		19" swing rack		Dimensions		
Front kit (corners + front panels)	Side panels, 4 u.	Plain door	Galvanized	Standard	Technical	Off-center	Centered	Height (mm)	Width (mm)	Depth (mm)
NSYSPF8200	NSYSPS3200	-	NSYMP128	-	NSYTVR12	-	-	1200	800	300
NSYSPF10200	NSYSPS3200	-	NSYMP1210	-	NSYTVR12	-	-	1200	1000	300
NSYSPF12200	NSYSPS4200	-	NSYMP1212	-	NSYTVR12	-	-	1200	1200	400
NSYSPF6200	NSYSPS3200	-	NSYMP146	-	NSYTVR14	-	-	1400	600	300
NSYSPF6200	NSYSPS4200	-	NSYMP146	-	NSYTVR14	-	-	1400	600	400
NSYSPF8200	NSYSPS3200	-	NSYMP148	-	NSYTVR14	NSYRSW27	NSYRSWC27	1400	800	300
NSYSPF8200	NSYSPS4200	-	NSYMP148	-	NSYTVR14	NSYRSW27	NSYRSWC27	1400	800	400
NSYSPF10200	NSYSPS4200	-	NSYMP1410	-	NSYTVR14	-	-	1400	1000	400
NSYSPF12200	NSYSPS4200	-	NSYMP1412	-	NSYTVR14	-	-	1400	1200	400
NSYSPF6200	NSYSPS3200	NSYID166	NSYMP166	-	NSYTVR16	-	-	1600	600	300
NSYSPF6200	NSYSPS4200	NSYID166	NSYMP166	-	NSYTVR16	-	-	1600	600	400
NSYSPF8200	NSYSPS3200	NSYID168	NSYMP168	-	NSYTVR16	NSYRSW31	NSYRSWC31	1600	800	300
NSYSPF8200	NSYSPS4200	NSYID168	NSYMP168	-	NSYTVR16	NSYRSW31	NSYRSWC31	1600	800	400
NSYSPF10200	NSYSPS3200	-	NSYMP1610	-	NSYTVR16	-	-	1600	1000	300
NSYSPF10200	NSYSPS4200	-	NSYMP1610	-	NSYTVR16	-	-	1600	1000	400
NSYSPF12200	NSYSPS3200	-	NSYMP1612	-	NSYTVR16	-	-	1600	1200	300
NSYSPF12200	NSYSPS4200	-	NSYMP1612	-	NSYTVR16	-	-	1600	1200	400
NSYSPF6200	NSYSPS3200	NSYID186	NSYMP186	NSYVR18	NSYTVR18	-	-	1800	600	300
NSYSPF6200	NSYSPS4200	NSYID186	NSYMP186	NSYVR18	NSYTVR18	-	-	1800	600	400
NSYSPF6200	NSYSPS5200	NSYID186	NSYMP186	NSYVR18	NSYTVR18	-	-	1800	600	500
NSYSPF8200	NSYSPS3200	NSYID188	NSYMP188	NSYVR18	NSYTVR18	NSYRSW36	NSYRSWC36	1800	800	300
NSYSPF8200	NSYSPS4200	NSYID188	NSYMP188	NSYVR18	NSYTVR18	NSYRSW36	NSYRSWC36	1800	800	400
NSYSPF8200	NSYSPS5200	NSYID188	NSYMP188	NSYVR18	NSYTVR18	NSYRSW36	NSYRSWC36	1800	800	500
NSYSPF8200	NSYSPS6200	NSYID188	NSYMP188	NSYVR18	NSYTVR18	NSYRSW36	NSYRSWC36	1800	800	600
NSYSPF10200	NSYSPS4200	NSYID1810	NSYMP1810	NSYVR18	NSYTVR18	-	-	1800	1000	400
NSYSPF10200	NSYSPS4200	NSYID1810	NSYMP1810	NSYVR18	NSYTVR18	-	-	1800	1000	400
NSYSPF10200	NSYSPS5200	NSYID1810	NSYMP1810	NSYVR18	NSYTVR18	-	-	1800	1000	500
NSYSPF12200	NSYSPS4200	-	NSYMP1812	NSYVR18	NSYTVR18	-	-	1800	1200	400
NSYSPF12200	NSYSPS5200	-	NSYMP1812	NSYVR18	NSYTVR18	-	-	1800	1200	500
NSYSPF16200	NSYSPS4200	-	NSYMP1816	NSYVR18	NSYTVR18	-	-	1800	1600	400
NSYSPF16200	NSYSPS5200	-	NSYMP1816	NSYVR18	NSYTVR18	-	-	1800	1600	500
NSYSPF6200	NSYSPS3200	NSYID206	NSYMP206	NSYVR20	NSYTVR20	-	-	2000	600	300
NSYSPF6200	NSYSPS4200	NSYID206	NSYMP206	NSYVR20	NSYTVR20	-	-	2000	600	400
NSYSPF6200	NSYSPS5200	NSYID206	NSYMP206	NSYVR20	NSYTVR20	-	-	2000	600	500
NSYSPF8200	NSYSPS3200	NSYID208	NSYMP208	NSYVR20	NSYTVR20	NSYRSW40	NSYRSWC40	2000	800	300
NSYSPF8200	NSYSPS4200	NSYID208	NSYMP208	NSYVR20	NSYTVR20	NSYRSW40	NSYRSWC40	2000	800	400
NSYSPF8200	NSYSPS5200	NSYID208	NSYMP208	NSYVR20	NSYTVR20	NSYRSW40	NSYRSWC40	2000	800	500
NSYSPF8200	NSYSPS6200	NSYID208	NSYMP208	NSYVR20	NSYTVR20	NSYRSW40	NSYRSWC40	2000	800	600
NSYSPF10200	NSYSPS4200	NSYID2010	NSYMP2010	NSYVR20	NSYTVR20	-	-	2000	1000	400
NSYSPF10200	NSYSPS5200	NSYID2010	NSYMP2010	NSYVR20	NSYTVR20	-	-	2000	1000	500
NSYSPF12200	NSYSPS4200	-	NSYMP2012	NSYVR20	NSYTVR20	-	-	2000	1200	400
NSYSPF12200	NSYSPS5200	-	NSYMP2012	NSYVR20	NSYTVR20	-	-	2000	1200	500
NSYSPF12200	NSYSPS6200	-	NSYMP2012	NSYVR20	NSYTVR20	-	-	2000	1200	600
NSYSPF16200	NSYSPS4200	-	NSYMP2016	NSYVR20	NSYTVR20	-	-	2000	1600	400
NSYSPF16200	NSYSPS5200	-	NSYMP2016	NSYVR20	NSYTVR20	-	-	2000	1600	500
NSYSPF16200	NSYSPS6200	-	NSYMP2016	NSYVR20	NSYTVR20	-	-	2000	1600	600

Technical changes reserved. Information provided without guarantee. Images are for illustrative purposes only.

SF Steel Floor-Standing Enclosures

Dimensions			Enclosures				Side panels	Cable entry plates		
			Doors	Plain door, without mounting plate	Plain door, with mounting plate	Transparent door, without mounting plate	Plain	Plain	1 entry	2 entries
(A) Height (mm)	(B) Width (mm)	(C) Depth (mm)								
1200	600	400	1	NSYSF12640	NSYSF12640P	-	NSY2SP124	NSYEC64	NSYEC641	-
1200	600	600	1	NSYSF12660	NSYSF12660P	-	NSY2SP126	NSYEC66	NSYEC661	NSYEC662
1200	800	400	1	NSYSF12840	NSYSF12840P	-	NSY2SP124	NSYEC84	NSYEC841	-
1200	800	600	1	NSYSF12860	NSYSF12860P	-	NSY2SP126	NSYEC86	NSYEC861	NSYEC862
1400	600	400	1	NSYSF14640	NSYSF14640P	-	NSY2SP144	NSYEC64	NSYEC641	-
1400	800	400	1	NSYSF14840	NSYSF14840P	-	NSY2SP144	NSYEC84	NSYEC841	-
1600	600	600	1	NSYSF16660	NSYSF16660P	-	NSY2SP166	NSYEC66	NSYEC661	NSYEC662
1600	600	800	1	NSYSF16680	NSYSF16680P	-	NSY2SP168	NSYEC68	NSYEC681	NSYEC682
1600	800	600	1	NSYSF16860	NSYSF16860P	-	NSY2SP166	NSYEC86	NSYEC861	NSYEC862
1600	800	800	1	NSYSF16880	NSYSF16880P	-	NSY2SP168	NSYEC88	NSYEC881	NSYEC882
1800	400	400	1	NSYSF18440	-	-	NSY2SP184	NSYEC44	NSYEC441	-
1800	400	500	1	NSYSF18450	-	-	NSY2SP185	NSYEC45	NSYEC451	-
1800	400	600	1	NSYSF18460	-	-	NSY2SP186	-	NSYEC461	NSYEC462
1800	600	400	1	NSYSF18640	NSYSF18640P	NSYSF18640T	NSY2SP184	NSYEC64	NSYEC641	-
1800	600	500	1	NSYSF18650	NSYSF18650P	NSYSF18650T	NSY2SP185	NSYEC65	NSYEC651	-
1800	600	600	1	NSYSF18660	NSYSF18660P	-	NSY2SP186	NSYEC66	NSYEC661	NSYEC662
1800	600	800	1	-	-	NSYSF18680T	NSY2SP188	NSYEC68	NSYEC681	NSYEC682
1800	800	400	1	NSYSF18840	NSYSF18840P	NSYSF18840T	NSY2SP184	NSYEC84	NSYEC841	-
1800	800	500	1	NSYSF18850	NSYSF18850P	NSYSF18850T	NSY2SP185	NSYEC85	NSYEC851	-
1800	800	600	1	NSYSF18860	NSYSF18860P	NSYSF18860T	NSY2SP186	NSYEC86	NSYEC861	NSYEC862
1800	800	600	2	NSYSF188602D	NSYSF188602DP	-	NSY2SP186	NSYEC86	NSYEC861	NSYEC862
1800	1000	400	1	NSYSF181040	NSYSF181040P	-	NSY2SP184	NSYEC104	NSYEC1041	-
1800	1000	400	2	NSYSF1810402D	NSYSF1810402DP	-	NSY2SP184	NSYEC104	NSYEC1041	-
1800	1000	500	1	NSYSF181050	NSYSF181050P	-	NSY2SP185	NSYEC105	NSYEC1051	-
1800	1000	600	1	NSYSF181060	NSYSF181060P	-	NSY2SP186	NSYEC106	NSYEC1061	NSYEC1062
1800	1000	600	2	NSYSF1810602D	NSYSF1810602DP	-	NSY2SP186	NSYEC106	NSYEC1061	NSYEC1062
1800	1200	400	2	NSYSF1812402D	NSYSF1812402DP	-	NSY2SP184	NSYEC124	NSYEC1241	-
1800	1200	500	2	NSYSF1812502D	NSYSF1812502DP	-	NSY2SP185	NSYEC125	NSYEC1251	-
1800	1200	600	2	NSYSF1812602D	NSYSF1812602DP	-	NSY2SP186	NSYEC126	NSYEC1261	NSYEC1262
2000	300	500	1	NSYSF20350	-	-	NSY2SP205	NSYEC35	NSYEC351	-
2000	300	600	1	NSYSF20360	-	-	NSY2SP206	NSYEC36	NSYEC361	-
2000	300	800	1	NSYSF20380	-	-	NSY2SP208	-	NSYEC381	-
2000	400	400	1	NSYSF20440	-	-	NSY2SP204	NSYEC44	NSYEC441	-
2000	400	500	1	NSYSF20450	-	-	NSY2SP205	NSYEC45	NSYEC451	-
2000	400	600	1	NSYSF20460	-	-	NSY2SP206	NSYEC64	NSYEC461	NSYEC462
2000	400	800	1	NSYSF20480	-	-	NSY2SP208	NSYEC84	NSYEC481	NSYEC482
2000	600	400	1	NSYSF20640	NSYSF20640P	NSYSF20640T	NSY2SP204	NSYEC64	NSYEC641	-
2000	600	500	1	NSYSF20650	NSYSF20650P	NSYSF20650T	NSY2SP205	NSYEC65	NSYEC651	-
2000	600	600	1	NSYSF20660	NSYSF20660P	-	NSY2SP206	NSYEC66	NSYEC661	NSYEC662
2000	600	800	1	NSYSF20680	NSYSF20680P	-	NSY2SP208	NSYEC68	NSYEC681	NSYEC682
2000	800	400	1	NSYSF20840	NSYSF20840P	NSYSF20840T	NSY2SP204	NSYEC84	NSYEC841	-
2000	800	500	1	NSYSF20850	NSYSF20850P	NSYSF20850T	NSY2SP205	NSYEC85	NSYEC851	-
2000	800	600	1	NSYSF20860	NSYSF20860P	NSYSF20860T	NSY2SP206	NSYEC86	NSYEC861	NSYEC862
2000	800	600	2	NSYSF208602D	NSYSF208602DP	-	NSY2SP206	NSYEC86	NSYEC861	NSYEC862
2000	800	800	1	NSYSF20880	NSYSF20880P	NSYSF20880T	NSY2SP208	NSYEC88	NSYEC881	NSYEC882
2000	1000	400	1	NSYSF201040	NSYSF201040P	NSYSF201040T	NSY2SP204	NSYEC104	NSYEC1041	-
2000	1000	400	2	NSYSF2010402D	NSYSF2010402DP	-	NSY2SP204	NSYEC104	NSYEC1041	-
2000	1000	500	1	NSYSF201050	NSYSF201050P	NSYSF201050T	NSY2SP205	NSYEC105	NSYEC1051	-
2000	1000	500	2	NSYSF2010502D	NSYSF2010502DP	-	NSY2SP205	NSYEC105	NSYEC1051	-
2000	1000	600	1	NSYSF201060	NSYSF201060P	NSYSF201060T	NSY2SP206	NSYEC106	NSYEC1061	NSYEC1062
2000	1000	600	2	NSYSF2010602D	NSYSF2010602DP	-	NSY2SP206	NSYEC106	NSYEC1061	NSYEC1062
2000	1000	800	1	NSYSF201080	NSYSF201080P	-	NSY2SP208	NSYEC108	NSYEC1081	NSYEC1082
2000	1200	400	2	NSYSF2012402D	NSYSF2012402DP	-	NSY2SP204	NSYEC124	NSYEC1241	-
2000	1200	500	2	NSYSF2012502D	NSYSF2012502DP	-	NSY2SP205	NSYEC125	NSYEC1251	-
2000	1200	600	2	NSYSF2012602D	NSYSF2012602DP	-	NSY2SP206	NSYEC126	NSYEC1261	NSYEC1262
2000	1200	800	2	NSYSF2012802D	NSYSF2012802DP	-	NSY2SP208	NSYEC128	NSYEC1281	NSYEC1282
2000	1600	400	2	NSYSF2016402D	NSYSF2016402DP	-	NSY2SP204	NSYEC164	NSYEC1641	-
2000	1600	500	2	NSYSF2016502D	NSYSF2016502DP	-	NSY2SP205	NSYEC165	NSYEC1651	-
2000	1600	600	2	NSYSF2016602D	NSYSF2016602DP	-	NSY2SP206	NSYEC166	NSYEC1661	NSYEC1662
2200	400	600	1	NSYSF22460	-	-	NSY2SP226	-	NSYEC461	-
2200	600	600	1	NSYSF22660	NSYSF22660P	-	NSY2SP226	NSYEC66	NSYEC661	NSYEC662
2200	600	800	1	NSYSF22680	NSYSF22680P	-	NSY2SP228	NSYEC68	NSYEC681	NSYEC682
2200	800	600	1	NSYSF22860	NSYSF22860P	-	NSY2SP226	NSYEC86	NSYEC861	NSYEC862
2200	800	800	1	NSYSF22880	NSYSF22880P	NSYSF22880T	NSY2SP228	NSYEC88	NSYEC881	NSYEC882
2200	1000	600	1	NSYSF221060	NSYSF221060P	-	NSY2SP226	NSYEC106	NSYEC1061	NSYEC1062
2200	1200	600	2	NSYSF2212602D	NSYSF2212602DP	-	NSY2SP226	NSYEC126	NSYEC1261	NSYEC1262
2200	1200	800	2	NSYSF2212802D	NSYSF2212802DP	-	NSY2SP228	NSYEC128	NSYEC1281	NSYEC1282

Technical changes reserved. Information provided without guarantee. Images are for illustrative purposes only.

Plinths (H 100 mm)		Plinths (H 200 mm)		Mounting plates		Vertical uprights		Dimensions		
								(A)	(B)	(C)
Front kit (corners + front panels)	Side panels, 2 u.	Front kit (corners + front panels)	Side panels, 4 u.	Mounting plate	Intermediate mounting plate	Standard	Technical	Height (mm)	Width (mm)	Depth (mm)
NSYSPF6100	NSYSPS4100	NSYSPF6200	NSYSPS4200	NSYMP126	NSYSIMP12	-	NSYTVR12	1200	600	400
NSYSPF6100	NSYSPS6100	NSYSPF6200	NSYSPS6200	NSYMP126	NSYSIMP12	-	NSYTVR12	1200	600	600
NSYSPF8100	NSYSPS4100	NSYSPF8200	NSYSPS4200	NSYMP128	NSYSIMP12	-	NSYTVR12	1200	800	400
NSYSPF8100	NSYSPS6100	NSYSPF8200	NSYSPS6200	NSYMP128	NSYSIMP12	-	NSYTVR12	1200	800	600
NSYSPF6100	NSYSPS4100	NSYSPF6200	NSYSPS4200	NSYMP146	NSYSIMP14	-	NSYTVR14	1400	600	400
NSYSPF8100	NSYSPS4100	NSYSPF8200	NSYSPS4200	NSYMP148	NSYSIMP14	-	NSYTVR14	1400	800	400
NSYSPF6100	NSYSPS6100	NSYSPF6200	NSYSPS6200	NSYMP166	NSYSIMP16	-	NSYTVR16	1600	600	600
NSYSPF6100	NSYSPS8100	NSYSPF6200	NSYSPS8200	NSYMP166	NSYSIMP16	-	NSYTVR16	1600	600	800
NSYSPF8100	NSYSPS6100	NSYSPF8200	NSYSPS6200	NSYMP168	NSYSIMP16	-	NSYTVR16	1600	800	600
NSYSPF8100	NSYSPS8100	NSYSPF8200	NSYSPS8200	NSYMP168	NSYSIMP16	-	NSYTVR16	1600	800	800
NSYSPF4100	NSYSPS4100	NSYSPF4200	NSYSPS4200	NSYMP184	NSYSIMP18	NSYVR18	NSYTVR18	1800	400	400
NSYSPF4100	NSYSPS5100	NSYSPF4200	NSYSPS5200	NSYMP184	NSYSIMP18	NSYVR18	NSYTVR18	1800	400	500
NSYSPF4100	NSYSPS6100	NSYSPF4200	NSYSPS6200	NSYMP184	NSYSIMP18	NSYVR18	NSYTVR18	1800	400	600
NSYSPF6100	NSYSPS4100	NSYSPF6200	NSYSPS4200	NSYMP186	NSYSIMP18	NSYVR18	NSYTVR18	1800	600	400
NSYSPF6100	NSYSPS5100	NSYSPF6200	NSYSPS5200	NSYMP186	NSYSIMP18	NSYVR18	NSYTVR18	1800	600	500
NSYSPF6100	NSYSPS6100	NSYSPF6200	NSYSPS6200	NSYMP186	NSYSIMP18	NSYVR18	NSYTVR18	1800	600	600
NSYSPF6100	NSYSPS8100	NSYSPF6200	NSYSPS8200	NSYMP186	NSYSIMP18	NSYVR18	NSYTVR18	1800	600	800
NSYSPF8100	NSYSPS4100	NSYSPF8200	NSYSPS4200	NSYMP188	NSYSIMP18	NSYVR18	NSYTVR18	1800	800	400
NSYSPF8100	NSYSPS5100	NSYSPF8200	NSYSPS5200	NSYMP188	NSYSIMP18	NSYVR18	NSYTVR18	1800	800	500
NSYSPF8100	NSYSPS6100	NSYSPF8200	NSYSPS6200	NSYMP188	NSYSIMP18	NSYVR18	NSYTVR18	1800	800	600
NSYSPF8100	NSYSPS8100	NSYSPF8200	NSYSPS8200	NSYMP188	NSYSIMP18	NSYVR18	NSYTVR18	1800	800	800
NSYSPF10100	NSYSPS4100	NSYSPF10200	NSYSPS4200	NSYMP1810	NSYSIMP18	NSYVR18	NSYTVR18	1800	1000	400
NSYSPF10100	NSYSPS5100	NSYSPF10200	NSYSPS5200	NSYMP1810	NSYSIMP18	NSYVR18	NSYTVR18	1800	1000	500
NSYSPF10100	NSYSPS6100	NSYSPF10200	NSYSPS6200	NSYMP1810	NSYSIMP18	NSYVR18	NSYTVR18	1800	1000	600
NSYSPF10100	NSYSPS8100	NSYSPF10200	NSYSPS8200	NSYMP1810	NSYSIMP18	NSYVR18	NSYTVR18	1800	1000	800
NSYSPF12100	NSYSPS4100	NSYSPF12200	NSYSPS4200	NSYMP1812	NSYSIMP18	NSYVR18	NSYTVR18	1800	1200	400
NSYSPF12100	NSYSPS5100	NSYSPF12200	NSYSPS5200	NSYMP1812	NSYSIMP18	NSYVR18	NSYTVR18	1800	1200	500
NSYSPF12100	NSYSPS6100	NSYSPF12200	NSYSPS6200	NSYMP1812	NSYSIMP18	NSYVR18	NSYTVR18	1800	1200	600
NSYSPF3100	NSYSPS5100	NSYSPF3200	NSYSPS5200	-	-	NSYVR20	NSYTVR20	2000	300	500
NSYSPF3100	NSYSPS6100	NSYSPF3200	NSYSPS6200	-	-	NSYVR20	NSYTVR20	2000	300	600
NSYSPF3100	NSYSPS8100	NSYSPF3200	NSYSPS8200	-	-	NSYVR20	NSYTVR20	2000	300	800
NSYSPF4100	NSYSPS4100	NSYSPF4200	NSYSPS4200	NSYMP204	NSYSIMP20	NSYVR20	NSYTVR20	2000	400	400
NSYSPF4100	NSYSPS5100	NSYSPF4200	NSYSPS5200	NSYMP204	NSYSIMP20	NSYVR20	NSYTVR20	2000	400	500
NSYSPF4100	NSYSPS6100	NSYSPF4200	NSYSPS6200	NSYMP204	NSYSIMP20	NSYVR20	NSYTVR20	2000	400	600
NSYSPF4100	NSYSPS8100	NSYSPF4200	NSYSPS8200	NSYMP204	NSYSIMP20	NSYVR20	NSYTVR20	2000	400	800
NSYSPF6100	NSYSPS4100	NSYSPF6200	NSYSPS4200	NSYMP206	NSYSIMP20	NSYVR20	NSYTVR20	2000	600	400
NSYSPF6100	NSYSPS5100	NSYSPF6200	NSYSPS5200	NSYMP206	NSYSIMP20	NSYVR20	NSYTVR20	2000	600	500
NSYSPF6100	NSYSPS6100	NSYSPF6200	NSYSPS6200	NSYMP206	NSYSIMP20	NSYVR20	NSYTVR20	2000	600	600
NSYSPF6100	NSYSPS8100	NSYSPF6200	NSYSPS8200	NSYMP206	NSYSIMP20	NSYVR20	NSYTVR20	2000	600	800
NSYSPF8100	NSYSPS4100	NSYSPF8200	NSYSPS4200	NSYMP208	NSYSIMP20	NSYVR20	NSYTVR20	2000	800	400
NSYSPF8100	NSYSPS5100	NSYSPF8200	NSYSPS5200	NSYMP208	NSYSIMP20	NSYVR20	NSYTVR20	2000	800	500
NSYSPF8100	NSYSPS6100	NSYSPF8200	NSYSPS6200	NSYMP208	NSYSIMP20	NSYVR20	NSYTVR20	2000	800	600
NSYSPF8100	NSYSPS8100	NSYSPF8200	NSYSPS8200	NSYMP208	NSYSIMP20	NSYVR20	NSYTVR20	2000	800	800
NSYSPF10100	NSYSPS4100	NSYSPF10200	NSYSPS4200	NSYMP2010	NSYSIMP20	NSYVR20	NSYTVR20	2000	1000	400
NSYSPF10100	NSYSPS5100	NSYSPF10200	NSYSPS5200	NSYMP2010	NSYSIMP20	NSYVR20	NSYTVR20	2000	1000	500
NSYSPF10100	NSYSPS6100	NSYSPF10200	NSYSPS6200	NSYMP2010	NSYSIMP20	NSYVR20	NSYTVR20	2000	1000	600
NSYSPF10100	NSYSPS8100	NSYSPF10200	NSYSPS8200	NSYMP2010	NSYSIMP20	NSYVR20	NSYTVR20	2000	1000	800
NSYSPF12100	NSYSPS4100	NSYSPF12200	NSYSPS4200	NSYMP2012	NSYSIMP20	NSYVR20	NSYTVR20	2000	1200	400
NSYSPF12100	NSYSPS5100	NSYSPF12200	NSYSPS5200	NSYMP2012	NSYSIMP20	NSYVR20	NSYTVR20	2000	1200	500
NSYSPF12100	NSYSPS6100	NSYSPF12200	NSYSPS6200	NSYMP2012	NSYSIMP20	NSYVR20	NSYTVR20	2000	1200	600
NSYSPF12100	NSYSPS8100	NSYSPF12200	NSYSPS8200	NSYMP2012	NSYSIMP20	NSYVR20	NSYTVR20	2000	1200	800
NSYSPF16100	NSYSPS4100	NSYSPF16200	NSYSPS4200	NSYMP2016	NSYSIMP20	NSYVR20	NSYTVR20	2000	1600	400
NSYSPF16100	NSYSPS5100	NSYSPF16200	NSYSPS5200	NSYMP2016	NSYSIMP20	NSYVR20	NSYTVR20	2000	1600	500
NSYSPF16100	NSYSPS6100	NSYSPF16200	NSYSPS6200	NSYMP2016	NSYSIMP20	NSYVR20	NSYTVR20	2000	1600	600
NSYSPF4100	NSYSPS6100	NSYSPF4200	NSYSPS6200	NSYMP224	NSYSIMP22	NSYVR22	NSYTVR22	2200	400	600
NSYSPF6100	NSYSPS6100	NSYSPF6200	NSYSPS6200	NSYMP226	NSYSIMP22	NSYVR22	NSYTVR22	2200	600	600
NSYSPF6100	NSYSPS8100	NSYSPF6200	NSYSPS8200	NSYMP226	NSYSIMP22	NSYVR22	NSYTVR22	2200	600	800
NSYSPF8100	NSYSPS6100	NSYSPF8200	NSYSPS6200	NSYMP228	NSYSIMP22	NSYVR22	NSYTVR22	2200	800	600
NSYSPF8100	NSYSPS8100	NSYSPF8200	NSYSPS8200	NSYMP228	NSYSIMP22	NSYVR22	NSYTVR22	2200	800	800
NSYSPF10100	NSYSPS6100	NSYSPF10200	NSYSPS6200	NSYMP2210	NSYSIMP22	NSYVR22	NSYTVR22	2200	1000	600
NSYSPF12100	NSYSPS6100	NSYSPF12200	NSYSPS6200	NSYMP2212	NSYSIMP22	NSYVR22	NSYTVR22	2200	1200	600
NSYSPF12100	NSYSPS8100	NSYSPF12200	NSYSPS8200	NSYMP2212	NSYSIMP22	NSYVR22	NSYTVR22	2200	1200	800

Technical changes reserved. Information provided without guarantee. Images are for illustrative purposes only.

Dimensions			Doors	Vertical uprights	Bottom frame and top frame with roof	Panels		Doors		Mounting plate
(A) Height (mm)	(B) Width (mm)	(C) Depth (mm)				Rear panel	Side panel	Plain	Transparent	
1200	600	400	1	NSYSFV12	NSYSFC64	NSYBP126	NSY2SP124	NSYSFD126	NSYSFD126T	NSYMP126
1200	600	500	1	NSYSFV12	NSYSFC65	NSYBP126	NSY2SP125	NSYSFD126	NSYSFD126T	NSYMP126
1200	600	600	1	NSYSFV12	NSYSFC66	NSYBP126	NSY2SP126	NSYSFD126	NSYSFD126T	NSYMP126
1200	600	800	1	NSYSFV12	NSYSFC68	NSYBP126	NSY2SP128	NSYSFD126	NSYSFD126T	NSYMP126
1200	800	400	1	NSYSFV12	NSYSFC84	NSYBP128	NSY2SP124	NSYSFD128	NSYSFD128T	NSYMP128
1200	800	500	1	NSYSFV12	NSYSFC85	NSYBP128	NSY2SP125	NSYSFD128	NSYSFD128T	NSYMP128
1200	800	600	1	NSYSFV12	NSYSFC86	NSYBP128	NSY2SP126	NSYSFD128	NSYSFD128T	NSYMP128
1200	800	800	1	NSYSFV12	NSYSFC88	NSYBP128	NSY2SP128	NSYSFD128	NSYSFD128T	NSYMP128
1400	600	400	1	NSYSFV14	NSYSFC64	NSYBP146	NSY2SP144	NSYSFD146	NSYSFD146T	NSYMP146
1400	600	500	1	NSYSFV14	NSYSFC65	NSYBP146	NSY2SP145	NSYSFD146	NSYSFD146T	NSYMP146
1400	600	600	1	NSYSFV14	NSYSFC66	NSYBP146	NSY2SP146	NSYSFD146	NSYSFD146T	NSYMP146
1400	600	800	1	NSYSFV14	NSYSFC68	NSYBP146	NSY2SP148	NSYSFD146	NSYSFD146T	NSYMP146
1400	800	400	1	NSYSFV14	NSYSFC84	NSYBP148	NSY2SP144	NSYSFD148	NSYSFD148T	NSYMP148
1400	800	500	1	NSYSFV14	NSYSFC85	NSYBP148	NSY2SP145	NSYSFD148	NSYSFD148T	NSYMP148
1400	800	600	1	NSYSFV14	NSYSFC86	NSYBP148	NSY2SP146	NSYSFD148	NSYSFD148T	NSYMP148
1400	800	800	1	NSYSFV14	NSYSFC88	NSYBP148	NSY2SP148	NSYSFD148	NSYSFD148T	NSYMP148
1600	600	400	1	NSYSFV16	NSYSFC64	NSYBP166	NSY2SP164	NSYSFD166	NSYSFD166T	NSYMP166
1600	600	500	1	NSYSFV16	NSYSFC65	NSYBP166	NSY2SP165	NSYSFD166	NSYSFD166T	NSYMP166
1600	600	600	1	NSYSFV16	NSYSFC66	NSYBP166	NSY2SP166	NSYSFD166	NSYSFD166T	NSYMP166
1600	600	800	1	NSYSFV16	NSYSFC68	NSYBP166	NSY2SP168	NSYSFD166	NSYSFD166T	NSYMP166
1600	800	400	1	NSYSFV16	NSYSFC84	NSYBP168	NSY2SP164	NSYSFD168	NSYSFD168T	NSYMP168
1600	800	500	1	NSYSFV16	NSYSFC85	NSYBP168	NSY2SP165	NSYSFD168	NSYSFD168T	NSYMP168
1600	800	600	1	NSYSFV16	NSYSFC86	NSYBP168	NSY2SP166	NSYSFD168	NSYSFD168T	NSYMP168
1600	800	800	1	NSYSFV16	NSYSFC88	NSYBP168	NSY2SP168	NSYSFD168	NSYSFD168T	NSYMP168
1800	400	400	1	NSYSFV18	NSYSFC44	NSYBP184	NSY2SP184	NSYSFD184	-	NSYMP184
1800	400	500	1	NSYSFV18	NSYSFC45	NSYBP184	NSY2SP185	NSYSFD184	-	NSYMP184
1800	400	600	1	NSYSFV18	NSYSFC46	NSYBP184	NSY2SP186	NSYSFD184	-	NSYMP184
1800	400	800	1	NSYSFV18	NSYSFC48	NSYBP184	NSY2SP188	NSYSFD184	-	NSYMP184
1800	600	400	1	NSYSFV18	NSYSFC64	NSYBP186	NSY2SP184	NSYSFD186	NSYSFD186T	NSYMP186
1800	600	500	1	NSYSFV18	NSYSFC65	NSYBP186	NSY2SP185	NSYSFD186	NSYSFD186T	NSYMP186
1800	600	600	1	NSYSFV18	NSYSFC66	NSYBP186	NSY2SP186	NSYSFD186	NSYSFD186T	NSYMP186
1800	600	800	1	NSYSFV18	NSYSFC68	NSYBP186	NSY2SP188	NSYSFD186	NSYSFD186T	NSYMP186
1800	800	400	1	NSYSFV18	NSYSFC84	NSYBP188	NSY2SP184	NSYSFD188	NSYSFD188T	NSYMP188
1800	800	500	1	NSYSFV18	NSYSFC85	NSYBP188	NSY2SP185	NSYSFD188	NSYSFD188T	NSYMP188
1800	800	600	1	NSYSFV18	NSYSFC86	NSYBP188	NSY2SP186	NSYSFD188	NSYSFD188T	NSYMP188
1800	800	600	2	NSYSFV18	NSYSFC86	NSYBP188	NSY2SP186	NSYSFD1882D	-	NSYMP188
1800	800	800	1	NSYSFV18	NSYSFC88	NSYBP188	NSY2SP188	NSYSFD188	NSYSFD188T	NSYMP188
1800	800	800	2	NSYSFV18	NSYSFC88	NSYBP188	NSY2SP188	NSYSFD1882D	-	NSYMP188
1800	1000	400	1	NSYSFV18	NSYSFC104	NSYBP1810	NSY2SP184	NSYSFD1810	NSYSFD1810T	NSYMP1810
1800	1000	400	2	NSYSFV18	NSYSFC104	NSYBP1810	NSY2SP184	NSYSFD18102D	-	NSYMP1810
1800	1000	500	1	NSYSFV18	NSYSFC105	NSYBP1810	NSY2SP185	NSYSFD1810	NSYSFD1810T	NSYMP1810
1800	1000	600	1	NSYSFV18	NSYSFC106	NSYBP1810	NSY2SP186	NSYSFD1810	NSYSFD1810T	NSYMP1810
1800	1000	600	2	NSYSFV18	NSYSFC106	NSYBP1810	NSY2SP186	NSYSFD18102D	-	NSYMP1810
1800	1000	800	1	NSYSFV18	NSYSFC108	NSYBP1810	NSY2SP188	NSYSFD1810	NSYSFD1810T	NSYMP1810
1800	1000	800	2	NSYSFV18	NSYSFC108	NSYBP1810	NSY2SP188	NSYSFD18102D	-	NSYMP1810
1800	1200	400	2	NSYSFV18	NSYSFC124	NSYBP1812	NSY2SP184	NSYSFD18122D	NSYSFD18122DT	NSYMP1812
1800	1200	500	2	NSYSFV18	NSYSFC125	NSYBP1812	NSY2SP185	NSYSFD18122D	NSYSFD18122DT	NSYMP1812
1800	1200	600	2	NSYSFV18	NSYSFC126	NSYBP1812	NSY2SP186	NSYSFD18122D	NSYSFD18122DT	NSYMP1812
1800	1200	800	2	NSYSFV18	NSYSFC128	NSYBP1812	NSY2SP188	NSYSFD18122D	NSYSFD18122DT	NSYMP1812

Technical changes reserved. Information provided without guarantee. Images are for illustrative purposes only.

Dimensions			Doors	Vertical uprights	Bottom frame and top frame with roof	Panels		Doors		Mounting plate
(A) Height (mm)	(B) Width (mm)	(C) Depth (mm)				Rear panel	Side panel	Plain	Transparent	
2000	300	500	1	NSYSFV20	NSYSFC35	NSYBP203	NSY2SP205	NSYSFD203	-	-
2000	300	600	1	NSYSFV20	NSYSFC36	NSYBP203	NSY2SP206	NSYSFD203	-	-
2000	300	800	1	NSYSFV20	NSYSFC38	NSYBP203	NSY2SP208	NSYSFD203	-	-
2000	400	400	1	NSYSFV20	NSYSFC44	NSYBP204	NSY2SP204	NSYSFD204	-	NSYMP204
2000	400	500	1	NSYSFV20	NSYSFC45	NSYBP204	NSY2SP205	NSYSFD204	-	NSYMP204
2000	400	600	1	NSYSFV20	NSYSFC46	NSYBP204	NSY2SP206	NSYSFD204	-	NSYMP204
2000	400	800	1	NSYSFV20	NSYSFC48	NSYBP204	NSY2SP208	NSYSFD204	-	NSYMP204
2000	600	400	1	NSYSFV20	NSYSFC64	NSYBP206	NSY2SP204	NSYSFD206	NSYSFD206T	NSYMP206
2000	600	500	1	NSYSFV20	NSYSFC65	NSYBP206	NSY2SP205	NSYSFD206	NSYSFD206T	NSYMP206
2000	600	600	1	NSYSFV20	NSYSFC66	NSYBP206	NSY2SP206	NSYSFD206	NSYSFD206T	NSYMP206
2000	600	800	1	NSYSFV20	NSYSFC68	NSYBP206	NSY2SP208	NSYSFD206	NSYSFD206T	NSYMP206
2000	800	400	1	NSYSFV20	NSYSFC84	NSYBP208	NSY2SP204	NSYSFD208	NSYSFD208T	NSYMP208
2000	800	500	1	NSYSFV20	NSYSFC85	NSYBP208	NSY2SP205	NSYSFD208	NSYSFD208T	NSYMP208
2000	800	600	1	NSYSFV20	NSYSFC86	NSYBP208	NSY2SP206	NSYSFD208	NSYSFD208T	NSYMP208
2000	800	600	2	NSYSFV20	NSYSFC86	NSYBP208	NSY2SP206	NSYSFD2082D	-	NSYMP208
2000	800	800	1	NSYSFV20	NSYSFC88	NSYBP208	NSY2SP208	NSYSFD208	NSYSFD208T	NSYMP208
2000	800	800	2	NSYSFV20	NSYSFC88	NSYBP208	NSY2SP208	NSYSFD2082D	-	NSYMP208
2000	1000	400	1	NSYSFV20	NSYSFC104	NSYBP2010	NSY2SP204	NSYSFD2010	NSYSFD2010T	NSYMP2010
2000	1000	400	2	NSYSFV20	NSYSFC104	NSYBP2010	NSY2SP204	NSYSFD20102D	-	NSYMP2010
2000	1000	500	1	NSYSFV20	NSYSFC105	NSYBP2010	NSY2SP205	NSYSFD2010	NSYSFD2010T	NSYMP2010
2000	1000	500	2	NSYSFV20	NSYSFC105	NSYBP2010	NSY2SP205	NSYSFD20102D	-	NSYMP2010
2000	1000	600	1	NSYSFV20	NSYSFC106	NSYBP2010	NSY2SP206	NSYSFD2010	NSYSFD2010T	NSYMP2010
2000	1000	600	2	NSYSFV20	NSYSFC106	NSYBP2010	NSY2SP206	NSYSFD20102D	-	NSYMP2010
2000	1000	800	1	NSYSFV20	NSYSFC108	NSYBP2010	NSY2SP208	NSYSFD2010	NSYSFD2010T	NSYMP2010
2000	1000	800	2	NSYSFV20	NSYSFC108	NSYBP2010	NSY2SP208	NSYSFD20102D	-	NSYMP2010
2000	1200	400	2	NSYSFV20	NSYSFC124	NSYBP2012	NSY2SP204	NSYSFD20122D	NSYSFD20122DT	NSYMP2012
2000	1200	500	2	NSYSFV20	NSYSFC125	NSYBP2012	NSY2SP205	NSYSFD20122D	NSYSFD20122DT	NSYMP2012
2000	1200	600	2	NSYSFV20	NSYSFC126	NSYBP2012	NSY2SP206	NSYSFD20122D	NSYSFD20122DT	NSYMP2012
2000	1200	800	2	NSYSFV20	NSYSFC128	NSYBP2012	NSY2SP208	NSYSFD20122D	NSYSFD20122DT	NSYMP2012
2000	1600	400	2	NSYSFV20	NSYSFC164	NSYBP2016	NSY2SP204	NSYSFD20162D	-	NSYMP2016
2000	1600	500	2	NSYSFV20	NSYSFC165	NSYBP2016	NSY2SP205	NSYSFD20162D	-	NSYMP2016
2000	1600	600	2	NSYSFV20	NSYSFC166	NSYBP2016	NSY2SP206	NSYSFD20162D	-	NSYMP2016
2200	400	400	1	NSYSFV22	NSYSFC44	NSYBP224	NSY2SP224	NSYSFD224	-	NSYMP224
2200	400	500	1	NSYSFV22	NSYSFC45	NSYBP224	NSY2SP225	NSYSFD224	-	NSYMP224
2200	400	600	1	NSYSFV22	NSYSFC46	NSYBP224	NSY2SP226	NSYSFD224	-	NSYMP224
2200	400	800	1	NSYSFV22	NSYSFC48	NSYBP224	NSY2SP228	NSYSFD224	-	NSYMP224
2200	600	400	1	NSYSFV22	NSYSFC64	NSYBP226	NSY2SP224	NSYSFD226	NSYSFD226T	NSYMP226
2200	600	500	1	NSYSFV22	NSYSFC65	NSYBP226	NSY2SP225	NSYSFD226	NSYSFD226T	NSYMP226
2200	600	600	1	NSYSFV22	NSYSFC66	NSYBP226	NSY2SP226	NSYSFD226	NSYSFD226T	NSYMP226
2200	600	800	1	NSYSFV22	NSYSFC68	NSYBP226	NSY2SP228	NSYSFD226	NSYSFD226T	NSYMP226
2200	800	400	1	NSYSFV22	NSYSFC84	NSYBP228	NSY2SP224	NSYSFD228	NSYSFD228T	NSYMP228
2200	800	500	1	NSYSFV22	NSYSFC85	NSYBP228	NSY2SP225	NSYSFD228	NSYSFD228T	NSYMP228
2200	800	600	1	NSYSFV22	NSYSFC86	NSYBP228	NSY2SP226	NSYSFD228	NSYSFD228T	NSYMP228
2200	800	800	1	NSYSFV22	NSYSFC88	NSYBP228	NSY2SP228	NSYSFD228	NSYSFD228T	NSYMP228
2200	1000	400	1	NSYSFV22	NSYSFC104	NSYBP2210	NSY2SP224	NSYSFD2210	NSYSFD2210T	NSYMP2210
2200	1000	500	1	NSYSFV22	NSYSFC105	NSYBP2210	NSY2SP225	NSYSFD2210	NSYSFD2210T	NSYMP2210
2200	1000	600	1	NSYSFV22	NSYSFC106	NSYBP2210	NSY2SP226	NSYSFD2210	NSYSFD2210T	NSYMP2210
2200	1000	800	1	NSYSFV22	NSYSFC108	NSYBP2210	NSY2SP228	NSYSFD2210	NSYSFD2210T	NSYMP2210
2200	1200	400	2	NSYSFV22	NSYSFC124	NSYBP2212	NSY2SP224	NSYSFD22122D	NSYSFD22122DT	NSYMP2212
2200	1200	500	2	NSYSFV22	NSYSFC125	NSYBP2212	NSY2SP225	NSYSFD22122D	NSYSFD22122DT	NSYMP2212
2200	1200	600	2	NSYSFV22	NSYSFC126	NSYBP2212	NSY2SP226	NSYSFD22122D	NSYSFD22122DT	NSYMP2212
2200	1200	800	2	NSYSFV22	NSYSFC128	NSYBP2212	NSY2SP228	NSYSFD22122D	NSYSFD22122DT	NSYMP2212

Technical changes reserved. Information provided without guarantee. Images are for illustrative purposes only.

					304L stainless-steel	316L stainless-steel	304L stainless-steel	
External dimensions								
Height (mm)	Width (mm)	Depth (mm)	No. of locks	No. of doors	Plain door	Glazed door. The glazed door has no reinforcement.	Plain door	Canopy
300	200	150	1	1	NSYS3X3215	-	NSYS3X3215H	NSYTX2015
300	250	150	1	1	NSYS3X302515	-	NSYS3X302515H	NSYTX2515
300	300	150	1	1	NSYS3X3315	-	NSYS3X3315H	NSYTX3015
400	300	150	1	1	NSYS3X4315	-	NSYS3X4315H	NSYTX3015
400	300	200	1	1	NSYS3X4320	NSYS3X4320T	NSYS3X4320H	NSYTX3020
400	400	200	1	1	NSYS3X4420	-	NSYS3X4420H	NSYTX4020
400	600	200	1	1	NSYS3X4620	-	NSYS3X4620H	NSYTX6020
500	400	200	2	1	NSYS3X5420	NSYS3X5420T	NSYS3X5420H	NSYTX4020
600	400	200	2	1	NSYS3X6420	NSYS3X6420T	NSYS3X6420H	NSYTX4020
600	600	250	2	1	NSYS3X6625	-	NSYS3X6625H	NSYTX6025
600	1000	300	-	2	NSYS3X601030	-	-	-
600	1200	300	-	2	NSYS3X601230	-	-	NSYTX12030
700	500	250	2	1	NSYS3X7525	NSYS3X7525T	NSYS3X7525H	NSYTX5025
800	600	250	2	1	NSYS3X8625	NSYS3X8625T	NSYS3X8625H	NSYTX6025
800	800	300	2	1	NSYS3X8830	-	NSYS3X8830H	NSYTX8030
800	1000	300	-	2	NSYS3X801030	-	-	-
800	1200	300	-	2	NSYS3X801230	-	-	NSYTX12030
1000	800	300	2	1	NSYS3X10830	NSYS3X10830T	NSYS3X10830H	NSYTX8030
1000	1000	300	-	2	NSYS3X101030	-	NSYS3X101030H	NSYTX10030
1200	800	300	2	1	NSYS3X12830	-	NSYS3X12830H	NSYTX8030
1200	1000	300	-	2	NSYS3X121030	-	NSYS3X121030H	NSYTX10030

⁽¹⁾ Three-point locking system system.

Accessories

										
External dimensions					Mounting plate Plain	Mounting plate Silkscreened	Mounting plate Microperforated	Mounting plate Telequick	Mounting plate Modular	Step slides
Height (mm)	Width (mm)	Depth (mm)	No. of modules							
300	200	150	-		NSYMM32	-	NSYMF32	NSYMR32	-	-
300	250	150	-		NSYMM3025	-	-	NSYMR3025	-	-
300	300	150	-		NSYMM33	-	NSYMF33	NSYMR33	-	-
400	300	150	24		NSYMM43	NSYMS43	NSYMF43	NSYMR43	NSYDLM24	-
400	300	200	24		NSYMM43	NSYMS43	NSYMF43	NSYMR43	NSYDLM24	NSYSDCR200
400	400	200	-		NSYMM44	NSYMS44	NSYMF44	NSYMR44	-	NSYSDCR200
400	600	200	-		NSYMM64	NSYMS64	NSYMF64	NSYMR46	-	NSYSDCR200
500	400	200	48		NSYMM54	NSYMS54	NSYMF54	NSYMR54	NSYDLM48	NSYSDCR200
600	400	200	48		NSYMM64	NSYMS64	NSYMF64	NSYMR64	NSYDLM48P	NSYSDCR200
600	600	250	84		NSYMM66	NSYMS66	NSYMF66	NSYMR66	NSYDLM84P	NSYSDCR250
600	1000	300*	-		NSYMM106	-	NSYMF106	NSYMR106	-	NSYSDCR300
600	1200	300*	-		NSYMM126	-	NSYMF126	-	-	NSYSDCR300
700	500	250	66		NSYMM75	NSYMS75	NSYMF75	NSYMR75	NSYDLM66	NSYSDCR250
700	500	250	88		-	-	-	-	NSYDLM88	-
800	600	250	84		NSYMM86	NSYMS86	NSYMF86	NSYMR86	NSYDLM84	NSYSDCR250
800	600	250	112		-	-	-	-	NSYDLM112	-
800	800	300	-		NSYMM88	-	NSYMF88	NSYMR88	-	NSYSDCR300
800	1000	300 ⁽¹⁾	-		NSYMM108	-	NSYMF108	NSYMR108	-	NSYSDCR300
800	1200	300 ⁽¹⁾	-		NSYMM128	-	NSYMF128	NSYMR128	-	NSYSDCR300
1000	800	300	234		NSYMM108	-	NSYMF108	NSYMR108	NSYDLM240	NSYSDCR300
1000	1000	300	-		NSYMM1010	-	NSYMF1010	NSYMR1010	-	NSYSDCR300
1200	800	300	-		NSYMM128	-	NSYMF128	NSYMR128	-	NSYSDCR300
1200	1000	300	-		NSYMM1210	-	NSYMF1210	NSYMR1210	-	NSYSDCR300

⁽¹⁾ Three-point locking system system.

Technical changes reserved. Information provided without guarantee. Images are for illustrative purposes only.

Stainless-Steel Floor-Standing Enclosures

Stainless-steel floor-standing enclosures

External dimensions			No. of front doors	304L stainless-steel	316L stainless-steel	Brushed 304L / 316L stainless-steel plinth height 100 mm*	Brushed 304L / 316L stainless-steel plinth height 200 mm*	Mounting plate**		
Height (mm)	Width (mm)	Depth (mm)		Floor-standing enclosure	Floor-standing enclosure	Kit (4 corners + front and back)	Set of 2 side panels		Kit (4 corners + front and back)	Set of 2 side panels (x2)
1400	1000	300	2	NSYSMX141030	-	NSYSFPX10100	NSYSFPSX3100	NSYSFPX10200	NSYSFPSX3200	NSYMP1410
1600	800	400	1	NSYSMX16840	-	NSYSFPX8100	NSYSFPSX4100	NSYSFPX8200	NSYSFPSX4200	NSYMP168
1800	600	400	1	NSYSMX18640	-	NSYSFPX6100	NSYSFPSX4100	NSYSFPX6200	NSYSFPSX4200	NSYMP186
1800	800	400	1	NSYSMX18840	NSYSMX18840H	NSYSFPX8100	NSYSFPSX4100	NSYSFPX8200	NSYSFPSX4200	NSYMP188
1800	1200	400	2	NSYSMX181240	NSYSMX181240H	NSYSFPX12100	NSYSFPSX4100	NSYSFPX12200	NSYSFPSX4200	NSYMP1812
1800	1600	400	2	NSYSMX181640	NSYSMX181640H	NSYSFPX16100	NSYSFPSX4100	NSYSFPX16200	NSYSFPSX4200	NSYMP1816
2000	800	500	1	NSYSMX20850	-	NSYSFPX8100	NSYSFPSX5100	NSYSFPX8200	NSYSFPSX5200	NSYMP208
2000	1000	400	2	NSYSMX201040	NSYSMX201040H	NSYSFPX10100	NSYSFPSX4100	NSYSFPX10200	NSYSFPSX4200	NSYMP2010
2000	1200	500	2	NSYSMX201250	NSYSMX201250H	NSYSFPX12100	NSYSFPSX5100	NSYSFPX12200	NSYSFPSX5200	NSYMP2012
2000	1600	600	2	NSYSMX201660	NSYSMX201660H	NSYSFPX16100	NSYSFPSX6100	NSYSFPX16200	NSYSFPSX6200	NSYMP2016

Stainless-steel floor-standing enclosures

External dimensions			No. of front doors	304L stainless-steel (316L stainless-steel enclosures on request)	Brushed 304L stainless-steel plinth height 100 mm*	Brushed 304L stainless-steel plinth height 200 mm*	Mounting plate**				
Height (mm)	Width (mm)	Depth (mm)		Suitable enclosure	Set of 2 side panels	Coupling kit		Kit (4 corners + front and back)	Set of 2 side panels	Kit (4 corners + front and back)	Side Set of 2 side panels (x2)
1800	600	400	1	NSYSFX18640	NSY2SPX184	NSYSFBK19	NSYSFPX6100	NSYSFPSX4100SF	NSYSFPX6200	NSYSFPSX4200SF	NSYMP186
1800	800	400	1	NSYSFX18840	NSY2SPX184	+	NSYSFPX8100	NSYSFPSX4100SF	NSYSFPX8200	NSYSFPSX4200SF	NSYMP188
1800	1200	400	2	NSYSFX181240	NSY2SPX184	NSYSFXJG	NSYSFPX12100	NSYSFPSX4100SF	NSYSFPX12200	NSYSFPSX4200SF	NSYMP1812
2000	600	500	1	NSYSFX20650	NSY2SPX205		NSYSFPX6100	NSYSFPSX5100SF	NSYSFPX6200	NSYSFPSX5200SF	NSYMP206
2000	800	400	1	NSYSFX20840	NSY2SPX204		NSYSFPX8100	NSYSFPSX4100SF	NSYSFPX8200	NSYSFPSX4200SF	NSYMP208
2000	800	600	1	NSYSFX20860	NSY2SPX206		NSYSFPX8100	NSYSFPSX6100SF	NSYSFPX8200	NSYSFPSX6200SF	NSYMP208
2000	1000	600	2	NSYSFX201060	NSY2SPX206		NSYSFPX10100	NSYSFPSX6100SF	NSYSFPX10200	NSYSFPSX6200SF	NSYMP2010
2000	1200	600	2	NSYSFX201260	NSY2SPX206		NSYSFPX12100	NSYSFPSX6100SF	NSYSFPX12200	NSYSFPSX6200SF	NSYMP2012

Stainless-steel floor-standing suitable

External dimensions			No. of front doors	Stainless-steel	304L stainless-steel plinth, height 100 mm*	304L stainless-steel plinth, height 200 mm*	Mounting plate**		
Height (mm)	Width (mm)	Depth (mm)		Floor-standing suitable	Front and rear	side panels		Front and rear	side panels
1000	600	500	1	NSYSDX6	NSYSFPX6100	NSYSFPSX5100	NSYSFPX6200	2x NSYSFPSX5100	NSYPMP8560
1000	800	500	1	NSYSDX8	NSYSFPX8100	NSYSFPSX5100	NSYSFPX8200	2x NSYSFPSX5100	NSYPMP8580
1000	1000	500	2	NSYSDX10	NSYSFPX10100	NSYSFPSX5100	NSYSFPX10200	2x NSYSFPSX5100	NSYPMP85100
1000	1200	500	2	NSYSDX12	NSYSFPX12100	NSYSFPSX5100	NSYSFPX12200	2x NSYSFPSX5100	NSYPMP85120

* See section on stainless-steel composition accessories.

** See other mounting plates in common accessories.

Polyester Wall-Mounted Enclosures

Polyester wall-mounted enclosures IP66



External dimensions			References of wall-mounted enclosures with door							
Height (mm)	Width (mm)	Depth (mm)	Plain	Transparent	Plain	Transparent	Plain	Transparent	Plain	Transparent
308	255	160	-	-	NSYPLM3025G	NSYPLM3025TG	-	-	-	-
310	215	160	NSYPLM32G	NSYPLM32TG	-	-	-	-	-	-
430	330	200	-	-	-	-	NSYPLM43G	NSYPLM43TG	NSYPLM43VG	NSYPLM43TVG
530	430	200	-	-	-	-	NSYPLM54G	NSYPLM54TG	NSYPLM54VG	NSYPLM54TVG
647	436	250	-	-	-	-	NSYPLM64G	NSYPLM64TG	NSYPLM64VG	NSYPLM64TVG
747	536	300	-	-	-	-	NSYPLM75G	NSYPLM75TG	NSYPLM75VG	NSYPLM75TVG
847	636	300	-	-	-	-	NSYPLM86G	NSYPLM86TG	NSYPLM86VG	NSYPLM86TVG
1056	852	350	-	-	-	-	NSYPLM108G	NSYPLM108TG	-	-

Details see page 215

New

PLM landscape (horizontal) range for photovoltaic and multiple applications with removable door system see page 448

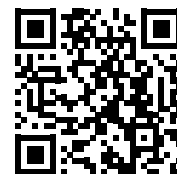

Scan or click for video

Mounting accessories

Dimensions			Metal mounting plates				Insulated mounting plates		Modular distribution chassis	Step slides	Symmetrical DIN rail	
Height (mm)	Width (mm)	Depth (mm)	Plain	Silkscreened	Micro-perforated	Telequick	Bakelite	Polyester				
310	215	160	NSYMM32	-	-	NSYMR32	NSYMB32	NSYMPP32	-	-	NSYCS200PLM	
308	255	160	NSYMM3025	-	-	NSYMR3025	NSYMB3025	NSYMPP3025	NSYDLPLM18G	-	-	
430	330	200	NSYMM43	NSYMS43	NSYMF43	NSYMR43	NSYMB43	NSYMPP43	NSYDLA24G	NSYDPLM200	NSYCS300PLM	
530	430	200	NSYMM54	NSYMS54	NSYMF54	NSYMR54	NSYMB54	NSYMPP54	NSYDLA48G	NSYDPLM200	NSYCS400PLM	
647	436	250	NSYMM64	NSYMS64	NSYMF64	NSYMR64	NSYMB64	NSYMPP64	NSYDLA48PG	NSYDPLM250	NSYCS400PLM	
747	536	300	NSYMM75	NSYMS75	NSYMF75	NSYMR75	NSYMB75	NSYMPP75	NSYDLA66G and NSYDLA88G	NSYDPLM300	NSYCS500PLM	
847	636	300	NSYMM86	NSYMS86	NSYMF86	NSYMR86	NSYMB86	NSYMPP86	NSYDLA84G and NSYDLA112G	NSYDPLM300	NSYCS600PLM	
1056	852	350	NSYMM108	-	NSYMF108	NSYMR108	NSYMB108	NSYMPP108	NSYDLA234G	NSYDPLM350	NSYCS800PLM	
Details			see page 260				see page 261		see page 220		see page 224	

Main accessories

Dimensions			Fixing lugs	Postfixing device	Floormounting pillar	Internal door	Blanking plates	Plinth ZM RAL 7032			
Height (mm)	Width (mm)	Depth (mm)									
310	215	160	NSYPPFLM32G	-	-	-	NSYCEPLMAG	-			
308	255	160	NSYPPFLMG	-	-	NSYPA3025PLMG	-	-			
430	330	200	NSYPPFLMG	NSYSFP300	-	NSYPAP43G	NSYCEPLMBG	-			
530	430	200	NSYPPFLMG	NSYSFP400	NSYSFSPLMG	NSYPAP54G	NSYCEPLMBG	-			
647	436	250	NSYPPFLMG	NSYSFP400	NSYSFSPLMG	NSYPAP64G	NSYCEPLMCG	-			
747	536	300	NSYPPFLMG	NSYSFP500	-	NSYPAP75G	NSYCEPLMCG	NSYZM253G			
847	636	300	NSYPPFLMG	NSYSFP600	-	NSYPAP86G	NSYCEPLMCG	NSYZM263G			
1056	852	350	NSYPPFLMG	-	-	NSYPAP108G	-	NSYZM283G			
Details			see page 218			see page 219		see page 218		see page 217	

Water drain plug: [Page 225](#)
 Rail-fixing nuts: [Page 224](#)
 Airing louvre: [Page 225](#)

Polyester Floor-Standing Enclosures



Indoor and Outdoor:
Outdoor use requires the installation of a canopy.

Completely sealed enclosures, IP65

Enclosures with open bottom part, IP54



PLA



PLA



PLAZ

Dimensions				Completely sealed enclosures, IP65		Enclosures with open bottom part, IP54
Height (mm)	Width (mm)	Depth (mm)	N° of doors	Plain	Glazed**	Plain
500	500	320	1	NSYPLA553G	NSYPLA553TG	NSYPLAZ553G
500	500	420	1	NSYPLA554G	NSYPLA554TG	NSYPLAZ554G
500	750	320	1	NSYPLA573G	NSYPLA573TG	NSYPLAZ573G
500	750	420	1	NSYPLA574G	NSYPLA574TG	NSYPLAZ574G
500	1000	320	2	NSYPLA5103G	NSYPLA5103TG	NSYPLAZ5103G
500	1000	420	2	NSYPLA5104G	NSYPLA5104TG	NSYPLAZ5104G
500	1250	320	2	NSYPLA5123G	NSYPLA5123TG	NSYPLAZ5123G
500	1250	420	2	NSYPLA5124G	NSYPLA5124TG	NSYPLAZ5124G
750	500	320	1	NSYPLA753G	NSYPLA753TG	NSYPLAZ753G
750	500	420	1	NSYPLA754G	NSYPLA754TG	NSYPLAZ754G
750	750	320	1	NSYPLA773G	NSYPLA773TG	NSYPLAZ773G
750	750	420	1	NSYPLA774G	NSYPLA774TG	NSYPLAZ774G
750	750	620	1	NSYPLA776G	NSYPLA776TG	NSYPLAZ776G
750	1000	320	2	NSYPLA7103G	NSYPLA7103TG	NSYPLAZ7103G
750	1000	420	2	NSYPLA7104G	NSYPLA7104TG	NSYPLAZ7104G
750	1250	320	2	NSYPLA7123G	NSYPLA7123TG	NSYPLAZ7123G
750	1250	420	2	NSYPLA7124G	NSYPLA7124TG	NSYPLAZ7124G
1000	500	320	1	NSYPLA1053G	NSYPLA1053TG	NSYPLAZ1053G
1000	500	420	1	NSYPLA1054G	NSYPLA1054TG	NSYPLAZ1054G
1000	750	320	1	NSYPLA1073G	NSYPLA1073TG	NSYPLAZ1073G
1000	750	420	1	NSYPLA1074G	NSYPLA1074TG	NSYPLAZ1074G
1000	1000	320	2	NSYPLA10103G	NSYPLA10103TG	NSYPLAZ10103G
1000	1000	420	2	NSYPLA10104G	NSYPLA10104TG	NSYPLAZ10104G
1000	1250	320	2	NSYPLA10123G	NSYPLA10123TG	NSYPLAZ10123G
1000	1250	420	2	NSYPLA10124G	NSYPLA10124TG	NSYPLAZ10124G
1250	500	320	1	NSYPLA1253G	NSYPLA1253TG	NSYPLAZ1253G
1250	500	420	1	NSYPLA1254G	NSYPLA1254TG	NSYPLAZ1254G
1250	750	320	1	NSYPLA1273G	NSYPLA1273TG	NSYPLAZ1273G
1250	750	420	1	NSYPLA1274G	NSYPLA1274TG	NSYPLAZ1274G
1250	750	620	1	NSYPLA1276G	NSYPLA1276TG	NSYPLAZ1276G
1250	1000	320	2	NSYPLA12103G	NSYPLA12103TG	NSYPLAZ12103G
1250	1000	420	2	NSYPLA12104G	NSYPLA12104TG	NSYPLAZ12104G
1250	1250	320	2	NSYPLA12123G	NSYPLA12123TG	NSYPLAZ12123G
1250	1250	420	2	NSYPLA12124G	NSYPLA12124TG	NSYPLAZ12124G
1250	1250	620	2	NSYPLA12126G	NSYPLA12126TG	NSYPLAZ12126G
1500	500	320	1	NSYPLA1553G	NSYPLA1553TG	NSYPLAZ1553G
1500	500	420	1	NSYPLA1554G	NSYPLA1554TG	NSYPLAZ1554G
1500	750	320	1	NSYPLA1573G	NSYPLA1573TG	NSYPLAZ1573G
1500	750	420	1	NSYPLA1574G	NSYPLA1574TG	NSYPLAZ1574G
1500	750	620	1	NSYPLA1576G	NSYPLA1576TG	NSYPLAZ1576G
1500	1000	320	2	NSYPLA15103G	NSYPLA15103TG	NSYPLAZ15103G
1500	1000	420	2	NSYPLA15104G	NSYPLA15104TG	NSYPLAZ15104G
1500	1250	320	2	NSYPLA15123G	NSYPLA15123TG	NSYPLAZ15123G
1500	1250	420	2	NSYPLA15124G	NSYPLA15124TG	NSYPLAZ15124G
1500	1250	620	2	NSYPLA15126G	NSYPLA15126TG	NSYPLAZ15126G
2000	750	420	2*	NSYPLA2074G	NSYPLA2074TG	NSYPLAZ2074G

*Two doors in vertical.

**Recommended to protect against direct UV radiation.

PHD - Applicative and customized solutions:

See the Polyester Heavy-Duty offer in the Applicative and customized solutions, [page 434](#).

Technical changes reserved. Information provided without guarantee. Images are for illustrative purposes only.



Dimensions				Enclosures with ventilated canopy, IP44	Enclosures with open bottom part and ventilated canopy, IP44
Height (mm)	Width (mm)	Depth (mm)	N° of doors	Plain	Plain
500	500	320	1	NSYPLAT553G	NSYPLAZT553G
500	500	420	1	NSYPLAT554G	NSYPLAZT554G
500	750	320	1	NSYPLAT573G	NSYPLAZT573G
500	750	420	1	NSYPLAT574G	NSYPLAZT574G
500	1000	320	2	NSYPLAT5103G	NSYPLAZT5103G
500	1000	420	2	NSYPLAT5104G	NSYPLAZT5104G
500	1250	320	2	NSYPLAT5123G	NSYPLAZT5123G
500	1250	420	2	NSYPLAT5124G	NSYPLAZT5124G
750	500	320	1	NSYPLAT753G	NSYPLAZT753G
750	500	420	1	NSYPLAT754G	NSYPLAZT754G
750	750	320	1	NSYPLAT773G	NSYPLAZT773G
750	750	420	1	NSYPLAT774G	NSYPLAZT774G
750	750	620	1	NSYPLAT776G	NSYPLAZT776G
750	1000	320	2	NSYPLAT7103G	NSYPLAZT7103G
750	1000	420	2	NSYPLAT7104G	NSYPLAZT7104G
750	1250	320	2	NSYPLAT7123G	NSYPLAZT7123G
750	1250	420	2	NSYPLAT7124G	NSYPLAZT7124G
1000	500	320	1	NSYPLAT1053G	NSYPLAZT1053G
1000	500	420	1	NSYPLAT1054G	NSYPLAZT1054G
1000	750	320	1	NSYPLAT1073G	NSYPLAZT1073G
1000	750	420	1	NSYPLAT1074G	NSYPLAZT1074G
1000	1000	320	2	NSYPLAT10103G	NSYPLAZT10103G
1000	1000	420	2	NSYPLAT10104G	NSYPLAZT10104G
1000	1250	320	2	NSYPLAT10123G	NSYPLAZT10123G
1000	1250	420	2	NSYPLAT10124G	NSYPLAZT10124G
1250	500	320	1	NSYPLAT1253G	NSYPLAZT1253G
1250	500	420	1	NSYPLAT1254G	NSYPLAZT1254G
1250	750	320	1	NSYPLAT1273G	NSYPLAZT1273G
1250	750	420	1	NSYPLAT1274G	NSYPLAZT1274G
1250	750	620	1	NSYPLAT1276G	NSYPLAZT1276G
1250	1000	320	2	NSYPLAT12103G	NSYPLAZT12103G
1250	1000	420	2	NSYPLAT12104G	NSYPLAZT12104G
1250	1250	320	2	NSYPLAT12123G	NSYPLAZT12123G
1250	1250	420	2	NSYPLAT12124G	NSYPLAZT12124G
1250	1250	620	2	NSYPLAT12126G	NSYPLAZT12126G
1500	500	320	1	NSYPLAT1553G	NSYPLAZT1553G
1500	500	420	1	NSYPLAT1554G	NSYPLAZT1554G
1500	750	320	1	NSYPLAT1573G	NSYPLAZT1573G
1500	750	420	1	NSYPLAT1574G	NSYPLAZT1574G
1500	750	620	1	NSYPLAT1576G	NSYPLAZT1576G
1500	1000	320	2	NSYPLAT15103G	NSYPLAZT15103G
1500	1000	420	2	NSYPLAT15104G	NSYPLAZT15104G
1500	1250	320	2	NSYPLAT15123G	NSYPLAZT15123G
1500	1250	420	2	NSYPLAT15124G	NSYPLAZT15124G
1500	1250	620	2	NSYPLAT15126G	NSYPLAZT15126G
2000	750	420	2*	NSYPLAT2074G	NSYPLAZT2074G







*Two doors in vertical.

PHD - Applicative and customized solutions:

See the Polyester Heavy-Duty offer in the Applicative and customized solutions, [page 434](#).

Technical changes reserved. Information provided without guarantee. Images are for illustrative purposes only.

Mounting accessories

			Metal mounting plates		Insulated mounting plates		Modular distributionchassis		Internal door
									
Dimensions			Plain	Telequick	Polyester	Bakelite			
Height (mm)	Width (mm)	No. of doors							
500	500	1	NSYPMM55	NSYPMR55	NSYPMA55	NSYPMB55	-	-	NSYPAPLA55G
500	750	1	NSYPMM75	NSYPMR57	NSYPMA75	NSYPMB75	-	-	NSYPAPLA57G
500	1000	2	NSYPMM510	2 x NSYPMR55	NSYPMA510	NSYPMB510	-	-	2 x NSYPAPLA55G
500	1250	2	NSYPMM55 + NSYPMM75	NSYPMR55 + NSYPMR57	NSYPMA55 + NSYPMA75	NSYPMB55 + NSYPMB75	-	-	NSYPAPLA55G + NSYPAPLA57G
750	500	1	NSYPMM75	NSYPMR75	NSYPMA75	NSYPMB75	NSYDLP76G	NSYDLP57G	NSYPAPLA75G
750	750	1	NSYPMM77	NSYPMR77	NSYPMA77	NSYPMB77	NSYDLP132G	NSYDLP99G	NSYPAPLA77G
750	1000	2	NSYPMM710	2 x NSYPMR75	NSYPMA710	NSYPMB710	2 x NSYDLP76G	2 x NSYDLP57G	2 x NSYPAPLA75G
750	1250	2	NSYPMM712	NSYPMR75 + NSYPMR77	NSYPMA712	NSYPMB712	NSYDLP76G + NSYDLP132G	NSYDLP57G + NSYDLP99G	NSYPAPLA75G + NSYPAPLA77G
1000	500	1	NSYPMM105	NSYPMR105	NSYPMA105	NSYPMB105	NSYDLP114G	NSYDLP95G	NSYPAPLA105G
1000	750	1	NSYPMM107	NSYPMR107	NSYPMA107	NSYPMB107	NSYDLP198G	NSYDLP165G	NSYPAPLA107G
1000	1000	2	NSYPMM1010	2 x NSYPMR105	NSYPMA1010	NSYPMB1010	2 x NSYDLP114G	2 x NSYDLP95G	2 x NSYPAPLA105G
1000	1250	2	NSYPMM1012	NSYPMR105 + NSYPMR107	NSYPMA1012	NSYPMB1012	NSYDLP114G + NSYDLP198G	NSYDLP95G + NSYDLP165G	NSYPAPLA105G + NSYPAPLA107G
1250	500	1	NSYPMM125	NSYPMR125	NSYPMA125	NSYPMB125	NSYDLP133G	NSYDLP114PG	NSYPAPLA125G
1250	750	1	NSYPMM127	NSYPMR127	NSYPMA127	NSYPMB127	NSYDLP231G	NSYDLP198PG	NSYPAPLA127G
1250	1000	2	NSYPMM1210	2 x NSYPMR125	NSYPMA1210	NSYPMB1210	2 x NSYDLP133G	2 x NSYDLP114PG	2 x NSYPAPLA125G
1250	1250	2	NSYPMM1212	NSYPMR125 + NSYPMR127	NSYPMA1212	NSYPMB1212	NSYDLP133G + NSYDLP231G	NSYDLP114PG + NSYDLP198PG	NSYPAPLA125G + NSYPAPLA127G
1500	500	1	NSYPMM155	NSYPMR155	-	NSYPMB155	NSYDLP171G	NSYDLP152G	NSYPAPLA155G
1500	750	1	NSYPMM157	NSYPMR157	-	NSYPMB157	NSYDLP297G	NSYDLP264G	NSYPAPLA157G
1500	1000	2	NSYPMM1510	2 x NSYPMR155	-	NSYPMB1510	2 x NSYDLP171G	2 x NSYDLP152G	2 x NSYPAPLA155G
1500	1250	2	NSYPMM1512	NSYPMR155 + NSYPMR157	-	NSYPMB1512	NSYDLP171G + NSYDLP297G	NSYDLP152G + NSYDLP264G	NSYPAPLA155G + NSYPAPLA157G
2000	750	2	NSYPMM207	2 x NSYPMR107	2 x NSYPMA107	2 x NSYPMB107	-	-	-
Details			see page 246		see page 246		see page 248		see page 242

Step slides: [Page 250](#)
 Uprights and mounting rails: [Page 270](#)
 Door retainer: [Page 242](#)

Composition accessories

		N plinth	H plinth	ZA plinth	ZZ plinth	Floor-fixing frame	Canopy	Cable entry plate							
															
Dimensions		Height 60 mm	Height 900 mm	Height 200 mm	Height 200 mm	Height 500 mm									
Width (mm)	Depth (mm)	500	320	NSYZNPLA53G	NSYZHPLA53G	NSYZA253G	NSYZZ253G	NSYZZ553G	NSYMFPLAZ53	NSYTJPLA53G	NSYECPLAZ53G				
500	420	NSYZNPLA54G	NSYZHPLA54G	NSYZA254G	NSYZZ254G	NSYZZ554G	NSYMFPLAZ54	NSYTJPLA54G	NSYECPLAZ54G						
750	320	NSYZNPLA73G	NSYZHPLA73G	NSYZA273G	NSYZZ273G	NSYZZ573G	NSYMFPLAZ73	NSYTJPLA73G	NSYECPLAZ73G						
750	420	NSYZNPLA74G	NSYZHPLA74G	NSYZA274G	NSYZZ274G	NSYZZ574G	NSYMFPLAZ74	NSYTJPLA74G	NSYECPLAZ74G						
750	620	-	-	NSYZA276G	NSYZZ276G	-	NSYMFPLAZ76	NSYTJPLA76G	NSYECPLAZ76G						
1000	320	NSYZNPLA103G	NSYZHPLA103G	NSYZA2103G	NSYZZ2103G	NSYZZ5103G	NSYMFPLAZ103	NSYTJPLA103G	NSYECPLAZ103G						
1000	420	NSYZNPLA104G	NSYZHPLA104G	NSYZA2104G	NSYZZ2104G	NSYZZ5104G	NSYMFPLAZ104	NSYTJPLA104G	NSYECPLAZ104G						
1000	320	NSYZNPLA123G	NSYZHPLA123G	NSYZA2123G	NSYZZ2123G	NSYZZ5123G	NSYMFPLAZ123	NSYTJPLA123G	NSYECPLAZ123G						
1250	420	NSYZNPLA124G	NSYZHPLA124G	NSYZA2124G	NSYZZ2124G	NSYZZ5124G	NSYMFPLAZ124	NSYTJPLA124G	NSYECPLAZ124G						
1250	620	-	-	NSYZA2126G	NSYZZ2126G	-	NSYMFPLAZ126	NSYTJPLA126G	NSYECPLAZ126G						
Details		see page 239		see page 241		see page 238		see page 240		see page 241		see page 237		see page 237	

VDI accessories

19" fixed chassis			
			
Dimensions			
Height (mm)	Width (mm)	Number of U	References
500	750	8	NSYBRF8PLAG
750	750	12	NSYBRF12PLAG + NSYSPLA75
1000	750	17	NSYBRF17PLAG + NSYSPLA100
1250	750	21	NSYBRF21PLAG + NSYSPLA125
1500	750	26	NSYBRF26PLAG + NSYSPLA150*
2000	750	2 x 17	2 x NSYBRF17PLAG + 2 x NSYSPLA100 + NSYPTZ4
Details		see page 245	

* not compatible with NSYCAAPVHD

Door switch: [Page 242](#)
 Insert: [Page 251](#)
 Document pocket: [Page 318](#)

VDI accessories and fixings: [Page 289](#)
 Coupling Kit: [Page 236](#)
 Anti-graffiti painting: [Page 237](#)

Handles and inserts: [Page 243](#)
 Wall fixing lug: [Page 237](#)

Steel Industrial Boxes

Spacial SDB metal junction boxes



Steel industrial boxes



Spacial SDB

Metal junction boxes	34
----------------------	----

Spacial SBM

Introduction	36
Characteristics	37
Spacial SBM overview	38
Fixing accessories	40

Dimensions

Dimensions	43
------------	----

Metal junction boxes

- PVC sealing gasket for sizes up to 20/15 and a rubber gasket for sizes > 25/20.
- Back ready for threaded drill holes for fixing equipment. From size 15/10 and up, there are four M4 threaded holes fitted with removable plugs for direct fixing of the mounting plate.
- With low cover.
- The SDB series consists of 2 basic models:
 - Without knock-outs: **NSYDB●●●**
 - With knock-outs: **NSYDB●●●M**
- Material: Sheet steel
- Finish: Structured finish, epoxy polyester powder
- Color: RAL 7035 grey
- Ingress protection rating: IP55 according to IEC 60529
- Mechanical protection rating: IK07 according to IEC 62262
- Installation: Indoor installation: Direct wall-mounted by means of drill holes fitted with plastic plugs to ensure sealing compliant with IEC 62208 regarding type tests specified in §9.12 (resistance to ultra-violet (UV) radiation) and §9.13 (resistance to corrosion).

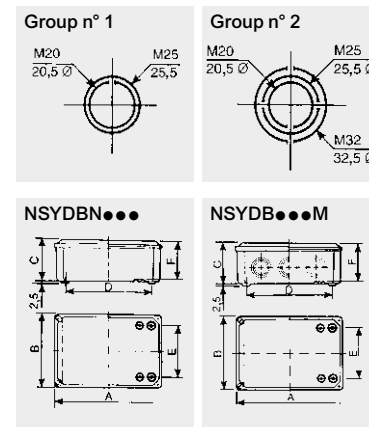

Low cover models without knock-outs



NSYDBN1510

	External dimensions (mm)			Dimensions (mm)			Weight (kg)	References
	Height (A)	Width (B)	Depth (C)	D	E	F		
85	85	49	58	58	-	0.18	NSYDBN88	
105	105	49	76	76	-	0.25	NSYDBN1010	
155	105	61	124	74	56	0.38	NSYDBN1510	
206	156	83	172	122	78	1.00	NSYDBN2015	
256	206	93	220	170	88	1.5	NSYDBN2520	
307	257	116	268	218	110	3.3	NSYDBN3025	

Low cover models with knock-outs



NSYDB2015M

	External dimensions (mm)			Dimensions (mm)			Knock-outs		Weight (kg)	References
	Height (A)	Width (B)	Depth (C)	D	E	F	Height (A)	Width (B)		
85	85	49	58	58	-	1 n° 1	1 n° 1	0.18	NSYDB88M	
105	105	49	76	76	-	2 n° 1	1 n° 1	0.25	NSYDB1010M	
155	105	61	124	74	56	3 n° 1	1 n° 1	0.38	NSYDB1510M	
206	156	83	172	122	78	3 n° 2	2 n° 2	1.00	NSYDB2015M	

Metal Junction Boxes

Spacial SDB

Plain mounting plates for SDB junction boxes

for models without knock-outs	for models with knock-outs	References
NSYDBN1510	NSYDB1510M	NSYPMD1510
NSYDBN2015	NSYDB2015M	NSYPMD2015
NSYDBN2520	-	NSYPMD2520
NSYDBN3025	-	NSYPMD3025

Simplicity, ergonomics and versatility, it's all in the box.

This range can be configured according to your needs

4 different services available:



Assemble to order



Mounting of standard accessories



Painting



Machining



Modularity

- 28 sizes available.

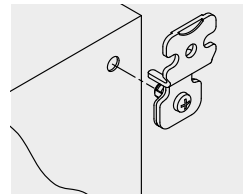

Easy installation

- Direct mounting through the rear.
- Mounting with versatile external lugs.



Added value to your work

- Quality and aesthetics.

Sturdy and good ingress protection

- Mechanical protection rating up to IK10.
- Ingress protection rating up to IP66.



Ergonomics

- Cover opening and accessory mounting with just a screwdriver.



Characteristics	Spacial SBM - Flat box with plain cover
Box body	Single-piece body (cross-shaped structure). Front design incorporating folded gutters. Flat rear. 2 (or 3 profiles for width 800 mm) drilled profiles for installing mounting plates and DIN rails, with mounting centers of 12.5 mm.
Box cover	Equipped with 4 or 6 half-turn thread screws, according to the version (6 screws for width greater than 400 mm) to ensure maximum watertightness. Polyurethane sealing gasket.
Protection of personnel	Ground connection mandatory for all boxes: Spacial SBM steel boxes are equipped with a M6 x 16 ground stud welded in the cover, to be linked with the body for equipotential connection. Grounding strap to be ordered separately (Ø 6.4 mm terminal).
Material	Sheet steel
Finish	Structured finish, epoxy polyester powder
Color	RAL 7035 grey
Ingress protection rating	<ul style="list-style-type: none"> • IP66 according to IEC 60529 • Types 4, 4X according to UL50E
Mechanical protection rating	IK10 according to IEC 62262
Standard	Compliance with enclosure standard IEC 62208 and the RoHS directive
Certifications (see page 712)	<ul style="list-style-type: none"> • UL (cULus), BVM, LR, DNV, TUV
Indoor installation	Direct wall-mounted (4 x Ø 10 mm holes) or with mounting lugs installed from the outside (to be ordered separately, see specific accessory pages).
Maximum load	Loading capacity on the body: 50 kg/m ²
Vibration constraints	Specific construction of the Spacial SBM - single-piece body (rectangular structure). The rear is flat without added parts - this ensures compliance with certain vibration constraints.
Seismic behaviour	<p>The seismic behavior of the industrial boxes Spacial SBM have been qualified according to MRI spectra "big material" specified in the standard IEC 60068-2-6 and IEC 60068-2-57 (see page 450 for more details). Tested enclosure configuration:</p> <ul style="list-style-type: none"> • Plain door, • Plain mounting plate with a load of 200 kg/m² uniformly distributed on the mounting plate, • Fixing to the wall with M8 screws (tightening torque: 12 Nm ± 1 Nm). <p>Level of the seismic behavior obtained:</p> <ul style="list-style-type: none"> • 1G for boxes with the following dimensions: <ul style="list-style-type: none"> - height = 400 mm and width ≥ 500 mm - height = 300 mm and width ≥ 600 mm - height = 200 mm and width = 800 mm • 3G for other dimension

SBM



Standard Bus box
phased out



Dimensions (mm)			Cover screws Bus Boxes phased out divide by 2	Flat box	Mounting plate without screws	DIN rail 10 rails, supplied without screws	Post mounting
Height	Width	Depth					
150	150	80	4	NSYSBM15158	NSYMM11SB	NSYAMRD15357SB	NSYSFPSC15
150	150	120	4	NSYSBM151512	NSYMM11SB	NSYAMRD15357SB	NSYSFPSC15
150	200	80	4	NSYSBM15208	NSYMM12SB	NSYAMRD20357SB	NSYSFPSC20
150	200	120	4	NSYSBM152012	NSYMM12SB	NSYAMRD20357SB	NSYSFPSC20
150	300	80	4	NSYSBM15308	NSYMM13SB	NSYAMRD30357SB	NSYSFPSC30
150	300	120	4	NSYSBM153012	NSYMM13SB	NSYAMRD30357SB	NSYSFPSC30
150	400	80	4	NSYSBM15408	NSYMM14SB	NSYAMRD40357SB	NSYSFPSC40
150	400	120	4	NSYSBM154012	NSYMM14SB	NSYAMRD40357SB	NSYSFPSC40
200	200	80	4	NSYSBM20208	NSYMM22SB	NSYAMRD20357SB	NSYSFPSC20
200	200	120	4	NSYSBM202012	NSYMM22SB	NSYAMRD20357SB	NSYSFPSC20
200	300	80	4	NSYSBM20308	NSYMM23SB	NSYAMRD30357SB	NSYSFPSC30
200	300	120	4	NSYSBM203012	NSYMM23SB	NSYAMRD30357SB	NSYSFPSC30
200	400	80	4	NSYSBM20408	NSYMM24SB	NSYAMRD40357SB	NSYSFPSC40
200	400	120	4	NSYSBM204012	NSYMM24SB	NSYAMRD40357SB	NSYSFPSC40
200	500	80	6	NSYSBM20508	NSYMM25SB	NSYAMRD50357SB	NSYSFPSC50
200	500	120	6	NSYSBM205012	NSYMM25SB	NSYAMRD50357SB	NSYSFPSC50
200	600	80	6	NSYSBM20608	NSYMM26SB	NSYAMRD60357SB	NSYSFPSC60
200	600	120	6	NSYSBM206012	NSYMM26SB	NSYAMRD60357SB	NSYSFPSC60
200	800	120	6	NSYSBM208012	NSYMM28SB	NSYAMRD80357SB	NSYSFPSC80
300	300	120	4	NSYSBM303012	NSYMM33SB	NSYAMRD30357SB	NSYSFPSC30
300	400	120	4	NSYSBM304012	NSYMM34SB	NSYAMRD40357SB	NSYSFPSC40
300	500	120	6	NSYSBM305012	NSYMM35SB	NSYAMRD50357SB	NSYSFPSC50
300	600	120	6	NSYSBM306012	NSYMM36SB	NSYAMRD60357SB	NSYSFPSC60
300	800	120	6	NSYSBM308012	NSYMM38SB	NSYAMRD80357SB	NSYSFPSC80
400	400	120	4	NSYSBM404012	NSYMM44SB	NSYAMRD40357SB	NSYSFPSC40
400	500	120	6	NSYSBM405012	NSYMM45SB	NSYAMRD50357SB	NSYSFPSC50
400	600	120	6	NSYSBM406012	NSYMM46SB	NSYAMRD60357SB	NSYSFPSC60
400	800	120	6	NSYSBM408012	NSYMM48SB	NSYAMRD80357SB	NSYSFPSC80

Flat boxes (SBM)



NSYSBM15158

Characteristics	Height (mm)	Width (mm)	Depth (mm)	Power dissipation	Sheet thickness	References
Flat box IP66 IK10 RAL 7035, 4 screws f. cover	150	150	80	13.5	10/10°	NSYSBM15158
Flat box IP66 IK10 RAL 7035, 4 screws f. cover	150	150	120	17.2	10/10°	NSYSBM151512
Flat box IP66 IK10 RAL 7035, 4 screws f. cover	150	200	80	16.6	10/10°	NSYSBM15208
Flat box IP66 IK10 RAL 7035, 4 screws f. cover	150	200	120	20.8	10/10°	NSYSBM152012
Flat box IP66 IK10 RAL 7035, 4 screws f. cover	150	300	80	22.8	10/10°	NSYSBM15308
Flat box IP66 IK10 RAL 7035, 4 screws f. cover	150	300	120	28.1	10/10°	NSYSBM153012
Flat box IP66 IK10 RAL 7035, 4 screws f. cover	150	400	80	29.0	10/10°	NSYSBM15408
Flat box IP66 IK10 RAL 7035, 4 screws f. cover	150	400	120	35.3	10/10°	NSYSBM154012
Flat box IP66 IK10 RAL 7035, 4 screws f. cover	200	200	80	20.6	10/10°	NSYSBM20208
Flat box IP66 IK10 RAL 7035, 4 screws f. cover	200	200	120	25.6	10/10°	NSYSBM202012
Flat box IP66 IK10 RAL 7035, 4 screws f. cover	200	300	80	28.2	10/10°	NSYSBM20308
Flat box IP66 IK10 RAL 7035, 4 screws f. cover	200	300	120	34.2	10/10°	NSYSBM203012
Flat box IP66 IK10 RAL 7035, 4 screws f. cover	200	400	80	35.7	10/10°	NSYSBM20408
Flat box IP66 IK10 RAL 7035, 4 screws f. cover	200	400	120	42.8	10/10°	NSYSBM204012
Flat box IP66 IK10 RAL 7035, 6 screws f. cover	200	500	80	43.3	12/10°	NSYSBM20508
Flat box IP66 IK10 RAL 7035, 6 screws f. cover	200	500	120	51.4	12/10°	NSYSBM205012
Flat box IP66 IK10 RAL 7035, 6 screws f. cover	200	600	80	50.8	12/10°	NSYSBM20608
Flat box IP66 IK10 RAL 7035, 6 screws f. cover	200	600	120	60.1	12/10°	NSYSBM206012
Flat box IP66 IK10 RAL 7035, 6 screws f. cover	200	800	120	77.3	12/10°	NSYSBM208012
Flat box IP66 IK10 RAL 7035, 4 screws f. cover	300	300	120	46.4	10/10°	NSYSBM303012
Flat box IP66 IK10 RAL 7035, 4 screws f. cover	300	400	120	57.8	10/10°	NSYSBM304012
Flat box IP66 IK10 RAL 7035, 6 screws f. cover	300	500	120	69.1	12/10°	NSYSBM305012
Flat box IP66 IK10 RAL 7035, 6 screws f. cover	300	600	120	80.4	12/10°	NSYSBM306012
Flat box IP66 IK10 RAL 7035, 6 screws f. cover	300	800	120	103.0	12/10°	NSYSBM308012
Flat box IP66 IK10 RAL 7035, 4 screws f. cover	400	400	120	72.7	10/10°	NSYSBM404012
Flat box IP66 IK10 RAL 7035, 6 screws f. cover	400	500	120	86.7	12/10°	NSYSBM405012
Flat box IP66 IK10 RAL 7035, 6 screws f. cover	400	600	120	100.7	12/10°	NSYSBM406012
Flat box IP66 IK10 RAL 7035, 6 screws f. cover	400	800	120	128.7	12/10°	NSYSBM408012

Mounting plate

- Material: Galvanized steel
- Installation: Mounting by means of 2* or 4 x Ø 5 mm self-tapping screws, Pozidriv head, ref. **NSYAMFSB**. Attachment points compatible with many other brands of accessories

Supply:

1 unit, supplied without screws



NSYMM11SB

Characteristics	Height (mm)	Width (mm)	References
Mounting plate	125	135	NSYMM11SB
Mounting plate	125	185	NSYMM12SB
Mounting plate	125	285	NSYMM13SB
Mounting plate	125	385	NSYMM14SB
Mounting plate	175	185	NSYMM22SB
Mounting plate	175	265	NSYMM23SB
Mounting plate	175	385	NSYMM24SB
Mounting plate	175	485	NSYMM25SB
Mounting plate	175	585	NSYMM26SB
Mounting plate	175	785	NSYMM28SB
Mounting plate	275	285	NSYMM33SB
Mounting plate	275	385	NSYMM34SB
Mounting plate	275	485	NSYMM35SB
Mounting plate	275	585	NSYMM36SB
Mounting plate	275	785	NSYMM38SB
Mounting plate	375	385	NSYMM44SB
Mounting plate	375	485	NSYMM45SB
Mounting plate	375	585	NSYMM46SB
Mounting plate	375	785	NSYMM48SB

Symmetrical DIN rails 35 x 7.5 mm

- Material: Galvanized steel
- Installation: Mounting by means of 2 x Ø 5 mm self-tapping screws, Pozidriv head, ref. **NSYAMFSB**
- All boxes are delivered with 5 x Ø 5 mm self-tapping screws.

Supply:
10 rails, supplied without screws



NSYAMRD15357SB

Characteristics	Height (mm)	Width (mm)	References
Symmetrical DIN rail	35	150	NSYAMRD15357SB
Symmetrical DIN rail	35	200	NSYAMRD20357SB
Symmetrical DIN rail	35	300	NSYAMRD30357SB
Symmetrical DIN rail	35	400	NSYAMRD40357SB
Symmetrical DIN rail	35	200	NSYAMRD20357SB
Symmetrical DIN rail	35	300	NSYAMRD30357SB
Symmetrical DIN rail	35	400	NSYAMRD40357SB
Symmetrical DIN rail	35	500	NSYAMRD50357SB
Symmetrical DIN rail	35	600	NSYAMRD60357SB
Symmetrical DIN rail	35	800	NSYAMRD80357SB
Symmetrical DIN rail	35	300	NSYAMRD30357SB
Symmetrical DIN rail	35	400	NSYAMRD40357SB
Symmetrical DIN rail	35	500	NSYAMRD50357SB
Symmetrical DIN rail	35	600	NSYAMRD60357SB
Symmetrical DIN rail	35	800	NSYAMRD80357SB
Symmetrical DIN rail	35	400	NSYAMRD40357SB
Symmetrical DIN rail	35	500	NSYAMRD50357SB
Symmetrical DIN rail	35	600	NSYAMRD60357SB
Symmetrical DIN rail	35	800	NSYAMRD80357SB

Post mounting

- Material: Zinc-plated steel
- Rail mounted externally to the rear of the box with 8 mm screws for installation on posts with diameters between 150 mm and 215 mm.
- For steel boxes with widths of 150, 200, 300, 400, 500, 600 and 800 mm.
- Maximum load: 100 kg

Supply:
1 unit



NSYSFPSC15

Characteristics	Height (mm)	Width (mm)	References
Post mounting	45	150	NSYSFPSC15
Post mounting	45	200	NSYSFPSC20
Post mounting	45	300	NSYSFPSC30
Post mounting	45	400	NSYSFPSC40
Post mounting	45	500	NSYSFPSC50
Post mounting	45	600	NSYSFPSC60
Post mounting	45	800	NSYSFPSC80

Mounting lugs

- Wall-mounted lugs to be mounted directly on the rear of the box, either in horizontal or vertical position. Their versatile design complies with the mounting dimensions of many other enclosures.
- Ingress protection rating: IP66 according to IEC 60529
- Installation: Horizontal or vertical position, distance between wall and enclosure: 12 mm, only requires a screw driver
- Maximum load: 70 kg

Supply:

4 wall-mounted lugs, screws and pre-mounted sealing gaskets



NSYAEFPFSB

Characteristics	References
wall-mounted lugs	NSYAEFPFSB

Self-tapping screws

- Same reference for all enclosure dimensions
- Self-tapping, Pozidriv head, screws, for Ø 5 mm holes.

Supply:

100 units



NSYAMFSB

Characteristics	References
Self-tapping screws	NSYAMFSB

Hinges

- The hinges allow the cover to be opened by more than 180°.
 - They can be installed on all covers of the range.
 - Ingress protection rating: IP66 according to IEC 60529
- Installation:**
- The box must be drilled before installing the 2 or 3 hinges on the body.
 - 3 hinges are required for boxes of width more than 500 mm
 - A specific mark on the body helps to locate where the hole should be drilled
 - Maximum load: 30 kg/m² on the hinged cover
 - Same reference for all enclosure dimensions

Supply:

Set of 6 hinges delivers with fixing hardware



NSYAEHHSB

Characteristics	References
Hinges SBM	NSYAEHHSB

Head screws

- The standard Pozidriv head screws can be replaced with the Double-bar or triangular shaped head screws, to discourage unauthorised opening of the cover with normal screwdrivers.
- Ingress protection rating: IP66 according to IEC 60529
- Installation: Simply replace the standard screw on the box
- Same reference for all enclosure dimensions

Supply:

1 unit



NSYAEDSBSB

NSYAEDSTSB

Characteristics	References
Double-bar shaped head 3 mm screw	NSYAEDSBSB
Triangular shaped head 6.5 mm screw	NSYAEDSTSB

Sealing kit

- The sealing kit helps to set up a lead-sealed cable of cover opening.
- Color: Green
- Ingress protection rating: IP66 according to IEC 60529
- Installation: Replaces the standard sealing washer on the box
- Same reference for all enclosure dimensions

Supply:

1 unit



NSYPPSB

Characteristics	References
Sealing kit SBM	NSYPPSB

Steel Industrial Boxes

Spacial SBM, Dimensions

Section A-A

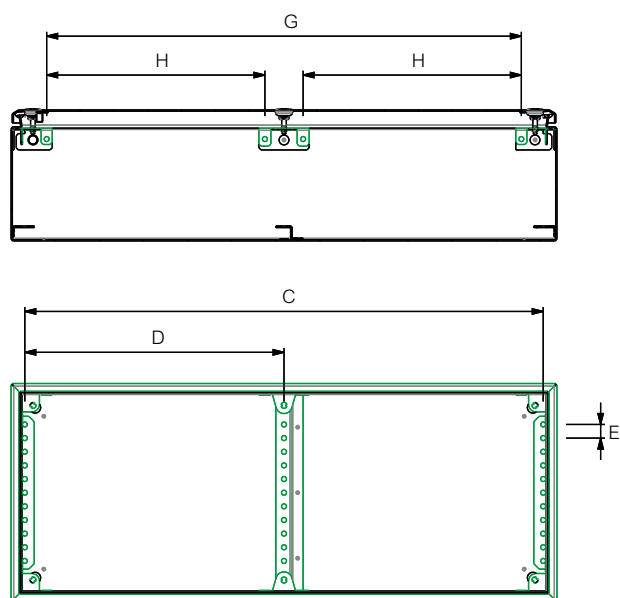

Section B-B

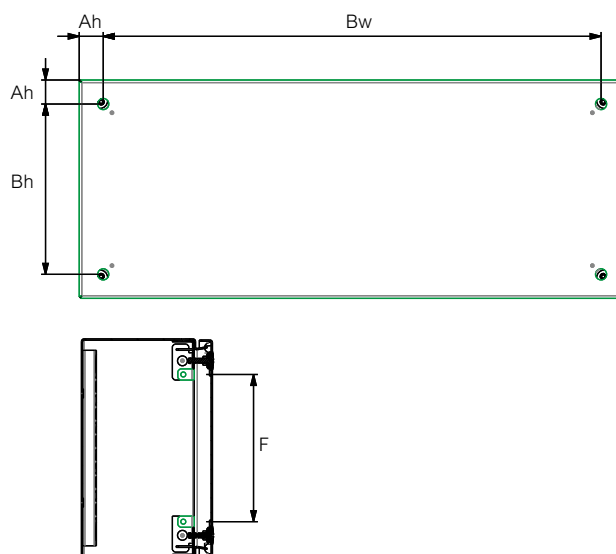

External mounting of the box and mounting accessories

Box		Mounting								
Height	Width	Ah	Bh	Bw	C	D	E	F	G	H
150 mm	150 mm	20.5 mm	109 mm	109 mm	125 mm	-	12.5 mm	85 mm	85 mm	-
	200 mm	20.5 mm	109 mm	159 mm	175 mm	-	12.5 mm	85 mm	135 mm	-
	300 mm	20.5 mm	109 mm	259 mm	275 mm	-	12.5 mm	85 mm	235 mm	-
	400 mm	20.5 mm	109 mm	359 mm	375 mm	-	12.5 mm	85 mm	335 mm	-
200 mm	200 mm	20.5 mm	159 mm	159 mm	175 mm	-	12.5 mm	135 mm	135 mm	-
	300 mm	20.5 mm	159 mm	259 mm	275 mm	-	12.5 mm	135 mm	235 mm	-
	400 mm	20.5 mm	159 mm	359 mm	375 mm	-	12.5 mm	135 mm	335 mm	-
	500 mm	20.5 mm	159 mm	459 mm	475 mm	-	12.5 mm	135 mm	435 mm	200 mm
	600 mm	20.5 mm	159 mm	559 mm	575 mm	-	12.5 mm	135 mm	535 mm	250 mm
	800 mm	20.5 mm	159 mm	759 mm	775 mm	387.5 mm	12.5 mm	135 mm	735 mm	350 mm
300 mm	300 mm	20.5 mm	259 mm	259 mm	275 mm	-	12.5 mm	235 mm	235 mm	-
	400 mm	20.5 mm	259 mm	359 mm	375 mm	-	12.5 mm	235 mm	335 mm	-
	500 mm	20.5 mm	259 mm	459 mm	475 mm	-	12.5 mm	235 mm	435 mm	200 mm
	600 mm	20.5 mm	259 mm	559 mm	575 mm	-	12.5 mm	235 mm	535 mm	250 mm
	800 mm	20.5 mm	259 mm	759 mm	775 mm	387.5 mm	12.5 mm	235 mm	735 mm	350 mm
400 mm	400 mm	20.5 mm	359 mm	359 mm	375 mm	-	12.5 mm	335 mm	335 mm	-
	500 mm	20.5 mm	359 mm	459 mm	475 mm	-	12.5 mm	335 mm	435 mm	200 mm
	600 mm	20.5 mm	359 mm	559 mm	575 mm	-	12.5 mm	335 mm	535 mm	250 mm
	800 mm	20.5 mm	359 mm	759 mm	775 mm	387.5 mm	12.5 mm	335 mm	735 mm	350 mm

Technical changes reserved. Information provided without guarantee. Images are for illustrative purposes only.

Steel Wall-Mounted Enclosures

2

Spacial CRN

Enclosure for indoor
non-clean industrial environment



Spacial S3D

Enclosure for indoor
non-clean industrial environment



Spacial CRN

Introduction	46
Characteristics	47
Selection guide	48
Accessories	57
Dimensions	68

Spacial S3D

Introduction	72
Characteristics	73
Selection guide	74
Fixing accessories	79
Plinth	82
Coupling accessories	83
Protection canopy	84
Handles	85
Locks	86
Accessories	88
Dimensions	100

Enclosure for indoor non-clean industrial environment

This range can be configured according to your needs

4 different services available:



Assemble to order



Mounting of standard accessories



Painting



Machining

CRN



CRNG



Built to last

- Industrial welding process.
 - Epoxy-polyester painting.
 - Molded polyurethane gasket.
- These features ensure quality as well as water and dust tightness for years. Front folded gutter prevents the entry of water, oil or liquids, ensuring IP66 protection



Sealed

- Door glazed with tempered glass, water- and dust-tight, IP66 and IK08 protection



Safe

- For people:**
- Two welded M6 x 15 earth studs welded to the back and one M6 x 15 stud on the door
- For your installation:**
- Water and dust tightness IP66
 - Ruggedness IK10 to protect your components from external impact
 - Concealed hinges to prevent removal of the door



Practical

- 4 welded M8 x 15 back studs with 10-mm collar for direct installation of mounting plate



Smart

- Welded door reinforcement profile allowing the fixing of equipment in models from 500 mm in height









Convenient

- Large embedded cable-entry plate with a neoprene gasket, flush with the back of the enclosure
- Direct fixing or using the brackets fixed from outside

See page 546 for details or consult our web site www.se.com







Characteristics	Spacial CRN	Spacial CRNG
	39 dimensions for this metal monobloc. Back piece joined to the sides using a special profile forming a protected sealed area.	<ul style="list-style-type: none"> • 17 dimensions with three-point locking system for this metal construction suite of enclosures • All Spacial CRNG models include a three-point locking system
Material	Steel	
Finish	Structured finish, epoxy-polyester powder	
Color	RAL 7035 grey	
Ingress protection rating	<ul style="list-style-type: none"> • IP66 for one-door enclosures • IP55 for two-door enclosures according to IEC 60529 	
Mechanical protection rating	IK10 for plain door and IK08 for glazed door according to IEC 62262	
Standards	IEC 62208	
Certifications	<ul style="list-style-type: none"> • UL (cULus), CUL • Rating according UL50E :Types 4, and 13 for NSYCRN enclosures, and Types 4, and 13 for single doors NSYCRNG enclosures. • Types 12 and 13 for double-door enclosures according UL50E • RoHS compliance 	
Installation	<ul style="list-style-type: none"> • Given their strength, metal enclosures are particularly well suited to indoor areas where they may experience impacts 	
Supply	<p>Body</p> <ul style="list-style-type: none"> • 4 holes for direct fixing • Wall-fixing drill holes sealed with plastic plugs to ensure the degree of protection (supplied as standard) • Wall-fixing bracket fixed from outside (brackets to be ordered separately) • Direct cable entry • Built-in cable-entry plate, flush with the back of the enclosure (without foamed-in gasket to facilitate machining) • Insulated cable entries with knock-outs, available as an accessory • Easy to equip with 4 welded back studs shouldered 10 mm <p>Door</p> <ul style="list-style-type: none"> • 3-mm standard double-bar lock as standard. (Wide choice of inserts as accessories) • Foamed-in polyurethane gasket on the doors to guarantee water and dust tightness • Easily reversible door, fixed with two or three invisible metal hinges allowing the door to open to 120° • Reinforcement on plain doors with welded perforated door profiles for equipment fixing from models NSYCRN54150 • Welded earth studs on door and body • Delivered with a reusable packaging and technical instructions 	<p>Body</p> <ul style="list-style-type: none"> • 4 holes for direct fixing • Wall-fixing drill holes sealed with plastic plugs to ensure water and dust tightness (supplied as standard) • Wall-fixing bracket fixed from outside, specific for large dimensions (to be ordered separately). • Built-in cable-entry plate, flush with the back of the enclosure (without foamed-in gasket to facilitate machining) • Easy to equip with 4 welded back studs shouldered 10 mm (6 for widths of 1000 mm and 1200 mm) <p>Door</p> <ul style="list-style-type: none"> • Three-point locking system for one and two doors. Standard 5-mm double-bar lock • Door-centering piece on two-door enclosures to ensure proper door alignment • Foamed-in polyurethane gasket on the doors to guarantee water and dust tightness • Reinforcement on plain doors with welded perforated door profiles for equipment fixing • Delivered with a reusable packaging and technical instructions • Easily reversible door, fixed with two or three invisible metal hinges allowing the door to open to 120° • Welded earth studs on door and body

Dimensions						Enclosures			Mounting plates			
Height (A) (mm)	Width (B) (mm)	Depth (C) (mm)	Doors	IP	Weight (kg) ⁽¹⁾							
						with plain door, with mounting plate	with plain door, without mounting plate	with glazed door, with mounting plate	Plain	Silkscreened	Micro-perforated	Telequick
200	200	150	1	66	2.5	-	NSYCRN22150 ⁽²⁾	-	NSYMM22	-	-	-
200	300	150	1	66	3.9	-	NSYCRN23150 ⁽²⁾	-	NSYMM32	-	NSYMF32	-
250	200	150	1	66	3.2	NSYCRN252150P	NSYCRN252150	-	NSYMM2520	-	-	-
300	250	150	1	66	4.2	NSYCRN325150P	NSYCRN325150	NSYCRN325150T	NSYMM3025	-	-	NSYMR3025
300	250	200	1	66	4.9	NSYCRN325200P	NSYCRN325200	NSYCRN325200T	NSYMM3025	-	-	NSYMR3025
300	300	150	1	66	5.0	NSYCRN33150P	NSYCRN33150	NSYCRN33150T	NSYMM33	-	NSYMF33	NSYMR33
300	300	200	1	66	6.0	NSYCRN33200P	NSYCRN33200	NSYCRN33200T	NSYMM33	-	NSYMF33	NSYMR33
300	400	200	1	66	6.4	-	NSYCRN34200	NSYCRN34200T	NSYMM43	NSYMS43	NSYMF43	NSYMR34
300	450	150	1	66	6.7	-	NSYCRN345150	-	NSYMM3045	-	-	-
400	300	150	1	66	6.0	NSYCRN43150P	NSYCRN43150	NSYCRN43150T	NSYMM43	NSYMS43	NSYMF43	NSYMR43
400	300	200	1	66	6.8	NSYCRN43200P	NSYCRN43200	NSYCRN43200T	NSYMM43	NSYMS43	NSYMF43	NSYMR43
400	400	200	1	66	8.0	NSYCRN44200P	NSYCRN44200	NSYCRN44200T	NSYMM44	NSYMS44	NSYMF44	NSYMR44
400	600	250	1	66	10.0	NSYCRN46250P	NSYCRN46250	NSYCRN46250T	NSYMM64	NSYMS64	NSYMF64	NSYMR46
400	600	300	1	66	11.2	-	NSYCRN46300	NSYCRN46300T	NSYMM64	NSYMS64	NSYMF64	NSYMR46
500	400	150	1	66	8.7	NSYCRN54150P	NSYCRN54150	NSYCRN54150T	NSYMM54	NSYMS54	NSYMF54	NSYMR54
500	400	200	1	66	9.8	NSYCRN54200P	NSYCRN54200	NSYCRN54200T	NSYMM54	NSYMS54	NSYMF54	NSYMR54
500	400	250	1	66	11.0	NSYCRN54250P	NSYCRN54250	NSYCRN54250T	NSYMM54	NSYMS54	NSYMF54	NSYMR54
500	500	250	1	66	12.8	NSYCRN55250P	NSYCRN55250	NSYCRN55250T	NSYMM55	NSYMS55	NSYMF55	NSYMR55
600	400	150	1	66	9.3	NSYCRN64150P	NSYCRN64150	NSYCRN64150T	NSYMM64	NSYMS64	NSYMF64	NSYMR64
600	400	200	1	66	10.8	NSYCRN64200P	NSYCRN64200	NSYCRN64200T	NSYMM64	NSYMS64	NSYMF64	NSYMR64
600	400	250	1	66	12.3	NSYCRN64250P	NSYCRN64250	NSYCRN64250T	NSYMM64	NSYMS64	NSYMF64	NSYMR64
600	500	150	1	66	11.3	NSYCRN65150P	NSYCRN65150	NSYCRN65150T	NSYMM65	-	NSYMF65	NSYMR65
600	500	200	1	66	14.3	NSYCRN65200P	NSYCRN65200	NSYCRN65200T	NSYMM65	-	NSYMF65	NSYMR65
600	500	250	1	66	16.2	NSYCRN65250P	NSYCRN65250	NSYCRN65250T	NSYMM65	-	NSYMF65	NSYMR65
600	600	200	1	66	16.3	NSYCRN66200P	NSYCRN66200	NSYCRN66200T	NSYMM66	NSYMS66	NSYMF66	NSYMR66
600	600	250	1	66	18.2	NSYCRN66250P	NSYCRN66250	NSYCRN66250T	NSYMM66	NSYMS66	NSYMF66	NSYMR66
600	600	300	1	66	19.8	NSYCRN66300P	NSYCRN66300	NSYCRN66300T	NSYMM66	NSYMS66	NSYMF66	NSYMR66
600	800	300	1	66	26.0	-	NSYCRN68300	NSYCRN68300T	NSYMM86	NSYMS86	NSYMF86	NSYMR68
700	500	200	1	66	17.3	NSYCRN75200P	NSYCRN75200	NSYCRN75200T	NSYMM75	NSYMS75	NSYMF75	NSYMR75
700	500	250	1	66	19.3	NSYCRN75250P	NSYCRN75250	NSYCRN75250T	NSYMM75	NSYMS75	NSYMF75	NSYMR75
800	600	200	1	66	21.8	NSYCRN86200P	NSYCRN86200	NSYCRN86200T	NSYMM86	NSYMS86	NSYMF86	NSYMR86
800	600	250	1	66	24.8	NSYCRN86250P	NSYCRN86250	NSYCRN86250T	NSYMM86	NSYMS86	NSYMF86	NSYMR86
800	600	300	1	66	26.3	NSYCRN86300P	NSYCRN86300	NSYCRN86300T	NSYMM86	NSYMS86	NSYMF86	NSYMR86
800	800	200	1	66	29.5	NSYCRN88200P	NSYCRN88200	NSYCRN88200T	NSYMM88	-	NSYMF88	NSYMR88
800	800	300	1	66	32.5	NSYCRN88300P	NSYCRN88300	NSYCRN88300T	NSYMM88	-	NSYMF88	NSYMR88
1000	600	250	1	66	28.4	NSYCRN106250P	NSYCRN106250	NSYCRN106250T	NSYMM106	-	NSYMF106	NSYMR106
1000	600	300	1	66	30.6	NSYCRN106300P	NSYCRN106300	NSYCRN106300T	NSYMM106	-	NSYMF106	NSYMR106
1000	800	250	1	66	34.5	NSYCRN108250P	NSYCRN108250	NSYCRN108250T	NSYMM108	-	NSYMF108	NSYMR108
1000	800	300	1	66	37.4	NSYCRN108300P	NSYCRN108300	NSYCRN108300T	NSYMM108	-	NSYMF108	NSYMR108

⁽¹⁾ Enclosure without mounting plate.

⁽²⁾ Two cable gland plates, one on the top, one on the bottom.

			Cable entries					Dimensions		
								Height (A) (mm)	Width (B) (mm)	Depth (C) (mm)
	Bakelite	DIN rail chassis	Aluminum vertical rails ⁽³⁾	Fig.	Type of cable entry	Cable gland plate standard	Cable gland plate insulated			
-	-	-	-	1	0	NSYTLCRNO	-	200	200	150
NSYMB32	-	-	-	1	B	NSYTLCRNB	-	200	300	150
-	-	-	-	1	0	NSYTLCRNO	-	250	200	150
NSYMB3025	-	-	NSYMDVR3	1	A	NSYTLCRNB	NSYTSACRNB	300	250	150
NSYMB3025	-	-	NSYMDVR3	1	A	NSYTLCRNB	NSYTSACRNB	300	250	200
NSYMB33	NSYMD33	-	NSYMDVR3	1	B	NSYTLCRNB	NSYTSACRNB	300	300	150
NSYMB33	NSYMD33	-	NSYMDVR3	1	B	NSYTLCRNB	NSYTSACRNB	300	300	200
NSYMB43	-	-	NSYMDVR3	1	C	NSYTLCRNC	NSYTSACRNC	300	400	200
NSYMB43	-	-	NSYMDVR3	1	B	NSYTLCRNB	NSYTSACRNB	300	450	150
NSYMB43	NSYMD43	-	NSYMDVR4	1	B	NSYTLCRNB	NSYTSACRNB	400	300	150
NSYMB43	NSYMD43	-	NSYMDVR4	1	B	NSYTLCRNB	NSYTSACRNB	400	300	200
-	-	-	NSYMDVR4	1	C	NSYTLCRNC	NSYTSACRNC	400	400	200
NSYMB64	-	-	NSYMDVR4	1	D	NSYTLCRND	NSYTSACRND	400	600	250
NSYMB64	-	-	NSYMDVR4	1	D	NSYTLCRND	NSYTSACRND	400	600	300
NSYMB54	NSYMD54	-	NSYMDVR5	2	B	NSYTLCRNB	NSYTSACRNB	500	400	150
NSYMB54	NSYMD54	-	NSYMDVR5	2	C	NSYTLCRNC	NSYTSACRNC	500	400	200
NSYMB54	NSYMD54	-	NSYMDVR5	2	C	NSYTLCRNC	NSYTSACRNC	500	400	250
-	-	-	NSYMDVR5	2	D	NSYTLCRND	NSYTSACRND	500	500	250
NSYMB64	NSYMD64	-	NSYMDVR6	2	B	NSYTLCRNB	NSYTSACRNB	600	400	150
NSYMB64	NSYMD64	-	NSYMDVR6	2	C	NSYTLCRNC	NSYTSACRNC	600	400	200
NSYMB64	NSYMD64	-	NSYMDVR6	2	C	NSYTLCRNC	NSYTSACRNC	600	400	250
NSYMB65	-	-	NSYMDVR6	2	B	NSYTLCRNB	NSYTSACRNB	600	500	150
NSYMB65	-	-	NSYMDVR6	2	D	NSYTLCRND	NSYTSACRND	600	500	200
NSYMB65	-	-	NSYMDVR6	2	D	NSYTLCRND	NSYTSACRND	600	500	250
-	NSYMD66	-	NSYMDVR6	2	D	NSYTLCRND	NSYTSACRND	600	600	200
-	NSYMD66	-	NSYMDVR6	2	D	NSYTLCRND	NSYTSACRND	600	600	250
-	NSYMD66	-	NSYMDVR6	2	D	NSYTLCRND	NSYTSACRND	600	600	300
-	-	-	NSYMDVR6	2	E	NSYTLCRNC ⁽⁴⁾	NSYTSACRNC	600	800	300
NSYMB75	NSYMD75	-	NSYMDVR7	2	D	NSYTLCRND	NSYTSACRND	700	500	200
NSYMB75	NSYMD75	-	NSYMDVR7	2	D	NSYTLCRND	NSYTSACRND	700	500	250
NSYMB86	NSYMD86	-	NSYMDVR8	2	D	NSYTLCRND	NSYTSACRND	800	600	200
NSYMB86	NSYMD86	-	NSYMDVR8	2	D	NSYTLCRND	NSYTSACRND	800	600	250
NSYMB86	NSYMD86	-	NSYMDVR8	2	D	NSYTLCRND	NSYTSACRND	800	600	300
-	-	-	NSYMDVR8	2	E	NSYTLCRNC ⁽⁴⁾	NSYTSACRNC ⁽⁵⁾	800	800	200
-	-	-	NSYMDVR8	2	E	NSYTLCRNC ⁽⁴⁾	NSYTSACRNC ⁽⁵⁾	800	800	300
NSYMB106	-	-	NSYMDVR10	2	D	NSYTLCRND	NSYTSACRND	1000	600	250
NSYMB106	-	-	NSYMDVR10	2	D	NSYTLCRND	NSYTSACRND	1000	600	300
NSYMB108	NSYMD108	-	NSYMDVR10	2	E	NSYTLCRNC ⁽⁴⁾	NSYTSACRNC ⁽⁵⁾	1000	800	250
NSYMB108	NSYMD108	-	NSYMDVR10	2	E	NSYTLCRNC ⁽⁴⁾	NSYTSACRNC ⁽⁵⁾	1000	800	300

⁽³⁾ Order NSYAMCSF, NSYMDVR12 in steel.

⁽⁴⁾ With two holes.

⁽⁵⁾ For flange openings type E, two NSYTSACRNC are required.

• For other dimensions, see our application offer.

Dimensions				Electric distribution						
Height (mm)	Width (mm)	Depth (mm)	Doors	DLA insulated Distribution chassis	DL metal distribution chassis	DLM metal distribution chassis	Plain cover plate for DLM	Mounting plate for DLM	Blanking plate	
200	200	150	1	-	-	-	-	-	-	
200	300	150	1	-	-	-	-	-	-	
250	200	150	1	-	-	-	-	-	-	
300	250	150	1	-	NSYDLR18	-	-	-	-	
300	250	200	1	-	NSYDLR18	-	-	-	-	
300	300	150	1	-	-	-	-	-	-	
300	300	200	1	-	-	-	-	-	-	
300	400	200	1	-	-	-	-	-	-	
300	450	150	1	-	-	-	-	-	-	
400	300	150	1	NSYDLA24G	NSYDLR24	NSYDLM24	NSYCTL300DLM	NSYPMP300DLM	NSYATP72M	
400	300	200	1	NSYDLA24G	NSYDLR36	NSYDLM24	NSYCTL300DLM	NSYPMP300DLM	NSYATP72M	
400	400	200	1	-	NSYDLR24 ⁽¹⁾	-	-	-	-	
400	600	250	1	-	NSYDLR36 ⁽¹⁾	-	-	-	-	
400	600	300	1	-	-	-	-	-	-	
500	400	150	1	NSYDLA48G	-	NSYDLM48	NSYCTL400DLM	NSYPMP400DLM	NSYATP72M	
500	400	200	1	NSYDLA48G	-	NSYDLM48	NSYCTL400DLM	NSYPMP400DLM	NSYATP72M	
500	400	250	1	NSYDLA48G	NSYDLR48	NSYDLM48	NSYCTL400DLM	NSYPMP400DLM	NSYATP72M	
500	500	250	1	-	NSYDLR48 ⁽¹⁾	-	-	-	-	
600	400	150	1	NSYDLA48PG	-	NSYDLM48P	NSYCTL400DLM	NSYPMP400DLM	NSYATP72M	
600	400	200	1	NSYDLA48PG	-	NSYDLM48P	NSYCTL400DLM	NSYPMP400DLM	NSYATP72M	
600	400	250	1	NSYDLA48PG	NSYDLR64	NSYDLM48P	NSYCTL400DLM	NSYPMP400DLM	NSYATP72M	
600	500	150	1	-	NSYDLR64	-	-	-	-	
600	500	200	1	-	-	-	-	-	-	
600	500	250	1	-	NSYDLR88	-	-	-	-	
600	600	200	1	-	NSYDLR88	NSYDLM84P	NSYCTL600DLM	NSYPMP600DLM	NSYATP72M	
600	600	250	1	-	-	NSYDLM84P	NSYCTL600DLM	NSYPMP600DLM	NSYATP72M	
600	600	300	1	-	-	NSYDLM84P	NSYCTL600DLM	NSYPMP600DLM	NSYATP72M	
600	800	300	1	-	-	-	-	-	-	
700	500	200	1	NSYDLA66G / NSYDLA88G	-	NSYDLM66 / NSYDLM88	NSYCTL500DLM	NSYPMP500DLM	NSYATP72M	
700	500	250	1	NSYDLA66G / NSYDLA88G	-	NSYDLM66 / NSYDLM88	NSYCTL500DLM	NSYPMP500DLM	NSYATP72M	
800	600	200	1	NSYDLA84G / NSYDLA112G	NSYDLR110	NSYDLM84 / NSYDLM112	NSYCTL600DLM	NSYPMP600DLM	NSYATP72M	
800	600	250	1	NSYDLA84G / NSYDLA112G	-	NSYDLM84 / NSYDLM112	NSYCTL600DLM	NSYPMP600DLM	NSYATP72M	
800	600	300	1	NSYDLA84G / NSYDLA112G	NSYDLR135	NSYDLM84 / NSYDLM112	NSYCTL600DLM	NSYPMP600DLM	NSYATP72M	
800	800	200	1	-	-	-	-	-	-	
800	800	300	1	-	-	-	-	-	-	
1000	600	250	1	-	-	NSYDLM168	NSYCTL600DLM	NSYPMP600DLM	NSYATP72M	
1000	600	300	1	-	-	NSYDLM168	NSYCTL600DLM	NSYPMP600DLM	NSYATP72M	
1000	800	250	1	NSYDLA234G	-	NSYDLM240	NSYCTL800DLM	NSYPMP800DLM	NSYATP72M	
1000	800	300	1	NSYDLA234G	-	NSYDLM240	NSYCTL800DLM	NSYPMP800DLM	NSYATP72M	

Technical changes reserved. Information provided without guarantee. Images are for illustrative purposes only.

Electronic and network		Plinths (100 mm)		Plinths (200 mm)		Installation system			Dimensions		
Fixed 19" rack	Swing 19" rack	Single plinths side plate ⁽¹⁾	Single plinths front plate ⁽¹⁾	Single plinths side plate ⁽¹⁾	Single plinths front plate ⁽¹⁾	Inner door	Step slides	Wall-fixing lugs	Height (mm)	Width (mm)	Depth (mm)
-	-	-	-	-	-	-	-	NSYPFCR	200	200	150
-	-	-	-	-	-	-	-	NSYPFCR	200	300	150
-	-	-	-	-	-	-	-	NSYPFCR	250	200	150
-	-	-	-	-	-	-	-	NSYPFCR	300	250	150
-	-	-	-	-	-	-	NSYSDCR200	NSYPFCR	300	250	200
-	-	-	-	-	-	-	-	NSYPFCR	300	300	150
-	-	-	-	-	-	-	NSYSDCR200	NSYPFCR	300	300	200
-	-	-	-	-	-	-	NSYSDCR200	NSYPFCR	300	400	200
-	-	-	-	-	-	-	-	NSYPFCR	300	450	150
-	-	-	-	-	-	NSYPIN43	-	NSYPFCR	400	300	150
-	-	-	-	-	-	NSYPIN43	NSYSDCR200	NSYPFCR	400	300	200
-	-	-	-	-	-	-	NSYSDCR200	NSYPFCR	400	400	200
NSYVDM8UF	NSYVDM7UP	-	-	-	-	-	NSYSDCR250	NSYPFCR	400	600	250
NSYVDM8UF	NSYVDM7UP	NSYSPS3100SD	NSYSPF6100	NSYSPS3200SD	NSYSPF6200	-	NSYSDCR300	NSYPFCR	400	600	300
-	-	-	-	-	-	NSYPIN54	-	NSYPFCR	500	400	150
-	-	-	-	-	-	NSYPIN54	NSYSDCR200	NSYPFCR	500	400	200
-	-	-	-	-	-	NSYPIN54	NSYSDCR250	NSYPFCR	500	400	250
-	-	-	-	-	-	-	NSYSDCR250	NSYPFCR	500	500	250
-	-	-	-	-	-	NSYPIN64	-	NSYPFCR	600	400	150
-	-	-	-	-	-	NSYPIN64	NSYSDCR200	NSYPFCR	600	400	200
-	-	-	-	-	-	NSYPIN64	NSYSDCR250	NSYPFCR	600	400	250
-	-	-	-	-	-	-	-	NSYPFCR	600	500	150
-	-	-	-	-	-	-	NSYSDCR200	NSYPFCR	600	500	200
-	-	-	-	-	-	-	NSYSDCR250	NSYPFCR	600	500	250
NSYVDM12UF	NSYVDM11UP	-	-	-	-	-	NSYSDCR200	NSYPFCR	600	600	200
NSYVDM12UF	NSYVDM11UP	-	-	-	-	-	NSYSDCR250	NSYPFCR	600	600	250
NSYVDM12UF	NSYVDM11UP	NSYSPS3100SD	NSYSPF6100	NSYSPS3200SD	NSYSPF6200	-	NSYSDCR300	NSYPFCR	600	600	300
-	-	NSYSPS3100SD	NSYSPF8100	NSYSPS3200SD	NSYSPF8200	-	NSYSDCR300	NSYPFCR	600	800	300
-	-	-	-	-	-	NSYPIN75	NSYSDCR200	NSYPFCR	700	500	200
-	-	-	-	-	-	NSYPIN75	NSYSDCR250	NSYPFCR	700	500	250
NSYVDM17UF	-	-	-	-	-	NSYPIN86	NSYSDCR200	NSYPFCR	800	600	200
NSYVDM17UF	NSYVDM16UP	-	-	-	-	NSYPIN86	NSYSDCR250	NSYPFCR	800	600	250
NSYVDM17UF	NSYVDM16UP	NSYSPS3100SD	NSYSPF6100	NSYSPS3200SD	NSYSPF6200	NSYPIN86	NSYSDCR300	NSYPFCR	800	600	300
-	-	-	-	-	-	-	NSYSDCR200	NSYPFCR	800	800	200
-	-	NSYSPS3100SD	NSYSPF8100	NSYSPS3200SD	NSYSPF8200	-	NSYSDCR300	NSYPFCR	800	800	300
NSYVDM21UF	NSYVDM20UP	-	-	-	-	NSYPIN106	NSYSDCR250	NSYPFCR	1000	600	250
NSYVDM21UF	NSYVDM20UP	NSYSPS3100SD	NSYSPF6100	NSYSPS3200SD	NSYSPF6200	NSYPIN106	NSYSDCR300	NSYPFCR	1000	600	300
-	NSYVDM20U8P	-	-	-	-	NSYPIN108	NSYSDCR250	NSYPFCR	1000	800	250
-	NSYVDM20U8P	NSYSPS3100SD	NSYSPF8100	NSYSPS3200SD	NSYSPF8200	NSYPIN108	NSYSDCR300	NSYPFCR	1000	800	300

⁽¹⁾ To install the plinth to a wall-mounted enclosure, order ref. NSYAPFWM.





Dimensions			Post-fixing	Supporting pole	Canopies	Support bracket	
Height (mm)	Width (mm)	Depth (mm)	Post-fixing device	Supporting pole	Coupling plates	Canopies	Support bracket for enclosure with anti-tilt kit and reinforcement 1400 mm ⁽²⁾
200	200	150	-	-	-	-	NSYCOCNS1400
200	300	150	-	-	-	-	NSYCOCNS1400
250	200	150	-	-	-	NSYTJ2015	NSYCOCNS1400
300	250	150	-	NSYCOCN80	NSYCHCOA	NSYTJ2515	NSYCOCNS1400
300	250	200	-	NSYCOCN80	NSYCHCOA	NSYTJ2520	NSYCOCNS1400
300	300	150	NSYSFPSC30	NSYCOCN80	NSYCHCOB	NSYTJ3015	NSYCOCNS1400
300	300	200	NSYSFPSC30	NSYCOCN80	NSYCHCOB	NSYTJ3020	NSYCOCNS1400
300	400	200	NSYSFPSC40	NSYCOCN80	NSYCHCOC	NSYTJ4020	NSYCOCNS1400
300	450	150	-	-	-	-	NSYCOCNS1400
400	300	150	NSYSFPSC30	NSYCOCN80	NSYCHCOB	NSYTJ3015	NSYCOCNS1400
400	300	200	NSYSFPSC30	NSYCOCN80	NSYCHCOB	NSYTJ3020	NSYCOCNS1400
400	400	200	NSYSFPSC40	NSYCOCN80	NSYCHCOC	NSYTJ4020	NSYCOCNS1400
400	600	250	NSYSFPSC60	NSYCOCN80	NSYCHCOD	NSYTJ6025	NSYCOCNS1400
400	600	300	NSYSFPSC60	NSYCOCN80	NSYCHCOD	NSYTJ6030	NSYCOCNS1400
500	400	150	NSYSFPSC40	NSYCOCN80	NSYCHCOB	NSYTJ4015	NSYCOCNS1400
500	400	200	NSYSFPSC40	NSYCOCN80	NSYCHCOC	NSYTJ4020	NSYCOCNS1400
500	400	250	NSYSFPSC40	NSYCOCN80	NSYCHCOC	NSYTJ4025	NSYCOCNS1400
500	500	250	NSYSFPSC50	NSYCOCN80	NSYCHCOD	NSYTJ5025	NSYCOCNS1400
600	400	150	NSYSFPSC40	NSYCOCN80	NSYCHCOB	NSYTJ4015	NSYCOCNS1400
600	400	200	NSYSFPSC40	NSYCOCN80	NSYCHCOC	NSYTJ4020	NSYCOCNS1400
600	400	250	NSYSFPSC40	NSYCOCN80	NSYCHCOC	NSYTJ4025	NSYCOCNS1400
600	500	150	NSYSFPSC50	NSYCOCN80	NSYCHCOB	NSYTJ5015	NSYCOCNS1400
600	500	200	NSYSFPSC50	NSYCOCN80	NSYCHCOD	NSYTJ5020	NSYCOCNS1400
600	500	250	NSYSFPSC50	NSYCOCN80	NSYCHCOD	NSYTJ5025	NSYCOCNS1400
600	600	200	NSYSFPSC60	NSYCOCN80	NSYCHCOD	NSYTJ6020	NSYCOCNS1400
600	600	250	NSYSFPSC60	NSYCOCN80	NSYCHCOD	NSYTJ6025	NSYCOCNS1400
600	600	300	NSYSFPSC60	NSYCOCN80	NSYCHCOD	NSYTJ6030	NSYCOCNS1400
600	800	300	NSYSFPSC80	-	NSYCHCOC ⁽¹⁾	NSYTJ8030	NSYCOCNS1400
700	500	200	NSYSFPSC50	NSYCOCN80	NSYCHCOD	NSYTJ5020	NSYCOCNS1400
700	500	250	NSYSFPSC50	NSYCOCN80	NSYCHCOD	NSYTJ5025	NSYCOCNS1400
800	600	200	NSYSFPSC60	NSYCOCN80	NSYCHCOD	NSYTJ6020	NSYCOCNS1400
800	600	250	NSYSFPSC60	NSYCOCN80	NSYCHCOD	NSYTJ6025	NSYCOCNS1400
800	600	300	NSYSFPSC60	NSYCOCN80	NSYCHCOD	NSYTJ6030	NSYCOCNS1400
800	800	200	NSYSFPSC80	-	NSYCHCOC ⁽¹⁾	NSYTJ8020	NSYCOCNS1400
800	800	300	NSYSFPSC80	-	NSYCHCOC ⁽¹⁾	NSYTJ8030	NSYCOCNS1400
1000	600	250	-	NSYCOCN80	NSYCHCOD	NSYTJ6025	NSYCOCNS1400
1000	600	300	-	NSYCOCN80	NSYCHCOD	NSYTJ6030	NSYCOCNS1400
1000	800	250	-	-	NSYCHCOC ⁽¹⁾	NSYTJ8025	NSYCOCNS1400
1000	800	300	-	-	NSYCHCOC ⁽¹⁾	NSYTJ8030	NSYCOCNS1400



⁽¹⁾ 2 coupling plates and supporting poles are required.

⁽²⁾ Available in version 1800 mm: Ref. **NSYCOCNS1800**.

- With three-point locking system
- Ingress protection rating: IP66 for the single-door enclosures and IP55 for the double-door enclosures, according to IEC 60529 and rated types 4, 4X and 13 for single-door enclosures and 12 and 13 for double-door enclosures, according to UL50E

- For other dimensions, see our application offer.
- Enclosure without mounting plate..
- In inverted use of silkscreened mounting plates, the marking is inverted.

Dimensions							Enclosures		Mounting plates			
Height (mm)	Width (mm)	Depth (mm)	Doors	IP	Weight (kg)							
							with plain door, without mounting plate	with glazed door, with mounting plate	Plain	Silkscreened	Microperforated	Telequick
800	600	400	1	66	30.0		NSYCRNG86400	NSYCRNG86400T	NSYMM86	NSYMS86	NSYMF86	NSYMR86
800	1000	300	2	55	40.0		NSYCRNG810300D	-	NSYMM108	-	NSYMF108	NSYMR810
800	1200	300	2	55	46.0		NSYCRNG812300D	-	NSYMM128	-	NSYMF128	2x NSYMR86 ⁽²⁾
1000	600	400	1	66	36.0		NSYCRNG106400	NSYCRNG106400T	NSYMM106	-	NSYMF106	NSYMR106
1000	800	400	1	66	43.0		NSYCRNG108400	NSYCRNG108400T	NSYMM108	-	NSYMF108	NSYMR108
1000	1000	300	2 ⁽¹⁾	55	47.0		NSYCRNG1010300D	NSYCRNG1010300T	NSYMM1010	-	NSYMF1010	NSYMR1010 ⁽³⁾
1000	1200	300	2	55	55.0		NSYCRNG1012300D	-	NSYMM1210	-	NSYMF1210	NSYMR1012 ⁽³⁾
1000	1200	400	2	55	60.0		NSYCRNG1012400D	-	NSYMM1210	-	NSYMF1210	NSYMR1012 ⁽³⁾
1200	600	300	1	66	37.0		NSYCRNG126300	NSYCRNG126300T	NSYMM126	-	NSYMF126	NSYMR126
1200	600	400	1	66	42.0		NSYCRNG126400	NSYCRNG126400T	NSYMM126	-	NSYMF126	NSYMR126
1200	800	300	1	66	45.0		NSYCRNG128300	NSYCRNG128300T	NSYMM128	-	NSYMF128	NSYMR128
1200	800	400	1	66	50.0		NSYCRNG128400	NSYCRNG128400T	NSYMM128	-	NSYMF128	NSYMR128
1200	1000	300	2	55	56.0		NSYCRNG1210300D	-	NSYMM1210	-	NSYMF1210	NSYMR1210 ⁽³⁾
1200	1000	400	2	55	61.0		NSYCRNG1210400D	-	NSYMM1210	-	NSYMF1210	NSYMR1210 ⁽³⁾
1200	1200	300	2	55	64.0		NSYCRNG1212300D	-	NSYMM1212	-	2x NSYMF126 ⁽²⁾	2x NSYMR126 ⁽²⁾
1200	1200	400	2	55	90.0		NSYCRNG1212400D	-	NSYMM1212	-	2x NSYMF126 ⁽²⁾	2x NSYMR126 ⁽²⁾
1400	1000	300	2	55	80.0		NSYCRNG1410300D	-	NSYMM1410	-	-	NSYMR1410 ⁽³⁾

Dimensions							Cable entries							
Height (mm)	Width (mm)	Depth (mm)	Doors	IP	Weight (kg)									
							Bakelite	DIN rail chassis	Aluminum vertical rails ⁽⁴⁾	Fig.	Type of cable entry	Cable gland plate standard	Cable gland plate with FL cut-out	FlexiCable ⁽⁵⁾
800	600	400	1	66	30.0		NSYMB86	NSYMD86	NSYMDVR8	3	G	NSYTLG	NSYTLG2FL	NSYTLGME
800	1000	300	2	55	40.0		-	-	NSYMDVR8	4	H	NSYTLG	NSYTLG2FL	2x NSYTLGME
800	1200	300	2	55	46.0		-	-	NSYMDVR8	4	H	NSYTLG	NSYTLG2FL	2x NSYTLGME
1000	600	400	1	66	36.0		NSYMB106	-	NSYMDVR10	3	G	NSYTLG	NSYTLG2FL	NSYTLGME
1000	800	400	1	66	43.0		NSYMB108	NSYMD108	NSYMDVR10	4	H	NSYTLG	NSYTLG2FL	2x NSYTLGME
1000	1000	300	2 ⁽¹⁾	55	47.0		NSYMB1210	-	NSYMDVR10	4	H	NSYTLG	NSYTLG2FL	2x NSYTLGME
1000	1200	300	2	55	55.0		NSYMB1210	-	NSYMDVR10	4	H	NSYTLG	NSYTLG2FL	2x NSYTLGME
1000	1200	400	2	55	60.0		-	-	NSYMDVR10	4	H	NSYTLG	NSYTLG2FL	2x NSYTLGME
1200	600	300	1	66	37.0		-	-	NSYMDVR12	3	G	NSYTLG	NSYTLG2FL	NSYTLGME
1200	600	400	1	66	42.0		-	-	NSYMDVR12	3	G	NSYTLG	NSYTLG2FL	NSYTLGME
1200	800	300	1	66	45.0		-	NSYMD128	NSYMDVR12	4	H	NSYTLG	NSYTLG2FL	2x NSYTLGME
1200	800	400	1	66	50.0		-	NSYMD128	NSYMDVR12	4	H	NSYTLG	NSYTLG2FL	2x NSYTLGME
1200	1000	300	2	55	56.0		NSYMB1210	-	NSYMDVR12	4	H	NSYTLG	NSYTLG2FL	2x NSYTLGME
1200	1000	400	2	55	61.0		NSYMB1210	-	NSYMDVR12	4	H	NSYTLG	NSYTLG2FL	2x NSYTLGME
1200	1200	300	2	55	64.0		-	-	NSYMDVR12	4	H	NSYTLG	NSYTLG2FL	2x NSYTLGME
1200	1200	400	2	55	90.0		-	-	NSYMDVR12	4	H	NSYTLG	NSYTLG2FL	2x NSYTLGME
1400	1000	300	2	55	80.0		-	-	-	4	H	NSYTLG	NSYTLG2FL	2x NSYTLGME

⁽¹⁾ Except glazed door in single-door.

⁽²⁾ Order NSYCRNGSDR to mount double mounting plate.

⁽³⁾ Ref. NSYEMR mandatory.

⁽⁴⁾ Order NSYAMCSF, NSYMDVR12 in steel.



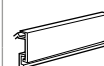

⁽⁵⁾ Cable entry FlexiCable IP55

- With three-point locking system
- For other dimensions, see our application offer.

Electric distribution



Dimensions			Doors	Electric distribution					
Height (mm)	Width (mm)	Depth (mm)		DLA insulated distribution chassis	DL metal distribution chassis	DLM metal distribution chassis	Plain cover plate for DLM	Mounting plate for DLM	Blanking plate
800	600	400	1	NSYDLA84G / NSYDLA112G	-	NSYDLM84 / NSYDLM112	NSYCTL600DLM	NSYPMP600DLM	NSYATP72M
800	1000	300	2	-	-	-	-	-	-
800	1200	300	2	-	-	-	-	-	-
1000	600	400	1	-	-	NSYDLM168	NSYCTL600DLM	NSYPMP600DLM	NSYATP72M
1000	800	400	1	NSYDLA234G	-	NSYDLM240	NSYCTL800DLM	NSYPMP800DLM	NSYATP72M
1000	1000	300	2	-	-	-	-	-	-
1000	1200	300	2	-	-	-	-	-	-
1000	1200	400	2	-	-	-	-	-	-
1200	600	300	1	-	-	-	-	-	-
1200	600	400	1	-	-	-	-	-	-
1200	800	300	1	-	-	-	-	-	-
1200	800	400	1	-	-	-	-	-	-
1200	1000	300	2	-	-	-	-	-	-
1200	1000	400	2	-	-	-	-	-	-
1200	1200	300	2	-	-	-	-	-	-
1200	1200	400	2	-	-	-	-	-	-
1400	1000	300	2	-	-	-	-	-	-

Electronic and network		Plinths (100 mm)		Plinths (200 mm)		Installation system				Dimensions		
										Height (mm)	Width (mm)	Depth (mm)
Fixed 19" rack	Swing 19" rack	Single plinths side plate ⁽¹⁾	Single plinths front plate ⁽¹⁾	Single plinths side plate ⁽¹⁾	Single plinths front plate ⁽¹⁾	Inner door	Step slides	Wall-fixing lugs				
NSYVDM17UF	NSYVDM16UP	NSYSPS4100SD	NSYSPF6100	NSYSPS4200SD	NSYSPF6200	NSYPIN86	NSYSDCR400	NSYAEFPFSC	800	600	400	
-	-	NSYSPS3100SD	NSYSPF10100	NSYSPS3200SD	NSYSPF10200	-	NSYSDCR300	NSYAEFPFSC	800	1000	300	
-	-	NSYSPS3100SD	NSYSPF12100	NSYSPS3200SD	NSYSPF12200	-	NSYSDCR300	NSYAEFPFSC	800	1200	300	
NSYVDM21UF	NSYVDM20UP	NSYSPS4100SD	NSYSPF6100	NSYSPS4200SD	NSYSPF6200	NSYPIN106	NSYSDCR400	NSYAEFPFSC	1000	600	400	
-	NSYVDM20U8P	NSYSPS4100SD	NSYSPF8100	NSYSPS4200SD	NSYSPF8200	NSYPIN108	NSYSDCR400	NSYAEFPFSC	1000	800	400	
-	-	NSYSPS3100SD	NSYSPF10100	NSYSPS3200SD	NSYSPF10200	-	NSYSDCR300	NSYAEFPFSC	1000	1000	300	
-	-	NSYSPS3100SD	NSYSPF12100	NSYSPS3200SD	NSYSPF12200	-	NSYSDCR300	NSYAEFPFSC	1000	1200	300	
-	-	NSYSPS4100SD	NSYSPF12100	NSYSPS4200SD	NSYSPF12200	-	NSYSDCR400	NSYAEFPFSC	1000	1200	400	
-	-	NSYSPS3100SD	NSYSPF6100	NSYSPS3200SD	NSYSPF6200	NSYPIN126	NSYSDCR300	NSYAEFPFSC	1200	600	300	
-	-	NSYSPS4100SD	NSYSPF6100	NSYSPS4200SD	NSYSPF6200	NSYPIN126	NSYSDCR400	NSYAEFPFSC	1200	600	400	
-	NSYVDM25U8P	NSYSPS3100SD	NSYSPF8100	NSYSPS3200SD	NSYSPF8200	NSYPIN128	NSYSDCR300	NSYAEFPFSC	1200	800	300	
-	NSYVDM25U8P	NSYSPS4100SD	NSYSPF8100	NSYSPS4200SD	NSYSPF8200	NSYPIN128	NSYSDCR400	NSYAEFPFSC	1200	800	400	
-	-	NSYSPS3100SD	NSYSPF10100	NSYSPS3200SD	NSYSPF10200	-	NSYSDCR300	NSYAEFPFSC	1200	1000	300	
-	-	NSYSPS4100SD	NSYSPF10100	NSYSPS4200SD	NSYSPF10200	-	NSYSDCR400	NSYAEFPFSC	1200	1000	400	
-	-	NSYSPS3100SD	NSYSPF12100	NSYSPS3200SD	NSYSPF12200	-	NSYSDCR300	NSYAEFPFSC	1200	1200	300	
-	-	NSYSPS4100SD	NSYSPF12100	NSYSPS4200SD	NSYSPF12200	-	NSYSDCR400	NSYAEFPFSC	1200	1200	400	
-	-	NSYSPS3100SD	NSYSPF10100	NSYSPS3200SD	NSYSPF10200	-	NSYSDCR300	NSYAEFPFSC	1400	1000	300	

⁽¹⁾ To install the plinth to a wall-mounted enclosure, order ref. NSYAPFWM.

- With three-point locking system
- For other dimensions see our application offer.

Dimensions			Post-fixing	Canopies	Floor stand kit for WM		Kit for heavy loads
Height (mm)	Width (mm)	Depth (mm)	Post-fixing device	Canopies	300 mm	400 mm	Kit for heavy loads ⁽¹⁾
800	600	400	NSYSFPSC60	NSYTJ6040	-	-	NSYAEFAHLBSC
800	1000	300	-	NSYTJ10030	NSYWWMK33	NSYWWMK34	NSYAEFAHLBSC
800	1200	300	-	NSYTJ12030	NSYWWMK33	NSYWWMK34	NSYAEFAHLBSC
1000	600	400	-	NSYTJ6040	-	-	NSYAEFAHLBSC
1000	800	400	-	NSYTJ8040	NSYWWMK43	NSYWWMK44	NSYAEFAHLBSC
1000	1000	300	-	NSYTJ10030	NSYWWMK33	NSYWWMK34	NSYAEFAHLBSC
1000	1200	300	-	NSYTJ12030	NSYWWMK33	NSYWWMK34	NSYAEFAHLBSC
1000	1200	400	-	NSYTJ12040	NSYWWMK43	NSYWWMK44	NSYAEFAHLBSC
1200	600	300	-	NSYTJ6030	-	-	NSYAEFAHLBSC
1200	600	400	-	NSYTJ6040	-	-	NSYAEFAHLBSC
1200	800	300	-	NSYTJ8030	NSYWWMK33	NSYWWMK34	NSYAEFAHLBSC
1200	800	400	-	NSYTJ8040	NSYWWMK43	NSYWWMK44	NSYAEFAHLBSC
1200	1000	300	-	NSYTJ10030	NSYWWMK33	NSYWWMK34	NSYAEFAHLBSC
1200	1000	400	-	NSYTJ10040	NSYWWMK43	NSYWWMK44	NSYAEFAHLBSC
1200	1200	300	-	NSYTJ12030	NSYWWMK33	NSYWWMK34	NSYAEFAHLBSC
1200	1200	400	-	NSYTJ12040	NSYWWMK43	NSYWWMK44	NSYAEFAHLBSC
1400	1000	300	-	NSYTJ10030	NSYWWMK33	NSYWWMK34	NSYAEFAHLBSC

⁽¹⁾ Order the **NSYAEFPFSC** wall-fixing brackets separately.

Wall-fixing lugs for Spacial CRN and CRNG enclosures

- Set of 4 wall-fixing lugs.
- Mounted directly on the rear of the enclosure, either in horizontal or vertical position.
- Wall-to-enclosure spacing separation of 10 mm.
- Maximum load: 250 kg
- Not suitable for dynamic loads.
- For weights of the Spacial CRN - CRNG enclosures without mounting plate refer to the selection guide

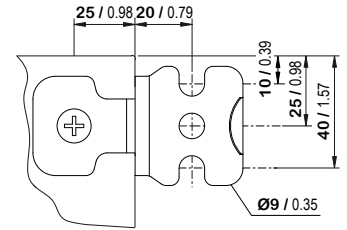

CRN Wall-fixing lugs for Spacial CRN enclosures



- Material: Passivated zinc-coated steel

Characteristics	References
Set of 4 wall fixing lugs for Spacial CRN enclosure	NSYPFCR

Supply:
Supplied with fixing screws and pre-mounted sealing gaskets

CRN Wall-fixing lugs for Spacial CRN enclosures



- Material: Stainless-steel AISI 304L

Characteristics	References
Set of 4 wall fixing brackets in stainless-steel AISI 304L	NSYPFCX

Supply:
Supplied with fixing screws and pre-mounted sealing gaskets

CRN Wall-fixing lugs for Spacial CRN enclosures



- Material: Stainless-steel AISI 316L

Characteristics	References
Set of 4 wall fixing brackets in stainless-steel AISI 316L	NSYPFC2X

Supply:
Supplied with fixing screws and pre-mounted sealing gaskets

CRNG Wall-fixing lugs for Spacial CRNG enclosures



- Material: Passivated zinc-coated steel

Characteristics	References
Set of 4 wall fixing lugs, made of steel	NSYAEFFPFC

Supply:
Supplied with fixing screws and pre-mounted sealing gaskets

CRNG Wall-fixing lugs for Spacial CRNG enclosures



- Material: Stainless-steel AISI 304L

Characteristics	References
Set of 4 wall fixing lugs, made of stainless-steel AISI 304L	NSYAEFFFXSC

Supply:
Supplied with fixing screws and pre-mounted sealing gaskets

CRNG Covers for wall fixing brackets



- Material: PA

Characteristics	References
Set of 4 covers for wall fixing brackets for Spacial S3D/CRN	NSYCAEFPF

Supply:
Kit of 4 covers

CRNG Kit for heavy loads



- Set of 2 reinforcement pieces.
- To be mounted before installing the mounting plate in top position with the standard lugs (to be ordered separately).
- Material: Passivated zinc-coated steel
- Maximum load: 400 kg

Characteristics	References
Kit for heavy load	NSYAEFAHLBSC

Supply:
Kit composed with 2 brackets

Post-fixing device for Spacial steel enclosure

- For indoor installations on posts with a maximum circumference of 675 mm (minimum diameter 150 mm and maximum diameter 215 mm).
- Rail fixed to the inserts in the rear of the enclosure with 8-mm screws.
- They allow the mounting of protection canopies.
- Material: Galvanized steel
- Maximum load: 100 kg

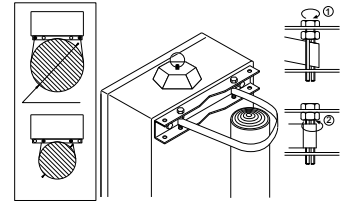
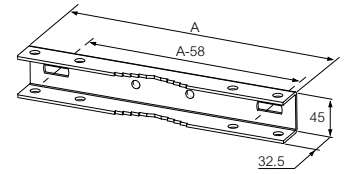

For more details see [page 70](#)



NSYSFPSC30

Characteristics	Width (mm)	A (mm)	References
Post-fixing device for Spacial steel enclosure	300	295	NSYSFPSC30
Post-fixing device for Spacial steel enclosure	400	395	NSYSFPSC40
Post-fixing device for Spacial steel enclosure	500	495	NSYSFPSC50
Post-fixing device for Spacial steel enclosure	600	595	NSYSFPSC60
Post-fixing device for Spacial steel enclosure	800	795	NSYSFPSC80

Support pillar

- The support pillar is fixed directly to the bottom face of the Spacial steel enclosure by means of an adapter plate. The latter, to be ordered in addition to the pillar, replaces the cable gland plate.
- Overall height of the support foot: 800 mm.
- Mounting possible on all enclosures with dimensions up to 600 x 400 x 250 mm (except 200 x 200 x 150 and 250 x 200 x 150 enclosures).
- Material: Extruded aluminum
- Finish: Epoxy-polyester paint
- Color: RAL 7035 grey

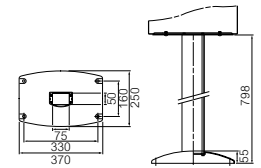

NSYCOCN80

Characteristics	Height (mm)	References
Support pillar	800	NSYCOCN80

Support pillar adaptation plate

- Description: Plate for fixing the support pillar on the enclosure.
- This plate replaces the cable gland plate delivered with the enclosure.
- Material: Steel
- Finish: Polyester powder
- Color: RAL 7035 grey

For more details see [page 68](#)



NSYCHCOA

Characteristics	For enclosure width (mm)	For enclosure depth (mm)	To be coupled with cable entry	References
Support pillar adaptation plate	250	150-200	A	NSYCHCOA
Support pillar adaptation plate	300-400-450-500	150-200	B	NSYCHCOB
Support pillar adaptation plate	400	200-250	C	NSYCHCOC
Support pillar adaptation plate	500-600	200-250-300	D	NSYCHCOD

Support bracket for enclosure with anti-tilt kit and reinforcement

- The support bracket is used when the enclosure cannot be hung from a wall or a post.
- Maximum enclosure dimensions: 1000 x 800 x 300 mm.
- Floor attachment by standard M12 fastenings.
- Material: Steel
- Finish: Epoxy-polyester paint
- Color: RAL 7035 grey
- Maximum load: 120 kg



NSYCOCONS1400

Characteristics	Height (mm)	References
Support bracket for enclosure with anti-tilt kit and reinforcement	1400	NSYCOCONS1400
Support bracket for enclosure with anti-tilt kit and reinforcement	1800	NSYCOCONS1800

Floor Stand Kit for wall-mounted enclosure

- Set of 2 feet, elevating wall-mounted enclosures.
- Cut-outs needed on enclosure – drilling template provided with the kit.
- Material: Steel
- Finish: Epoxy-polyester paint
- Color: RAL 7035 grey
- Thickness: Sides: 2.5 mm, Base: 3 mm
- Maximum load: 250 kg
- Compatible with Spacial S3D, S3DC and CRNG enclosures.
- Enclosure depth 300 mm: When enclosures are equipped with a cable gland plate, it only fits with enclosures of width 800, 1000 and 1200 mm, except model H 600 x W 800 x D 300 mm.
- Enclosure depth 400 mm: When enclosures are equipped with a cable gland plate, it does not fit with enclosures of width 600 mm.

Supply:
2 platform feet (right and left) and fixing elements



NSYWWMK33

Characteristics	Enclosure depth (mm)	(Inches)	Foot height (mm)	(Inches)	References
Floor stand for Spacial S3D	300	12	300	12	NSYWWMK33
Floor stand for Spacial S3D	400	16	300	12	NSYWWMK43
Floor stand for Spacial S3D	300	12	450	18	NSYWWMK34
Floor stand for Spacial S3D	400	16	450	18	NSYWWMK44

Front and rear plinths



Stainless-steel plinths (standard plinths [page 167](#), ventilated plinths [page 441](#)) are compatible with steel wall-mounted S3D enclosures using an earthing cable reference **NSYEL226D13** (description [page 323](#)) to be ordered separately.

- The front and rear of the plinth consists of 4 corners with 2 or 4 panels.
- Material: Folded sheet steel, corner with a thickness of 25/10° mm
- Finish: Structured finish, epoxy-polyester powder
- Color: RAL 7022 grey
- Ingress protection rating: IP30 according to IEC 60529
- Mechanical protection rating: IK10 according to IEC 62262



NSYSPPF6100



NSYSPPF6200

Characteristics	Width (mm)	Height (mm)	References
Front and rear plinths for Spacial	600	100	NSYSPPF6100
Front and rear plinths for Spacial	800	100	NSYSPPF8100
Front and rear plinths for Spacial	1000	100	NSYSPPF10100
Front and rear plinths for Spacial	1200	100	NSYSPPF12100
Front and rear plinths for Spacial	600	200	NSYSPPF6200
Front and rear plinths for Spacial	800	200	NSYSPPF8200
Front and rear plinths for Spacial	1000	200	NSYSPPF10200
Front and rear plinths for Spacial	1200	200	NSYSPPF12200

Installation:

It is necessary to order separately the plinth fixing kit (ref. **NSYAPFWM**) composed by fixing hardware and drilling jig

Note:

For more information see [page 124](#)

Supply:

Height 100 mm: 4 corners, 2 panels (front and rear), 4 corner covers and fixing elements. Height 200 mm: 4 corners, 4 panels (2 front and 2 rear), 4 corner covers and fixing elements

Plinth side panels



NSYSPPS3100SD



NSYSPPS3200SD

- They are fixed to the corner of the plinth by 2 fixing screws.
- Folded sheet steel
- Finish: Structured finish, epoxy-polyester powder
- Color: RAL 7022 grey
- Ingress protection rating: IP30 according to IEC 60529
- Mechanical protection rating: Mechanical protection rating

Supply:

Height 100 mm: 2 side panels, 4 corner covers and fixing elements. Height 200 mm: 4 side panels (height of 100 mm, 2 for each side), 4 corner covers and fixing elements

Characteristics	Depth (mm)	Height (mm)	References
Side plinths for Spacial	300	100	NSYSPPS3100SD
Side plinths for Spacial	400	100	NSYSPPS4100SD
Side plinths for Spacial	300	200	NSYSPPS3200SD
Side plinths for Spacial	400	200	NSYSPPS4200SD

Plinth

- Material: Stainless-steel, AISI 304L or AISI 316L
- Finish: Scotch-Brite® brushing, to guarantee the durability in application where the contact with the floor increases the risk of corrosion



NSYSPPFX8100

Characteristics	Width	Height (mm)	References
Plinth height 100 mm, Kit (4 corners + front and back), AISI 304L	800	100	NSYSPPFX8100
Plinth height 100 mm, Kit (4 corners + front and back), AISI 304L	1000	100	NSYSPPFX10100
Plinth height 100 mm, Kit (4 corners + front and back), AISI 316L	800	100	NSYSPPFX8100H
Plinth height 100 mm, Kit (4 corners + front and back), AISI 316L	1000	100	NSYSPPFX10100H



NSYSPPSX3100

Characteristics	Depth	Height (mm)	References
Plinth height 100 mm, Set of 2 side panels, AISI 304L	300	100	NSYSPPSX3100
Plinth height 100 mm, Set of 2 side panels, AISI 316L	300	100	NSYSPPSX3100H



NSYSPPFX8200

Characteristics	Width	Height (mm)	References
Plinth height 200 mm, Kit (4 corners + front and back), AISI 304L	800	200	NSYSPPFX8200
Plinth height 200 mm, Kit (4 corners + front and back), AISI 304L	1000	200	NSYSPPFX10200
Plinth height 200 mm, Kit (4 corners + front and back), AISI 316L	800	200	NSYSPPFX8200H
Plinth height 200 mm, Kit (4 corners + front and back), AISI 316L	1000	200	NSYSPPFX10200H

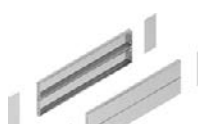

NSYSPPSX3200

Characteristics	Depth	Height (mm)	References
Plinth height 200 mm, Set of 2 side panels (x2), AISI 304L	300	200	NSYSPPSX3200
Plinth height 200 mm, Set of 2 side panels (x2), AISI 316L	300	200	NSYSPPSX3200H

Technical changes reserved. Information provided without guarantee. Images are for illustrative purposes only.

Coupling of Spacial steel enclosures

- Available in 2 versions:
 - Coupling version without cable entry.
 - Version with coupling frame allowing the entry of cables.
- Separation of 17 mm between 2 coupled enclosures, allowing full opening of the doors.
- Allows lateral coupling of 2 enclosures.
- These frames allow the door to open to 120°.
- Material: Fiberglass-reinforced polyester, self-extinguishing
- Ingress protection rating: IP66 according to IEC 60529

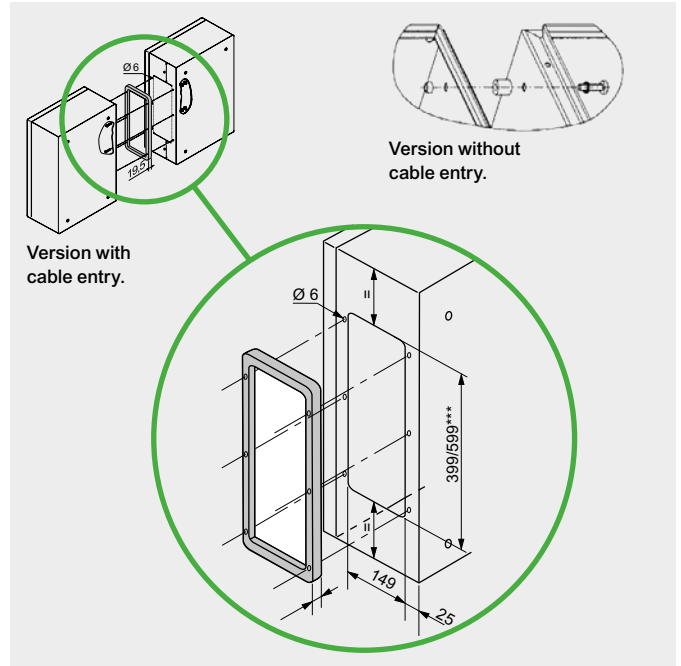

Supply:
Set of 4 spacers and their fixings. Mounting by screws, included

Coupling spacers



NSYAEUBUSC

Characteristics	References
Set of 4 coupling spacers	NSYAEUBUSC

Coupling frame



NSYAEUBU41SC

Characteristics	References
Coupling frame, 435 x 185 mm	NSYAEUBU41SC
Coupling frame, 635 x 185 mm	NSYAEUBU61SC

Eyebolts



NSYAELYTCRG8

- Set of two M8 eyebolts. They are fixed directly to the body of the floor-standing enclosure. Cannot be installed with the canopy in place or if it is planned to put one.
- Material: Zinc-coated molded steel
- Maximum load: 200 kg per enclosure when slinging at 60°

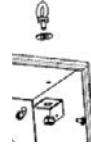

Supply:
Reinforcing brackets attached to the rings (these brackets also act as a drilling template)

Characteristics

Set of 2 M8 eyebolts

References

NSYAELYTCRG8

Protection canopy



NSYTJ2015

- Direct fixing to the body of the enclosure by 4 M6 screws.
- Material: Sheet steel
- Finish: Epoxy-polyester paint
- Color: RAL 7035 grey

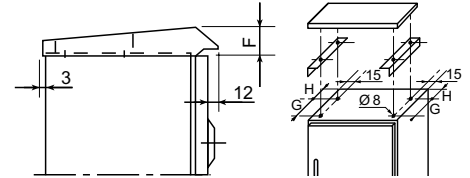

Supply:
Delivered with the fixings required for installation

Characteristics	Width (mm)	Depth (mm)	F (mm)	G (mm)	H (mm)	References
Protection canopy	200	150	36	75	23	NSYTJ2015
Protection canopy	250	150	36	75	23	NSYTJ2515
Protection canopy	300	150	36	75	23	NSYTJ3015
Protection canopy	400	150	36	75	23	NSYTJ4015
Protection canopy	500	150	36	75	23	NSYTJ5015
Protection canopy	500	200	36	130	23	NSYTJ5020
Protection canopy	600	200	36	130	23	NSYTJ6020
Protection canopy	250	200	36	130	23	NSYTJ2520
Protection canopy	300	200	36	130	23	NSYTJ3020
Protection canopy	400	200	36	130	23	NSYTJ4020
Protection canopy	800	200	36	130	23	NSYTJ8020
Protection canopy	400	250	42	150	48	NSYTJ4025
Protection canopy	500	250	42	150	48	NSYTJ5025
Protection canopy	600	250	42	150	48	NSYTJ6025
Protection canopy	800	250	42	150	48	NSYTJ8025
Protection canopy	600	300	42	200	48	NSYTJ6030
Protection canopy	800	300	42	200	48	NSYTJ8030
Protection canopy	1000	300	42	200	48	NSYTJ10030
Protection canopy	1200	300	42	200	48	NSYTJ12030
Protection canopy	600	400	42	300	48	NSYTJ6040
Protection canopy	800	400	42	300	48	NSYTJ8040
Protection canopy	1000	400	42	300	48	NSYTJ10040
Protection canopy	1200	400	42	300	48	NSYTJ12040

Number of modules per chassis** (every 18 mm)

Chassis reference	NSYDLM24	NSYDLM48	NSYDLM48P	NSYDLM84P	NSYDLM66	NSYDLM88	NSYDLM84	NSYDLM112	NSYDLM168	NSYDLM240
Enclosure height (mm)	400	500	600	600	700	700	800	800	1000	1000
Enclosure width (mm)	300	400	400	600	500	500	600	600	600	800
Number of rows	2	3	3	3	3	4	3	4	6	6
Modules per row	12	16	16	28	22	22	28	28	28	39
Total n. of modules	24	48	48	84	66	88	84	112	168	234

Note:

References **NSYDLM48**, **NSYDLM48P** and **NSYDLM84P**, the central row cannot receive modules at the height of the lock (check our technical instructions) when installed at the front of the enclosure. In this case, 1 module is sealed up. ** DLM modular chassis. The provided dimensions are with the modular chassis, which is the most commonly used accessory with this enclosure.

Lock for Spacial CRN enclosure

- **NSYCDB3** 3 mm Ø standard double-bar lock.
- By fixing the wing nut to the lock, the double-bar lock becomes a handle lock.
- Operation using:
wing key ref.: **NSYDBP**
key **NSYLDB5** (according to DIN 43668)
- **NSYTDBC RN** delivered with 1 metal key

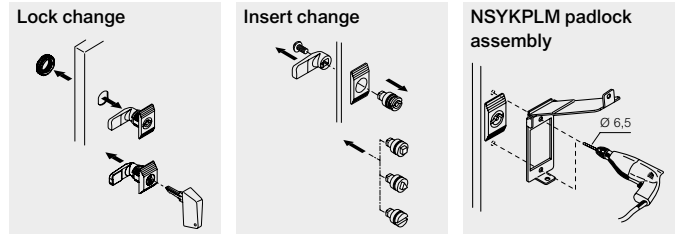

Inserts



Characteristics	Key references	References
3-mm double-bar	NSYLDB5	NSYTDBC RN
6 mm square	NSYLC7	NSYTC6CRN
7 mm square	NSYLC7	NSYTC7CRN
8 mm square	NSYLC8	NSYTC8CRN
6.5 mm triangular	NSYLT8	NSYTT6CRN
7 mm triangular	NSYLT8	NSYTT7CRN
8 mm triangular	NSYLT8	NSYTT8CRN
Screw driver lock		NSYAEDLSD

Keys



- Insert without keys (unless indicated)

Characteristics	References
Metal key for 5-mm double-bar insert	NSYLDB5
Metal key for 7 mm square insert	NSYLC7
Metal key for 8 mm square insert	NSYLC8
Metal key for 8 mm triangle insert	NSYLT8

Complete locks

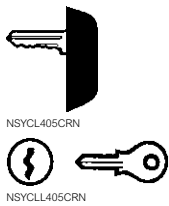

Characteristics	References
Complete manual handle lock, operated with key 405	NSYCL405CRN
Complete manual handle lock, operated with key 220	NSYCL220CRN
Complete metal lock, operated with key 405E	NSYCLL405CRN

Padlocks



Characteristics	References
Padlock device for WM enclosures, Ø 8 mm	NSYKPLM
Padlock for Spacial CRN enclosure, Ø 7.5 mm / Ø 10 mm	NSYCBCCR N

Lock for Spacial CRNG enclosure (three-point lock)

- Standard 5-mm double-bar lock for CRNG models.
- Operation using: Key **NSYLDB5** (according to DIN 43668)

Transformation of the standard lock to standardised variations in enclosures with three-point locks

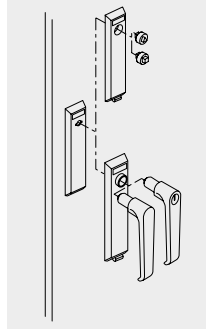

Transformation of the standard lock to a retractable three-point lock with various types of inserts

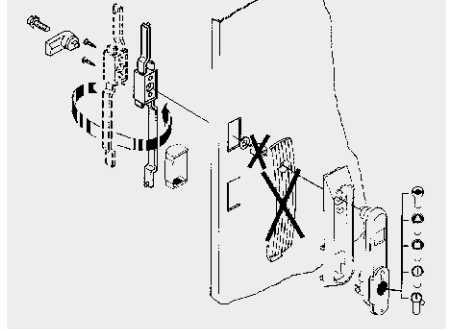

Transformation of the standard lock to standardised variations in enclosures with three-point locks



NSYTC6ML

Type of insert	Key references	References
6 mm square	NSYLC7	NSYTC6ML
7 mm square	NSYLC7	NSYTC7ML
8 mm square	NSYLC8	NSYTC8ML
7 mm side triangle	NSYLT8	NSYTT7ML
8 mm side triangle	NSYLT8	NSYTT8ML

Handle locks for transformation of the standard lock to standardised variations in enclosures with three-point locks



NSYTL405SML

Characteristics	References
Handle lock	NSYTSML
Handle lock operated using key 405 (included)	NSYTL405SML

Transformation of the standard lock to a retractable three-point lock with various types of inserts



NSYTEL405ML

Characteristics	Key references	References
Key operated bar lock	NSYLDB5	NSYTEDB5ML
8 mm square lock	NSYLC8	NSYTEC8ML
7 mm side triangle lock	NSYLT8	NSYET7ML
8 mm side triangle lock	NSYLT8	NSYET8ML
Lock operated with key type 405		NSYTEL405ML
Lock operated with reinforced key		NSYTERML

Keys

- Insert without keys (unless indicated)



NSYLDB5



NSYLC8



NSYLT8

Characteristics	References
Metal key for 5-mm double-bar insert	NSYLDB5
Metal key for 7 mm square insert	NSYLC7
Metal key for 8 mm square insert	NSYLC8
Metal key for 8 mm triangle insert	NSYLT8

Padlocking accessories

- Padlocking system, positioned around the long rectangular escutcheon of the enclosures, to block access to the lock, for a Ø 9 mm padlock.



NSYBCPL

Characteristics	References
Padlock device for large rectangular escutcheon of PLM 108 and PL	NSYBCPL

- Padlocking system, to block access to the retractable handle, for a Ø 9 mm padlock.



NSYBCME

Characteristics	References
Spacial SFX - SMX enclosures - padlocking device for retractable handle	NSYBCME

Standard cable gland plates

- The cable gland plate for Spacial CRN guarantees water and dust tightness.
- Material: Steel
- Color: RAL 7035 grey
- Installation: Fixing with screws, it is flattened with the body
- Type E: Enclosure with 2 entries

Supply:

Included as a standard with the Spacial CRN enclosure. It is delivered with a separate seal: It allows easy cut-outs with no risk of damaging the seal and can be easily repainted.



NSYTLCRNO

Characteristics	Width (mm)	Depth (mm)	To be coupled with entry	References
Standard cable gland plate	200	150	0	NSYTLCRNO
Standard cable gland plate	250	150/200	A	NSYTLCRNA
Standard cable gland plate	300	150/200	B	NSYTLCRNB
Standard cable gland plate	400/500	150	B	NSYTLCRNB
Standard cable gland plate	400	200/250	C	NSYTLCRNC
Standard cable gland plate	500/600	200/250/300	D	NSYTLCRND
Standard cable gland plate	800	200/250/300	E	NSYTLCRNC

Insulated cable gland plates

- With a polyurethane sealing gasket.
- Excellent thermal resistance.
- Pre-marked holes for cable entry plates.
- Material: Self-extinguishing ABS with 30% fiberglass
- Color: RAL 7035 grey
- Installation: Pre-marked holes with diameter Pg for coupling of cable glands, membrane glands, tubes, etc
- For type E cable entry, use two **NSYTSACRNC**.

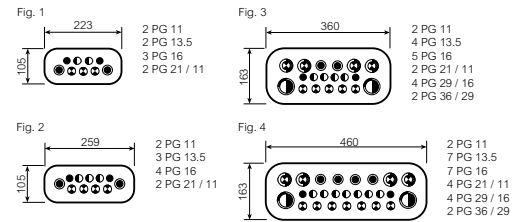

For more details see [page 71](#)



NSYTSACRNA

Characteristics	Fig.	Width (mm)	Depth (mm)	To be coupled with entry	References
Insulated cable gland plate	1	250	150/200	A	NSYTSACRNA
Insulated cable gland plate	2	300	150/200	B	NSYTSACRNB
Insulated cable gland plate	3	400/500	150	B	NSYTSACRNB
Insulated cable gland plate	3	400	200/250	C	NSYTSACRNC
Insulated cable gland plate	4	500/600	200/250/300	D	NSYTSACRND
Insulated cable gland plate	3	800	200/250/300	E ⁽²⁾	NSYTSACRNC

Standard cable gland plates

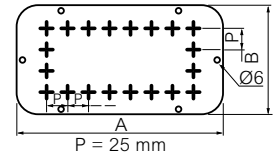

- Cable entries
- Material: Steel
- Color: RAL 7035 grey
- Ingress protection rating: IP66 according to IEC 60529
- Installation: Surface with a grid pattern in 25 mm intervals to facilitate perforation, fixing with screws

Supply:
Standard supply with the Spacial CRNG enclosures



Characteristics	Width (mm)	Depth (mm)	To be coupled with entry	Dimensions A x B (mm)	References
Standard cable gland plate	600	400	G	495 x 220	NSYTLG
Standard cable gland plate	800	300-400	H (2 entries)	345 x 130	NSYTLG
Standard cable gland plate	1000-1200	300-400	H (2 entries)	445 x 130	NSYTLG

Cable gland plates for membrane glands

- Cable entries
- FL21 cut-outs
- Material: Steel
- Color: RAL 7035 grey
- Ingress protection rating: The membranes are built to accommodate water and dust tight cable entries in insulated material (flame classification V0), guaranteeing IP65 (to be ordered separately), IP 65 according to IEC 60529
- Installation: Fixing with screws

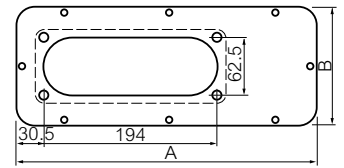

Characteristics	Width (mm)	Depth (mm)	To be coupled with entry	Dimensions A x B (mm)	References
For membrane glands	600	400	G	495 x 220	NSYTLG2FL
For membrane glands	800	300-400	H (2 entries)	345 x 130	NSYTLG2FL
For membrane glands	1000-1200	300-400	H (2 entries)	445 x 130	NSYTLG2FL

FlexiCable

- FlexiCable is an innovative cable gland plate for simple and fast cable entrance. There is no need to drill holes: The creation of the cable entrances takes a few seconds. Cable diameter: Up to 26 mm.
- Ingress protection rating: IP55 according to IEC 60529
- Installation: Installation options: Replaces cable gland plate (S3D or CRN-G) or directly on enclosure
- Other characteristics: Exists in 5 sizes matching 46 sizes (132 models) of Spacial S3D steel wall-mounted enclosures
Fire resistant 650 °C following IEC 60695-2-11
Tested on short-circuit effect 250 A, 25 kA following IEC 61439-1

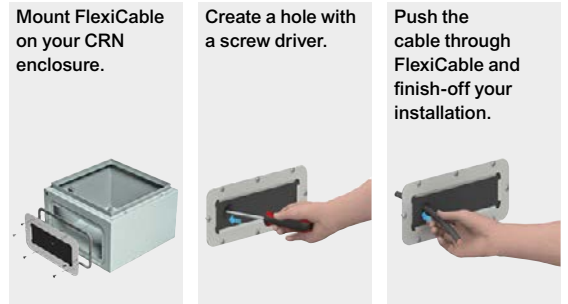

Supply:
1 metal frame with pre-mounted membrane, 1 gasket, Fixing hardware



Characteristics	Width (mm)	Depth (mm)	Dimensions A x B (mm)	Effective cable entrance dimensions (mm)	References
FlexiCable	600	400	495 x 220	428 x 153	NSYTLGME
FlexiCable	800	300-400	345 x 130	-	NSYTLGME
FlexiCable	1000-1200	300-400	445 x 130	-	NSYTLGME

Internal door

- Locking with 3-mm double-bar lock.
- The internal door can be installed directly on the front face of the enclosure or on the step slides (not supplied as standard).
- To mount an inner door and a mounting plate at the same time on the step slides is possible as standard.
- Incompatible with the installation of the door stop and door switch.
- For further details, please consult us.
- Material: Steel
- Color: RAL 7035 grey
- Maximum load: 30 kg/m²

Note:

⁽¹⁾ Equipped with welded vertical profiles in order to facilitate cable management.



NSYPIN43

Characteristics	High (mm)	Width (mm)	References
Internal door	400	300	NSYPIN43
Internal door	500	400	NSYPIN54
Internal door	600	400	NSYPIN64
Internal door	700	500	NSYPIN75
Internal door	800	600	NSYPIN86 ⁽¹⁾
Internal door	1000	600	NSYPIN106 ⁽¹⁾
Internal door	1000	800	NSYPIN108 ⁽¹⁾
Internal door	1200	600	NSYPIN126
Internal door	1200	800	NSYPIN128 ⁽¹⁾

Door hinges

- Captive pin, indexed by a spring.
- Material: Zamak body for ref **NSYAEDH180S3D**, treated sheet-steel body for ref. **NSYAEDH120S3D**, aluminum pin
- Maximum load: For the 180° hinge, the maximum admissible load on the door is 20 kg/m²
- For the 120° hinge, the maximum admissible load on the door is 50 kg/m²

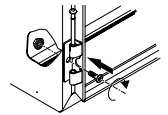

Supply:

Set of 1 hinge, delivered with fixings



NSYAEDH180S3D NSYAEDH120S3D

Characteristics	References
180° hinge for CRNG enclosure	NSYAEDH180S3D
Standard 120° hinge for CRNG	NSYAEDH120S3D

Mounting rail

- Accessory designed to optimize the available space in the enclosure.
- It is intended for the installation of switchgear complementing the chassis.
- Mounting possible after installing the mounting plate.
- It is mounted horizontally, with a single screw, on the side panels.
- Door switch mounting option.
- It is possible to vertically fasten **NSYSLCR●●** light cross-rails (description on [page 276](#)) and **NSYSQCR●●** quick-fixing cross-rails (description on [page 274](#)).
- Material: Galvanized steel
- Maximum load: Static load: 6 kg (sides) and 1,5 kg (top); Dynamic load (transport horizontally): 2 kg according to ASTM D-4169-16
- Installation: In order to ensure the electrical continuity in all cases we recommend using an earthing cable **NSYEL●●●D6** or **NSYEL●●●D8**, see [page 323](#)



Supply:

Set of 2 cross-rails



NSYSUCR200WM

Characteristics	Enclosure depth (mm)	References
Mounting rail for wall-mounted enclosure S3D/CRN	200	NSYSUCR200WM
Mounting rail for wall-mounted enclosure S3D/CRN	250	NSYSUCR250WM
Mounting rail for wall-mounted enclosure S3D/CRN	300	NSYSUCR300WM
Mounting rail for wall-mounted enclosure S3D/CRN	400	NSYSUCR400WM

Dimensions

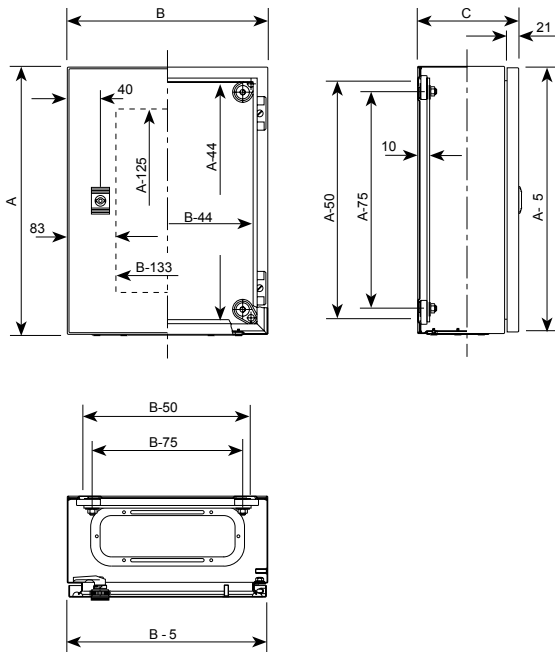

Fig. 1

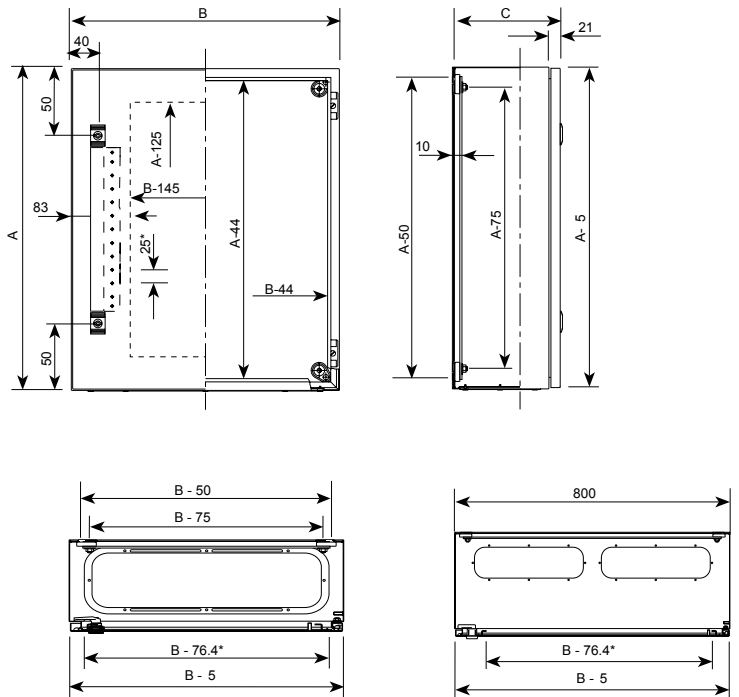
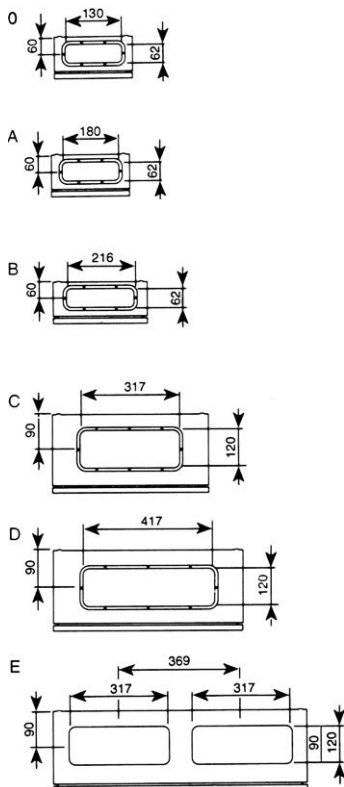

Fig. 2

A: Enclosure height
B: Enclosure width
C: Enclosure depth

Spacial CRN cable entry dimensions and type



None of the T glazed-door enclosures have door reinforcement profiles.

Our DXF diagrams and technical instruction sheets can be downloaded from our websites.

Technical changes reserved. Information provided without guarantee. Images are for illustrative purposes only.

Dimensions

A: Enclosure height, B: Enclosure width, C: Enclosure depth

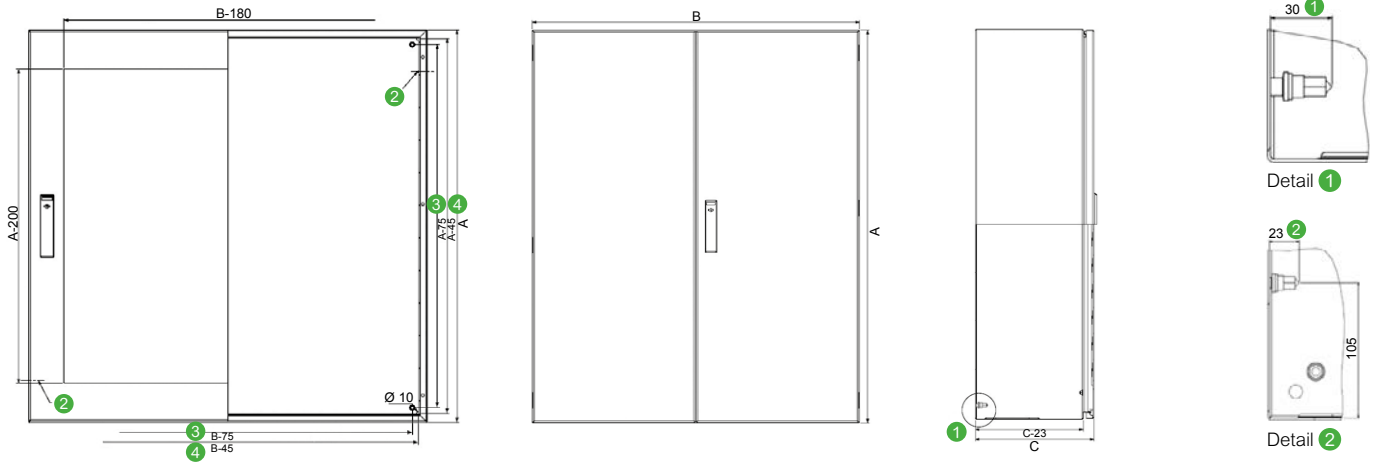

Dimensions of enclosure (mm)					
Width (B)	Depth (C)	J	K	L	M
600	300-400	126	470	195	-
800	300-400	95	320	105	400
1000 (5)	300	125	420	105	500
1000	300-400	95	420	105	500
1200	300	95	420	105	500
	400	125	420	105	600

- 1 Four M8 x 25 back studs
- 2 Two M6 x 17.5 earth studs
- 3 Spacing between the studs
- 4 Spacing between the perforations for direct fixing
- 5 Only models 1400 x 1000 x 300

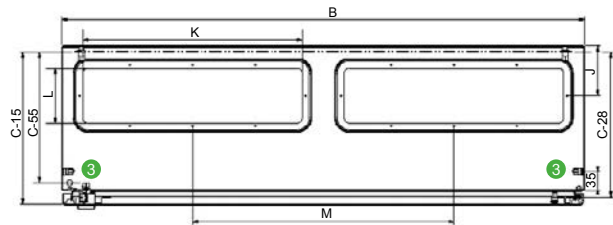

Cable entry type H: Enclosure width \geq 800 mm.

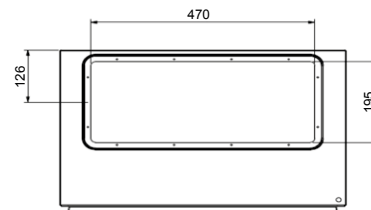

Cable entry type G: Enclosure width 600 mm.

Dimensions of the door-reinforcement profiles, the T doors only include vertical profiles

1-door enclosure		Reinforcement profile	
Height (A)	Width (B)	F	D
800	600	620	487
1000	600	820	487
	800	820	687
1200	600	1020	480
	800	1020	687

2-door enclosure		Reinforcement profile			
Height (A)	Width (B)	Rt. Door		Lft. Door	
		F	D	F	D
800	1000	620	387	620	437
	1200	620	487	620	537
1000	1000	820	387	820	437
	1200	820	487	820	537
1200	1000	1020	387	1020	437
	1200	1020	487	1020	537
1400	1000	1020	387	1020	437

- 6 25-mm passage
- 7 1 M6 x 17.5 earth stud

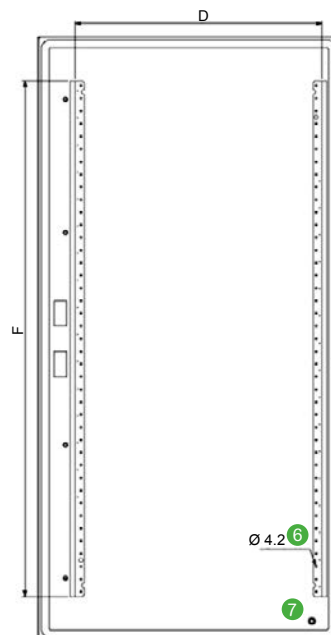

Download our DXF diagrams from our website.

Steel Wall-Mounted Enclosures

Spacial CRN - CRNG, Dimensions

2
CRN

Post-fixing device for Spacial steel enclosure

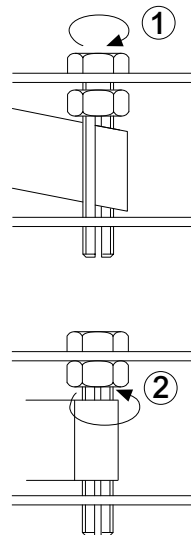
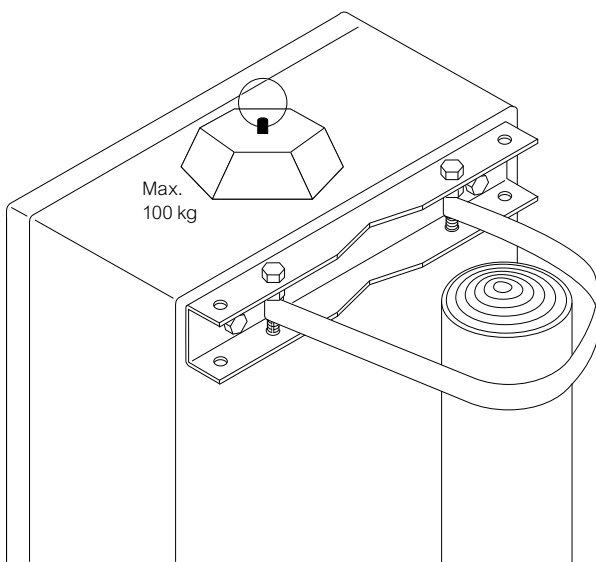
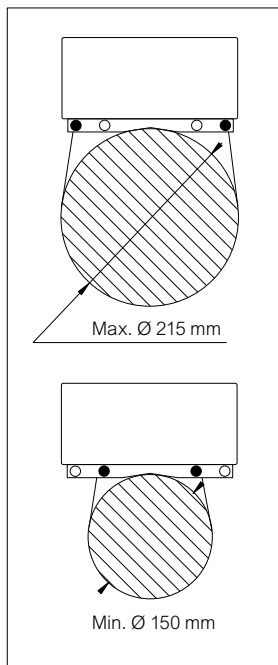
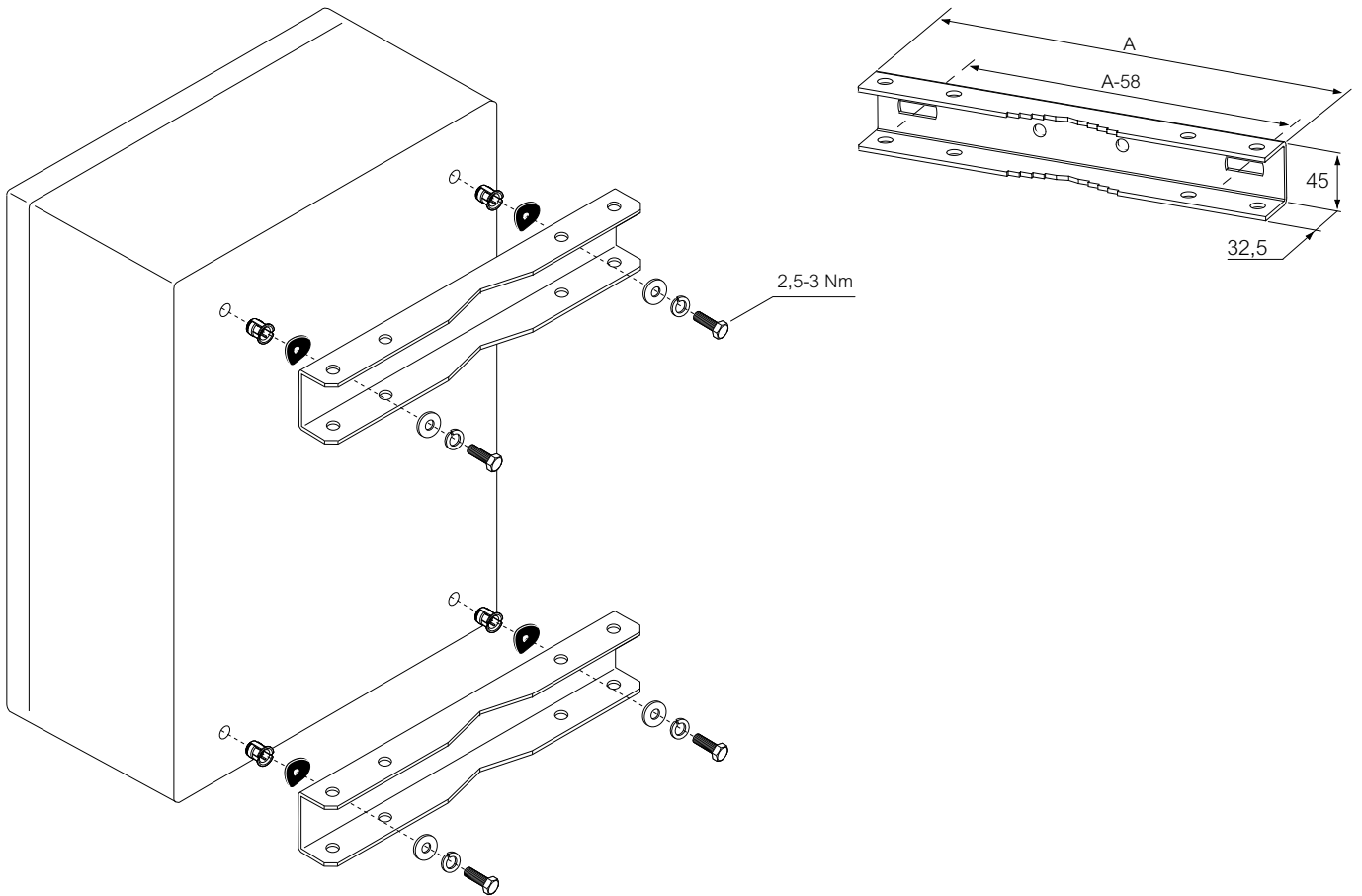

Technical changes reserved. Information provided without guarantee. Images are for illustrative purposes only.

Insulated cable gland plates

Fig. 1

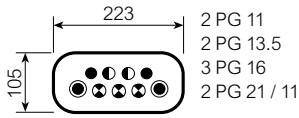

Fig. 2

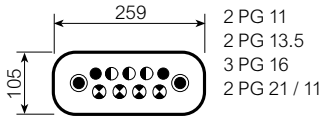

Fig. 3

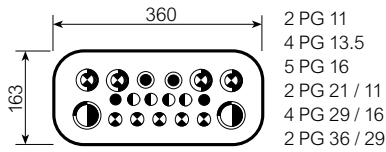
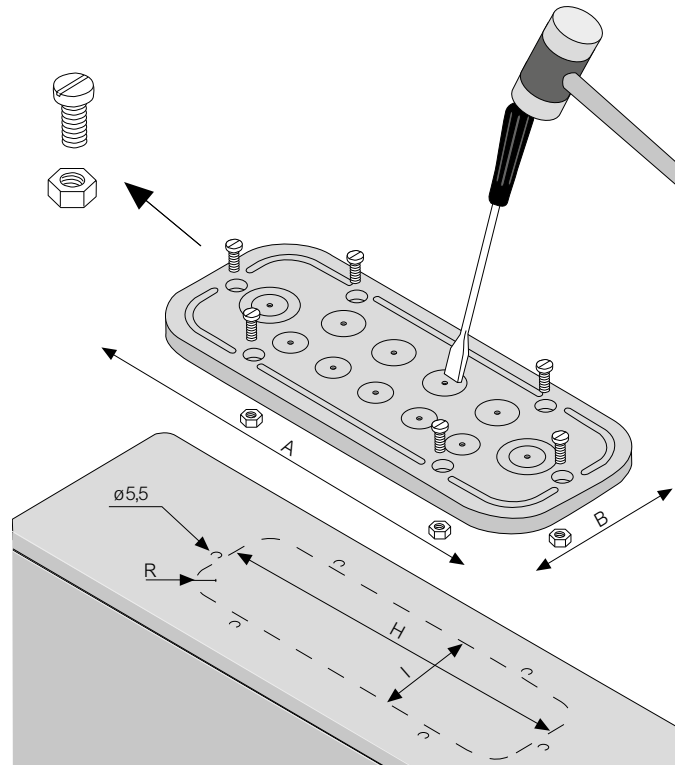
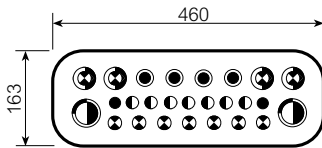
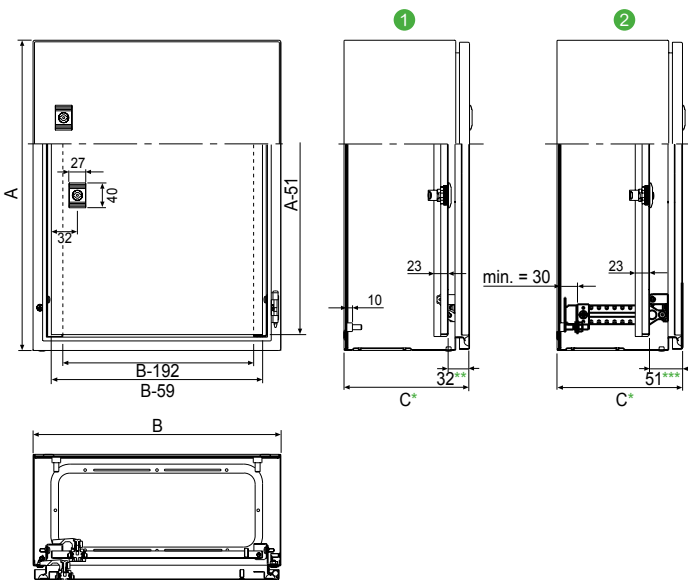

Fig. 4



- PG 11 (18,6 mm)
- PG 16 (20,4 mm)
- PG 16 / 22,5 mm
- PG 21 / 11 (28,3 / 18,6 mm)
- PG 29 / 16 (37 / 22,5 mm)
- PG 36 / 29 (47 / 37 mm)

Internal door



- 1 NSYPIN●●● internal door fixed directly to the enclosure.
- 2 NSYPIN●●● internal door fixed to the adjustable NSYSDCR support. In this case, both the internal door and the mounting plate may be depth adjustable.

* Dimension C according to general table on [page 48](#).

** Except H 1200 x W 600: 38.3.

*** Except H 1200 x W 600: 59 and H 1200 x W 800: 50

The steel enclosure with the greatest range of available dimensions on the market!

This range can be configured according to your needs

4 different services available:



Assemble to order



Mounting of standard accessories



Painting



Machining



Service life

- Quality of the welding and the painting.



Personnel safety

- Earthing studs welded to the body and door.



Component protection

- Water and dust tightness and impact resistance.
- EMC and ATEX offer.



Added value to your work

- Quality and aesthetics.



Increased choice

- Large range of universal dimensions.
- Application offer with special dimensions.



Easy equipping

- 4 10 mm shouldered welded studs.
- Broad range of mounting plates.
- Broad range of cable gland plates.
- Cable guides welded to the door from the height of 400 mm.

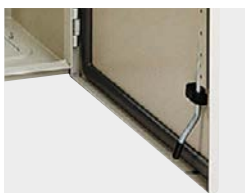

Easy maintenance

- Removable hinges.
- 1-lock system for heights below 600 mm.
- 3-point lock for heights from 600 mm.

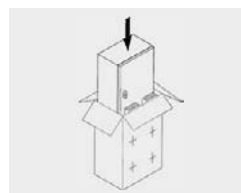

Easy handling

- Reusable, eco-friendly packaging.
- No sharp edges.

See [page 546](#) for details or consult our web site www.se.com



S3D

Characteristics	Spacial S3D
	<p>Three steel enclosure configurations are available:</p> <ul style="list-style-type: none"> • Enclosure with plain door. • Enclosure with plain door delivered with a galvanized plain mounting plate, not installed. • Enclosure with glazed door, 4 mm-thick Securit® glass.
Personnel protection	<ul style="list-style-type: none"> • Earth connection: Spacial S3D steel enclosures are equipped with M6 x 16 earth studs welded in the body and the door for equipotential connection. Earth braid to be ordered separately (see page 323). • Closing the enclosure: The enclosures are equipped from the height of 600 mm with three locking points with linkage, with a single control point, helping prevent the enclosures from being left ajar. Locks and inserts, page 85.
Material	Steel
Finish	Structured finish, epoxy polyester powder
Color	RAL 7035 grey
Ingress protection rating	<ul style="list-style-type: none"> • IP66 for the single-door enclosures and IP55 for the double-door enclosures, according to IEC 60529. • cUL : Types 4, 4x and 13 for single-door enclosure and 12 and 13
Mechanical protection rating	IK10 for the plain-door enclosures and IK08 for the glazed-door enclosures according to IEC 62262 Types 4, 4X and 13 for single-door and Types 12 and 13 according UL508A and CAN C22.2 No 14
Standards	Compliance with enclosure standards IEC 62208 The Spacial S3D wall-mounted enclosures are compliant with the RoHS directive
Certifications (see page 712)	<ul style="list-style-type: none"> • UL (cULus), BVM, DNV, LR. For Atex see page 496 • Types 4, 4X and 13 for the single-door enclosures and Types 12, 13 for the double-door enclosures. according to UL508A. Information on NEMA and UL classification on page 717 and 718 <p>Nuclear decontamination: RAL 7035 grey and AFNOR A550 tests available on demand. More information on painting properties on page 719 and 720</p> <ul style="list-style-type: none"> • Seismic behavior: 2.5G or 3G (details page 104)
Fixing	4 (or 6 studs for widths 1000 and 1200 (see page 102 and 103)) M8 x 25 collared studs for installing mounting plates and step slides, leaving a space of 10 mm behind them.
Supply	<p>Body</p> <ul style="list-style-type: none"> • Single-piece body (cross-shaped structure). Gutter-shaped front profile with double fold. <p>Flat rear</p> <ul style="list-style-type: none"> • M6 x 16 earthing screws for equipotential connection between the door and the body of the enclosure • Cable gland plate with marking for easy drilling and to enable the maximum access surface; Delivered with the enclosure. This plate is flush with the body of the enclosure (detail and other options on page 89) • Direct wall-mounted (4 Ø 10 holes for the sealing plugs for the the IP) or with the help of fixing lugs installed from the outside (to be ordered separately, see page 79) <p>Door</p> <ul style="list-style-type: none"> • Wall-mounted enclosure supplied with 3-mm double-bar lock as standard • Polyurethane door gasket • M6 x 16 earthing screws for equipotential connection between the door and the body of the enclosure • Easily removable and reversible, with 20 mm return with double thickness granting excellent rigidity, opening to 120°, equipped with 2 or 3 invisible hinges (from the height of 800 mm) • Door opening to 180° with optional hinges (page 88) • For heights from 600 mm, three locking points with linkage, with a single control point. Simple reversal of linkage. Maximum load: 50 kg/m² • A handle is delivered which provides 2 functions: <ul style="list-style-type: none"> - Operating key - Tool for loosening the stud protection caps. This handle can be solidly attached to the locking system by means of a captive element • Perforated rails on the door, with drill holes with a diameter of 4.2 mm in steps of 25 mm: <ul style="list-style-type: none"> - 2 vertical rails from the height of 400 mm - 2 vertical rails and 2 horizontal rails from the width of 800 mm

• Ingress protection rating: IP66 for the single-door enclosures and IP55 for the double-door enclosures, according to IEC 60529.

• Rating according UL50E: Types 4, 4X and 13 for single-door enclosures and Types 12 and 13 for double-door enclosures.

Dimensions ⁽¹⁾			Door						Mounting plates		
Height (mm)	Width (mm)	Depth (mm)	Doors	IP	Weight (kg) ⁽²⁾	Plain without mounting plate	Plain with mounting plate	Glazed without mounting plate	Plain	Silkscreened ⁽³⁾	Microperforated
300	200	150	1	66	3.02	NSYS3D3215	NSYS3D3215P	-	NSYMM32	-	NSYMF32
300	250	150	1	66	3.48	NSYS3D32515	NSYS3D32515P	NSYS3D32515T	NSYMM3025	-	-
300	300	150	1	66	3.90	NSYS3D3315	NSYS3D3315P	NSYS3D3315T	NSYMM33	-	NSYMF33
300	300	200	1	66	4.50	NSYS3D3320	NSYS3D3320P	NSYS3D3320T	NSYMM33	-	NSYMF33
300	400	150	1	66	4.82	NSYS3D3415	NSYS3D3415P	NSYS3D3415T	NSYMM43	NSYMS43	NSYMF43
300	400	200	1	66	5.60	NSYS3D3420	NSYS3D3420P	NSYS3D3420T	NSYMM43	NSYMS43	NSYMF43
400	300	150	1	66	4.90	NSYS3D4315	NSYS3D4315P	NSYS3D4315T	NSYMM43	NSYMS43	NSYMF43
400	300	200	1	66	5.00	NSYS3D4320	NSYS3D4320P	NSYS3D4320T	NSYMM43	NSYMS43	NSYMF43
400	400	200	1	66	6.50	NSYS3D4420	NSYS3D4420P	NSYS3D4420T	NSYMM44	NSYMS44	NSYMF44
400	600	200	1	66	10.50	NSYS3D4620	NSYS3D4620P	NSYS3D4620T	NSYMM64	NSYMS64	NSYMF64
400	600	250	1	66	12.00	NSYS3D4625	NSYS3D4625P	NSYS3D4625T	NSYMM64	NSYMS64	NSYMF64
500	300	200	1	66	7.50	NSYS3D5320	NSYS3D5320P	NSYS3D5320T	NSYMM53	NSYMS53	NSYMF53
500	400	200	1	66	9.30	NSYS3D5420	NSYS3D5420P	NSYS3D5420T	NSYMM54	NSYMS54	NSYMF54
500	400	250	1	66	10.20	NSYS3D5425	NSYS3D5425P	NSYS3D5425T	NSYMM54	NSYMS54	NSYMF54
500	500	200	1	66	11.18	NSYS3D5520	NSYS3D5520P	NSYS3D5520T	NSYMM55	NSYMS55	NSYMF55
500	500	250	1	66	12.06	NSYS3D5525	NSYS3D5525P	NSYS3D5525T	NSYMM55	NSYMS55	NSYMF55
600	400	200	1	66	11.00	NSYS3D6420	NSYS3D6420P	NSYS3D6420T	NSYMM64	NSYMS64	NSYMF64
600	400	250	1	66	12.00	NSYS3D6425	NSYS3D6425P	NSYS3D6425T	NSYMM64	NSYMS64	NSYMF64
600	500	250	1	66	16.20	NSYS3D6525	NSYS3D6525P	NSYS3D6525T	NSYMM65	-	NSYMF65
600	600	200	1	66	14.00	NSYS3D6620	NSYS3D6620P	NSYS3D6620T	NSYMM66	NSYMS66	NSYMF66
600	600	250	1	66	15.00	NSYS3D6625	NSYS3D6625P	NSYS3D6625T	NSYMM66	NSYMS66	NSYMF66
600	600	300	1	66	17.00	NSYS3D6630	NSYS3D6630P	NSYS3D6630T	NSYMM66	NSYMS66	NSYMF66
600	600	400	1	66	19.00	NSYS3D6640	NSYS3D6640P	NSYS3D6640T	NSYMM66	NSYMS66	NSYMF66
600	800	300	1	66	25.50	NSYS3D6830	NSYS3D6830P	NSYS3D6830T	NSYMM86	NSYMS86	NSYMF86
700	500	250	1	66	15.00	NSYS3D7525	NSYS3D7525P	NSYS3D7525T	NSYMM75	NSYMS75	NSYMF75
800	600	200	1	66	21.00	NSYS3D8620	NSYS3D8620P	NSYS3D8620T	NSYMM86	NSYMS86	NSYMF86
800	600	250	1	66	23.00	NSYS3D8625	NSYS3D8625P	NSYS3D8625T	NSYMM86	NSYMS86	NSYMF86
800	600	300	1	66	25.00	NSYS3D8630	NSYS3D8630P	NSYS3D8630T	NSYMM86	NSYMS86	NSYMF86
800	600	400	1	66	29.00	NSYS3D8640	NSYS3D8640P	NSYS3D8640T	NSYMM86	NSYMS86	NSYMF86
800	800	250	1	66	30.00	NSYS3D8825	NSYS3D8825P	NSYS3D8825T	NSYMM88	-	NSYMF88
800	800	300	1	66	32.00	NSYS3D8830	NSYS3D8830P	NSYS3D8830T	NSYMM88	-	NSYMF88
800	1000	300	1	66	38.00	NSYS3D81030	NSYS3D81030P	-	NSYMM108	-	NSYMF108
800	1000	300	2	55	43.50	NSYS3D81030D	NSYS3D81030DP	-	NSYMM108	-	NSYMF108
800	1200	300	2	55	46.00	NSYS3D81230D	NSYS3D81230DP	-	NSYMM128	-	NSYMF128
1000	600	250	1	66	28.00	NSYS3D10625	NSYS3D10625P	NSYS3D10625T	NSYMM106	-	NSYMF106
1000	600	300	1	66	30.60	NSYS3D10630	NSYS3D10630P	NSYS3D10630T	NSYMM106	-	NSYMF106
1000	600	400	1	66	33.00	NSYS3D10640	NSYS3D10640P	NSYS3D10640T	NSYMM106	-	NSYMF106
1000	800	250	1	66	35.00	NSYS3D10825	NSYS3D10825P	NSYS3D10825T	NSYMM108	-	NSYMF108
1000	800	300	1	66	38.00	NSYS3D10830	NSYS3D10830P	NSYS3D10830T	NSYMM108	-	NSYMF108
1000	800	400	1	66	42.00	NSYS3D10840	NSYS3D10840P	NSYS3D10840T	NSYMM108	-	NSYMF108
1000	1000	300	1	66	46.00	NSYS3D101030	NSYS3D101030P	NSYS3D101030T	NSYMM1010	-	NSYMF1010
1000	1000	300	2	55	46.00	NSYS3D101030D	NSYS3D101030DP	NSYS3D101030DT	NSYMM1010	-	NSYMF1010
1000	1200	300	2	55	53.00	NSYS3D101230D	NSYS3D101230DP	-	NSYMM1210	-	NSYMF1210
1000	1200	400	2	55	60.00	NSYS3D101240D	NSYS3D101240DP	-	NSYMM1210	-	NSYMF1210
1200	600	300	1	66	37.00	NSYS3D12630	NSYS3D12630P	NSYS3D12630T	NSYMM126	-	NSYMF126
1200	600	400	1	66	42.00	NSYS3D12640	NSYS3D12640P	NSYS3D12640T	NSYMM126	-	NSYMF126
1200	800	300	1	66	45.00	NSYS3D12830	NSYS3D12830P	NSYS3D12830T	NSYMM128	-	NSYMF128
1200	800	400	1	66	49.00	NSYS3D12840	NSYS3D12840P	NSYS3D12840T	NSYMM128	-	NSYMF128
1200	1000	300	1	66	53.00	NSYS3D121030	NSYS3D121030P	NSYS3D121030T	NSYMM1210	-	NSYMF1210
1200	1000	300	2	55	54.00	NSYS3D121030D	NSYS3D121030DP	NSYS3D121030DT	NSYMM1210	-	NSYMF1210
1200	1000	400	2	55	61.00	NSYS3D121040D	NSYS3D121040DP	-	NSYMM1210	-	NSYMF1210
1200	1200	300	2	55	64.00	NSYS3D121230D	NSYS3D121230DP	-	NSYMM1212	-	2x NSYMF126 ⁽⁴⁾
1200	1200	400	2	55	90.00	NSYS3D121240D	NSYS3D121240DP	-	NSYMM1212	-	2x NSYMF126 ⁽⁴⁾
1400	1000	300	2	55	80.00	NSYS3D141030D	NSYS3D141030DP	-	NSYMM1410	-	-

⁽¹⁾ For other dimensions, see our application offer, page 16.

⁽²⁾ Enclosure without mounting plate.

⁽³⁾ In inverted use, the marking is inverted.

⁽⁴⁾ Order NSYCRNGSDR for double mounting of the mounting plates









⁽⁵⁾ Order nuts ref. NSYAMCSF. Steel siderail ref. NSYMDVR12.

⁽⁶⁾ When width ≥ 1000 ref. NSYEMR is mandatory (see on page 102).

⁽⁷⁾ Possible assembling to ref. NSYDLM84 or NSYDLM112.

Technical changes reserved. Information provided without guarantee. Images are for illustrative purposes only.

- For other dimensions, see our application offer.
- Enclosure without mounting plate.
- In inverted use of silkscreened mounting plates, the marking is inverted.

		Modular mounting plate						Cross-rails			Dimensions ⁽¹⁾		
										Height (mm)	Width (mm)	Depth (mm)	
	Telequick	Bakelite	Modules	Modular chassis DLM Steel	Modular chassis DLA Insulated	DIN rail chassis	Typ	Aluminum vertical rails ⁽⁶⁾	Door cross-rails				
	NSYMR32	NSYMB32	-	-	-	-	-	NSYMDVR3	-	300	200	150	
	NSYMR3025	NSYMB3025	-	-	-	-	-	NSYMDVR3	-	300	250	150	
	NSYMR33	NSYMB33	-	-	-	NSYMD33	B	NSYMDVR3	-	300	300	150	
	NSYMR33	NSYMB33	-	-	-	NSYMD33	B	NSYMDVR3	-	300	300	200	
	NSYMR34	NSYMB43	-	-	-	-	-	NSYMDVR3	-	300	400	150	
	NSYMR34	NSYMB43	-	-	-	-	-	NSYMDVR3	-	300	400	200	
	NSYMR43	NSYMB43	24	NSYDLM24	-	NSYMD43	B	NSYMDVR4	-	400	300	150	
	NSYMR43	NSYMB43	24	NSYDLM24	NSYDLA24G	NSYMD43	B	NSYMDVR4	-	400	300	200	
	NSYMR44	-	-	-	-	-	-	NSYMDVR4	NSYTFPCR4	400	400	200	
	NSYMR46	NSYMB64	-	-	-	-	-	NSYMDVR4	NSYTFPCR6	400	600	200	
	NSYMR46	NSYMB64	-	-	-	-	-	NSYMDVR4	NSYTFPCR6	400	600	250	
	NSYMR53	-	-	-	-	-	-	NSYMDVR5	-	500	300	200	
	NSYMR54	NSYMB54	48	NSYDLM48	NSYDLA48G	NSYMD54	B	NSYMDVR5	NSYTFPCR4	500	400	200	
	NSYMR54	NSYMB54	48	NSYDLM48	-	NSYMD54	B	NSYMDVR5	NSYTFPCR4	500	400	250	
	NSYMR55	-	-	-	-	-	-	NSYMDVR5	NSYTFPCR5	500	500	200	
	NSYMR55	-	-	-	-	-	-	NSYMDVR5	NSYTFPCR5	500	500	250	
	NSYMR64	NSYMB64	48	NSYDLM48P	NSYDLA48PG	NSYMD64	B	NSYMDVR6	NSYTFPCR4	600	400	200	
	NSYMR64	NSYMB64	48	NSYDLM48P	NSYDLA48PG	NSYMD64	B	NSYMDVR6	NSYTFPCR4	600	400	250	
	NSYMR65	NSYMB65	-	-	-	-	-	NSYMDVR6	-	600	500	250	
	NSYMR66	-	84	NSYDLM84P	-	NSYMD66	A	NSYMDVR6	NSYTFPCR6	600	600	200	
	NSYMR66	-	84	NSYDLM84P	-	NSYMD66	A	NSYMDVR6	NSYTFPCR6	600	600	250	
	NSYMR66	-	84	NSYDLM84P	-	NSYMD66	A	NSYMDVR6	NSYTFPCR6	600	600	300	
	NSYMR66	-	84	NSYDLM84P	-	NSYMD66	A	NSYMDVR6	NSYTFPCR6	600	600	400	
	NSYMR68	NSYMB86	-	-	-	NSYMD86	A	NSYMDVR6	NSYTFPCR8	600	800	300	
	NSYMR75	NSYMB75	66	NSYDLM66	NSYDLA66G	NSYMD75	B	NSYMDVR7	NSYTFPCR5	700	500	250	
	NSYMR86	NSYMB86	84 ⁽⁷⁾	NSYDLM84	NSYDLA84G / NSYDLA112G	NSYMD86	A	NSYMDVR8	NSYTFPCR6	800	600	200	
	NSYMR86	NSYMB86	112 ⁽⁷⁾	NSYDLM112	NSYDLA84G / NSYDLA112G	NSYMD86	A	NSYMDVR8	NSYTFPCR6	800	600	250	
	NSYMR86	NSYMB86	112 ⁽⁷⁾	NSYDLM112	NSYDLA84G / NSYDLA112G	NSYMD86	A	NSYMDVR8	NSYTFPCR6	800	600	300	
	NSYMR86	NSYMB86	112 ⁽⁷⁾	NSYDLM112	NSYDLA84G / NSYDLA112G	NSYMD86	A	NSYMDVR8	NSYTFPCR6	800	600	400	
	NSYMR88	-	-	-	-	-	-	NSYMDVR8	NSYTFPCR8	800	800	250	
	NSYMR88	-	-	-	-	-	-	NSYMDVR8	NSYTFPCR8	800	800	300	
	NSYMR810	NSYMB108	-	-	-	-	-	NSYMDVR8	NSYTFPCR10	800	1000	300	
	NSYMR810	NSYMB108	-	-	-	-	-	NSYMDVR8	-	800	1000	300	
	2x NSYMR86 ⁽⁴⁾	2x NSYMB86 ⁽⁴⁾	-	-	-	2x NSYMD86 ⁽⁴⁾	A	NSYMDVR8	-	800	1200	300	
	NSYMR106	NSYMB106	168	NSYDLM168	-	-	-	NSYMDVR10	NSYTFPCR6	1000	600	250	
	NSYMR106	NSYMB106	168	NSYDLM168	-	-	-	NSYMDVR10	NSYTFPCR6	1000	600	300	
	NSYMR106	NSYMB106	168	NSYDLM168	-	-	-	NSYMDVR10	NSYTFPCR6	1000	600	400	
	NSYMR108	NSYMB108	234	NSYDLM240	NSYDLA234G	NSYMD108	A	NSYMDVR10	NSYTFPCR8	1000	800	250	
	NSYMR108	NSYMB108	234	NSYDLM240	NSYDLA234G	NSYMD108	A	NSYMDVR10	NSYTFPCR8	1000	800	300	
	NSYMR108	NSYMB108	234	NSYDLM240	NSYDLA234G	NSYMD108	A	NSYMDVR10	NSYTFPCR8	1000	800	400	
	NSYMR1012 ⁽⁶⁾	-	-	-	-	-	-	NSYMDVR10	NSYTFPCR10	1000	1000	300	
	NSYMR1012 ⁽⁶⁾	-	-	-	-	-	-	NSYMDVR10	-	1000	1000	300	
	NSYMR1012 ⁽⁶⁾	NSYMB1210	-	-	-	-	-	NSYMDVR10	-	1000	1200	300	
	NSYMR1012 ⁽⁶⁾	NSYMB1210	-	-	-	-	-	NSYMDVR10	-	1000	1200	400	
	-	-	-	-	-	-	-	NSYMDVR12	-	1200	600	300	
	-	-	-	-	-	-	-	NSYMDVR12	-	1200	600	400	
	NSYMR128	-	-	-	-	NSYMD128	A	NSYMDVR12	NSYTFPCR8	1200	800	300	
	NSYMR128	-	-	-	-	NSYMD128	A	NSYMDVR12	NSYTFPCR8	1200	800	400	
	NSYMR1210 ⁽⁶⁾	NSYMB1210	-	-	-	-	-	NSYMDVR12	NSYTFPCR10	1200	1000	300	
	NSYMR1210 ⁽⁶⁾	NSYMB1210	-	-	-	-	-	NSYMDVR12	-	1200	1000	300	
	NSYMR1210 ⁽⁶⁾	NSYMB1210	-	-	-	-	-	NSYMDVR12	-	1200	1000	400	
	2x NSYMR126 ⁽⁴⁾	-	-	-	-	-	-	NSYMDVR12	-	1200	1200	300	
	2x NSYMR126 ⁽⁴⁾	-	-	-	-	-	-	NSYMDVR12	-	1200	1200	400	
	NSYMR1410 ⁽⁶⁾	-	-	-	-	-	-	-	-	1400	1000	300	

Wall fixing lugs: [page 79](#)
Steel: NSYAEFPFSC
Stainless-steel: NSYAEFPFXSC

Reinforcement for heavy loads: [page 79](#)
NSYAEFAHLBSC
Locking accessories: [page 86](#)

Door accessories: [page 318](#)
Clip-on nuts: [page 290](#)
Self-tapping screw: NSYS13M5HS / [page 291](#)

Technical changes reserved. Information provided without guarantee. Images are for illustrative purposes only.

- Ingress protection rating: IP66 for the single-door enclosures and IP55 for the double-door enclosures, according to IEC 60529
- For other dimensions, see our application offer.

- Enclosure without mounting plate..
- In inverted use of silkscreened mounting plates, the marking is inverted.

Dimensions ⁽¹⁾			Electronics and networks, 19" racks				Cable entry accessories, Cable gland plates				
Height (mm)	Width (mm)	Depth (mm)	Fixed	No. of U	Swing	No. of U	Entry type	Standard steel	Aluminum	Steel with cut-out for FL membrane ⁽²⁾	FlexiCable ⁽⁶⁾
300	200	150	-	-	-	-	A	NSYTLA	NSYT LAU	-	-
300	250	150	-	-	-	-	A	NSYT LA	NSYT LAU	-	-
300	300	150	-	-	-	-	B	NSYTLB	NSYTL BU	NSYTL BFL	-
300	300	200	-	-	-	-	C	NSYTLC	NSYTLCU	NSYTLCFL	NSYTLCME
300	400	150	-	-	-	-	B	NSYTLB	NSYTL BU	NSYTL BFL	-
300	400	200	-	-	-	-	D	NSYTLD	NSYTLDU	NSYTLDLFL	NSYTLDME
400	300	150	-	-	-	-	B	NSYTLB	NSYTL BU	NSYTL BFL	-
400	300	200	-	-	-	-	C	NSYTLC	NSYTLCU	NSYTLCFL	NSYTLCME
400	400	200	-	-	-	-	D	NSYTLD	NSYTLDU	NSYTLDLFL	NSYTLDME
400	600	200	NSYVDM8UF	8	NSYVDM7UP	7	F	NSYT LF	NSYT LFU	NSYT LFFL	NSYT LFME
400	600	250	NSYVDM8UF	8	NSYVDM7UP	7	F	NSYT LF	NSYT LFU	NSYT LFFL	NSYT LFME
500	300	200	-	-	-	-	C	NSYTLC	NSYTLCU	NSYTLCFL	NSYTLCME
500	400	200	-	-	-	-	D	NSYTLD	NSYTLDU	NSYTLDLFL	NSYTLDME
500	400	250	-	-	-	-	D	NSYTLD	NSYTLDU	NSYTLDLFL	NSYTLDME
500	500	200	-	-	-	-	E	NSYTLE	NSYTLEU	NSYTLEFL	NSYTLEME
500	500	250	-	-	-	-	E	NSYTLE	NSYTLEU	NSYTLEFL	NSYTLEME
600	400	200	-	-	-	-	D	NSYTLD	NSYTLDU	NSYTLDLFL	NSYTLDME
600	400	250	-	-	-	-	D	NSYTLD	NSYTLDU	NSYTLDLFL	NSYTLDME
600	500	250	-	-	-	-	E	NSYTLE	NSYTLEU	NSYTLEFL	NSYTLEME
600	600	200	NSYVDM12UF	12	NSYVDM11UP	11	F	NSYT LF	NSYT LFU	NSYT LFFL	NSYT LFME
600	600	250	NSYVDM12UF	12	NSYVDM11UP	11	F	NSYT LF	NSYT LFU	NSYT LFFL	NSYT LFME
600	600	300	NSYVDM12UF	12	NSYVDM11UP	11	G	NSYT LG	NSYT LGU	NSYT LG2FL ⁽⁵⁾	NSYT LGME
600	600	400	NSYVDM12UF	12	NSYVDM11UP	11	G	NSYT LG	NSYT LGU	NSYT LG2FL ⁽⁵⁾	NSYT LGME
600	800	300	-	-	-	-	D ⁽⁴⁾	NSYTLD	NSYTLDU	NSYTLDLFL	2x NSYTLDME
700	500	250	-	-	-	-	E	NSYTLE	NSYTLEU	NSYTLEFL	NSYTLEME
800	600	200	NSYVDM17UF	17	NSYVDM16UP	16	F	NSYT LF	NSYT LFU	NSYT LFFL	NSYT LFME
800	600	250	NSYVDM17UF	17	NSYVDM16UP	16	F	NSYT LF	NSYT LFU	NSYT LFFL	NSYT LFME
800	600	300	NSYVDM17UF	17	NSYVDM16UP	16	G	NSYT LG	NSYT LGU	NSYT LG2FL ⁽⁵⁾	NSYT LGME
800	600	400	NSYVDM17UF	17	NSYVDM16UP	16	G	NSYT LG	NSYT LGU	NSYT LG2FL ⁽⁵⁾	NSYT LGME
800	800	250	-	-	-	-	D ⁽⁴⁾	NSYTLD	NSYTLDU	NSYTLDLFL	2x NSYTLDME
800	800	300	-	-	-	-	D ⁽⁴⁾	NSYTLD	NSYTLDU	NSYTLDLFL	2x NSYTLDME
800	1000	300	-	-	-	-	E ⁽⁴⁾	NSYTLE	NSYTLEU	NSYTLEFL	2x NSYTLEME
800	1000	300	-	-	-	-	E ⁽⁴⁾	NSYTLE	NSYTLEU	NSYTLEFL	2x NSYTLEME
800	1200	300	-	-	-	-	E ⁽⁴⁾	NSYTLE	NSYTLEU	NSYTLEFL	2x NSYTLEME
1000	600	250	NSYVDM21UF	21	NSYVDM20UP	20	F	NSYT LF	NSYT LFU	NSYT LFFL	NSYT LFME
1000	600	300	NSYVDM21UF	21	NSYVDM20UP	20	G	NSYT LG	NSYT LGU	NSYT LG2FL ⁽⁵⁾	NSYT LGME
1000	600	400	NSYVDM21UF	21	NSYVDM20UP	20	G	NSYT LG	NSYT LGU	NSYT LG2FL ⁽⁵⁾	NSYT LGME
1000	800	250	-	-	-	-	D ⁽⁴⁾	NSYTLD	NSYTLDU	NSYTLDLFL	2x NSYTLDME
1000	800	300	-	-	-	-	D ⁽⁴⁾	NSYTLD	NSYTLDU	NSYTLDLFL	2x NSYTLDME
1000	800	400	-	-	-	-	D ⁽⁴⁾	NSYTLD	NSYTLDU	NSYTLDLFL	2x NSYTLDME
1000	1000	300	-	-	-	-	E ⁽⁴⁾	NSYTLE	NSYTLEU	NSYTLEFL	2x NSYTLEME
1000	1000	300	-	-	-	-	E ⁽⁴⁾	NSYTLE	NSYTLEU	NSYTLEFL	2x NSYTLEME
1000	1200	300	-	-	-	-	E ⁽⁴⁾	NSYTLE	NSYTLEU	NSYTLEFL	2x NSYTLEME
1000	1200	400	-	-	-	-	E ⁽⁴⁾	NSYTLE	NSYTLEU	NSYTLEFL	2x NSYTLEME
1200	600	300	-	-	-	-	G	NSYT LG	NSYT LGU	NSYT LG2FL ⁽⁵⁾	NSYT LGME
1200	600	400	-	-	-	-	G	NSYT LG	NSYT LGU	NSYT LG2FL ⁽⁵⁾	NSYT LGME
1200	800	300	-	-	-	25	D ⁽⁴⁾	NSYTLD	NSYTLDU	NSYTLDLFL	2x NSYTLDME
1200	800	400	-	-	-	25	D ⁽⁴⁾	NSYTLD	NSYTLDU	NSYTLDLFL	2x NSYTLDME
1200	1000	300	-	-	-	-	E ⁽⁴⁾	NSYTLE	NSYTLEU	NSYTLEFL	2x NSYTLEME
1200	1000	300	-	-	-	-	E ⁽⁴⁾	NSYTLE	NSYTLEU	NSYTLEFL	2x NSYTLEME
1200	1000	400	-	-	-	-	E ⁽⁴⁾	NSYTLE	NSYTLEU	NSYTLEFL	2x NSYTLEME
1200	1200	300	-	-	-	-	E ⁽⁴⁾	NSYTLE	NSYTLEU	NSYTLEFL	2x NSYTLEME
1200	1200	400	-	-	-	-	E ⁽⁴⁾	NSYTLE	NSYTLEU	NSYTLEFL	2x NSYTLEME
1400	1000	300	-	-	-	-	E ⁽⁴⁾	NSYTLE	NSYTLEU	NSYTLEFL	2x NSYTLEME

⁽¹⁾ For other dimensions, see our application offer, page 16.

⁽²⁾ FL13 for entry type A and B FL21 for all other entries.

⁽³⁾ To adjust the depth of the internal door, please order the step slides.

⁽⁴⁾ 2 plates.

⁽⁵⁾ Exists with 1 cut-out NSYT LGFL.

⁽⁶⁾ Cable entry FlexiCable IP55





Composition accessories					Plinths				Dimensions ⁽¹⁾		
Internal door ⁽³⁾	Step slides	Canopy	Fixing on post	Full width wall fixing lugs	Single plinths front plate ⁽⁹⁾	Single plinths side plate ⁽⁹⁾	Single plinths front plate ⁽⁷⁾⁽⁹⁾	Single plinths side plate ⁽⁷⁾⁽⁹⁾	Height (mm)	Width (mm)	Depth (mm)
-	-	NSYTJ2015	-	NSYAEFPFS3DW20	-	-	-	-	300	200	150
-	-	NSYTJ2515	-	-	-	-	-	-	300	250	150
-	-	NSYTJ3015	NSYSFPSC30	NSYAEFPFS3DW30	-	-	-	-	300	300	150
-	NSYSDCR200	NSYTJ3020	NSYSFPSC30	NSYAEFPFS3DW30	-	-	-	-	300	300	200
-	-	NSYTJ4015	NSYSFPSC40	NSYAEFPFS3DW40	-	-	-	-	300	400	150
-	NSYSDCR200	NSYTJ4020	NSYSFPSC40	NSYAEFPFS3DW40	-	-	-	-	300	400	200
NSYPIN43	-	NSYTJ3015	NSYSFPSC30	NSYAEFPFS3DW30	-	-	-	-	400	300	150
NSYPIN43	NSYSDCR200	NSYTJ3020	NSYSFPSC30	NSYAEFPFS3DW30	-	-	-	-	400	300	200
-	NSYSDCR200	NSYTJ4020	NSYSFPSC40	NSYAEFPFS3DW40	-	-	-	-	400	400	200
-	NSYSDCR200	NSYTJ6020	NSYSFPSC60	NSYAEFPFS3DW60	-	-	-	-	400	600	200
-	NSYSDCR250	NSYTJ6025	NSYSFPSC60	NSYAEFPFS3DW60	-	-	-	-	400	600	250
-	NSYSDCR200	NSYTJ3020	NSYSFPSC30	NSYAEFPFS3DW30	-	-	-	-	500	300	200
NSYPIN54	NSYSDCR200	NSYTJ4020	NSYSFPSC40	NSYAEFPFS3DW40	-	-	-	-	500	400	200
NSYPIN54	NSYSDCR250	NSYTJ4025	NSYSFPSC40	NSYAEFPFS3DW40	-	-	-	-	500	400	250
-	NSYSDCR200	NSYTJ5020	NSYSFPSC50	NSYAEFPFS3DW50	-	-	-	-	500	500	200
-	NSYSDCR250	NSYTJ5025	NSYSFPSC50	NSYAEFPFS3DW50	-	-	-	-	500	500	250
NSYPIN64	NSYSDCR200	NSYTJ4020	NSYSFPSC40	NSYAEFPFS3DW40	-	-	-	-	600	400	200
NSYPIN64	NSYSDCR250	NSYTJ4025	NSYSFPSC40	NSYAEFPFS3DW40	-	-	-	-	600	400	250
-	NSYSDCR250	NSYTJ5025	NSYSFPSC50	NSYAEFPFS3DW50	-	-	-	-	600	500	250
-	NSYSDCR200	NSYTJ6020	NSYSFPSC60	NSYAEFPFS3DW60	-	-	-	-	600	600	200
-	NSYSDCR250	NSYTJ6025	NSYSFPSC60	NSYAEFPFS3DW60	-	-	-	-	600	600	250
-	NSYSDCR300	NSYTJ6030	NSYSFPSC60	NSYAEFPFS3DW60	NSYSPF6100	NSYS3100SD	NSYSPF6200	NSYS3200SD	600	600	300
-	NSYSDCR400	NSYTJ6040	NSYSFPSC60	NSYAEFPFS3DW60	NSYSPF6100	NSYS4100SD	NSYSPF6200	NSYS4200SD	600	600	400
-	NSYSDCR300	NSYTJ8030	NSYSFPSC80	NSYAEFPFS3DW80	NSYSPF8100	NSYS3100SD	NSYSPF8200	NSYS3200SD	600	800	300
NSYPIN75	NSYSDCR250	NSYTJ5025	NSYSFPSC50	NSYAEFPFS3DW50	-	-	-	-	700	500	250
NSYPIN86	NSYSDCR200	NSYTJ6020	NSYSFPSC60	NSYAEFPFS3DW60	-	-	-	-	800	600	200
NSYPIN86	NSYSDCR250	NSYTJ6025	NSYSFPSC60	NSYAEFPFS3DW60	-	-	-	-	800	600	250
NSYPIN86	NSYSDCR300	NSYTJ6030	NSYSFPSC60	NSYAEFPFS3DW60	NSYSPF6100	NSYS3100SD	NSYSPF6200	NSYS3200SD	800	600	300
NSYPIN86	NSYSDCR400	NSYTJ6040	NSYSFPSC60	NSYAEFPFS3DW60	NSYSPF6100	NSYS4100SD	NSYSPF6200	NSYS4200SD	800	600	400
-	NSYSDCR250	NSYTJ8025	NSYSFPSC80	NSYAEFPFS3DW80	-	-	-	-	800	800	250
-	NSYSDCR300	NSYTJ8030	NSYSFPSC80	NSYAEFPFS3DW80	NSYSPF8100	NSYS3100SD	NSYSPF8200	NSYS3200SD	800	800	300
-	NSYSDCR300	NSYTJ10030	-	NSYAEFPFS3DW100	NSYSPF10100	NSYS3100SD	NSYSPF10200	NSYS3200SD	800	1000	300
-	NSYSDCR300	NSYTJ10030	-	NSYAEFPFS3DW100	NSYSPF10100	NSYS3100SD	NSYSPF10200	NSYS3200SD	800	1000	300
-	NSYSDCR300 ⁽⁶⁾	NSYTJ12030	-	NSYAEFPFS3DW120	-	-	-	-	800	1200	300
NSYPIN106	NSYSDCR250	NSYTJ6025	-	NSYAEFPFS3DW60	-	-	-	-	1000	600	250
NSYPIN106	NSYSDCR300	NSYTJ6030	-	NSYAEFPFS3DW60	NSYSPF6100	NSYS3100SD	NSYSPF6200	NSYS3200SD	1000	600	300
NSYPIN106	NSYSDCR400	NSYTJ6040	-	NSYAEFPFS3DW60	NSYSPF6100	NSYS4100SD	NSYSPF6200	NSYS4200SD	1000	600	400
NSYPIN108	NSYSDCR250	NSYTJ8025	-	NSYAEFPFS3DW80	-	-	-	-	1000	800	250
NSYPIN108	NSYSDCR300	NSYTJ8030	-	NSYAEFPFS3DW80	NSYSPF8100	NSYS3100SD	NSYSPF8200	NSYS3200SD	1000	800	300
NSYPIN108	NSYSDCR400	NSYTJ8040	-	NSYAEFPFS3DW80	NSYSPF8100	NSYS4100SD	NSYSPF8200	NSYS4200SD	1000	800	400
-	NSYSDCR300	NSYTJ10030	-	NSYAEFPFS3DW100	NSYSPF10100	NSYS3100SD	NSYSPF10200	NSYS3200SD	1000	1000	300
-	NSYSDCR300	NSYTJ10030	-	NSYAEFPFS3DW100	NSYSPF10100	NSYS3100SD	NSYSPF10200	NSYS3200SD	1000	1000	300
-	NSYSDCR300 ⁽⁶⁾	NSYTJ12030	-	NSYAEFPFS3DW120	NSYSPF12100	NSYS3100SD	NSYSPF12200	NSYS3200SD	1000	1200	300
-	NSYSDCR400 ⁽⁶⁾	NSYTJ12040	-	NSYAEFPFS3DW120	NSYSPF12100	NSYS4100SD	NSYSPF12200	NSYS4200SD	1000	1200	400
NSYPIN126	NSYSDCR300	NSYTJ6030	-	NSYAEFPFS3DW60	NSYSPF6100	NSYS3100SD	NSYSPF6200	NSYS3200SD	1200	600	300
NSYPIN126	NSYSDCR400	NSYTJ6040	-	NSYAEFPFS3DW60	NSYSPF6100	NSYS4100SD	NSYSPF6200	NSYS4200SD	1200	600	400
NSYPIN128	NSYSDCR300	NSYTJ8030	-	NSYAEFPFS3DW80	NSYSPF8100	NSYS3100SD	NSYSPF8200	NSYS3200SD	1200	800	300
NSYPIN128	NSYSDCR400	NSYTJ8040	-	NSYAEFPFS3DW80	NSYSPF8100	NSYS4100SD	NSYSPF8200	NSYS4200SD	1200	800	400
-	NSYSDCR300	NSYTJ10030	-	NSYAEFPFS3DW100	NSYSPF10100	NSYS3100SD	NSYSPF10200	NSYS3200SD	1200	1000	300
-	NSYSDCR300	NSYTJ10030	-	NSYAEFPFS3DW100	NSYSPF10100	NSYS3100SD	NSYSPF10200	NSYS3200SD	1200	1000	300
-	NSYSDCR400	NSYTJ10040	-	NSYAEFPFS3DW100	NSYSPF10100	NSYS4100SD	NSYSPF10200	NSYS4200SD	1200	1000	400
-	NSYSDCR300 ⁽⁶⁾	NSYTJ12030	-	NSYAEFPFS3DW120	NSYSPF12100	NSYS3100SD	NSYSPF12200	NSYS3200SD	1200	1200	300
-	NSYSDCR400 ⁽⁶⁾	NSYTJ12040	-	NSYAEFPFS3DW120	NSYSPF12100	NSYS4100SD	NSYSPF12200	NSYS4200SD	1200	1200	400
-	NSYSDCR300	NSYTJ10030	-	NSYAEFPFS3DW100	NSYSPF10100	NSYS3100SD	NSYSPF10200	NSYS3200SD	1400	1000	300

⁽⁷⁾ Also available in ventilated version with cable gland for widths of 600 and 800, see page 125.

⁽⁶⁾ For the double mounting plates,

⁽⁹⁾ To install the plinth to a wall-mounted enclosure, order ref. **NSYAPFWM**.

Composition accessories

Dimensions							
Height (mm)	Width (mm)	Depth (mm)	Support pillar adaption plate	Support pillar	Floor stand kit for wall-mounted		Support bracket for enclosure with anti-tilt kit and reinforcement
					300 mm	400 mm	1400 mm (1)
300	200	150	-	-	-	-	NSYCOCNS1400
300	250	150	-	-	-	-	NSYCOCNS1400
300	300	150	NSYAEFP315S3D	NSYCOCN80	-	-	NSYCOCNS1400
300	300	200	NSYAEFP32S3D	NSYCOCN80	-	-	NSYCOCNS1400
300	400	150	NSYAEFP315S3D	NSYCOCN80	-	-	NSYCOCNS1400
300	400	200	NSYAEFP42S3D	NSYCOCN80	-	-	NSYCOCNS1400
400	300	150	NSYAEFP315S3D	NSYCOCN80	-	-	NSYCOCNS1400
400	300	200	NSYAEFP32S3D	NSYCOCN80	-	-	NSYCOCNS1400
400	400	200	NSYAEFP42S3D	NSYCOCN80	-	-	NSYCOCNS1400
400	600	200	-	-	-	-	NSYCOCNS1400
400	600	250	-	-	-	-	NSYCOCNS1400
500	300	200	NSYAEFP32S3D	NSYCOCN80	-	-	NSYCOCNS1400
500	400	200	NSYAEFP42S3D	NSYCOCN80	-	-	NSYCOCNS1400
500	400	250	NSYAEFP42S3D	NSYCOCN80	-	-	NSYCOCNS1400
500	500	200	-	-	-	-	NSYCOCNS1400
500	500	250	-	-	-	-	NSYCOCNS1400
600	400	200	NSYAEFP42S3D	NSYCOCN80	-	-	NSYCOCNS1400
600	400	250	NSYAEFP42S3D	NSYCOCN80	-	-	NSYCOCNS1400
600	500	250	-	-	-	-	NSYCOCNS1400
600	600	200	-	-	-	-	NSYCOCNS1400
600	600	250	-	-	-	-	NSYCOCNS1400
600	600	300	-	-	-	-	NSYCOCNS1400
600	600	400	-	-	-	-	NSYCOCNS1400
600	800	300	-	-	-	-	NSYCOCNS1400
700	500	250	-	-	-	-	NSYCOCNS1400
800	600	200	-	-	-	-	NSYCOCNS1400
800	600	250	-	-	-	-	NSYCOCNS1400
800	600	300	-	-	-	-	NSYCOCNS1400
800	600	400	-	-	-	-	NSYCOCNS1400
800	800	250	-	-	-	-	NSYCOCNS1400
800	800	300	-	-	NSYWMK33	NSYWMK34	NSYCOCNS1400
800	1000	300	-	-	NSYWMK33	NSYWMK34	NSYCOCNS1400
800	1000	300	-	-	-	-	NSYCOCNS1400
800	1200	300	-	-	NSYWMK33	NSYWMK34	NSYCOCNS1400
1000	600	250	-	-	-	-	NSYCOCNS1400
1000	600	300	-	-	-	-	NSYCOCNS1400
1000	600	400	-	-	-	-	NSYCOCNS1400
1000	800	250	-	-	-	-	NSYCOCNS1400
1000	800	300	-	-	NSYWMK33	NSYWMK34	NSYCOCNS1400
1000	800	400	-	-	NSYWMK43	NSYWMK44	-
1000	1000	300	-	-	NSYWMK33	NSYWMK34	-
1000	1000	300	-	-	NSYWMK33	NSYWMK34	-
1000	1000	400	-	-	NSYWMK43	NSYWMK44	-
1000	1200	300	-	-	NSYWMK33	NSYWMK34	-
1000	1200	400	-	-	NSYWMK43	NSYWMK44	-
1200	600	300	-	-	-	-	-
1200	600	400	-	-	-	-	-
1200	800	300	-	-	NSYWMK33	NSYWMK34	-
1200	800	400	-	-	NSYWMK43	NSYWMK44	-
1200	1000	300	-	-	NSYWMK33	NSYWMK34	-
1200	1000	300	-	-	NSYWMK33	NSYWMK34	-
1200	1000	400	-	-	NSYWMK43	NSYWMK44	-
1200	1200	300	-	-	NSYWMK33	NSYWMK34	-
1200	1200	400	-	-	NSYWMK43	NSYWMK44	-
1400	1000	300	-	-	NSYWMK33	NSYWMK34	-

⁽¹⁾ Available in version 1800 mm: ref. NSYCOCNS1800.

Comment:

You will find the weights of the Spacial S3D enclosures without mounting plate in the selection guide on [page 74](#).

Wall fixing lugs

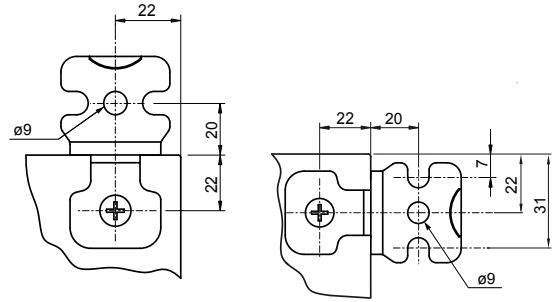

Supply:
Supplied with fixing screws and pre-mounted sealing gaskets



NSYAEFFSC

- Set of 4 wall fixing lugs.
- Mounted directly on the rear of the enclosure, either in horizontal or vertical position.
- Wall-enclosure separation of 12 mm.
- Do not use for dynamic loads.
- Maximum load: 250 kg

Characteristics	References
Wall fixing lugs, passivated zinc-coated steel, for indoor enclosure	NSYAEFFSC
Wall fixing lugs, 304L stainless-steel	NSYAEFFXSC



NSYAEFFSC2

Supply:
4 fixing brackets + covers

Characteristics	References
Wall fixing lugs + cover, passivated zinc-coated steel + PA	NSYAEFFSC2



NSYCAEFPF

Supply:
Kit of 4 covers

Characteristics	References
Cover for wall fixing brackets, PA	NSYCAEFPF

Kit for heavy loads



NSYAEFAHLBSC

- Set of 2 reinforcement pieces.
- To be mounted before installing the mounting plate in top position with the standard lugs (to be ordered separately).
- This kit is mandatory for wall-mounted enclosures bigger than 800 x 800 mm.
- Material: Passivated zinc-coated steel
- Maximum load: 400 kg

Characteristics	References
Kit for heavy loads	NSYAEFAHLBSC

Wall fixing lugs with wall-enclosure separation



NSYAEFF40SC

- Set of 4 wall fixing lugs.
- Separation of 40 mm from the wall at the rear of the enclosure.
- Requires a drilled hole to prevent rotation.
- Material: Passivated zinc-coated steel
- Maximum load: 100 kg

Characteristics	References
Wall fixing lugs with wall-enclosure separation	NSYAEFF40SC

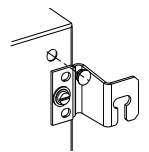

Full-width wall fixing lugs

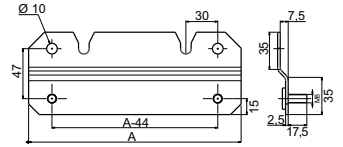

Comment:
For more information see [page 105](#)

- Kit made of 2 parts (top and bottom).
- Screwed from the inside.
- Material: Passivated zinc-coated steel
- Maximum load: 350 kg



NSYAEFPFS3DW20

Characteristics	Width (mm)	A (mm)	References
Heavy load reinforcement	200	-	NSYAEFPFS3DW20
Heavy load reinforcement	300	295	NSYAEFPFS3DW30
Heavy load reinforcement	400	395	NSYAEFPFS3DW40
Heavy load reinforcement	500	495	NSYAEFPFS3DW50
Heavy load reinforcement	600	595	NSYAEFPFS3DW60
Heavy load reinforcement	800	795	NSYAEFPFS3DW80
Heavy load reinforcement	1000	-	NSYAEFPFS3DW100
Heavy load reinforcement	1200	-	NSYAEFPFS3DW120

Post fixing device for Spacial steel enclosure

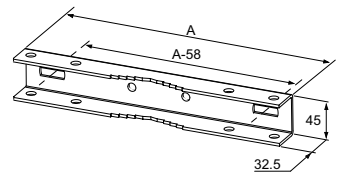

Supply:
2 pieces

Comment:
For more information see [page 105](#)

- For indoor installations on posts with a maximum circumference of 675 mm (minimum diameter 150 mm and maximum diameter 215 mm).
- Rail fixed to the inserts in the rear of the enclosure with 8 mm screws.
- They allow the mounting of protection canopies.
- Material: Passivated zinc-coated steel
- Maximum load: 100 kg



NSYSFPSC30

Characteristics	Width (mm)	A (mm)	References
Post fixing	300	295	NSYSFPSC30
Post fixing	400	395	NSYSFPSC40
Post fixing	500	495	NSYSFPSC50
Post fixing	600	595	NSYSFPSC60
Post fixing	800	795	NSYSFPSC80

Support pillar



NSYCOCN80

- The support pillar is fixed directly to the bottom face of the Spacial steel enclosure by means of an adapter plate.
- The adapter plate, to be ordered in addition to the pillar, replaces the cable gland plate.
- Overall height of the support foot: 800 mm.
- Mounting possible on all enclosures with dimensions up to 600 x 400 x 250 mm (except 200 x 200 x 150 mm and 250 x 200 x 150 mm enclosures).
- Material: Extruded aluminum
- Finish: Epoxy polyester paint
- Color: RAL 7035 grey

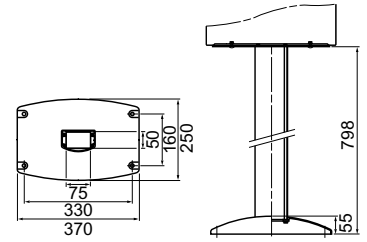

Characteristics	Height (mm)	References
Support pillar	800	NSYCOCN80

Support pillar adaptation plate



NSYAEFP315S3D

- Description: Plate for fixing the support pillar on the enclosure.
- This plate replaces the cable gland plate delivered with the enclosure.
- Material: Steel
- Finish: Polyester powder
- Color: RAL 7035 grey

Characteristics	For enclosure width (mm)	For enclosure depth (mm)	References
Support pillar adaptation plate	300-400	150	NSYAEFP315S3D
Support pillar adaptation plate	300	200	NSYAEFP32S3D
Support pillar adaptation plate	400	200-250	NSYAEFP42S3D

Support bracket for enclosure with anti-tilt kit and reinforcement



NSYCOCN1400

- The support bracket is used when the enclosure cannot be hung from a wall or a post.
- Maximum enclosure dimensions: 1000 x 800 x 300 mm.
- Floor attachment by standard M12 fastenings.
- Material: Steel
- Finish: Epoxy polyester paint
- Color: RAL 7035 grey
- Maximum load: 120 kg

Characteristics	Height (mm)	References
Support bracket for enclosure with anti-tilt kit and reinforcement	1400	NSYCOCN1400
Support bracket for enclosure with anti-tilt kit and reinforcement	1800	NSYCOCN1800

Floor Stand Kit for wall-mounted enclosure



NSYWMK33

- Set of 2 feet, elevating wall-mounted enclosures.
- Cut-outs needed on enclosure – drilling template provided with the kit.
- Material: Steel
- Finish: Epoxy polyester paint
- Color: RAL 7035 grey
- Thickness: Sides: 25/10° mm, Base: 30/10° mm
- Maximum load: 250 kg
- Compatible with Spacial S3D, S3DC enclosures.
- Enclosure depth 300 mm: When enclosures are equipped with a cable gland plate, it only fits with enclosures of width 800, 1000 and 1200 mm, except model H 600 x W 800 x D 300 mm.
- Enclosure depth 400 mm: When enclosures are equipped with a cable gland plate, it does not fit with enclosures of width 600 mm.

Supply:
2 platform feet (right and left) and fixing elements

Characteristics	Enclosure depth (mm)	(Inches)	Foot height (mm)	(Inches)	References
Floor stand for Spacial S3D	300	12	300	12	NSYWMK33
Floor stand for Spacial S3D	400	16	300	12	NSYWMK43
Floor stand for Spacial S3D	300	12	450	18	NSYWMK34
Floor stand for Spacial S3D	400	16	450	18	NSYWMK44

Front and rear plinths

- The front and rear of the plinth consists of 4 corners with 2 or 4 panels.
- Material: Folded sheet steel, corner with a thickness of 25/10° mm
- Finish: Structured finish, epoxy polyester powder
- Color: RAL 7022 grey
- Ingress protection rating: IP30 according to IEC 60529
- Mechanical protection rating: IK10 according to IEC 62262



Characteristics	Width (mm)	Height (mm)	References
Front plinths for Spacial	600	100	NSYSPPF6100
Front plinths for Spacial	800	100	NSYSPPF8100
Front plinths for Spacial	1000	100	NSYSPPF10100
Front plinths for Spacial	1200	100	NSYSPPF12100
Front plinths for Spacial	600	200	NSYSPPF6200
Front plinths for Spacial	800	200	NSYSPPF8200
Front plinths for Spacial	1000	200	NSYSPPF10200
Front plinths for Spacial	1200	200	NSYSPPF12200

Installation:

It is necessary to order separately the plinth fixing kit (ref. **NSYAPFWM**) composed by fixing hardware and drilling jig

Comment:

For more information see [page 124](#)

Supply:

Height 100 mm: 4 corners, 2 panels (front and rear), 4 corner covers and fixing elements. Height 200 mm: 4 corners, 4 panels (2 front and 2 rear), 4 corner covers and fixing elements

Plinth side panels

- They are fixed to the corner of the plinth by 2 fixing screws.
- Folded sheet steel
- Finish: Structured finish, epoxy polyester powder
- Color: RAL 7022 grey
- Ingress protection rating: IP30 according to IEC 60529
- Mechanical protection rating: Mechanical protection rating



Characteristics	Depth (mm)	Height (mm)	References
Side plinths for Spacial	300	100	NSYSPPS3100SD
Side plinths for Spacial	400	100	NSYSPPS4100SD
Side plinths for Spacial	300	200	NSYSPPS3200SD
Side plinths for Spacial	400	200	NSYSPPS4200SD

Supply:

Height 100 mm: 2 side panels, 4 corner covers and fixing elements. Height 200 mm: 4 side panels (height of 100 mm, 2 for each side), 4 corner covers and fixing elements



Stainless-steel plinths (standard plinths [page 167](#), ventilated plinths [page 441](#)) are compatible with steel wall-mounted S3D enclosures using an earthing cable reference **NSYEL226D13** (description [page 323](#)) to be ordered separately.

Coupling of S3D steel enclosures

- Available in 2 versions:
 - Coupling version without cable entry.
 - Version with coupling frame allowing the entry of cables.
- Spacing of 17 mm between 2 coupled enclosures, allowing full opening of the doors.
- Allows lateral coupling of 2 enclosures.
- These frames allow the door to open to 120°.
- Material: Fiberglass-reinforced polyester, self-extinguishing
- Ingress protection rating: IP66 according to IEC 60529

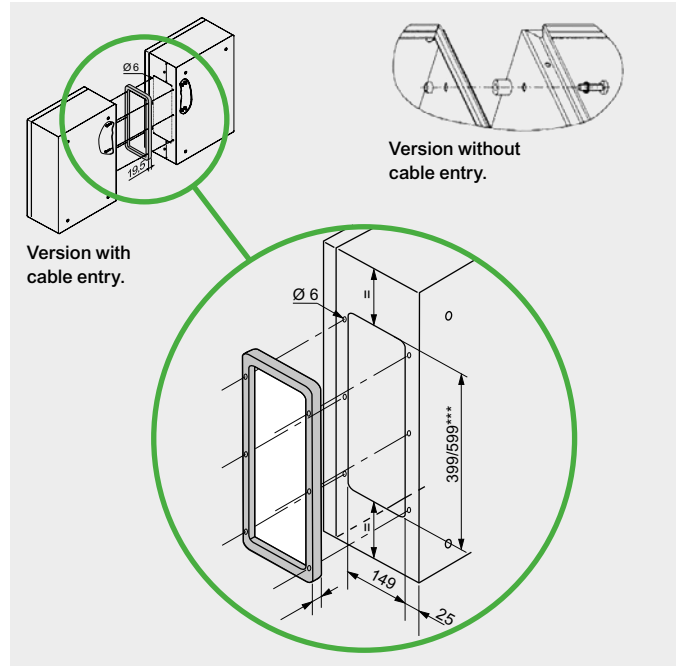

Supply:

Set of 4 spacers and their fixings. Mounting by screws, included

Coupling spacers



NSYAEUBUSC

Characteristics	References
Set of 4 coupling spacers	NSYAEUBUSC

Coupling frame



NSYAEUBU41SC

Characteristics	References
Coupling frame, 435 x 185 mm	NSYAEUBU41SC
Coupling frame, 635 x 185 mm	NSYAEUBU61SC

Eyebolts



NSYAELYTCRG8

- Set of two M8 eyebolts. They are fixed directly to the body of the floor-standing enclosure. Cannot be installed with the canopy in place or if it is planned to put one.
- Material: Zinc-coated molded steel
- Maximum load: 200 kg per enclosure when slinging at 60°

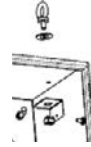

Supply:
Reinforcing brackets attached to the rings (these brackets also act as a drilling template)

Characteristics

Set of 2 M8 eyebolts

References

NSYAELYTCRG8

Protection canopy



NSYTJ2015

- Direct fixing to the body of the enclosure by four M6 screws.
- Material: Sheet steel
- Finish: Epoxy polyester paint
- Color: RAL 7035 grey

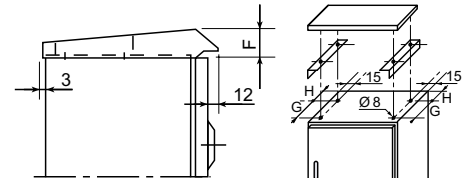

Supply:
Delivered with the fixings required for installation

Characteristics	Width (mm)	Depth (mm)	F (mm)	G (mm)	H (mm)	References
Protection canopy	200	150	36	75	23	NSYTJ2015
Protection canopy	250	150	36	75	23	NSYTJ2515
Protection canopy	300	150	36	75	23	NSYTJ3015
Protection canopy	400	150	36	75	23	NSYTJ4015
Protection canopy	500	150	36	75	23	NSYTJ5015
Protection canopy	500	200	36	130	23	NSYTJ5020
Protection canopy	600	200	36	130	23	NSYTJ6020
Protection canopy	250	200	36	130	23	NSYTJ2520
Protection canopy	300	200	36	130	23	NSYTJ3020
Protection canopy	400	200	36	130	23	NSYTJ4020
Protection canopy	800	200	36	130	23	NSYTJ8020
Protection canopy	400	250	42	150	48	NSYTJ4025
Protection canopy	500	250	42	150	48	NSYTJ5025
Protection canopy	600	250	42	150	48	NSYTJ6025
Protection canopy	800	250	42	150	48	NSYTJ8025
Protection canopy	600	300	42	200	48	NSYTJ6030
Protection canopy	800	300	42	200	48	NSYTJ8030
Protection canopy	1000	300	42	200	48	NSYTJ10030
Protection canopy	1200	300	42	200	48	NSYTJ12030
Protection canopy	600	400	42	300	48	NSYTJ6040
Protection canopy	800	400	42	300	48	NSYTJ8040
Protection canopy	1000	400	42	300	48	NSYTJ10040
Protection canopy	1200	400	42	300	48	NSYTJ12040

Mounting rail



NSYSUCR200WM

- Accessory designed to optimize the available space inside the enclosure.
- It is intended for the installation of switchgear to extend the chassis.
- Mounting possible after installing the mounting plate.
- It is mounted horizontally, with a single screw, on the side panels.
- Door switch mounting option.
- It is possible to vertically fasten **NSYSLCR●●** light cross-rails (description on [page 276](#)) and **NSYSQCR●●** quick-fixing cross-rails (description on [page 274](#)).
- Material: Galvanized steel
- Maximum load: Static load: 6 kg (sides) and 1.5 kg (top); Dynamic load (transport horizontally): 2 kg according to ASTM D-4169-16
- Installation: In order to ensure the electrical continuity in all cases it is recommended to use an earthing cable **NSYEL●●●D6** or **NSYEL●●●D8**, see [page 323](#)



Supply:
Set of 2 cross-rails

Characteristics	Enclosure depth (mm)	References
Mounting rail for wall-mounted enclosure S3D/CRN	200	NSYSUCR200WM
Mounting rail for wall-mounted enclosure S3D/CRN	250	NSYSUCR250WM
Mounting rail for wall-mounted enclosure S3D/CRN	300	NSYSUCR300WM
Mounting rail for wall-mounted enclosure S3D/CRN	400	NSYSUCR400WM

Standard handle

- Operating handle delivered with the enclosure.
- It can be attached to the locking system by means of a fixing element.
- It can also be used to loosen the caps helping protect the studs when painting.



NSYAEDLS3DKDB3

Characteristics	References
Standard handle	NSYAEDLS3DKDB3

Standard handles with keys

- Attractive and ergonomic bi-material handle.
- Large range of barrels covering all the most common needs.
- The installation of the standard handle does not require the escutcheon to be removed.
- Locks may only be operated using the supplied keys.
- Delivery: Delivered with 2 keys

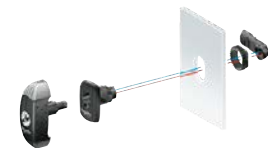

NSYAEDL1242S3D

Characteristics	References
405	NSYAEDL405S3D
421	NSYAEDL421S3D
455	NSYAEDL455S3D
520	NSYAEDL520S3D
601	NSYAEDL601S3D
610E	NSYAEDL610S3D
705E	NSYAEDL705S3D
1242	NSYAEDL1242S3D
1332E	NSYAEDL1332S3D
1344E	NSYAEDL1344S3D
2124E	NSYAEDL2124S3D
2131A	NSYAEDL2131S3D
2132A	NSYAEDL2132S3D
2133A	NSYAEDL2133S3D
2241A	NSYAEDL2241S3D
2244E	NSYAEDL2244S3D
2314E	NSYAEDL2314S3D
2322A	NSYAEDL2322S3D
2331A	NSYAEDL2331S3D
2432E	NSYAEDL2432S3D
2433A	NSYAEDL2433S3D
3113A	NSYAEDL3113S3D
3123E	NSYAEDL3123S3D
3131A	NSYAEDL3131AS3D
3132A	NSYAEDL3132S3D
3432E	NSYAEDL3432S3D
3524E	NSYAEDL3524S3D
4322A	NSYAEDL4322S3D
4324E	NSYAEDL4324S3D
5124A	NSYAEDL5124S3D

Standard locks

- Spacial S3D wall-mounted enclosures are supplied with a 3-mm double-bar lock as **standard**.
- Spare lock: Order ref. **NSYAEDLS3DRL** (escutcheon + cam + washer).
- Large range of standardised inserts covering all the most common needs.
- Installation and removal with a single screw.
- Material: Zamack + polyamide
- Ingress protection rating: IP66 according to IEC 60529

Supply:
Delivered with 1 plastic key



NSYAEDLS6S3D

Characteristics	References
6 mm square	NSYAEDLS6S3D
7 mm square	NSYAEDLS7S3D
8 mm square	NSYAEDLS8S3D
3-mm double-bar	NSYAEDLB3S3D
5-mm double-bar	NSYAEDLB5S3D
CNOMO 6.5 mm triangular	NSYAEDLT6S3D
8 mm triangular	NSYAEDLT8S3D

Barrel DIN kit

- Mounting of half-cylinder according to DIN 18252 (EN1303). Cam can be turned every 45°.
- Easy mounting instead of standard lock.
- Compatible with PLM barrels offer. See [page 177](#). (Example: **NSYTL1242EME**).
- Material: Polyamide GF
- Ingress protection rating: IP66 according to IEC 60529

Supply:
Delivered with metal cam 1 point and metal cam 3 points



NSYAEDDINS3D

Characteristics	References
Barrel DIN kit	NSYAEDDINS3D

Double-bar 3 mm metal lock

- Easy mounting instead of standard lock.
- Material: Zamak
- Ingress protection rating: IP66 according to IEC 60529

Supply:
Delivered with metal cam 1 point and metal cam 3 points



NSYAEDLB3MS3D

Characteristics	References
Double-bar 3 mm metal lock	NSYAEDLB3MS3D

Metal cam kit 1 point and 3 points

- To adapt other locks.
- Material: Zinc-coated metal

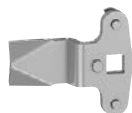

NSYAEDLMETS3D

Characteristics	References
Metal cam kit 1 point and 3 points	NSYAEDLMETS3D

Lock with screwdriver insert and metal latch

- Material: Zamak
- Ingress protection rating: IP55 (IEC 60529)

Supply:
Delivered with housing, insert, fixing nut and metal cam 3 points



NSYAEDLSDS3D

Characteristics	References
Lock with screwdriver insert and metal latch	NSYAEDLSDS3D

Padlock

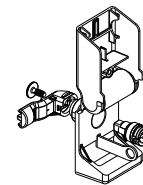

NSYAEDLPADS3D

- Easy mounting instead of the standard lock.
- Padlockable, diameter 8 mm
- Material: Zamak
- Ingress protection rating: IP66 (IEC 60529)

Supply:
Delivered with metal key

Characteristics	References
Padlock	NSYAEDLPADS3D

Other locks with keys



NSYAEDLEDF13S3D

- Material: Zamak
- Ingress protection rating: IP66 (IEC 60529)

Supply:
Delivered with metal cam 1 point
and metal cam 3 points

Characteristics	References
EDF 900	NSYAEDLEDF9S3D
EDF 1300	NSYAEDLEDF13S3D
EDF 1400	NSYAEDLEDF14S3D

"Push-close" locking system



NSYAEDLPSS3D

- The Spacial S3D enclosures can be transformed into push-close enclosures.
- The push-close enclosure is used in various applications and fully meets the security demands of the market.
- Locking system with a 6.5 mm push-close system in accordance with CNOMO standards.
- This system allows the door to be closed and locked by simply pushing it.
- System made up of a lock and a locking system plate.
- It is only installed on enclosures with 1 locking point (H < 600 mm).
- Other dimensions: Contact us.
- Ingress protection rating: IP55 according to IEC 60529

Supply:
Delivered with metal cam 1 point

Characteristics	References
"Push-close" locking system	NSYAEDLPSS3D

Door hinges

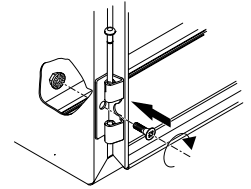

NSYAEDH180S3D NSYAEDH120S3D

- Captive pin, indexed by a spring.
- Material: Zamak body for ref. **NSYAEDH180S3D**, treated sheet steel body for ref. **NSYAEDH120S3D**, aluminum pin
- Maximum load: For the 180° hinge, the maximum admissible load on the door is 20 kg/m²
- For the 120° hinge, the maximum admissible load on the door is 50 kg/m²

Supply:
Set of 1 hinge, delivered with fixings

Characteristics	References
180° hinge for S3D enclosure	NSYAEDH180S3D
Standard 120° hinge for S3D	NSYAEDH120S3D

Door switch for wall-mounted enclosures



NSYINLCRN

- Switch/commutator unit equipped with support and fixings for direct fixing to the enclosure.
- Can be used to control lighting, air-conditioning units, etc.
- It is not compatible with installing the 19" swing rack and the internal door.
- NC + NO contact, 240 V AC / 3 A (IEC 60947-5-1) 250 V DC / 0,1 A (IEC 0947-5-1).

Supply:
1 door switch and fixing elements

Characteristics	References
Door switch	NSYINLCRN

Wall-mounted door retainer steel



NSYAEDRSCST

- To block the door in the open position.
- It is installed on enclosures with heights from 400 mm and widths from 300 mm.
 - Door opening angle: 120°.
 - Earthing connection of the enclosure by means of the reinforcement rail.
 - Earthing accessories supplied with the enclosure (earth-connection cable to be ordered separately), for more information see [page 323](#)
 - Material: Steel

Comment:
It is not compatible with installing the 19" swing rack and the internal door.

Characteristics	References
Wall-mounted door retainer Steel	NSYAEDRSCST

Wall-mounted door retainer polyamide



NSYAEDRS3DPA6

- To block the door in the open position.
- It is installed on the perforated rails of the enclosure doors at the required height.
 - Material: Polyamide 6 (PA6)

Comment:
It is only installed on enclosures with a height of less than 400 mm (no perforated rails).

Characteristics	References
Wall-mounted door retainer polyamide	NSYAEDRS3DPA6

Internal door



NSYPIN43

- Locking with 3-mm double-bar lock.
- The internal door can be installed directly on the front face of the enclosure or on the step slides (not supplied as standard).
- To mount an inner door and a mounting plate at the same time on the step slides is possible as standard.
- Incompatible with the installation of the door stop and door switch. For further details, please consult us.
- Material: Steel
- Color: RAL 7035 grey
- Maximum load: 30 kg/m²

Comment:
For more information see [page 107](#)
(¹) Equipped with welded vertical profiles in order to facilitate cable management.

Characteristics	High (mm)	Width (mm)	References
Internal door	400	300	NSYPIN43
Internal door	500	400	NSYPIN54
Internal door	600	400	NSYPIN64
Internal door	700	500	NSYPIN75
Internal door	800	600	NSYPIN86
Internal door	1000	600	NSYPIN106 ⁽¹⁾
Internal door	1000	800	NSYPIN108 ⁽¹⁾
Internal door	1200	600	NSYPIN126 ⁽¹⁾
Internal door	1200	800	NSYPIN128 ⁽¹⁾

Standard cable gland plate

- Plate delivered as standard with the Spacial S3D universal enclosure.
- Drilling marks with 25 mm spacing.
- Material: Steel, structured finish RAL 7035 grey
- Thickness: 15/10° mm
- Ingress protection rating: IP66 according to IEC 60529
- Fixing: Fixing by 4, 6, 8, 10 or 12 screws, according to the model

Comment:
For more information see [page 107](#)

Supply:
Delivered with sealing gasket and fixing hardware



Characteristics	Enclosures width (mm)	Enclosures depth (mm)	Type	Width (A)	Depth (B)	No. of markings	No. of Ø 6 holes	References
Standard	200-250	150	A	140	80	4	4	NSYTLA
Standard	300-400	150	B	245	80	7	4	NSYTLB
Standard	300	200	C	245	130	21	6	NSYTLC
Standard	400	200-250	D	345	130	33	8	NSYTLD
Standard	500	200-250	E	445	130	45	8	NSYTLE
Standard	600	200-250	F	545	130	57	10	NSYTLF
Standard	600	300-400	G	495	220	102	12	NSYTLG
Standard	800	250-300-400	D	345	130	-	-	2x NSYTLD
Standard	1000-1200	300-400	E	445	130	-	-	2x NSYTLE

Aluminum cable gland plate

- Suitable for non-magnetic applications.
- Material: Brushed-finish aluminum
- Thickness: 30/10° mm
- Ingress protection rating: IP66 according to IEC 60529
- Fixing: Fixing by 4, 6, 8, 10 or 12 screws, according to the model

Supply:
Delivered with sealing gasket and fixing hardware



Characteristics	Enclosures width (mm)	Enclosures depth (mm)	Type	Width (A)	Depth (B)	No. of markings	No. of Ø 6 holes	References
Aluminum	200-250	150	A	140	80	4	4	NSYTLAU
Aluminum	300-400	150	B	245	80	7	4	NSYTLBU
Aluminum	300	200	C	245	130	21	6	NSYTLCU
Aluminum	400	200-250	D	345	130	33	8	NSYTLDU
Aluminum	500	200-250	E	445	130	45	9	NSYTLEU
Aluminum	600	200-250	F	545	130	57	10	NSYTLFU
Aluminum	600	300-400	G	495	220	102	12	NSYTLGU
Aluminum	800	250-300-400	D	345	130	-	-	2x NSYTLDU
Aluminum	1000-1200	300-400	E	445	130	-	-	2x NSYTLEU

Cable gland plates with FL-type cut-out for cable gland membranes

- Mounting replaces the Spacial S3D plate.
- Cut-outs for installation of membranes type FL 21 (Cut-out FL13 for depth 150 mm; And cut-out FL21 for other depths.), [page 107](#).
- Material: Steel, structured finish RAL 7035 grey
- Thickness: 15/10° mm
- Fixing: Fixing by 4, 6, 8, 10 or 12 screws, according to the model
- **NSYTLG2FL** with 2 FL21 cut-outs
- **NSYTLG4FL** with 4 FL21 cut-outs
- **NSYTLAFL** cannot be mounted on enclosure width 200 and depth 150
- **NSYTLBFL** with FL13 cut-out

Comment:
For more information see [page 107](#)

Supply:
Delivered with sealing gasket and fixing hardware



Characteristics	Enclosures width (mm)	Enclosures depth (mm)	Type	Width (A)	Depth (B)	No. of markings	No. of Ø 6 holes	References
Cut-out	200-250	150	A	140	80	4	4	NSYTLAFL
Cut-out	300-400	150	B	245	80	7	4	NSYTLBFL
Cut-out	300	200	C	245	130	21	6	NSYTLCFL
Cut-out	400	200-250	D	345	130	33	8	NSYTLDFL
Cut-out	500	200-250	E	445	130	45	9	NSYTLEFL
Cut-out	600	200-250	F	545	130	57	10	NSYTLFFL
Cut-out	600	200-250	F	545	130	57	10	NSYTLF2FL
Cut-out	600	300-400	G	495	220	102	12	NSYTLGFL
Cut-out	600	300-400	G	495	220	102	12	NSYTLG2FL
Cut-out	600	300-400	G	495	220	102	12	NSYTLG4FL
Cut-out	800	250-300-400	D	345	130	-	-	2x NSYTLDFL
Cut-out	1000-1200	300-400	E	445	130	-	-	2x NSYTLEFL

FlexiCable cable entries

FlexiCable is an innovative cable gland plate for simple and fast cable entry.

There is no need to drill holes: The creation of the cable entrances takes a few seconds.

- Installation options: Replaces cable gland plate (S3D) or directly on enclosure.
- Cable diameter: Up to 26 mm.
- Ingress protection rating: IP55 according to IEC 60529
- Fixing: By 4, 6, 8, 10 or 12 screws, according to the model

Other characteristics:

- Exists in 5 sizes matching 46 sizes (132 models) of Spacial S3D steel wall-mounted enclosures
- Fire resistant 650 °C following IEC 60695-2-11
- Tested on short-circuit effect 250 A, 25 kA following IEC 61439-1

Mount FlexiCable on your S3D enclosure.



Create a hole with a screw driver.



Push the cable through FlexiCable and complete your installation.



Supply:

- 1 metal frame with pre-mounted membrane, 1 gasket, Fixing hardware

FlexiCable cable entries



NSYTL0ME

Characteristics	Enclosures width (mm)	Enclosures depth (mm)	Type	Width (A)	Depth (B)	Effective cable entrance dimensions (mm)	References
Standard	300	200	C	245	130	178 x 63	NSYTL0ME
Standard	400	200-250	D	345	130	278 x 63	NSYTL0ME
Standard	500	200-250	E	445	130	378 x 63	NSYTL0ME
Standard	600	200-250	F	545	130	478 x 63	NSYTL0ME
Standard	600	300-400	G	495	220	428 x 153	NSYTL0ME
Standard	800	250-300-400	D	345	130	-	NSYTL0ME
Standard	1000-1200	300-400	E	445	130	-	NSYTL0ME

Cable-guide to be mounted on adjustable step slides



NSYTFPCR04

- Direct mounting of cable guides NSYTFPCR04 on bracket.

Characteristics	References
Cable-guide for wall-mounted enclosure, door width 400 mm	NSYTFPCR04
Cable-guide for wall-mounted enclosure, door width 500 mm	NSYTFPCR05
Cable-guide for wall-mounted enclosure, door width 600 mm	NSYTFPCR06
Cable-guide for wall-mounted enclosure, door width 800 mm	NSYTFPCR08
Cable-guide for wall-mounted enclosure, door width 1000 mm	NSYTFPCR10





NSYTFPCR04







Supply: 2

Steel Wall-Mounted Enclosures

• For details enter the reference into the search engine of www.se.com

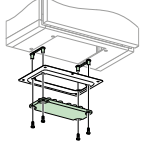
Multi-A	Multi-C	Multi-R	Multi-CS	Multi-T
				
FL13 and FL21 type membranes	Circular connector-free entries	Rectangular connector-free entries	Modular entry allowing the passing of up to 48 pre-assembled cables.	FL21-type membranes
NSYAECPFLA7	NSYTSAM504SE	NSYTSA2414SE	NSYDCD2412	NSYAECPFLBP ⁽¹⁾
NSYAECPFLA10	NSYTSAM508SE	NSYTSA2417SE	NSYDCD244	NSYAECPFLT7
NSYAECPFLA25	NSYTSAM638SE	NSYTSA2422SE	NSYDCD248	NSYAECPFLT25
NSYAECPFLA33	NSYTSAM6313SE	NSYTSA2423SE	NSYDCD249	NSYAECPFLT35
		NSYTSA2429SE		

⁽¹⁾ Metal plate

PrismaSeT	Multi-F	Multi-CF	Multi-CR	Multi-H
				
FL21 or rectangular.	FL13 and FL21 preconfigured flanges.	Cable entry for protected cables.	Cable entries with dies for cables equipped with connectors.	FL21 insulated flange with ISO knock-outs.
LVS08881	NSYAECPKFL11	NSYTLK2414	NSYDCE168	NSYTSAKFL
LVS08892	NSYAECPKFL7A	NSYTLK2422	NSYDCE244	
LVS08895	NSYAECPKFL10	NSYTLK2428	NSYDCE2410	
LVS08897		NSYTLK2446		
LVS08898		NSYTLK24M		
LVS08899				

Simple-1	Simple-2	Simple-3	Simple-4	Simple-5	Synthetic snap-in cable gland	Stainless-steel cable gland with lamellar insert	
							
Mixed membrane entries for enclosure thickness 20/10° - 32/10° mm.	PVC adjustable cone-shaped entries for enclosure thickness 30/10° - 32/10° mm.	Quick cable entries for enclosure thickness 10/10e - 40/10e mm (5/10° - 20/10° mm for ref. IMT36179).	PVC adjustable cone-shaped entries for PC tubes or for enclosure thickness 12/10° - 15/10° mm.	ISO cable gland	Without thread. Easy assembly and disassembly. Suitable for walls from 0.5 to 4 mm thick.	Lamellar technology provides excellent resistance to traction as well as excellent torsional protection. For outdoor use, or for aggressive environments. AISI 304L AISI 316L	
ISM71071	NSYECPC3	IMT36179	NSYEC7	ISM71501	NSYCGSP16	NSYCGX12	NSYCGX12H
ISM71072	NSYECPC5	IMT36180		ISM71502	NSYCGSP20	NSYCGX16	NSYCGX16H
ISM71073	NSYECPC6	IMT36181		ISM71503	NSYCGSP25	NSYCGX20	NSYCGX20H
ISM71074	NSYECPC9	IMT36182		ISM71504	NSYCGSP32	NSYCGX25	NSYCGX25H
IMT36172	NSYECPC15	IMT36183		ISM71505	NSYCGSP40	NSYCGX32	NSYCGX32H
IMT36173		IMT36184		ISM71506		NSYCGX40	NSYCGX40H
		IMT36185		IMT36150			

Technical changes reserved. Information provided without guarantee. Images are for illustrative purposes only.

Multi-A

- Material: TPE, SBS, SEBS and PP co-polymer - halogen-free
- Color: RAL 7035 grey
- Cable entry material: Combined
- Cable glands to be fitted: Optional: Specific cable clamp ref. **NSYAECPLACA●●** to be used
- Installation options:
 - On cable gland plate adapter or directly on enclosure
- Flexibility of the installation: Medium
- Reversibility: Medium
- Ingress protection rating: IP55 according to IEC 60529
- Cable retention: High with cable clamp, (up to 18 daN)
- Cable diameter (mm): From 13 to 30
- Cable Installation time: Moyenne
- Quantity of cables to be fitted for a given surface: ++
- Cable entries for cables with connectors: No
- Cut-out dimensions (mm): 134 x 52 (FL13); 214 x 90 (FL21)
- External dimensions (mm): 216 x 84
- Certificates: Cable anchorage pull test: EN 50262. Long term UV resistance: ASTM G 154-06
- Flame resistance: 750 °C
- Temperature range: -40 °C to +85 °C



NSYAECPLA33

Characteristics	Height (mm)	Width (mm)	Depth (mm)	Diameter of the cable entry (Ø mm)								References
				No.	13	14	15	16	18	21	30	
FL13 and FL21 type membranes	20	135	47	7	-	-	4	-	-	3	-	NSYAECPLA7
FL13 and FL21 type membranes	20	135	47	10	6	-	-	4	-	-	-	NSYAECPLA10
FL13 and FL21 type membranes	25	215	86	25	-	16	-	-	6	-	3	NSYAECPLA25
FL13 and FL21 type membranes	25	215	86	33	-	24	-	-	9	-	-	NSYAECPLA33

Multi-C

- Order by multiples of 10 (10, 20, 30...)
- Material: Polyamide
- Cable entry material: Soft membrane
- Cable glands to be fitted: No
- Installation options:
 - On modified cable gland plate or directly on enclosure
- Flexibility of the installation: Medium
- Reversibility: Full
- Ingress protection rating: IP55 according to IEC 60529, UL recognized (UR)
- Cable retention: Medium
- Cable diameter (mm): From 3 to 15.9
- Cable Installation time: Fast
- Quantity of cables to be fitted for a given surface: ++
- Cable entries for cables with connectors: No
- Cut-out dimensions (mm): Ø 50.5; Ø 63.5
- External dimensions (mm): Ø 58; Ø 71
- Certificates: UL 94 V-0
- Flame resistance: 650 °C



NSYTSAM508SE

Characteristics	Cut-out Ø (mm)	No.	Diameter of the cable entry (Ø mm)						References
			3-5.5	3-6.5	3.6-6.5	5-9.2	6-10	9.6-15.9	
Circular connector-free entries	50.5	4	-	-	-	-	3	1	NSYTSAM504SE
Circular connector-free entries	50.5	8	-	-	7	-	1	-	NSYTSAM508SE
Circular connector-free entries	63.5	8	-	2	-	4	-	2	NSYTSAM638SE
Circular connector-free entries	63.5	13	6	-	6	-	1	-	NSYTSAM6313SE

Multi-R

- Material: Polyamide
- Cable entry material: Soft membrane
- Cable glands to be fitted: No
- Installation options: On cable gland plate with special cut-out or directly on enclosure
- Flexibility of the installation: Medium
- Reversibility: Full
- Ingress protection rating: IP55 according to IEC 60529, UL recognized (UL)
- Cable retention: Medium
- Cable diameter (mm): From 4.3 to 15.9
- Cable Installation time: Fast
- Quantity of cables to be fitted for a given surface: ++
- Cable entries for cables with connectors: No
- Cut-out dimensions (mm): 112 x 36
- External dimensions (mm): 146 x 14 x 58
- Certificates: UL 94 V-0
- Flame resistance: 650 °C

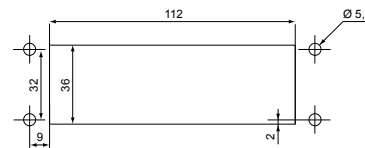

Supply:
1 unit



NSY TSA2414SE

Characteristics	Cut-out Ø (mm)	No.	Diameter of the cable entry (Ø mm)					References
			4.3-8.1	3-6.5	5-9.2	8-12.5	9.6-15.9	
Rectangular connector-free entries	112 x 36	14	-	6	4	-	-	NSY TSA2414SE
Rectangular connector-free entries	112 x 36	17	-	-	17	-	-	NSY TSA2417SE
Rectangular connector-free entries	112 x 36	22	-	16	4	2	-	NSY TSA2422SE
Rectangular connector-free entries	112 x 36	23	23	-	-	-	-	NSY TSA2423SE
Rectangular connector-free entries	112 x 36	29	-	29	-	-	-	NSY TSA2429SE

Multi-CS

- Material: Reinforced polypropylene and TPE, halogen-free
- Color: Black
- Cable entry material: Soft membrane
- Cable glands to be fitted: No
- Installation options:
 - On cable gland plate adapter or directly on enclosure
- Flexibility of the installation: Full
- Reversibility: Full
- Ingress protection rating: IP55 according to IEC 60529
- Cable retention: Medium
- Cable diameter (mm): Up to 22
- Cable Installation time: Fast
- Quantity of cables to be fitted for a given surface: +++
- Cable entries for cables with connectors: Yes
- Cut-out dimensions (mm): 112 x 36
- External dimensions (mm): 148 x 58 x 15; 148 x 58 x 18
- Certificates: UL recognized (UR)
- Temperature range: -30 °C to +100 °C

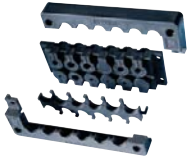

NSYDCD2412

Characteristics	References
Modular entry allowing the passing of up to 48 pre-assembled cables	NSYDCD2412
Modular entry allowing the passing of up to 48 pre-assembled cables	NSYDCD244
Modular entry allowing the passing of up to 48 pre-assembled cables	NSYDCD248
Modular entry allowing the passing of up to 48 pre-assembled cables	NSYDCD249

Multi-T

- Material: TPE
- Color: RAL 7035 grey
- Cable entry material: Soft membrane
- Cable glands to be fitted: No
- Installation options:
 - On cable gland plate adapter or directly on enclosure
- Flexibility of the installation: Medium
- Reversibility: Medium
- Ingress protection rating: IP66 according to IEC 60529 (IP65 for **NSYAECFLBP**)
- Cable retention: Low
- Cable diameter (mm): From 5 to 60
- Cable Installation time: Fast
- Quantity of cables to be fitted for a given surface: ++
- Cable entries for cables with connectors: No
- Cut-out dimensions (mm): 214 x 90 (FL21)
- External dimensions (mm): 214 x 88
- Flame resistance: 650 °C
- Temperature range: -40 °C to +100 °C



NSYAECFLT25

Characteristics	Diameter of the cable entry (Ø mm)												References
	No.	5-7	6-10	8-12	8-16	10-14	12-18	14-20	17-32	20-26	24-54	30-60	
metal plate	0	-	-	-	-	-	-	-	-	-	-	-	NSYAECFLBP
FL21 membranes	7	-	-	-	4	-	-	-	-	-	2	1	NSYAECFLT7
FL21 membranes	27	4	-	4	-	13	-	4	-	2	-	-	NSYAECFLT25
FL21 membranes	37	-	4	14	-	16	2	-	1	-	-	-	NSYAECFLT35

PrismaSeT

- Material: Insulated material
- Color: RAL 9003
- Cable entry material: Soft membrane
- Cable glands to be fitted: No
- Installation options:
 - On cable gland plate adapter or directly on enclosure
- Flexibility of the installation: Medium
- Reversibility: Medium

- Ingress protection rating: IP55 according to IEC 60529
- Cable retention: Low
- Cable diameter (mm): From 28 to 60 (FL21), From 7 to 72 (rectangular)
- Cable Installation time: Fast
- Quantity of cables to be fitted for a given surface: ++
- Cable entries for cables with connectors: No
- Cut-out dimensions (mm): 214 x 90 (FL21)
- External dimensions (mm): 216 x 84

PrismaSeT, plain

- Solid cable gland plates



08881

Characteristics	Type	References
PrismaSeT	FL21	LVS08881

PrismaSeT, pre-drilled

- Suitable for receiving cable glands with metric pitch

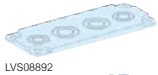

LVS08892

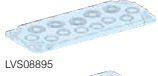

LVS08895

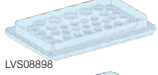

LVS08898

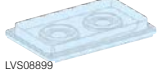

LVS08899

Characteristics	Type	References
Pre-drilled, 2 x M20 or M32 + 2 x M25 or M40	FL21	LVS08892
Pre-drilled, 5 x M16 or M25 + 8 x M20	FL21	LVS08895
Pre-drilled, 39 x Ø 7 - 26 mm	opening 225 x 137 mm	LVS08898
Pre-drilled, 2 x Ø 33 - 72 mm	opening 225 x 137 mm	LVS08899

PrismaSeT, membrane

- Membrane to be drilled according to the required diameter

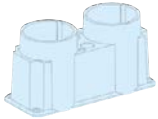

LVS08897

Characteristics	Type	References
Membrane, 2 x Ø 28 - 60 mm	FL21	LVS08897

Multi-F

- Type FL13 or FL21
- Pop-out membranes only
- Pop-out membranes or cable gland installation
- Knock-out system
- Material: Fiberglass-reinforced polypropylene and TPE - halogen-free
- Color: RAL 7035 grey
- Cable entry material: Soft membrane
- Cable glands to be fitted: No
- Installation options:
 - On cable gland plate adapter or directly on enclosure
- Flexibility of the installation: Medium
- Reversibility: Medium
- Ingress protection rating: IP65 according to IEC 60529
- Cable retention: Low
- Cable diameter (mm): From 16 to 50
- Cable Installation time: Fast
- Quantity of cables to be fitted for a given surface: ++
- Cable entries for cables with connectors: No
- Cut-out dimensions (mm): 134 x 52 (FL13); 214 x 90 (FL21)
- External dimensions (mm): From 134 x 52 to 214 x 90
- Test standard EN 60529:1991 + A1; EN 60670-1:2005, EN 50262:1998 EMKO-TUI (03-SEC) FI001/84; Semko report 816003; UL-approved materials
- Temperature range: -20 °C to +125 °C (Pop-out membranes only)

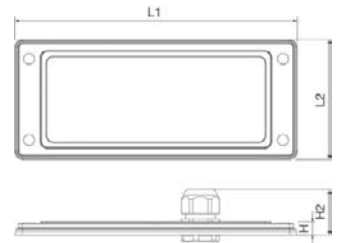

NSYAECPKFL11

Characteristics	Dimensions (mm)				Diameter of the cable entry (Ø mm)						References
	L1	L2	H	H2	No.	4-10	M16 (5-10)	M20 (6-13)	M25 (8-17)	M32, M40 oder M50	
MMulti-F FL13	134	52	6.5	35	11	10	-	1	-	-	NSYAECPKFL11
Multi-F	214	90	9	35	7	-	2	2	2	1	NSYAECPKFL7A
Multi-F	214	90	9	35	10	-	4	2	4	-	NSYAECPKFL10

Multi-CF

- Material: Reinforced polypropylene and TPE, halogen-free
- Color: Black
- Cable entry material: Soft membrane
- Cable glands to be fitted: No
- Installation options:
 - On cable gland plate adapter or directly on enclosure
- Flexibility of the installation: Full
- Reversibility: Full
- Ingress protection rating: IP65 according to IEC 60529
- Cable retention: Medium
- Cable diameter (mm): From 9 to 30
- Cable Installation time: Fast
- Quantity of cables to be fitted for a given surface: +++
- Cable entries for cables with connectors: Yes
- Cut-out dimensions (mm): 112 x 36
- External dimensions (mm): 148 x 60 x 10
- Temperature range: -30 °C to +70 °C



NSYTLK2414

Characteristics	References
Cable entry for protected cables	NSYTLK2414
Cable entry for protected cables	NSYTLK2422
Cable entry for protected cables	NSYTLK2428
Cable entry for protected cables	NSYTLK2446
Cable entry for protected cables	NSYTLK24M

Multi-CR

- Material: Polyamide
- Cable entry material: Hard-plastic
- Cable glands to be fitted: Yes
- Installation options:
 - On cable gland plate adapter or directly on enclosure
- Flexibility of the installation: Low
- Reversibility: Medium
- Ingress protection rating: IP54 according to IEC 60529
- Cable retention: High (with fastener)
- Cable diameter (mm): From 3 to 31
- Cable Installation time: Slow
- Quantity of cables to be fitted for a given surface: ++
- Cable entries for cables with connectors: Yes
- Cut-out dimensions (mm):
 - 36 x 91 (**NSYDCE168**); 36 x 112 (**NSYDCE24***)
- External dimensions (mm): 146 x 58
- Flame resistance: 650 °C
- Temperature range: -40 °C to +80 °C
- UL recognized (UR)

Supply:
1 die and fixing elements



NSYDCE168



NSYDCE244



NSYDCE2410

Characteristics	Height (mm)	Width (mm)	Depth (mm)	Connector cut-out type	Number of cable entries	References
Cable entries with dies for cables equipped with connectors.	14	146	58	16	8	NSYDCE168
Cable entries with dies for cables equipped with connectors.	14	146	58	24	4	NSYDCE244
Cable entries with dies for cables equipped with connectors.	14	146	58	24	10	NSYDCE2410

Multi-H

- Material: Fiberglass-reinforced polycarbonate
- Color: RAL 7035 grey
- Cable entry material: Hard-plastic
- Cable glands to be fitted: Yes
- Installation options:
 - On cable gland plate adapter or directly on enclosure
- Flexibility of the installation: Low
- Reversibility: Medium
- Ingress protection rating: IP65 according to IEC 60529
- Cable retention: High (with cable clamp)
- Cable diameter (mm): From 12 to 25
- Cable Installation time: Slow
- Quantity of cables to be fitted for a given surface: ++
- Cable entries for cables with connectors: No
- Cut-out dimensions (mm): 214 x 90 (FL21)
- External dimensions (mm): 215 x 85
- Flame resistance: 750 °C
- Temperature range: For normal operation: -40 °C to +80 °C; For a short time: -40 °C to +120 °C



NSYSAKFL

Characteristics	Height (mm)	Width (mm)	Depth (mm)	Diameter of the cable entry (Ø mm)				References
				No.	M12	M12 or M20	M16 oder M25	
FL21 insulated flange with ISO knock-outs	10	215	85	12	4	4	4	NSYSAKFL

Simple-1

- Mixed membrane entries for enclosure thickness 20/10° - 32/10° mm.
- Material: SBS
- Color: RAL 7035 grey or RAL 9010 white
- Cable entry material: Soft membrane
- Cable glands to be fitted: Not applicable
- Installation options: On cable gland plate or directly on enclosure
- Flexibility of the installation: Low
- Reversibility: Medium
- Ingress protection rating: IP55 according to IEC 60529
- Cable retention: Low
- Cable diameter (mm): From 20 to 40
- Cable Installation time: Fast
- Quantity of cables to be fitted for a given surface: +
- Cable entries for cables with connectors: No
- Cut-out dimensions (mm): Various circular hole diameters according to cable diameter
- External dimensions (mm): From Ø 23 to 44
- Flame resistance: 750 °C

Supply:
Minor packaging of 10 pieces



ISM71074

Characteristics	Drill hole Ø (mm)	Cable / conduit Ø (mm)	References
Mixed membrane entries for IP55 direct cable entries, RAL 9010	23	4 - 20	IMT36172
Mixed membrane entries for IP55 direct cable entries, RAL 9010	29	4 - 25	IMT36173
Mixed membrane entries for IP55 direct cable entries, RAL 7035	23	4 - 20	ISM71071
Mixed membrane entries for IP55 direct cable entries, RAL 7035	29	4 - 25	ISM71072
Mixed membrane entries for IP55 direct cable entries, RAL 7035	36	4 - 32	ISM71073
Mixed membrane entries for IP55 direct cable entries, RAL 7035	44	4 - 40	ISM71074

Simple-2

- PVC adjustable cone-shaped entries for enclosure thickness 30/10° - 32/10° mm.
- Material: PVC
- Cable entry material: Soft membrane
- Cable glands to be fitted: Not applicable
- Installation options: On cable gland plate or directly on enclosure
- Flexibility of the installation: Low
- Reversibility: Medium
- Ingress protection rating: IP55 according to IEC 60529
- Cable retention: Low
- Cable diameter (mm): From 5 to 87
- Cable Installation time Fast
- Quantity of cables to be fitted for a given surface: +
- Cable entries for cables with connectors: No
- Cut-out dimensions (mm): Various circular hole diameters according to cable diameter
- External dimensions (mm): From Ø 25 to 98

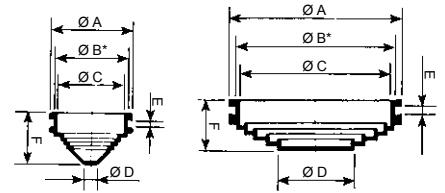

Supply:
NSYECPC3 50 cable entries, **NSYECPC5** and **NSYECPC6** each 25 cable entries, **NSYECPC9** and **NSYECPC15** each 10 cable entries



NSYECPC15

Characteristics	Dimensions (mm)						Capacity		References
	Ø A	Ø B	Ø C	Ø D	E	F	Cable (Ø mm)	Tube	
PVC adjustable cone-shaped entries	25	21.5	18	5	3.2	13	5-18	PG 9-11	NSYECPC3
PVC adjustable cone-shaped entries	33	29.5	26	5	3.2	20	5-26	PG 9-16	NSYECPC5
PVC adjustable cone-shaped entries	43	38.5	36	5	3.2	22	5-36	PG 9-21	NSYECPC6
PVC adjustable cone-shaped entries	70	63	60	28	3	20	28-60	PG 21-48	NSYECPC9
PVC adjustable cone-shaped entries	98	90	87	28	3	23	28-87	PG 21-48	NSYECPC15

Simple-3

- Quick cable entries for enclosure thickness 10/10° - 40/10° mm (5/10° - 20/10° mm for ref. **IMT36179**).
- Material: EPDM plastic
- Color: Grey cable entries: NCS 5500; Black cable entries: NCS 9000
- Cable entry material: Combined
- Cable glands to be fitted: Not applicable
- Installation options: On cable gland plate or directly on enclosure
- Flexibility of the installation: Low
- Reversibility: Medium
- Ingress protection rating: IP67 according to IEC 60529
- Cable retention: Medium
- Cable diameter (mm): From 12 to 50
- Cable Installation time: Fast
- Quantity of cables to be fitted for a given surface: +
- Cable entries for cables with connectors: No
- Cut-out dimensions (mm):
Various circular hole diameters according to cable diameter
- External dimensions (mm): From Ø 12.5 to 50.7
- Flame resistance: 750 °C

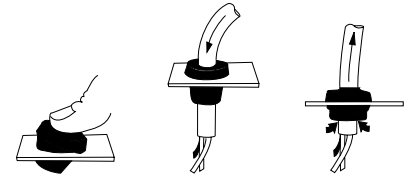

Supply:
50 (M12 to M32)
25 (M40 and M50)



IMT36179

Characteristics	Dimensions			References
	ISO	Drill hole (Ø mm)	Cable (Ø mm)	
Quick cable entries	M12	12.5	3 - 5	IMT36179
Quick cable entries	M16	16	5 - 7	IMT36180
Quick cable entries	M20	20.3	7 - 10	IMT36181
Quick cable entries	M25	25.3	10 - 14	IMT36182
Quick cable entries	M32	32.4	14 - 20	IMT36183
Quick cable entries	M40	40.7	20 - 26	IMT36184
Quick cable entries	M50	50.7	26 - 35	IMT36185

PVC adjustable cone-shaped entries

- PVC adjustable cone-shaped entries for PG tubes or for enclosure thickness 12/10° - 15/10° mm.
- Material: PVC
- Color: Black
- Cable entry material: Combined
- Cable glands to be fitted: Not applicable
- Installation options:
On cable gland plate or directly on enclosure
- Flexibility of the installation: Low
- Reversibility: Medium
- Ingress protection rating: IP55 according to IEC 60529
- Cable retention: Low
- Cable diameter (mm): From 16 to 44
- Cable Installation time: Fast
- Quantity of cables to be fitted for a given surface: +
- Cable entries for cables with connectors: No
- Cut-out dimensions (mm):
Various circular hole diameters according to cable diameter
- External dimensions (mm): From Ø 25 to 52

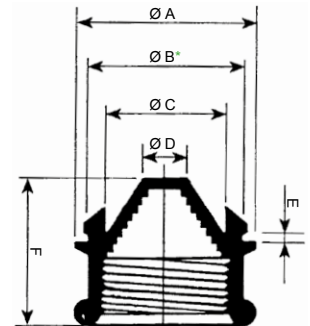

Supply:
25 cable entries



NSYEC7

Characteristics	Dimensions (mm)						Capacity		References
	Ø A	Ø B	Ø C	Ø D	E	F	Cable (Ø mm)	Tube	
PVC adjustable cone-shaped entries	52	48.5	44	13	1.5	30	13 to 44	PG 36	NSYEC7

Simple-5

- ISO cable gland.
- Material: PA6 Polyamide, neoprene gasket
- Color: RAL 7035 grey
- Cable entry material: Combined
- Installation options: On cable gland plate or directly on enclosure
- Flexibility of the installation: Low
- Reversibility: Medium
- Ingress protection rating: IP68
- Cable retention: High
- Cable diameter (mm): From 12 to 40
- Cable Installation time: Slow
- Quantity of cables to be fitted for a given surface: +
- Cable entries for cables with connectors: No
- Cut-out dimensions (mm): Various circular hole diameters according to cable diameter
- External dimensions (mm): From Ø 15 to 46
- Certificate: VDE, UL Recognized (UR)
- Flame resistance: 750 °C

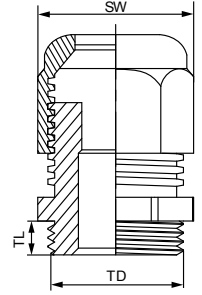

Supply:

The cable glands are supplied with nuts
Pack of 20 (M12 to M20), of 10 (M25 and M32), of 5 (M40)



ISM71503

Characteristics	Dimensions					References
	Cable (Ø mm)	Drill hole (Ø mm)	TD	TL	SW	
Cable gland	3 / 6.5	12.2 (0 + 0.2)	12	6	15	ISM71501
Cable gland	4 / 8	16.2 (0 + 0.2)	16	8	19	ISM71502
Cable gland	6 / 12	20.2 (0 + 0.2)	20	10	24	ISM71503
Cable gland with high resistance to fire	6 / 12	20.2 (0 + 0.2)	20	10	24	IMT36150
Cable gland	11 / 17	25.2 (0 + 0.2)	25	8	29	ISM71504
Cable gland	15 / 21	32.2 (0 + 0.3)	32	10	36	ISM71505
Cable gland	19 / 28	40.5 (0 + 0.3)	40	10	46	ISM71506

Synthetic snap-in cable gland

- Without thread.
- Easy assembly and disassembly.
- Suitable for walls from 0.5 to 4 mm thick.
- Material: PA6 Polyamide, neoprene gasket
- Color: RAL 7035 grey, RAL 7001, RAL 9005.
Other colors on demand
- Cable entry material: Non-armoured
- Installation options:
On cable gland plate or directly on enclosure
- Flexibility of the installation: Low
- Reversibility: Medium
- Ingress protection rating: IP66
- Cable retention: High
- Cable diameter (mm): From 16 to 40
- Cable Installation time: Slow
- Quantity of cables to be fitted for a given surface: +
- Cable entries for cables with connectors: No
- Thread type: Metric EN 60423
Other types are available on demand
- Cut-out dimensions (mm):
Various circular hole diameters according to cable diameter
- External dimensions (mm): From Ø 22 to 46
- Certificates: UR (cURus) Type 4x except for the size M40
- Standard: DIN EN 62444, UL 514B, UL 514B§8.26.7
- Temperature range: -20 °C to + 100 °C

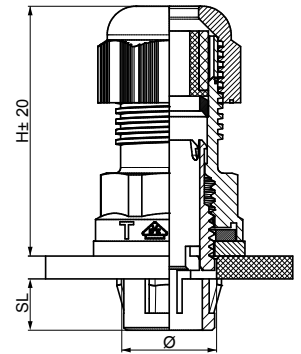

Supply:

The cable glands are supplied with nuts
Pack of 20 (M16 and M20), of 10 (M25 and M32), of 5 (M40)



NSYCGSP16

Characteristics	Dimensions						References	
	Ø	Ø min / max	Drill Ø	SL	SD	H		
Synthetic snap-in cable gland	M16	5/10	16.2 to 16.4	9	15.9	42.5	22	NSYCGSP16
Synthetic snap-in cable gland	M20	6/12	20.2 to 20.4	9	19.9	41.5	24	NSYCGSP20
Synthetic snap-in cable gland	M25	11/17	25.2 to 25.4	9	24.9	43.5	29	NSYCGSP25
Synthetic snap-in cable gland	M32	15/21	32.2 to 32.4	9	31.9	49.5	36	NSYCGSP32
Synthetic snap-in cable gland	M40	19/28	40.2 to 40.4	11.5	39.9	56	46	NSYCGSP40

Snap-in cable gland disassembling tool

- Material: Plastic



NSYDT16



NSYDT20

Characteristics	Ø	References
Tool to quickly disassemble cable gland	M16	NSYDT16
Tool to quickly disassemble cable gland	M20	NSYDT20
Tool to quickly disassemble cable gland	M25	NSYDT25
Tool to quickly disassemble cable gland	M32	NSYDT32
Tool to quickly disassemble cable gland	M40	NSYDT40

Stainless-steel cable gland with lamellar insert

- Lamellar technology provides excellent resistance to traction as well as excellent torsional protection. For aggressive environments.
- Material: Stainless-steel AISI 304L or AISI 316L, neoprene gasket
- Cable entry material: Non armoured
- Installation options:
 - On cable gland plate or directly on enclosure
- Flexibility of the installation: Low
- Reversibility: Medium
- Ingress protection rating: IP68
- Cable retention: High
- Cable diameter (mm): From 12 to 40
- Cable Installation time: Slow
- Quantity of cables to be fitted for a given surface: +
- Cable entries for cables with connectors: No
- Thread type: Metric EN 60423
- Cut-out dimensions (mm):
 - Various circular hole diameters according to cable diameter
- External dimensions (mm): From Ø 14 to 43
- Certificates: UL recognized (cURus). Rated Type 4, 4X according UL50E
- Standard: DIN EN 62444, UL 514
- Temperature range: -20 °C to + 100 °C



Supply:

The cable glands are supplied with nuts
Pack of 5 (M12 and M16), of 4 (M20 and M25), of 2 (M32 and M40)



NSYCGX12

Characteristics	Dimensions							References
	Ø	Ø min-max mm	Thread Length TL mm	SW Cap mm	SW Body mm	Outer Ø D mm	max. Height H mm	
AISI 304L	M12x1.5	3.0 - 6.5	6	14	14	15.5	24	NSYCGX12
AISI 304L	M16x1.5	4.0 - 8.0	7	17	19	21	25.5	NSYCGX16
AISI 304L	M20x1.5	10.0 - 14.0	8	24	24	26.5	30	NSYCGX20
AISI 304L	M25x1.5	10.0 - 14.0	8	24	27	30	30	NSYCGX25
AISI 304L	M32x1.5	13.0 - 18.0	9	30	36	39.8	35	NSYCGX32
AISI 304L	M40x1.5	18.0 - 25.0	9	41	46	51.4	40.5	NSYCGX40
AISI 316L	M12x1.5	3.0 - 6.5	6	14	14	15.5	24	NSYCGX12H
AISI 316L	M16x1.5	4.0 - 8.0	7	17	19	21	25.5	NSYCGX16H
AISI 316L	M20x1.5	10.0 - 14.0	8	24	24	26.5	30	NSYCGX20H
AISI 316L	M25x1.5	10.0 - 14.0	8	24	27	30	30	NSYCGX25H
AISI 316L	M32x1.5	13.0 - 18.0	9	30	36	39.8	35	NSYCGX32H
AISI 316L	M40x1.5	18.0 - 25.0	9	41	46	51.4	40.5	NSYCGX40H

Single-door enclosure

Double-door enclosure

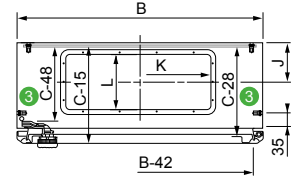
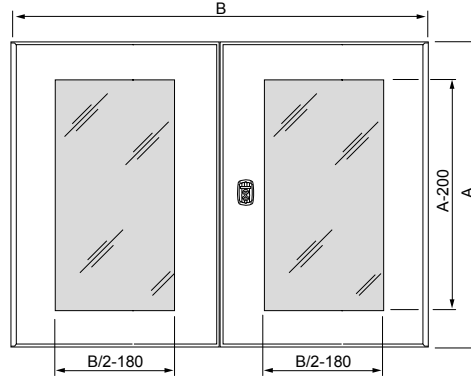
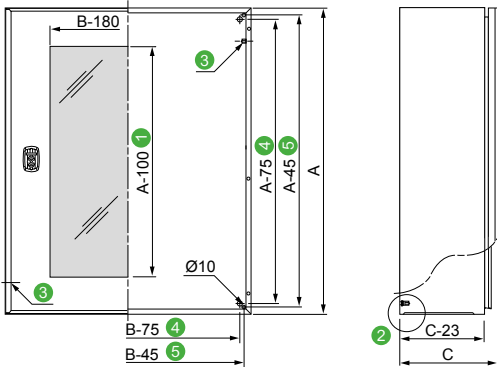

A: Enclosure height
B: Enclosure width
C: Enclosure depth

- 1 A-200 from the height of 800 mm.
- 2 4 or 6 (widths 1000 - 1200 mm) M8 x 25 mm backstuds.
- 3 2 M6 x 17.5 mm earthing studs
- 4 Stud center-to-center distance.
- 5 Center-to-center distance of the holes for direct fixing.

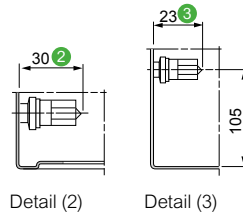

Comment:

The DXF diagrams can be downloaded from our websites.

Enclosure		Cable gland plate						
Width (mm)	Depth (mm)	Dim. (mm)	Type	No.	J	K	L	References
200 - 250	150 - 250	140 x 80	A	1	57	115	55	NSYTLA
300 - 400	150	245 x 80	B	1	57	220	55	NSYTLB
300	200	245 x 130	C	1	80	220	105	NSYTLC
400	200 - 250	345 x 130	D	1	80	320	105	NSYTLD
500	200 - 250	445 x 130	E	1	80	420	105	NSYTLE
600	200 - 250	545 x 130	F	1	80	520	105	NSYTLF
600	300 - 400	495 x 220	G	1	126*	470	195	NSYTLG
800	250 - 300 - 400	345 x 130	D	2	95**	320	105	2 x NSYTLD
1000 - 1200	300 - 400	445 x 130	E	2	95	420	105	2 x NSYTLE

* Except enclosure 1000 x 600 x 400 mm, J = 140 mm.

** Except enclosure 600 x 800 x 300 mm, J = 80 mm.

Perforated rails on plain door*

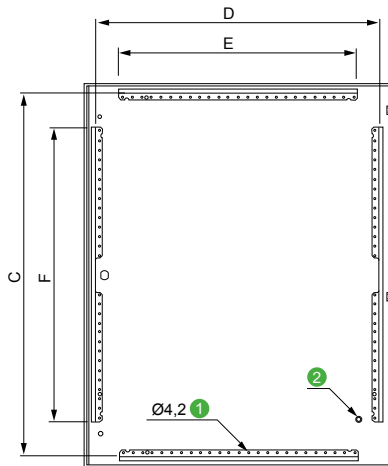

- 1 Perforations with 25 mm spacing
- 2 1 M6 x 17.5 mm earthing stud.

* The glazed doors are equipped with a vertical cable guide on the hinge side.

Enclosure**		Perforated rails on the door				Perforated rails on the double-door				Perforated rails on the internal door			
Height (mm)	Width (mm)	Vertical (mm)		Horizontal (mm)		Vertical (mm)		Horizontal (mm)		Vertical (mm)		Horizontal (mm)	
		F	D	E	C	F	D	E	C	F	D	E	C
400	300	320	237	-	-	-	-	-	-	-	-	-	-
400	400	320	337	-	-	-	-	-	-	-	-	-	-
400	600	320	537	-	-	-	-	-	-	-	-	-	-
500	300	370	237	-	-	-	-	-	-	-	-	-	-
500	400	370	337	-	-	-	-	-	-	-	-	-	-
500	500	370	437	-	-	-	-	-	-	-	-	-	-
600	400	370	337	-	-	-	-	-	-	-	-	-	-
600	500	370	437	-	-	-	-	-	-	-	-	-	-
600	600	370	537	-	-	-	-	-	-	-	-	-	-
600	800	370	737	-	-	-	-	-	-	-	-	-	-
700	500	470	437	-	-	-	-	-	-	-	-	-	-
800	600	570	537	-	-	-	-	-	-	-	-	-	-
800	800	570	737	620	749	-	-	-	-	-	-	-	-
800	1000	570	937	820	749	570	437	320	749	620	437	320	749
800	1200	-	-	-	-	570	537	420	749	620	537	420	749
1000	600	770	537	420	949	-	-	-	-	-	-	-	-
1000	800	770	737	620	949	-	-	-	-	-	-	-	-
1000	1000	770	937	820	949	770	437	320	949	820	437	320	949
1000	1200	-	-	-	-	770	537	420	949	820	537	420	949
1200	600	970	537	420	1149	-	-	-	-	-	-	-	-
1200	800	970	737	620	1149	-	-	-	-	-	-	-	-
1200	1000	970	937	820	1149	970	437	320	1149	1020	437	320	1149
1200	1200	-	-	-	-	970	537	420	1149	1020	537	420	1149
1400	1000	-	-	-	-	970	437	320	1349	1020	437	320	1349

** The doors of enclosures with dimensions of less than 800 x 600 mm do not have horizontal cable guides.



Download the configuration sheets and DXF diagrams from www.se.com
Send them back to your local Schneider Electric office.
Take advantage of a shorter delivery time!

Installation of 2 mounting plates in the enclosures with width of 1000 or 1200 mm and depth of 300 or 400 mm

Step slides, [page 263](#).



1 On the 6 backstuds

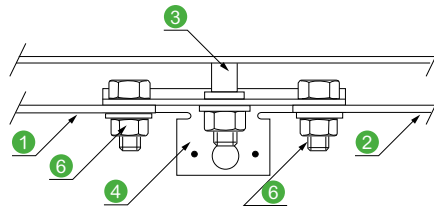

2 Two offset mounting plates with depthwise adjustment

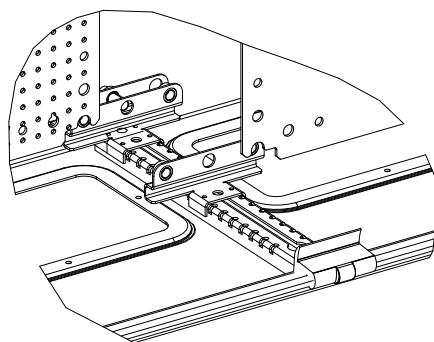
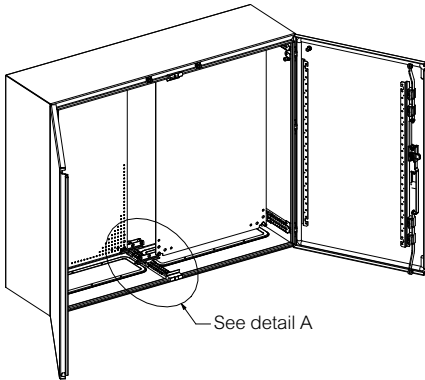
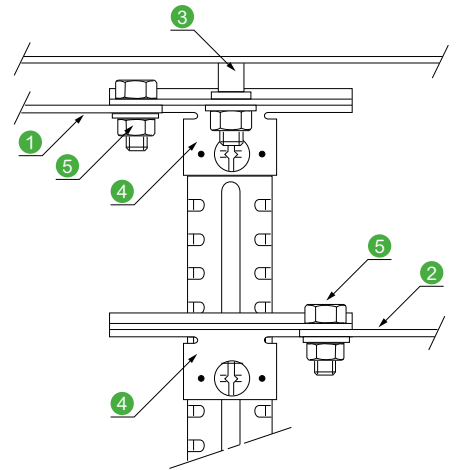

Detail A

- 1 Left mounting plate
- 2 Right mounting plate
- 3 Central backstud
- 4 Bracket ref. **NSYCRNGSDR** with 2 M8 x 20 mm screws
- 5 M8 x 20 mm screw

Installation of Telequick mounting plates

Spacers for raising the mounting plate in the enclosures equipped with 6 studs.

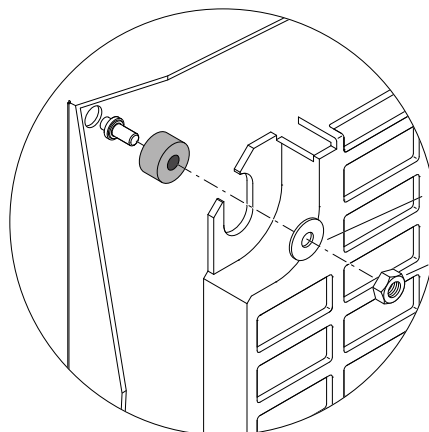
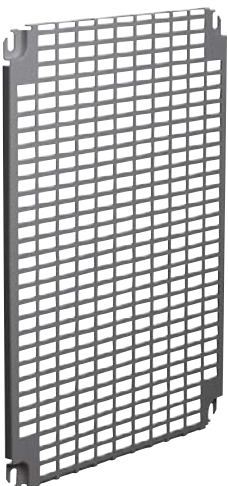

Reference **NSYEMR**

Acceptable loads on the mounting plates, bases and doors



Spacial 3D wall-mounted enclosures

Acceptable loads (kg)					References
On plain mounting plates	On base	On door *	On vertical lug	On horizontal lug	
60	135	50	350	190	NSYS3D3215 to NSYS3D5320
90	135	50	350	190	NSYS3D5420 to NSYS3D6425
135	135	50	350	190	NSYS3D6620 to NSYS3D8630
150	135	50	350	190	NSYS3D10625 to NSYS3D10830
180	135	50	350	190	NSYS3D101030D to NSYS3D141030D

* On a sheet door with a thickness of 20/10° mm: 60 kg of maximum acceptable load (please consult us).

Areas without cut-outs

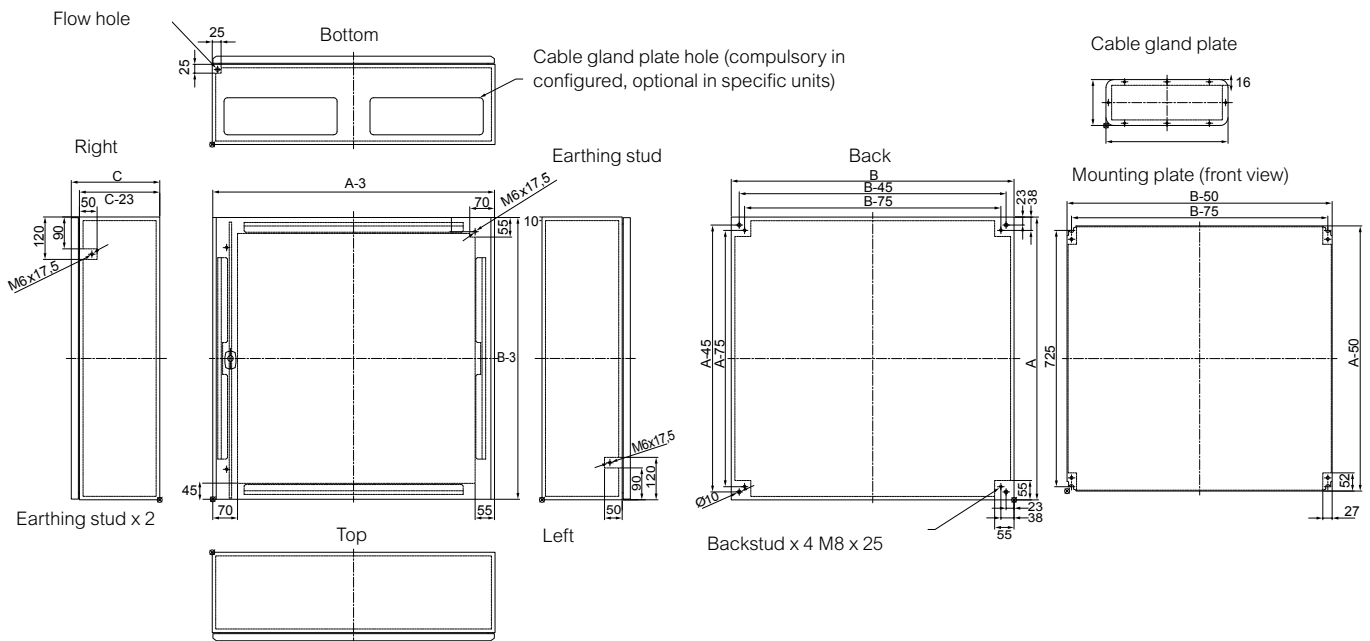

- For 800, 1000 and 1200 mm widths, 2 cable gland plates: See previous page.
- Vertical cable guides from 400 mm height.
- Horizontal cable guides from 800 mm width.
- Download our DXF diagrams from our websites.

EMC protection

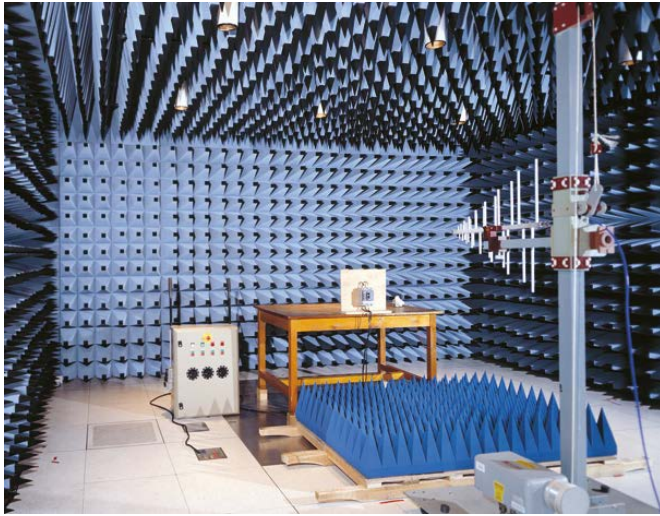

Standard Spacial S3D enclosures are tested against electromagnetic interference. Since the enclosure is tested empty, it is advisable to rerun the tests with the enclosure completely equipped in its final configuration.

Earth braids to be ordered separately, see [page 323](#).

Another solution and information on electromagnetic compatibility: Spacial S3HF enclosure, [page 492](#).

Attenuation curve of the Spacial S3D compared with the Spacial S3HF

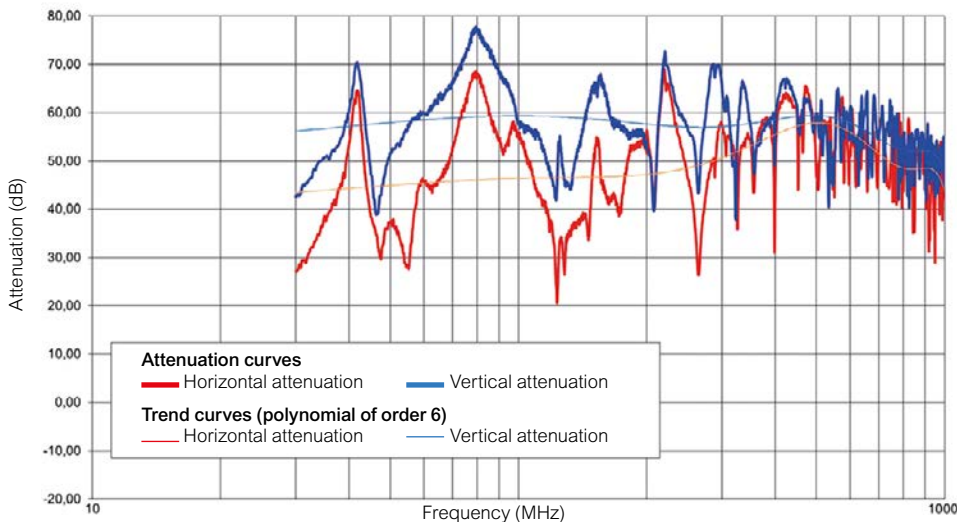

Frequency: 3 - 13.2 Hz
 Amplitude: 1 mm/sec below 22 Hz
 Frequency: 3 - 100 Hz
 Acceleration: 0.7 g above 30 Hz

Vibration constraints

Specific construction of the Spacial S3D - single-piece body (cross-shaped structure). The rear is flat without added parts - this allows it to comply with certain vibration constraints. The tests were conducted according to the "rules for ships" by "Det Norske Veritas". Enclosures labelled "DNV" have undergone these tests and obtained classification "A". Since the enclosure is tested empty, it is advisable to rerun the tests with the enclosure completely equipped in its final configuration.

Seismic constraint

The seismic behavior of the the wall-mounted enclosure Spacial S3D has been qualified according to MRI spectra "big material" specified in the standard IEC 60068-2-6 and IEC 60068-2-57 (see [page 450](#) for more details).

Tested enclosure configuration:

- Plain door,
- Plain mounting plate with a load of 250 kg/m² uniformly distributed on the mounting plate,
- Fixing to the wall with M8 screws (tightening torque: 12 Nm ± 1 Nm).

Level of the seismic behavior obtained:

- 2.5G for enclosure with the following dimensions:
 height ≥ 700 mm, height = 600 mm and width ≥ 600 mm
- 3G for other dimensions.

ATEX compliance

The Spacial S3D enclosure (with adaptation) is ATEX-certified by the LCIE.

Environmental properties

Compliance with RoHS standard.



Post fixing device for Spacial steel enclosure

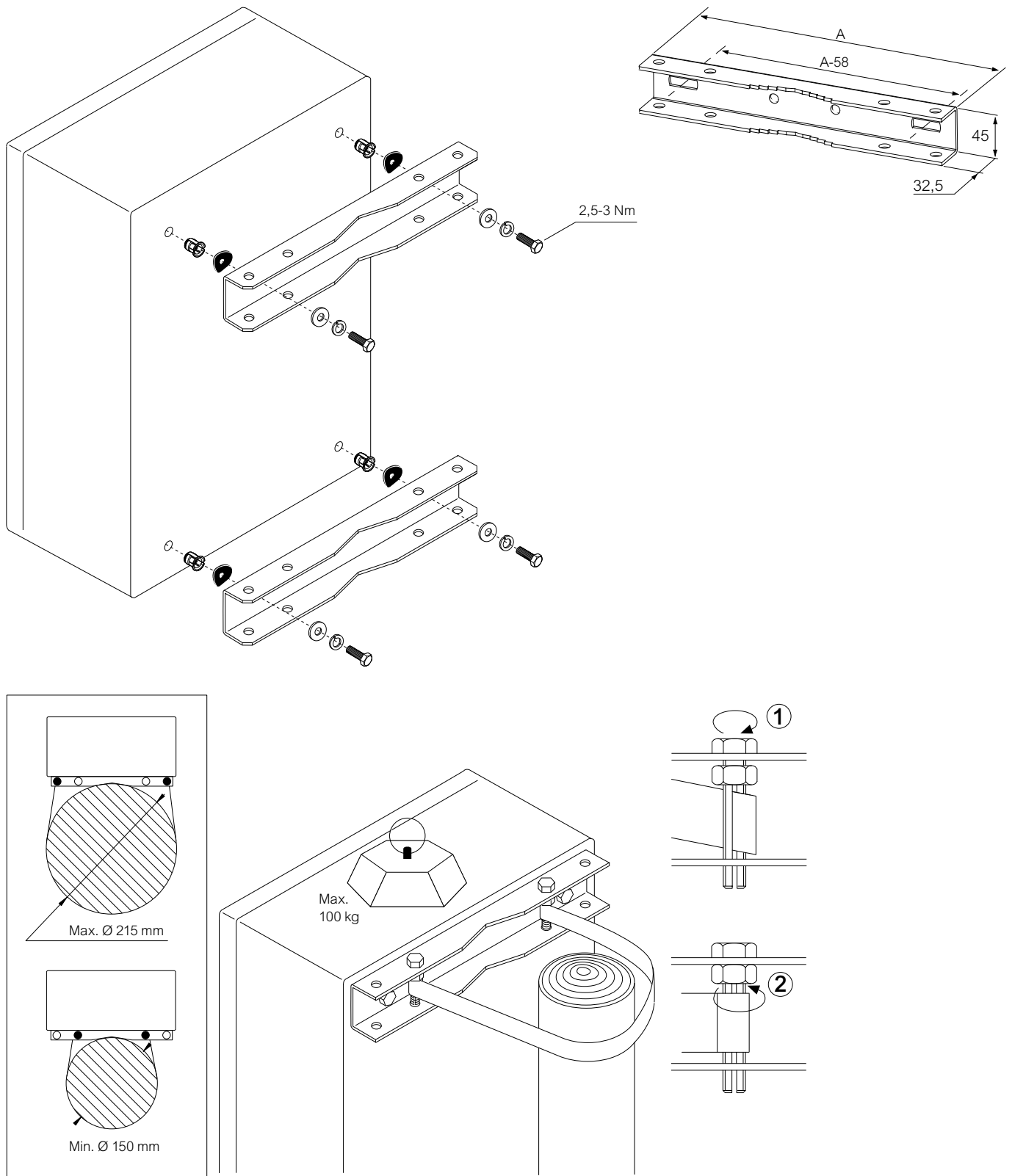

Mounting rail



Quick-fixing cross-rails

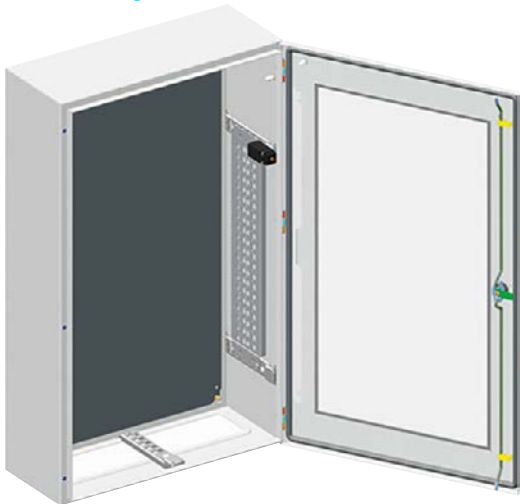

Ease of installation



Door switch mounting option

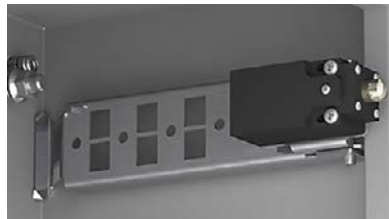

With DIN rail

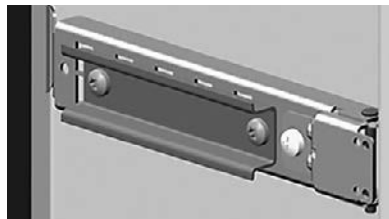

With light cross-rails and cage nut

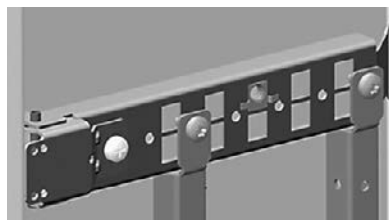

Standard cable gland plate

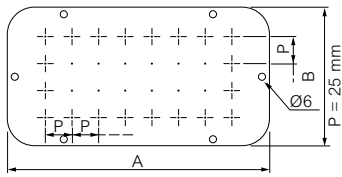

Width (A)	Depth (B)	Standard References	Aluminum References
140	80	NSYTLA	NSYTLAU
245	80	NSYTLB	NSYTLBU
245	130	NSYTLC	NSYTLCU
345	130	NSYTLD	NSYTLDU
445	130	NSYTLE	NSYTLEU
545	130	NSYTLF	NSYTLFU
495	220	NSYTLG	NSYTLGU
345	130	2x NSYTLD	2x NSYTLDU
445	130	2x NSYTLE	2x NSYTLEU

Cable gland plates with FL-type cut-out for cable gland membranes

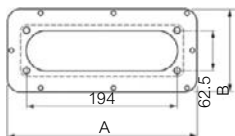

NSYTLBFL, NSYTLCFL, NSYTLDFL,
NSYTLEFL, NSYTLFFL, NSYTLGBFL

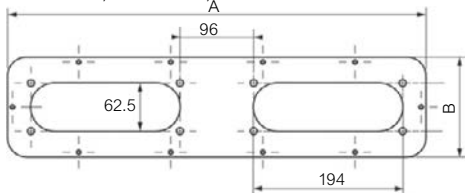

NSYTLBFL, NSYTLG2FL

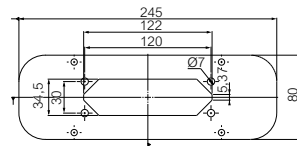

NSYTLBFL

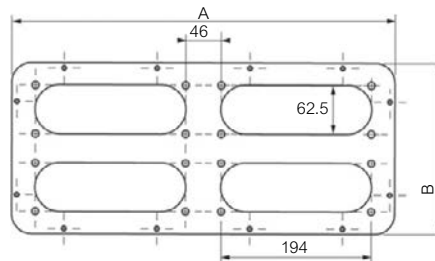

NSYTLBFL

Width (A)	Depth (B)	References
140	80	NSYTLAFL
245	80	NSYTLBFL
245	130	NSYTLCFL
345	130	NSYTLDFL
445	130	NSYTLEFL
545	130	NSYTLFFL
545	130	NSYTLF2FL
495	220	NSYTLGFL
495	220	NSYTLG2FL
495	220	NSYTLG4FL
345	130	2x NSYTLDFL
445	130	2x NSYTLEFL

Internal door

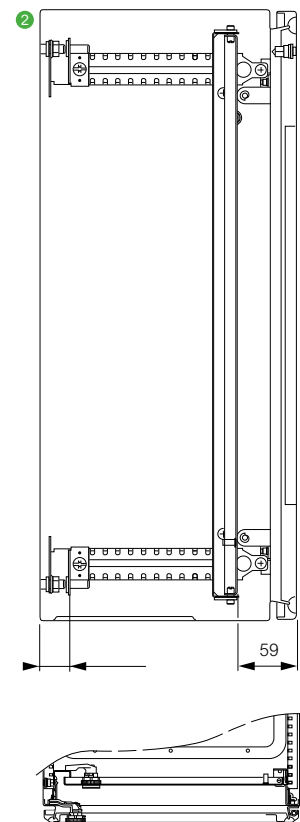
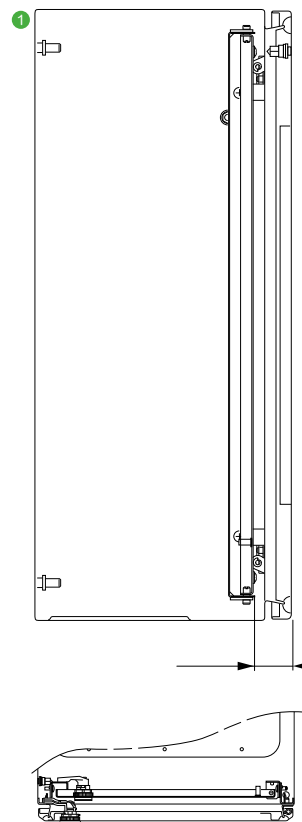
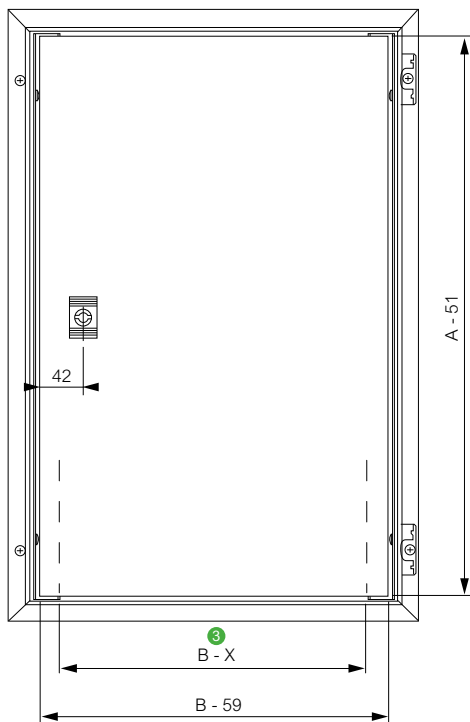

- 1 Installation on the front of the enclosure or
- 2 Installation on step slides
- 3 Dimension resulting from installation on step slides: B-83 mm.
Dimension resulting from direct installation (without step slides): B-91 mm

Technical changes reserved. Information provided without guarantee. Images are for illustrative purposes only.

Steel Floor-Standing Enclosures

3

Compact enclosures Spacial SM



Suitable enclosures Spacial SF - Assembled supply



Spacial SM-SF

Introduction	110
Characteristics	112
Selection guide	114
Accessories	120
Dimensions	146

Multi-purpose IP55 compact steel enclosure for fast and simple solutions.

This range can be configured according to your needs

4 different services available:

- 

Assemble to order
- 

Mounting of standard accessories
- 

Painting
- 

Machining



Robust

- Body made as a single piece with welded rear panel.
- Front part forming a rigid frame with welded corners.



Protection

- IP guaranteed by the rigidity of the enclosure, the expanded-polyurethane sealing gasket of the enclosure and the subsequent welding.
- Double-door enclosures with inner lock on the left door.



Practical

- Height-adjustable door rails suitable for cable fixing.
- Can be installed with adapter profile in the front and rear of the enclosure, the universal 40-mm cross-rail (1 row) in the rear provides the same fixing points as the modular enclosure.



Comfort

- Handle with sturdy design for easily activating the locking system, allowing the installation of any shape insert and any cylindrical combination key.
- Easily interchangeable insert with one click.

See page 546 for details or consult our web site www.se.com

Adapts to all your needs. Delivered assembled for a ready-to-use solution.

SF



Adapts to customer needs. Delivered as kit, with up to 600 possible configurations.

SF kit

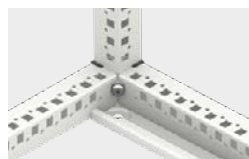

Robust

- Structure formed from a single 15/10° mm galvanized steel section with high rigidity.
- Vertical uprights screwed together with connections of full steel. Placement and screwing of the 4 vertical uprights at the corners of the top and bottom frames. Fixing by 8 screws, one at each corner of the enclosure.
- Capable of withstanding 1000 kg distributed in its volume.



Fast

- The double system of cut-outs on the structure allows most accessories to be installed using self-tapping TORX T30 M6 screws or nuts.
- Clip-on quick-fixing cross-rails, fixed with self-tapping screws.
- Door is installed by inserting the captive pins of the hinge into their housing in the door.

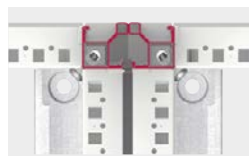

Reliable

- The design of the profile creates a double protective barrier against the entry of water and dust when coupling two enclosures.
- The first barrier is the metal connection of the sections, and the second barrier is the EPDM gasket that helps guarantee the sealing.



Practical

- Suspension of the rear panel using a self-centering piece to facilitate screwing.

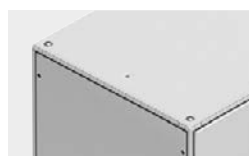

Aesthetics

- The built-in panels and handle with new design give the enclosure a new appearance.

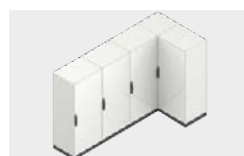

Simple

The new design allows enclosures to be coupled in any direction, adapting to all installation surfaces.

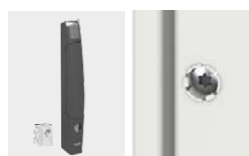

Comfort

- Handle with robust design for easily activating the locking system, allowing the installation of inserts of any shape and any cylindrical combination key.
- Panels with captive screws for easier assembly and dismantling.



Accessible

The symmetric design of the profile allows doors to be installed on any side of the enclosure, opening right or left, providing full accessibility to the enclosure.



Characteristics	Compact enclosures Spacial SM
	<ul style="list-style-type: none"> • Compact body with a front rigid frame with welded corners and rear panel supports installed in depth to adjust and fix the equipment with a pitch of 25 mm
Basic composition	<ul style="list-style-type: none"> • The double doors are overlapping, with system for fixing the left door • Door reversible, 120° opening • Welded rear panel • System with 4 locking points with handle and 5-mm double-bar insert • Cable gland plate 1 entry • Mounting plate support brackets
Versions / Configurations	<ul style="list-style-type: none"> • Compact enclosure with plain door and mounting plate • Compact enclosure with plain door and without mounting plate • Compact enclosure with transparent Securit® glass door and without mounting plate
Protection of personnel	Earthing accessories needed to ensure the grounding continuity, page 323
Material	Steel
Finish	Structured finish, epoxy polyester powder
Color	RAL 7035 grey
Ingress protection rating	IP55 according to IEC 60529
Mechanical protection rating	IK10 for plain door and IK08 for transparent door according to IEC 62262
Standards	Compliance with enclosure standard IEC 62208 and the RoHS and REACH directive
Certifications	BVM, UL (cULus), Rating according UL50E : single-door enclosures : Types 1, 2, 3R, 5 and 13. double-door enclosures Types 1, 12
Installation	* Compliant with IEC 62208 regarding type tests specified in §9.12 (resistance to UV radiation) and §9.13 (resistance to corrosion) Canopy needed to avoid water stagnation on the upper part of the enclosure, page 135
Maximum load	500 kg
Options	<ul style="list-style-type: none"> • Plinths, heights 100 mm and 200 mm, page 126 • Lifting eyebolts, page 134 • Internal door, page 139 • Door accessories, page 141 • Other locking options, page 144 • Mounting plates and Telequick system, page 265



SF



SF_{kit}

Suitable enclosures Spacial SF - supplied assembled

- Structure made up of vertical uprights joined with top and bottom frames
- Panels and doors built into the structure
- Formed from a single section and perforated structure with a pitch of 25 mm
- Front door with a reinforcement frame (horizontal rails height-adjustable)
- The double doors are overlapping, with system for fixing the left door
- Door reversible, 120° opening
- Rear panel screwed on with captive screws
- Removable roof
- System with 4 locking points with handle and 5-mm double-bar insert
- Mounting plate support brackets (for widths from 600 mm)
- Mounting plate sliding rails (for widths from 600 mm)
- 2 quick-fixing cross-rails (for heights from 1800 mm, widths from 600 mm and depths from 500 mm)

- Modular enclosure with plain door and mounting plate
- Modular enclosure with plain door and without mounting plate
- Modular enclosure with transparent Securit® glass door and without mounting plate

Suitable enclosures Spacial SF - supplied as kit

- Front door with a reinforcement frame (horizontal rails height-adjustable)
- The double doors are overlapping, with system for fixing the left door
- Door reversible, 120° opening
- Rear panel to be screwed on with captive screws
- Removable roof delivered with top frame
- System with 4 locking points with handle and 5-mm double-bar insert
- Mounting plate support brackets delivered with top and bottom frames kit (for widths from 600 mm)
- Mounting plate sliding rails delivered with top and bottom frames kit (for widths from 600 mm)
- 2 quick-fixing cross-rails delivered with top and bottom frames kit (for frames with widths from 600 mm and depths from 500 mm)

- Uprights kit
- Top and bottom frames kit
- Rear panel kit
- Door kit (plain or transparent)

Earthing accessories needed to ensure the grounding continuity

Steel

Structured finish, epoxy polyester powder

RAL 7035 grey

IP55 according to IEC 60529 (with side panels and cable entry plates)

IK10 for plain door and IK08 for transparent door according to IEC 62262

Compliance with enclosure standard IEC 62208 and the RoHS and REACH directive

BV, BVM, DNV, UL (cULus) Rating according UL50E : Types 1, 3R, 12

1000 kg

- Side panels options, [page 122](#)
- Enclosure suites options, [page 123](#)
- Plinths, heights 100 mm and 200 mm, [page 124](#)
- Cable gland plates, [page 130](#)
- Lifting systems, [page 134](#)
- Roof options, [page 136](#)
- Door accessories, [page 141](#)
- Other locking options, [page 144](#)
- Mounting plates and Telequick system, [page 265](#)



- Side panels options, [page 122](#)
- Enclosure suites options, [page 123](#)
- Plinths, heights 100 mm and 200 mm, [page 124](#)
- Cable gland plates, [page 130](#)
- Lifting systems, [page 134](#)
- Roof options, [page 136](#)
- Other locking options, [page 144](#)
- Mounting plates and Telequick system, [page 265](#)

Dimensions			Doors	Enclosures			Plinth (H 100 mm)	
Height (mm)	Width (mm)	Depth (mm)		Plain door, without mounting plate	Plain door, with mounting plate	Transparent door, without mounting plate	Front kit (corners + front panels)	Side panels, 2 u.
1200	800	300	1	NSYSM12830	NSYSM12830P	-	NSYSPPF8100	NSYSPPS3100
1200	1000	300	2	NSYSM1210302D	NSYSM1210302DP	-	NSYSPPF10100	NSYSPPS3100
1200	1200	400	2	NSYSM1212402D	NSYSM1212402DP	-	NSYSPPF12100	NSYSPPS4100
1400	600	300	1	NSYSM14630	NSYSM14630P	-	NSYSPPF6100	NSYSPPS3100
1400	600	400	1	NSYSM14640	NSYSM14640P	-	NSYSPPF6100	NSYSPPS4100
1400	800	300	1	NSYSM14830	NSYSM14830P	-	NSYSPPF8100	NSYSPPS3100
1400	800	400	1	NSYSM14840	NSYSM14840P	NSYSM14840T	NSYSPPF8100	NSYSPPS4100
1400	1000	400	2	NSYSM1410402D	NSYSM1410402DP	-	NSYSPPF10100	NSYSPPS4100
1400	1200	400	2	NSYSM1412402D	NSYSM1412402DP	-	NSYSPPF12100	NSYSPPS4100
1600	600	300	1	NSYSM16630	NSYSM16630P	-	NSYSPPF6100	NSYSPPS3100
1600	600	400	1	NSYSM16640	NSYSM16640P	NSYSM16640T	NSYSPPF6100	NSYSPPS4100
1600	800	300	1	NSYSM16830	NSYSM16830P	NSYSM16830T	NSYSPPF8100	NSYSPPS3100
1600	800	400	1	NSYSM16840	NSYSM16840P	NSYSM16840T	NSYSPPF8100	NSYSPPS4100
1600	1000	300	2	NSYSM1610302D	NSYSM1610302DP	-	NSYSPPF10100	NSYSPPS3100
1600	1000	400	2	NSYSM1610402D	NSYSM1610402DP	-	NSYSPPF10100	NSYSPPS4100
1600	1200	300	2	NSYSM1612302D	NSYSM1612302DP	-	NSYSPPF12100	NSYSPPS3100
1600	1200	400	2	NSYSM1612402D	NSYSM1612402DP	-	NSYSPPF12100	NSYSPPS4100
1800	600	300	1	NSYSM18630	NSYSM18630P	-	NSYSPPF6100	NSYSPPS3100
1800	600	400	1	NSYSM18640	NSYSM18640P	NSYSM18640T	NSYSPPF6100	NSYSPPS4100
1800	600	500	1	NSYSM18650	NSYSM18650P	-	NSYSPPF6100	NSYSPPS5100
1800	800	300	1	NSYSM18830	NSYSM18830P	NSYSM18830T	NSYSPPF8100	NSYSPPS3100
1800	800	400	1	NSYSM18840	NSYSM18840P	NSYSM18840T	NSYSPPF8100	NSYSPPS4100
1800	800	500	1	NSYSM18850	NSYSM18850P	NSYSM18850T	NSYSPPF8100	NSYSPPS5100
1800	800	600	1	NSYSM18860	NSYSM18860P	-	NSYSPPF8100	NSYSPPS6100
1800	1000	400	1	NSYSM181040	NSYSM181040P	-	NSYSPPF10100	NSYSPPS4100
1800	1000	400	2	NSYSM1810402D	NSYSM1810402DP	-	NSYSPPF10100	NSYSPPS4100
1800	1000	500	2	NSYSM1810502D	NSYSM1810502DP	-	NSYSPPF10100	NSYSPPS5100
1800	1200	400	2	NSYSM1812402D	NSYSM1812402DP	-	NSYSPPF12100	NSYSPPS4100
1800	1200	500	2	NSYSM1812502D	NSYSM1812502DP	-	NSYSPPF12100	NSYSPPS5100
1800	1600	400	2	NSYSM1816402D	NSYSM1816402DP	-	NSYSPPF16100	NSYSPPS4100
1800	1600	500	2	NSYSM1816502D	NSYSM1816502DP	-	NSYSPPF16100	NSYSPPS5100
2000	600	300	1	NSYSM20630	NSYSM20630P	-	NSYSPPF6100	NSYSPPS3100
2000	600	400	1	NSYSM20640	NSYSM20640P	NSYSM20640T	NSYSPPF6100	NSYSPPS4100
2000	600	500	1	NSYSM20650	NSYSM20650P	-	NSYSPPF6100	NSYSPPS5100
2000	800	300	1	NSYSM20830	NSYSM20830P	NSYSM20830T	NSYSPPF8100	NSYSPPS3100
2000	800	400	1	NSYSM20840	NSYSM20840P	NSYSM20840T	NSYSPPF8100	NSYSPPS4100
2000	800	500	1	NSYSM20850	NSYSM20850P	NSYSM20850T	NSYSPPF8100	NSYSPPS5100
2000	800	600	1	NSYSM20860	NSYSM20860P	NSYSM20860T	NSYSPPF8100	NSYSPPS6100
2000	1000	400	2	NSYSM2010402D	NSYSM2010402DP	-	NSYSPPF10100	NSYSPPS4100
2000	1000	500	2	NSYSM2010502D	NSYSM2010502DP	-	NSYSPPF10100	NSYSPPS5100
2000	1200	400	2	NSYSM2012402D	NSYSM2012402DP	-	NSYSPPF12100	NSYSPPS4100
2000	1200	500	2	NSYSM2012502D	NSYSM2012502DP	-	NSYSPPF12100	NSYSPPS5100
2000	1200	600	2	NSYSM2012602D	NSYSM2012602DP	-	NSYSPPF12100	NSYSPPS6100
2000	1600	400	2	NSYSM2016402D	NSYSM2016402DP	-	NSYSPPF16100	NSYSPPS4100
2000	1600	500	2	NSYSM2016502D	NSYSM2016502DP	-	NSYSPPF16100	NSYSPPS5100
2000	1600	600	2	NSYSM2016602D	NSYSM2016602DP	-	NSYSPPF16100	NSYSPPS6100

Technical changes reserved. Information provided without guarantee. Images are for illustrative purposes only.

Plinth (H 200 mm)		Inner door	Mounting plate	Vertical uprights		19" swing rack		Dimensions		
Front kit (corners + front panels)	Side panels, 4 u.	Plain door	Galvanized	Standard	Technical	Off-center	Centered	Height (mm)	Width (mm)	Depth (mm)
NSYSPF8200	NSYSPS3200	-	NSYMP128	-	NSYTVR12	-	-	1200	800	300
NSYSPF10200	NSYSPS3200	-	NSYMP1210	-	NSYTVR12	-	-	1200	1000	300
NSYSPF12200	NSYSPS4200	-	NSYMP1212	-	NSYTVR12	-	-	1200	1200	400
NSYSPF6200	NSYSPS3200	-	NSYMP146	-	NSYTVR14	-	-	1400	600	300
NSYSPF6200	NSYSPS4200	-	NSYMP146	-	NSYTVR14	-	-	1400	600	400
NSYSPF8200	NSYSPS3200	-	NSYMP148	-	NSYTVR14	NSYRSW27	NSYRWC27	1400	800	300
NSYSPF8200	NSYSPS4200	-	NSYMP148	-	NSYTVR14	NSYRSW27	NSYRWC27	1400	800	400
NSYSPF10200	NSYSPS4200	-	NSYMP1410	-	NSYTVR14	-	-	1400	1000	400
NSYSPF12200	NSYSPS4200	-	NSYMP1412	-	NSYTVR14	-	-	1400	1200	400
NSYSPF6200	NSYSPS3200	NSYID166	NSYMP166	-	NSYTVR16	-	-	1600	600	300
NSYSPF6200	NSYSPS4200	NSYID166	NSYMP166	-	NSYTVR16	-	-	1600	600	400
NSYSPF8200	NSYSPS3200	NSYID168	NSYMP168	-	NSYTVR16	NSYRSW31	NSYRWC31	1600	800	300
NSYSPF8200	NSYSPS4200	NSYID168	NSYMP168	-	NSYTVR16	NSYRSW31	NSYRWC31	1600	800	400
NSYSPF10200	NSYSPS3200	-	NSYMP1610	-	NSYTVR16	-	-	1600	1000	300
NSYSPF10200	NSYSPS4200	-	NSYMP1610	-	NSYTVR16	-	-	1600	1000	400
NSYSPF12200	NSYSPS3200	-	NSYMP1612	-	NSYTVR16	-	-	1600	1200	300
NSYSPF12200	NSYSPS4200	-	NSYMP1612	-	NSYTVR16	-	-	1600	1200	400
NSYSPF6200	NSYSPS3200	NSYID186	NSYMP186	NSYVR18	NSYTVR18	-	-	1800	600	300
NSYSPF6200	NSYSPS4200	NSYID186	NSYMP186	NSYVR18	NSYTVR18	-	-	1800	600	400
NSYSPF6200	NSYSPS5200	NSYID186	NSYMP186	NSYVR18	NSYTVR18	-	-	1800	600	500
NSYSPF8200	NSYSPS3200	NSYID188	NSYMP188	NSYVR18	NSYTVR18	NSYRSW36	NSYRWC36	1800	800	300
NSYSPF8200	NSYSPS4200	NSYID188	NSYMP188	NSYVR18	NSYTVR18	NSYRSW36	NSYRWC36	1800	800	400
NSYSPF8200	NSYSPS5200	NSYID188	NSYMP188	NSYVR18	NSYTVR18	NSYRSW36	NSYRWC36	1800	800	500
NSYSPF8200	NSYSPS6200	NSYID188	NSYMP188	NSYVR18	NSYTVR18	NSYRSW36	NSYRWC36	1800	800	600
NSYSPF10200	NSYSPS4200	NSYID1810	NSYMP1810	NSYVR18	NSYTVR18	-	-	1800	1000	400
NSYSPF10200	NSYSPS4200	NSYID1810	NSYMP1810	NSYVR18	NSYTVR18	-	-	1800	1000	400
NSYSPF10200	NSYSPS5200	NSYID1810	NSYMP1810	NSYVR18	NSYTVR18	-	-	1800	1000	500
NSYSPF12200	NSYSPS4200	-	NSYMP1812	NSYVR18	NSYTVR18	-	-	1800	1200	400
NSYSPF12200	NSYSPS5200	-	NSYMP1812	NSYVR18	NSYTVR18	-	-	1800	1200	500
NSYSPF16200	NSYSPS4200	-	NSYMP1816	NSYVR18	NSYTVR18	-	-	1800	1600	400
NSYSPF16200	NSYSPS5200	-	NSYMP1816	NSYVR18	NSYTVR18	-	-	1800	1600	500
NSYSPF6200	NSYSPS3200	NSYID206	NSYMP206	NSYVR20	NSYTVR20	-	-	2000	600	300
NSYSPF6200	NSYSPS4200	NSYID206	NSYMP206	NSYVR20	NSYTVR20	-	-	2000	600	400
NSYSPF6200	NSYSPS5200	NSYID206	NSYMP206	NSYVR20	NSYTVR20	-	-	2000	600	500
NSYSPF8200	NSYSPS3200	NSYID208	NSYMP208	NSYVR20	NSYTVR20	NSYRSW40	NSYRWC40	2000	800	300
NSYSPF8200	NSYSPS4200	NSYID208	NSYMP208	NSYVR20	NSYTVR20	NSYRSW40	NSYRWC40	2000	800	400
NSYSPF8200	NSYSPS5200	NSYID208	NSYMP208	NSYVR20	NSYTVR20	NSYRSW40	NSYRWC40	2000	800	500
NSYSPF8200	NSYSPS6200	NSYID208	NSYMP208	NSYVR20	NSYTVR20	NSYRSW40	NSYRWC40	2000	800	600
NSYSPF10200	NSYSPS4200	NSYID2010	NSYMP2010	NSYVR20	NSYTVR20	-	-	2000	1000	400
NSYSPF10200	NSYSPS5200	NSYID2010	NSYMP2010	NSYVR20	NSYTVR20	-	-	2000	1000	500
NSYSPF12200	NSYSPS4200	-	NSYMP2012	NSYVR20	NSYTVR20	-	-	2000	1200	400
NSYSPF12200	NSYSPS5200	-	NSYMP2012	NSYVR20	NSYTVR20	-	-	2000	1200	500
NSYSPF12200	NSYSPS6200	-	NSYMP2012	NSYVR20	NSYTVR20	-	-	2000	1200	600
NSYSPF16200	NSYSPS4200	-	NSYMP2016	NSYVR20	NSYTVR20	-	-	2000	1600	400
NSYSPF16200	NSYSPS5200	-	NSYMP2016	NSYVR20	NSYTVR20	-	-	2000	1600	500
NSYSPF16200	NSYSPS6200	-	NSYMP2016	NSYVR20	NSYTVR20	-	-	2000	1600	600

Technical changes reserved. Information provided without guarantee. Images are for illustrative purposes only.

Dimensions			Enclosures				Side panels	Cable entry plates		
(A) Height (mm)	(B) Width (mm)	(C) Depth (mm)	Doors							
				Plain door, without mounting plate	Plain door, with mounting plate	Transparent door, without mounting plate	Plain	Plain	1 entry	2 entries
1200	600	400	1	NSYSF12640	NSYSF12640P	-	NSY2SP124	NSYEC64	NSYEC641	-
1200	600	600	1	NSYSF12660	NSYSF12660P	-	NSY2SP126	NSYEC66	NSYEC661	NSYEC662
1200	800	400	1	NSYSF12840	NSYSF12840P	-	NSY2SP124	NSYEC84	NSYEC841	-
1200	800	600	1	NSYSF12860	NSYSF12860P	-	NSY2SP126	NSYEC86	NSYEC861	NSYEC862
1400	600	400	1	NSYSF14640	NSYSF14640P	-	NSY2SP144	NSYEC64	NSYEC641	-
1400	800	400	1	NSYSF14840	NSYSF14840P	-	NSY2SP144	NSYEC84	NSYEC841	-
1600	600	600	1	NSYSF16660	NSYSF16660P	-	NSY2SP166	NSYEC66	NSYEC661	NSYEC662
1600	600	800	1	NSYSF16680	NSYSF16680P	-	NSY2SP168	NSYEC68	NSYEC681	NSYEC682
1600	800	600	1	NSYSF16860	NSYSF16860P	-	NSY2SP166	NSYEC86	NSYEC861	NSYEC862
1600	800	800	1	NSYSF16880	NSYSF16880P	-	NSY2SP168	NSYEC88	NSYEC881	NSYEC882
1800	400	400	1	NSYSF18440	-	-	NSY2SP184	NSYEC44	NSYEC441	-
1800	400	500	1	NSYSF18450	-	-	NSY2SP185	NSYEC45	NSYEC451	-
1800	400	600	1	NSYSF18460	-	-	NSY2SP186	-	NSYEC461	NSYEC462
1800	600	400	1	NSYSF18640	NSYSF18640P	NSYSF18640T	NSY2SP184	NSYEC64	NSYEC641	-
1800	600	500	1	NSYSF18650	NSYSF18650P	NSYSF18650T	NSY2SP185	NSYEC65	NSYEC651	-
1800	600	600	1	NSYSF18660	NSYSF18660P	-	NSY2SP186	NSYEC66	NSYEC661	NSYEC662
1800	600	800	1	-	-	NSYSF18680T	NSY2SP188	NSYEC68	NSYEC681	NSYEC682
1800	800	400	1	NSYSF18840	NSYSF18840P	NSYSF18840T	NSY2SP184	NSYEC84	NSYEC841	-
1800	800	500	1	NSYSF18850	NSYSF18850P	NSYSF18850T	NSY2SP185	NSYEC85	NSYEC851	-
1800	800	600	1	NSYSF18860	NSYSF18860P	NSYSF18860T	NSY2SP186	NSYEC86	NSYEC861	NSYEC862
1800	800	600	2	NSYSF188602D	NSYSF188602DP	-	NSY2SP186	NSYEC86	NSYEC861	NSYEC862
1800	1000	400	1	NSYSF181040	NSYSF181040P	-	NSY2SP184	NSYEC104	NSYEC1041	-
1800	1000	400	2	NSYSF1810402D	NSYSF1810402DP	-	NSY2SP184	NSYEC104	NSYEC1041	-
1800	1000	500	1	NSYSF181050	NSYSF181050P	-	NSY2SP185	NSYEC105	NSYEC1051	-
1800	1000	600	1	NSYSF181060	NSYSF181060P	-	NSY2SP186	NSYEC106	NSYEC1061	NSYEC1062
1800	1000	600	2	NSYSF1810602D	NSYSF1810602DP	-	NSY2SP186	NSYEC106	NSYEC1061	NSYEC1062
1800	1200	400	2	NSYSF1812402D	NSYSF1812402DP	-	NSY2SP184	NSYEC124	NSYEC1241	-
1800	1200	500	2	NSYSF1812502D	NSYSF1812502DP	-	NSY2SP185	NSYEC125	NSYEC1251	-
1800	1200	600	2	NSYSF1812602D	NSYSF1812602DP	-	NSY2SP186	NSYEC126	NSYEC1261	NSYEC1262
2000	300	500	1	NSYSF20350	-	-	NSY2SP205	NSYEC35	NSYEC351	-
2000	300	600	1	NSYSF20360	-	-	NSY2SP206	NSYEC36	NSYEC361	-
2000	300	800	1	NSYSF20380	-	-	NSY2SP208	-	NSYEC381	-
2000	400	400	1	NSYSF20440	-	-	NSY2SP204	NSYEC44	NSYEC441	-
2000	400	500	1	NSYSF20450	-	-	NSY2SP205	NSYEC45	NSYEC451	-
2000	400	600	1	NSYSF20460	-	-	NSY2SP206	NSYEC64	NSYEC461	NSYEC462
2000	400	800	1	NSYSF20480	-	-	NSY2SP208	NSYEC84	NSYEC481	NSYEC482
2000	600	400	1	NSYSF20640	NSYSF20640P	NSYSF20640T	NSY2SP204	NSYEC64	NSYEC641	-
2000	600	500	1	NSYSF20650	NSYSF20650P	NSYSF20650T	NSY2SP205	NSYEC65	NSYEC651	-
2000	600	600	1	NSYSF20660	NSYSF20660P	-	NSY2SP206	NSYEC66	NSYEC661	NSYEC662
2000	600	800	1	NSYSF20680	NSYSF20680P	-	NSY2SP208	NSYEC68	NSYEC681	NSYEC682
2000	800	400	1	NSYSF20840	NSYSF20840P	NSYSF20840T	NSY2SP204	NSYEC84	NSYEC841	-
2000	800	500	1	NSYSF20850	NSYSF20850P	NSYSF20850T	NSY2SP205	NSYEC85	NSYEC851	-
2000	800	600	1	NSYSF20860	NSYSF20860P	NSYSF20860T	NSY2SP206	NSYEC86	NSYEC861	NSYEC862
2000	800	600	2	NSYSF208602D	NSYSF208602DP	-	NSY2SP206	NSYEC86	NSYEC861	NSYEC862
2000	800	800	1	NSYSF20880	NSYSF20880P	NSYSF20880T	NSY2SP208	NSYEC88	NSYEC881	NSYEC882
2000	1000	400	1	NSYSF201040	NSYSF201040P	NSYSF201040T	NSY2SP204	NSYEC104	NSYEC1041	-
2000	1000	400	2	NSYSF2010402D	NSYSF2010402DP	-	NSY2SP204	NSYEC104	NSYEC1041	-
2000	1000	500	1	NSYSF201050	NSYSF201050P	NSYSF201050T	NSY2SP205	NSYEC105	NSYEC1051	-
2000	1000	500	2	NSYSF2010502D	NSYSF2010502DP	-	NSY2SP205	NSYEC105	NSYEC1051	-
2000	1000	600	1	NSYSF201060	NSYSF201060P	NSYSF201060T	NSY2SP206	NSYEC106	NSYEC1061	NSYEC1062
2000	1000	600	2	NSYSF2010602D	NSYSF2010602DP	-	NSY2SP206	NSYEC106	NSYEC1061	NSYEC1062
2000	1000	800	1	NSYSF201080	NSYSF201080P	-	NSY2SP208	NSYEC108	NSYEC1081	NSYEC1082
2000	1200	400	2	NSYSF2012402D	NSYSF2012402DP	-	NSY2SP204	NSYEC124	NSYEC1241	-
2000	1200	500	2	NSYSF2012502D	NSYSF2012502DP	-	NSY2SP205	NSYEC125	NSYEC1251	-
2000	1200	600	2	NSYSF2012602D	NSYSF2012602DP	-	NSY2SP206	NSYEC126	NSYEC1261	NSYEC1262
2000	1200	800	2	NSYSF2012802D	NSYSF2012802DP	-	NSY2SP208	NSYEC128	NSYEC1281	NSYEC1282
2000	1600	400	2	NSYSF2016402D	NSYSF2016402DP	-	NSY2SP204	NSYEC164	NSYEC1641	-
2000	1600	500	2	NSYSF2016502D	NSYSF2016502DP	-	NSY2SP205	NSYEC165	NSYEC1651	-
2000	1600	600	2	NSYSF2016602D	NSYSF2016602DP	-	NSY2SP206	NSYEC166	NSYEC1661	NSYEC1662
2200	400	600	1	NSYSF22460	-	-	NSY2SP226	-	NSYEC461	-
2200	600	600	1	NSYSF22660	NSYSF22660P	-	NSY2SP226	NSYEC66	NSYEC661	NSYEC662
2200	600	800	1	NSYSF22680	NSYSF22680P	-	NSY2SP228	NSYEC68	NSYEC681	NSYEC682
2200	800	600	1	NSYSF22860	NSYSF22860P	-	NSY2SP226	NSYEC86	NSYEC861	NSYEC862
2200	800	800	1	NSYSF22880	NSYSF22880P	NSYSF22880T	NSY2SP228	NSYEC88	NSYEC881	NSYEC882
2200	1000	600	1	NSYSF221060	NSYSF221060P	-	NSY2SP226	NSYEC106	NSYEC1061	NSYEC1062
2200	1200	600	2	NSYSF2212602D	NSYSF2212602DP	-	NSY2SP226	NSYEC126	NSYEC1261	NSYEC1262
2200	1200	800	2	NSYSF2212802D	NSYSF2212802DP	-	NSY2SP228	NSYEC128	NSYEC1281	NSYEC1282

Technical changes reserved. Information provided without guarantee. Images are for illustrative purposes only.

Plinths (H 100 mm)		Plinths (H 200 mm)		Mounting plates		Vertical uprights		Dimensions		
								(A)	(B)	(C)
Front kit (corners + front panels)	Side panels, 2 u.	Front kit (corners + front panels)	Side panels, 4 u.	Mounting plate	Intermediate mounting plate	Standard	Technical	Height (mm)	Width (mm)	Depth (mm)
NSYSPF6100	NSYSPS4100	NSYSPF6200	NSYSPS4200	NSYMP126	NSYSIMP12	-	NSYTVR12	1200	600	400
NSYSPF6100	NSYSPS6100	NSYSPF6200	NSYSPS6200	NSYMP126	NSYSIMP12	-	NSYTVR12	1200	600	600
NSYSPF8100	NSYSPS4100	NSYSPF8200	NSYSPS4200	NSYMP128	NSYSIMP12	-	NSYTVR12	1200	800	400
NSYSPF8100	NSYSPS6100	NSYSPF8200	NSYSPS6200	NSYMP128	NSYSIMP12	-	NSYTVR12	1200	800	600
NSYSPF6100	NSYSPS4100	NSYSPF6200	NSYSPS4200	NSYMP146	NSYSIMP14	-	NSYTVR14	1400	600	400
NSYSPF8100	NSYSPS4100	NSYSPF8200	NSYSPS4200	NSYMP148	NSYSIMP14	-	NSYTVR14	1400	800	400
NSYSPF6100	NSYSPS6100	NSYSPF6200	NSYSPS6200	NSYMP166	NSYSIMP16	-	NSYTVR16	1600	600	600
NSYSPF6100	NSYSPS8100	NSYSPF6200	NSYSPS8200	NSYMP166	NSYSIMP16	-	NSYTVR16	1600	600	800
NSYSPF8100	NSYSPS6100	NSYSPF8200	NSYSPS6200	NSYMP168	NSYSIMP16	-	NSYTVR16	1600	800	600
NSYSPF8100	NSYSPS8100	NSYSPF8200	NSYSPS8200	NSYMP168	NSYSIMP16	-	NSYTVR16	1600	800	800
NSYSPF4100	NSYSPS4100	NSYSPF4200	NSYSPS4200	NSYMP184	NSYSIMP18	NSYVR18	NSYTVR18	1800	400	400
NSYSPF4100	NSYSPS5100	NSYSPF4200	NSYSPS5200	NSYMP184	NSYSIMP18	NSYVR18	NSYTVR18	1800	400	500
NSYSPF4100	NSYSPS6100	NSYSPF4200	NSYSPS6200	NSYMP184	NSYSIMP18	NSYVR18	NSYTVR18	1800	400	600
NSYSPF6100	NSYSPS4100	NSYSPF6200	NSYSPS4200	NSYMP186	NSYSIMP18	NSYVR18	NSYTVR18	1800	600	400
NSYSPF6100	NSYSPS5100	NSYSPF6200	NSYSPS5200	NSYMP186	NSYSIMP18	NSYVR18	NSYTVR18	1800	600	500
NSYSPF6100	NSYSPS6100	NSYSPF6200	NSYSPS6200	NSYMP186	NSYSIMP18	NSYVR18	NSYTVR18	1800	600	600
NSYSPF6100	NSYSPS8100	NSYSPF6200	NSYSPS8200	NSYMP186	NSYSIMP18	NSYVR18	NSYTVR18	1800	600	800
NSYSPF8100	NSYSPS4100	NSYSPF8200	NSYSPS4200	NSYMP188	NSYSIMP18	NSYVR18	NSYTVR18	1800	800	400
NSYSPF8100	NSYSPS5100	NSYSPF8200	NSYSPS5200	NSYMP188	NSYSIMP18	NSYVR18	NSYTVR18	1800	800	500
NSYSPF8100	NSYSPS6100	NSYSPF8200	NSYSPS6200	NSYMP188	NSYSIMP18	NSYVR18	NSYTVR18	1800	800	600
NSYSPF8100	NSYSPS8100	NSYSPF8200	NSYSPS8200	NSYMP188	NSYSIMP18	NSYVR18	NSYTVR18	1800	800	800
NSYSPF10100	NSYSPS4100	NSYSPF10200	NSYSPS4200	NSYMP1810	NSYSIMP18	NSYVR18	NSYTVR18	1800	1000	400
NSYSPF10100	NSYSPS5100	NSYSPF10200	NSYSPS5200	NSYMP1810	NSYSIMP18	NSYVR18	NSYTVR18	1800	1000	500
NSYSPF10100	NSYSPS6100	NSYSPF10200	NSYSPS6200	NSYMP1810	NSYSIMP18	NSYVR18	NSYTVR18	1800	1000	600
NSYSPF10100	NSYSPS8100	NSYSPF10200	NSYSPS8200	NSYMP1810	NSYSIMP18	NSYVR18	NSYTVR18	1800	1000	800
NSYSPF12100	NSYSPS4100	NSYSPF12200	NSYSPS4200	NSYMP1812	NSYSIMP18	NSYVR18	NSYTVR18	1800	1200	400
NSYSPF12100	NSYSPS5100	NSYSPF12200	NSYSPS5200	NSYMP1812	NSYSIMP18	NSYVR18	NSYTVR18	1800	1200	500
NSYSPF12100	NSYSPS6100	NSYSPF12200	NSYSPS6200	NSYMP1812	NSYSIMP18	NSYVR18	NSYTVR18	1800	1200	600
NSYSPF3100	NSYSPS5100	NSYSPF3200	NSYSPS5200	-	-	NSYVR20	NSYTVR20	2000	300	500
NSYSPF3100	NSYSPS6100	NSYSPF3200	NSYSPS6200	-	-	NSYVR20	NSYTVR20	2000	300	600
NSYSPF3100	NSYSPS8100	NSYSPF3200	NSYSPS8200	-	-	NSYVR20	NSYTVR20	2000	300	800
NSYSPF4100	NSYSPS4100	NSYSPF4200	NSYSPS4200	NSYMP204	NSYSIMP20	NSYVR20	NSYTVR20	2000	400	400
NSYSPF4100	NSYSPS5100	NSYSPF4200	NSYSPS5200	NSYMP204	NSYSIMP20	NSYVR20	NSYTVR20	2000	400	500
NSYSPF4100	NSYSPS6100	NSYSPF4200	NSYSPS6200	NSYMP204	NSYSIMP20	NSYVR20	NSYTVR20	2000	400	600
NSYSPF4100	NSYSPS8100	NSYSPF4200	NSYSPS8200	NSYMP204	NSYSIMP20	NSYVR20	NSYTVR20	2000	400	800
NSYSPF6100	NSYSPS4100	NSYSPF6200	NSYSPS4200	NSYMP206	NSYSIMP20	NSYVR20	NSYTVR20	2000	600	400
NSYSPF6100	NSYSPS5100	NSYSPF6200	NSYSPS5200	NSYMP206	NSYSIMP20	NSYVR20	NSYTVR20	2000	600	500
NSYSPF6100	NSYSPS6100	NSYSPF6200	NSYSPS6200	NSYMP206	NSYSIMP20	NSYVR20	NSYTVR20	2000	600	600
NSYSPF6100	NSYSPS8100	NSYSPF6200	NSYSPS8200	NSYMP206	NSYSIMP20	NSYVR20	NSYTVR20	2000	600	800
NSYSPF8100	NSYSPS4100	NSYSPF8200	NSYSPS4200	NSYMP208	NSYSIMP20	NSYVR20	NSYTVR20	2000	800	400
NSYSPF8100	NSYSPS5100	NSYSPF8200	NSYSPS5200	NSYMP208	NSYSIMP20	NSYVR20	NSYTVR20	2000	800	500
NSYSPF8100	NSYSPS6100	NSYSPF8200	NSYSPS6200	NSYMP208	NSYSIMP20	NSYVR20	NSYTVR20	2000	800	600
NSYSPF8100	NSYSPS8100	NSYSPF8200	NSYSPS8200	NSYMP208	NSYSIMP20	NSYVR20	NSYTVR20	2000	800	800
NSYSPF10100	NSYSPS4100	NSYSPF10200	NSYSPS4200	NSYMP2010	NSYSIMP20	NSYVR20	NSYTVR20	2000	1000	400
NSYSPF10100	NSYSPS5100	NSYSPF10200	NSYSPS5200	NSYMP2010	NSYSIMP20	NSYVR20	NSYTVR20	2000	1000	500
NSYSPF10100	NSYSPS6100	NSYSPF10200	NSYSPS6200	NSYMP2010	NSYSIMP20	NSYVR20	NSYTVR20	2000	1000	600
NSYSPF10100	NSYSPS8100	NSYSPF10200	NSYSPS8200	NSYMP2010	NSYSIMP20	NSYVR20	NSYTVR20	2000	1000	800
NSYSPF12100	NSYSPS4100	NSYSPF12200	NSYSPS4200	NSYMP2012	NSYSIMP20	NSYVR20	NSYTVR20	2000	1200	400
NSYSPF12100	NSYSPS5100	NSYSPF12200	NSYSPS5200	NSYMP2012	NSYSIMP20	NSYVR20	NSYTVR20	2000	1200	500
NSYSPF12100	NSYSPS6100	NSYSPF12200	NSYSPS6200	NSYMP2012	NSYSIMP20	NSYVR20	NSYTVR20	2000	1200	600
NSYSPF12100	NSYSPS8100	NSYSPF12200	NSYSPS8200	NSYMP2012	NSYSIMP20	NSYVR20	NSYTVR20	2000	1200	800
NSYSPF16100	NSYSPS4100	NSYSPF16200	NSYSPS4200	NSYMP2016	NSYSIMP20	NSYVR20	NSYTVR20	2000	1600	400
NSYSPF16100	NSYSPS5100	NSYSPF16200	NSYSPS5200	NSYMP2016	NSYSIMP20	NSYVR20	NSYTVR20	2000	1600	500
NSYSPF16100	NSYSPS6100	NSYSPF16200	NSYSPS6200	NSYMP2016	NSYSIMP20	NSYVR20	NSYTVR20	2000	1600	600
NSYSPF4100	NSYSPS6100	NSYSPF4200	NSYSPS6200	NSYMP224	NSYSIMP22	NSYVR22	NSYTVR22	2200	400	600
NSYSPF6100	NSYSPS6100	NSYSPF6200	NSYSPS6200	NSYMP226	NSYSIMP22	NSYVR22	NSYTVR22	2200	600	600
NSYSPF6100	NSYSPS8100	NSYSPF6200	NSYSPS8200	NSYMP226	NSYSIMP22	NSYVR22	NSYTVR22	2200	600	800
NSYSPF8100	NSYSPS6100	NSYSPF8200	NSYSPS6200	NSYMP228	NSYSIMP22	NSYVR22	NSYTVR22	2200	800	600
NSYSPF8100	NSYSPS8100	NSYSPF8200	NSYSPS8200	NSYMP228	NSYSIMP22	NSYVR22	NSYTVR22	2200	800	800
NSYSPF10100	NSYSPS6100	NSYSPF10200	NSYSPS6200	NSYMP2210	NSYSIMP22	NSYVR22	NSYTVR22	2200	1000	600
NSYSPF12100	NSYSPS6100	NSYSPF12200	NSYSPS6200	NSYMP2212	NSYSIMP22	NSYVR22	NSYTVR22	2200	1200	600
NSYSPF12100	NSYSPS8100	NSYSPF12200	NSYSPS8200	NSYMP2212	NSYSIMP22	NSYVR22	NSYTVR22	2200	1200	800

Technical changes reserved. Information provided without guarantee. Images are for illustrative purposes only.

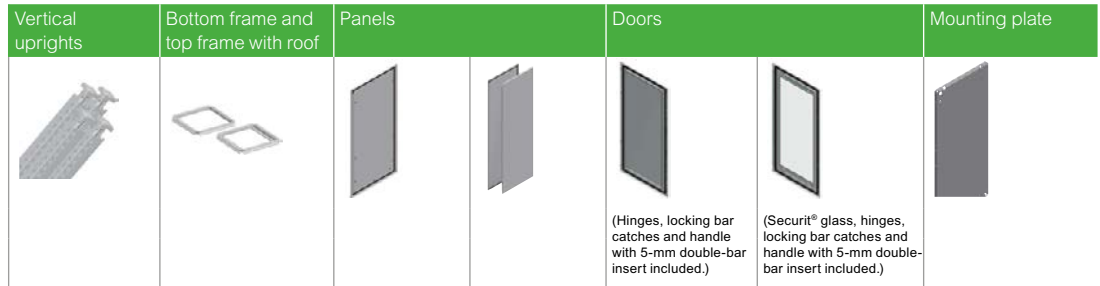

Dimensions			Doors	Vertical uprights		Bottom frame and top frame with roof		Panels		Doors		Mounting plate
(A) Height (mm)	(B) Width (mm)	(C) Depth (mm)		Standard	Frames	Rear panel	Side panel	Plain	Transparent	Standard		
1200	600	400	1	NSYSFV12	NSYSFC64	NSYBP126	NSY2SP124	NSYSFD126	NSYSFD126T	NSYMP126		
1200	600	500	1	NSYSFV12	NSYSFC65	NSYBP126	NSY2SP125	NSYSFD126	NSYSFD126T	NSYMP126		
1200	600	600	1	NSYSFV12	NSYSFC66	NSYBP126	NSY2SP126	NSYSFD126	NSYSFD126T	NSYMP126		
1200	600	800	1	NSYSFV12	NSYSFC68	NSYBP126	NSY2SP128	NSYSFD126	NSYSFD126T	NSYMP126		
1200	800	400	1	NSYSFV12	NSYSFC84	NSYBP128	NSY2SP124	NSYSFD128	NSYSFD128T	NSYMP128		
1200	800	500	1	NSYSFV12	NSYSFC85	NSYBP128	NSY2SP125	NSYSFD128	NSYSFD128T	NSYMP128		
1200	800	600	1	NSYSFV12	NSYSFC86	NSYBP128	NSY2SP126	NSYSFD128	NSYSFD128T	NSYMP128		
1200	800	800	1	NSYSFV12	NSYSFC88	NSYBP128	NSY2SP128	NSYSFD128	NSYSFD128T	NSYMP128		
1400	600	400	1	NSYSFV14	NSYSFC64	NSYBP146	NSY2SP144	NSYSFD146	NSYSFD146T	NSYMP146		
1400	600	500	1	NSYSFV14	NSYSFC65	NSYBP146	NSY2SP145	NSYSFD146	NSYSFD146T	NSYMP146		
1400	600	600	1	NSYSFV14	NSYSFC66	NSYBP146	NSY2SP146	NSYSFD146	NSYSFD146T	NSYMP146		
1400	600	800	1	NSYSFV14	NSYSFC68	NSYBP146	NSY2SP148	NSYSFD146	NSYSFD146T	NSYMP146		
1400	800	400	1	NSYSFV14	NSYSFC84	NSYBP148	NSY2SP144	NSYSFD148	NSYSFD148T	NSYMP148		
1400	800	500	1	NSYSFV14	NSYSFC85	NSYBP148	NSY2SP145	NSYSFD148	NSYSFD148T	NSYMP148		
1400	800	600	1	NSYSFV14	NSYSFC86	NSYBP148	NSY2SP146	NSYSFD148	NSYSFD148T	NSYMP148		
1400	800	800	1	NSYSFV14	NSYSFC88	NSYBP148	NSY2SP148	NSYSFD148	NSYSFD148T	NSYMP148		
1600	600	400	1	NSYSFV16	NSYSFC64	NSYBP166	NSY2SP164	NSYSFD166	NSYSFD166T	NSYMP166		
1600	600	500	1	NSYSFV16	NSYSFC65	NSYBP166	NSY2SP165	NSYSFD166	NSYSFD166T	NSYMP166		
1600	600	600	1	NSYSFV16	NSYSFC66	NSYBP166	NSY2SP166	NSYSFD166	NSYSFD166T	NSYMP166		
1600	600	800	1	NSYSFV16	NSYSFC68	NSYBP166	NSY2SP168	NSYSFD166	NSYSFD166T	NSYMP166		
1600	800	400	1	NSYSFV16	NSYSFC84	NSYBP168	NSY2SP164	NSYSFD168	NSYSFD168T	NSYMP168		
1600	800	500	1	NSYSFV16	NSYSFC85	NSYBP168	NSY2SP165	NSYSFD168	NSYSFD168T	NSYMP168		
1600	800	600	1	NSYSFV16	NSYSFC86	NSYBP168	NSY2SP166	NSYSFD168	NSYSFD168T	NSYMP168		
1600	800	800	1	NSYSFV16	NSYSFC88	NSYBP168	NSY2SP168	NSYSFD168	NSYSFD168T	NSYMP168		
1800	400	400	1	NSYSFV18	NSYSFC44	NSYBP184	NSY2SP184	NSYSFD184	-	NSYMP184		
1800	400	500	1	NSYSFV18	NSYSFC45	NSYBP184	NSY2SP185	NSYSFD184	-	NSYMP184		
1800	400	600	1	NSYSFV18	NSYSFC46	NSYBP184	NSY2SP186	NSYSFD184	-	NSYMP184		
1800	400	800	1	NSYSFV18	NSYSFC48	NSYBP184	NSY2SP188	NSYSFD184	-	NSYMP184		
1800	600	400	1	NSYSFV18	NSYSFC64	NSYBP186	NSY2SP184	NSYSFD186	NSYSFD186T	NSYMP186		
1800	600	500	1	NSYSFV18	NSYSFC65	NSYBP186	NSY2SP185	NSYSFD186	NSYSFD186T	NSYMP186		
1800	600	600	1	NSYSFV18	NSYSFC66	NSYBP186	NSY2SP186	NSYSFD186	NSYSFD186T	NSYMP186		
1800	600	800	1	NSYSFV18	NSYSFC68	NSYBP186	NSY2SP188	NSYSFD186	NSYSFD186T	NSYMP186		
1800	800	400	1	NSYSFV18	NSYSFC84	NSYBP188	NSY2SP184	NSYSFD188	NSYSFD188T	NSYMP188		
1800	800	500	1	NSYSFV18	NSYSFC85	NSYBP188	NSY2SP185	NSYSFD188	NSYSFD188T	NSYMP188		
1800	800	600	1	NSYSFV18	NSYSFC86	NSYBP188	NSY2SP186	NSYSFD188	NSYSFD188T	NSYMP188		
1800	800	600	2	NSYSFV18	NSYSFC86	NSYBP188	NSY2SP186	NSYSFD1882D	-	NSYMP188		
1800	800	800	1	NSYSFV18	NSYSFC88	NSYBP188	NSY2SP188	NSYSFD188	NSYSFD188T	NSYMP188		
1800	800	800	2	NSYSFV18	NSYSFC88	NSYBP188	NSY2SP188	NSYSFD1882D	-	NSYMP188		
1800	1000	400	1	NSYSFV18	NSYSFC104	NSYBP1810	NSY2SP184	NSYSFD1810	NSYSFD1810T	NSYMP1810		
1800	1000	400	2	NSYSFV18	NSYSFC104	NSYBP1810	NSY2SP184	NSYSFD18102D	-	NSYMP1810		
1800	1000	500	1	NSYSFV18	NSYSFC105	NSYBP1810	NSY2SP185	NSYSFD1810	NSYSFD1810T	NSYMP1810		
1800	1000	600	1	NSYSFV18	NSYSFC106	NSYBP1810	NSY2SP186	NSYSFD1810	NSYSFD1810T	NSYMP1810		
1800	1000	600	2	NSYSFV18	NSYSFC106	NSYBP1810	NSY2SP186	NSYSFD18102D	-	NSYMP1810		
1800	1000	800	1	NSYSFV18	NSYSFC108	NSYBP1810	NSY2SP188	NSYSFD1810	NSYSFD1810T	NSYMP1810		
1800	1000	800	2	NSYSFV18	NSYSFC108	NSYBP1810	NSY2SP188	NSYSFD18102D	-	NSYMP1810		
1800	1200	400	2	NSYSFV18	NSYSFC124	NSYBP1812	NSY2SP184	NSYSFD18122D	NSYSFD18122DT	NSYMP1812		
1800	1200	500	2	NSYSFV18	NSYSFC125	NSYBP1812	NSY2SP185	NSYSFD18122D	NSYSFD18122DT	NSYMP1812		
1800	1200	600	2	NSYSFV18	NSYSFC126	NSYBP1812	NSY2SP186	NSYSFD18122D	NSYSFD18122DT	NSYMP1812		
1800	1200	800	2	NSYSFV18	NSYSFC128	NSYBP1812	NSY2SP188	NSYSFD18122D	NSYSFD18122DT	NSYMP1812		

Technical changes reserved. Information provided without guarantee. Images are for illustrative purposes only.

Dimensions			Doors	Vertical uprights	Bottom frame and top frame with roof	Panels		Doors		Mounting plate
(A) Height (mm)	(B) Width (mm)	(C) Depth (mm)		Standard	Frames	Rear panel	Side panel	Plain	Transparent	Standard
2000	300	500	1	NSYSFV20	NSYSFC35	NSYBP203	NSY2SP205	NSYSFD203	-	-
2000	300	600	1	NSYSFV20	NSYSFC36	NSYBP203	NSY2SP206	NSYSFD203	-	-
2000	300	800	1	NSYSFV20	NSYSFC38	NSYBP203	NSY2SP208	NSYSFD203	-	-
2000	400	400	1	NSYSFV20	NSYSFC44	NSYBP204	NSY2SP204	NSYSFD204	-	NSYMP204
2000	400	500	1	NSYSFV20	NSYSFC45	NSYBP204	NSY2SP205	NSYSFD204	-	NSYMP204
2000	400	600	1	NSYSFV20	NSYSFC46	NSYBP204	NSY2SP206	NSYSFD204	-	NSYMP204
2000	400	800	1	NSYSFV20	NSYSFC48	NSYBP204	NSY2SP208	NSYSFD204	-	NSYMP204
2000	600	400	1	NSYSFV20	NSYSFC64	NSYBP206	NSY2SP204	NSYSFD206	NSYSFD206T	NSYMP206
2000	600	500	1	NSYSFV20	NSYSFC65	NSYBP206	NSY2SP205	NSYSFD206	NSYSFD206T	NSYMP206
2000	600	600	1	NSYSFV20	NSYSFC66	NSYBP206	NSY2SP206	NSYSFD206	NSYSFD206T	NSYMP206
2000	600	800	1	NSYSFV20	NSYSFC68	NSYBP206	NSY2SP208	NSYSFD206	NSYSFD206T	NSYMP206
2000	800	400	1	NSYSFV20	NSYSFC84	NSYBP208	NSY2SP204	NSYSFD208	NSYSFD208T	NSYMP208
2000	800	500	1	NSYSFV20	NSYSFC85	NSYBP208	NSY2SP205	NSYSFD208	NSYSFD208T	NSYMP208
2000	800	600	1	NSYSFV20	NSYSFC86	NSYBP208	NSY2SP206	NSYSFD208	NSYSFD208T	NSYMP208
2000	800	600	2	NSYSFV20	NSYSFC86	NSYBP208	NSY2SP206	NSYSFD2082D	-	NSYMP208
2000	800	800	1	NSYSFV20	NSYSFC88	NSYBP208	NSY2SP208	NSYSFD208	NSYSFD208T	NSYMP208
2000	800	800	2	NSYSFV20	NSYSFC88	NSYBP208	NSY2SP208	NSYSFD2082D	-	NSYMP208
2000	1000	400	1	NSYSFV20	NSYSFC104	NSYBP2010	NSY2SP204	NSYSFD2010	NSYSFD2010T	NSYMP2010
2000	1000	400	2	NSYSFV20	NSYSFC104	NSYBP2010	NSY2SP204	NSYSFD20102D	-	NSYMP2010
2000	1000	500	1	NSYSFV20	NSYSFC105	NSYBP2010	NSY2SP205	NSYSFD2010	NSYSFD2010T	NSYMP2010
2000	1000	500	2	NSYSFV20	NSYSFC105	NSYBP2010	NSY2SP205	NSYSFD20102D	-	NSYMP2010
2000	1000	600	1	NSYSFV20	NSYSFC106	NSYBP2010	NSY2SP206	NSYSFD2010	NSYSFD2010T	NSYMP2010
2000	1000	600	2	NSYSFV20	NSYSFC106	NSYBP2010	NSY2SP206	NSYSFD20102D	-	NSYMP2010
2000	1000	800	1	NSYSFV20	NSYSFC108	NSYBP2010	NSY2SP208	NSYSFD2010	NSYSFD2010T	NSYMP2010
2000	1000	800	2	NSYSFV20	NSYSFC108	NSYBP2010	NSY2SP208	NSYSFD20102D	-	NSYMP2010
2000	1200	400	2	NSYSFV20	NSYSFC124	NSYBP2012	NSY2SP204	NSYSFD20122D	NSYSFD20122DT	NSYMP2012
2000	1200	500	2	NSYSFV20	NSYSFC125	NSYBP2012	NSY2SP205	NSYSFD20122D	NSYSFD20122DT	NSYMP2012
2000	1200	600	2	NSYSFV20	NSYSFC126	NSYBP2012	NSY2SP206	NSYSFD20122D	NSYSFD20122DT	NSYMP2012
2000	1200	800	2	NSYSFV20	NSYSFC128	NSYBP2012	NSY2SP208	NSYSFD20122D	NSYSFD20122DT	NSYMP2012
2000	1600	400	2	NSYSFV20	NSYSFC164	NSYBP2016	NSY2SP204	NSYSFD20162D	-	NSYMP2016
2000	1600	500	2	NSYSFV20	NSYSFC165	NSYBP2016	NSY2SP205	NSYSFD20162D	-	NSYMP2016
2000	1600	600	2	NSYSFV20	NSYSFC166	NSYBP2016	NSY2SP206	NSYSFD20162D	-	NSYMP2016
2200	400	400	1	NSYSFV22	NSYSFC44	NSYBP224	NSY2SP224	NSYSFD224	-	NSYMP224
2200	400	500	1	NSYSFV22	NSYSFC45	NSYBP224	NSY2SP225	NSYSFD224	-	NSYMP224
2200	400	600	1	NSYSFV22	NSYSFC46	NSYBP224	NSY2SP226	NSYSFD224	-	NSYMP224
2200	400	800	1	NSYSFV22	NSYSFC48	NSYBP224	NSY2SP228	NSYSFD224	-	NSYMP224
2200	600	400	1	NSYSFV22	NSYSFC64	NSYBP226	NSY2SP224	NSYSFD226	NSYSFD226T	NSYMP226
2200	600	500	1	NSYSFV22	NSYSFC65	NSYBP226	NSY2SP225	NSYSFD226	NSYSFD226T	NSYMP226
2200	600	600	1	NSYSFV22	NSYSFC66	NSYBP226	NSY2SP226	NSYSFD226	NSYSFD226T	NSYMP226
2200	600	800	1	NSYSFV22	NSYSFC68	NSYBP226	NSY2SP228	NSYSFD226	NSYSFD226T	NSYMP226
2200	800	400	1	NSYSFV22	NSYSFC84	NSYBP228	NSY2SP224	NSYSFD228	NSYSFD228T	NSYMP228
2200	800	500	1	NSYSFV22	NSYSFC85	NSYBP228	NSY2SP225	NSYSFD228	NSYSFD228T	NSYMP228
2200	800	600	1	NSYSFV22	NSYSFC86	NSYBP228	NSY2SP226	NSYSFD228	NSYSFD228T	NSYMP228
2200	800	800	1	NSYSFV22	NSYSFC88	NSYBP228	NSY2SP228	NSYSFD228	NSYSFD228T	NSYMP228
2200	1000	400	1	NSYSFV22	NSYSFC104	NSYBP2210	NSY2SP224	NSYSFD2210	NSYSFD2210T	NSYMP2210
2200	1000	500	1	NSYSFV22	NSYSFC105	NSYBP2210	NSY2SP225	NSYSFD2210	NSYSFD2210T	NSYMP2210
2200	1000	600	1	NSYSFV22	NSYSFC106	NSYBP2210	NSY2SP226	NSYSFD2210	NSYSFD2210T	NSYMP2210
2200	1000	800	1	NSYSFV22	NSYSFC108	NSYBP2210	NSY2SP228	NSYSFD2210	NSYSFD2210T	NSYMP2210
2200	1200	400	2	NSYSFV22	NSYSFC124	NSYBP2212	NSY2SP224	NSYSFD22122D	NSYSFD22122DT	NSYMP2212
2200	1200	500	2	NSYSFV22	NSYSFC125	NSYBP2212	NSY2SP225	NSYSFD22122D	NSYSFD22122DT	NSYMP2212
2200	1200	600	2	NSYSFV22	NSYSFC126	NSYBP2212	NSY2SP226	NSYSFD22122D	NSYSFD22122DT	NSYMP2212
2200	1200	800	2	NSYSFV22	NSYSFC128	NSYBP2212	NSY2SP228	NSYSFD22122D	NSYSFD22122DT	NSYMP2212

Technical changes reserved. Information provided without guarantee. Images are for illustrative purposes only.

Side door

3



- Door for the side of the enclosure, replaces the side panel.
- Installation directly on the structure of the enclosure, opening 120°.
- Lock with handle and 5-mm double-bar insert. 4 locking points.
- Reinforcement frame, cut-out with a pitch of 25 mm.
- Opening to right or left.
- Material: Steel
- Finish: Structured finish, epoxy polyester powder
- Color: RAL 7035 grey
- Ingress protection rating: IP55 according to IEC 60529

Supply:
One side door, four hinges, four catches and handle lock



NSYSFD126

Characteristics	Height (mm)	Depth (mm)	References
Spacial SF Side door	1200	600	NSYSFD126
Spacial SF Side door	1200	800	NSYSFD128
Spacial SF Side door	1400	600	NSYSFD146
Spacial SF Side door	1400	800	NSYSFD148
Spacial SF Side door	1600	600	NSYSFD166
Spacial SF Side door	1600	800	NSYSFD168
Spacial SF Side door	1800	400	NSYSFD184
Spacial SF Side door	1800	500	NSYSFD185
Spacial SF Side door	1800	600	NSYSFD186
Spacial SF Side door	1800	800	NSYSFD188
Spacial SF Side door	2000	400	NSYSFD204
Spacial SF Side door	2000	500	NSYSFD205
Spacial SF Side door	2000	600	NSYSFD206
Spacial SF Side door	2000	800	NSYSFD208
Spacial SF Side door	2200	400	NSYSFD224
Spacial SF Side door	2200	500	NSYSFD225
Spacial SF Side door	2200	600	NSYSFD226
Spacial SF Side door	2200	800	NSYSFD228

External fixing

- Set of 2 side panels fixed from the outside of the enclosure.
- Material: Steel
- Finish: Structured finish, epoxy polyester powder
- Color: RAL 7035 grey
- Ingress protection rating: IP55 according to IEC 60529

Supply:
2 side panels, with sealing gasket and bag of accessories

Characteristics	Height (mm)	Depth (mm)	References
Set of 2 side panels fixed from the outside of the enclosure	1200	400	NSY2SP124
Set of 2 side panels fixed from the outside of the enclosure	1200	500	NSY2SP125
Set of 2 side panels fixed from the outside of the enclosure	1200	600	NSY2SP126
Set of 2 side panels fixed from the outside of the enclosure	1200	800	NSY2SP128
Set of 2 side panels fixed from the outside of the enclosure	1400	400	NSY2SP144
Set of 2 side panels fixed from the outside of the enclosure	1400	500	NSY2SP145
Set of 2 side panels fixed from the outside of the enclosure	1400	600	NSY2SP146
Set of 2 side panels fixed from the outside of the enclosure	1400	800	NSY2SP148
Set of 2 side panels fixed from the outside of the enclosure	1600	400	NSY2SP164
Set of 2 side panels fixed from the outside of the enclosure	1600	500	NSY2SP165
Set of 2 side panels fixed from the outside of the enclosure	1600	600	NSY2SP166
Set of 2 side panels fixed from the outside of the enclosure	1600	800	NSY2SP168
Set of 2 side panels fixed from the outside of the enclosure	1800	400	NSY2SP184
Set of 2 side panels fixed from the outside of the enclosure	1800	500	NSY2SP185
Set of 2 side panels fixed from the outside of the enclosure	1800	600	NSY2SP186
Set of 2 side panels fixed from the outside of the enclosure	1800	800	NSY2SP188
Set of 2 side panels fixed from the outside of the enclosure	2000	400	NSY2SP204
Set of 2 side panels fixed from the outside of the enclosure	2000	500	NSY2SP205
Set of 2 side panels fixed from the outside of the enclosure	2000	600	NSY2SP206
Set of 2 side panels fixed from the outside of the enclosure	2000	800	NSY2SP208
Set of 2 side panels fixed from the outside of the enclosure	2200	400	NSY2SP224
Set of 2 side panels fixed from the outside of the enclosure	2200	500	NSY2SP225
Set of 2 side panels fixed from the outside of the enclosure	2200	600	NSY2SP226
Set of 2 side panels fixed from the outside of the enclosure	2200	800	NSY2SP228



NSY2SP124

Internal fixing

- Set of 2 side panels fixed from the enclosure, helping prevent access by unauthorized persons.
- Very useful in public spaces.
- Material: Steel
- Finish: Painted with epoxy polyester resin
- Color: RAL 7035 grey
- Ingress protection rating: IP55 according to IEC 60529

Supply:
2 side panels, with sealing gasket and bag of accessories

Characteristics	Height (mm)	Depth (mm)	References
Set of 2 side panels fixed from the enclosure	1200	600	NSY2SPI126
Set of 2 side panels fixed from the enclosure	1800	500	NSY2SPI185
Set of 2 side panels fixed from the enclosure	1800	600	NSY2SPI186
Set of 2 side panels fixed from the enclosure	1800	800	NSY2SPI188
Set of 2 side panels fixed from the enclosure	2000	400	NSY2SPI204
Set of 2 side panels fixed from the enclosure	2000	500	NSY2SPI205
Set of 2 side panels fixed from the enclosure	2000	600	NSY2SPI206
Set of 2 side panels fixed from the enclosure	2000	800	NSY2SPI208
Set of 2 side panels fixed from the enclosure	2200	600	NSY2SPI226
Set of 2 side panels fixed from the enclosure	2200	800	NSY2SPI228



NSY2SPI126

Internal fixing rear panel

- Rear panel fixed from the inside of the enclosure, helping prevent unauthorized personnel from accessing and removing it. Normally used in public spaces.
- Material: Steel
- Finish: Painted with epoxy polyester resin
- Color: RAL 7035 grey
- Ingress protection rating: IP55 according to IEC 60529

Supply:
1 rear panel and fixing elements

Characteristics	Height (mm)	Depth (mm)	References
Rear panel fixed from the inside of the enclosure	1800	1000	NSYBPI1810
Rear panel fixed from the inside of the enclosure	2000	600	NSYBPI206
Rear panel fixed from the inside of the enclosure	2000	800	NSYBPI208
Rear panel fixed from the inside of the enclosure	2000	1000	NSYBPI2010
Rear panel fixed from the inside of the enclosure	2200	800	NSYBPI228
Rear panel fixed from the inside of the enclosure	2200	1000	NSYBPI2210



NSYBPI1810

Partition panel

- Partition panel for direct fixing to the structure, helps guarantee a water/dustproof protection of IP10 between enclosure suites.
- Material: Galvanized steel
- Color: RAL 7035 grey
- Ingress protection rating: IP55 according to IEC 60529

Supply:
1 partition panel, sealing gasket and fixing elements

Characteristics	Height (mm)	Depth (mm)	References
Spacial SF partition panel	1600	600	NSYPPS166
Spacial SF partition panel	1600	800	NSYPPS168
Spacial SF partition panel	1800	400	NSYPPS184
Spacial SF partition panel	1800	500	NSYPPS185
Spacial SF partition panel	1800	600	NSYPPS186
Spacial SF partition panel	2000	400	NSYPPS204
Spacial SF partition panel	2000	500	NSYPPS205
Spacial SF partition panel	2000	600	NSYPPS206
Spacial SF partition panel	2000	800	NSYPPS208
Spacial SF partition panel	2200	600	NSYPPS226
Spacial SF partition panel	2200	800	NSYPPS228



NSYPPS166

Accessories

- Trim cap for external fixing panels, both sides and rear
- Material: Polyamide 6
- Color: RAL 7035 grey

Supply:
50 units

Characteristics	References
Trim cap for external fixing panels	NSYCSP



NSYCSP

SF Standard coupling kit



NSYSFBK

- Used for joining enclosures side-to-side or depthwise.
- Fixing from the inside of the enclosure.
- Material: Flat connectors and brackets: Zinc-coated steel
Sealing gasket: EPDM

Supply:
4 brackets, 2 flat connectors, sealing gasket and fixing elements and 16 caps

Characteristics	References
Spacial SF Standard coupling kit	NSYSFBK

SF Swing 19" rack coupling kit

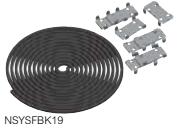

NSYSFBK19

- Used for joining enclosures equipped with swing 19" rack, side-to-side or depthwise.
- Fixing from the inside of the enclosures.
- Material: Flat connectors: Zinc-coated steel
Sealing gasket: EPDM

Supply:
8 flat connectors, sealing gasket and fixing elements and 16 caps

Characteristics	References
Spacial SF-19" Swing 19" rack coupling kit	NSYSFBK19

SF Reinforced coupling



NSYSFBKR

- It is used together with the coupling kit to reinforce the connection between 2 enclosures when they carry heavy loads.
- Fixing from the inside of the enclosures.
- Material: Zinc-coated steel

Supply:
4 reinforced connectors and fixing elements

Characteristics	References
Spacial SF Reinforced coupling	NSYSFBKR

SF Quick coupling



NSYSFBKF

- Used for quickly joining 2 enclosures.
- Fixing from the inside of the enclosures.
- Material: Zinc-coated steel

Supply:
4 flat links and fixing elements

Characteristics	References
Spacial SF Quick coupling, IP 40	NSYSFBKF

SF Kit for coupling the previous version with Spacial SF

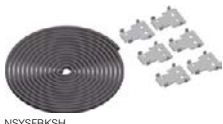

NSYSFBKSH

- It is used for coupling an enclosure of a previous version (OLN or Spacial 6000) side-to-side or depthwise with a Spacial SF enclosure.
- Fixing from the inside of the enclosures.
- Material: Flat connectors and spacers: Zinc-coated steel
Sealing gasket: EPDM

Supply:
6 flat connectors, sealing gasket and fixing elements

Characteristics	References
Spacial SF Kit for coupling the previous version with Spacial SF	NSYSFBKSH

SF External coupling



NSYSFBKE

- Allows two enclosures to be joined by their structure.
- To be used with the standard coupling kit in those cases where front and back uprights are not accessible.
- The mounting plate or vertical uprights fixed to the back of the enclosure help prevent the assembly and dismantling of the kit.
- It can be combined with the reinforced or the quick coupling kit.
- Material: External connectors: Zinc-coated steel

Supply:
4 external connectors and fixing elements

Characteristics	References
Spacial SF External coupling	NSYSFBKE

SM Enclosure coupling kit for Spacial SM



NSYSMBK

- Used for joining enclosure side-to-side.
- Enclosures fixed from the inside.
- Material: 3 x 10 mm sealing gasket: EPDM

Supply:
1 sealing gasket and fixing elements

Characteristics	References
Spacial SM Enclosure coupling kit for Spacial SM	NSYSMBK

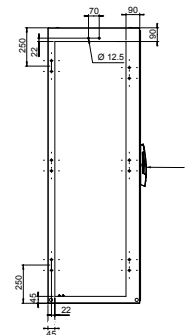

Plinth as a kit

3

The complete plinth consists of two elements, one is the front and rear kit, determined by the length of the enclosure, and the other consists of the side panels which determine the depth of the enclosure. The number of side panels required depends on the plinth combination.

- + Robust design.
- + The modular plinth system makes it possible to reduce the number of references in stock.

Characteristics	Front and rear kit	Side panels	Complete plinth
Plinth height 100 mm			
Plinth height 200 mm			

Floor

Examples of solutions

Plinth cross-rail fixed in position B, requires 2 cross-rails fixed in position A.

- They are fixed to the plinth cross-rails, both the universal and the quick-fixing types.
- Their depth is adjustable in increments of 25 mm.

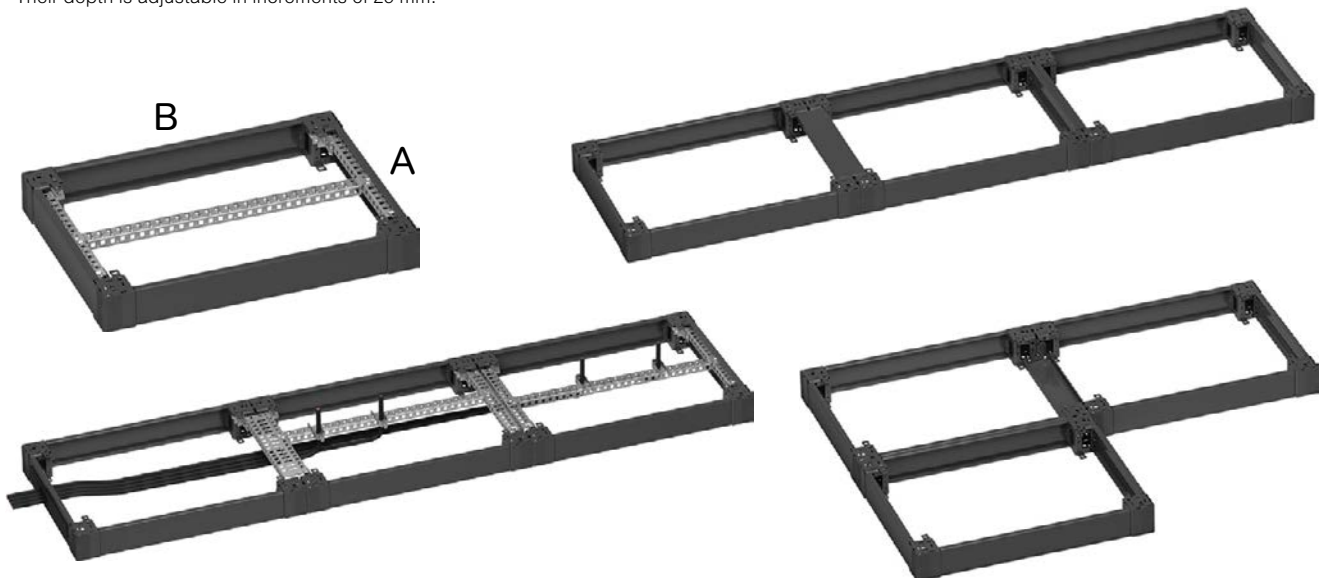

Comment: Universal and quick-fixing cross-rail references, [page 274](#)

Possibility of joining plinths

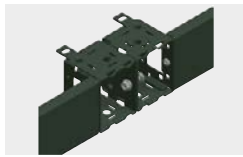

The surfaces between corners are always in contact.

They are joined by a M8 screw and nut, not included in the standard supply.

- + Longitudinally free space for passing cables
- + Greater rigidity of the resulting assembly unit



Side panels

are secured by M6 screws and caged nuts, not included in the standard supply, reference **NSYSMP6** and reference **NSYCN9M625**, which can be mounted above and/or below.

- + Improves rigidity in the depthwise direction during transport

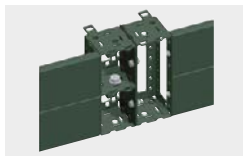

Vertical plinth assembly

are secured by means of M12 screws and nuts, not included in the standard supply.

- + The two heights of corners can be combined

Possibility of fixing the enclosure to the plinth

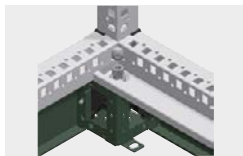

Fixing from the inside of the enclosure

by means of an M12 screw, screwing directly into the corner of the plinth.

- + Fixing convenience and speed



Fixing from the outside of the enclosure

with a M12 screw, screwing directly onto the vertical upright.

- + Maximum rigidity of the enclosure-plinth assembly

Possibility of fixing the plinth to the floor



Fixing from the inside of the enclosure.

The machining angle varies according to the plinth model:

- Plinth height 100 mm $\varphi = 18^\circ$.
- Plinth height 200 mm $\varphi = 9^\circ$.



Fixing from the outside of the enclosure, optimal point for the rigidity of the assembly.

The machining angle varies according to the plinth model:

- Plinth height 100 mm $\varphi = 22^\circ$.
- Plinth height 200 mm $\varphi = 11^\circ$.

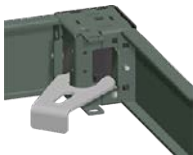

Floor-fixing supports can be used as well.

- Reference **NSYSGF**, to fix the corner or the panel and the corner to the floor.

The corners can be rotated if the side panels of the plinth need to be removed and/or to obtain access to the external fixing when the set is set up against the wall.

Fixing the enclosure to the floor



Fixing from the outside of the enclosure

Optimal point for the rigidity of the assembly.

The machining angle varies according to the plinth model:

- Plinth height 100 mm $\varphi = 22^\circ$.
- Plinth height 200 mm $\varphi = 11^\circ$.

Fixing the enclosure to the floor



Enclosure against a wall

Thanks to the design of the corners, when the enclosure is installed against the wall, the following is possible:

- To remove the side panels (turning back corners),
 - To access the external fixing to the floor.
- It is also possible to use floor-fixing supports, reference **NSYSGF**, to fix the corner or the panel and the corner to the floor.

Fixing the enclosure to the plinth



Fixing from the inside of the enclosure

by means of a M12 screw, screwing directly into the corner of the plinth

- + Fixing convenience and speed.

Assembly of the plinth panels



The panels are fixed with an M6 screw to the corner

included in the standard supply of the side panels.

- The front and rear panels are delivered with the corners mounted

Front and rear plinths

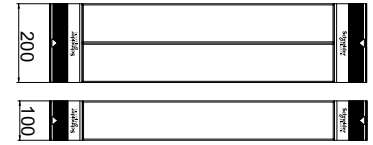
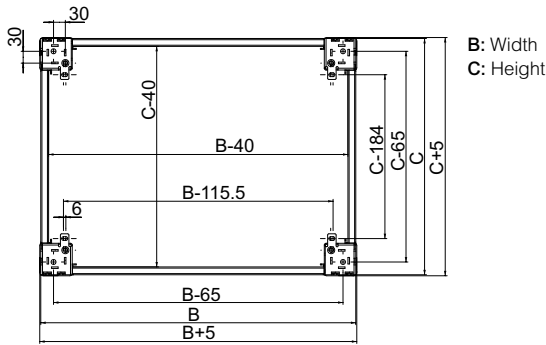

- The front and rear of the plinth consists of 4 corners with 2 or 4 panels.
- Material: Folded sheet steel, corner with a thickness of 25/10° mm
- Finish: Structured finish, epoxy polyester powder
- Color: RAL 7022 grey
- Ingress protection rating: IP30 according to IEC 60529
- Mechanical protection rating: IK10 according to IEC 62262

Supply:

Height 100 mm: 4 corners, 2 panels (front and rear), 4 corner covers and fixing elements
 Height 200 mm: 4 corners, 4 panels (2 front and 2 rear), 4 corner covers and fixing elements

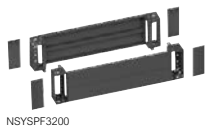
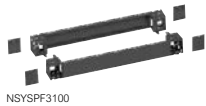

Characteristics	Height (mm)	Width (mm)	References
Front plinths for Spacial	100	300	NSYSPF3100
Front plinths for Spacial	100	400	NSYSPF4100
Front plinths for Spacial	100	600	NSYSPF6100
Front plinths for Spacial	100	800	NSYSPF8100
Front plinths for Spacial	100	1000	NSYSPF10100
Front plinths for Spacial	100	1200	NSYSPF12100
Front plinths for Spacial	100	1600	NSYSPF16100
Front plinths for Spacial	200	300	NSYSPF3200
Front plinths for Spacial	200	400	NSYSPF4200
Front plinths for Spacial	200	600	NSYSPF6200
Front plinths for Spacial	200	800	NSYSPF8200
Front plinths for Spacial	200	1000	NSYSPF10200
Front plinths for Spacial	200	1200	NSYSPF12200
Front plinths for Spacial	200	1600	NSYSPF16200

Plinth side panels

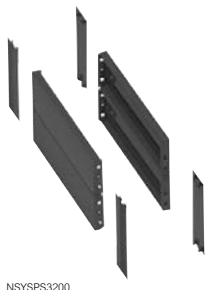

- They are fixed to the corner of the plinth by 2 fixing screws.
- Material: Folded sheet steel
- Finish: Structured finish, epoxy polyester powder
- Color: RAL 7022 grey
- Ingress protection rating: IP30 according to IEC 60529
- Mechanical protection rating: IK10 according to IEC 62262

Supply:

Height 100 mm: 2 side panels, 4 corner covers and fixing elements
 Height 200 mm: 4 side panels (height of 100 mm, 2 for each side), 4 corner covers and fixing elements

Characteristics	Height (mm)	Depth (mm)	References
Side plinths for Spacial	100	300	NSYSPS3100
Side plinths for Spacial	100	400	NSYSPS4100
Side plinths for Spacial	100	500	NSYSPS5100
Side plinths for Spacial	100	600	NSYSPS6100
Side plinths for Spacial	100	800	NSYSPS8100
Side plinths for Spacial	200	300	NSYSPS3200
Side plinths for Spacial	200	400	NSYSPS4200
Side plinths for Spacial	200	500	NSYSPS5200
Side plinths for Spacial	200	600	NSYSPS6200
Side plinths for Spacial	200	800	NSYSPS8200

Ventilated front plinth



NSYSPFV6100

- The front and rear of the ventilated plinth is made up of 4 corners with 2 front panels.
- Material: Folded sheet steel, corner with a thickness of 25/10° mm
- Finish: Structured finish, epoxy polyester powder
- Color: RAL 7022 grey
- Ingress protection rating: IP20 according to IEC 60529
- Mechanical protection rating: IK10 according to IEC 62262

Supply:
Height 100 mm: 4 corners, 2 ventilated panels (front and rear), 4 corner covers and fixing elements

Characteristics	Height (mm)	Width (mm)	References
Ventilated front plinth for Spacial SF-SM	100	600	NSYSPFV6100
Ventilated front plinth for Spacial SF-SM	100	800	NSYSPFV8100

Ventilated side panels

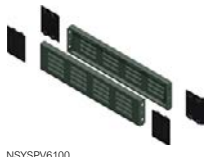

NSYSPV6100

- They are fixed to the corner of the plinth by fixing screws.
- Material: Folded sheet steel
- Finish: Structured finish, epoxy polyester powder
- Color: RAL 7022 grey
- Ingress protection rating: IP20 according to IEC 60529
- Mechanical protection rating: IK10 according to IEC 62262

Supply:
Height 100 mm: 2 ventilated side panels, 4 corner covers and fixing elements

Characteristics	Height (mm)	Depth (mm)	References
Ventilated side panels for Spacial SF-SM	100	600	NSYSPV6100
Ventilated side panels for Spacial SF-SM	100	800	NSYSPV8100

Panels with brush



NSYSPB6100

- They allow the entry and fixing of cables inside the enclosure, through the plinth.
- Material: Folded sheet steel
- Finish: Structured finish, epoxy polyester powder
- Color: RAL 7022 grey
- Ingress protection rating: IP20 according to IEC 60529
- Mechanical protection rating: IK10 according to IEC 62262

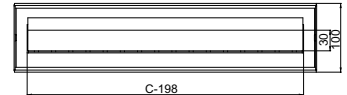

Supply:
Height 100 mm: 2 panels with brushes, 4 corner covers and fixing elements

Characteristics	Height (mm)	Depth (mm)	References
Panels with brush for Spacial SF-SM	100	600	NSYSPB6100
Panels with brush for Spacial SF-SM	100	800	NSYSPB8100



Stainless-steel plinths (standard plinths [page 176](#), ventilated plinths [page 441](#)) are compatible with steel floor-standing enclosure SM and SF using an earthing cable reference **NSYEL226D13** (description [page 323](#)) to be ordered separately.

Fixing to the floor

3



NSYSGF

- Part for fixing the plinth to the floor if the drillholes made in the plinth cannot be used.
- Material: Steel
- Finish: Zinc-coated

Characteristics

Spacial SF-Fixing to the floor

References

NSYSGF

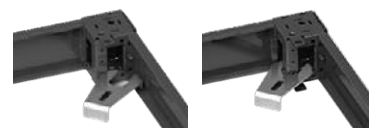

Supply:

4 pieces, fixing element not supplied

Fixing to the floor by fixing points of previous version (OLN/CMO or Spacial 6000 and 18500)



NSYOL6GF

- Parts that reproduce the floor-fixing points of the previous plinth.
- Material: Steel
- Finish: Zinc-coated

Characteristics

Fixing to the floor by fixing points of previous version

References

NSYOL6GF

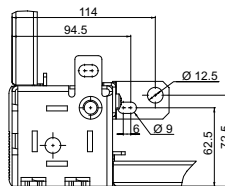

Supply:

4 pieces, fixing elements not supplied

Plinth cross-rail support



NSYSPCR

- Support for fixing a cross-rail inside the plinth.
- Material: Steel
- Finish: Zinc-coated

Characteristics

Spacial SF-Plinth cross-rail support, 100 mm

References

NSYSPCR



Comment:

Reference by unit Order by multiples of 12 (12, 24, 36...)

Supply:

12 pieces and fixing elements

Plinth cross-rails

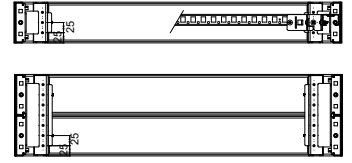

Supply:
2 cross-rails and fixing elements

- They are fixed across the width and/or depth between the corners of the plinth.
- The plinth cross-rail supports are required for its assembly.
- Material: Steel
- Finish: Zinc-coated



NSYSUCR4030

Characteristics	Cross-rails	Width (mm)	Depth (mm)	References
Plinth cross-rails for Spacial SF-SM	1 row (40)	400	-	NSYSUCR4030
Plinth cross-rails for Spacial SF-SM	1 row (40)	600	-	NSYSUCR4050
Plinth cross-rails for Spacial SF-SM	1 row (40)	800	-	NSYSUCR4070
Plinth cross-rails for Spacial SF-SM	1 row (40)	1000	-	NSYSUCR4090
Plinth cross-rails for Spacial SF-SM	1 row (40)	1200	-	NSYSUCR40110
Plinth cross-rails for Spacial SF-SM	3 row (90)	400	-	NSYSUCR9030
Plinth cross-rails for Spacial SF-SM	3 row (90)	600	-	NSYSUCR9050
Plinth cross-rails for Spacial SF-SM	3 row (90)	800	-	NSYSUCR9070
Plinth cross-rails for Spacial SF-SM	3 row (90)	1000	-	NSYSUCR9090
Plinth cross-rails for Spacial SF-SM	3 row (90)	1200	-	NSYSUCR90110
Plinth cross-rails for Spacial SF-SM	1 row (40)	-	500	NSYSUCR4040
Plinth cross-rails for Spacial SF-SM	3 row (90)	-	500	NSYSUCR9040

Fixing options, Screw M6

Supply:
50 screws



NSYSPM6

- M6 x 10 mm

Characteristics	References
Screw M6	NSYSPM6

Fixing options, Caged nuts

Supply:
100 caged nuts.



NSYCN9M625

- M6 caged nuts.

Characteristics	References
Caged nuts	NSYCN9M625

Fixing options, Levelling the plinth

- The plinth allows levelling by means of a M12 screw.

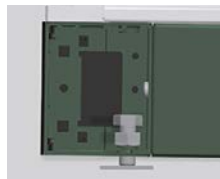

NSYSPLK

Characteristics	References
Levelling the plinth	NSYSPLK

Cable entries

Possibilities of cable gland plate adjustment

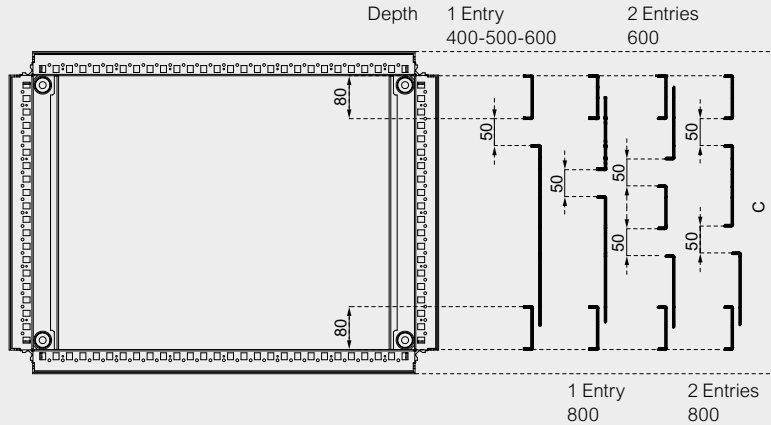

Plain cable gland plate

- The design of the compact cable gland plate, coupled with the use of the sealing gasket **NSYCEK** enable maximum dust/water tightness.
- Material: Steel painted with epoxy polyester resin
- Color: RAL 7035 grey
- Thicknesses: 10/10° mm

Supply:
Plain plate and fixing elements

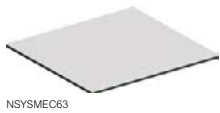

NSYSMEC63

Characteristics	Width (mm)	Depth (mm)	References
Spacial SM Plain cable gland plate	600	300	NSYSMEC63
Spacial SM Plain cable gland plate	600	400	NSYSMEC64
Spacial SM Plain cable gland plate	600	500	NSYSMEC65
Spacial SM Plain cable gland plate	600	600	NSYSMEC66
Spacial SM Plain cable gland plate	800	300	NSYSMEC83
Spacial SM Plain cable gland plate	800	400	NSYSMEC84
Spacial SM Plain cable gland plate	800	500	NSYSMEC85
Spacial SM Plain cable gland plate	800	600	NSYSMEC86
Spacial SM Plain cable gland plate	1000	300	NSYSMEC103
Spacial SM Plain cable gland plate	1000	400	NSYSMEC104
Spacial SM Plain cable gland plate	1000	500	NSYSMEC105
Spacial SM Plain cable gland plate	1200	300	2x NSYSMEC63
Spacial SM Plain cable gland plate	1200	400	2x NSYSMEC64
Spacial SM Plain cable gland plate	1200	500	2x NSYSMEC65
Spacial SM Plain cable gland plate	1200	600	2x NSYSMEC66
Spacial SM Plain cable gland plate	1600	400	2x NSYSMEC84
Spacial SM Plain cable gland plate	1600	500	2x NSYSMEC85
Spacial SM Plain cable gland plate	1600	600	2x NSYSMEC86

Plain cable gland plate

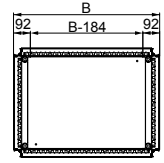

3

- The design of the compact cable gland plate, coupled with the use of the sealing gasket **NSYCEK** enable maximum dust/water tightness.
- Material: Galvanized steel
- Thicknesses: 15/10° mm

Supply:
Plain plate and fixing elements



Characteristics	(B) Width (mm)	(C) Depth (mm)	References
Spacial SF Plain cable gland plate	300	500	NSYEC35
Spacial SF Plain cable gland plate	300	600	NSYEC36
Spacial SF Plain cable gland plate	400	400	NSYEC44
Spacial SF Plain cable gland plate	400	500	NSYEC45
Spacial SF Plain cable gland plate	400	600	NSYEC64
Spacial SF Plain cable gland plate	400	800	NSYEC84
Spacial SF Plain cable gland plate	600	400	NSYEC64
Spacial SF Plain cable gland plate	600	500	NSYEC65
Spacial SF Plain cable gland plate	600	600	NSYEC66
Spacial SF Plain cable gland plate	600	800	NSYEC68
Spacial SF Plain cable gland plate	800	400	NSYEC84
Spacial SF Plain cable gland plate	800	500	NSYEC85
Spacial SF Plain cable gland plate	800	600	NSYEC86
Spacial SF Plain cable gland plate	800	800	NSYEC88
Spacial SF Plain cable gland plate	1000	400	NSYEC104
Spacial SF Plain cable gland plate	1000	500	NSYEC105
Spacial SF Plain cable gland plate	1000	600	NSYEC106
Spacial SF Plain cable gland plate	1000	800	NSYEC108
Spacial SF Plain cable gland plate	1200	400	NSYEC124
Spacial SF Plain cable gland plate	1200	500	NSYEC125
Spacial SF Plain cable gland plate	1200	600	NSYEC126
Spacial SF Plain cable gland plate	1200	800	NSYEC128
Spacial SF Plain cable gland plate	1600	400	NSYEC164
Spacial SF Plain cable gland plate	1600	500	NSYEC165
Spacial SF Plain cable gland plate	1600	600	NSYEC166

Plate with 1 entry

3

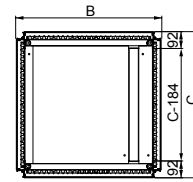

Enclosures of 300 and 400 mm width.

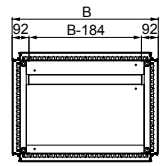

Enclosures of 600, 800, 1000 and 1200 mm width.

- Facilitates the entry of cables thanks to a longitudinal opening.
- Material: Galvanized steel
- Thicknesses: 15/10° mm

Supply:

Plate with 1 entry; Self-extinguishing polyurethane adhesive gasket with cross-section of 15 x 25 mm (helps guarantee good sealing) and fixing elements



NSYEC351

Characteristics	(B) Width (mm)	(C) Depth (mm)	References
Spacial SF Plate with 1 entry	300	500	NSYEC351
Spacial SF Plate with 1 entry	300	600	NSYEC361
Spacial SF Plate with 1 entry	400	400	NSYEC441
Spacial SF Plate with 1 entry	400	500	NSYEC451
Spacial SF Plate with 1 entry	400	600	NSYEC461
Spacial SF Plate with 1 entry	400	800	NSYEC481
Spacial SF Plate with 1 entry	600	400	NSYEC641
Spacial SF Plate with 1 entry	600	500	NSYEC651
Spacial SF Plate with 1 entry	600	600	NSYEC661
Spacial SF Plate with 1 entry	600	800	NSYEC681
Spacial SF Plate with 1 entry	800	400	NSYEC841
Spacial SF Plate with 1 entry	800	500	NSYEC851
Spacial SF Plate with 1 entry	800	600	NSYEC861
Spacial SF Plate with 1 entry	800	800	NSYEC881
Spacial SF Plate with 1 entry	1000	400	NSYEC1041
Spacial SF Plate with 1 entry	1000	500	NSYEC1051
Spacial SF Plate with 1 entry	1000	600	NSYEC1061
Spacial SF Plate with 1 entry	1000	800	NSYEC1081
Spacial SF Plate with 1 entry	1200	400	NSYEC1241
Spacial SF Plate with 1 entry	1200	500	NSYEC1251
Spacial SF Plate with 1 entry	1200	600	NSYEC1261
Spacial SF Plate with 1 entry	1200	800	NSYEC1281
Spacial SF Plate with 1 entry	1600	400	NSYEC1641
Spacial SF Plate with 1 entry	1600	500	NSYEC1651
Spacial SF Plate with 1 entry	1600	600	NSYEC1661

Plate with 2 entries

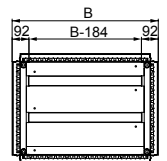

- Cable entry for very deep enclosures (600 and 800 mm).
- Two longitudinal openings allowing a large number of cables through.
- Material: Galvanized steel
- Thicknesses: 15/10° mm

Supply:

1 plate with 2 entries; Polyurethane adhesive gasket with cross-section of 15 x 25 mm (helps guarantee good sealing) and fixing elements



NSYEC662

Characteristics	(B) Width (mm)	(C) Depth (mm)	References
Spacial SF Plate with 2 entries	400	600	NSYEC462
Spacial SF Plate with 2 entries	400	800	NSYEC482
Spacial SF Plate with 2 entries	600	600	NSYEC662
Spacial SF Plate with 2 entries	600	800	NSYEC682
Spacial SF Plate with 2 entries	800	600	NSYEC862
Spacial SF Plate with 2 entries	800	800	NSYEC882
Spacial SF Plate with 2 entries	1000	600	NSYEC1062
Spacial SF Plate with 2 entries	1000	800	NSYEC1082
Spacial SF Plate with 2 entries	1200	600	NSYEC1262
Spacial SF Plate with 2 entries	1200	800	NSYEC1282
Spacial SF Plate with 2 entries	1600	600	NSYEC1662

SF Cable gland plate for connectors

- Adapter plate to install cable entry plates for connectors, see [page 305](#).
- To be used together with cable gland plates, 1 or 2 entries, adding or replacing one of the parts.
- Material: Galvanized steel
- Thicknesses: 15/10° mm

Supply:
Plate and fixing elements

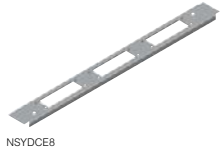

Characteristics	No. of cuts	Width (mm)	References
Spacial SF Cable gland plate for connectors	2	600	NSYDCE6
Spacial SF Cable gland plate for connectors	3	800	NSYDCE8
Spacial SF Cable gland plate for connectors	4	1000	NSYDCE10
Spacial SF Cable gland plate for connectors	2	1200	NSYDCE12

SF Brush-type cable entry gasket

- For plates with 1 or 2 cable entries.
- The cables can have different diameters.
- No IP degree of protection



Characteristics	Width (mm)	References
Spacial SF Brush-type cable entry gasket	400	NSYBCE4
Spacial SF Brush-type cable entry gasket	600	NSYBCE6
Spacial SF Brush-type cable entry gasket	800	NSYBCE8
Spacial SF Brush-type cable entry gasket	1000	NSYBCE10
Spacial SF Brush-type cable entry gasket	1200	NSYBCE12
Spacial SF Brush-type cable entry gasket	1600	NSYBCE16

SM Brush-type cable entry gasket

- Brush-type gasket for installation on the cable gland plates.
- The cables can have different diameters.
- No IP degree of protection

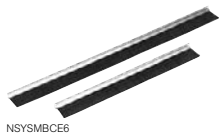

Characteristics	Width (mm)	References
Spacial SM-Brush-type cable entry gasket	600	NSYSMBCE6
Spacial SM-Brush-type cable entry gasket	800	NSYSMBCE8
Spacial SM-Brush-type cable entry gasket	1000	NSYSMBCE10
Spacial SM-Brush-type cable entry gasket	1200	2x NSYSMBCE6
Spacial SM-Brush-type cable entry gasket	1600	2x NSYSMBCE8

SF Foam cable entry gasket

- Spare gasket, made from self-extinguishing expanded polyurethane with a cross-section of 15 x 25 mm, for fixing on cable gland plates.



Characteristics	References
Spacial SF Foam cable entry gasket	NSYCEJ

SF Sealing gasket

- Sealing gasket, made from ethylene-propylene with a cross-section of 3 x 10 mm, for mounting on the perimeter of the cable gland plates. Adhesive to help guarantee good sealing.



Characteristics	References
Spacial SF Sealing gasket	NSYCEK

Lifting systems

SF Eyebolts

3



- Set of M12 lifting eyebolts, which screw directly into the structure of the enclosure, in the axis of the uprights.
- Material: Galvanized cast steel
- Maximum load: 340 kg
- Maximum amount of assembled enclosures to be lifted: 1

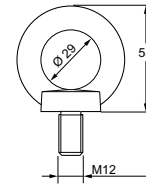

Supply:
4 eyebolts

Characteristics	Enclosures to be lifted	Max. load (kg)	References
Spacial SF Eyebolts	1	340	NSYSFEB

SM Eyebolts



- Set of M12 lifting eyebolts, fixed to the enclosure by fixing nuts.
- Material: Galvanized cast steel
- Maximum load: 340 kg
- Maximum amount of assembled enclosures to be lifted: 1

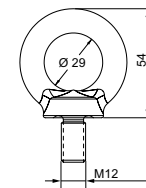

Supply:
4 eyebolts and
4 fixing nuts

Characteristics	Enclosures to be lifted	Max. load (kg)	References
Spacial SM Eyebolts	1	340	NSYSMEB

SF Lifting brackets



- Set of lifting and transport brackets, fixed to the structure between two coupled enclosures, in the axis of the uprights.
- Material: Zinc-coated steel
- Maximum load: 500 kg
- Maximum amount of assembled enclosures to be lifted: 2

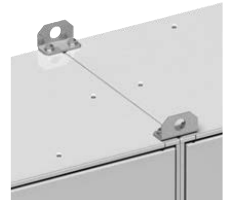
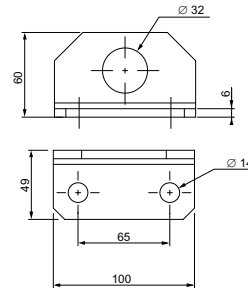

Supply:
4 brackets and fixing elements (M12 screws)

Characteristics	Enclosures to be lifted	Max. load (kg)	References
Spacial SF Lifting brackets	2	500	NSYSFELB

SF Lifting bar



- Set of bars for lifting and transporting enclosures suites.
- They are fixed to the structure of the enclosure, in the axis of the uprights.
- Material: Steel

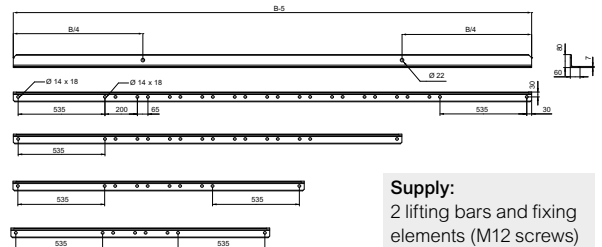

Supply:
2 lifting bars and fixing elements (M12 screws)

Characteristics	Length (mm)	Enclosures to be lifted	Max. load (kg)	References
Spacial SF Lifting bar	1600	2	2000	NSYSFTB16
Spacial SF Lifting bar	1800	3	3000	NSYSFTB18
Spacial SF Lifting bar	2400	4	3000	NSYSFTB24
Spacial SF Lifting bar	3200	5	4000	NSYSFTB32

Roof Canopy

- Provides excellent protection against splashes from rainwater.
- Canopy cannot be used together with lifting fixtures.
- Spacial SF: It is possible to use a single canopy with combinations of modular enclosures (example: one 1600-mm canopy with two coupled 800-mm enclosures).
- Material: Galvanized steel
- Finish: Structured finish, epoxy polyester powder
- Color: RAL 7035 grey

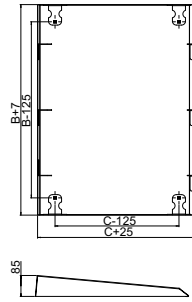

Fixing:
 Spacial SF: Fixing by drill holes to be made in the roof of the enclosure
 Spacial SM: Fixing by drill holes already made in the roof

Supply:
 One canopy, drilling template and fixing elements



NSYSC630

Characteristics	(B) Width (mm)	(C) Depth (mm)	References
Spacial SF/SM Canopy	600	300	NSYSC630
Spacial SF/SM Canopy	600	400	NSYSC640
Spacial SF/SM Canopy	600	500	NSYSC650
Spacial SF/SM Canopy	600	600	NSYSC660
Spacial SF/SM Canopy	800	300	NSYSC830
Spacial SF/SM Canopy	800	400	NSYSC840
Spacial SF/SM Canopy	800	500	NSYSC850
Spacial SF/SM Canopy	800	600	NSYSC860
Spacial SF/SM Canopy	1000	300	NSYSC1030
Spacial SF/SM Canopy	1000	400	NSYSC1040
Spacial SF/SM Canopy	1000	500	NSYSC1050
Spacial SF/SM Canopy	1000	600	NSYSC1060
Spacial SF/SM Canopy	1200	300	NSYSC1230
Spacial SF/SM Canopy	1200	400	NSYSC1240
Spacial SF/SM Canopy	1200	500	NSYSC1250
Spacial SF/SM Canopy	1200	600	NSYSC1260
Spacial SF/SM Canopy	1600	400	NSYSC1640
Spacial SF/SM Canopy	1600	500	NSYSC1650
Spacial SF/SM Canopy	1600	600	NSYSC1660
Spacial SF/SM Canopy	1800	500	NSYSC1850
Spacial SF/SM Canopy	1800	600	NSYSC1860
Spacial SF/SM Canopy	2000	500	NSYSC2050
Spacial SF/SM Canopy	2000	600	NSYSC2060
Spacial SF/SM Canopy	2400	500	NSYSC2450
Spacial SF/SM Canopy	2400	600	NSYSC2460

Ventilated roof

3

- Roof providing natural airing for the enclosure, with IP30 protection.
- Height: An extra 63 mm in relation to the structure.
- Material: Steel
- Finish: Structured finish, epoxy polyester powder
- Color: RAL 7035 grey
- Fixing: They are screwed onto the structure at the roof fixing point

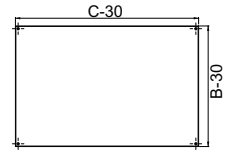
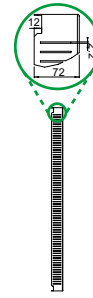

Supply:
One ventilated roof and four elevators



Characteristics	(B) Width (mm)	(C) Depth (mm)	References
Spacial SF Ventilated roof	600	600	NSYSVR606
Spacial SF Ventilated roof	600	800	NSYSVR608
Spacial SF Ventilated roof	800	600	NSYSVR806
Spacial SF Ventilated roof	800	800	NSYSVR808

Airing elevators for roof

- Allows the roof to be raised, providing natural airing.
- They are screwed onto the structure at the roof fixing point.
- Material: Zinc-coated steel

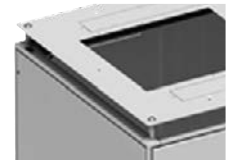
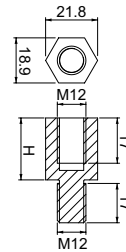

Supply:
4 elevators



Characteristics	(H) Height (mm)	IP	References
Spacial SF Airing elevators for roof	23	10	NSYRE26
Spacial SF Airing elevators for roof	60	00	NSYRE60

FL21 cable entry membranes

- Membrane plate for watertight cable entries made from insulated material (fireresistance level UL 94 V-0).
- Direct installation in the FL21 cable entry plate adapter.
- 4 models: Plain plate and membrane plates from 7 to 37 cable entries.
- Material: Grey plastic
- Ingress protection rating: IP66 according to IEC 60529

Comment:
For more information see [page 305](#)

Supply:
Membrane plate and fixing elements.



NSYAECPFLT25

Characteristics	No. of entries	References
FL21 plain metal plate	0	NSYAECPFLBP
FL21 cable entry membranes	7	NSYAECPFLT7
FL21 cable entry membranes	27	NSYAECPFLT25
FL21 cable entry membranes	37	NSYAECPFLT35

Standard cable entry plate

- Thickness: 15/10^ø mm

Comment:
For more information see [page 305](#)



NSYTLC

Characteristics	References
Standard cable entry plate	NSYTLC

Aluminum cable entry plate

- Thickness: 30/10^ø mm



NSYTLCU

Characteristics	References
Aluminum cable entry plate	NSYTLCU

FlexiCable

Characteristics	References
FlexiCable	NSYTLCME

Adapter for FL21 cable entry plate

- Thickness: 15/10^ø mm

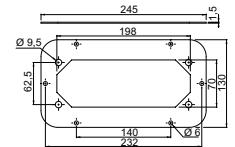

Characteristics	References
Adapter for FL21 cable entry plate	NSYTLCFL

Wall fixing

SF Wall fixing support

3

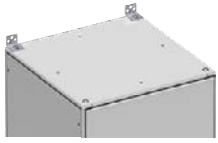

NSYSFWFIX

- Supports for fixing the enclosure on the wall and helping prevent it from turning over.
- They cannot be used for hanging the enclosure.
- They are installed using the roof mounting screws.
- Material: Zinc-coated steel sheet

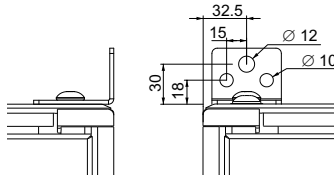

Supply:
2 supports

Characteristics

Spacial SF Wall fixing support

References

NSYSFWFIX

SM Wall fixing support



NSYSMWFIX

- Supports for fixing the enclosure on the wall and helping prevent it from turning over.
- They are installed using the drill holes in the back of the enclosure.
- Mounted directly on the rear of the enclosure, either in horizontal or vertical position
- Material: Zinc-coated steel sheet

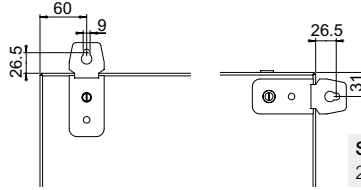

Supply:
2 supports

Characteristics

Spacial SM Wall fixing support

References

NSYSMWFIX

Doors **SF** **SM**

Inner door



NSYID166

- Door for additional protection. Prevents the switchgear from being manipulated by unauthorised personnel.
- Allows the installation of switchgear mounted directly on the door.
- Mounting on the top and bottom frame of the enclosure.
- Depth adjustable with a pitch of 25 mm, from the first fixing point.
- Opening to right or left, with two locks, 3-mm double-bar, with central handle.
- Reinforcement frames on the rear, cut-outs with a 25 mm pitch, for equipping the door.
- Maximum acceptable load: 15 kg.
- Inner doors can be mounted in our stainless-steel floor-standing enclosures (SFX and SMX).
- Material: Steel
- Finish: Structured finish, epoxy polyester powder
- Color: RAL 7035 grey

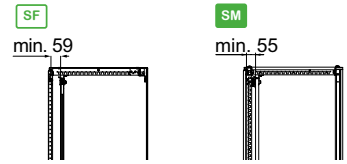

Comment:
For dimensions see [page 19](#)

Supply:
One inner door and fixing elements



NSYID166

Characteristics	Height (mm)	Width (mm)	References
Spacial SF/SM Inner door	1600	600	NSYID166
Spacial SF/SM Inner door	1600	800	NSYID168
Spacial SF/SM Inner door	1800	600	NSYID186
Spacial SF/SM Inner door	1800	800	NSYID188
Spacial SF/SM Inner door	1800	1000	NSYID1810
Spacial SF/SM Inner door	2000	600	NSYID206
Spacial SF/SM Inner door	2000	800	NSYID208
Spacial SF/SM Inner door	2000	1000	NSYID2010
Spacial SF/SM Inner door	2200	600	NSYID226
Spacial SF/SM Inner door	2200	800	NSYID228

SF Side Door



NSYSFD126

- Door for all sides of the enclosure, replaces the side panel.
- Installation directly on the structure of the enclosure, opening 120°.
- Lock with handle and 5-mm double-bar insert.
- 4 locking points.
- Reinforcement frame, cut-out with a pitch of 25 mm.
- Opening to right or left.
- Material: Steel
- Finish: Structured finish, epoxy polyester powder
- Color: RAL 7035 grey

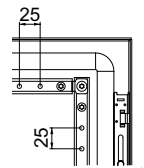

Comment:
For dimensions see [page 22](#)

Supply:
One side door, four hinges, four catches and handle lock

Characteristics	Height (mm)	Width (mm)	References
Spacial SF Side door	1200	600	NSYSFD126
Spacial SF Side door	1200	800	NSYSFD128
Spacial SF Side door	1400	600	NSYSFD146
Spacial SF Side door	1400	800	NSYSFD148
Spacial SF Side door	1600	600	NSYSFD166
Spacial SF Side door	1600	800	NSYSFD168
Spacial SF Side door	1800	400	NSYSFD184
Spacial SF Side door	1800	500	NSYSFD185
Spacial SF Side door	1800	600	NSYSFD186
Spacial SF Side door	1800	800	NSYSFD188
Spacial SF Side door	2000	300	NSYSFD203
Spacial SF Side door	2000	400	NSYSFD204
Spacial SF Side door	2000	500	NSYSFD205
Spacial SF Side door	2000	600	NSYSFD206
Spacial SF Side door	2000	700	NSYSFD207
Spacial SF Side door	2000	800	NSYSFD208
Spacial SF Side door	2200	400	NSYSFD224
Spacial SF Side door	2200	500	NSYSFD225
Spacial SF Side door	2200	600	NSYSFD226
Spacial SF Side door	2200	800	NSYSFD228

Partial doors

Front fix panel for modularity

- Top and bottom fix panel to obtain modularity required to install partial doors.
- It is needed to purchase **NSYMIC6** and **NSYMIC8**.
- Height 100 mm fixed panels are delivered as standard for the compartmentalised enclosure, Spacial SFM.
- Option to order it separately for Spacial SF framework in kit supply.
- Available in 2 heights (mm).
- Ingress protection rating: IP54 according to IEC 60529



NSYMFP2M6

Characteristics	Height (mm)	Width (mm)	References
Spacial SFM - Front Fix panel for modularity	100	600	NSYMFP2M6
Spacial SFM - Front Fix panel for modularity	250	600	NSYMFP5M6
Spacial SFM - Front Fix panel for modularity	100	800	NSYMFP2M8
Spacial SFM - Front Fix panel for modularity	250	800	NSYMFP5M8

Frontal partial doors

- Plain partial door with lock 5-mm double-bar insert.
- They are fixed to the uprights of the framework by means of hinges.
- Drilling template for uprights ref. **NSYMDT** (only one drilling template required per order).
- Opening to right or left.
- 1, 2 or 4 locking points depending on height.
- Option to replace locking insert.
- Available in following heights (mm).
- Ingress protection rating: IP54 according to IEC 60529



NSYMPD3M6

Characteristics	Height (mm)	Width (mm)	References
Spacial SFM Frontal partial door	150	600	NSYMPD3M6
Spacial SFM Frontal partial door	200	600	NSYMPD4M6
Spacial SFM Frontal partial door	250	600	NSYMPD5M6
Spacial SFM Frontal partial door	300	600	NSYMPD6M6
Spacial SFM Frontal partial door	400	600	NSYMPD8M6
Spacial SFM Frontal partial door	450	600	NSYMPD9M6
Spacial SFM Frontal partial door	600	600	NSYMPD12M6
Spacial SFM Frontal partial door	800	600	NSYMPD16M6
Spacial SFM Frontal partial door	900	600	NSYMPD18M6
Spacial SFM Frontal partial door	1000	600	NSYMPD20M6
Spacial SFM Frontal partial door	1200	600	NSYMPD24M6
Spacial SFM Frontal partial door	150	800	NSYMPD3M8
Spacial SFM Frontal partial door	200	800	NSYMPD4M8
Spacial SFM Frontal partial door	250	800	NSYMPD5M8
Spacial SFM Frontal partial door	300	800	NSYMPD6M8
Spacial SFM Frontal partial door	400	800	NSYMPD8M8
Spacial SFM Frontal partial door	450	800	NSYMPD9M8
Spacial SFM Frontal partial door	600	800	NSYMPD12M8
Spacial SFM Frontal partial door	800	800	NSYMPD16M8
Spacial SFM Frontal partial door	900	800	NSYMPD18M8
Spacial SFM Frontal partial door	1000	800	NSYMPD20M8
Spacial SFM Frontal partial door	1200	800	NSYMPD24M8

Frontal transparent partial doors

- Glazed (Securit glass) partial door with lock 5-mm double-bar insert.
- They are fixed to the uprights of the framework by means of hinges.
- Opening to right or left.
- 1 or 2 locking points according different heights.
- Available in following heights (mm).
- Ingress protection rating: IP54 according to IEC 60529



NSYMPD26T

Characteristics	Height (mm)	Width (mm)	References
Spacial SFM Frontal Transparent partial doors	200	600	NSYMPD26T
Spacial SFM Frontal Transparent partial doors	400	600	NSYMPD46T
Spacial SFM Frontal Transparent partial doors	600	600	NSYMPD66T
Spacial SFM Frontal Transparent partial doors	800	600	NSYMPD86T
Spacial SFM Frontal Transparent partial doors	1000	600	NSYMPD106T
Spacial SFM Frontal Transparent partial doors	200	800	NSYMPD28T
Spacial SFM Frontal Transparent partial doors	400	800	NSYMPD48T
Spacial SFM Frontal Transparent partial doors	600	800	NSYMPD68T
Spacial SFM Frontal Transparent partial doors	800	800	NSYMPD88T
Spacial SFM Frontal Transparent partial doors	1000	800	NSYMPD108T

Intermediate crossbar



- Mounted between partial doors or between doors and control desk, guaranteeing IP54 according to IEC 60529.
- Crossbar with direct fixing to the structure.
- Available in 2 widths (mm).



Supply:
2 crossbars with fixing elements.

Characteristics	Width (mm)	References
Spacial SF-Intermediate Crossbar	600	NSYMIC6
Spacial SF-Intermediate Crossbar	800	NSYMIC8

Folding panel



- Height 300 mm horizontal panel, hinged at the top.
- Helps guarantee protection of the sets of bars.
- Opening angle: 110°.
- It is installed together with partial doors to create the modularity of the enclosure.
- 2 locking points, 5-mm double-bar insert.
- Available in 2 widths (mm).

Characteristics	Width (mm)	References
Spacial SF Folding panel	600	NSYCDP36
Spacial SF Folding panel	800	NSYCDP38

Control desk



- Support for human-machine interface.
- Height 400 mm Control desk is installed together with partial doors to create the modularity of the enclosure.
- 2 locking points, 5-mm double-bar insert.
- Available in 2 widths (mm).

Characteristics	Width (mm)	References
Spacial SF Control desk	600	NSYCOD264
Spacial SF Control desk	800	NSYCOD284

Metal document pocket



- Direct mounting on the reinforcement frame of the door.
- Adjustable depth with a pitch of 25 mm.
- Material: Steel
- Finish: Structured finish, epoxy polyester powder
- Color: RAL 7035 grey

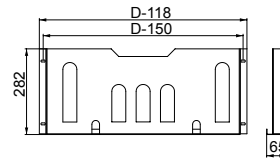

Supply:
1 metal document pocket and fixing elements

Characteristics	(D) Width (mm)	References
Spacial SF/SM Metal document pocket	600	NSYDPM6M
Spacial SF/SM Metal document pocket	800	NSYDPM8M

Plastic document pocket



- Attachment by adhesive tape.
- Material: Polystyrene (PS)
- Color: RAL 7035 grey (**NSYDPA4**: RAL 9001)

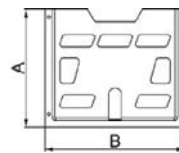

Comment:
NSYDPA44 not compatible with 19" chassis or modular distribution.

Supply:
1 plastic document pocket

Characteristics	Doc. format	A (mm)	B (mm)	C (mm)	References
Spacial SF/SM Plastic document pocket	A5	174	188	22	NSYDPA5
Spacial SF/SM Plastic document pocket	A4	230	247	23	NSYDPA4
Spacial SF/SM Plastic document pocket	A4	234	278	40	NSYDPA44
Spacial SF/SM Plastic document pocket	A3	285	476	35	NSYDPA3

3

Folding support tray



NSYSDT5

- Adjustable horizontal support for laptop computers, documents or any other element.
- Installation on the reinforcement frame of the door.
- Can also be installed on the door cross-rails, see [page 319](#).
- 4 positions: 45°, 60°, 75° and 90°.
- Maximum load: 30 kg
- Material: Steel
- Finish: Structured finish, epoxy polyester powder
- Color: RAL 7035 grey

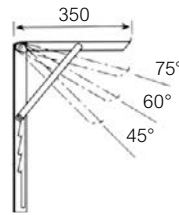

Supply:
1 folding support tray and fixing elements



NSYSDT8

Characteristics	Width of enclosure (mm)	Width of tray (mm)	References
Spacial SF/SM-Folding support tray	500	325	NSYSDT5
Spacial SF/SM-Folding support tray	600	425	NSYSDT6
Spacial SF/SM-Folding support tray	800	625	NSYSDT8

180° hinge

- Hinge with opening of 180°.
- Intended to replace the 120° hinges installed as standard.
- They are compatible with the transparent door and can be installed even with enclosure suites.
- Maximum load: 60 kg on the door
- Material: Aluminum and zamak
- Finish: Painted RAL 9005 black
- UL-certified (cULus):
 - SF: Types 1, 3R, 12 according UL50E
 - SM: Types 1, 2, 3R, 5 and 13 for single-door enclosures



Supply:
4 hinges



NSYSH180NC

Characteristics	References
Spacial SF/SM 180° hinge	NSYSH180NC

Door-centering caster



NSYSDRC

- Allows the door to be raised when closing.
- Direct mounting on the reinforcement frame.
- Maximum load: 90 kg

Supply:
One centering roller and fixing elements

Characteristics	References
Spacial SF/SM Door-centering caster	NSYSDRC

Door switch



NSYDCM20

- The switch is fixed to the structure of the enclosure.
- Drilled M20 cable entry for cable gland.
- NC + NO contact, 240 V AC / 3 A (IEC 60947-5-1)
250 V DC / 0,1 A (IEC 60947-5-1)



Supply:
1 door switch and fixing elements

Characteristics	References
Spacial SF/SFX Door switch	NSYDCM20
Spacial SM Door switch	NSYMDCM20

Locking system Padlock locking



NSYBLKH123

- Padlock locking system, for installation in all the handles of the Spacial SF and Spacial SM enclosures.
- Screw with 7.5 mm drill hole.



Supply:
One cut-out handle, screw for padlock and screw fixing screw

Characteristics	References
Spacial SF/SM Padlock locking	NSYBLKH123

CNOMO kit



NSYCNOH123

- Locking system to be installed on the central locking bar of the door.
- It works as a locking bar immobiliser, helping prevent the handle from closing while the door is still open.
- It is compatible with all handle lock versions, except the flat lock and the small flat lock.



Supply:
One mechanism and fixing elements

Characteristics	References
Spacial SF/SM CNOMO kit	NSYCNOH123

Push-button handle with 3524E key



NSYSFHPB

- Push-button handle with 3524E key for Spacial SF and Spacial SM enclosures.
- Locking and unlocking by key and opening by pushing the insert.
- Handle material: Polyamide 6 with 30% fiberglass
- Color: RAL 9005
- Fire resistant: 650 °C

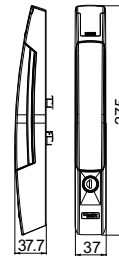

Supply:
Push-button handle, two 3524E keys and fixing elements (insert included)

Characteristics	References
Spacial SF/SM Push-button handle with 3524E key	NSYSFHPB

Handle for shaped inserts and cylindrical barrels



NSYSFHS1

- Easy to change the opening direction of the door, right/left.
- Space reserved for enclosure identification, 21 x 27 mm, protected by a label frame.
- Handle material: Polyamide 6 with 30% fiberglass
- Color: RAL 9005
- Mechanical protection rating: IK10 according to IEC 62262
- Fire resistance: 650 °C

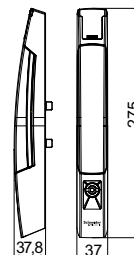

Supply:
Standard handle and fixing elements (insert not included)

Characteristics	References
Spacial SF/SM Handle for shaped inserts and cylindrical barrels	NSYSFHS1

Push-button



NSYINPULS1

Characteristics	References
Push-button	NSYINPULS1

Shape inserts



Characteristics	References
6 mm square insert	NSYINS61
7 mm square insert	NSYINS71
8 mm square insert	NSYINS81
Female 8 mm square insert	NSYINS8G1
6.5 mm triangular insert	NSYINT61
7 mm triangular insert	NSYINT71
8 mm triangular insert	NSYINT81
9 mm triangular insert	NSYINT91
10 mm triangular insert	NSYINT101
3-mm double-bar insert	NSYINDB31
5-mm double-bar insert	NSYINDB51

Cylindrical barrels

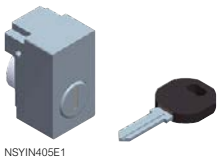

Characteristics	References
405E key lock	NSYIN405E1
421E key lock	NSYIN421E1
455 key lock	NSYIN4551
1242E key lock	NSYIN1242E1
1332E key lock	NSYIN1332E1
2124E key lock	NSYIN2124E1
2131A key lock	NSYIN2131A1
2132A key lock	NSYIN2132A1
2331A key lock	NSYIN2331A1
2433A key lock	NSYIN2433A1
2452E key lock	NSYIN2452E1
3113A key lock	NSYIN3113A1
3122E key lock	NSYIN3122E1
3123A key lock	NSYIN3123A1
3131A1 key lock	NSYIN3131A1
3133A key lock	NSYIN3133A1
3422E key lock	NSYIN3422E1
3432E key lock	NSYIN3432E1
6101 key lock	NSYIN6101
EDF1300 key lock	NSYINF1301
EDF1400 key lock	NSYINF1401
Michelin 8133 keyless lock	NSYINICHEL8131
Michelin 8376 keyless lock	NSYINICHEL8371
E1 keyless lock	NSYINE11

Flat escutcheon lock

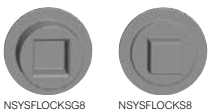

- Optional flat escutcheon lock. Replaces the handle lock.
- Easy to change the opening direction of the door, right/ left.
- Option of changing the turning direction of the insert.
- Handle material: Polyamide 6 with 30% fiberglass
- Color: RAL 9005
- Mechanical protection rating: IK10 according to IEC 62262
- Fire resistance: 650 °C

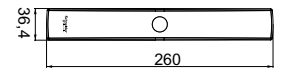

Supply:
Flat lock, shape insert, key and fixing elements

Characteristics	References
Flat lock + screwdriver slot, 2 mm groove	NSYSFLOCK24
Flat lock + 8 mm triangular insert	NSYSFLOCKT8
Flat lock + 7 mm triangular insert	NSYSFLOCKT7
Flat lock + 6.5 mm triangular insert	NSYSFLOCKT6
Flat lock + 8 mm female square insert	NSYSFLOCKSG8
Flat lock + 8 mm square insert	NSYSFLOCKS8
Flat lock + 7 mm square insert	NSYSFLOCKS7
Flat lock + 6 mm square insert	NSYSFLOCKS6
Flat lock + 5-mm double-bar insert	NSYSFLOCKDB5

Technical changes reserved. Information provided without guarantee. Images are for illustrative purposes only.

Handles for insert types DIN, KABA, ASSA, Insert handle



- The inserts are easily and quickly mounted without any screws and allow the installation of profiled DIN, KABA and ASSA locks.
- To install shaped inserts or cylindrical barrels, it is necessary to add adapter ref. **NSYLADP**.
- Easy to change the opening direction of the door, right/left.
- Space reserved for enclosure identification, 21 x 27 mm, protected by a label frame.
- Handle material: Polyamide 6 with 30% fiberglass
- Color: RAL 9005
- Mechanical protection rating: IK10 according to IEC 62262
- Fire resistance: 650 °C

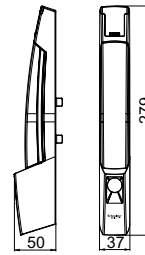

Supply:
One handle for DIN, KABA and ASSA inserts and fixing elements (insert not included)

Characteristics	References
Spacial SF/SM Insert handle	NSYSFHD2

Handles for insert types DIN, KABA, ASSA, double-insert handle



- The double-insert handle can perform the "AND" and "OR" functions (are supplied with the handle).
- "AND" function: One insert blocks the activation of the other insert.
- "OR" function: Either insert can release the handle.
- Easy to change the opening direction of the door, right/left.
- Space reserved for enclosure identification, 21 x 27 mm, protected by a label frame.
- To install shaped inserts or cylindrical barrels, it is necessary to add adapter ref. **NSYLADP**.
- Handle material: Polyamide 6 with 30% fiberglass
- Color: RAL 9005
- Mechanical protection rating: IK10 according to IEC 62262
- Fire resistance: 650 °C

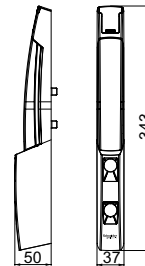

Supply:
One handle for DIN, KABA and ASSA inserts and fixing elements (insert not included)

Characteristics	References
Spacial SF/SM Double-insert handle	NSYSFHD3

Lock system: DIN, KABA and ASSA

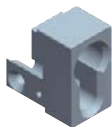

NSYIN1242E2

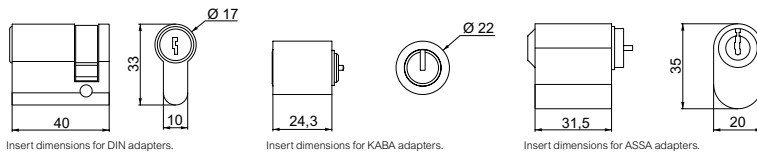

Comment:
NSYINKBA2: Adapter for receiving the KABA8, KABA20 and KABA start cylinders.

Characteristics	References
Spacial SF/SM Adapter for DIN cylinder	NSYINDIN2
Spacial SF/SM Adapter for KABA cylinder	NSYINKBA2
Spacial SF/SM Adapter for ASSA cylinder	NSYINASSA2
Spacial SF/SM 1242E key lock	NSYIN1242E2
Spacial SF/SM Reinforced key lock	NSYINKR2
Spacial SF/SM JIS key lock	NSYINKJIS2
Spacial SF/SM FAC key lock	NSYINKFAC2

Adapter for shaped inserts and cylindrical barrels



NSYLADP

- Plastic adapter for installing shaped inserts and cylindrical barrels in handle lock types DIN, KABA, ASSA.
- See shaped inserts and cylindrical barrels.
- See insert types DIN, KABA, ASSA.

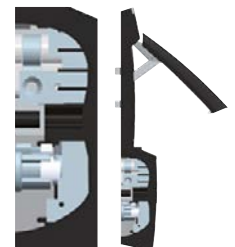

Supply:
1 unit

Characteristics	References
Spacial SF/SM Adapter for shaped inserts and cylindrical barrels	NSYLADP

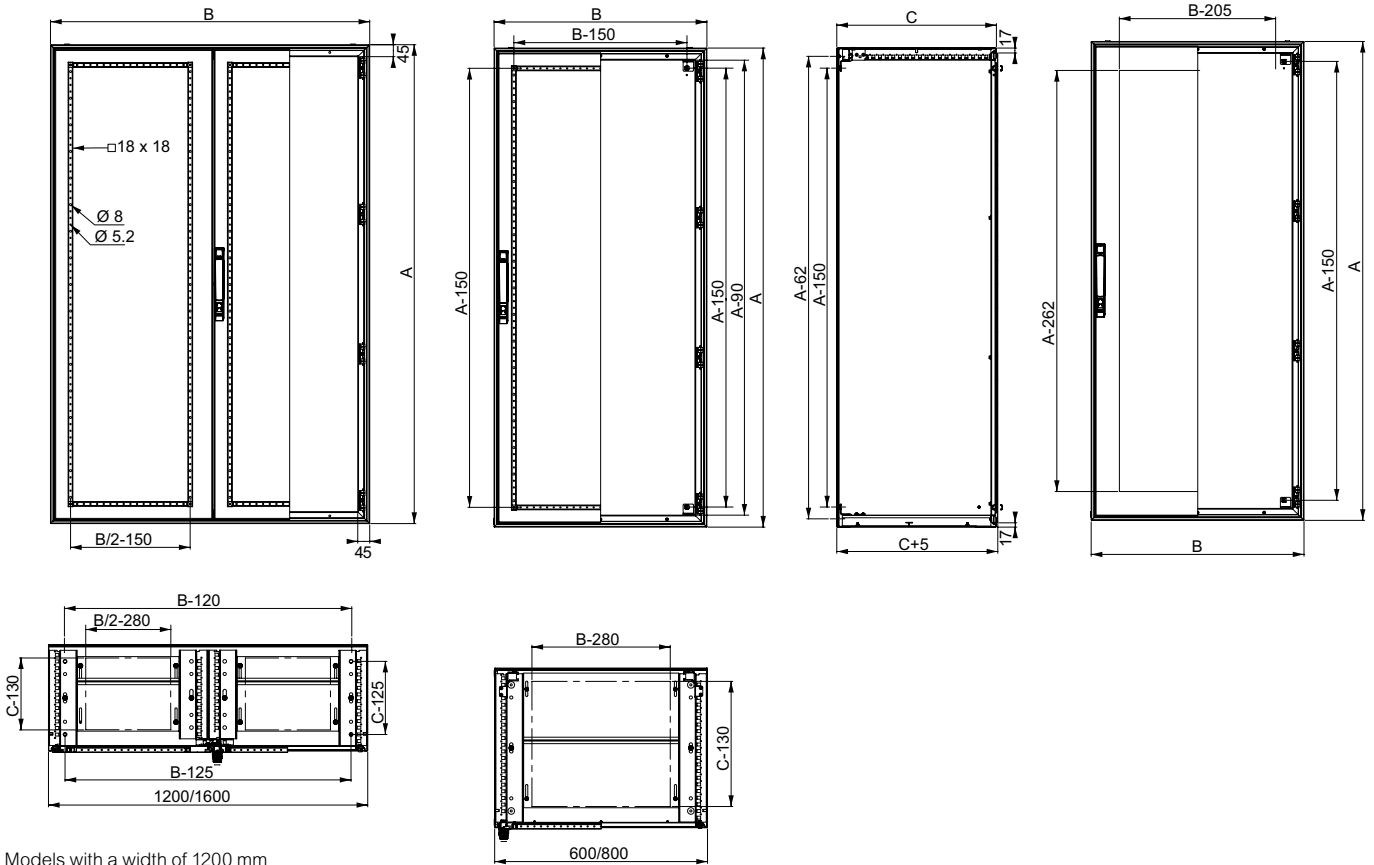

Models with a width of 1200 mm without top/bottom adjustment rails

Inner door

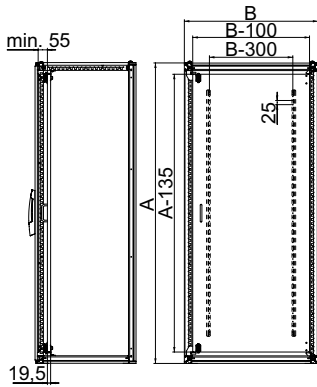

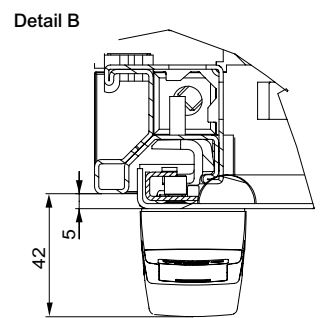
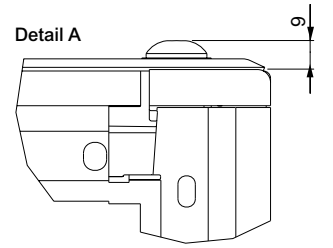
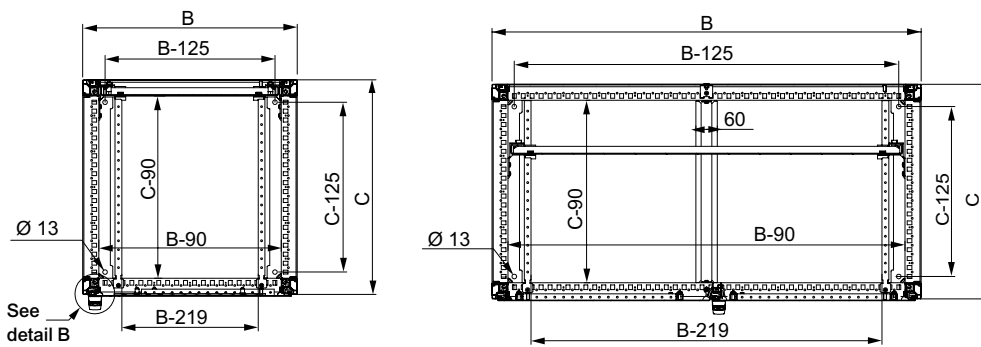
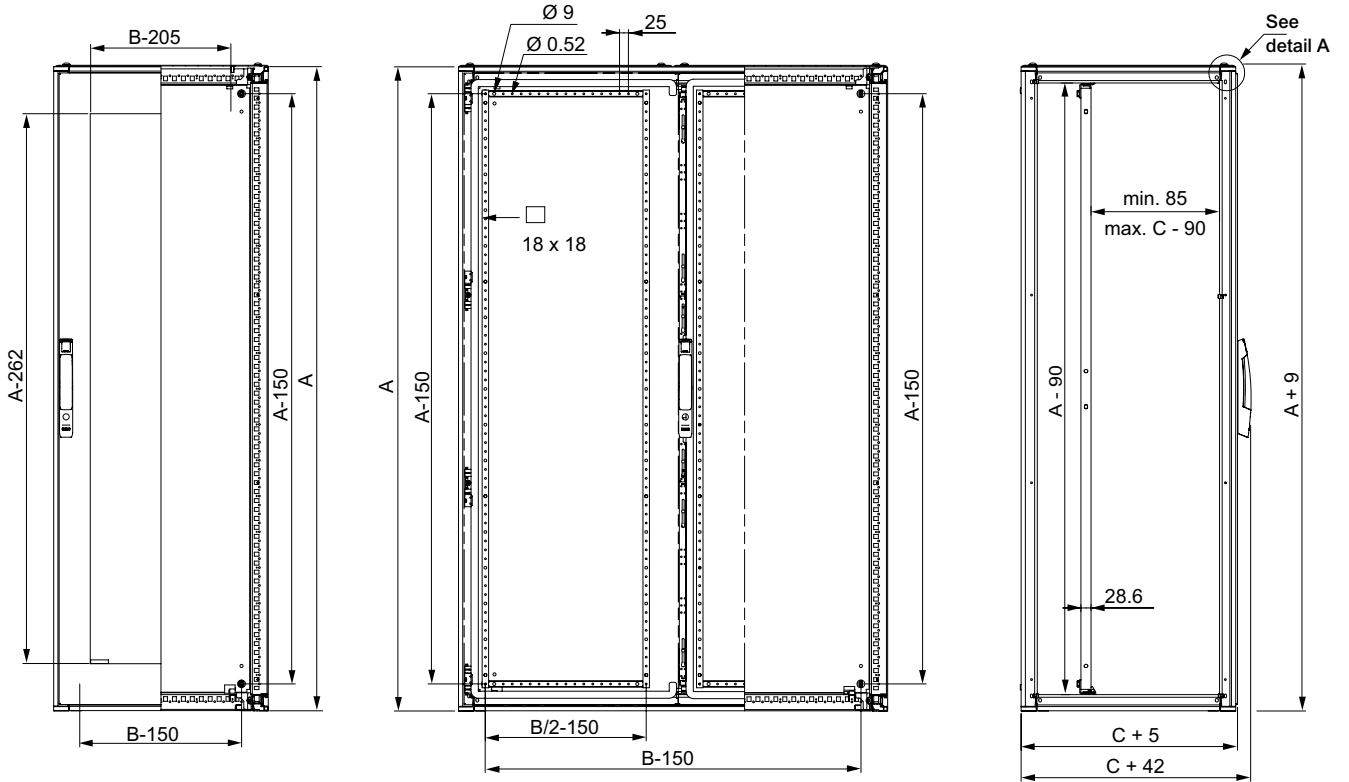

Inner door

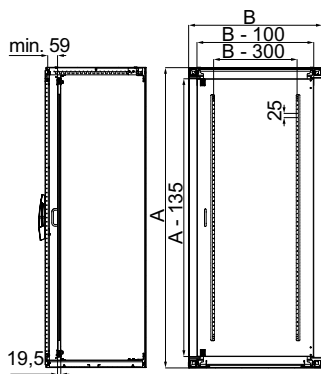

Side door

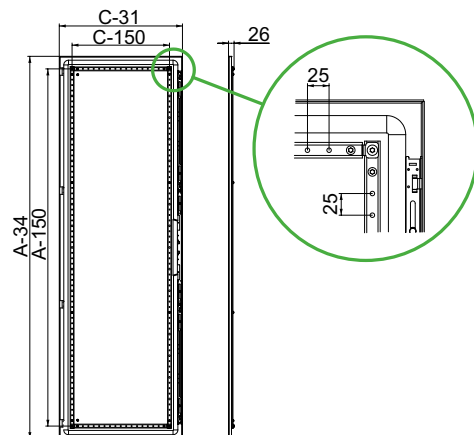

Stainless-Steel Industrial Boxes

Spacial SBX

4



Spacial SBX

Introduction	150
Characteristics	153
Accessories	154
Dimensions	158

What is stainless-steel?

How is the grade of stainless-steel determined?

These enclosures have been specially designed for the chemical, oil and food and beverage industries, among others, which are particularly demanding in terms of hygiene and resistance to corrosion.

Elaborate material composition

The following table shows the percentages of the main alloy elements that make up stainless-steels. The resistance of the material to aggressive agents in the environment depends mainly on these alloys.



4

Choosing a grade

Stainless-steel type		Chemical composition (%)			
AISI grade	N. Europe	Carbon	Chromium	Nickel	Molybdenum
304L	1.4307	< 0.03	17 - 19	8 - 10	0
316L	1.4404	< 0.03	17 - 19	10 - 13	2 - 2.25



AISI 304L stainless-steel

The most commonly used type in the food and beverage industry because of its resistance to corrosion and ease of cleaning.

- Prevention against corrosion, especially in the presence of organic acids.
- Resistance to the effects of nitrous gas in the presence of condensed water and in most aggressive environments.



AISI 316L stainless-steel

Recommended in salty or chlorinated environments because of its very high resistance to corrosion created by molybdenum.

- Improved resistance to corrosion.
- Particularly well adapted to environments with acidity, bromine and saline halides or very corrosive additives and solvents.

The finish

The finish: Three solutions for protection against aggressive substances

Surface condition plays an important role in the fight against bacteria. The lower the roughness, the fewer bacteria become incrustated. Reduced roughness means fewer bacteria, less adhesion, and a finish that's impeccable. The choice of finish determines the appearance of the enclosures that matches the environment of other machines and equipment.



Solution 1: Scotch-Brite® brushing

The method uses brushing as defined by the ASTM (American Society for Testing and Material).

- Finish very commonly used for the chemical and food and beverage industries.
- Surface roughness is improved thanks to an additional polishing process which offers more efficient characteristics against polluting elements.
- Surface roughness: $Ra \leq 0.8 \mu m$.



Solution 2: Micro-beading (on request)

Exclusiveness, an impeccable finish with silky-smooth appearance.

The method:

- Bombardment with miniscule ceramic balls of the entire surface to be treated at very high speed.
- Closes micro-cracks caused during lamination by flattening the surface.

The result:

- Increased hardness.
- Reduced surface roughness: $Ra \approx 0.8 \mu m$.
- A perfectly even surface, with a silky appearance (no scratches and no burrs).
- Reduces the adhesion of materials.
- Allows disinfection.
- Typical application: Pharmaceutical and food and beverage industries.

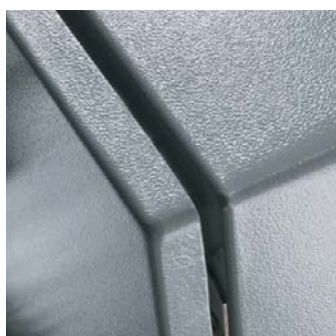

Solution 3: Protective painting (on request)

The highest protection against aggressive substances, external pollution and projections of metal particles.

- Provides ultimate protection against corrosion.
- Typical applications: Marine, seaside, off-shore.

Simplicity, ergonomics and quality.

4



Save Time



Get the Best
Esthetic



Get a High Quality
Cut-Outs



Customized cut-outs.



- Enclosure delivered with cut-outs so you can focus on your added-value work
- Cut-outs made with an industrial laser machine for a perfect result, burr-free, with high accuracy and minimal machining tolerances
- Scotch-Brite®-brushed
- External surfaces with no scratches



Selection

- 6 sizes
- 80 mm and 120 mm in depth.



Sturdy with high ingress protection

- Thickness of 1.2 mm
- Mechanical protection rating up to IK10.
- Ingress protection rating up to IP66.



Added-value for your work

- Quality and esthetics.
- Same dimensions as steel boxes (SBM range).
- Mounting with versatile external brackets.
- Certification (on request):
UL, Veritas and BVM.



Ergonomics

- Cover opening and accessory mounting with just a screwdriver.

See [page 546](#) for details or consult our web site www.se.com



Characteristics	Spacial SBX Flat box
	<p>Box with plain faces Single-piece body (rectangular structure). Front design incorporating folded gutters. Flat rear. 2 drilled profiles for installing mounting plates and DIN rails, with mounting centers of 12.5 mm. Equipped with 4 half-turn thread screws to ensure maximum watertightness. Polyurethane sealing gasket.</p> <p>Protection of personnel Earthing connection mandatory for all boxes: Spacial SBX Stainless-Steel boxes are equipped with an M6 x 10 mm earthing stud welded on the cover, to be linked with the body for equipotential connection. Earthing braid to be ordered separately (Ø 6.4 mm terminal).</p>
Material	AISI 304L stainless-steel, thickness of 1.2 mm.
Finish	Scotch-Brite® brushed.
Ingress protection rating	IP66
Mechanical protection rating	IK10
Compliance with standards	IEC 62208 and the RoHS directive.
Certifications	<ul style="list-style-type: none"> • UL (cULus), BV, BVM • Rating according UL50E: Types 4, 4X and 13
Installation	<p>Indoor installation Direct wall-mounted (4 x Ø 10 mm holes with sealing plugs to maintain the IP rating) or with the help of fixing lugs installed from the outside (to be ordered separately, see the specific accessory pages). Distance between mounting holes enables the installation of the box in the same locations as many existing enclosures.</p> <p>Outdoor installation Compliant with IEC 62208 regarding type tests specified in §9.12 resistance to ultra-violet (UV) radiation and §9.13 resistance to corrosion. It is always advisable to place the box under shelter to avoid water stagnation on the upper part of the enclosure.</p>
Maximum load capacity	On the body: 50 kg/m ²
Other characteristics	<p>Vibration constraints Specific construction of the Spacial SBX - single-piece body (rectangular structure). The rear is flat without added parts - this helps ensure compliance with certain vibration constraints. The tests were conducted according to the marine application by Bureau Veritas Marine.</p>

Dimensions			Box	Mounting plate	DIN rail	Fixing lugs	Sealing kit
Height (mm)	Width (mm)	Depth (mm)	Supply: 1 piece	Supply: 1 piece	Supply: 10 pieces	Supply: 4 pieces	Supply: 1 piece
			References	References	References	References	References
150	150	80	NSYSBX15158	NSYMM11SB	NSYAMRD15357SB	NSYAEFFFSBX	NSYPPSB
150	300	80	NSYSBX15308	NSYMM13SB	NSYAMRD30357SB		
200	200	80	NSYSBX20208	NSYMM22SB	NSYAMRD20357SB		
200	300	80	NSYSBX20308	NSYMM23SB	NSYAMRD30357SB		
200	400	120	NSYSBX204012	NSYMM24SB	NSYAMRD40357SB		
300	300	120	NSYSBX303012	NSYMM33SB	NSYAMRD30357SB		

Mounting plate

- Material: Galvanized steel
- Installation: Mounting by means of 2* or 4 x Ø 5 mm self-tapping screws, Pozidriv head, ref. **NSYAMFSB**. Mounting plate installation points compatible with many other brands of accessories.

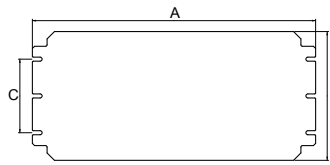

Comment:
* Only 2 screws for mounting plates with height of 150 mm

Supply:
1 unit, supplied without screws

Characteristics	Dimensions		Mounting plate, Dimensions			Thickness (mm)	References
	Height (mm)	Width (mm)	A (mm)	B (mm)	C (mm)		
Mounting plate	150	150	135	135	-	1.5	NSYMM11SB
Mounting plate	150	300	135	285	-	1.5	NSYMM13SB
Mounting plate	200	200	185	185	100	1.5	NSYMM22SB
Mounting plate	200	300	185	285	100	1.5	NSYMM23SB
Mounting plate	200	400	185	385	100	2.0	NSYMM24SB
Mounting plate	300	300	185	185	200	1.5	NSYMM33SB

Symmetrical DIN rails 35 x 7.5 mm

- Material: Galvanized steel
- Installation: Mounting by means of 2 x Ø 5 mm self-tapping screws, Pozidriv head, ref. **NSYAMFSB** (All boxes are delivered with 5 x Ø 5 mm self-tapping screws).

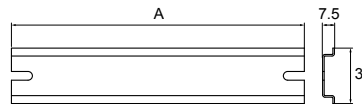

Supply:
10 rails, supplied without screws

Characteristics	Box Width (mm)	DIN rail Length A (mm)	References
Symmetrical DIN rail	150	135	NSYAMRD15357SB
Symmetrical DIN rail	200	185	NSYAMRD20357SB
Symmetrical DIN rail	300	285	NSYAMRD30357SB
Symmetrical DIN rail	400	385	NSYAMRD40357SB

Self-tapping screws



NSYAMFSB

- Same reference for all dimensions
- Self-tapping, Pozidriv head, screws, for Ø 5 mm holes.

Supply:
100 units

Characteristics	References
Self-tapping screws	NSYAMFSB

Sealing kit



NSYPPSB

- The sealing kit helps to set up a lead-sealed cable of cover opening.
- Color: Green
- Ingress protection rating: IP66 according to IEC 60529
- Installation: Replaces the standard sealing washer on the box
- Same reference for all dimensions

Supply:
1 unit

Characteristics	References
Sealing kit SBM	NSYPPSB

Mounting lugs



NSYAEFFFSBX

- Wall-mounted lugs to be mounted directly on the rear of the box, either in horizontal or vertical position. Their versatile design complies with the mounting dimensions of many other enclosures.
- Installation: Horizontal or vertical position, distance between wall and enclosure: 12 mm
- Maximum load: 70 kg

Supply:
4 wall-mounted lugs, screws and pre-mounted sealing gaskets

Characteristics	References
Wall-mounted lugs	NSYAEFFFSBX

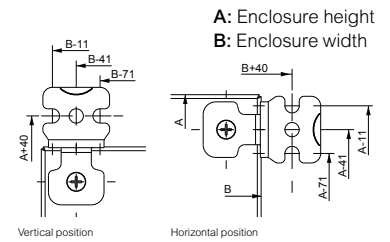

Simple-5

- ISO cable gland.
- Material: PA6 Polyamide, neoprene gasket
- Color: RAL 7035 grey
- Cable entry material: Combined
- Installation options: On cable gland plate or directly on enclosure
- Flexibility of the installation: Low
- Reversibility: Medium
- Ingress protection rating: IP68
- Cable retention: High
- Cable diameter (mm): From 12 to 40
- Cable Installation time: Slow
- Quantity of cables to be fitted for a given surface: +
- Cable entries for cables with connectors: No
- Cut-out dimensions (mm): Various circular hole diameters according to cable diameter
- External dimensions (mm): From Ø 15 to 46
- Glow wire resistance 960 °C
- Certified by VDE and UL
- Flame resistance: 750 °C

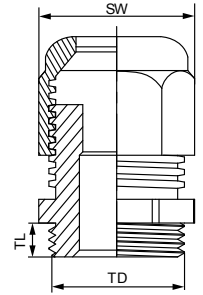

Supply:

The cable glands are supplied with nuts
Pack of 20 (M12 to M20), of 10 (M25 and M32), of 5 (M40)



ISM71503

Characteristics	Dimensions					References
	Cable (Ø mm)	Drill hole (Ø mm)	TD	TL	SW	
Cable gland M12, RAL 7035	3 / 6.5	12.2 (0 + 0.2)	12	6	15	ISM71501
Cable gland M16, RAL 7035	4 / 8	16.2 (0 + 0.2)	16	8	19	ISM71502
Cable gland M20, RAL 7035	6 / 12	20.2 (0 + 0.2)	20	10	24	ISM71503
Safety Cable gland M20, RAL 3000	6 / 12	20.2 (0 + 0.2)	20	10	24	IMT36150
Cable gland M25, RAL 7035	11 / 17	25.2 (0 + 0.2)	25	8	29	ISM71504
Cable gland M32, RAL 7035	15 / 21	32.2 (0 + 0.3)	32	10	36	ISM71505
Cable gland M40, RAL 7035	19 / 28	40.5 (0 + 0.3)	40	10	46	ISM71506

Synthetic snap-in cable gland

- Without thread.
- Easy assembly and disassembly.
- Suitable for walls from 0.5 to 4 mm thick.
- Material: PA6 Polyamide, neoprene gasket
- Color: RAL 7035 grey, RAL 7001, RAL 9005. Other colors on demand
- Cable entry material: Non armoured
- Installation options: On cable gland plate or directly on enclosure
- Flexibility of the installation: Low
- Reversibility: Medium
- Ingress protection rating: IP66
- Cable retention: High
- Cable diameter (mm): From 16 to 40
- Cable Installation time: Slow
- Quantity of cables to be fitted for a given surface: +
- Cable entries for cables with connectors: No
- Thread type: Metric EN 60423
Other types are available on demand
- Cut-out dimensions (mm): Various circular hole diameters according to cable diameter
- External dimensions (mm): From Ø 22 to 46
- Certificates: UL Certified (cULus)
- Temperature range: -20 °C to + 100 °C

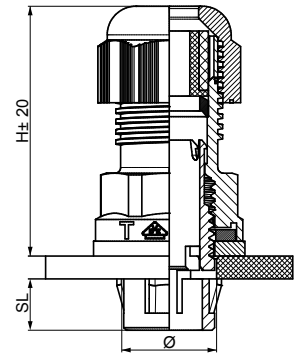

Supply:

The cable glands are supplied with nuts
Pack of 20 (M16 and M20), of 10 (M25 and M32), of 5 (M40)



NSYCGSP16

Characteristics	Dimensions						References	
	Ø	Ø min / max	Drill Ø	SL	SD	H		
Synthetic snap-in cable gland	M16	5/10	16.2 to 16.4	9	15.9	42.5	22	NSYCGSP16
Synthetic snap-in cable gland	M20	6/12	20.2 to 20.4	9	19.9	41.5	24	NSYCGSP20
Synthetic snap-in cable gland	M25	11/17	25.2 to 25.4	9	24.9	43.5	29	NSYCGSP25
Synthetic snap-in cable gland	M32	15/21	32.2 to 32.4	9	31.9	49.5	36	NSYCGSP32
Synthetic snap-in cable gland	M40	19/28	40.2 to 40.4	11.5	39.9	56	46	NSYCGSP40

Stainless-steel cable gland with lamellar insert

- Lamellar technology provides excellent resistance to traction as well as excellent torsional protection. For outdoor use, or for aggressive environments.
- Material: Stainless-steel AISI 304L or AISI 316L, neoprene gasket
- Cable entry material: Non armoured
- Installation options:
 - On cable gland plate or directly on enclosure
- Flexibility of the installation: Low
- Reversibility: Medium
- Ingress protection rating: IP68
- Cable retention: High
- Cable diameter (mm): From 12 to 40
- Cable Installation time: Slow
- Quantity of cables to be fitted for a given surface: +
- Cable entries for cables with connectors: No
- Thread type: Metric EN 60423

- Cut-out dimensions (mm): Various circular hole diameters according to cable diameter
- External dimensions (mm): From Ø 14 to 43
- Certificate: UL (cULus)
- Standard: DIN EN 62444
- Temperature range: -20 °C to + 100 °C



Supply:

The cable glands are supplied with nuts
Pack of 5 (M12 and M16), of 4 (M20 and M25), of 2 (M32 and M40)



NSYCGX12

Characteristics	Dimensions							References
	Ø	Ø min-max mm	Thread Length TL mm	SW Cap mm	SW Body mm	Outer Ø D mm	max. Height H mm	
AISI 304L	M12x1.5	3.0 - 6.5	6	14	14	15.5	24	NSYCGX12
AISI 304L	M16x1.5	4.0 - 8.0	7	17	19	21	25.5	NSYCGX16
AISI 304L	M20x1.5	10.0 - 14.0	8	24	24	26.5	30	NSYCGX20
AISI 304L	M25x1.5	10.0 - 14.0	8	24	27	30	30	NSYCGX25
AISI 304L	M32x1.5	13.0 - 18.0	9	30	36	39.8	35	NSYCGX32
AISI 304L	M40x1.5	18.0 - 25.0	9	41	46	51.4	40.5	NSYCGX40
AISI 316L	M12x1.5	3.0 - 6.5	6	14	14	15.5	24	NSYCGX12H
AISI 316L	M16x1.5	4.0 - 8.0	7	17	19	21	25.5	NSYCGX16H
AISI 316L	M20x1.5	10.0 - 14.0	8	24	24	26.5	30	NSYCGX20H
AISI 316L	M25x1.5	10.0 - 14.0	8	24	27	30	30	NSYCGX25H
AISI 316L	M32x1.5	13.0 - 18.0	9	30	36	39.8	35	NSYCGX32H
AISI 316L	M40x1.5	18.0 - 25.0	9	41	46	51.4	40.5	NSYCGX40H

Earth braids

- They help guarantee the earth connection for high frequencies, avoiding the disturbing electric currents that are produced.
- Material: Tinned copper.

Supply:

10 earth braids
(nuts and washers not included)
Reference by unit. Order by multiples of 10 (10, 20, 30...)



NSYEB156D6

Characteristics	Section (mm ²)	Terminal Ø (mm)	Length (mm)	Width (mm)	References
Earth braids	6	6.5	150	12	NSYEB156D6
Earth braids	10	6.5	150	17	NSYEB1510D6

Earth cables

- Make it easier to install a safe earth connection, with a perfect contact, with optimized length.
- Material: Brass and copper alloy terminal, green and yellow PVC insulated sheath

Supply:

10 earth cables (nuts and washers not included).
Reference by unit. Order by multiples of 10 (10, 20, 30...)



NSYEL136D6

Characteristics	Section (mm ²)	Terminal Ø (mm)	Length (mm)	References
Earth cables	6	6.4	130	NSYEL136D6
Earth cables	6	6.4	160	NSYEL166D6
Earth cables	6	8.3	160	NSYEL166D8
Earth cables	10	8.3	170	NSYEL1710D6
Earth cables	6	6.4	220	NSYEL226D6
Earth cables	6	13	220	NSYEL226D13
Earth cables	25	8.3	220	NSYEL2225D8
Earth cables	10	6.4	250	NSYEL2510D6
Earth cables	25	8.3	350	NSYEL3525D8

Earthing strip

- Perforated brass bar, 15 x 3 mm.
- 1 m long.
- 87 connection points, M5 drill holes

Supply:

- 1 earthing strip and fixing elements



NSYECB1M153

Characteristics	References
Earthing strip	NSYECB1M153

Technical changes reserved. Information provided without guarantee. Images are for illustrative purposes only.

Section A-A

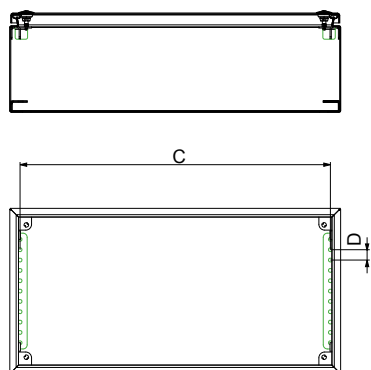

Section B-B

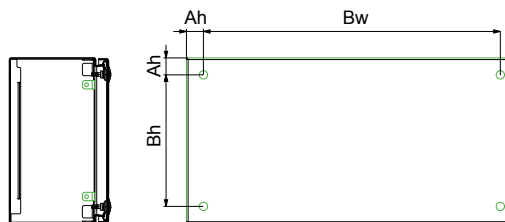

4

Dimensions Height (mm)	Width (mm)	Depth (mm)	Sheet thickness (mm)	Box installation Ah (mm)	Bh (mm)	Bw (mm)	Mounting C (mm)	D (mm)
150	150	80	1.2	20.5	109	109	125	12.5
150	300	80	1.2	20.5	109	259	275	12.5
200	200	80	1.2	20.5	159	159	175	12.5
200	300	80	1.2	20.5	159	259	275	12.5
200	400	120	1.2	20.5	159	359	375	12.5
300	300	120	1.2	20.5	259	259	275	12.5

Stainless-Steel Wall-Mounted Enclosures

Stainless-steel wall-mounted enclosures



5

Spacial S3X, Stainless-steel wall-mounted enclosures

Introduction	162
Characteristics	164
Selection guide	166
Accessories	167
Dimensions	171

What is stainless-steel?

How is the grade of stainless-steel determined?

These enclosures have been specially designed for the chemical, oil and food and beverage industries, among others, which are particularly demanding in terms of hygiene and resistance to corrosion.

Elaborate material composition

The following table shows the percentages of the main alloy elements that make up stainless-steels. The resistance of the material to aggressive agents in the environment depends mainly on these alloys.



5

Choosing a grade

Stainless-steel type		Chemical composition (%)			
AISI grade	N. Europe	Carbon	Chromium	Nickel	Molybdenum
304L	1.4307	< 0.03	17 - 19	8 - 10	0
316L	1.4404	< 0.03	17 - 19	10 - 13	2 - 2.25



AISI 304L stainless-steel

The most commonly used type in the food and beverage industry because of its resistance to corrosion and ease of cleaning.

- Prevention against corrosion, especially in the presence of organic acids.
- Resistance to the effects of nitrous gas in the presence of condensed water and in most aggressive environments.



AISI 316L stainless-steel

Recommended in salty or chlorinated environments because of its very high resistance to corrosion created by molybdenum.

- Improved resistance to corrosion.
- Particularly well adapted to environments with acidity, bromine and saline halides or very corrosive additives and solvents.

The finish

The finish: Three solutions for protection against aggressive substances

Surface condition plays an important role in the fight against bacteria. The lower the roughness, the fewer bacteria become incrustated. Reduced roughness means fewer bacteria, less adhesion, and a finish that's impeccable. The choice of finish determines the appearance of the enclosures that matches the environment of other machines and equipment.



Solution 1: Scotch-Brite® brushing

The method uses brushing as defined by the ASTM (American Society for Testing and Material).

- Finish very commonly used for the chemical and food and beverage industries.
- Surface roughness is improved thanks to an additional polishing process which offers more efficient characteristics against polluting elements.
- Surface roughness: $Ra \leq 0.8 \mu m$.



Solution 2: Micro-beading (on request)

Exclusiveness, an impeccable finish with silky-smooth appearance.

The method:

- Bombardment with miniscule ceramic balls of the entire surface to be treated at very high speed.
- Closes micro-cracks caused during lamination by flattening the surface.

The result:

- Increased hardness.
- Reduced surface roughness: $Ra \approx 0.8 \mu m$.
- A perfectly even surface, with a silky appearance (no scratches and no burrs).
- Reduces the adhesion of materials.
- Allows disinfection.
- Typical application: Pharmaceutical and food and beverage industries.



Solution 3: Protective painting (on request)

The highest protection against aggressive substances, external pollution and projections of metal particles.

- Provides ultimate protection against corrosion.
- Typical applications: Marine, seaside, off-shore.

These enclosures have been specially designed for the chemical, oil and food and beverage industries, among others, which are particularly demanding in terms of hygiene and resistance to corrosion.

This range can be configured according to your needs

5

4 different services available:



Assemble to order



Mounting of standard accessories



Painting



Machining



Finishes

- Two types of steel offered as standard: 304L and 316L, with Scotch-Brite® brushed finish.
- Painted or micro-beaded finish (on request).



Robustness and durability

Resistance to external mechanical impacts:

- IK10: Plain door, IK08: Glazed door.
- Door reinforcement frame or profile.
- Stainless-steel hinges.



Large range of accessories

- Stainless-steel accessories: canopy, wall fixing lugs.
- Standard accessories: mounting plate, inner door, modular chassis and step slides.
- Large selection of locks made of 100% stainless-steel.



Time savings and convenience

- 304L or 316L stainless-steel wall fixing lugs.
- Vertical reinforcement perforated profiles, which make it easier to equip the door.
- Reversible door opening to 120°.
- Easy installation directly on the machine thanks to the 4 rear drilled holes.



Sealing

- Protection rating of IP66 (1 door) or IP55 (2 doors) according to IEC 60529: Complete protection against dust and water sprays.
- Polyurethane gasket.
- Gutter-shaped front profile.
- Three locking points for the double-door.

See page 546 for details or consult our web site www.se.com



Comment:
For more information see [page 171](#)

Characteristics	NSYS3X●●●●	NSYS3X●●●●T	NSYS3X●●●●H
Material	304L stainless-steel		316L stainless-steel
Finish	Enclosure with plain door.		Enclosure with plain door.
Thickness	10/10° - 15/10° mm		
Ingress protection rating	<ul style="list-style-type: none"> • IP66 (1 door) or IP55 (2 doors) according to IEC 60529 • Rating according to UL50e: Types 4,4X and 13 for single-door and Types 1 and 12 for double-door enclosures. 		
Mechanical protection rating	IK10 according to IEC 62262	IK08 according to IEC 62262	IK10 according to IEC 62262
Standards and certifications	See technical guide on page 712		
Installation	Outdoor installation: Compliant with IEC 62208 regarding type tests specified in §9.12 (resistance to ultra-violet (UV) radiation) and §9.13 (resistance to corrosion). It is always advisable to install a canopy to avoid water stagnation on the upper part of the enclosure		
Other characteristics	<ul style="list-style-type: none"> • Single-piece body (cross-shaped structure). Gutter-shaped front profile • 4 rear studs for fixing the material • 2 cut-out vertical profiles on the door (from a height of 600 mm), with drill holes with a diameter of 4.25 mm and a pitch of 25 mm for installing accessories • Door reinforcement frame (from a height of 1000 mm), cross-section of 20 mm x 15 mm, with drilled holes with a diameter of 5 mm and a pitch of 25 mm • Standard lock with 3-mm double-bar lock (chrome-plated zamak) • 2 locking points for heights of more than 500 mm or three points for two-door enclosures • Stainless-steel hinges screwed to the body of the enclosure. They make it easier to remove and invert the door. Opening angle: 120° • Maximum load on the door: 50 kg/m² • Polyurethane gasket • M6 x 16 mm screws on the door and on the body, allowing equipotential connection between the earth connections (on request) • 4 holes for fixing to the wall directly or with the help of mounting lugs (on request), sealed by sealing plugs 		

					304L stainless-steel		316L stainless-steel
External dimensions			No. of locks	No. of doors	304L stainless-steel		316L stainless-steel
Height (mm)	Width (mm)	Depth (mm)			Plain door	Glazed door. The glazed door has no reinforcement.	Plain door
300	200	150	1	1	NSYS3X3215	-	NSYS3X3215H
300	250	150	1	1	NSYS3X302515	-	NSYS3X302515H
300	300	150	1	1	NSYS3X3315	-	NSYS3X3315H
400	300	150	1	1	NSYS3X4315	-	NSYS3X4315H
400	300	200	1	1	NSYS3X4320	NSYS3X4320T	NSYS3X4320H
400	400	200	1	1	NSYS3X4420	-	NSYS3X4420H
400	600	200	1	1	NSYS3X4620	-	NSYS3X4620H
500	400	200	2	1	NSYS3X5420	NSYS3X5420T	NSYS3X5420H
600	400	200	2	1	NSYS3X6420	NSYS3X6420T	NSYS3X6420H
600	600	250	2	1	NSYS3X6625	-	NSYS3X6625H
600	1000	300	-	2	NSYS3X601030	-	-
600	1200	300	-	2	NSYS3X601230	-	-
700	500	250	2	1	NSYS3X7525	NSYS3X7525T	NSYS3X7525H
800	600	250	2	1	NSYS3X8625	NSYS3X8625T	NSYS3X8625H
800	800	300	2	1	NSYS3X8830	-	NSYS3X8830H
800	1000	300	2	2	NSYS3X801030	-	-
800	1200	300	2	2	NSYS3X801230	-	-
1000	800	300	2	1	NSYS3X10830	NSYS3X10830T	NSYS3X10830H
1000	1000	300	-	2	NSYS3X101030	-	NSYS3X101030H
1200	800	300	2	1	NSYS3X12830	-	NSYS3X12830H
1200	1000	300	-	2	NSYS3X121030	-	NSYS3X121030H

(1) Three-point locking system system.

Accessories

External dimensions				Accessories					
Height (mm)	Width (mm)	Depth (mm)	No. of modules	Mounting plate Plain	Mounting plate Silkscreened	Mounting plate Microperforated	Mounting plate Telequick	Modular Chassis	Step slides
300	200	150	-	NSYMM32	-	NSYMF32	NSYMR32	-	-
300	250	150	-	NSYMM3025	-	-	NSYMR3025	-	-
300	300	150	-	NSYMM33	-	NSYMF33	NSYMR33	-	-
400	300	150	24	NSYMM43	NSYMS43	NSYMF43	NSYMR43	NSYDLM24	-
400	300	200	24	NSYMM43	NSYMS43	NSYMF43	NSYMR43	NSYDLM24	NSYSDCR200
400	400	200	-	NSYMM44	NSYMS44	NSYMF44	NSYMR44	-	NSYSDCR200
400	600	200	-	NSYMM64	NSYMS64	NSYMF64	NSYMR46	-	NSYSDCR200
500	400	200	48	NSYMM54	NSYMS54	NSYMF54	NSYMR54	NSYDLM48	NSYSDCR200
600	400	200	48	NSYMM64	NSYMS64	NSYMF64	NSYMR64	NSYDLM48P	NSYSDCR200
600	600	250	84	NSYMM66	NSYMS66	NSYMF66	NSYMR66	NSYDLM84P	NSYSDCR250
600	1000	300*	-	NSYMM106	-	NSYMF106	NSYMR106	-	NSYSDCR300
600	1200	300*	-	NSYMM126	-	NSYMF126	-	-	NSYSDCR300
700	500	250	66	NSYMM75	NSYMS75	NSYMF75	NSYMR75	NSYDLM66	NSYSDCR250
700	500	250	88	-	-	-	-	NSYDLM88	-
800	600	250	84	NSYMM86	NSYMS86	NSYMF86	NSYMR86	NSYDLM84	NSYSDCR250
800	600	250	112	-	-	-	-	NSYDLM112	-
800	800	300	-	NSYMM88	-	NSYMF88	NSYMR88	-	NSYSDCR300
800	1000	300 ⁽¹⁾	-	NSYMM108	-	NSYMF108	NSYMR108	-	NSYSDCR300
800	1200	300 ⁽¹⁾	-	NSYMM128	-	NSYMF128	NSYMR128	-	NSYSDCR300
1000	800	300	234	NSYMM108	-	NSYMF108	NSYMR108	NSYDLM240	NSYSDCR300
1000	1000	300	-	NSYMM1010	-	NSYMF1010	NSYMR1010	-	NSYSDCR300
1200	800	300	-	NSYMM128	-	NSYMF128	NSYMR128	-	NSYSDCR300
1200	1000	300	-	NSYMM1210	-	NSYMF1210	NSYMR1210	-	NSYSDCR300

(1) Three-point locking system system.

Technical changes reserved. Information provided without guarantee. Images are for illustrative purposes only.

Plinth

- Material: Stainless-steel, AISI 304L or AISI 316L
- Finish: Scotch-Brite® brushing, to help guarantee the durability in applications where contact to the floor increases the risk of corrosion
- Installation: Plinth fixing kit must be ordered separately (ref. **NSYAPFXWM**) composed by fixing elements and drilling jig



NSYSPFX8100

Characteristics	Width	References
Plinth height 100 mm, Kit (4 corners + front and back), AISI 304L	800	NSYSPFX8100
Plinth height 100 mm, Kit (4 corners + front and back), AISI 304L	1000	NSYSPFX10100
Plinth height 100 mm, Kit (4 corners + front and back), AISI 316L	800	NSYSPFX8100H
Plinth height 100 mm, Kit (4 corners + front and back), AISI 316L	1000	NSYSPFX10100H



NSYSPSX3100

Characteristics	Depth	References
Plinth height 100 mm, Set of 2 side panels, AISI 304L	300	NSYSPSX3100
Plinth height 100 mm, Set of 2 side panels, AISI 316L	300	NSYSPSX3100H



NSYSPFX8200

Characteristics	Width	References
Plinth height 200 mm, Kit (4 corners + front and back), AISI 304L	800	NSYSPFX8200
Plinth height 200 mm, Kit (4 corners + front and back), AISI 304L	1000	NSYSPFX10200
Plinth height 200 mm, Kit (4 corners + front and back), AISI 316L	800	NSYSPFX8200H
Plinth height 200 mm, Kit (4 corners + front and back), AISI 316L	1000	NSYSPFX10200H

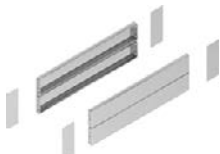

NSYSPSX3200

Characteristics	Depth	References
Plinth height 200 mm, Set of 2 side panels (x2), AISI 304L	300	NSYSPSX3200
Plinth height 200 mm, Set of 2 side panels (x2), AISI 316L	300	NSYSPSX3200H

Plain mounting plate screw



NSYS13M5HS



Characteristics	Supply	References
Plain mounting plate screw, Self-tapping screw M5 x 13	100	NSYS13M5HS
Plain mounting plate screw, Self-tapping screw M5 x 16	100	NSYS16M5HS
Plain mounting plate screw, Self-tapping screw M6 x 16	100	NSYS16M6HS

Accessories

Clip-on nuts: [page 290](#)
 Reference: **AF1EA6**
 Cable entries: [page 292](#)
 Reference: **NSYSAM504SE**

Stainless-steel cable gland with lamellar insert: [page 294](#)
 Reference: **NSYCGX12**
 Lighting: [page 314](#)
 Reference: **NSYLAMLDS**

Adhesive plastic document pocket: [page 318](#)
 Reference: **NSYDPA44**
 Door switch: [page 318](#)
 Reference: **NSYINLCRN**

Canopy

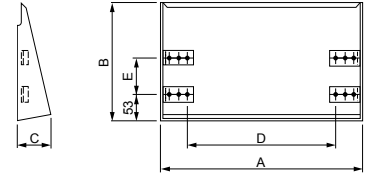

- Material: 304L stainless-steel sheet
- Finish: Scotch-Brite® brushed
- Thickness: 15/10° mm
- Installation: Direct fixing to the body of the enclosure

Supply:
Delivered with the fixings required for installation



NSYTX2015

Dimensions

Characteristics	Width (mm)	Depth (mm)	A (mm)	B (mm)	C (mm)	D (mm)	E (mm)	References
Canopy	200	150	205	183	51	120	-	NSYTX2015
Canopy	250	150	205	183	51	120	-	NSYTX2515
Canopy	300	150	305	183	51	220	-	NSYTX3015
Canopy	300	200	305	233	51	220	70	NSYTX3020
Canopy	400	200	405	233	70	320	70	NSYTX4020
Canopy	600	200	605	233	70	520	70	NSYTX6020
Canopy	600	250	605	283	70	520	120	NSYTX6025
Canopy	1000	300	1005	333	70	920	170	NSYTX10030
Canopy	1200	300	1205	333	70	1120	120	NSYTX12030
Canopy	500	250	505	283	70	420	120	NSYTX5025
Canopy	800	300	805	333	70	720	170	NSYTX8030

5

Wall fixing lugs

- A: Enclosure height
- B: Enclosure width

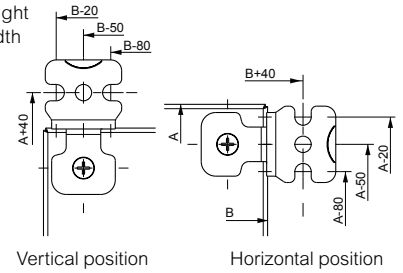

Vertical position

Horizontal position

Installation:

Mounting of the wall fixing lugs in horizontal or vertical position. Fixing from the outside.

- Wall-enclosure separation of 12 mm
- Maximum load: 250 kg

Supply:
Set of four wall fixing lugs



NSYPFCX

Characteristics	References
Wall fixing-lug, 304L stainless-steel	NSYPFCX
Wall fixing-lug, 316L stainless-steel	NSYPFC2X

Support bracket for enclosure with anti-tilt kit and reinforcement

- Material: Steel
- The support bracket is used when the enclosure cannot be hung from a wall or a post.
- Maximum enclosure dimensions: 1000 x 800 x 300 mm.
- Floor attachment by standard M12 fastenings.
- Finish: Epoxy polyester paint
- Color: RAL 7035 grey
- Maximum load: 120 kg



NSYCOCS1400

Characteristics	Height (mm)	References
Support bracket for enclosure with anti-tilt kit and reinforcement	1400	NSYCOCS1400
Support bracket for enclosure with anti-tilt kit and reinforcement	1800	NSYCOCS1800

1-point-lock options

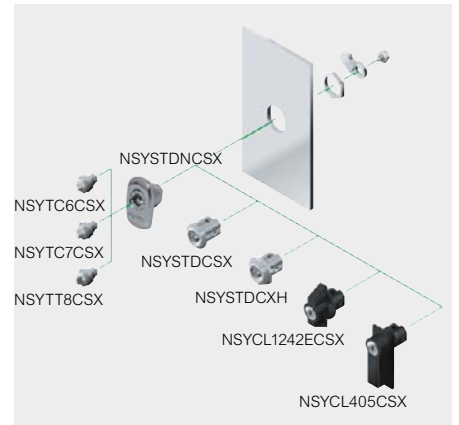

- Protection rating: IP66
- For locks for double-door enclosures please contact us.



Characteristics	Type	Material	References
Double-bar lock	Escutcheon with insert, 3 mm	Chrome-plated zamak	NSYSTDNCSX
Insert	triangular, 8 mm	304L stainless-steel	NSYTT8CSX
Insert	square, 7 mm	304L stainless-steel	NSYTC7CSX
Insert	square, 6 mm	304L stainless-steel	NSYTC6CSX
Round lock	round, 3 mm (spare)	Chromeplated zamak	NSYSTDCSX
Round lock	round, 3 mm	304L stainless-steel	NSYSTDCXH
Round lock	round	316 stainless-steel, please contact us for availability	NSYSTDCX2H
Handle lock	Padlock	316 stainless-steel, please contact us for availability	NSYCBXHCRN
Handle lock	1242E	Chrome-plated zamak	NSYCL1242ECSX
Handle lock	405	Polyamide	NSYCL405CSX
Handle lock	610	Polyamide	NSYCL610CSX

3-point-lock options



- Protection rating: IP66

Type	Material	References
Handle lock	100% stainless-steel	NSYTSML

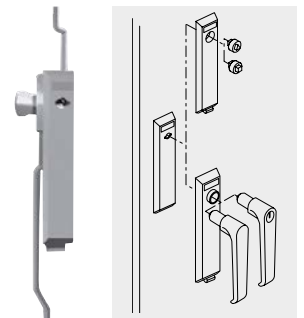

Wall-mounted door retainer, steel

To block the door in open position.

- It is installed on enclosures with heights from 400 mm and widths from 300 mm.
- Door opening angle: 120°.
- Earthing connection of the enclosure by means of the reinforcement rail.
- Earthing accessories supplied with the enclosure (earth-connection cable to be ordered separately), see [page 323](#).
- Material: Steel

Comment:

It is not compatible with the 19" swing rack and the internal door.



Characteristics	References
Wall-mounted door retainer, steel	NSYAEDRSCST

Eyebolts, Consult us for availability

- Material: Stainless-steel 304L
- Maximum load: 210 kg per enclosure when slinging at 60°
- Supply reinforcing brackets attached to therings (these brackets also act as a drilling template)



NSYAELYTCRXG8

Characteristics	References
Set of 2 M8 eyebolts	NSYAELYTCRXG8

Inner door

- 3-mm double-bar lock.
- Not compatible with door retainer and door switch. Consult us.
- Maximum load: 30 kg/m²

Installation: As standard it can be mounted an inner door and a mounting plate, on the step slides, at the same time

- Can be mounted either on the front side of the enclosure or on step slides (not supplied with standard)

Supply:
1 inner door



NSYPIN43

Characteristics	Height (mm)	Width (mm)	D (mm)	E (mm)	G (mm)	H (mm)	I min. (mm)	References
Inner door for wall-mounted enclosures	400	300	349	241	208	32	51	NSYPIN43
Inner door for wall-mounted enclosures	500	400	449	341	308	32	51	NSYPIN54
Inner door for wall-mounted enclosures	600	400	549	341	308	32	51	NSYPIN64
Inner door for wall-mounted enclosures	700	500	649	441	408	32	51	NSYPIN75
Inner door for wall-mounted enclosures	800	600	749	541	508	32	51	NSYPIN86
Inner door for wall-mounted enclosures	1000	800	949	741	708	32	51	NSYPIN108
Inner door for wall-mounted enclosures	1200	800	1149	741	708	32	52	NSYPIN128

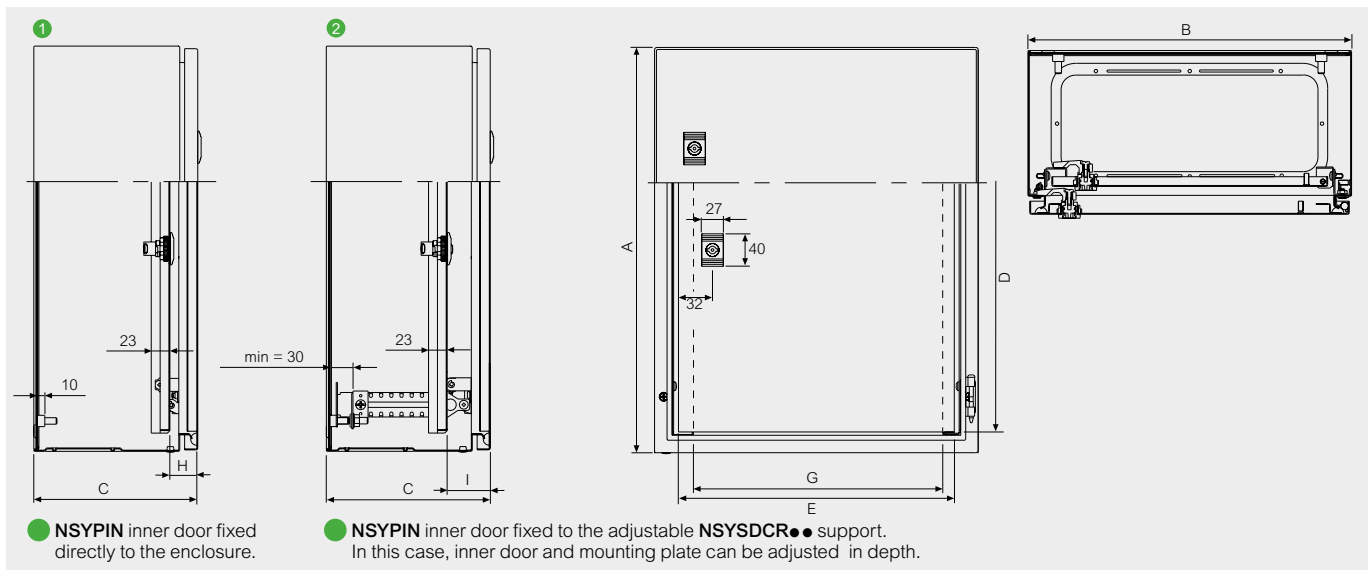

Height (mm)	Width (mm)	D (mm)	E (mm)	G (mm)	H (mm)	I min. (mm)	References
400	300	349	241	208	32	51	NSYPIN43
500	400	449	341	308	32	51	NSYPIN54
600	400	549	341	308	32	51	NSYPIN64
700	500	649	441	408	32	51	NSYPIN75
800	600	749	541	508	32	51	NSYPIN86
1000	800	949	741	708	32	51	NSYPIN108
1200	800	1149	741	708	32	52	NSYPIN128

Fig. 1

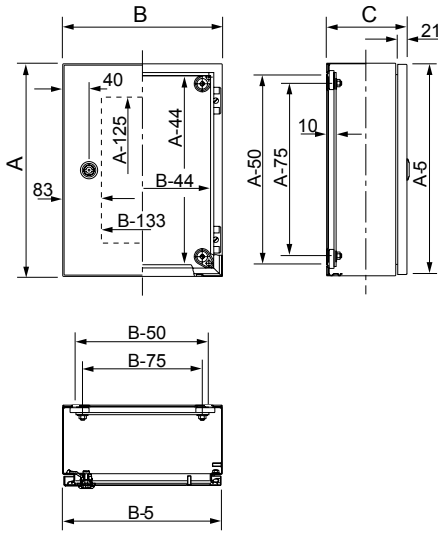
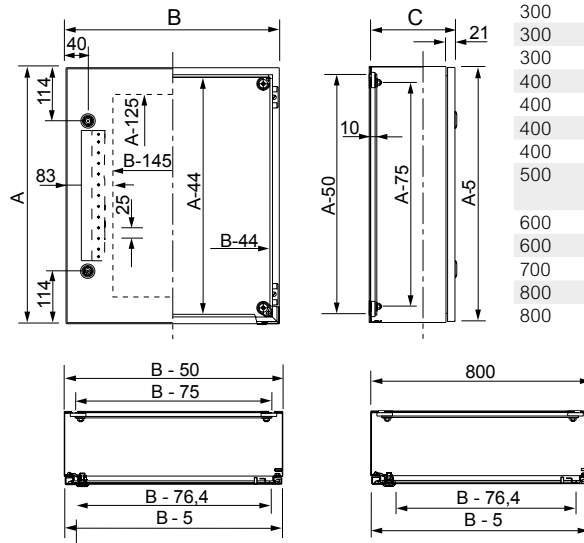

Fig. 2



External dimensions (mm)			Fig.
A	B	C	
300	200	150	1
300	250	150	1
300	300	150	1
400	300	150	1
400	300	200	1
400	400	200	1
400	600	200	1
500	400	200	2 Without door reinforcement
600	400	200	2
600	600	250	2
700	500	250	2
800	600	250	2
800	800	300	2

Fig. 3

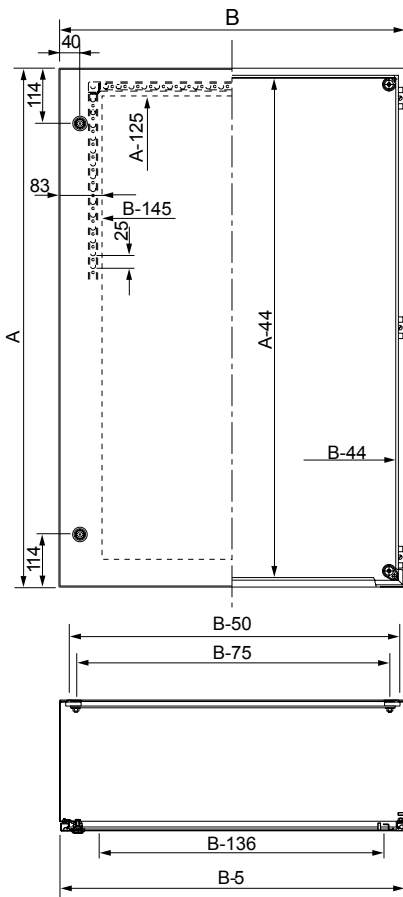
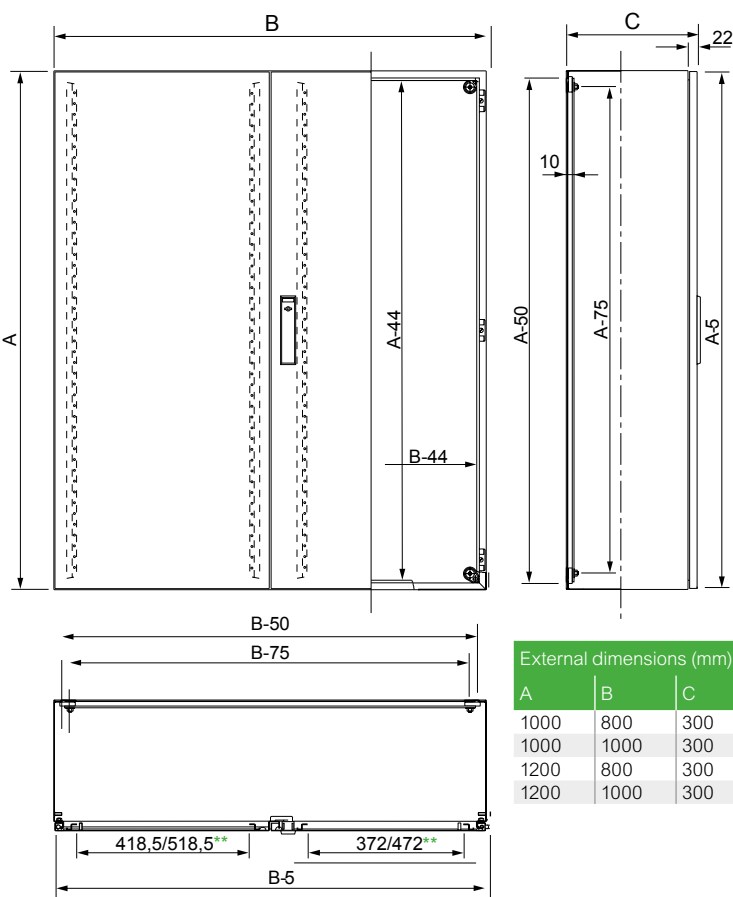

Fig. 4



External dimensions (mm)			Fig.
A	B	C	
1000	800	300	3
1000	1000	300	4
1200	800	300	3
1200	1000	300	4

** For glazed door.

Stainless-Steel Floor-Standing Enclosures

Spacial SMX



Spacial SFX



6

Spacial SMX SFX

Introduction	174
Characteristics	175
Accessories	176
Dimensions	180

These enclosures have been specially designed for the chemical, oil and food and beverage industries, among others, which are particularly demanding in terms of hygiene and resistance to corrosion.

This range can be configured according to your needs

4 services are available:



Assemble to order



Mounting of standard accessories



Painting



Machining



6



Material and finishes

- AISI 304L as standard in Spacial SMX and SFX.
- AISI 316L as standard in Spacial SMX and on request in Spacial SFX.
- Finishes:
 - Scotch-Brite® brushed (standard).
 - Micro-beaded (on request).
 - Painted (on request).

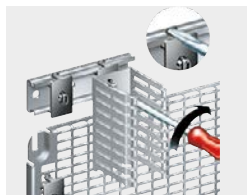

Time savings and convenience

- Complete range of accessories for installation, cable management, etc.
- 316L stainless-steel plinth: easy cable entry.
- 304L or 316L stainless-steel plinth: easy cable entry (Spacial SFX and SMX).
- Reversible door opening to 120°.
- Padlock lock with key or shaped insert.
- Adjustment rails perforated with a pitch of 25 mm.
- Perforated reinforcement frame allowing accessories to be mounted on the door.



Sealing

- Protection rating against dust and water IP66 or IP55 depending model according to IEC 60529.
- 3-point locking system.
- Canopy (optional):
 - Protects the door sealing,
 - Helps guarantee correct water drainage,
 - No stagnation on the top.
- Single-piece cable gland plate with polyurethane gasket.



Compatible with the other ranges

- The mounting plates and other accessories of the Spacial SM and SF can be combined with metal products.



Hygiene

- The high quality of the standard finish enables very easy maintenance while avoiding contamination.
- The hygienic feet made from 316L stainless-steel, adjustable between 140 mm and 200 mm in height, make it easier to clean under the enclosures.



Robustness and durability

- Resistance to external mechanical impacts: IK10 according to IEC 62262.
- 3 hinges made entirely from stainless-steel.
- Door reinforcement frame.



Resistance to corrosion

- High resistance to corrosion. 304L and 316L stainless-steels provide the best solutions for applications in extremely demanding environments.

See page 546 for details or consult our web site www.se.com



Characteristics	Spacial SMX	Spacial SFX
	<ul style="list-style-type: none"> Stainless-steel floor-standing enclosure, folded and welded. Single and double front door, with reinforcement frame. 	<ul style="list-style-type: none"> Enclosure made up of a structure, consisting of top and bottom, rear panel and vertical profiles. Single and double front door, with reinforcement frame.
Material	304L stainless-steel, 316L stainless-steel	304L stainless-steel, 316L version (on request)
Finish	Scotch-Brite® brushed finish Micro-beaded and painted finishes (on request)	
Thickness	15/10* mm	Consult us
Ingress protection rating	IP66 according to IEC 62208 (single-door enclosure)	
Mechanical protection rating	IK10 according to IEC 62262	
Standards and certifications	See technical guides page 712	
Installation	Outdoor installation: Compliant with IEC 62208 regarding type tests specified in §9.12 (resistance to ultra-violet (UV) radiation) and §9.13 (resistance to corrosion). Comment: SMX and SFX units do not require a canopy for outdoor use.	
Other characteristics	<ul style="list-style-type: none"> Plain front door. Opening to left or right to 120° with reinforcement frame installed: 3 stainless-steel hinges 3-point locking system with handle made from painted zamak, 5-mm double-bar Acceptable load of 50 kg 	
Supply	<ul style="list-style-type: none"> Welded compact body Single-piece cable gland plate with sealing gasket Welded mounting plate support brackets 	<ul style="list-style-type: none"> Welded rear panel 4 mounting plate-supporting brackets Single-piece cable gland plate with sealing gasket

304L	316L	304L
------	------	------



Comment:
Dimensions,
see [page 180](#)

External dimensions				Stainless-steel enclosure	Stainless-steel enclosure	Stainless-steel suitable enclosure
Height (mm)	Width (mm)	Depth (mm)	Number of front doors			
1400	1000	300	2	NSYSMX141030	-	-
1600	800	400	1	NSYSMX16840	-	-
1800	600	400	1	NSYSMX18640	-	NSYSFX18640
1800	800	400	1	NSYSMX18840	NSYSMX18840H	NSYSFX18840
1800	1200	400	2	NSYSMX181240	NSYSMX181240H	NSYSFX181240
1800	1600	400	2	NSYSMX181640	NSYSMX181640H	-
2000	600	500	1	-	-	NSYSFX20650
2000	800	400	1	-	-	NSYSFX20840
2000	800	500	1	NSYSMX20850	-	-
2000	800	600	1	-	-	NSYSFX20860
2000	1000	400	2	NSYSMX201040	NSYSMX201040H	-
2000	1000	600	2	-	-	NSYSFX201060
2000	1200	500	2	NSYSMX201250	NSYSMX201250H	-
2000	1200	600	2	-	-	NSYSFX201260
2000	1600	600	2	NSYSMX201660	NSYSMX201660H	-

Stainless-Steel Floor-Standing Enclosures

Spacial SMX - SFX, Accessories

SMX



Plinth height 100 mm
(4 corners + front and back)



Plinth height 100 mm
(Set of 2 side panels)



Plinth height 200 mm
(4 corners + front and back)

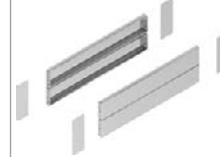

Plinth height 200 mm
(Set of 2 side panels)

Characteristics		Stainless-steel plinths								
Material		Stainless-steel, AISI 304L				Stainless-steel, AISI 316L				
Finish		Scotch-Brite®-brushing to ensure durability in applications where contact with the floor increases the risk of corrosion								
External dimensions (mm)		Plinth height 100 mm		Plinth height 200 mm		Plinth height 100 mm		Plinth height 200 mm		
Height (A)	Width (B)	Depth (C)	Kit (4 corners + front and back)	Set of 2 side panels	Kit (4 corners + front and back)	Set of 2 side panels (x2)	Kit (4 corners + front and back)	Set of 2 side panels	Kit (4 corners + front and back)	Set of 2 side panels (x2)
1400	1000	300	NSYSPFX10100	NSYSPSX3100	NSYSPFX10200	NSYSPSX3200	NSYSPFX10100H	NSYSPSX3100H	NSYSPFX10200H	NSYSPSX3200H
1600	800	400	NSYSPFX8100	NSYSPSX4100	NSYSPFX8200	NSYSPSX4200	NSYSPFX8100H	NSYSPSX4100H	NSYSPFX8200H	NSYSPSX4200H
1800	600	400	NSYSPFX6100	NSYSPSX4100	NSYSPFX6200	NSYSPSX4200	NSYSPFX6100H	NSYSPSX4100H	NSYSPFX6200H	NSYSPSX4200H
		800	400	NSYSPFX8100	NSYSPSX4100	NSYSPFX8200	NSYSPSX4200	NSYSPFX8100H	NSYSPSX4100H	NSYSPFX8200H
	1200	400	NSYSPFX12100	NSYSPSX4100	NSYSPFX12200	NSYSPSX4200	NSYSPFX12100H	NSYSPSX4100H	NSYSPFX12200H	NSYSPSX4200H
		400	NSYSPFX16100	NSYSPSX4100	NSYSPFX16200	NSYSPSX4200	NSYSPFX16100H	NSYSPSX4100H	NSYSPFX16200H	NSYSPSX4200H
2000	600	500	NSYSPFX6100	NSYSPSX5100	NSYSPFX6200	NSYSPSX5200	NSYSPFX6100H	NSYSPSX5100H	NSYSPFX6200H	NSYSPSX5200H
		400	NSYSPFX8100	NSYSPSX4100	NSYSPFX8200	NSYSPSX4200	NSYSPFX8100H	NSYSPSX4100H	NSYSPFX8200H	NSYSPSX4200H
	800	400	NSYSPFX8100	NSYSPSX5100	NSYSPFX8200	NSYSPSX5200	NSYSPFX8100H	NSYSPSX5100H	NSYSPFX8200H	NSYSPSX5200H
		500	NSYSPFX8100	NSYSPSX6100	NSYSPFX8200	NSYSPSX6200	NSYSPFX8100H	NSYSPSX6100H	NSYSPFX8200H	NSYSPSX6200H
	1000	400	NSYSPFX10100	NSYSPSX4100	NSYSPFX10200	NSYSPSX4200	NSYSPFX10100H	NSYSPSX4100H	NSYSPFX10200H	NSYSPSX4200H
		600	NSYSPFX10100	NSYSPSX6100	NSYSPFX10200	NSYSPSX6200	NSYSPFX10100H	NSYSPSX6100H	NSYSPFX10200H	NSYSPSX6200H
	1200	500	NSYSPFX12100	NSYSPSX5100	NSYSPFX12200	NSYSPSX5200	NSYSPFX12100H	NSYSPSX5100H	NSYSPFX12200H	NSYSPSX5200H
		600	NSYSPFX12100	NSYSPSX6100	NSYSPFX12200	NSYSPSX6200	NSYSPFX12100H	NSYSPSX6100H	NSYSPFX12200H	NSYSPSX6200H
1600	600	NSYSPFX16100	NSYSPSX6100	NSYSPFX16200	NSYSPSX6200	NSYSPFX16100H	NSYSPSX6100H	NSYSPFX16200H	NSYSPSX6200H	

SFX



Plinth height 100 mm
(4 corners + front and back)



Plinth height 100 mm
(Set of 2 side panels)

Characteristics		Stainless-steel plinths				
Material		Stainless-steel, AISI 304L				
Finish		Scotch-Brite®-brushing to ensure durability in applications where contact with the floor increases the risk of corrosion				
Installation		Mounting in the holes for fixing the enclosures to the floor. Suitable for steel floor-standing enclosures (SF and SM)				
External dimensions (mm)		Plinth height 100 mm		Plinth height 200 mm		
Height (A)	Width (B)	Depth (C)	Kit (4 corners + front and back)	Set of 2 side panels	Kit (4 corners + front and back)	Set of 2 side panels (x2)
1400	1000	300	NSYSPFX10100	-	NSYSPFX10200	-
1600	800	400	NSYSPFX8100	NSYSPSX4100SF	NSYSPFX8200	NSYSPSX4200SF
1800	600	400	NSYSPFX6100	NSYSPSX4100SF	NSYSPFX6200	NSYSPSX4200SF
		800	400	NSYSPFX8100	NSYSPSX4100SF	NSYSPFX8200
	1200	400	NSYSPFX12100	NSYSPSX4100SF	NSYSPFX12200	NSYSPSX4200SF
		400	-	NSYSPSX4100SF	-	NSYSPSX4200SF
2000	600	500	NSYSPFX6100	NSYSPSX5100SF	NSYSPFX6200	NSYSPSX5200SF
		400	NSYSPFX8100	NSYSPSX4100SF	NSYSPFX8200	NSYSPSX4200SF
	800	400	NSYSPFX8100	NSYSPSX5100SF	NSYSPFX8200	NSYSPSX5200SF
		500	NSYSPFX8100	NSYSPSX6100SF	NSYSPFX8200	NSYSPSX6200SF
	1000	400	NSYSPFX10100	NSYSPSX4100SF	NSYSPFX10200	NSYSPSX4200SF
		600	NSYSPFX10100	NSYSPSX6100SF	NSYSPFX10200	NSYSPSX6200SF
	1200	500	NSYSPFX12100	NSYSPSX5100SF	NSYSPFX12200	NSYSPSX5200SF
		600	NSYSPFX12100	NSYSPSX6100SF	NSYSPFX12200	NSYSPSX6200SF
1600	600	-	NSYSPSX6100SF	-	NSYSPSX6200SF	

Comment:

Ventilated plinths made of stainless-steel for heavy-duty outdoor enclosures (page 441) are compatible to Spacial SMX stainless-steel compact enclosures.

SMX Canopy



NSYSCMX10030

- Helps guarantee very high protection of the enclosure when used outdoors.
- Material: 304L stainless-steel sheet
Other types of stainless-steel, contact us
- Finish: Scotch-Brite® brushed
- Other finishes, contact us
- Thickness 15/10°
- Installation: It is fixed in the same holes as the eyebolt.

Supply:

Delivered with fixings. Other dimensions and canopy for sets, contact us

Characteristics	Width (mm)	Depth (mm)	References
Top-mounted	600	400	NSYSCMX6040
Top-mounted	800	400	NSYSCMX8040
Top-mounted	800	500	NSYSCMX8050
Top-mounted	1000	300	NSYSCMX10030
Top-mounted	1000	400	NSYSCMX10040
Top-mounted	1200	400	NSYSCMX12040
Top-mounted	1200	500	NSYSCMX12050
Top-mounted	1600	400	NSYSCMX16040
Top-mounted	1600	600	NSYSCMX16060

SFX Canopy



NSYSCX6040

Characteristics	Width (mm)	Depth (mm)	References
Top-mounted	600	400	NSYSCX6040
Top-mounted	600	500	NSYSCX6050
Top-mounted	800	400	NSYSCX8040
Top-mounted	800	600	NSYSCX8060
Top-mounted	1000	600	NSYSCX10060
Top-mounted	1200	400	NSYSCX12040
Top-mounted	1200	600	NSYSCX12060
Top-mounted (used when coupling 2 SFX together)	1200	500	NSYSCX12050
Top-mounted (used when coupling 2 SFX together)	1600	400	NSYSCX16040
Top-mounted (used when coupling 2 SFX together)	1600	600	NSYSCX16060

Supply:

Delivered with fixings. Other dimensions and canopy for sets, contact us

Locking options



NSYTDB5ME



NSYTDB5ME



NSYBCME

- The enclosures Spacial SMX and SFX are delivered as standard with a retractable handle made from
- Painted zamak with 5-mm double-bar insert, ref. **NSYMCSX**
- Standard inserts can be replaced by shaped inserts or barrels according the following table:

Door switch for Spacial SF and SFX: page 318

Reference: **NSYDCM20**

Door switch for Spacial SM: page 318

Reference: **NSYMDCM20**

Characteristics	Type	Supply	References
Shape insert	5 mm doublebar insert.	Insert with key	NSYTDB5ME
Shape insert	Square insert, 6 mm	Insert with key	NSYTC6ME
Shape insert	Square insert, 8 mm	Insert with key	NSYTC8ME
Shape insert	Triangular insert, 6.5 mm	1 pack	NSYTT6ME
Shape insert	Triangular insert, 8 mm	1 pack	NSYTT8ME
Padlocking system	Padlocking device	1 pack	NSYBCME
Barrels	Reinforced key and barrel	1 pack	NSYTLRME
Barrels	JIS key and barrel	1 pack	NSYTLJISME
Barrels	Manual	1 pack	NSYTMME
Barrels	Barrel and key 405E	Barrels with 1 key	NSYTCL405ME
Barrels	Barrel and key 610E	Barrels with 1 key	NSYTCL610ME
Barrels	Barrel and key 1242E	Barrels with 1 key	NSYTL1242EME

SFX Side panels



NSY2SPX184

- Side panels including a polyurethane sealing gasket.
- Their special design helps guarantee the protection of the door gasket
- 304L stainless-steel sheet

Characteristics	Height (mm)	Depth (mm)	References
Set of 2 side panels	1800	400	NSY2SPX184
Set of 2 side panels	2000	400	NSY2SPX204
Set of 2 side panels	2000	500	NSY2SPX205
Set of 2 side panels	2000	600	NSY2SPX206

SMX Plain mounting plate



NSYMP1410

Characteristics	Height (mm)	Width (mm)	References
Plain mounting plate	1400	1000	NSYMP1410
Plain mounting plate	1600	800	NSYMP168
Plain mounting plate	1800	600	NSYMP186
Plain mounting plate	1800	800	NSYMP188
Plain mounting plate	1800	1200	NSYMP1812
Plain mounting plate	1800	1600	NSYMP1816
Plain mounting plate	2000	800	NSYMP208
Plain mounting plate	2000	1000	NSYMP2010
Plain mounting plate	2000	1200	NSYMP2012
Plain mounting plate	2000	1600	NSYMP2016

SFX Plain mounting plate



NSYMP186

Characteristics	Height (mm)	Width (mm)	References
Plain mounting plate	1800	600	NSYMP186
Plain mounting plate	1800	800	NSYMP188
Plain mounting plate	1800	1200	NSYMP1812
Plain mounting plate	2000	600	NSYMP206
Plain mounting plate	2000	800	NSYMP208
Plain mounting plate	2000	1000	NSYMP2010
Plain mounting plate	2000	1200	NSYMP2012

SMX SFX Uprights vertical



Characteristics	Height (mm)	References
Uprights vertical, Standard	1800	NSYVR18
Uprights vertical, Standard	2000	NSYVR20
Uprights vertical, Technical	1400	NSYTVR14
Uprights vertical, Technical	1600	NSYTVR16
Uprights vertical, Technical	1800	NSYTVR18
Uprights vertical, Technical	2000	NSYTVR20

Eyebolts



- Material: Stainless-steel 304L
- Installation: By the fixing nuts supplied
- Maximum load: 340 kg for 1 eyebolt in vertical direction

Supply:
Set of four M12 eyebolts

Characteristics	References
Eyebolt	NSYSMXEB

SFX Lifting bracket



- Material: Treated steel
- Installation: They are fixed instead of the eyebolts on two suitable enclosures side-by-side, helping guarantee the rigidity of the enclosure when lifted
- Maximum load: 1300 kg when slinging at 60°

Supply:
Set of four lifting brackets

Characteristics	References
Lifting bracket for SFX	NSYPUNX

SMX Wall fixing lugs



- Material: Stainless-steel 304L
- Installation: Mounting of the wall fixing lugs in horizontal or vertical position; Fixing from the outside

Supply:
Set of four wall fixing lugs

Characteristics	References
Wall fixing lugs for SMX	NSYFCMX

Hygienic feet



- Recommended for applications that require special hygiene conditions.
- Material: 316L stainless-steel
- Installation: Adjustable between 140 mm and 200 mm in height
- Maximum load: 200 kg per foot.

Supply:
Set of 4 adjustable feet

Characteristics	References
Hygienic feet	NSYPHX200

SFX Coupling kit

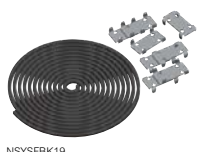

- Used for joining enclosures side by side.
- Material: Flat connectors and brackets: Zinc-coated steel (**NSYSFBK19**); Sealing gasket: EPDM (**NSYSFXJG**)
- Ingress protection rating: IP55
- Installation: Fixing from the inside of the enclosures

Characteristics	References
Coupling kit for SFX	NSYSFBK19
Coupling kit for SFX	NSYSFXJG

6

6

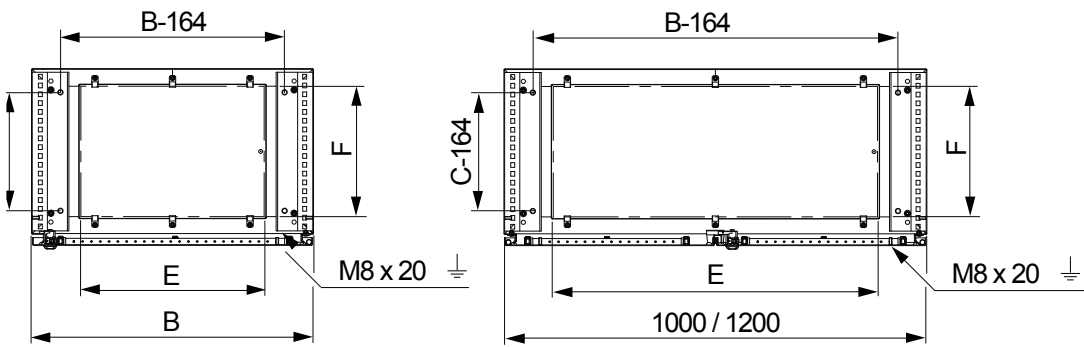
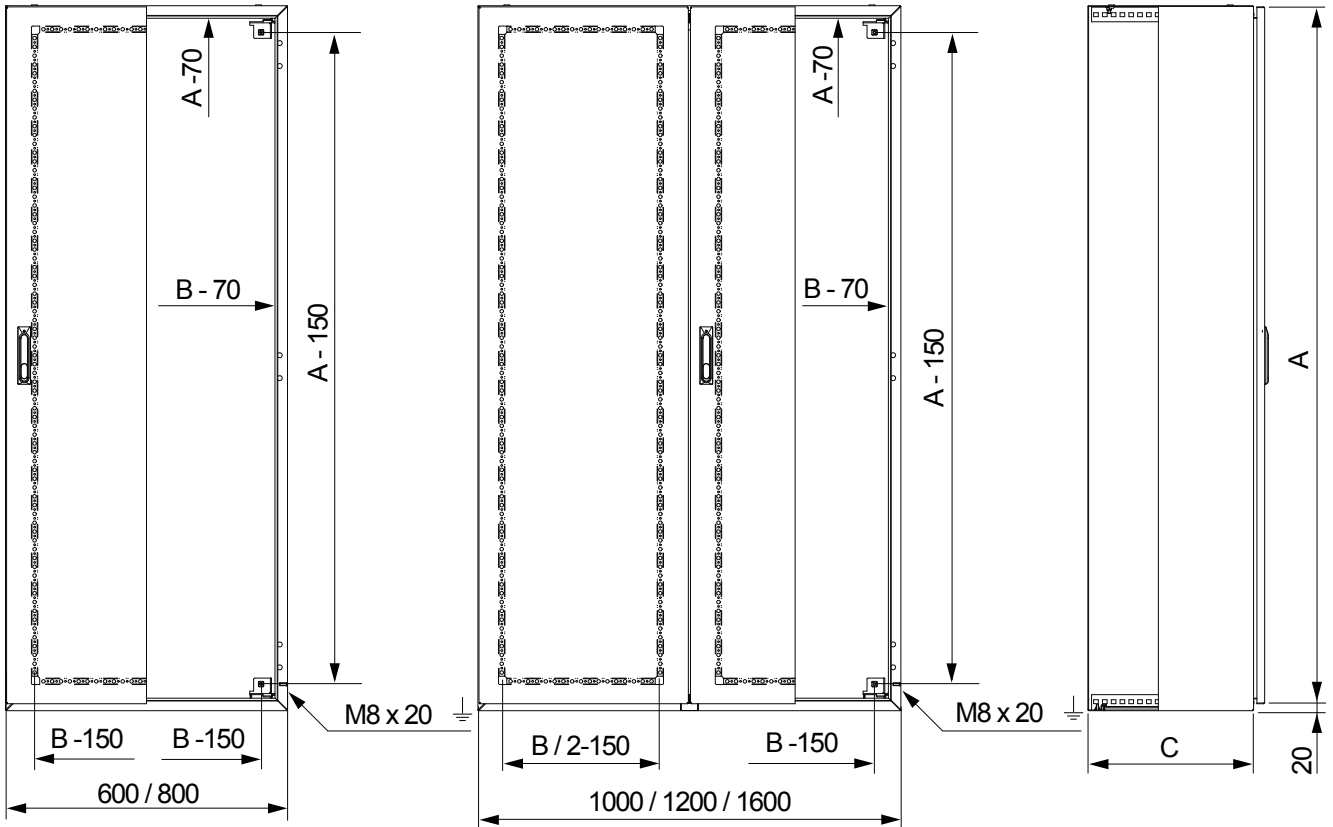

Enclosure width of 1000 and 1200 mm

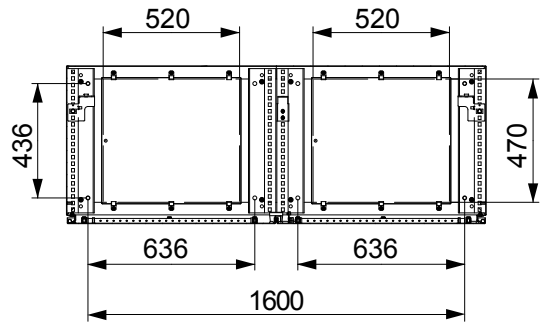

Enclosure width of 1600 mm

Floor-standing enclosure			No. of front doors	No. of cable gland plates	Dimensions	
Height (A) (mm)	Width (B) (mm)	Depth (C) (mm)			E (mm)	F (mm)
1400	1000	300	1	1	720	270
1600	800	400	1	1	520	270
1800	600	400	1	1	520	270
1800	800	400	1	1	520	270
1800	1200	400	2	1	920	270
1800	1600	400	2	2	1320	270
2000	800	500	1	1	520	370
2000	1000	400	2	1	720	270
2000	1200	500	2	1	920	370
2000	1600	600	2	2	1320	470

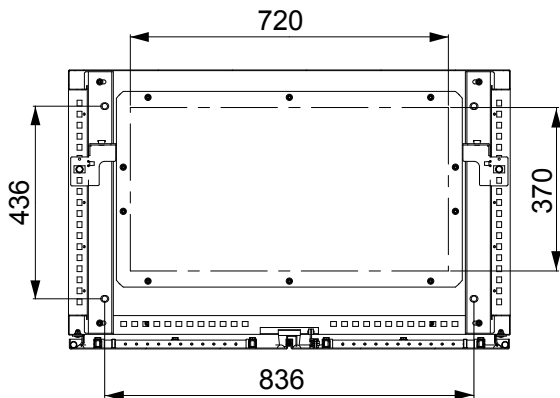
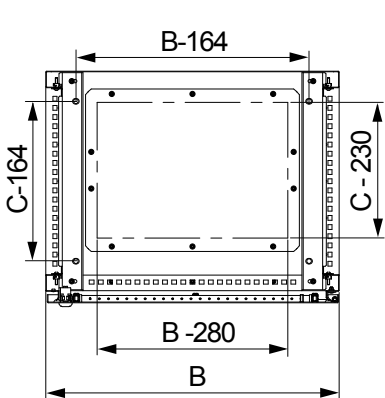
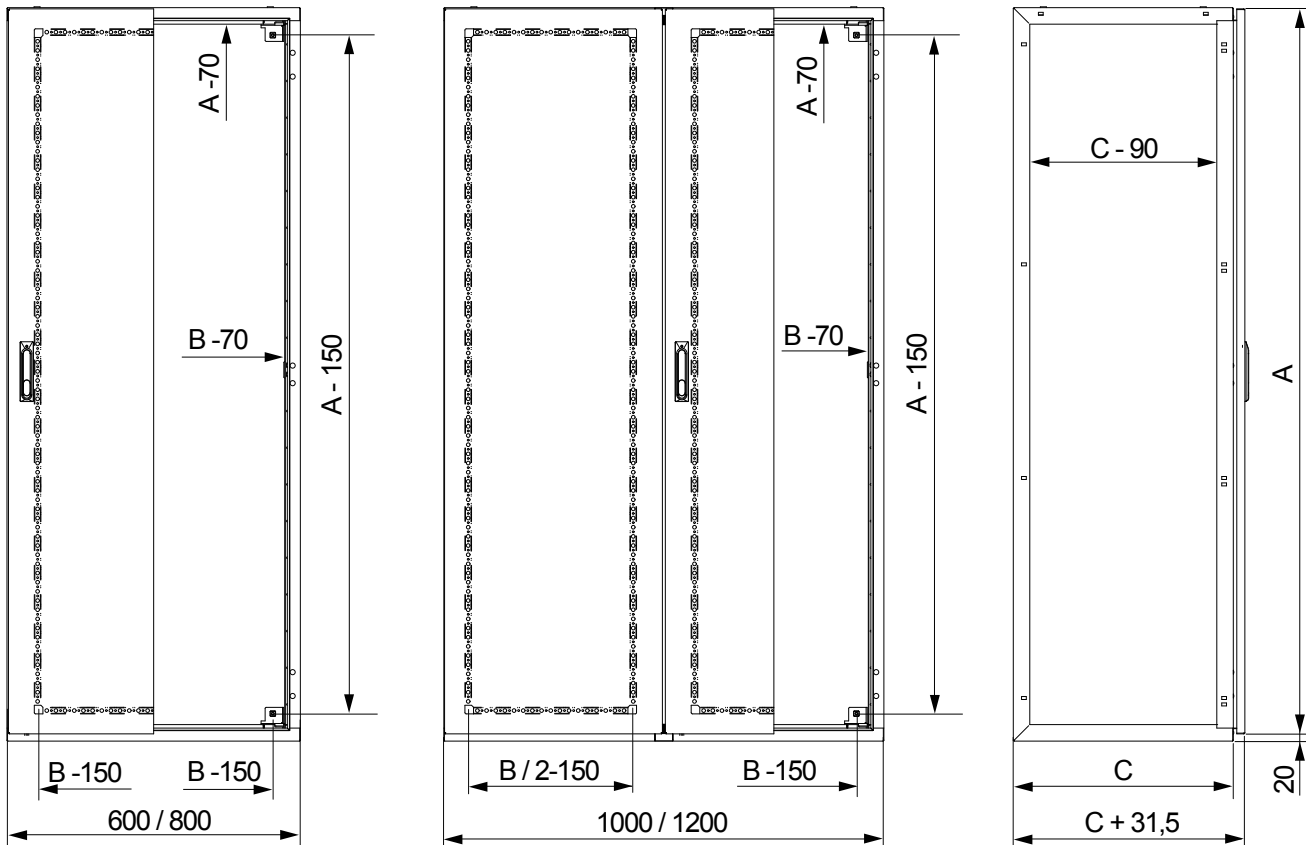

Enclosure width 1000

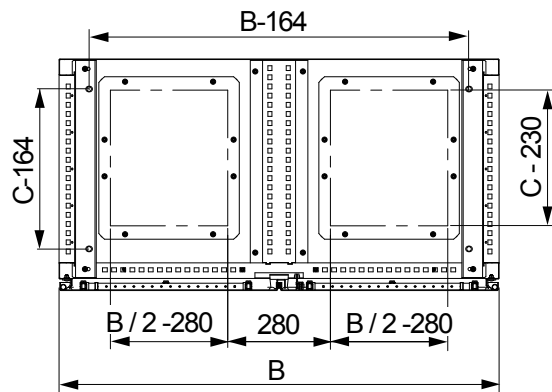

Enclosure width 1200 mm

External dimensions			Number of front doors	No. of cable gland plates
Height (A) (mm)	Width (B) (mm)	Depth (C) (mm)		
1800	600	400	1	1
1800	800	400	1	1
1800	1200	400	2	2
2000	600	500	1	1
2000	800	400	1	1
2000	800	600	1	1
2000	1000	600	2	1
2000	1200	600	2	2

Technical changes reserved. Information provided without guarantee. Images are for illustrative purposes only.

Insulated Boxes

Thalassa TBS



Thalassa TBP



7

Thalassa PLS



Thalassa TBS - TBP Insulated industrial boxes

Introduction	184
Characteristics	185
Selection guide	186
Specific accessories	188
Common accessories	192

Thalassa PLS Insulated modular boxes



Introduction	196
Characteristics	198
Selection guide	200
Accessories	202

Technical Guide

Insulated industrial boxes Dimensions	206
--	------------

Insulated industrial boxes:

- ABS for conventional applications (IK07) in regular operating conditions,
- polycarbonate for enhanced impact resistance (IK08) and for outdoor applications or applications directly exposed to UV,
- polycarbonate with certified UL (cULus) rating according to UL50E: type 4 4X, IP66 rating for all ranges, protection against electrical impacts of Class II.

This range can be configured according to your needs

4 different services available:



Assemble to order



Mounting of standard accessories



Painting



Machining



7



Easy to install

- 3 methods of fixing the box to its support



Smart

- Fixing studs on the cover.



Easy to use

- Only one tool is required: A flat-bladed screwdriver.

See [page 546](#) for details or consult our web site www.se.com



Class II



Characteristics	Universal boxes rated IP66	ABS boxes with push-buttons rated IP54	ABS boxes prepared for push-buttons
	Boxes can be coupled (exactly the same dimensions) with kit ref. 13934 . Locks from box size of 116 x 116 x 62 mm: <ul style="list-style-type: none"> • Cover locking by 4 plastic captive screws with coarse thread outside the sealed area, • Plumbable lock. Locks from box size of 138 x 93 x 72 mm: <ul style="list-style-type: none"> • The standard screws (flat-bladed screwdriver) can be replaced with other standardised screws. The 4 reinforced edges of the cover ensure its robustness and perfect support during customization operations. Adaptable hinges on all the 20 and 40 mm covers.		
Material	ABS boxes: <ul style="list-style-type: none"> • Transparent cover made of polycarbonate • Glow wire resistance: 650 °C according to IEC 60695-2-11 • Operating temperature: -25 °C...+60 °C • Installation temperature: -15 °C...+40 °C Polycarbonate boxes: <ul style="list-style-type: none"> • Glow wire resistance: 960 °C • Operating temperature: -25 °C...+80 °C • Installation temperature: -15 °C...+60 °C 	ABS boxes: <ul style="list-style-type: none"> • Glow wire resistance: 650 °C according to IEC 60695-2-11 • Operating temperature: -25 °C...+60 °C • Installation temperature: -15 °C...+40 °C 	
Color	<ul style="list-style-type: none"> • Body: RAL 7035 grey • Cover: RAL 7035 grey or transparent 		
Ingress protection rating	IP66 according to IEC 60529	IP54 according to IEC 60529	-
Mechanical protection rating	ABS: IK07 according to IEC 62262 Polycarbonate: IK08 according to IEC 62262	ABS: IK07 according to IEC 62262	
Standards	IEC 62208		
Certifications	<ul style="list-style-type: none"> • IEC 62208 certified by TÜV • UL (cULus) : Polycarbonate Range • Product Environmental Profile • Class II according to IEC 61140 Polycarbonate range: <ul style="list-style-type: none"> • Rating according UL50E : Types 4, 4X • Self-extinguishing 		<ul style="list-style-type: none"> • IEC 62208 certified by TÜV • Product Environmental Profile • Class II according to IEC 61140
Installation	Fixing the box: <ul style="list-style-type: none"> • Outside the sealed sensitive volume by the 4 chimneys in the corners from box size of 138 x 93 x 72 mm • Through the rear of the box by 2 or 4 elongated holes to be perforated • With fixing lugs from box size of 116 x 116 x 62 mm (ref. NSYAEFTB) Outdoor installation, only for polycarbonate range: Compliant with IEC 62208 regarding type tests specified in §9.12 (resistance UV radiation) and §9.13 (resistance to corrosion). Equipment installation: <ul style="list-style-type: none"> • Studs for fixing the equipment in the body and the cover of the box by means of a Ø 4 mm self-tapping screw (ref. NSYAMFSTB, screw Ø 4 x 10 mm with Pozidriv and slotted head) • Option of installing rails, plates or other types of supports (card, etc.) • Spacers and stand-offs to be installed on the studs for adjusting the height of the equipment 		

7







Comment:

For outdoor use and based on the configuration of the installation, a canopy must be installed on the top of the boxes or the boxes should be installed under a shelter to protect them against the different weather conditions and to avoid water stagnation between body and lid. Anti-condensation valves must be installed to prevent condensation and deformations of the boxes.

Comment:
For dimensions see [page 206](#)

Overall external dimensions			Overall internal dimensions			Body (mm)	Cover (mm)	Minor pack.	Cover screw
Height (mm)	Width (mm)	Depth (mm)	Height (mm)	Width (mm)	Depth (mm)				
74	74	54	65	65	47	37	10	5	Metal
89	89	54	80	80	47	37	10	5	Metal
116	74	62	105	65	55	45	10	5	Metal
116	74	94	105	65	85	45	40	3	Metal
116	116	62	105	105	55	45	10	5	Plastic
116	116	133	105	105	125	45	80	2	Plastic
138	93	72	125	80	65	45	20	2	Plastic
164	121	87	150	105	80	60	20	2	Plastic
192	121	87	175	105	80	60	20	2	Plastic
192	121	105	175	105	100	60	40	2	Plastic
192	164	87	175	150	80	60	20	1	Plastic
192	164	105	175	150	100	60	40	1	Plastic
241	194	87	225	175	80	60	20	1	Plastic
241	194	107	225	175	100	80	20	1	Plastic
241	194	107	225	175	100	60	40	1	Plastic
241	194	127	225	175	120	80	40	1	Plastic
291	241	88	275	225	80	60	20	1	Plastic
291	241	128	275	225	120	100	20	1	Plastic
291	241	128	275	225	120	60	60	1	Plastic
291	241	168	275	225	160	100	60	1	Plastic
341	291	128	325	275	120	100	20	1	Plastic
341	291	168	325	275	160	100	60	1	Plastic

Universal boxes with IP66			
ABS IP66 IK07		PC-UL IP66 IK08	
			
Opaque cover	Transparent cover	Opaque cover	Transparent cover
References	References	References	References
NSYTBS775	-	NSYTBP775	-
NSYTBS885	-	NSYTBP885	-
NSYTBS1176	-	NSYTBP1176	-
NSYTBS1179H	-	-	-
NSYTBS11116	-	NSYTBP11116	-
NSYTBS111113H	-	-	-
NSYTBS1397	NSYTBS1397T	NSYTBP1397	NSYTBP1397T
NSYTBS16128	NSYTBS16128T	NSYTBP16128	NSYTBP16128T
NSYTBS19128	NSYTBS19128T	NSYTBP19128	NSYTBP19128T
NSYTBS191210H	NSYTBS191210HT	NSYTBP191210H	NSYTBP191210HT
NSYTBS19168	NSYTBS19168T	NSYTBP19168	NSYTBP19168T
NSYTBS191610H	NSYTBS191610HT	NSYTBP191610H	NSYTBP191610HT
NSYTBS24198	NSYTBS24198T	NSYTBP24198	NSYTBP24198T
NSYTBS241910	NSYTBS241910T	NSYTBP241910	NSYTBP241910T
NSYTBS241910H	NSYTBS241910HT	NSYTBP241910H	NSYTBP241910HT
NSYTBS241912H	NSYTBS241912HT	NSYTBP241912H	NSYTBP241912HT
NSYTBS29248	NSYTBS29248T	NSYTBP29248	NSYTBP29248T
NSYTBS292412	NSYTBS292412T	NSYTBP292412	NSYTBP292412T
NSYTBS292412H	NSYTBS292412HT	NSYTBP292412H	NSYTBP292412HT
NSYTBS292416H	NSYTBS292416HT	NSYTBP292416H	NSYTBP292416HT
NSYTBS342912	NSYTBS342912T	NSYTBP342912	NSYTBP342912T
NSYTBS342916H	NSYTBS342916HT	NSYTBP342916H	NSYTBP342916HT

7



Mounting plates for adjustment to mounting surface

Installation:

- Fixing by means of Ø 4 mm self-tapping screws, Pozidrive and slotted head, ref. **NSYAMFSTB**

Supply:
Plates supplied without screws

Box Height (mm)	Width (mm)	Mounting plate dimensions		Minor pack.
		A (mm)	B (mm)	
192	164	168.5	140	1
241	194	215	168.5	1
291	241	265	215	1
341	291	315	265	1

Mounting plates	
	
Material: Galvanized steel	Material: Insulated polyester plate reinforced with fiberglass, halogen-free: Glow wire resistance 750 °C according to IEC 60695-2-11.
Thickness: 15/10° mm	Thickness: 25/10° mm
References	References
NSYAMP1916TB	NSYAMPA1916TB
NSYAMP2419TB	NSYAMPA2419TB
NSYAMP2924TB	NSYAMPA2924TB
NSYAMP3429TB	NSYAMPA3429TB

Button description

- Emergency-off function with a red, O 40 mm, turn-to-unlock palm button.
- Start/stop function with 2 push-buttons.
- Up/down/stop function with 3 push buttons.

Technical features of the switches:

- NC switch with positive opening maneuver according to IEC 60947-5-1 appendix K,
- Mechanical durability of the emergency switch: 0.1 million cycles,
- Mechanical durability of the NC and NO switches: 5 million cycles,
- Protection against short circuits: 10 A.

- Ref. **XALEK1702** houses an emergency switching off palm button with mechanical locking according to standards IEC 60364-5-53 and 60947-5-5.

Comment:

For dimensions see [page 206](#)

Boxes equipped with IP54 ABS buttons | ABS button boxes, to be equipped



Overall external dimensions			Overall internal dimensions			Body (mm)	Cover (mm)	Minor pack.	No. of holes	Function	References	References
Height (mm)	Width (mm)	Depth (mm)	Height (mm)	Width (mm)	Depth (mm)							
74	74	83	-	-	-	-	-	1	-	Emergency switching off	XALEK170	-
116	74	62	105	65	55	45	10, Grey	5	2	-	-	XALE2
116	74	62	105	65	55	45	10, Grey	5	3	-	-	XALE3
116	74	75	-	-	-	-	-	1	-	Start/stop	XALE2141	-
116	74	75	-	-	-	-	-	1	-	Up/down/stop	XALE3255	-

Function	Push-button type	Type NO	
Emergency switching off	Locking, red	1	
Start/stop			
Start	Flush, green	1	
Stop	Projecting, red	-	
Up/down/stop			
Up	Flush, black	-	
Down	Flush, white	-	
Stop	Projecting, red	-	

Function	Push-button type	Type NC	
Emergency switching off	Locking, red	1	
Start/stop			
Start	Flush, green	-	
Stop	Projecting, red	1	
Up/down/stop			
Up	Flush, black	-	
Down	Flush, white	-	
Stop	Projecting, red	1	

Function	Push-button type	Type C/O	
Emergency switching off	Locking, red	-	
Start/stop			
Start	Flush, green	-	
Stop	Projecting, red	-	
Up/down/stop			
Up	Flush, black	1	
Down	Flush, white	1	
Stop	Projecting, red	-	

Coupling kit



13934

The coupling kit allows you to join several boxes with dimensions from 138 x 93 mm.

- Material: Polystyrene, glow wire resistance: 650 °C according to IEC 60695-2-11
- Ingress protection rating: IP66 according to IEC 60529
- Installation: The kit is installed by drilling a hole with Ø 32 mm in the boxes to be coupled

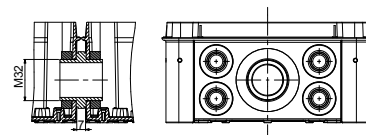

Supply:
The kit consists of 2 linking parts, nuts and seals

Characteristics	Drilling Ø	Minor pack.	Reference
Coupling kit	32 mm	1	13934

Sealed anti-condensation valve



NSYACAG12LPH1

Controls the pressure to avoid condensation and/or deformations of the boxes due to internal temperature changes. Protection of equipment for luminaires, industrial control, transportation, pumps, etc.

- Material: PA6-V2, acrylic co-polymer membrane, water and oil repellent
- Ingress protection rating: IP68
- Installation: The valve is installed by drilling a hole with Ø 12 mm in the box
- Operating temperature: -40...+105 °C
- Permeability: Air flow under $\Delta P = 0.7$ bar
- Pressure difference: Condition for IP68

Supply:
10 valves, nuts and seals

Characteristics	Permeability	Pressure difference	Drilling Ø	Minor pack.	Reference
Sealed anti-condensation valve IP68	16 litres/h	$\Delta P < 1$ bar	12 mm	1	NSYACAG12LPH1
Sealed anti-condensation valve IP68	120 litres/h	$\Delta P < 0.1$ bar	12 mm	1	NSYACAG12LPH2

7

Cover accessories Set



NSYAEDST820TB



NSYAEDSB520TB



NSYAEDS20TB

- The Thalassa boxes are delivered as standard with slotted-head screws for flat-bladed screwdriver from 4 to 5.5 mm.
- With box sizes from 138 x 93 x 72 mm, these screws can be replaced for screws with different standardised heads to comply with most cases.
- After removing the standard screw, simply position the new screw by pressing on it.
- The adapter clips (intermediate parts for tightening the cover on the body of the box) are the same as those for the standard screws. They are not delivered with the shaped screws.
- A single key for opening the boxes as well as the other enclosures of your installation.

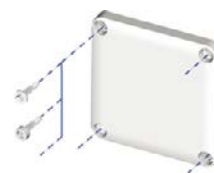

Supply:
Set of 4 shape screws

Characteristics	Minor pack.	Reference
Triangular screw Ø8 mm, for Thalassa boxes, Height of the lid 20 mm	1	NSYAEDST820TB
Double-bar screw Ø5 mm, for Thalassa boxes, Height of the lid 20 mm	1	NSYAEDSB520TB
Spare standard plastic screw for Thalassa boxes, Height of the lid 20 mm	1	NSYAEDS20TB
Spare standard plastic screw for Thalassa boxes, Height of the lid 40 mm	1	NSYAEDS40TB
Spare standard plastic screw for Thalassa boxes, Height of the lid 60 mm	1	NSYAEDS60TB

Cover accessories Pack



NSYAEDKTB

- The handle (or thumbwheel) allows the screws to be handled without any tools. It is ideally combined with a box equipped with hinges.
- It snaps onto the head of the standard plastic screw.

Supply:
Pack of 4 handles

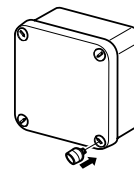

Characteristics	Minor pack.	Reference
Handles	1	NSYAEDKTB

4-hole terminal blocks



IMT34003



IMT34005



IMT34007

- The terminal-block support bar is particularly well suited to thermoplastic boxes.
- Boxes with sizes from 192 x 116 mm can accommodate a terminal-block support bar of 12 x 2 mm.
- The screw-type terminal blocks are easily clipped onto this bar.
- Terminal-block connection capacity: See selection table below.
- 4-hole terminal block length (Lb): 30 mm.
- The earth terminal snap fits into boxes with dimensions of less than 116 x 116 mm.

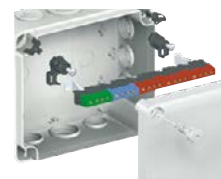

Supply:

Red (live) Minor pack. 10
Blue (neutral) Minor pack. 5
Green (earth) Minor pack. 5

Characteristics	Reference
4-hole terminal blocks 2 x 10 ² + 2 x 16 ² – Red (live)	IMT34003
Earth terminal block 2 x 252 – Red (live)	IMT34009
4-hole terminal blocks 2 x 10 ² + 2 x 16 ² – Blue (neutral)	IMT34005
4-hole terminal blocks 2 x 10 ² + 2 x 16 ² – Green (earth)	IMT34007

Terminal-block support bar

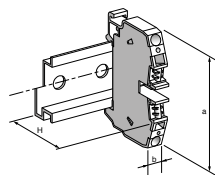

IMT34000

- Discover our complete terminal blocks range in **LVYED213001EN**.

Supply:

Minor pack. 1

Characteristics	No. of Terminal blocks 2 x 10 ² + 2 x 16 ² 4 holes	Support length Ls (mm)	Height or width (mm)	Min. depth (mm)	Reference
Terminal-block support bar	4	140	192	87	IMT34000
Terminal-block support bar	6	185	241	87	IMT34001
Terminal-block support bar	8	235	291	128	IMT34002



Hinges, set of 2 hinges



NSYAEDH20TB

- The hinges can be adapted to all covers with a height of 20 and 40 mm with dimensions from 138 x 93 mm.
- The hinge allows the lid to open fully to 200°.
- Ingress protection rating: IP66 according to IEC 60529
- Installation: The hinge does not require any machining and is installed easily even with the box already equipped
- Maximum load: Hinged cover: 10 kg/m²

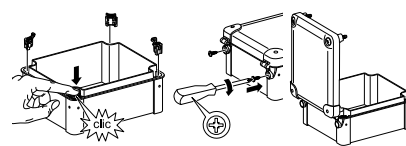

Supply:

The hinges (2 per set) are delivered with the fixings, minor pack 1

Characteristics	Height of the lid (mm)	References
Set of 2 hinges	20	NSYAEDH20TB
Set of 2 hinges	40	NSYAEDH40TB

Hinges, Set of 4 fixing lugs



NSYAEFTB

- Plastic fixing lugs for installation on boxes with dimensions from 116 x 116 mm.
- Option of vertical or horizontal installation.
- Installation: Installation by a single screw at the last moment, with the box closed and equipped
- Maximum load: Body: 30 kg/m², Cover: 10 kg/m²

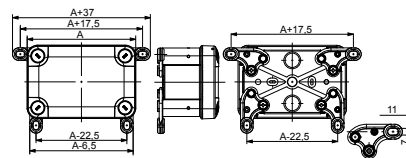

Supply:

4 lugs + screws, minor pack 1

Characteristics	Reference
Set of 4 fixing lugs	NSYAEFTB

Mounting plates



NSYAMP1916TB

- Mounting plates made to adapt to all usage scenarios.
- Material: Galvanized steel
- Thickness: 15/10^e mm
- Installation: Fixing by means of Ø 4 mm self-tapping screws, Pozidrive and slotted head, ref. **NSYAMFSTB**

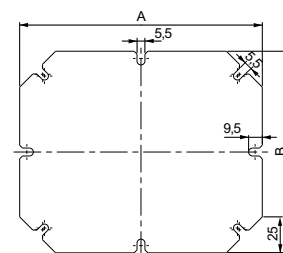

Supply:

Plates supplied without screws

Characteristics	Box		Dimensions		Minor pack.	References
	Height (mm)	Width (mm)	A (mm)	B (mm)		
Mounting plate	192	164	168.5	140	1	NSYAMP1916TB
Mounting plate	241	194	215	168.5	1	NSYAMP2419TB
Mounting plate	291	241	265	215	1	NSYAMP2924TB
Mounting plate	341	291	315	265	1	NSYAMP3429TB



NSYAMPA1916TB

- Mounting plates made to adapt to all usage scenarios.
- Material: Insulated polyester plate reinforced with fiberglass, halogen-free: Glow wire resistance 750 °C.
- Thickness: 25/10^e mm
- Installation: Fixing by means of Ø 4 mm self-tapping screws, Pozidrive and slotted head, ref. **NSYAMFSTB**

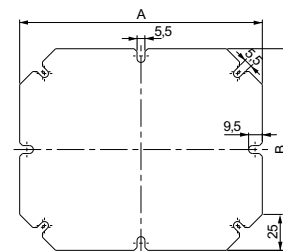

Supply:

Plates supplied without screws

Characteristics	Box		Dimensions		Minor pack.	References
	Height (mm)	Width (mm)	A (mm)	B (mm)		
Insulated mounting plate	192	164	168.5	140	1	NSYAMPA1916TB
Insulated mounting plate	241	194	215	168.5	1	NSYAMPA2419TB
Insulated mounting plate	291	241	265	215	1	NSYAMPA2924TB
Insulated mounting plate	341	291	315	265	1	NSYAMPA3429TB

Symmetric DIN rails

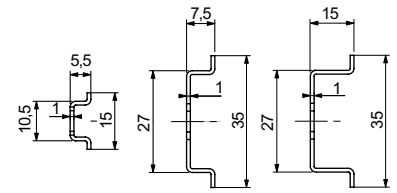

- A 15 x 5 mm rail is provided for the compact terminal blocks.
- Installation: Fixing of the rails with Ø 4 mm self-tapping screws, (not included), Pozidrive and slotted head, ref. **NSYAMFSTB**

Supply:
Supplied without screws
(except for the 15 x 5 mm rails)



NSYAMRD11155TB

Characteristics	Height (mm)	Depth (mm)	Length (mm)	Box (mm)	References
Symmetric DIN rail	15	5	97	105	NSYAMRD11155TB
Symmetric DIN rail	15	5	140	150	NSYAMRD16155TB
Symmetric DIN rail	15	5	168	175	NSYAMRD19155TB
Symmetric DIN rail	15	5	214	225	NSYAMRD24155TB
Symmetric DIN rail	15	5	264	275	NSYAMRD29155TB
Symmetric DIN rail	15	5	316	325	NSYAMRD34155TB



NSYAMRD11357TB

Symmetric DIN rail	35	7.5	97	105	NSYAMRD11357TB
Symmetric DIN rail	35	7.5	140	150	NSYAMRD16357TB
Symmetric DIN rail	35	7.5	168	175	NSYAMRD19357TB
Symmetric DIN rail	35	7.5	214	225	NSYAMRD24357TB
Symmetric DIN rail	35	7.5	264	275	NSYAMRD29357TB
Symmetric DIN rail	35	7.5	316	325	NSYAMRD34357TB



NSYAMRD243515TB

Symmetric DIN rail	35	15	214	225	NSYAMRD243515TB
Symmetric DIN rail	35	15	264	275	NSYAMRD293515TB
Symmetric DIN rail	35	15	316	325	NSYAMRD343515TB

Screws for rails



NSYAMFSTB

- Ø 4 x 10 mm

Supply:
Pack of 100 screws

Characteristics	References
Screws Ø4 mm, height 10 mm	NSYAMFSTB

Simple-1	Simple-2	Simple-3	Simple-4	Simple-5	Synthetic snap-in cable gland
					
Mixed membrane entries for enclosure thickness 20/10° - 32/10° mm.	PVC adjustable cone-shaped entries for enclosure thickness 30/10° - 32/10° mm.	Quick cable entries for enclosure thickness 10/10° - 40/10° mm (5/10° - 20/10° mm for ref. IMT36179).	PVC adjustable cone-shaped entries for PG tubes or for enclosure thickness 12/10° - 15/10° mm.	ISO cable gland	Without thread. Easy assembly and dis-assembly. Suitable for walls from 0,5 to 4 mm thick.
ISM71071 ISM71072 ISM71073 ISM71074 IMT36172 IMT36173	NSYECPC3 NSYECPC5 NSYECPC6 NSYECPC9 NSYECPC15	IMT36179 IMT36180 IMT36181 IMT36182 IMT36183 IMT36184 IMT36185	NSYEC7	ISM71501 ISM71502 ISM71503 ISM71504 ISM71505 ISM71506 IMT36150	NSYCGSP16 NSYCGSP20 NSYCGSP25 NSYCGSP32 NSYCGSP40

Accessories bag for enclosure TBS/TBP

7



NSYTBPASBS

Simple-1

Characteristics	References
Spare Parts	NSYTBPASBS

- Mixed membrane entries for enclosure thickness 20/10° - 32/10° mm.
- Material: SBS
- Color: RAL 7035 grey or RAL 9010 white
- Cable entry material: Soft membrane
- Cable glands to be fitted: Not applicable
- Installation options: On cable gland plate or directly on enclosure
- Flexibility of the installation: Low
- Reversibility: Medium
- Ingress protection rating: IP55 according to IEC 60529
- Cable retention: Low
- Cable diameter (mm): From 20 to 40
- Cable Installation time: Fast
- Quantity of cables to be fitted for a given surface: +
- Cable entries for cables with connectors: No
- Cut-out dimensions (mm): Various circular hole diameters according to cable diameter
- External dimensions (mm): From Ø 23 to 44
- Flame resistance: 750 °C

Supply:
Minor packaging of 10 pieces



ISM71074

Characteristics	Drill hole Ø (mm)	Cable / conduit Ø (mm)	References
Mixed membrane entries for IP55 direct cable entries, RAL 9010	23	4 - 20	IMT36172
Mixed membrane entries for IP55 direct cable entries, RAL 9010	29	4 - 25	IMT36173
Mixed membrane entries for IP55 direct cable entries, RAL 7035	23	4 - 20	ISM71071
Mixed membrane entries for IP55 direct cable entries, RAL 7035	29	4 - 25	ISM71072
Mixed membrane entries for IP55 direct cable entries, RAL 7035	36	4 - 32	ISM71073
Mixed membrane entries for IP55 direct cable entries, RAL 7035	44	4 - 40	ISM71074

Simple-2

- PVC adjustable cone-shaped entries for enclosure thickness 30/10^e - 32/10^e mm.
- Material: PVC
- Cable entry material: Soft membrane
- Cable glands to be fitted: Not applicable
- Installation options:
 - On cable gland plate or directly on enclosure
- Flexibility of the installation: Low
- Reversibility: Medium
- Ingress protection rating: IP55 according to IEC 60529
- Cable retention: Low
- Cable diameter (mm): From 5 to 87
- Cable Installation time Fast
- Quantity of cables to be fitted for a given surface: +
- Cable entries for cables with connectors: No
- Cut-out dimensions (mm): Various circular hole diameters according to cable diameter
- External dimensions (mm): From Ø 25 to 98

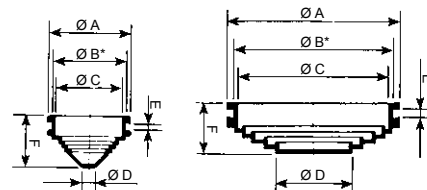

Supply:
NSYECPC3 50 cable entries, **NSYECPC5** and **NSYECPC6** each 25 cable entries, **NSYECPC9** and **NSYECPC15** each 10 cable entries



NSYECPC15

Characteristics	Dimensions (mm)						Capacity		References
	Ø A	Ø B	Ø C	Ø D	E	F	Cable (Ø mm)	Tube	
PVC adjustable cone-shaped entrie 25x3 mm	25	21.5	18	5	3.2	13	5-18	PG 9-11	NSYECPC3
PVC adjustable cone-shaped entrie 32x3 mm	33	29.5	26	5	3.2	20	5-26	PG 9-16	NSYECPC5
PVC adjustable cone-shaped entrie 43x3 mm	43	38.5	36	5	3.2	22	5-36	PG 9-21	NSYECPC6
PVC adjustable cone-shaped entrie 70x3 mm	70	63	60	28	3	20	28-60	PG 21-48	NSYECPC9
PVC adjustable cone-shaped entrie 98x3 mm	98	90	87	28	3	23	28-87	PG 21-48	NSYECPC15

Simple-3

- Quick cable entries for enclosure thickness 10/10^e - 40/10^e mm (5/10^e - 20/10^e mm for ref. **IMT36179**).
- Material: EPDM plastic
- Color: Grey cable entries: NCS 5500; Black cable entries: NCS 9000
- Cable entry material: Combined
- Cable glands to be fitted: Not applicable
- Installation options: On cable gland plate or directly on enclosure
- Flexibility of the installation: Low
- Reversibility: Medium
- Ingress protection rating: IP67 according to IEC 60529
- Cable retention: Medium
- Cable diameter (mm): From 12 to 50
- Cable Installation time: Fast
- Quantity of cables to be fitted for a given surface: +
- Cable entries for cables with connectors: No3
- Cut-out dimensions (mm): Various circular hole diameters according to cable diameter
- External dimensions (mm): From Ø 12.5 to 50.7
- Flame resistance: 750 °C

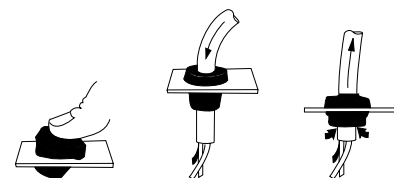

Supply:
 50 (M12 to M32)
 25 (M40 and M50)



IMT36179

Characteristics	Dimensions			References
	ISO	Drill hole (Ø mm)	Cable (Ø mm)	
Quick cable entries	M12	12.5	3 - 5	IMT36179
Quick cable entries	M16	16	5 - 7	IMT36180
Quick cable entries	M20	20.3	7 - 10	IMT36181
Quick cable entries	M25	25.3	10 - 14	IMT36182
Quick cable entries	M32	32.4	14 - 20	IMT36183
Quick cable entries	M40	40.7	20 - 26	IMT36184
Quick cable entries	M50	50.7	26 - 35	IMT36185

PVC adjustable cone-shaped entries

- PVC adjustable cone-shaped entries for PG tubes or for enclosure thickness 12/10^a - 15/10^a mm.
- Material: PVC
- Color: Black
- Cable entry material: Combined
- Cable glands to be fitted: Not applicable
- Installation options: On cable gland plate or directly on enclosure
- Flexibility of the installation: Low
- Reversibility: Medium
- Ingress protection rating: IP55 according to IEC 60529
- Cable retention: Low
- Cable diameter (mm): From 16 to 44
- Cable Installation time: Fast
- Quantity of cables to be fitted for a given surface: +
- Cable entries for cables with connectors: No
- Cut-out dimensions (mm): Various circular hole diameters according to cable diameter
- External dimensions (mm): From Ø 25 to 52

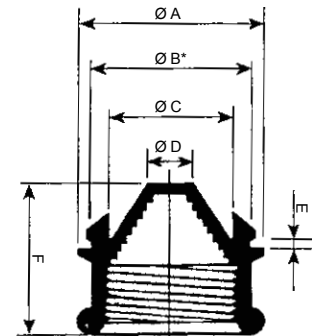

Supply:
25 cable entries

Characteristics	Dimensions (mm)						Capacity		References
	Ø A	Ø B	Ø C	Ø D	E	F	Cable (Ø mm)	Tube	
PVC adjustable cone-shaped entries	52	48.5	44	13	1.5	30	13 to 44	PG 36	NSYEC7



NSYEC7

7

Simple-5

- ISO cable gland
- Material: PA6 Polyamide, neoprene gasket
- Color: RAL 7035 grey
- Cable entry material: Combined
- Installation options: On cable gland plate or directly on enclosure
- Flexibility of the installation: Low
- Reversibility: Medium
- Ingress protection rating: IP68
- Cable retention: High
- Cable diameter (mm): From 12 to 40
- Cable Installation time: Slow
- Quantity of cables to be fitted for a given surface: +
- Cable entries for cables with connectors: No
- Cut-out dimensions (mm): Various circular hole diameters according to cable diameter
- External dimensions (mm): From Ø 15 to 46
- Certificates: UL
- Flame resistance: 750 °C

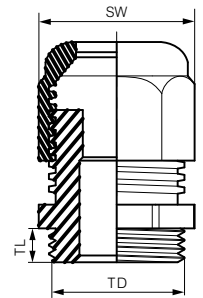

Supply:
The cable glands are supplied with nuts Pack of 20 (M12 to M20), of 10 (M25 and M32), of 5 (M40)

Characteristics	Dimensions					References
	Cable (Ø mm)	Drill hole (Ø mm)	TD	TL	SW	
Cable gland M12, RAL 7035	3 / 6.5	12.2 (0 + 0.2)	12	6	15	ISM71501
Cable gland M16, RAL 7035	4 / 8	16.2 (0 + 0.2)	16	8	19	ISM71502
Cable gland M20, RAL 7035	6 / 12	20.2 (0 + 0.2)	20	10	24	ISM71503
Safety Cable gland M20, RAL 3000	6 / 12	20.2 (0 + 0.2)	20	10	24	IMT36150
Cable gland M25, RAL 7035	11 / 17	25.2 (0 + 0.2)	25	8	29	ISM71504
Cable gland M32, RAL 7035	15 / 21	32.2 (0 + 0.3)	32	10	36	ISM71505
Cable gland M40, RAL 7035	19 / 28	40.5 (0 + 0.3)	40	10	46	ISM71506



ISM71503

Synthetic snap-in cable gland

- Without thread.
- Easy assembly and disassembly.
- Suitable for walls from 0.5 to 4 mm thick.
- Material: PA6 Polyamide, neoprene gasket
- Color: RAL 7035 grey, RAL 7001, RAL 9005. Other colors on demand
- Cable entry material: Non armoured
- Installation options:
 - On cable gland plate or directly on enclosure
- Flexibility of the installation: Low
- Reversibility: Medium
- Ingress protection rating: IP66
- Cable retention: High
- Cable diameter (mm): From 16 to 40
- Cable Installation time: Slow
- Quantity of cables to be fitted for a given surface: +
- Cable entries for cables with connectors: No
- Thread type: Metric EN 60423
 - Other types are available on demand
- Cut-out dimensions (mm): Various circular hole diameters according to cable diameter
- External dimensions (mm): From Ø 22 to 46
- Certificates: UL 94 V-2 (except for the size M40)
- Standard: DIN EN 62444, UL 514B, UL 514B§8.26.7
- Temperature range: -20 °C to + 100 °C

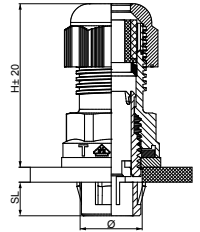

Supply:
The cable glands are supplied with nuts Pack of 20 (M16 and M20), of 10 (M25 and M32), of 5 (M40)



NSYCGSP16

Characteristics	Dimensions (mm)							References
	Ø	Ø min / max	Drill Ø	SL	SD	H		
Synthetic snap-in cable gland	M16	5/10	16.2 to 16.4	9	15.9	42.5	22	NSYCGSP16
Synthetic snap-in cable gland	M20	6/12	20.2 to 20.4	9	19.9	41.5	24	NSYCGSP20
Synthetic snap-in cable gland	M25	11/17	25.2 to 25.4	9	24.9	43.5	29	NSYCGSP25
Synthetic snap-in cable gland	M32	15/21	32.2 to 32.4	9	31.9	49.5	36	NSYCGSP32
Synthetic snap-in cable gland	M40	19/28	40.2 to 40.4	11.5	39.9	56	46	NSYCGSP40

Snap-in cable gland disassembling tool

- Material: Plastic



NSYDT16



NSYDT20

Characteristics	Ø	References
Tool to quickly disassemble cable gland	M16	NSYDT16
Tool to quickly disassemble cable gland	M20	NSYDT20
Tool to quickly disassemble cable gland	M25	NSYDT25
Tool to quickly disassemble cable gland	M32	NSYDT32
Tool to quickly disassemble cable gland	M40	NSYDT40



7

PLS boxes: Polyester rear and PC transparent cover with wing screws for manual opening

This range can be configured according to your needs

4 different services available:



Assemble to order



Mounting of standard accessories



Painting



Machining

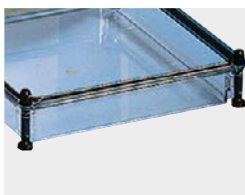

Protection

IP66.
Gasket between body and cover.
IK09.
Insulation Class II.

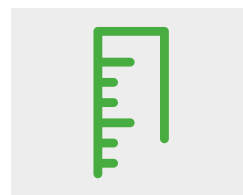

Modular

The dimensions of the sides, multiples of 9 cm, allow the creation of assemblies.



Easy

Bosses with inserts, at the rear of the body, for fixing plates or various supports.

See [page 546](#) for details or consult our web site www.se.com



Prolonged exposure to UV radiation, wind and rain can cause aesthetics changes in the external surface of the enclosure. Without affecting the technical properties according to IEC 62208. For long exposure applications, it is recommended to use painted enclosures available through the P&S offer.



Class II



Complete box

Characteristics	NSYPLS5454AG	NSYPLS1827G	NSYPLSC5472AG	NSYPLSC1827G	NSYPLSP1827G
	<ul style="list-style-type: none"> Insulated boxes that can be coupled by all their side surfaces, allowing the creation of the greatest variety of modular assemblies. The product references show the two lateral dimensions in cm. 14 sizes of insulated boxes; The sides are multiples of 9 cm. Body made from polyester reinforced with fiberglass, molded by hot compression, 9 sizes. 3 types of cover available according to the sizes: <ul style="list-style-type: none"> Standard cover, made from transparent polycarbonate with neoprene gasket, 45 mm high, or 95 mm high (final index A) according to the sizes, Opaque polycarbonate cover (index C), with neoprene gasket, 45 mm high, or 95 mm high (final index A) according to the sizes, Polyester reinforced with fiberglass cover (index P) with PUR gasket, 45 mm high. Complete box includes body, cover, locking screws and sealing device. The bodies (prefix F) and the covers (prefix T) are supplied separately as standard references. The separate covers are supplied without locking screws or sealing accessories. The PLS enclosures with transparent cover are also offered in sets; The reference refers to the complete set. Excellent resistance to corrosion; withstands most chemical substances. Full insulation to create Class II assemblies. Standard lock with slot screws outside the volume of the boxes. Delivered with sealing system. External wall-mounted by 4 lugs, to be ordered separately. Service temperature: -40 to +80 °C. Bosses with M6 inserts for fixing the mounting plate. Halogen-free and compliant with the RoHS directive. 				
Color	RAL 7035 grey (opaque bodies and cover)				
Ingress protection rating	IP66				
Mechanical protection rating	IK09				
Certifications	<ul style="list-style-type: none"> Certification according to standard IEC 62208 to ensure compliance with IP, IK, resistance to heat and fire (self-extinguishing), insulation to 5000 V, and load of the mounting plate, 100 kg/m² Certified UL (cULus). Rating according UL50E Type 1, 2, 3, 3R, 4, 4X, 12 and 13 				
Installation	Outdoor installation: Compliant with IEC 62208 regarding type tests specified in §9.12 (resistance to UV radiation) and §9.13 (resistance to corrosion). It is always advisable to install a canopy to avoid water stagnation on the top of the enclosure and to protect against UV radiation..				
Options	-				
Supply	-				

* NSYPLS, NSYPLSP and NSYPLSC followed by suffixes.



Insulated modular boxes with modular distribution chassis

NSYDLS12

PLS boxes, polyester body and PC transparent cover with hinges and wing screws for manual opening. Built-in DLS modular chassis, made up of an insulated protection panel, RAL 7011 color, 35-mm DIN rails and a 2 x 16 + 5 x 6 mm² neutral/earth connection strip.

- Opening for cable entry, delivered with lock plate, ref. **NSYTL27270G**.
- Double-insulated installation.
- Plastic external hinges, allowing opening to 180°.
- Removable 36-mm blanking covers (2 modules):
1 per row in the standard offer.

-

IP43

IK09

-

Indoor

The boxes can be equipped with a double-bar lock and handle ref. **NSYCL27M**, or a lock with key ref. **NSYCL27L405**, by specific demand
The modular chassis can be ordered separately



Modular distribution chassis

NSYPLS1827DLS12

Built-in DLS modular chassis, made up of an insulated protection panel, RAL 7011 color, 35-mm DIN rails and a 2 x 16 + 5 x 6 mm² neutral/earth connection strip.

-

IP43

IK09

-

Indoor

-

-

Complete box





Dimensions			Transparent cover	Polycarbonate cover	Polyester cover
Height (mm)	Width (mm)	Depth (mm)	References	References	References
180	270	180	NSYPLS1827G	NSYPLSC1827G	NSYPLSP1827G
270	270	180	NSYPLS2727G	NSYPLSC2727G	NSYPLSP2727G
270	270	230	NSYPLS2727AG	NSYPLSC2727AG	-
270	360	180	NSYPLS2736G	NSYPLSC2736G	NSYPLSP2736G
270	360	230	NSYPLS2736AG	NSYPLSC2736AG	-
270	540	180	NSYPLS2754G	NSYPLSC2754G	NSYPLSP2754G
270	540	230	NSYPLS2754AG	NSYPLSC2754AG	-
360	270	180	-	-	-
360	270	180	-	-	-
360	360	180	NSYPLS3636G	NSYPLSC3636G	NSYPLSP3636G
360	540	180	NSYPLS3654G	NSYPLSC3654G	NSYPLSP3654G
360	540	230	NSYPLS3654AG	NSYPLSC3654AG	-
360	720	230	NSYPLS3672AG	NSYPLSC3672AG	-
540	270	180	-	-	-
540	540	180	NSYPLS5454G	NSYPLSC5454G	NSYPLSP5454G
540	540	230	NSYPLS5454AG	NSYPLSC5454AG	-
540	720	230	NSYPLS5472AG	NSYPLSC5472AG	-







Rear Low covers: 45 mm



Dimensions			Rear 135 mm	Transparent	Polycarbonate	Polyester
Height (mm)	Width (mm)	Depth (mm)	References	References	References	References
180	270	180	NSYFPLS1827G	NSYTPLS1827	NSYTPLSC1827G	NSYTPLSP1827G
270	270	180	NSYFPLS2727G	NSYTPLS2727	NSYTPLSC2727G	NSYTPLSP2727G
270	270	230	NSYFPLS2727G	-	-	-
270	360	180	NSYFPLS2736G	NSYTPLS2736	NSYTPLSC2736G	NSYTPLSP2736G
270	360	230	NSYFPLS2736G	-	-	-
270	540	180	NSYFPLS2754G	NSYTPLS2754	NSYTPLSC2754G	NSYTPLSP2754G
270	540	230	NSYFPLS2754G	-	-	-
360	360	180	NSYFPLS3636G	NSYTPLS3636	NSYTPLSC3636G	NSYTPLSP3636G
360	540	180	NSYFPLS3654G	NSYTPLS3654	NSYTPLSC3654G	NSYTPLSP3654G
360	540	230	NSYFPLS3654G	-	-	-
360	720	230	NSYFPLS3672G	-	-	-
540	540	180	NSYFPLS5454G	NSYTPLS5454	NSYTPLSC5454G	NSYTPLSP5454G
540	540	230	NSYFPLS5454G	-	-	-
540	720	230	NSYFPLS5472G	-	-	-

Insulated modular boxes with modular distribution chassis					Modular distribution chassis		Dimensions		
									
No. of 18 mm modules	No. of rows	Approximate weight (kg)	References	References	Height (mm)	Width (mm)	Depth (mm)		
12	1	1.7	NSYPLS1827DLS12	NSYDLS12	180	270	180		
24	2	2.5	NSYPLS2727DLS24	NSYDLS24	270	270	180		
-	-	-	-	-	270	270	230		
-	-	-	-	-	270	360	180		
-	-	-	-	-	270	360	230		
-	-	-	-	-	270	540	180		
-	-	-	-	-	270	540	230		
24	2	2.7	NSYPLS3627DLS24	NSYDLS242	360	270	180		
36	3	2.8	NSYPLS3627DLS36	NSYDLS36	360	270	180		
-	-	-	-	-	360	360	180		
-	-	-	-	-	360	540	180		
-	-	-	-	-	360	540	230		
-	-	-	-	-	360	720	230		
-	4	3.8	NSYPLS5427DLS48	NSYDLS48	540	270	180		
48	-	-	-	-	540	540	180		
-	-	-	-	-	540	540	230		
-	-	-	-	-	540	720	230		

7

High covers: 95 mm		Metal mounting plates		Insulated mounting plates		Dimensions		
								
Transparent	Opaque	Plain	Telequick	Polyester	Bakelite	Height (mm)	Width (mm)	Depth (mm)
References	References	References	References	References	References			
-	-	NSYPMM1827	NSYPMR1827	NSYPMA1827G	NSYPMB1827	180	270	180
-	-	NSYPMM2727	NSYPMR2727	NSYPMA2727G	NSYPMB2727	270	270	180
NSYTPLS2727A	NSYTPLSC2727AG	NSYPMM2727	NSYPMR2727	NSYPMA2727G	NSYPMB2727	270	270	230
-	-	NSYPMM2736	NSYPMR2736	NSYPMA2736G	NSYPMB2736	270	360	180
NSYTPLS2736A	NSYTPLSC2736AG	NSYPMM2736	NSYPMR2736	NSYPMA2736G	NSYPMB2736	270	360	230
-	-	NSYPMM2754	NSYPMR2754	NSYPMA2754G	NSYPMB2754	270	540	180
NSYTPLS2754A	NSYTPLSC2754AG	NSYPMM2754	NSYPMR2754	NSYPMA2754G	NSYPMB2754	270	540	230
-	-	NSYPMM3636	-	NSYPMA3636G	NSYPMB3636	360	360	180
-	-	NSYPMM3654	NSYPMR3654	NSYPMA3654G	NSYPMB3654	360	540	180
NSYTPLS3654A	NSYTPLSC3654AG	NSYPMM3654	NSYPMR3654	NSYPMA3654G	NSYPMB3654	360	540	230
NSYTPLS3672A	NSYTPLSC3672AG	NSYPMM3672	NSYPMR3672	NSYPMA3672G	NSYPMB3636	360	720	230
-	-	NSYPMM5454	NSYPMR5454	NSYPMA5454G	NSYPMB3654	540	540	180
NSYTPLS5454A	NSYTPLSC5454AG	NSYPMM5454	NSYPMR5454	NSYPMA5454G	NSYPMB3654	540	540	230
NSYTPLS5472A	NSYTPLSC5472AG	NSYPMM5472	NSYPMR5472	NSYPMA5472G	NSYPMB5472	540	720	230

Technical changes reserved. Information provided without guarantee. Images are for illustrative purposes only.

Wall fixing lugs



NSYPF27N



NSYPF27X

- Passivated zinc-coated steel
- Stainless-steel

Supply:
Set of 4 lugs and fixings

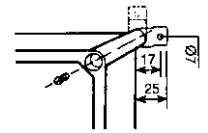

Characteristics	References
Wall fixing lug, passivated zinc-coated steel	NSYPF27N
Wall fixing lug, stainless-steel	NSYPF27X

Plastic carrying handle



NSYATM27

- Material: Plastic
- Ingress protection rating: IP43

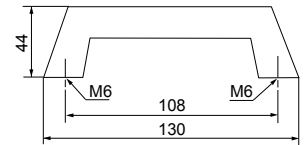

Characteristics	References
Plastic carrying handle	NSYATM27

Coupling frames



NSYUM27180

- Ingress protection rating: Frame with full opening: IP65 between enclosures

Characteristics	For surfaces (mm)	Opening (mm)	References
Full-opening frame	180	110	NSYUM27180
Full-opening frame	270	200	NSYUM27270
Full-opening frame	360	290	NSYUM27360

Comment:

Use the dimensional drawings of the boxes to identify which coupling frame you need. Consider the sides and surfaces you will join. Not UL-certified.

Comment:

Use the dimensional drawings of the boxes to identify which coupling frame you need. Consider the sides and surfaces you will join. Not UL-certified.

Supply:

References by unit. Order by multiples of 10 units (10, 20, 30, etc.).



NSYUCC270

- Ingress protection rating: Frame with full opening: IP44 between enclosures

Characteristics	For surfaces (mm)	Opening (mm)	References
Partial-opening frame	270	200	NSYUCC270
Partial-opening frame	360	290	NSYUCC360

Supply:

References by unit. Order by multiples of 10 units (10, 20, 30, etc.).

Side plates

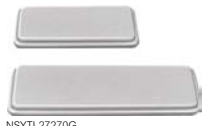

NSYTL27270G

- Ingress protection rating: IP65

Characteristics	For surfaces (mm)	Width (mm)	References
Side plate	270	200	NSYTL27270G
Side plate	360	290	NSYTL27360G

Box coupling unit piece



NSYPS2C27

- For coupling 2, 3 or 4 boxes, with optional wall-mounted.
- M6 x 8 mm screw with cylindrical head.

Characteristics	References
Box coupling unit piece for coupling 2 boxes	NSYPS2C27
Box coupling unit piece for coupling 3 or 4 boxes	NSYPS4C27

Supply:

To be ordered in multiples of 25

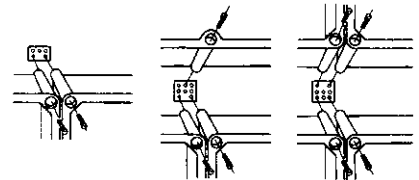

Closures for PLS boxes

- Slotted screw: Included in the standard references of boxes **NSYPLS●●●●**.
- Wing screw: Included in the standard references of modular distribution boxes **NSYPLS●●●●DLS●●●●**.
- Triangular screw: **NSYLT27**

Supply:
Set of 4, 6 or 8 screws.
The references also include 4 M6 screws for fixing mounting plates and 2 steel sealing accessories



NSYTCD274



NSYTCM274



NSYTCT274

Characteristics	Tool	References
Set of 4 slotted screws	Flat-blade screwdriver	NSYTCD274
Set of 6 slotted screws	Flat-blade screwdriver	NSYTCD276
Set of 8 slotted screws	Flat-blade screwdriver	NSYTCD278
Set of 4 wing screws	Manual	NSYTCM274
Set of 4 triangular screws	Triangular key	NSYTCT274

Closing locks



NSYCL27M



NSYCL27L405

- Option of installing a side lock on the opposite side to where the hinges are installed
- Ingress protection rating: IP43

Characteristics	Tool	References
Double-bar side lock and handle	NSYDBP	NSYCL27M
Side lock with key 405	Key 405	NSYCL27L405

Closing and opening



NSYLT27

Characteristics	References
Triangular key for PLS	NSYLT27

External hinges



NSYBE27G

- To open the door to 180°.
- Material: Plastic

Characteristics

External hinges, plastic

Comment:

IP level cannot be guaranteed due to type of application and installation

Supply:

Set of 2 hinges

References

NSYBE27G

Internal hinges



NSYBL27

- To open the door to 180°.
- Material: Brass

Characteristics

Internal hinges, brass

Comment:

IP level cannot be guaranteed due to type of application and installation

Supply:

Set of 2 hinges

References

NSYBL27

Box of 74 x 74 x 54 mm (external dimensions) NSYTB●●●775

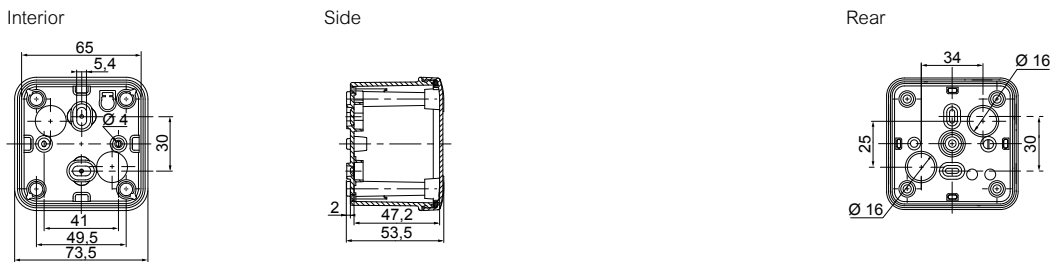

Box of 89 x 89 x 54 mm (external dimensions) NSYTB●●●885

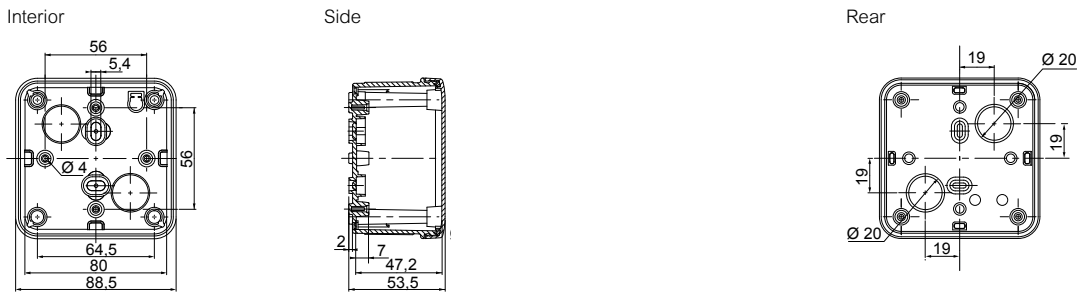

Box of 116 x 74 x 62 or 94 mm (external dimensions) NSYTB●●●1176 or NSYTB●●●1179

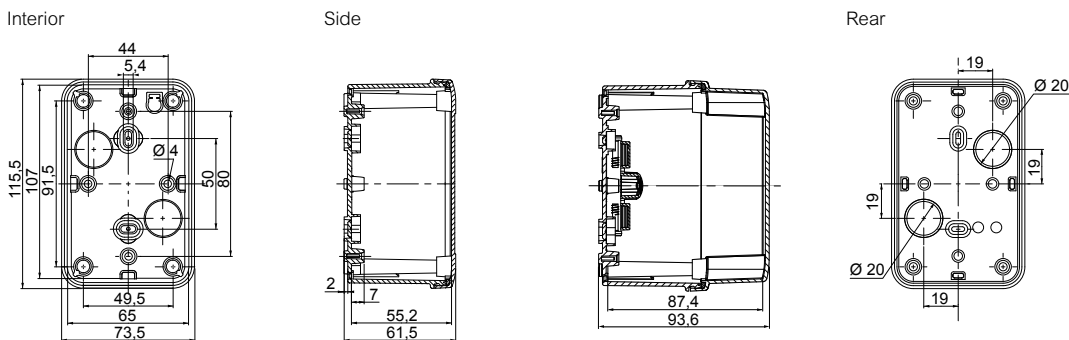

Box of 116 x 116 x 62 or 133 mm (external dimensions) NSYTB●●●11116 or NSYTB●●●11113

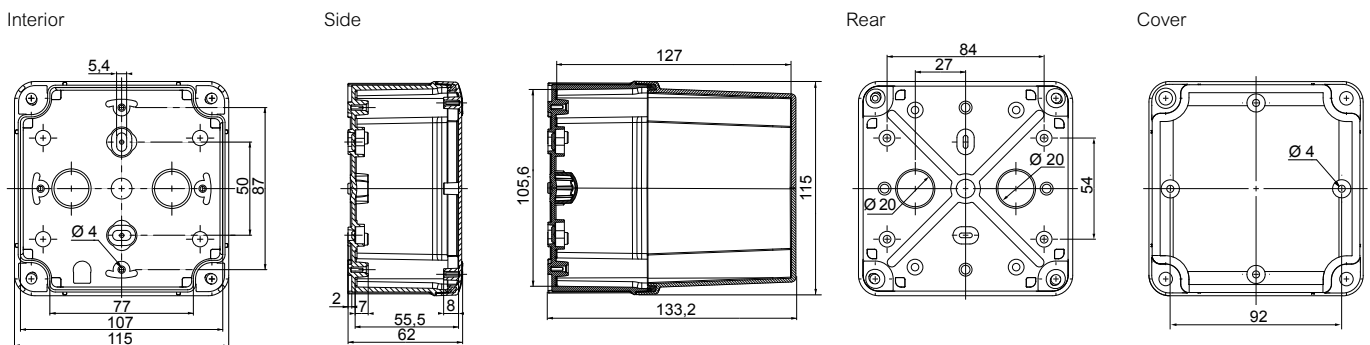

Box of 138 x 93 x 72 mm (external dimensions) NSYTB●●●1397



Technical changes reserved. Information provided without guarantee. Images are for illustrative purposes only.

Box of 164 x 121 x 87 mm (external dimensions) NSYTB●●●16128

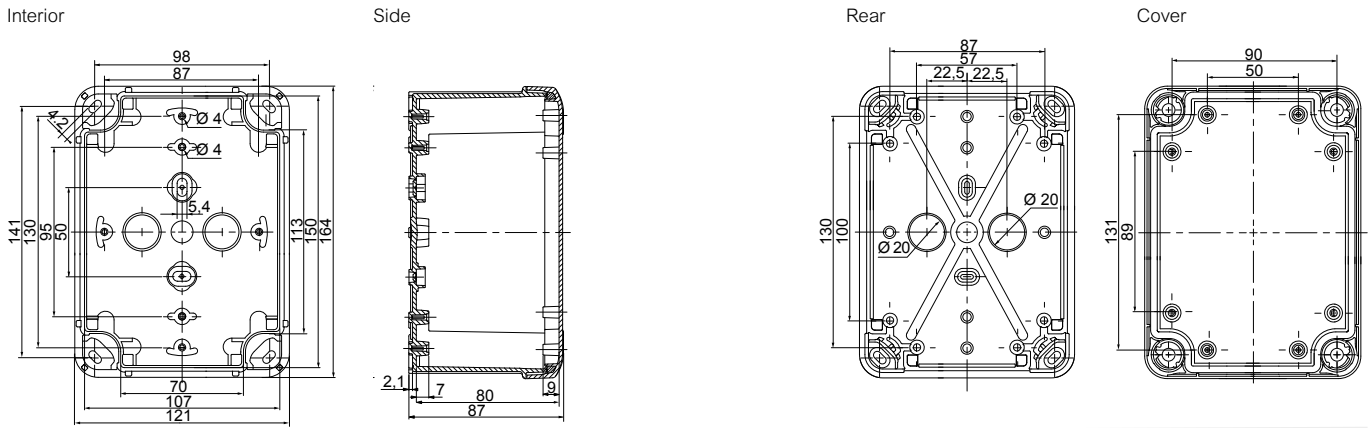

Box of 192 x 121 x 87 or 105 mm (external dimensions) NSYTB●●●19128 or NSYTB●●●191210

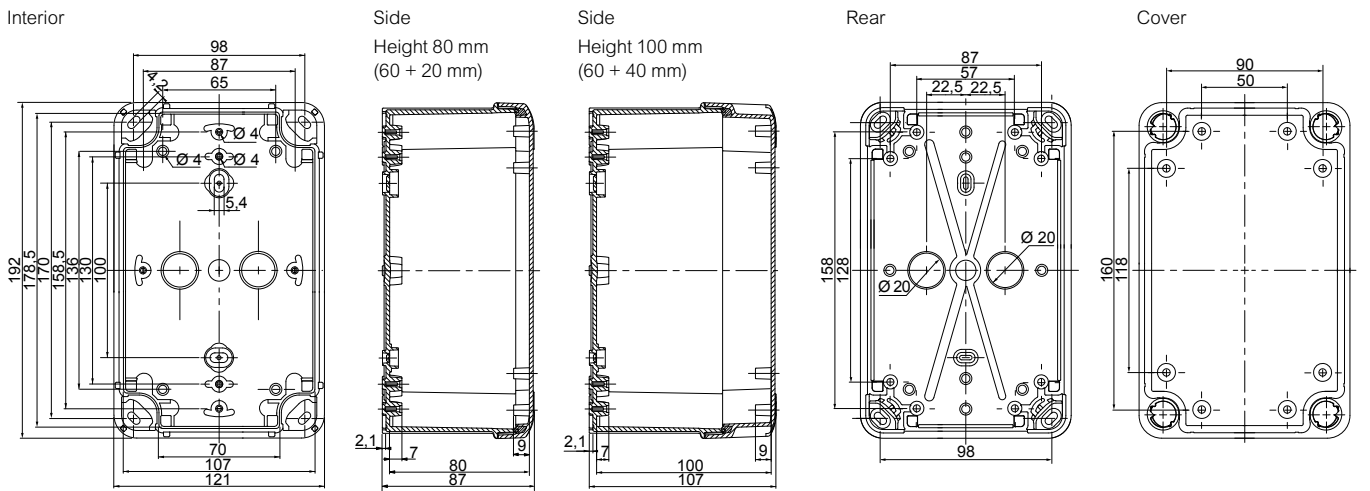

Box of 192 x 164 x 87 or 105 mm (external dimensions) NSYTB●●●19168 or NSYTB●●●191610

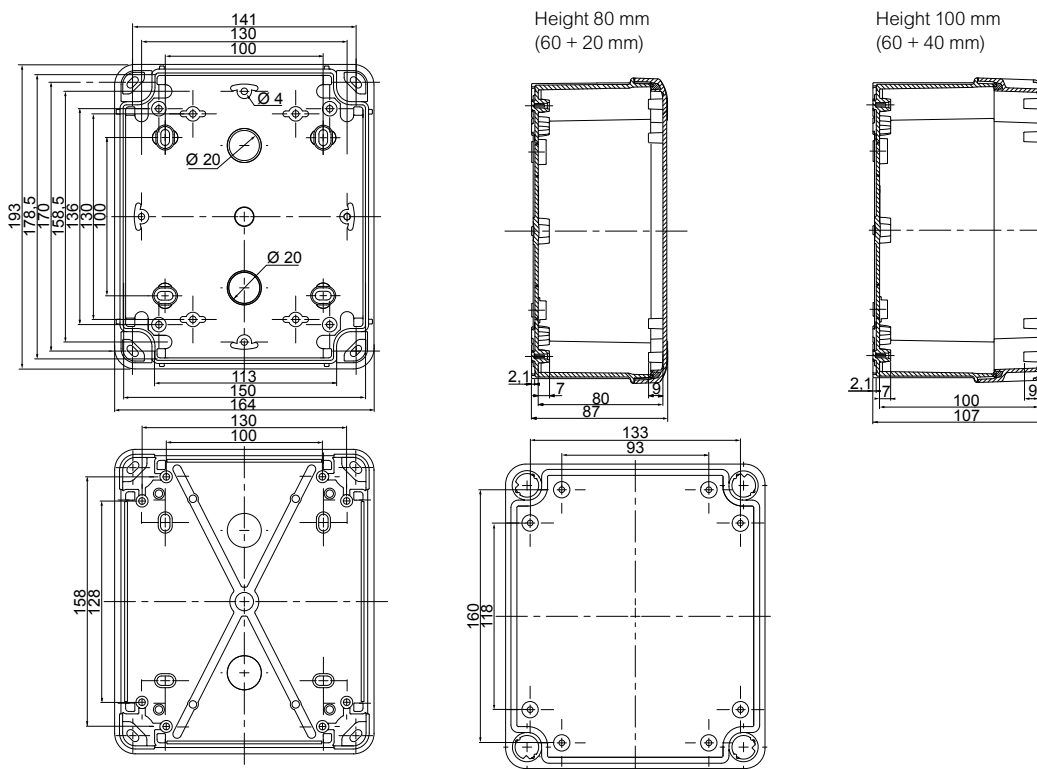

Box of 241 x 194 x 87, 107 or 127 mm (external dimensions)
NSYTB●●●24198, NSYTB●●●241910 or NSYTB●●●241912

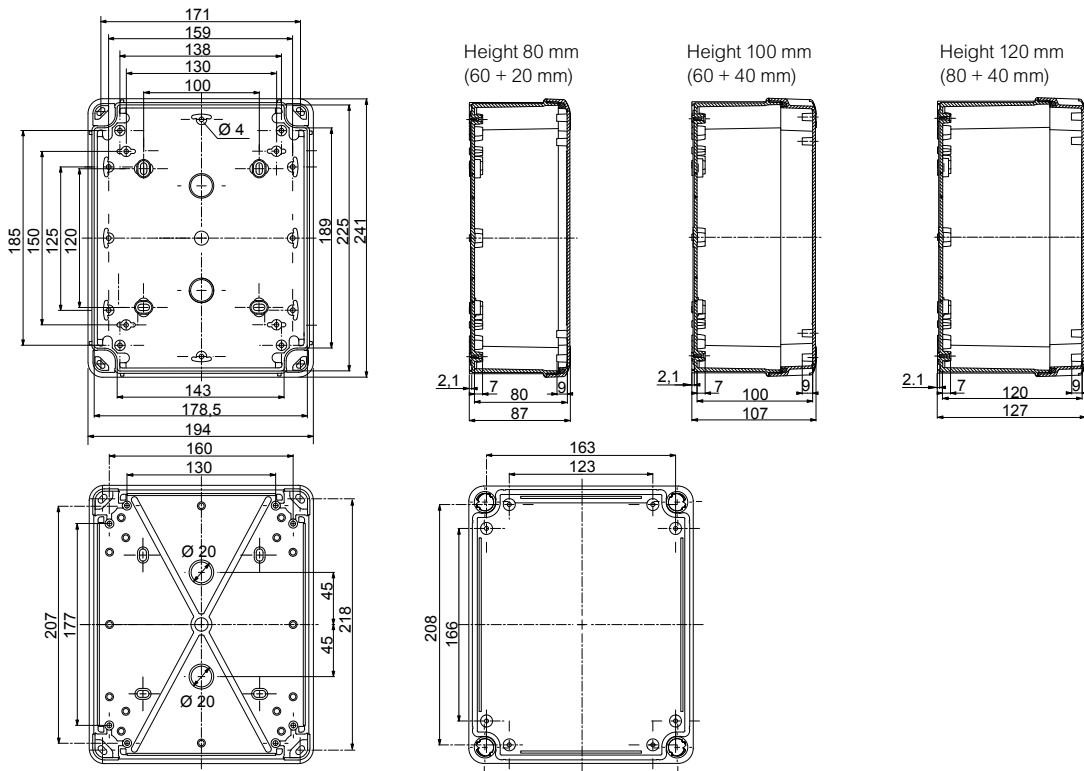

Box of 291 x 241 x 88, 128 or 168 mm (external dimensions)
NSYTB●●●29248, NSYTB●●●292412 or NSYTB●●●292416

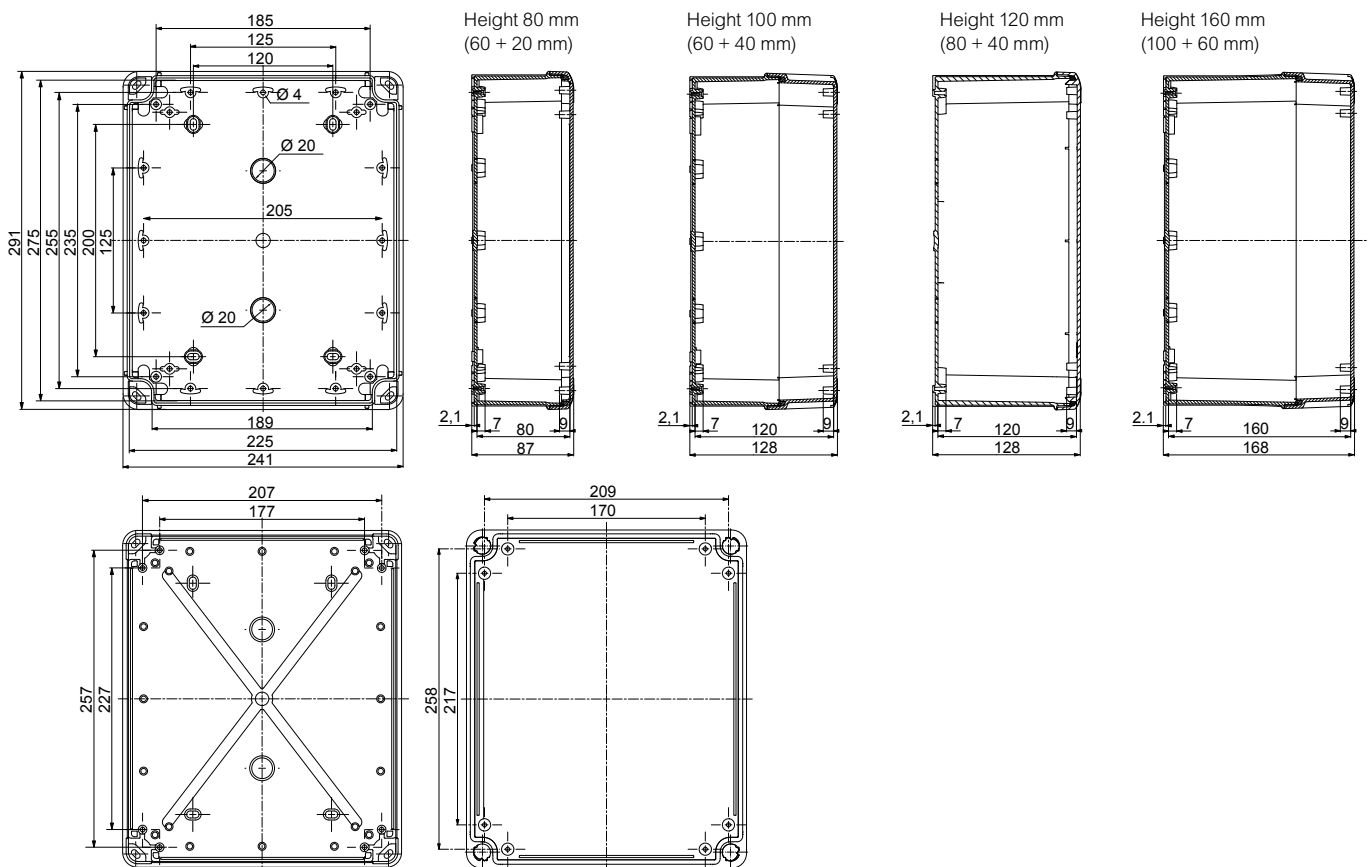

Technical changes reserved. Information provided without guarantee. Images are for illustrative purposes only.

Insulated Industrial Boxes

Box of 341 x 291 x 128 or 168 mm (external dimensions)
NSYTB●●●342912 or **NSYTB●●●342916**

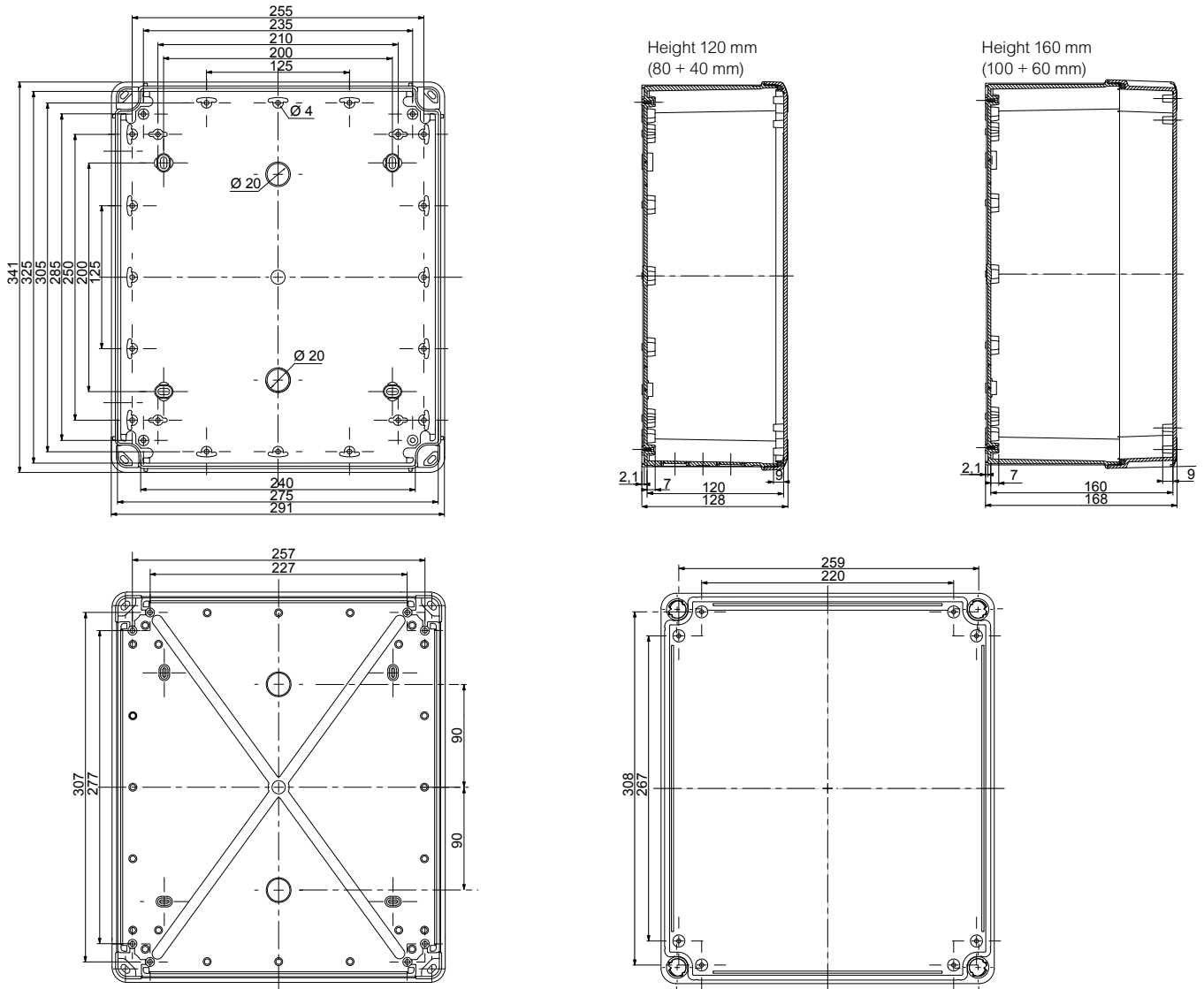

Technical changes reserved. Information provided without guarantee. Images are for illustrative purposes only.

The surfaces are numbered to enable identification of the surfaces to be drilled in the customized offer.

NSYPLS...1827G

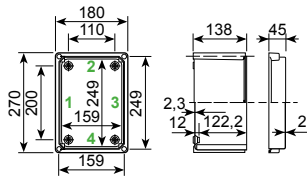

NSYPLS...2727G

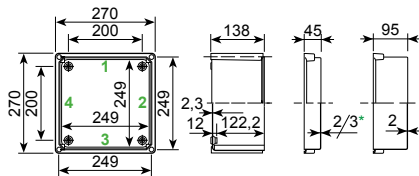

NSYPLS...2736G

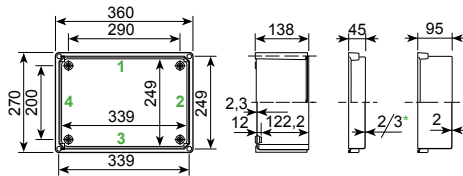

NSYPLS...3636G

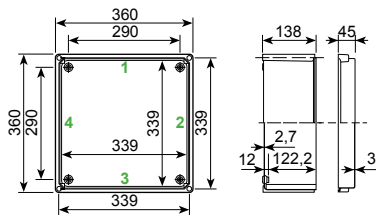

NSYPLS...2754G

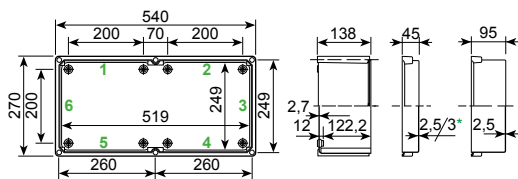

NSYPLS...3654G

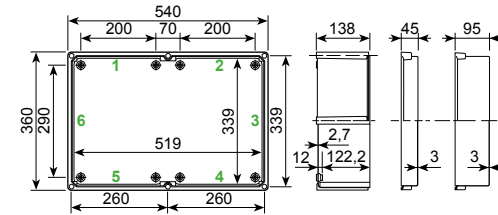

NSYPLS...5454G

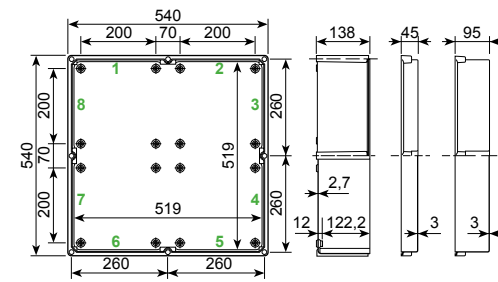

NSYPLS...3672G

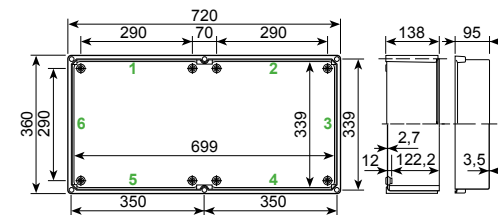

NSYPLS...5472G

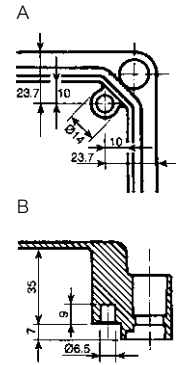
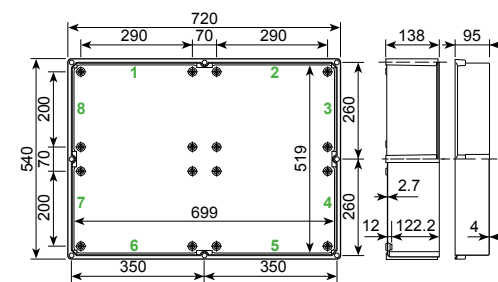

A - B: Internal view of the corners of the polyester covers with bosses for inserts ref. NSYTEX5 for M5 screws.

* Thickness of 30/10° mm for the polyester cover.

Insulated modular boxes with modular distribution chassis

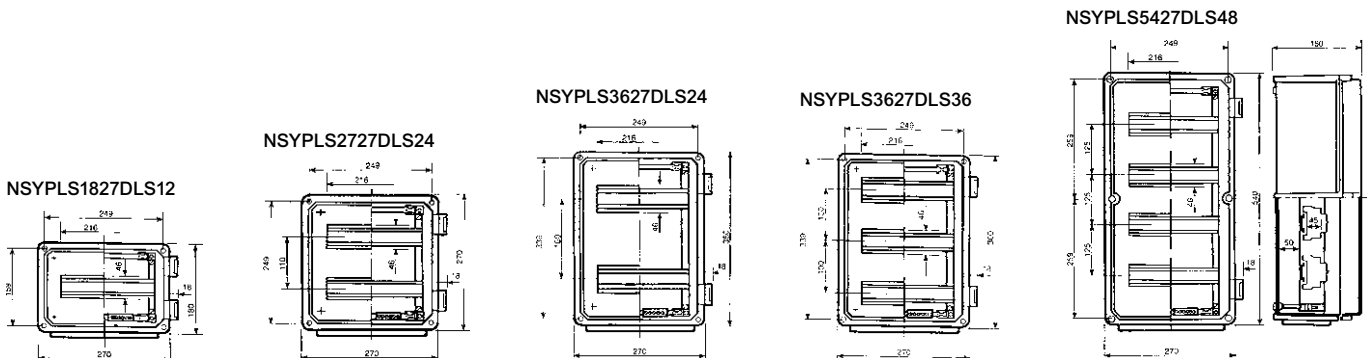

Technical changes reserved. Information provided without guarantee. Images are for illustrative purposes only.

Examples of assembly

All the boxes can be joined by their lateral surfaces using the coupling frames **NSYUM●●●** or **NSYUCC●●●**, and the joining and fixing pieces **NSYPS2C27** and **NSYPS4C27**.

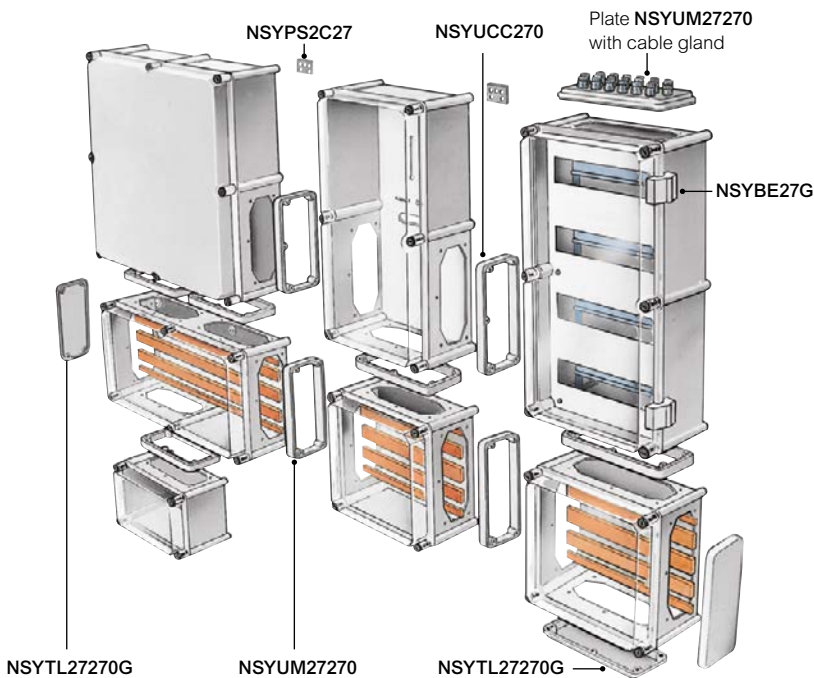
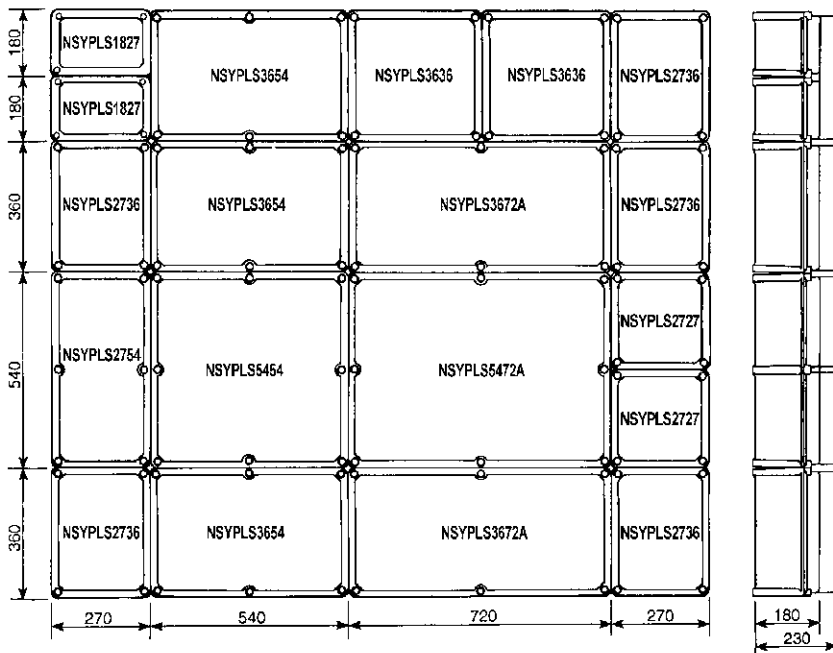

Technical changes reserved. Information provided without guarantee. Images are for illustrative purposes only.

Insulated Wall-Mounted Enclosures

Polyester wall-mounted enclosures



Thalassa PLM

Introduction	214
Characteristics	215
Selection guide	216
Specific accessories	217
Dimensions	228

Monobloc wall-mounted enclosure, made of polyester reinforced with fiberglass, molded by hot compression. Degree of protection IP66, impact resistance IK10 for plain doors and surfaces, and IK08 for glazed doors of polyester versions, UL certification (cULus), rating according to UL50E 4x and 13 for polyester wall-mounted enclosures. Full insulation to produce Class II-units compliant with RoHS and REACH directives

This range can be configured according to your needs

4 different services available:



Assemble to order



Mounting of standard accessories



Painting



Machining



Easy installation

- Door easily reversible by turning it over.
- Opening to 120° or 180°.
- Easy machining with no corrosion.
- Lightness.
- Polyamide hinge pin, easily removable and captive.



Service life

- High resistance to corrosion in harsh environments, maintaining mechanical properties and insulation.



Smart interior

- Notches for easy fixing of DIN rails.
- Grid pattern on the rear of the door for marking the machining operations.



Landscape enclosures

- Horizontal enclosures for photovoltaic and multiple applications
- Easily and quickly removable door system (without removing hinges and pins)
- For more details see [page 448](#)

See [page 546](#) for details or consult our web site www.se.com







Prolonged exposure to UV radiation, wind and rain can cause aesthetics changes in the external surface of the enclosure. Without affecting the technical properties according to IEC 62208. For long exposure applications, it is recommended to use painted enclosures available through the P&S offer.









Characteristics	ABS/PC wall-mounted enclosures	Polyester wall-mounted enclosures								
	<ul style="list-style-type: none"> • Monobloc wall-mounted enclosure. • Version with transparent polycarbonate door. • Door opening: 180°. • Supplied with a lock with double-bar insert as standard 	<ul style="list-style-type: none"> • Monobloc wall-mounted enclosure. • Version with transparent tempered-glass door. • Door opening angle: 120°. • Grid pattern with a pitch of 50 mm on the back of the door. • Supplied with one lock with a double-bar insert as standard. 	<ul style="list-style-type: none"> • Monobloc wall-mounted enclosure. • Version with transparent tempered-glass door. • Locking device outside the sealed area to ensure long-term tightness according to IP66. • Locking system: enclosure height ≤ 847 mm: 2 locks with double-bar insert ref. NSYCDBPLM or 1 handle with key lock and 3-point locking system, enclosure height 1056 mm: 1 lock with double-bar insert and 4-point locking system ref. NSYVPLM108. • Door opening angle: 180°. • Bosses for accessory-fixing inserts: M6 inside the enclosure, M5 in the door for enclosure heights of 430 and 530 mm, M6 in the door for enclosure heights ≥ 647 mm. • Grid pattern with a pitch of 25 mm on the back of the door. 							
Material	ABS/PC	Polyester reinforced with fiberglass, molded by hot compression								
Temperature range - Gasket	-40 °C to +80 °C									
Color	RAL 7035 grey									
Ingress protection rating	IP66 according to IEC 60529									
Mechanical protection rating	<ul style="list-style-type: none"> • IK10 plain door • IK08 glazed door 									
Certifications (see page 712)	<ul style="list-style-type: none"> • IEC 62208 • Bureau Veritas Marine 	<ul style="list-style-type: none"> • IEC 62208 • Marine • UL (cULus). Rating according to UL50E: 1, 2, 3, 3R, 4, 4X, 5, 12 and 13. • Certifications exclude range NSYPLM...VG or TVG 	<ul style="list-style-type: none"> • IEC 62208 • Marine 							
Installation	<ul style="list-style-type: none"> • Direct fixing of symmetrical rails ref. NSYCS200PLM with plastic nuts ref. NSYTCSPML, to be installed in the notches on the rear of the body, with a pitch of 25 mm • Fixing of installation plates on the studs at the rear of the enclosure 	<ul style="list-style-type: none"> • Fixing of rear accessories on 4 M8 x 18 studs 	<ul style="list-style-type: none"> • Fixing of rear accessories on 4 M8 studs, included in the standard supply • Direct fixing of symmetrical rails ref. NSYCS●●●PLM, with plastic nuts, ref. NSYTCSPML, to be installed in the notches on the rear of the body, with a pitch of 25 mm 							
External dimensions	References of wall-mounted enclosures with door									
Height (mm)	Width (mm)	Depth (mm)	Plain (3)	Transparent (4)	Plain (3)	Transparent (4)	Plain (3)	Transparent (4)	Plain (1)	Transparent (1) (4)
308	255	160	-	-	NSYPLM3025G	NSYPLM3025TG	-	-	-	-
310	215	160	NSYPLM32G	NSYPLM32TG	-	-	-	-	-	-
430	330	200	-	-	-	-	NSYPLM43G	NSYPLM43TG	NSYPLM43VG	NSYPLM43TVG
530	430	200	-	-	-	-	NSYPLM54G	NSYPLM54TG	NSYPLM54VG	NSYPLM54TVG
647	436	250	-	-	-	-	NSYPLM64G	NSYPLM64TG	NSYPLM64VG	NSYPLM64TVG
747	536	300	-	-	-	-	NSYPLM75G	NSYPLM75TG	NSYPLM75VG	NSYPLM75TVG
847	636	300	-	-	-	-	NSYPLM86G	NSYPLM86TG	NSYPLM86VG	NSYPLM86TVG
1056	852	350	-	-	-	-	NSYPLM108G (2)	NSYPLM108TG (2)	-	-

(1) Wall-mounted enclosure with handle and lock with 3-point locking system and key 1242 E delivered as standard.
 (2) Wall-mounted enclosure with standard 5-mm double-bar lock and lock with 4-point locking system.
 (3) These enclosures are also available equipped with metal or insulated mounted plates.
 (4) Must be protected against UV radiation.

Comment:
NSYPLMRS108GA is also certified by UL (cULus)

ABS/PC wall-mounted enclosures with door				Polyester wall-mounted enclosures with door			
Comment: For dimensions see page 228							
				Plain (3)	Transparent (4)	Plain (3)	Transparent (4)
External dimensions				References		References	
Height (mm)	Width (mm)	Depth (mm)	References	References	References	References	
310	215	160	NSYPLM32G	NSYPLM32TG	-	-	
308	255	160	-	-	NSYPLM3025G	NSYPLM3025TG	





Polyester wall-mounted enclosures with door													
Comment: For dimensions see page 228													
								Plain (3)	Transparent (4)	Plain (1)	Transparent (1) (4)		
External dimensions													
Height (mm)	Width (mm)	Depth (mm)	References	References	References	References							
430	330	200	NSYPLM43G	NSYPLM43TG	NSYPLM43VG	NSYPLM43TVG							
530	430	200	NSYPLM54G	NSYPLM54TG	NSYPLM54VG	NSYPLM54TVG							
647	436	250	NSYPLM64G	NSYPLM64TG	NSYPLM64VG	NSYPLM64TVG							
747	536	300	NSYPLM75G	NSYPLM75TG	NSYPLM75VG	NSYPLM75TVG							
847	636	300	NSYPLM86G	NSYPLM86TG	NSYPLM86VG	NSYPLM86TVG							
1056	852	350	NSYPLM108G (2)	NSYPLM108TG (2)	-	-							



⁽¹⁾ Wall-mounted enclosure with handle and lock with 3-point locking system and key 1242 E delivered as standard.

⁽²⁾ Wall-mounted enclosure with standard 5-mm double-bar lock and lock with 4-point locking system.

⁽³⁾ These enclosures are also available equipped with metal or insulated mounted plates.

⁽⁴⁾ Must be protected against UV radiation.

Wall-mounted enclosures with plain door and mounted plate (not mounted)											
Comment: For dimensions see page 228											
								Plain	Bakelite	Plain	Bakelite
External dimensions											
Height (mm)	Width (mm)	Depth (mm)	References	References	References	References					
310	215	160	NSYPLM32PG	NSYPLM32BG	-	-					
308	255	160	-	-	NSYPLM3025PG	NSYPLM3025BG					

Wall-mounted enclosures with plain door and mounted plate (not mounted)										
Comment: For dimensions see page 228										
								Plain	Bakelite	NSYPLM108BG
External dimensions										
Height (mm)	Width (mm)	Depth (mm)	References	References						
430	330	200	NSYPLM43PG	NSYPLM43BG						
530	430	200	NSYPLM54PG	NSYPLM54BG						
647	436	250	NSYPLM64PG	NSYPLM64BG						
747	536	300	NSYPLM75PG	NSYPLM75BG						
847	636	300	NSYPLM86PG	NSYPLM86BG						
1056	852	350	-	NSYPLM108BG						



Characteristics	ZM plinth for PLM enclosure <ul style="list-style-type: none"> • Designed to support and raise enclosures NSYPLM75G, NSYPLM86G and NSYPLM108G. • Plinth height of 200 mm; stackable to obtain a 400 mm plinth. • Four floor attachment points; symmetry of the parts prevents incorrect assembly. <p>The front parts of the plinth (front and rear) have two stainless-steel screws protected by a plastic cap; these screws make it possible (using an Allen key) to open and remove the front parts for easier cable installation. In stacked position, the bottom plinth can be partially buried. It is provided with one transverse reinforcement rail, adjustable to adapt to the position of the cables. The reference of the plinth contains all the accessories required for attaching the enclosure to the plinth and for stacking two plinths.</p>
Material	Polyester reinforced with fiberglass, molded by hot compression
Ingress protection rating	IP44
Mechanical protection rating	IK10
Standards	Helps guarantee full insulation according to IEC 61439-1

Plinth



NSYZM253G

Characteristics	PLM enclosure	Height (mm)	Width (mm)	Depth (mm)	Reference
Plinth	NSYPLM75G	200	456	302	NSYZM253G
Plinth	NSYPLM86G	200	556	302	NSYZM263G
Plinth	NSYPLM108G	200	772	352	NSYZM283G

Cable supporting cross-rail

The sides of the plinths are provided with bosses for the attachment of cross-rails with cutout profiles that support the cables. The reference of the cross-rail includes all elements required for assembly.



NSYAC280

Characteristics	For plinth	Reference
Cable supporting cross-rail	NSYZM253G	NSYAC280
Cable supporting cross-rail	NSYZM263G	NSYAC360
Cable supporting cross-rail	NSYZM283G	NSYAC600

Kit for IP54



NSYAEPM

Required to obtain IP54 for the plinth and the plinth enclosure coupling.

Characteristics	Reference
Kit for IP54	NSYAEPM

Feet for partially buried installation



NSYAEBFZ

Allows the partially buried installation of plinths before completion of the floor. The plinths are attached by four feet with a standard length of 750 mm. Option of horizontal adjustment of the plinth. The reference includes a kit made up of four feet and fixings.

Characteristics	Reference
Feet for partially buried installation	NSYAEBFZ

Floor-mounted pillar

To protect cables entering the enclosure in outdoor installations.
Cable entry section: 165 x 100 mm.
For enclosures ref. **NSYPLM54G**, **NSYPLM54TG**, **NSYPLM64G** and **NSYPLM64TG**.



NSYSFSPLMG

- Material: Polyester reinforced with fiberglass
- Color: RAL 7035 grey

Supply:
Delivered with steel frame for secure fixing to the floor

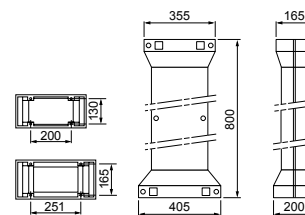

Characteristics	Reference
Floor-mounted pillar	NSYSFSPLMG

Wall fixing lugs

Set of 4 wall fixing lugs. Mounted directly on the enclosure, either in horizontal position or in vertical position.

- Material: Polyamide reinforced with fiberglass
- Color: RAL 7035 grey
- **Maximum load:**

On PLM32: Vertical or horizontal: 10 kg

Other PLM models: Vertical position: 200 kg, horizontal position: 100 kg

Supply:
Delivered with fixings



NSYFPPLMG

NSYFPPLM32G

Characteristics	Reference
Wall fixing lugs	NSYFPPLMG
Wall fixing lugs, exclusively for enclosures ref. NSYPLM32G and NSYPLM32TG.	NSYFPPLM32G

Wall fixing lugs

Set of 4 wall fixing lugs. Mounted directly on the enclosure, either in horizontal position or in vertical position.

- Material: Stainless-steel
- Color: RAL 7035 grey
- **Maximum load:**

Other PLM models: Vertical position: 200 kg, horizontal position: 100 kg

Supply:
Delivered with fixings



NSYFPXPLM

Characteristics	Reference
Wall fixing lugs	NSYFPXPLM

Post fixing device

- For outdoor installations on a post with a maximum circumference of 675 mm, Ø 215 mm.
- Material: Galvanized steel
- Maximum load: 100 kg

Supply:
Supply of 2 rails, the strips and the fixings



NSYSFP300

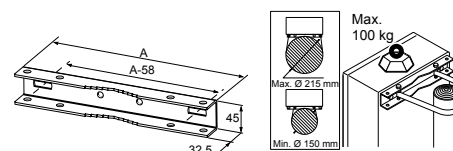

Characteristics	For wall-mounted enclosure	Reference
Post fixing device	NSYPLM43G	NSYSFP300
Post fixing device	NSYPLM54G and NSYPLM64G	NSYSFP400
Post fixing device	NSYPLM75G	NSYSFP500
Post fixing device	NSYPLM86G	NSYSFP600

Blanking plates

Aesthetic Accessory. They are positioned on the rear surface of the enclosures to block the openings in the corners in order to improve their appearance or prevent the entry of unwanted elements in the airing shaft. Supplied as standard for enclosure, ref. **NSYPLM108G**.

- Material: Thermoplastic
- Color: RAL 7035 grey
- Ingress protection rating: IP40

Accessory is mounted outside the IP66-protected area.



NSYCEPLMAG

Characteristics	For wall-mounted enclosure	Reference
Blanking plates	NSYPLM32G	NSYCEPLMAG
Blanking plates	NSYPLM43G and NSYPLM54G	NSYCEPLMBG
Blanking plates	NSYPLM64G, 75G and 86G	NSYCEPLMCG

Support bracket for enclosure with anti-tilt kit and reinforcement



NSYCOCONS1400

- The support bracket is used when the enclosure cannot be hung from a wall or a post.
- Maximum enclosure dimensions: 1000 x 800 x 300 mm.
- Floor attachment by standard M12 fasteners.
- Material: Steel
- Finish: Epoxy polyester paint
- Color: RAL 7035 grey
- Maximum load: 120 kg

Characteristics	Height (mm)	References
Support bracket for enclosure with anti-tilt kit and reinforcement	1400	NSYCOCONS1400
Support bracket for enclosure with anti-tilt kit and reinforcement	1800	NSYCOCONS1800

Internal door

- Reversible door.
- Grid pattern with a pitch of 25 mm for easier marking before drilling.
- Closes with 2 double-bar locks.
- Door handle.
- Steel internal door, without grid pattern and locking by a screw, for enclosures ref. **NSYPLM3025G**.
- Incompatible with the modular distribution chassis.
- Material: Polyester reinforced with fiberglass, self-extinguishing
- Color: RAL 7035 grey

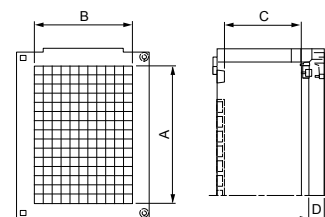

Supply:
Delivered with fixings and brass inserts



NSYPA3025PLMG

Characteristics	Height (mm)	Width (mm)	A (mm)	B (mm)	C (mm)	D Plain door (mm)	D Transp. door (mm)	Reference
Internal door	308	255	248	165	62	76	71	NSYPA3025PLMG
Internal door	430	330	315	205	152	26	21	NSYPAP43G
Internal door	530	430	415	305	152	26	21	NSYPAP54G
Internal door	645	435	515	305	194	32	27	NSYPAP64G
Internal door	745	535	615	405	244	32	27	NSYPAP75G
Internal door	845	635	715	505	244	32	27	NSYPAP86G
Internal door	1055	850	850	650	269	37	32	NSYPAP108G

New

PLM landscape (horizontal) range for photovoltaic and multiple applications with removable door system [see page 448](#)



Scan or click for video

Metal mounted Plate

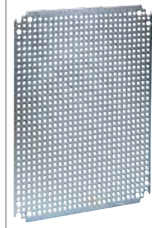

Characteristics	Plain	Silkscreened	Microperforated
-----------------	-------	--------------	-----------------

Model	Enclosure Dimensions			MP Dimension		Reference	Reference	Reference
	Height (mm)	Width (mm)	Depth (mm)	Height (mm)	Width (mm)			
NSYPLM32	310	215	160	250	150	NSYMM32	-	-
NSYPLM3025	308	255	160	250	200	NSYMM3025	-	-
NSYPLM43	430	330	200	230	350	NSYMM43	NSYMS43	NSYMF43
NSYPLM54	530	430	200	450	350	NSYMM54	NSYMS54	NSYMF54
NSYPLM64	647	436	250	550	350	NSYMM64	NSYMS64	NSYMF64
NSYPLM75	747	536	300	650	450	NSYMM75	NSYMS75	NSYMF75
NSYPLM86	847	636	300	750	550	NSYMM86	NSYMS86	NSYMF86
NSYPLM108	1056	852	350	950	750	NSYMM108	-	NSYMF108

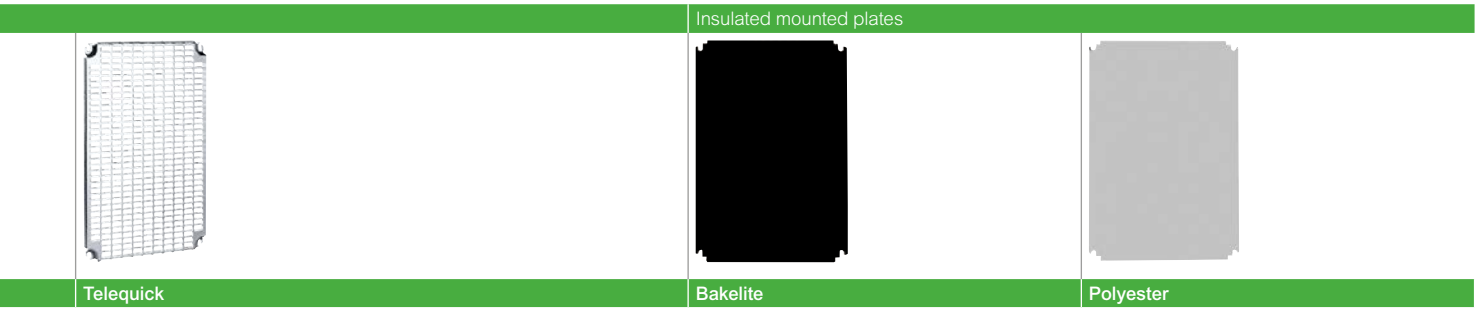

Height (mm)	Width (mm)	# of perforation H	# of perforation W	Reference	Height (mm)	Width (mm)	Thick. (mm)	Reference	Height (mm)	Width (mm)	Thick. (mm)	Reference
255	153.7	16	5	NSYMR32	265	150	4	NSYMB32	265	150	4	NSYMPP32
253	228	16	8	NSYMR3025	265	200	4	NSYMB3025	265	200	4	NSYMPP3025
348.7	251	22	9	NSYMR43	325	250	4	NSYMB43	325	250	4	NSYMPP43
450	351	31	11	NSYMR54	465	350	4	NSYMB54	465	350	4	NSYMPP54
555	351	38	11	NSYMR64	565	350	4	NSYMB64	565	350	4	NSYMPP64
645	451	44	14	NSYMR75	665	450	4	NSYMB75	665	450	4	NSYMPP75
750	551	51	17	NSYMR86	765	550	4	NSYMB86	765	550	5	NSYMPP86
945	751	64	24	NSYMR108	965	750	4	NSYMB108	965	750	5	NSYMPP108

Options to convert the locks to double-bar inserts **NSYPLM32G** to **NSYPLM86G**



NSYTC8CRN



NSYTT8CRN



NSYTL405PLM

- Changing the shaped inserts for locks with keys according to the following table.

Characteristics	Operated with a key	References
Square insert 6 mm □	LC-7	NSYTC6CRN
Square insert 7 mm □	LC-7	NSYTC7CRN
Square insert 8 mm □	LC-8	NSYTC8CRN
Triangular insert 6 mm ▲	LT-8	NSYTT6CRN
Triangular insert 8 mm ▲	LT-8	NSYTT8CRN
Lock and key 405		NSYTL405PLM
Lock and key 220		NSYTL220PLM
Lock TJIS		NSYTLJIS

Options to convert the locks to double-bar inserts **NSYPLM32G** to **NSYPLM86G**

- Replacement for locking handle with cylindrical barrel, delivered with all the parts required to change the lock.



NSYTHL1242EPLM

Characteristics	References
Key 1242 E	NSYTHL1242EPLM
Key 405	NSYTHL405PLM
Key 421	NSYTHL421PLM
Key 455	NSYTHL455PLM
Key 2331 A	NSYTHL2331APLM
Key 2433 A	NSYTHL2433APLM
Key 3113 A	NSYTHL3113APLM
Key 3131A	NSYTHL3131APLM
Manual	NSYTHPLM

Options to convert versions **NSYPLM●●V**, with retractable handle and 3-point locking system

- Conversion of the standard insert (barrel for key 1242E, ref. **NSYTL1242EME**) to other shaped inserts or barrels according to the following table.

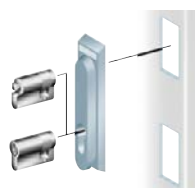

NSYTD5ME

Characteristics	References
5-mm double-bar	NSYTD5ME
6 mm male square	NSYTC6ME
8 mm male square	NSYTC8ME
6.5 mm male triangle	NSYTT6ME
8 mm male triangle	NSYTT8ME
Barrel and key 405	NSYTC405ME
Reinforced key and barrel	NSYTLRME
JIS key and barrel	NSYTLJISME
Manual	NSYTMME

Locks and inserts for enclosures **NSYPLM108/T**

- Options to convert the insert
- The standard insert can be replaced with other shaped inserts according to the following table.

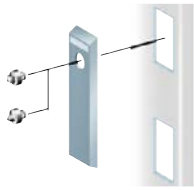

NSYTDB5PL

Characteristics	References
Double-bar insert	NSYTDB5PL

Locks and inserts for enclosures **NSYPLM108/T**

- Options to convert to a retractable handle
- The escutcheon and rosette assembly can be replaced with a lock with retractable handle equipped with inserts or barrels according to the following table.



NSYTEDB5PL

Characteristics	References
5-mm double-bar	NSYTEDB5PL
6 mm male square	NSYTEC6PL
7 mm male square	NSYTEC7PL
6.5 mm male triangle	NSYTET6PL
8 mm male triangle	NSYTET8PL
Lock key 1242 E	NSYTEL1242EPL
Barrel and key 405	NSYTEL405PL
Reinforced key and barrel	NSYTERPL
JIS key and barrel	NSYTELJISPL
FAC key and barrel	NSYTELFCPL
Manual	NSYTEMPL

Padlocking accessories

Padlocking system positioned around the rectangular escutcheon of the enclosures with a height of ≤ 847 mm to block access to the lock; For a $\varnothing 9$ mm padlock.



NSYKPLM

Characteristics	References
Padlocking accessories	NSYKPLM

Padlocking accessories

Padlocking system positioned around the long rectangular escutcheon of the enclosures ref. **NSYPLM108G/TG** to block access to the lock; For $\varnothing 9$ mm padlock.



NSYBCPL

Characteristics	References
Padlocking accessories	NSYBCPL

Padlocking accessories

Padlocking system to block access to the retractable handle, for the versions **NSYPLM●●V** or optionally for enclosures ref. **NSYPLM108G/TG**, for a $\varnothing 9$ mm padlock.



NSYBCME

Characteristics	References
Padlocking accessories	NSYBCME

Step slides

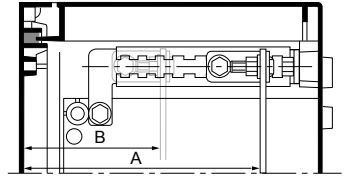

Kit allowing depth adjustment with a pitch of 12.5 mm, and the fixings required for the installation. Incompatible with the modular distribution chassis.

Supply:
4 step slides with brackets



NSYDPLM200

Characteristics (Material: Galvanized steel)	For wall-mounted enclosure depth (mm)	Depth adjustment A (mm)	Depth adjustment B (mm)	References
Step slides	200	156	94	NSYDPLM200
Step slides	250	200	100	NSYDPLM250
Step slides	300	250	100	NSYDPLM300
Step slides	350	306	106	NSYDPLM350

Plastic nuts for rail fixing

They slide directly into the notches, with a pitch of 25 mm, which are located on the rear of the enclosures, except enclosure ref. **NSYPLM3025G/TG**. They allow direct fixing of symmetrical DIN rails by self-tapping screws. Option of raising the rails with an M6 spacer using a plastic nut containing an M6 nut.

Supply:
References by unit. Order by multiples of 20 units (20, 40, 60, etc.)



NSYTCSPLM

Characteristics	References
Plastic nut with self-tapping screw	NSYTCSPLM
Plastic nut containing an M6 metal nut	NSYTCSM6PLM

35-mm symmetrical DIN rails

They are fixed to the rear of the enclosure without uprights, with a pitch of 25 mm for the notches on the rear of the enclosure using direct-fixing nuts ref. **NSYTCSPLM** or **NSYTCSM6PLM**.

- Material: Galvanized steel

Supply:
References by unit. Order by multiples of 2 units (2, 4, 6, etc.)



NSYCS200PLM

Characteristics	For wall-mounted enclosure width (mm)	Rail length (mm)	References
35 mm symmetrical DIN rails	215	180	NSYCS200PLM
35 mm symmetrical DIN rails	330	280	NSYCS300PLM
35 mm symmetrical DIN rails	430 / 436	380	NSYCS400PLM
35 mm symmetrical DIN rails	536	480	NSYCS500PLM
35 mm symmetrical DIN rails	636	580	NSYCS600PLM
35 mm symmetrical DIN rails	852	795	NSYCS800PLM

Fixing inserts



Expanding inserts for addition to the M6 bosses of the enclosure, the M5 or M6 bosses of the door and the M8 bosses of the external rear part of the enclosure.

Supply:
References by unit. Order by multiples of 8 units (8, 16, 24, etc.). M5 and M6 inserts to be ordered in multiples of 20

Characteristics	Insert size	For wall-mounted enclosure	References
Fixing inserts	M5	NSYPLM43G and NSYPLM54G	NSYTEX5
Fixing inserts	M6	NSYPLM64G to NSYPLM108G	NSYTEX6
Fixing inserts	M8	For the rear of the enclosure	NSYTEX8PLM

Airing louvres



- They can be positioned inside the wall-mounted enclosures with heights from 430 to 846 mm, allowing airing through the channels of the enclosure.

Supply:
References by unit. Order by multiples of 2 units (2, 4, 6, etc.)

Characteristics	References
Airing louvres	NSYCAG35LP

Water drain plug



- For drainage of condensed water. (Condensation should be eliminated using ClimaSys solution.) It is placed in the Ø 8.5 mm (8.2 mm for wall-mounted enclosures **NSYPLM32G**, **NSYPLM32TG**, **NSYPLM32PG** and **NSYPLM32BG**, diverse accessories) housing at the bottom of the enclosure.
- Ingress protection rating: IP53

Supply:
References by unit. Order by multiples of 10 units (10, 20, 30, etc.)

Characteristics	References
Water drain plug	NSYVEA9

Renovation and anti-graffiti paint



- Paint kit with two components (base 80% + hardener 20%)
- Specially designed for polyester enclosures, for their renovation and/or as prevention to allow easy removal of graffiti.
- Color: RAL 7035 grey

Supply: NSYAUPG1G
The 1 kg reference includes 1 pot with 800 g of base paint and 200 g of hardener (It is enough to paint a surface of around 5 m²)

Characteristics	References
Renovation and anti-graffiti paint	NSYAUPG1G

- Solvent bottles to be used as a paint thinner or to clean brushes.

Supply:
1 kg

Characteristics	References
Renovation and anti-graffiti paint solvent	NSYAUPGS

Insulated Wall-Mounted Enclosures

Thalassa PLM, S3D, S3X, Specific Accessories



S3D* **S3X** **PLM**

Characteristics	DLA modular chassis
	<ul style="list-style-type: none"> • Front panels and covers installed in the front part, not depth adjustable. • Rigid structure for the installation of modular devices. • Open front panels with 35-mm DIN rail and plain front panels with mounted plate, according to the model. • Front plates are quickly installed with no fixings. • Rail depth adjustable from 40 to 85 mm. • System for standard circuit marking. • Incompatible with the internal doors and the step slides. • Neutral/earth strip: 2 x 16 mm² + 5 x 6 mm².
Material	Front panels and finish covers: Polystyrene Rigid structure: Galvanized steel
Color	Front panels and finish covers: RAL 7035 grey

DLA modular chassis



NSYDLA24G

Characteristics	No. of rows	No. of 18 mm modules per row	No. of 18 mm modules	No. of plates	PLM enclosure References	S3D enclosure (depth ≥ 200 mm) Height (mm) Width (mm)	Reference
DLA modular chassis	2	12	24	-	NSYPLM43G NSYPLM43TG	400 300	NSYDLA24G
DLA modular chassis	3	16	48	-	NSYPLM54G NSYPLM54TG	500 400	NSYDLA48G
DLA modular chassis	3	16	48	-	NSYPLM64G NSYPLM64TG	600 400	NSYDLA48PG
DLA modular chassis	3	22	66	1	NSYPLM75G NSYPLM75TG	700 500	NSYDLA66G
DLA modular chassis	4	22	88	-	NSYPLM75G NSYPLM75TG	700 500	NSYDLA88G
DLA modular chassis	3	28	84	1	NSYPLM86G NSYPLM86TG	800 600	NSYDLA84G
DLA modular chassis	4	28	112	-	NSYPLM86G NSYPLM86TG	800 600	NSYDLA112G
DLA modular chassis	6	39	234	-	NSYPLM108G NSYPLM108TG	1000 800	NSYDLA234G

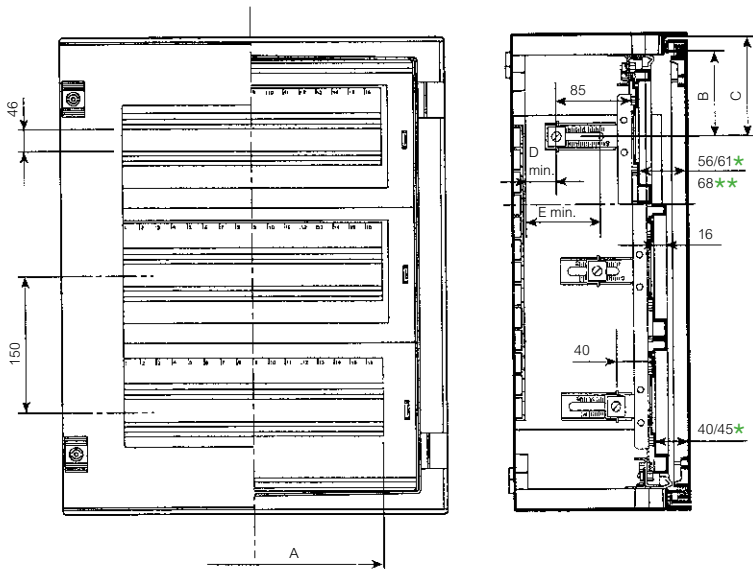
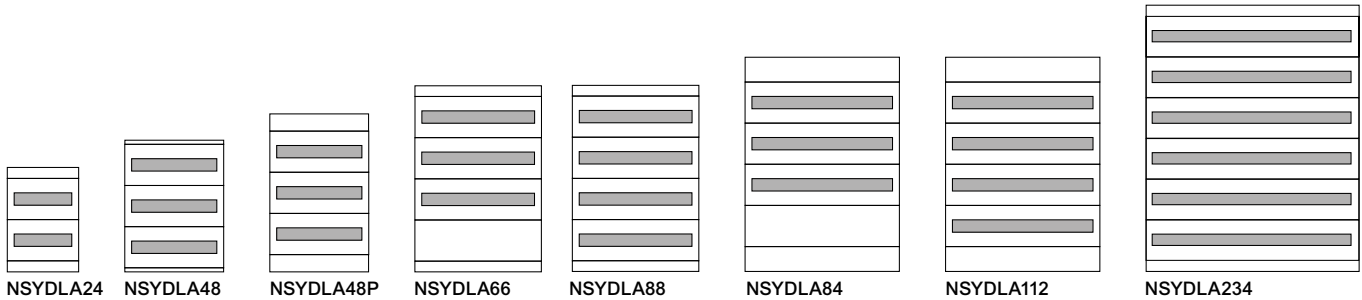

* Models **NSYDLA48PG, 66, 88, 84** and **112**.
** Models **NSYDLA234**.

Technical changes reserved. Information provided without guarantee. Images are for illustrative purposes only.

Plain front panels for Dinimel DLA chassis

- Front panel for non-modular device protection on one row.
- To be ordered in multiples of two.
- Material: Polystyrene
- Color: RAL 7035 grey



NSYCTL300DLAG

Characteristics	Width (mm)	For installing on the chassis	Reference
Plain front panels for Dinimel DLA chassis	256	NSYDLA24G	NSYCTL300DLAG
Plain front panels for Dinimel DLA chassis	356	NSYDLA48G and NSYDLA48PG	NSYCTL400DLAG
Plain front panels for Dinimel DLA chassis	456	NSYDLA66G and NSYDLA88G	NSYCTL500DLAG
Plain front panels for Dinimel DLA chassis	555	NSYDLA84G and NSYDLA112G	NSYCTL600DLAG
Plain front panels for Dinimel DLA chassis	755	NSYDLA234G	NSYCTL800DLAG

Mounted plate for Dinimel DLA chassis

- Mounted plate for mounted non-modular devices on one row.
- To be ordered in multiples of two.
- Material: Galvanized steel

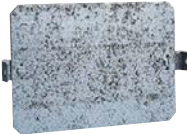

NSYPMP400DLA

Characteristics	Width (mm)	For installing on the chassis	Reference
Mounted plate for Dinimel DLA chassis	315	NSYDLA48G and NSYDLA48PG	NSYPMP400DLA
Mounted plate for Dinimel DLA chassis	415	NSYDLA66G and NSYDLA88G	NSYPMP500DLA
Mounted plate for Dinimel DLA chassis	514	NSYDLA84G and NSYDLA112G	NSYPMP600DLA
Mounted plate for Dinimel DLA chassis	714	NSYDLA234G	NSYPMP800DLA

Modular distribution chassis

- For mounted modular devices on two rows of nine 18-mm modules.
- Material:
Chassis: Metal Protective
Plate: Insulated material



NSYDLPLM18G

Characteristics	For enclosure	Reference
Modular distribution chassis	NSYPLM3025G/TG	NSYDLPLM18G

ABS/PC wall-mounted enclosures

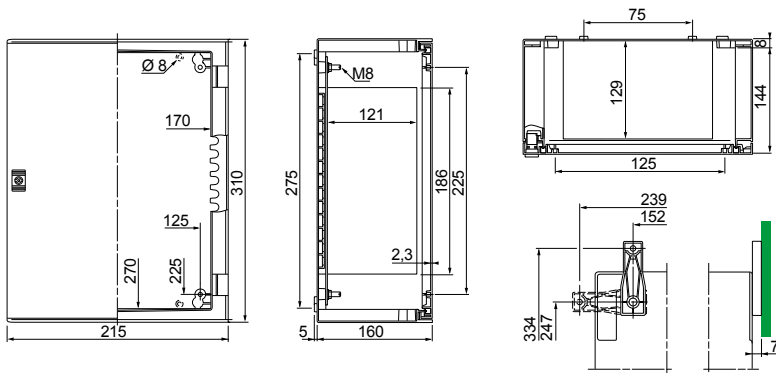

Polyester wall-mounted enclosures 308 x 255 mm

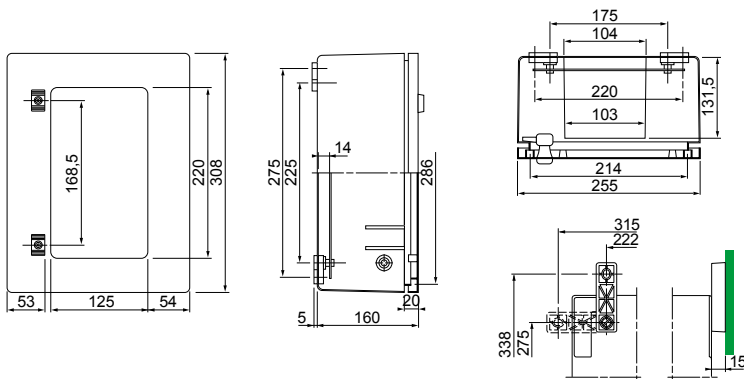

 Warning! This model is available with only one lock!

8

Other polyester wall-mounted enclosures

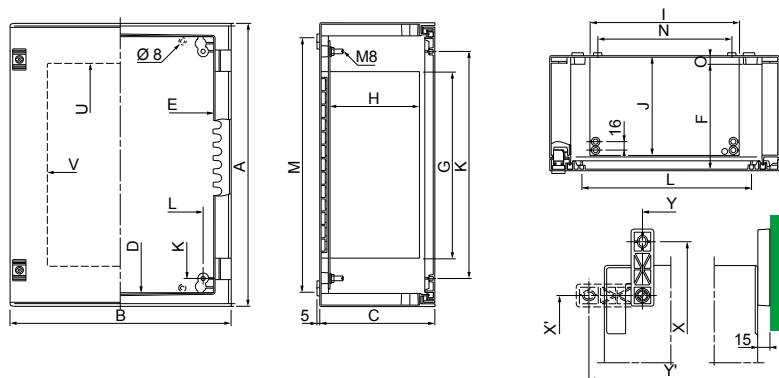

External fixing with lugs (mm)				
References	Vertical		Horizontal	
	X	Y	X'	Y'
NSYPLM43G	490	225	355	360
NSYPLM54G	590	325	455	460
NSYPLM64G	690	330	555	465
NSYPLM75G	790	430	655	565
NSYPLM86G	890	530	755	665
NSYPLM108G	1090	750	955	885

Glazed door opening (mm)		
References	U	V
NSYPLM43TG	273	194
NSYPLM43TVG	273	151
NSYPLM54TG	373	294
NSYPLM54TVG	373	251
NSYPLM64TG	463	294
NSYPLM64TVG	463	252
NSYPLM75TG	563	394
NSYPLM75TVG	563	352
NSYPLM86TG	663	494
NSYPLM86TVG	663	452
NSYPLM108TG	854	661

References	Dimensions (mm)										Bottom screw and door bosses (mm)		Internal fixing (mm)		
	A	B	C	D	E	F	G	H	I	J	K	L	M	N	O
NSYPLM43G	430	330	200	380	260	181	247	247	179	168	325	225	225	150	13
NSYPLM54G	530	430	200	480	360	181	347	347	279	168	425	325	325	250	13
NSYPLM64G	647	436	250	580	360	228	388	388	279	212	525	325	325	250	13
NSYPLM75G	747	536	300	680	460	278	487	487	379	261	625	425	425	350	15
NSYPLM86G	847	636	300	780	560	278	587	587	479	261	725	525	525	450	15
NSYPLM108G	1056	852	350	980	760	327	775	775	680	300	925	725	725	650	15

Insulated Floor-Standing Enclosures

PLA Version



PLAT Version



PLAZ Version



PLAZT Version



PLD Version



Thalassa PLA Polyester floor-standing enclosures

Introduction	232
Characteristics	233
Selection guide	234
Specific accessories	236
Dimensions	249

Polyester Floor-Standing Enclosures Thalassa PLA, PLAT, PLAZ, PLAZT, Introduction

The **floor-standing enclosures** are made of **polyester reinforced with fiberglass**, molded by hot compression. High resistance to corrosion in harsh environments, it maintains its mechanical and insulation properties.

This range can be configured according to your needs

4 different services available:



Assemble to order



Mounting of standard accessories



Painting



Machining



New Bigger dimensions

Enclosures with a height of 2000 mm and a depth of 620 mm have been included to suit the demands of industry and infrastructure for the integration of motor controllers, power distribution, electronic or telecommunication devices

9

PLAT version



Airing

- Open top with canopy allows passive airing.



Easy mounting

- Various bosses for M8 inserts.

PLAZ version



Open bottom

- Big open bottom to be mounted directly on the floor or on a plinth.



Smart interior

- Plain mounting plate installed on step slides and compulsory adapter plates in all the enclosures with open bottom part.

PLAZT version



Easy installation

- Door opening to 180°.



Resistant

- Anti lever security system..





See page 546 for details or consult our web site www.se.com



Prolonged exposure to UV radiation, wind and rain can cause aesthetics changes in the external surface of the enclosure. Without affecting the technical properties according to IEC 62208. For long exposure applications, it is recommended to use painted enclosures available through the P&S offer.



Class II

	PLA	PLAT	PLAZ	PLAZT
				
Characteristics	PLA version	PLAT version	PLAZ version	PLAZT version
	<p>Completely sealed enclosure Enclosure obtained by assembling:</p> <ul style="list-style-type: none"> • 1 sealed top part, • 1 sealed bottom part, • 2 side parts, • 1 or 2 rear panels (depending on width), • 1 or 2 doors (depending on width). • Locking system with handle with a 5-mm double-bar insert block, included in the standard supply. Other blocks with inserts or barrels and keys optionally available. • Door opening to 120°. 	<p>Enclosure with ventilated canopy Enclosure obtained by assembling:</p> <ul style="list-style-type: none"> • 1 open top part with canopy, • 1 sealed bottom part, • 2 side parts, • 1 or 2 rear panels (depending on width), • 1 or 2 doors (depending on width). • Locking system with handle with a 5-mm double-bar insert block, included in the standard supply. Other blocks with inserts or barrels and keys optionally available. • Door opening to 120°. 	<p>Enclosure with open bottom Enclosure obtained by assembling:</p> <ul style="list-style-type: none"> • 1 sealed top part, • 1 plinth-type open bottom part, • 2 side parts, • 1 or 2 rear panels (depending on width), • 1 or 2 doors (depending on width). • Locking system with handle with a 5-mm double-bar insert block, included in the standard supply. Other blocks with inserts or barrels and keys optionally available. • Door opening to 120°. 	<p>Enclosure with open bottom and ventilated canopy</p> <ul style="list-style-type: none"> • Enclosure obtained by assembling: • 1 open top part with canopy, • 1 plinth-type open bottom part, • 2 side parts, • 1 or 2 rear panels (depending on width), • 1 or 2 doors (depending on width). • Locking system with handle with a 5-mm double-bar insert block. Other blocks with inserts or barrels and keys optionally available. • Door opening to 180°. • Anti-lever system to help prevent forcing of the door.
Material	<ul style="list-style-type: none"> • Polyester reinforced with fiberglass 			
Finish	<ul style="list-style-type: none"> • Molded by hot compression: The pieces have an excellent finish on both sides and can include numerous bosses for accommodating inserts and mounting or cable management accessories 			
Color	<ul style="list-style-type: none"> • RAL 7035 grey 			
Ingress protection rating	IP65 according to IEC 60529	<ul style="list-style-type: none"> • IP44 according to IEC 60529 • IP54 with 1 or 2 internal grilles, ref. NSYCAG125LPP, to be ordered separately. 	IP54 according to IEC 60529	<ul style="list-style-type: none"> • IP44 according to IEC 60529 • IP54 with 1 or 2 internal grilles, ref. NSYCAG125LPP, to be ordered separately
Mechanical protection rating	IK10 (20 joules) plain door - IEC62262 and IK08 glazed door			
Insulation	<ul style="list-style-type: none"> • Class II according to IEC 60950-1 if the mounting process follows the included mounting instructions sheet 			
Certifications	<ul style="list-style-type: none"> • UL (cULus). • Rating according UL50E: Types 1, 2, 3, 3X, 3R, 3RX, 5, 12 and 13. • Bureau Veritas Marine • IEC 62208 	<ul style="list-style-type: none"> • IEC 62208 		
Installation	<ul style="list-style-type: none"> • Indoor use only. For outdoor use, must install a canopy 	<ul style="list-style-type: none"> • Outdoor or indoor installation 		<ul style="list-style-type: none"> • The open bottom part forms a 60 mm plinth which is fixed to the floor directly or by means of an optional fixing frame, see page 240, or else it is installed on a semi-embedded plinth, see page 240
	<ul style="list-style-type: none"> • Direct fixing to the floor or by means of a plinth with a height of 60 mm, as an option, see page 238 • Option of fixing on a semi-embedded plinth, see page 238 • Optional wall fixing lugs 			
	<ul style="list-style-type: none"> • The versions with glassed door must be protected against the direct sunlight to avoid overheating. 			
Options	<ul style="list-style-type: none"> • Anti-posting door upon request 			

PHD - Applicative and customized solutions:
See the Polyester Heavy-Duty offer in the Applicative and customized solutions, [page 434](#).



Indoor and Outdoor:
Outdoor use requires the installation of a canopy.

Completely sealed enclosures, IP65

Enclosures with open bottom part, IP54



PLA



PLA



PLAZ

Dimensions (mm)				Completely sealed enclosures, IP65		Enclosures with open bottom part, IP54
Height	Width	Depth	N° of doors	Plain	Glazed**	Plain
500	500	320	1	NSYPLA553G	NSYPLA553TG	NSYPLAZ553G
500	500	420	1	NSYPLA554G	NSYPLA554TG	NSYPLAZ554G
500	750	320	1	NSYPLA573G	NSYPLA573TG	NSYPLAZ573G
500	750	420	1	NSYPLA574G	NSYPLA574TG	NSYPLAZ574G
500	1000	320	2	NSYPLA5103G	NSYPLA5103TG	NSYPLAZ5103G
500	1000	420	2	NSYPLA5104G	NSYPLA5104TG	NSYPLAZ5104G
500	1250	320	2	NSYPLA5123G	NSYPLA5123TG	NSYPLAZ5123G
500	1250	420	2	NSYPLA5124G	NSYPLA5124TG	NSYPLAZ5124G
750	500	320	1	NSYPLA753G	NSYPLA753TG	NSYPLAZ753G
750	500	420	1	NSYPLA754G	NSYPLA754TG	NSYPLAZ754G
750	750	320	1	NSYPLA773G	NSYPLA773TG	NSYPLAZ773G
750	750	420	1	NSYPLA774G	NSYPLA774TG	NSYPLAZ774G
750	750	620	1	NSYPLA776G	NSYPLA776TG	NSYPLAZ776G
750	1000	320	2	NSYPLA7103G	NSYPLA7103TG	NSYPLAZ7103G
750	1000	420	2	NSYPLA7104G	NSYPLA7104TG	NSYPLAZ7104G
750	1250	320	2	NSYPLA7123G	NSYPLA7123TG	NSYPLAZ7123G
750	1250	420	2	NSYPLA7124G	NSYPLA7124TG	NSYPLAZ7124G
1000	500	320	1	NSYPLA1053G	NSYPLA1053TG	NSYPLAZ1053G
1000	500	420	1	NSYPLA1054G	NSYPLA1054TG	NSYPLAZ1054G
1000	750	320	1	NSYPLA1073G	NSYPLA1073TG	NSYPLAZ1073G
1000	750	420	1	NSYPLA1074G	NSYPLA1074TG	NSYPLAZ1074G
1000	1000	320	2	NSYPLA10103G	NSYPLA10103TG	NSYPLAZ10103G
1000	1000	420	2	NSYPLA10104G	NSYPLA10104TG	NSYPLAZ10104G
1000	1250	320	2	NSYPLA10123G	NSYPLA10123TG	NSYPLAZ10123G
1000	1250	420	2	NSYPLA10124G	NSYPLA10124TG	NSYPLAZ10124G
1250	500	320	1	NSYPLA1253G	NSYPLA1253TG	NSYPLAZ1253G
1250	500	420	1	NSYPLA1254G	NSYPLA1254TG	NSYPLAZ1254G
1250	750	320	1	NSYPLA1273G	NSYPLA1273TG	NSYPLAZ1273G
1250	750	420	1	NSYPLA1274G	NSYPLA1274TG	NSYPLAZ1274G
1250	750	620	1	NSYPLA1276G	NSYPLA1276TG	NSYPLAZ1276G
1250	1000	320	2	NSYPLA12103G	NSYPLA12103TG	NSYPLAZ12103G
1250	1000	420	2	NSYPLA12104G	NSYPLA12104TG	NSYPLAZ12104G
1250	1250	320	2	NSYPLA12123G	NSYPLA12123TG	NSYPLAZ12123G
1250	1250	420	2	NSYPLA12124G	NSYPLA12124TG	NSYPLAZ12124G
1250	1250	620	2	NSYPLA12126G	NSYPLA12126TG	NSYPLAZ12126G
1500	500	320	1	NSYPLA1553G	NSYPLA1553TG	NSYPLAZ1553G
1500	500	420	1	NSYPLA1554G	NSYPLA1554TG	NSYPLAZ1554G
1500	750	320	1	NSYPLA1573G	NSYPLA1573TG	NSYPLAZ1573G
1500	750	420	1	NSYPLA1574G	NSYPLA1574TG	NSYPLAZ1574G
1500	750	620	1	NSYPLA1576G	NSYPLA1576TG	NSYPLAZ1576G
1500	1000	320	2	NSYPLA15103G	NSYPLA15103TG	NSYPLAZ15103G
1500	1000	420	2	NSYPLA15104G	NSYPLA15104TG	NSYPLAZ15104G
1500	1250	320	2	NSYPLA15123G	NSYPLA15123TG	NSYPLAZ15123G
1500	1250	420	2	NSYPLA15124G	NSYPLA15124TG	NSYPLAZ15124G
1500	1250	620	2	NSYPLA15126G	NSYPLA15126TG	NSYPLAZ15126G
2000	750	420	2*	NSYPLA2074G	NSYPLA2074TG	NSYPLAZ2074G

*Two doors in vertical.

**Recommended to protect against the direct UV radiation.

PHD - Applicative and customized solutions:

See the Polyester Heavy-Duty offer in the applicative and customized solutions, [page 434](#).

Technical changes reserved. Information provided without guarantee. Images are for illustrative purposes only.

Enclosures with ventilated canopy, IP44 Enclosures with open bottom part and ventilated canopy, IP44



PLAT



PLAZT

Dimensions (mm)				Plain	Plain
Height	Width	Depth	N° of doors		
500	500	320	1	NSYPLAT553G	NSYPLAZT553G
500	500	420	1	NSYPLAT554G	NSYPLAZT554G
500	750	320	1	NSYPLAT573G	NSYPLAZT573G
500	750	420	1	NSYPLAT574G	NSYPLAZT574G
500	1000	320	2	NSYPLAT5103G	NSYPLAZT5103G
500	1000	420	2	NSYPLAT5104G	NSYPLAZT5104G
500	1250	320	2	NSYPLAT5123G	NSYPLAZT5123G
500	1250	420	2	NSYPLAT5124G	NSYPLAZT5124G
750	500	320	1	NSYPLAT753G	NSYPLAZT753G
750	500	420	1	NSYPLAT754G	NSYPLAZT754G
750	750	320	1	NSYPLAT773G	NSYPLAZT773G
750	750	420	1	NSYPLAT774G	NSYPLAZT774G
750	750	620	1	NSYPLAT776G	NSYPLAZT776G
750	1000	320	2	NSYPLAT7103G	NSYPLAZT7103G
750	1000	420	2	NSYPLAT7104G	NSYPLAZT7104G
750	1250	320	2	NSYPLAT7123G	NSYPLAZT7123G
750	1250	420	2	NSYPLAT7124G	NSYPLAZT7124G
1000	500	320	1	NSYPLAT1053G	NSYPLAZT1053G
1000	500	420	1	NSYPLAT1054G	NSYPLAZT1054G
1000	750	320	1	NSYPLAT1073G	NSYPLAZT1073G
1000	750	420	1	NSYPLAT1074G	NSYPLAZT1074G
1000	1000	320	2	NSYPLAT10103G	NSYPLAZT10103G
1000	1000	420	2	NSYPLAT10104G	NSYPLAZT10104G
1000	1250	320	2	NSYPLAT10123G	NSYPLAZT10123G
1000	1250	420	2	NSYPLAT10124G	NSYPLAZT10124G
1250	500	320	1	NSYPLAT1253G	NSYPLAZT1253G
1250	500	420	1	NSYPLAT1254G	NSYPLAZT1254G
1250	750	320	1	NSYPLAT1273G	NSYPLAZT1273G
1250	750	420	1	NSYPLAT1274G	NSYPLAZT1274G
1250	750	620	1	NSYPLAT1276G	NSYPLAZT1276G
1250	1000	320	2	NSYPLAT12103G	NSYPLAZT12103G
1250	1000	420	2	NSYPLAT12104G	NSYPLAZT12104G
1250	1250	320	2	NSYPLAT12123G	NSYPLAZT12123G
1250	1250	420	2	NSYPLAT12124G	NSYPLAZT12124G
1250	1250	620	2	NSYPLAT12126G	NSYPLAZT12126G
1500	500	320	1	NSYPLAT1553G	NSYPLAZT1553G
1500	500	420	1	NSYPLAT1554G	NSYPLAZT1554G
1500	750	320	1	NSYPLAT1573G	NSYPLAZT1573G
1500	750	420	1	NSYPLAT1574G	NSYPLAZT1574G
1500	750	620	1	NSYPLAT1576G	NSYPLAZT1576G
1500	1000	320	2	NSYPLAT15103G	NSYPLAZT15103G
1500	1000	420	2	NSYPLAT15104G	NSYPLAZT15104G
1500	1250	320	2	NSYPLAT15123G	NSYPLAZT15123G
1500	1250	420	2	NSYPLAT15124G	NSYPLAZT15124G
1500	1250	620	2	NSYPLAT15126G	NSYPLAZT15126G
2000	750	420	Two doors in vertical	NSYPLAT2074G	NSYPLAZT2074G

PHD - Applicative and customized solutions:

See the Polyester Heavy-Duty offer in the applicative and customized solutions, [page 434](#).

Technical changes reserved. Information provided without guarantee. Images are for illustrative purposes only.

Horizontal coupling kits, 15 mm, joining two enclosures mounted on ZA plinths

- For coupling two enclosures side by side.
- Coupling frame kit: Made up of a coupling kit and the fixings required for installation.
- Trim kit: Made up of two frames for aesthetic fitting of the two coupled enclosures
- Coupling kit widths: 15 mm, joining two enclosures mounted on ZA plinths
- Ingress protection rating: IP55 at the coupling point

Note:
Not valid for coupling two enclosures using ZZ or ZH type plinth.

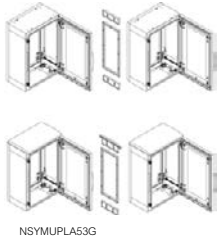

Characteristics	Depth (mm)	Height (mm)	References
Coupling frame kit 15 mm	320	500	NSYMUPLA53G
Coupling frame kit 15 mm	320	750	NSYMUPLA73G
Coupling frame kit 15 mm	320	1000	NSYMUPLA103G
Coupling frame kit 15 mm	320	1250	NSYMUPLA123G
Coupling frame kit 15 mm	320	1500	NSYMUPLA153G
Coupling frame kit 15 mm	420	500	NSYMUPLA54G
Coupling frame kit 15 mm	420	750	NSYMUPLA74G
Coupling frame kit 15 mm	420	1000	NSYMUPLA104G
Coupling frame kit 15 mm	420	1250	NSYMUPLA124G
Coupling frame kit 15 mm	420	1500	NSYMUPLA154G
Coupling frame kit 15 mm	420	2000	NSYMUPLA204G
Coupling frame kit 15 mm	620	750	NSYMUPLA76G
Coupling frame kit 15 mm	620	1250	NSYMUPLA126G
Coupling frame kit 15 mm	620	1500	NSYMUPLA156G
Trim kit for enclosure without canopy	320	-	NSYSUPLA3G
Trim kit for enclosure with canopy	320	-	NSYSUPLA3TG
Trim kit for enclosure without canopy	420	-	NSYSUPLA4G
Trim kit for enclosure with canopy	420	-	NSYSUPLA4TG

Horizontal coupling kits, 35 mm, joining two enclosures mounted on ZZ or ZH plinths

- For coupling two enclosures side by side.
- Coupling frame kit: Made up of a coupling kit and the fixings required for installation.
- Coupling kit widths: 35 mm, joining two enclosures mounted on ZZ or ZH plinths
- Ingress protection rating: IP55 at the coupling point

Note:
Not valid for coupling two enclosures using ZA plinths

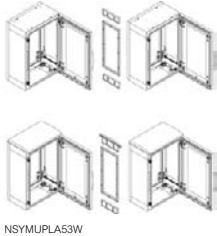

Characteristics	Depth (mm)	Height (mm)	References
Coupling frame kit 35 mm	320	500	NSYMUPLA53W
Coupling frame kit 35 mm	320	750	NSYMUPLA73W
Coupling frame kit 35 mm	320	1000	NSYMUPLA103W
Coupling frame kit 35 mm	320	1250	NSYMUPLA123W
Coupling frame kit 35 mm	320	1500	NSYMUPLA153W
Coupling frame kit 35 mm	420	500	NSYMUPLA54W
Coupling frame kit 35 mm	420	750	NSYMUPLA74W
Coupling frame kit 35 mm	420	1000	NSYMUPLA104W
Coupling frame kit 35 mm	420	1250	NSYMUPLA124W
Coupling frame kit 35 mm	420	1500	NSYMUPLA154W
Coupling frame kit 35 mm	420	2000	NSYMUPLA204W
Coupling frame kit 35 mm	620	750	NSYMUPLA76W
Coupling frame kit 35 mm	620	1250	NSYMUPLA126W
Coupling frame kit 35 mm	620	1500	NSYMUPLA156W

Vertical coupling kit

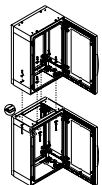

- For coupling two enclosures on top of one another.
- Set of 3.5 m of adhesive seal and the fixings required for mounting.
- Ingress protection rating: IP55 at the coupling point

Characteristics	References
Vertical coupling kit	NSYUVPLA

Canopy

- Can be installed in all enclosure models.
- High resistance to impacts, temperature and bad weather.
- Increases the height (A) of the enclosure by 38 mm without modifying its width or depth.
- Material: Polyester reinforced with fiberglass
- Color: RAL 7035 grey
- Installation: Essential for outdoor use

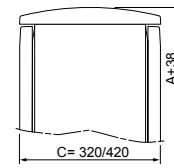

Supply:
Delivered with the fixings required for installation



Characteristics	Width (mm)	Depth (mm)	References
Canopy	500	320	NSYTJPLA53G
Canopy	500	420	NSYTJPLA54G
Canopy	750	320	NSYTJPLA73G
Canopy	750	420	NSYTJPLA74G
Canopy	750	620	NSYTJPLA76G
Canopy	1000	320	NSYTJPLA103G
Canopy	1000	420	NSYTJPLA104G
Canopy	1250	320	NSYTJPLA123G
Canopy	1250	420	NSYTJPLA124G
Canopy	1250	620	NSYTJPLA126G

Wall fixing lugs



- Drilling positions and marks inside the side panels.
- Material: Passivated zinc-coated steel
 - Maximum load: 180 kg including weight of enclosure
- Fixing:** Fixing on the sides by four or six lugs in horizontal position (six lugs for enclosures with height ≥ 1000 mm)
10 mm fixing distance on the rear of the enclosure plane

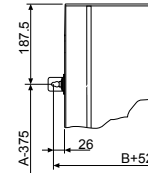

Supply:
Set of six lugs and fixings

Characteristics	References
Wall fixing lugs	NSYFMPLA

PLAZ PLAZT Cable entry plate

- Easy drilling in specific customized version.
- Not compatible with: Adapter plates, step slides, internal door and chassis for modular distribution.
- Material: Polyester reinforced with fiberglass
- Thickness: 4 mm

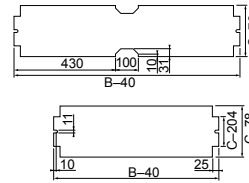

Supply:
Delivered with the fixings required for installation



Characteristics	Width (mm)	Depth (mm)	References
Cable entry plate	500	320	NSYECPLAZ53G
Cable entry plate	500	420	NSYECPLAZ54G
Cable entry plate	750	320	NSYECPLAZ73G
Cable entry plate	750	420	NSYECPLAZ74G
Cable entry plate	750	620	NSYECPLAZ76G
Cable entry plate	1000	320	NSYECPLAZ103G
Cable entry plate	1000	420	NSYECPLAZ104G
Cable entry plate	1250	320	NSYECPLAZ123G
Cable entry plate	1250	420	NSYECPLAZ124G
Cable entry plate	1250	620	NSYECPLAZ126G

Renovation and anti-graffiti paint

Supply: NSYAUPG1G
The 1 kg reference includes one pot with 800 g of base paint and 200 g of hardener (It is enough to paint a surface of around 5 m²)

- Paint kit with two components (base 80% + hardener 20%)
- Specially developed for the renovation of polyester enclosures and/or to facilitate the easy removal of graffiti.
- Color: RAL 7035 grey



Characteristics	References
Renovation and anti-graffiti paint	NSYAUPG1G

- Solvent bottles to be used as a paint thinner or to clean brushes.

Supply:
1 kg

Characteristics	References
Renovation and anti-graffiti paint solvent	NSYAUPGS



Characteristics	ZA plinths for PLA and PLAT versions
	<ul style="list-style-type: none"> The front parts of the plinth (front and rear) have two stainless-steel screws protected by a plastic cap; these screws, which can be accessed from the outside, make it possible (using an Allen key) to open and remove the front parts for easier cable installation. In stacked position, the bottom plinth can be partially buried. It is provided with one or two reinforcement cross-rails, adjustable to adjust to the position of the cables.
Material	Polyester reinforced with fiberglass
Color	RAL 7035 grey
Ingress protection rating	IP44
Mechanical protection rating	IK10
Fixing	Four floor attachment points; symmetry of the parts prevents incorrect assembly
Supply	The reference of the plinth contains all the accessories required for attaching the enclosure to the plinth and for stacking two plinths

For floor-standing enclosure			Plinth		Cable gland area		Height 200 mm
Width (mm)	Depth (mm)	References	Width (mm)	Depth (mm)	Width (mm)	Depth (mm)	References
500	320	NSYPLA(T)●53G	494	250	360	205	NSYZA253G
750	320	NSYPLA(T)●73G	744	250	610	205	NSYZA273G
1000	320	NSYPLA(T)●103G	994	250	860	205	NSYZA2103G
1250	320	NSYPLA(T)●123G	1244	250	1100	205	NSYZA2123G
500	420	NSYPLA(T)●54G	494	350	360	305	NSYZA254G
750	420	NSYPLA(T)●74G	744	350	610	305	NSYZA274G
1000	420	NSYPLA(T)●104G	994	350	860	305	NSYZA2104G
1250	420	NSYPLA(T)●124G	1244	350	1110	305	NSYZA2124G
750	620	NSYPLA(T)●76G	744	550	610	505	NSYZA276G
1250	620	NSYPLA(T)●126G	1244	550	1110	505	NSYZA2126G

Cable supporting cross-rail

- Description: The lateral sides of the plinth are provided with bosses for attaching cross-rails with cut-out profiles, for supporting cables.

Supply:
the reference of the cross-rail includes all the elements required for assembly.



Characteristics	For plinth	For plinth	References
Cable supporting cross-rail	NSYZA253G	NSYZA254G	NSYAC320
Cable supporting cross-rail	NSYZA273G	NSYZA274G	NSYAC560
Cable supporting cross-rail	NSYZA2103G	NSYZA2104G	NSYAC840
Cable supporting cross-rail	NSYZA2123G	NSYZA2124G	NSYAC1080

Feet for partially buried installation

Description: Allows the partially buried installation of plinths before completion of the floor. The plinths are attached by four feet with a standard length of 750 mm. Option of horizontal adjustment of the plinth.

Supply:
Kit includes four feet and fixings.



NSYAEBFZ

Characteristics	References
Feet for partially buried installation	NSYAEBFZ

N plinths

Designed to be installed under the closed bottom enclosures (version PLA or PLAT).

- Material: Polyester reinforced with fiberglass
- Color: RAL 7035 grey
- Height 60 mm

Supply:
Delivered with fixings required for installation



NSYZNPLA53G

Characteristics	References
N plinths	NSYZNPLA53G
N plinths	NSYZNPLA73G
N plinths	NSYZNPLA103G
N plinths	NSYZNPLA123G
N plinths	NSYZNPLA54G
N plinths	NSYZNPLA74G
N plinths	NSYZNPLA104G
N plinths	NSYZNPLA124G

Connectors between plinths

Description: Designed to allow the adaptation of a closed bottom enclosure + N plinth on a H-type partially buried plinth.

- NSYPLA or NSYPLAT not for NSYPLAZ●●●
- NSYZNPLA●●●
- NSYAZ●●●
- NSYZHPLA●●●

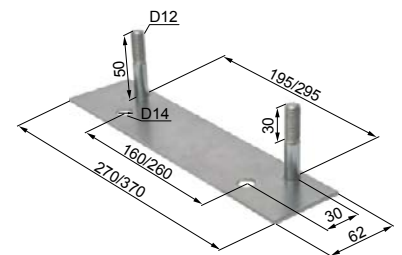
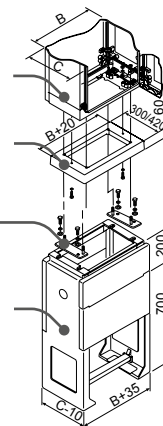

Supply:
two parts for adapting the center-to-center distances.



NSYAZ3PLA

Characteristics	For floor-standing enclosure Depth (mm)	References
Linking parts for N plinth on 320 mm H plinth	320	NSYAZ3PLA
Linking parts for N plinth on 420 mm H plinth	420	NSYAZ4PLA



(1) For enclosures using ZZ or ZH type plinths the coupling kit to use is the **NSYMUPLA●●●W**.

Characteristics	ZZ plinths for PLAZ and PLAZT versions⁽¹⁾
	<ul style="list-style-type: none"> The front parts (front and rear) are removed from the inside. Removing them makes it easier to install the cables. The 500-mm plinth can be partially buried. It is provided with one or two reinforcement cross-rails, adjustable to adapt to the position of the cables.
Material	Polyester reinforced with fiberglass
Color	RAL 7035 grey
Ingress protection rating	IP44
Mechanical protection rating	IK10
Fixing	Four floor attachment points; symmetry of the parts prevents incorrect assembly
Supply	The reference of the plinth contains all the accessories required for attaching the enclosure to the plinth

For floor-standing enclosure			Plinth		Cable gland area		Height 200 mm	Height 500 mm
Width (mm) (B)	Depth (mm) (C)	References	Width (mm)	Depth (mm)	Width (mm)	Depth (mm)	References	References
500	320	NSYPLAZ(T)●53G	535	310	419	252	NSYZZ253G	NSYZZ553G
750	320	NSYPLAZ(T)●73G	785	310	669	252	NSYZZ273G	NSYZZ573G
1000	320	NSYPLAZ(T)●103G	1035	310	919	252	NSYZZ2103G	NSYZZ5103G
1250	320	NSYPLAZ(T)●123G	1285	310	1169	252	NSYZZ2123G	NSYZZ5123G
500	420	NSYPLAZ(T)●54G	535	410	419	352	NSYZZ254G	NSYZZ554G
750	420	NSYPLAZ(T)●74G	785	410	669	352	NSYZZ274G	NSYZZ574G
1000	420	NSYPLAZ(T)●104G	1035	410	919	352	NSYZZ2104G	NSYZZ5104G
1250	420	NSYPLAZ(T)●124G	1285	410	1169	352	NSYZZ2124G	NSYZZ5124G
750	620	NSYPLAZ(T)●76G	785	610	669	552	NSYZZ276G	-
1250	620	NSYPLAZ(T)●126G	1285	610	1169	552	NSYZZ2126G	-

Cable supporting cross-rail

- Description: The sides of the plinths are provided with bosses for the attachment of cross-rails with cutout profiles that support the cables.

Supply:

The reference of the cross-rail includes all elements required for assembly.



NSYAC360

Characteristics	For plinth	For plinth	For plinth	For plinth	References
Cable supporting cross-rail	NSYZZ253G	NSYZZ254G	NSYZZ553G	NSYZZ554G	NSYAC360
Cable supporting cross-rail	NSYZZ273G	NSYZZ274G	NSYZZ573G	NSYZZ574G	NSYAC600
Cable supporting cross-rail	NSYZZ2103G	NSYZZ2104G	NSYZZ5103G	NSYZZ5104G	NSYAC840
Cable supporting cross-rail	NSYZZ2123G	NSYZZ2124G	NSYZZ5123G	NSYZZ5124G	NSYAC1120

Outside opening kit



NSYAE LZ

- Description: The 200 mm front part of the 200 and 500 mm plinths can be opened from the outside, after installing a set of two locks with double-bar insert.

Characteristics	References
Outside opening kit	NSYAE LZ

Buriable H plinths



NSYZHPLA53G

- Front panel with a height of 170 mm, retractable, providing easy access to the inside.
- Fixed front panel with a height of 305 mm, corresponding to the finished floor height area.
- The height above the floor after built-in varies between 200 and 500 mm.
- A metal rail helps to fix the entry cables.
- Lateral uprights with knock-out auxiliary output with Ø Pg 36 (48 mm).
- A knock-out area is provided at the bottom of the lateral uprights for cable entry, if necessary.
- Material: Polyester reinforced with fiberglass
- Color: RAL 7035 grey

Supply:

Delivered with the fixings required for installation

Note:

For dimensions see [page 254](#)



NSYZHPLA53G

Characteristics	References
Buriable H plinths	NSYZHPLA53G
Buriable H plinths	NSYZHPLA73G
Buriable H plinths	NSYZHPLA103G
Buriable H plinths	NSYZHPLA123G
Buriable H plinths	NSYZHPLA54G
Buriable H plinths	NSYZHPLA74G
Buriable H plinths	NSYZHPLA104G
Buriable H plinths	NSYZHPLA124G

Floor-standing frame

- Frame for direct fixing on the floor for installing open bottom enclosures (version PLAZ or PLAZT).
- Material: Passivated zinc-coated steel

Supply:

Delivered with fixings required for installation

Note:

For dimensions see [page 254](#)



NSYMFPLAZ53

Characteristics	References
Floor-standing frame	NSYMFPLAZ53
Floor-standing frame	NSYMFPLAZ73
Floor-standing frame	NSYMFPLAZ103
Floor-standing frame	NSYMFPLAZ123
Floor-standing frame	NSYMFPLAZ54
Floor-standing frame	NSYMFPLAZ74
Floor-standing frame	NSYMFPLAZ104
Floor-standing frame	NSYMFPLAZ124
Floor-standing frame	NSYMFPLAZ76
Floor-standing frame	NSYMFPLAZ126

Floor-fixing studs



NSYFSP LAZ

- Description: Set of four threaded parts and fixings for fixing the enclosures on concrete plinths.

Characteristics	References
Floor-fixing studs	NSYFSP LAZ

Internal door

- Designed for direct installation in enclosures with sealed bottom part. In the enclosures with the bottom part open, installation can be performed by ordering the necessary adapter plates, ref. **NSYPTZ●●●**.
- Two depthwise mounting positions (two positions for depthwise installation) according to the chosen M8 impressions, on the top and bottom parts of the enclosure, for fixing.
- Lock with 5-mm double-bar inserts.
- Not compatible with: Modular distribution chassis, 19" chassis, cable entry plate and door retainer, ref. **NSYRETPLAU**.
- Material: Aluminum
- Color: RAL 7035 grey

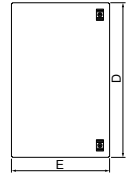

Supply:
Delivered with M8 brass inserts and fixings

Note:
For dimensions see [page 254](#)



Dimensions		Internal door dimensions		References
Height (mm)	Width (mm)	D (mm)	E (mm)	
500	500	398	398	NSYPAPLA55G
500	750	398	648	NSYPAPLA57G
500	1000	398	796 (2 x 398)	2 x NSYPAPLA55G
500	1250	398	1046 (398 + 648)	NSYPAPLA55G + NSYPAPLA57G
750	500	648	398	NSYPAPLA75G
750	750	648	648	NSYPAPLA77G
750	1000	648	796 (2 x 398)	2 x NSYPAPLA75G
750	1250	648	1046 (398 + 648)	NSYPAPLA75G + NSYPAPLA77G
1000	500	898	398	NSYPAPLA105G
1000	750	898	648	NSYPAPLA107G
1000	1000	898	796 (2 x 398)	2 x NSYPAPLA105G
1000	1250	898	1046 (398 + 648)	NSYPAPLA105G + NSYPAPLA107G
1250	500	1148	398	NSYPAPLA125G
1250	750	1148	648	NSYPAPLA127G
1250	1000	1148	796 (2 x 398)	2 x NSYPAPLA125G
1250	1250	1148	1046 (398 + 648)	NSYPAPLA125G + NSYPAPLA127G
1500	500	1398	398	NSYPAPLA155G
1500	750	1398	648	NSYPAPLA157G
1500	1000	1398	796 (2 x 398)	2 x NSYPAPLA155G
1500	1250	1398	1046 (398 + 648)	NSYPAPLA155G + NSYPAPLA157G

Supply:
Delivered with the fixings required for installation

Note:
ref. **NSYRETPLAU** is incompatible with internal doors, modular distribution chassis, step slides, adapter plates and cable entry plates. If not compatible, use ref. **NSYRETPLA**.

- Designed to adapt directly to the enclosure
- Can be installed on a door opening to the left or right indistinctly
- Material: Galvanized steel

Characteristics	References
Door retainer, PLA, PLAZ, PLAT versions, opening to 110°	NSYRETPLA
Door retainer, PLA, PLAZ, PLAT, PLAZT versions*, with 2 positions, 90° and 120°	NSYRETPLAU



Door switch

- NC + NO switch.
- Incompatible with the rear door and modular distribution chassis

Supply:
Switch, fixing bracket and fixings



Characteristics	References
Door switch	NSYSNLPLA

Lock with handle

- Ergonomic locking system with pivoting handle installed as standard on enclosures with ventilated canopy and/or open bottom part, with a 5-mm double-bar insert block.
- Material: PA6
- Color: RAL 7035 grey

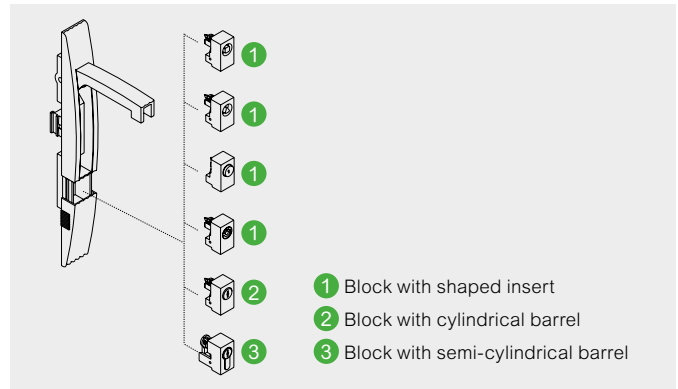

Options for converting the form-insert blocks



NSYINS61

Characteristics	References
6 mm square insert	NSYINS61
7 mm square insert	NSYINS71
8 mm square insert	NSYINS81
6.5 mm triangular insert	NSYINT61
8 mm triangular insert	NSYINT81
Push-button	NSYTSPLA
Double-bar	NSYINDB51

Options for converting the blocks to cylindrical barrels

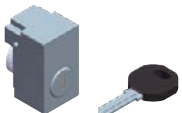

NSYIN405E1

Characteristics	References
405E key lock	NSYIN405E1
421E key lock	NSYIN421E1
455 key lock	NSYIN4551
1242E key lock	NSYIN1242E1
1332E key lock	NSYIN1332E1
2124E key lock	NSYIN2124E1
2131A key lock	NSYIN2131A1
2132A key lock	NSYIN2132A1
2331A key lock	NSYIN2331A1
2433A key lock	NSYIN2433A1
2452E key lock	NSYIN2452E1
3113A key lock	NSYIN3113A1
3122E key lock	NSYIN3122E1
3123A key lock	NSYIN3123A1
3131A1 key lock	NSYIN3131A1
3133A key lock	NSYIN3133A1
3422E key lock	NSYIN3422E1
3432E key lock	NSYIN3432E1
6101 key lock	NSYIN6101

Options for converting the blocks to semi-cylindrical barrels

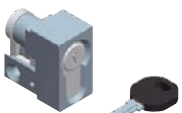

NSYIN1242E2

Characteristics	References
Spacial SF/SM 1242E key lock	NSYIN1242E2
Spacial SF/SM Adapter for DIN cylinder	NSYINDIN2
Spacial SF/SM JIS key lock	NSYINKJIS2
Spacial SF/SM Reinforced key lock	NSYINKR2
Spacial SF/SM FAC key lock	NSYINKFAC2

Options for converting the handle lock

- Changing the handle for a handle including a padlocking device (Ø 10 mm) allowing the handle to be locked. The handle is delivered without barrel or insert block.



NSYCBCMPLAG

Characteristics	References
Options for converting the handle lock	NSYCBCMPLAG

Options for converting the handle lock

- Spare handle lock without barrel or insert blocks. The insert or barrel are to be chosen from the option table.



NSYEBMPLAG

Characteristics	References
Options for converting the handle lock	NSYEBMPLAG



NSYLDDB5

NSYLC8

NSYLT8

Type of lock	Insert references	Key references
5-mm double-bar	NSYTDB5PLA	NSYLDDB5
6 mm	NSYTC6CRN	NSYLC7
7 mm	NSYTC7CRN	NSYLC7
8 mm	NSYTC8CRN	NSYLC8
6.5 mm	NSYTT6CRN	NSYLT8
7 mm	NSYTT7CRN	NSYLT8
8 mm	NSYTT8CRN	NSYLT8

19" fixed chassis

Installation: For heights from 750 to 1500 mm, the installation requires ordering one set of two matching uprights. If a chassis is installed in an enclosure with a greater height, it is necessary to use the suitable uprights for the size of the enclosure

- Very sturdy 19" metal chassis, designed for installation in enclosures with a width of 750 and 1250 mm.
In enclosures with a width of 1250 mm, the chassis is installed in the 750-mm part with an intermediate support, ref. **NSYSBPLA**.
- These chassis can be used as partial mounting plates in enclosures with a height greater than the nominal height.
- Incompatible with the internal doors and the step slides.
- Fixed chassis made up of two uprights with fixings
- Material: Galvanized steel
- Finish: Epoxy polyester paint
- Color: RAL 7035 grey
- Maximum load: 3 kg per unit

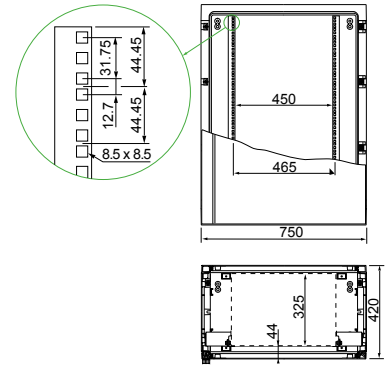

Note:
For dimensions see [page 257](#)



NSYBRF8PLAG

Characteristics	Height (mm)	Width (mm)	# of units	References
19" fixed chassis	500	750	8	NSYBRF8PLAG
19" fixed chassis	750	750	12	NSYBRF12PLAG
19" fixed chassis	1000	750	17	NSYBRF17PLAG
19" fixed chassis	1250	750	21	NSYBRF21PLAG
19" fixed chassis	1500	750	26	NSYBRF26PLAG
19" fixed chassis	2000	750	2 x 17	2 x NSYBRF17PLAG + NSYPTZ4
Set of two uprights	750	750	12	NSYSPLA75
Set of two uprights	1000	750	17	NSYSPLA100
Set of two uprights	1250	750	21	NSYSPLA125
Set of two uprights	1500	750	26	NSYSPLA150*
Set of two uprights	2000	750	2 x 17	2 x NSYSPLA100



* Not compatible with **NSYCAAPVHD**.



Note:
For dimensions see [page 255](#)

Characteristics	Plain mounting plate	Telequick mounting plate	Insulated mounting plate	
	<ul style="list-style-type: none"> Direct installation on M8 inserts at the rear of the enclosure or on step slides for depth adjustment (see page 250). The enclosures with height of ≥ 1000 mm have intermediate impressions for installing mounting plates of a lesser height (M8 inserts, ref. NSYTEX8, to be ordered separately). In the two door enclosures, it is possible to install one complete mounting plate or two individual mounting plates. 	<ul style="list-style-type: none"> Grille with 11 x 26 mm drill holes, with a step of 15 x 30 mm, for direct installation, with clip nuts, of all the devices with fixing at 2, 3 or 4 points, by screws with diameters of 3, 4, 5 or 6 mm. Direct installation on M8 inserts at the rear of the enclosure or on step slides for depth adjustment (see page 250). The enclosures with height of ≥ 1000 mm have intermediate impressions for installing mounting plates of a lesser height (M8 inserts, ref. NSYTEX8, to be ordered separately). 	<ul style="list-style-type: none"> Direct installation on M8 inserts at the rear of the enclosure or on step slides for depth adjustment (see page 250). The enclosures with height of ≥ 1000 mm have intermediate impressions for installing mounting plates of a lesser height (M8 inserts, ref. NSYTEX8, to be ordered separately). In the two door enclosures, it is possible to install one complete mounting plate or two individual mounting plates. 	
Material	Galvanized sheet steel	Galvanized steel	Bakelite	Polyester
Finish	-	-	-	-
Color	-	-	-	-
Thickness	2.5 mm	-	4 mm	<ul style="list-style-type: none"> 4 mm up to 700 mm height 5 mm from 800 mm height
Maximum load	150 kg/m ²	150 kg/m ²	100 kg/m ²	100 kg/m ²
Supply	One mounting plate	One mounting plate	One mounting plate	One mounting plate

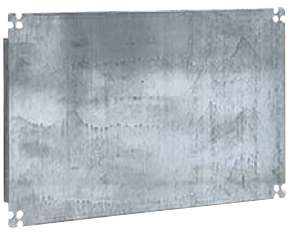
Dimensions					Dimensions					
Height (A) (mm)	Width (B) (mm)	H (mm)	Surface (dm ²)	References	E (mm)	D (mm)	Surface (dm ²)	References	References	References
500	500	-	14	NSYPMM55	350	350	13	NSYPMR55	NSYPMB55	NSYPMA55
500	750	-	24	NSYPMM75	350	600	23	NSYPMR57	NSYPMB75	NSYPMA75
500	1000	437.5	32	NSYPMM510	350	2 x 350	26	2 x NSYPMR55	NSYPMB510	NSYPMA510
500	1250	-	38	NSYPMM55 + NSYPMM75	350	350 + 600	36	NSYPMR55 + NSYPMR75	NSYPMB55 + NSYPMB75	NSYPMA55 + NSYPMA75
750	500	-	24	NSYPMM75	600	350	23	NSYPMR75	NSYPMB75	NSYPMA75
750	750	-	40	NSYPMM77	600	600	38	NSYPMR77	NSYPMB77	NSYPMA77
750	1000	437.5	54	NSYPMM710	600	2 x 350	46	2 x NSYPMR75	NSYPMB710	NSYPMA710
750	1250	687.5	70	NSYPMM712	600	350 + 600	61	NSYPMR75 + NSYPMR77	NSYPMB712	NSYPMA712
1000	500	-	33	NSYPMM105	850	350	32	NSYPMR105	NSYPMB105	NSYPMA105
1000	750	-	55	NSYPMM107	850	600	54	NSYPMR107	NSYPMB107	NSYPMA107
1000	1000	437.5	74	NSYPMM1010	850	2 x 350	64	2 x NSYPMR105	NSYPMB1010	NSYPMA1010
1000	1250	687.5	96	NSYPMM1012	850	350 + 600	86	NSYPMR105 + NSYPMR107	NSYPMB1012	NSYPMA1012
1250	500	-	42	NSYPMM125	1100	350	42	NSYPMR125	NSYPMB125	NSYPMA125
1250	750	-	70	NSYPMM127	1100	600	70	NSYPMR127	NSYPMB127	NSYPMA127
1250	1000	437.5	96	NSYPMM1210	1100	2 x 350	84	2 x NSYPMR125	NSYPMB1210	NSYPMA1210
1250	1250	687.5	124	NSYPMM1212	1100	350 + 600	112	NSYPMR125 + NSYPMR127	NSYPMB1212	NSYPMA1212
1500	500	-	51	NSYPMM155	1350	350	51	NSYPMR155	NSYPMB155	-
1500	750	-	85	NSYPMM157	1350	600	85	NSYPMR157	NSYPMB157	-
1500	1000	437.5	118	NSYPMM1510	1350	2 x 350	102	2 x NSYPMR155	NSYPMB1510	-
1500	1250	687.5	152	NSYPMM1512	1350	350 + 600	136	NSYPMR155 + NSYPMR157	NSYPMB1512	-
2000	750	-	115	NSYPMM207	2 x 850	2 x 600	108	2 x NSYPMR107	2 x NSYPMB107	2 x NSYPMA107

Partial plain mounting plate	Technical uprights	Anti burglary accessory
		
<ul style="list-style-type: none"> Direct fixing on the uprights with the notched sliding nuts or pivoting nuts, see common accessories section. 	<ul style="list-style-type: none"> Supports for fixing rails, perforated grilles and plain partial mounting plates. Details in the common accessory section. Fixing at the rear on the M8 inserts or on the step slides. 	<ul style="list-style-type: none"> Anti burglary accessory for polyester outdoor heavy-duty enclosure in accordance with ENV 1627-1630:2011 Class 2.
Galvanized sheet steel	Zinc-coated steel	Steel with anti-corrosive painting
-	-	Structured finish, 100% polyester powder
-	-	RAL 7035 grey
2.5 mm	2 mm	-
150 kg/m ²		
One mounting plate	Two technical uprights	One anti burglary frame

Height 247 mm (H)	Height 397 mm (H)			Depth 420 mm	Depth 620 mm
References	References	Dimensions (mm)	References	References	References
-	-	-	-	-	-
NSYSPMP2575	-	-	-	-	-
NSYSPMP25100	NSYSPMP40100	-	-	-	-
-	-	-	-	-	-
-	-	625	NSYTVR7	-	-
NSYSPMP2575	-	625	NSYTVR7	NSYBGN774HD	NSYBGN776HD
NSYSPMP25100	NSYSPMP40100	625	NSYTVR7	-	-
-	-	625	NSYTVR7	-	-
-	-	875	NSYTVR10	NSYBGN1054HD	-
NSYSPMP2575	-	875	NSYTVR10	NSYBGN1074HD	-
NSYSPMP25100	NSYSPMP40100	875	NSYTVR10	-	-
-	-	875	NSYTVR10	-	-
-	-	1125	NSYTVR125	NSYBGN1254HD	-
NSYSPMP2575	-	1125	NSYTVR125	NSYBGN1274HD	NSYBGN1276HD
NSYSPMP25100	NSYSPMP40100	1125	NSYTVR125	-	-
-	-	1125	NSYTVR125	NSYBGN12124HD	NSYBGN12126HD
-	-	1375	NSYTVR15	-	-
NSYSPMP2575	-	1375	NSYTVR15	NSYBGN1574HD	NSYBGN1576HD
NSYSPMP25100	NSYSPMP40100	1375	NSYTVR15	-	-
-	-	1375	NSYTVR15	NSYBGN15124HD	NSYBGN15126HD
NSYSPMP2575	-	1875	2 x NSYTVR10	NSYBGN2074HD	-
		Note: Enclosures with widths of 1000 and 1250 allow the installation of four uprights to integrate two mounting plates of 500 mm or of 500 and 750 mm.			

Modular distribution chassis

- Chassis for modular switchgear, installed directly in the sealed enclosures (PLA version).
For installation in enclosures with open bottom part (PLAZ version) it is necessary to use a set of adapter plates (ref. **NSYPTZ●●●**).
- Chassis made up of cover plates on a rigid structure.
- Quick installation without fixings.
- Distance between rail and front panel with adjustable depth from 40 to 85 mm.
- System for identifying electrical circuits supplied.
- Neutral/earth strip: 2 x 16 mm² + 5 x 6 mm² included in the standard offer.
- Incompatibility with: Cable entry plate, internal door, door switch and door retainer (ref. **NSYRETPLAU**).
- Material: Rigid structure: Galvanized steel, Cover plates: Self-extinguishing insulated
- Color: Cover plates: RAL 7035 grey

Note:

For dimensions see [page 249](#)
Other modular distribution accessories on [page 250](#)



Dimensions (mm)		No. of doors	No. of rows	Rows for module	No. of modules 18 mm	No. of plates	References
Height (A)	Width (B)						
750	500	1	4	4	76	-	NSYDLP76G
750	500	1	4	3	57	1	NSYDLP57G
750	750	1	4	4	132	-	NSYDLP132G
750	750	1	4	3	99	1	NSYDLP99G
750	1000	2	4 + 4	4 + 4	152	-	2 x NSYDLP76G
750	1000	2	4 + 4	3 + 3	114	1 + 1	2 x NSYDLP57G
750	1250	2	4 + 4	4 + 4	208	-	NSYDLP76G + NSYDLP132G
750	1250	2	4 + 4	3 + 3	156	1 + 1	NSYDLP57G + NSYDLP99G
1000	500	1	6	6	114	-	NSYDLP114G
1000	500	1	6	5	95	1	NSYDLP95G
1000	750	1	6	6	198	-	NSYDLP198G
1000	750	1	6	5	165	1	NSYDLP165G
1000	1000	2	6 + 6	6 + 6	228	-	2 x NSYDLP114G
1000	1000	2	6 + 6	5 + 5	190	1 + 1	2 x NSYDLP95G
1000	1250	2	6 + 6	6 + 6	312	-	NSYDLP114G + NSYDLP198G
1000	1250	2	6 + 6	5 + 5	260	1 + 1	NSYDLP95G + NSYDLP165G
1250	500	1	7	7	133	-	NSYDLP133G
1250	500	1	7	6	114	1	NSYDLP114PG
1250	750	1	7	7	231	-	NSYDLP231G
1250	750	1	7	6	198	1	NSYDLP198PG
1250	1000	2	7 + 7	7 + 7	266	-	2 x NSYDLP133G
1250	1000	2	7 + 7	6 + 6	228	1 + 1	2 x NSYDLP114PG
1250	1250	2	7 + 7	7 + 7	364	-	NSYDLP133G + NSYDLP231G
1250	1250	2	7 + 7	6 + 6	312	1 + 1	NSYDLP114PG + NSYDLP198PG
1500	500	1	9	9	171	-	NSYDLP171G
1500	500	1	9	8	152	1	NSYDLP152G
1500	750	1	9	9	297	-	NSYDLP297G
1500	750	1	9	8	264	1	NSYDLP264G
1500	1000	2	9 + 9	9 + 9	342	-	2 x NSYDLP171G
1500	1000	2	9 + 9	8 + 8	304	-	2 x NSYDLP152G
1500	1250	2	9 + 9	9 + 9	468	1 + 1	NSYDLP171G + NSYDLP297G
1500	1250	2	9 + 9	8 + 8	416	1 + 1	NSYDLP152G + NSYDLP264G

Modular distribution chassis

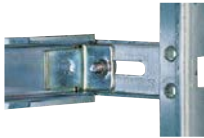
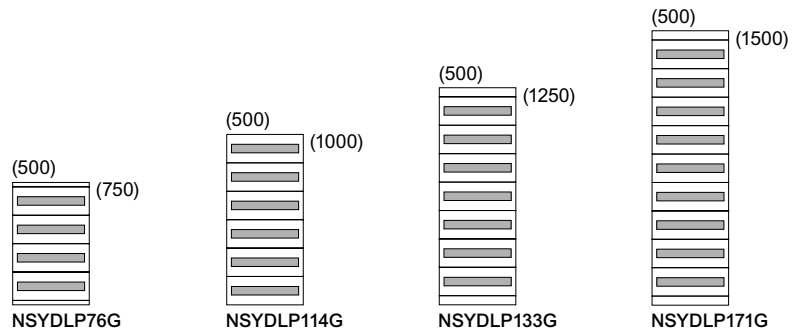

Details of the depth adjustment

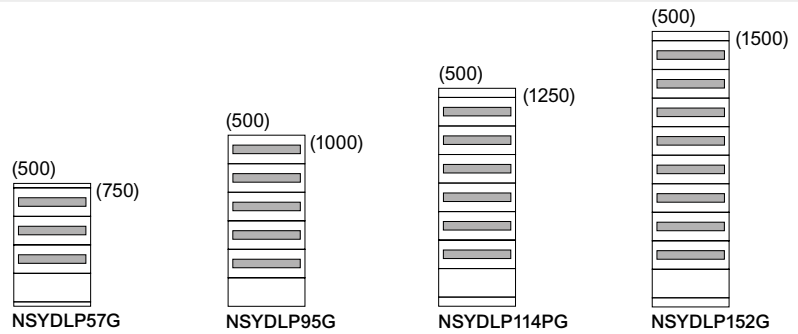

Detail from front panel mounting.

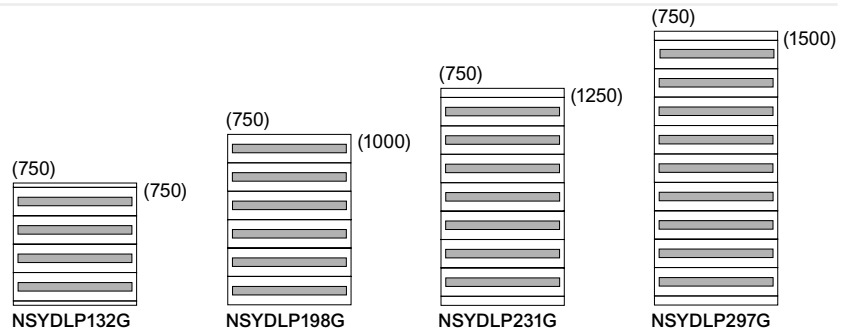

Detail from the circuit marking system.

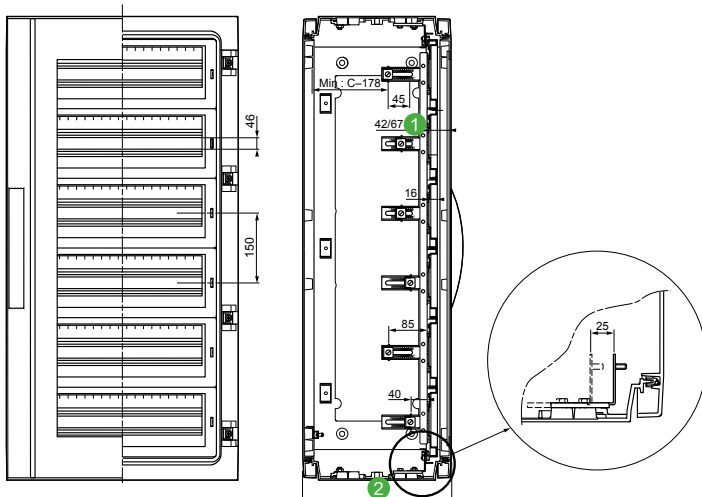
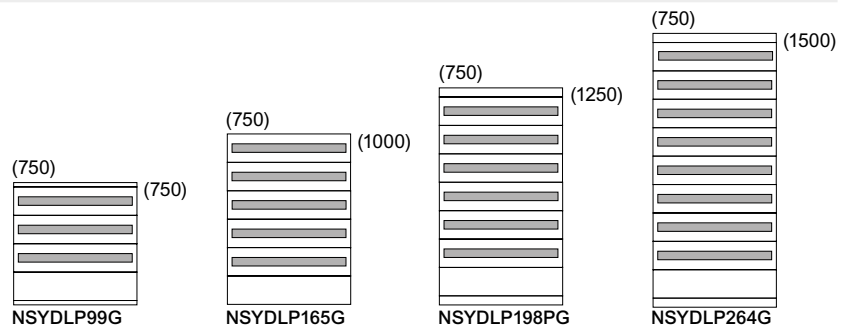

- 1 Dimensions of 42 or 67 mm or a pitch of 25 mm, according to the M8 boss chosen for the installation. See details in the enlarged image on the right. In enclosures with glazed doors, the two dimensions are reduced by 5 mm.
- 2 C = Depth of the enclosure.

Step slides

- Set of four step slides with brackets allowing continuous depth adjustment of the mounting plate, with a pitch of 25 mm.
- Designed for direct installation in the enclosures with sealed bottom part (versions PLA or PLAT).
- In the enclosures with open bottom part (versions PLAZ or PLAZT), installation is made possible by adding the relevant adapter plates.
- Incompatibility with: Internal door, modular distribution chassis, 19" chassis, cable entry plate and door retainer, ref. **NSYRETPLAU**.
- Material: Bracket with steel M8 stud on aluminum rail
- Fixing: Fixing on the top and bottom parts of the enclosure by means of M8 inserts and screws (supplied)



Note:
For dimensions see [page 255](#)



NSYDPLA3

Characteristics	Depth (mm)	No. of doors	References
Step slides	320	1	NSYDPLA3
Step slides	320	2	2 x NSYDPLA3
Step slides	420	1	NSYDPLA4
Step slides	420	2	2 x NSYDPLA4
Step slides	620	1	NSYDPLA6
Step slides	620	2	2 x NSYDPLA6

Adapter plates

- The enclosures with open bottom part (versions PLAZ and PLAZT) require a set of adapter plates for mounting: An internal door, step slides, modular chassis and 19" chassis.
- **NSYPTZ●●●** for one door enclosures
- **NSYPTX●●● 2P** for two door enclosures
- Material: Galvanized steel
- Fixing: Fixing on the bottom part of the enclosure by means of M8 inserts and screws (supplied)



NSYPTZ3

Characteristics	Depth (mm)	No. of doors	References
Adapter plates	320	1	NSYPTZ3
Adapter plates	320	2	NSYPTZ32P
Adapter plates	420	1	NSYPTZ4
Adapter plates	420	2	NSYPTZ42P
Adapter plates	620	1	NSYPTZ6
Adapter plates	620	2	NSYPTZ62P

9

Additional support

- Set of four additional brackets, to be slid into the step slides, for the installation of an additional mounting plate.

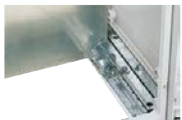

NSYEDPLA

Characteristics	Reference
Additional support	NSYEDPLA

Plain cover plate

- Plain cover plate for non-modular switchgear protection.
- Can be cutted out according to needs.
- Material: Polystyrene (PS) (for 146 mm high)
- Fiberglass reinforced polyester (for 298 mm high)
- Color: RAL 7035 grey

Supply:
Order by multiples of 2 (2, 4, 6...)

Note:
Dimensions, [page 256](#)



NSYCTL500DLPG

Characteristics	References
Plain cover plate	NSYCTL500DLPG
Plain cover plate	NSYCTL500DLP2
Plain cover plate	NSYCTL750DLPG
Plain cover plate	NSYCTL750DLP2

Supply:
Order by multiples of 2 (2, 4, 6...)

Note:
Dimensions, [page 256](#)

Plain mounting plate

- Plate for fixing non-modular devices.
- Depth-adjustable fixing on the supports from 40 to 85 mm..
- Material: Galvanized steel 2 mm thick

Characteristics	References
Plain mounting plate 146 for width 500	NSYPMP500DLP
Plain mounting plate 298 for width 500	NSYPMP5002DLP
Plain mounting plate 146 for width 750	NSYPMP750DLP
Plain mounting plate 298 for width 750	NSYPMP7502DLP

Technical changes reserved. Information provided without guarantee. Images are for illustrative purposes only.

Support plate



NSYSPLA75

Installation:

It is installed directly on the bottom part of the enclosure.

For the installation of one or several support plates, use two sets of two uprights suitable for the height (to be ordered separately). These uprights offer the option of adjusting the height with a step of 50 mm

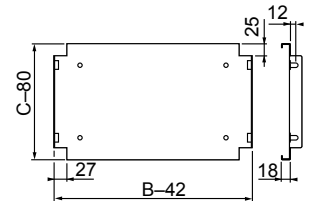
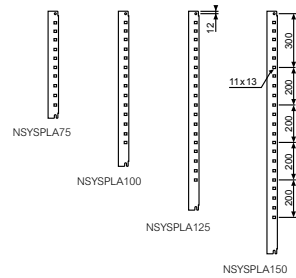

- Designed to support assorted equipment or simply to install a separation.
- In the two door enclosures, the installation of the plate or the uprights requires the prior installation of an intermediate support, ref. **NSYSBPLA**, presented beside.
- Material: Galvanized steel

Supply:

Delivered with the fixings required for installation

Height	Depth	Upright No. of adjustments	References
750	320 / 420	2	2 x NSYSPLA75
1000	320 / 420	3	2 x NSYSPLA100
1250	320 / 420	4	2 x NSYSPLA125
1500	–	5	2 x NSYSPLA150
2000	420	6	2 x NSYSPLA100

Depth (C)	Width (B)	Plate Max. load	References
320	500	60 kg	NSYBANPLA53
320	750	60 kg	NSYBANPLA73
420	500	50 kg	NSYBANPLA54
420	750	50 kg	NSYBANPLA74
620	500	50 kg	NSYBANPLA56*
620	750	50 kg	NSYBANPLA76

*Designed for PLA enclosures of 1250 mm width and 620 mm depth.

M8 inserts



NSYTEX8

- To be placed in the bosses molded on the doors, uprights, rear panels and bottom and top parts, for fixing accessories and assorted devices.
- Material: Brass

Supply:

References by unit. Order by multiples of 8 units (8, 16, 24, etc.)

Characteristics	References
Fixing inserts	NSYTEX8

Intermediate support in the two door enclosures



NSYSBPLA

- Required accessory for installing support plates, ref. **NSYBANPLA●●●** or uprights, ref. **NSYSPLA●●●** in the two door enclosures
- Material: Galvanized steel

Supply:

Two support kits

Characteristics	References
Intermediate support in the two door enclosures	NSYSBPLA

Recommendation

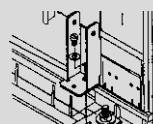

Intermediate support

Accessory required for installing uprights, ref. **NSYSPLA●●●**. Only for two door enclosures.
Supply: one (including two supports) ref. **NSYSBPLA**

Sealed enclosure or enclosure with ventilated canopy

For enclosures without canopy, please just disregard the related 38 mm.

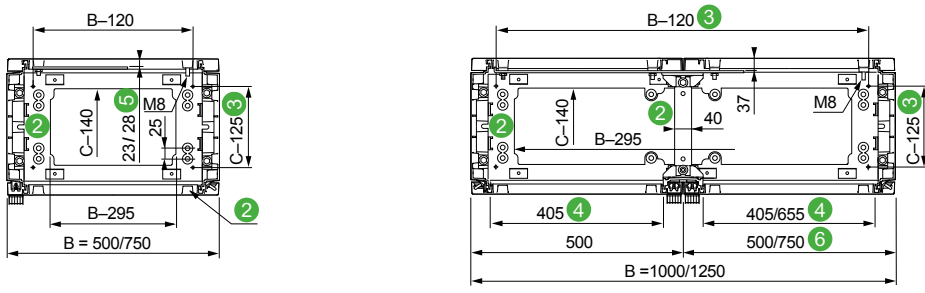
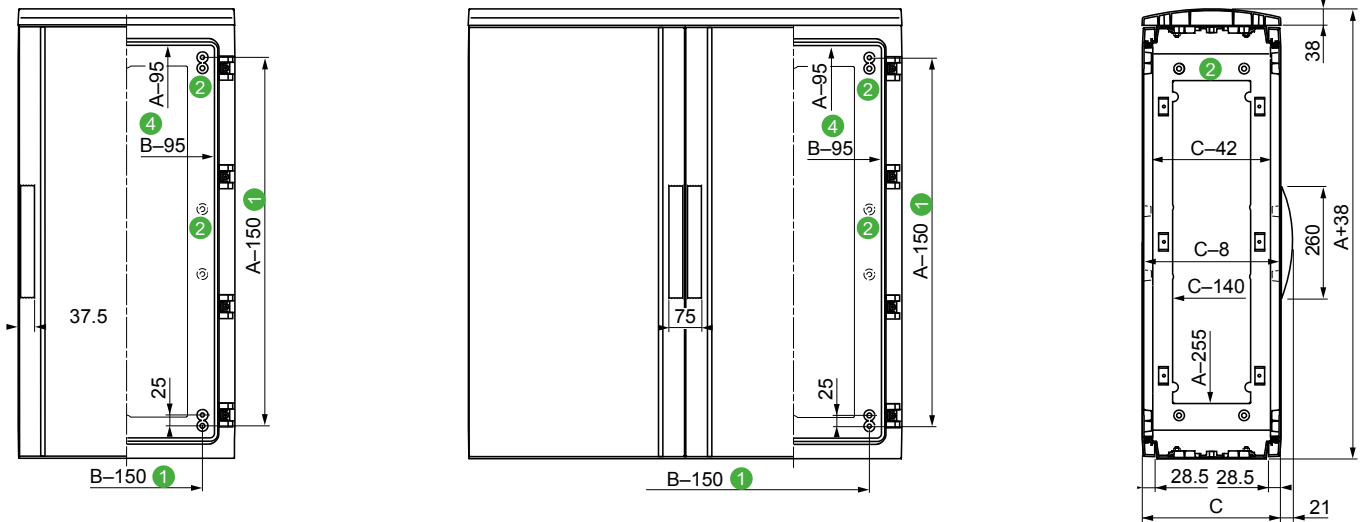

9

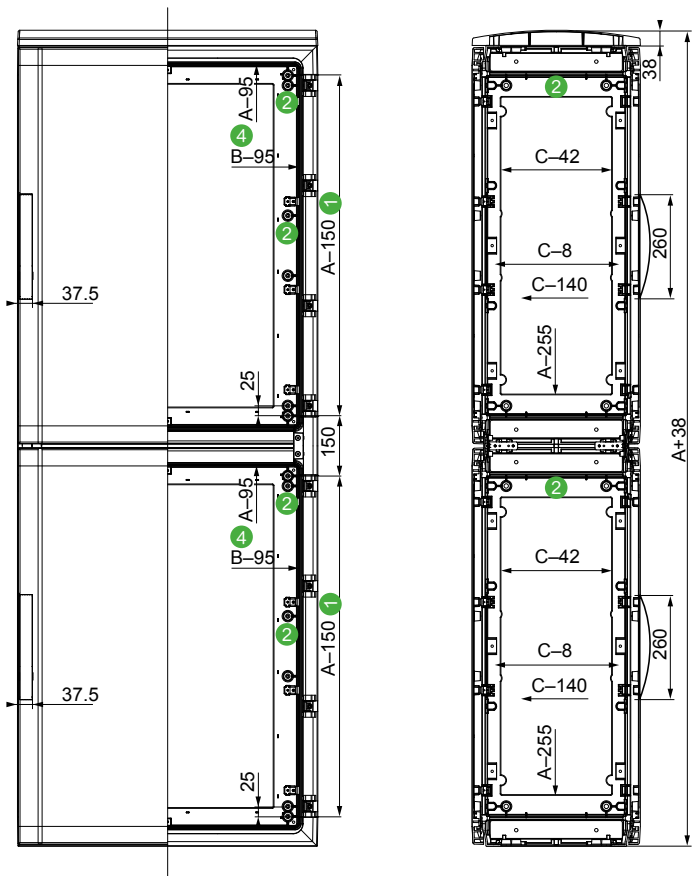

- ① 4 bosses with M8 inserts and studs for direct fixing of mounting plates.
- ② Bosses designed to accommodate M8 inserts, ref. **NSYTEX8**. They are placed:
 - On the back of the enclosure, from the height of 1000 mm. They allow the fixing of partial mounting plates and assorted equipment.
 - On the top and bottom parts of the enclosure. They are used for fixing the step slides, an internal door, 19" chassis, etc.
- ③ Dimensions for fixing on the floor or on a plinth.
- ④ Entry dimensions, door open.
- ⑤ Dimension of 28 mm for enclosures with heights of more than 1000 mm (height after the installation of the plain mounting plates with reinforcement foldings).
- ⑥ With a width of 1250 mm in standard supply, 500 mm door on the left and 750 mm door on the right.

Technical changes reserved. Information provided without guarantee. Images are for illustrative purposes only.

Enclosures with open bottom - plinth type with or without ventilated canopy

For enclosures without canopy, please disregard the corresponding 38 mm



- 1 4 bosses with M8 inserts and studs for direct fixing of mounting plates.
- 2 Bosses designed to accommodate M8 inserts, ref. NSYTEX8. They are placed:
 - On the back of the enclosure, from the height of 1000 mm. They allow the fixing of partial mounting plates and assorted equipment.
 - On the top and bottom parts of the enclosure. They are used for fixing the step slides, an internal door, 19" chassis, etc.
- 3 Dimensions for fixing on the floor or on a plinth.
- 4 Entry dimensions, door open.
- 5 Dimension of 28 mm for enclosures with heights of more than 1000 mm (height after the installation of the plain mounting plates with reinforcement foldings).
- 6 With a width of 1250 mm in standard supply, 500 mm door on the left and 750 mm door on the right.

Connectors between plinths

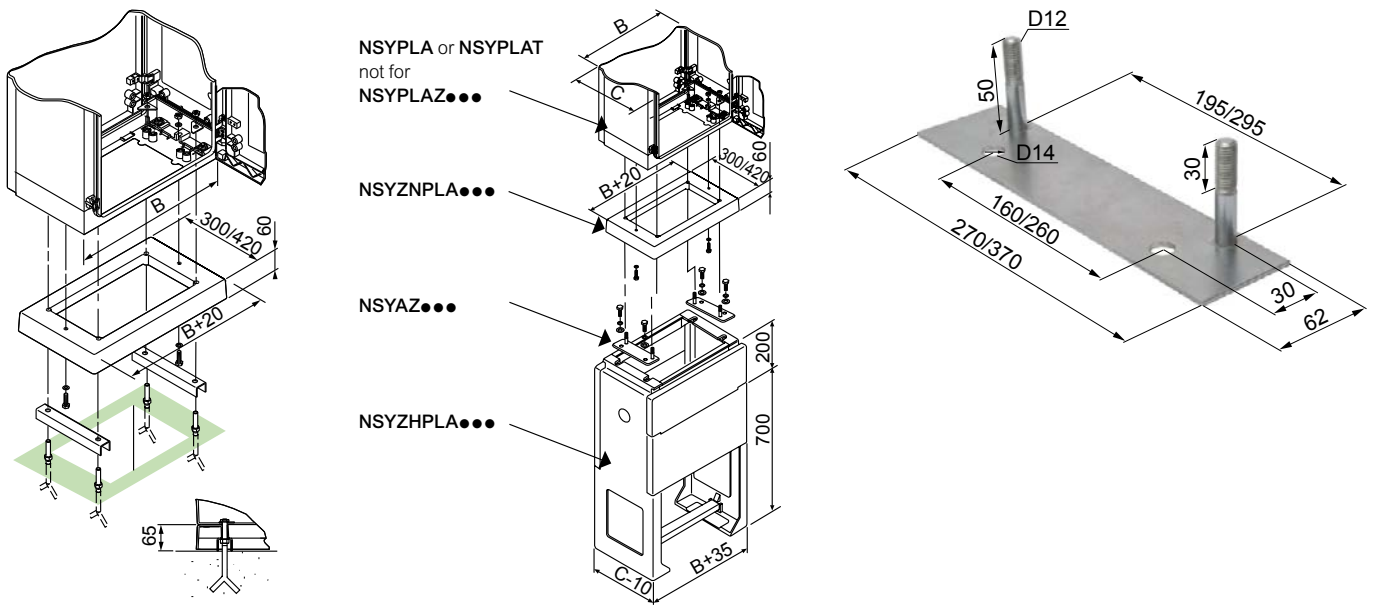

H-plinths for partially burried installation

Floor-standing frame

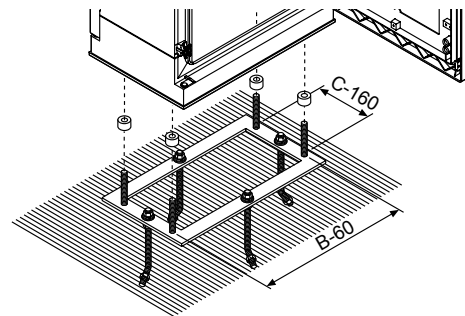
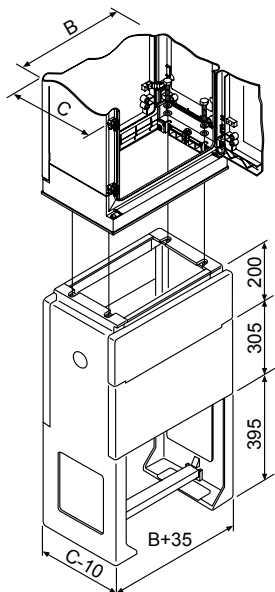

9

Internal door

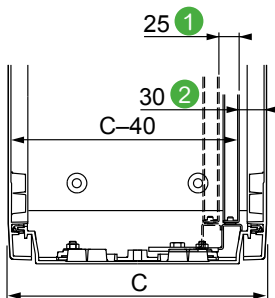

- ① Two positions for depthwise installation
- ② The 2nd position moves the position of the internal door back by 25 mm

Plain mounting plate

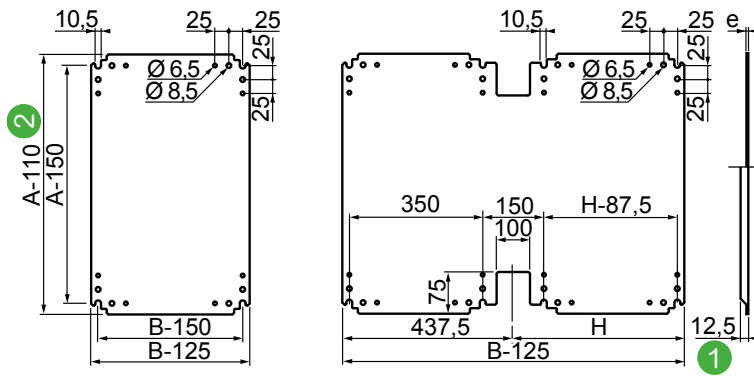

Telequick mounting plate

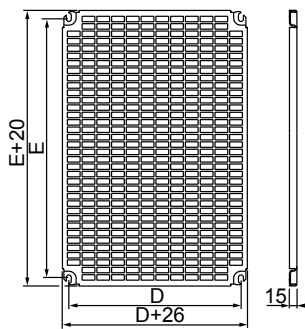

Insulated mounting plate

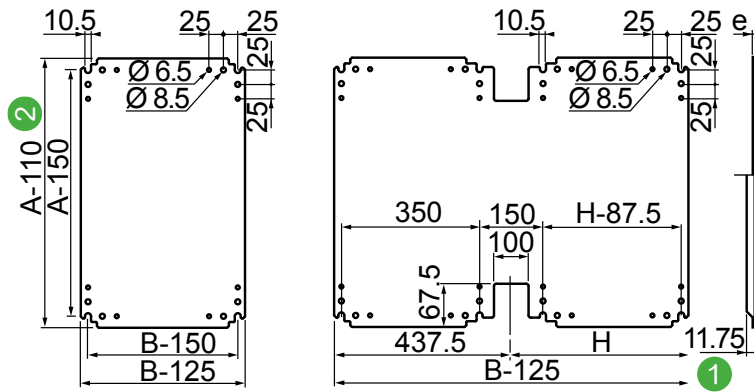

- ① Reinforcing fold for steel mounting plate NSYPMM1010 to NSYPMM1512
- ② A-125 for references NSYPMM1010 to NSYPMM1512, A-120 for the polyester mounting plate, ref. NSYPMA●●●.

Step slides

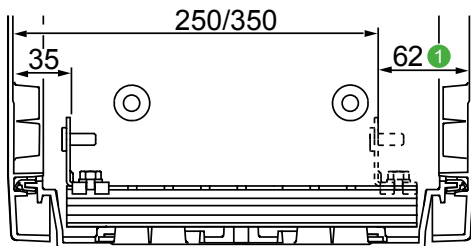

Installation of step slide ref. NSYDPLA●●●,
① 57 mm with one transparent door.

Step slides

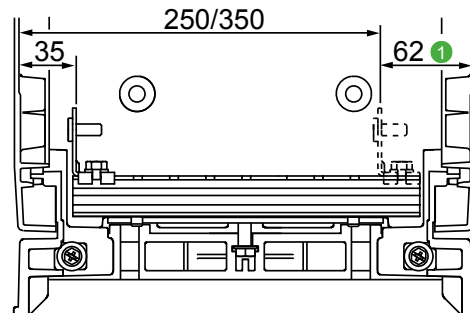

Installation of step slide ref. NSYDPLA●●●, with adapter plate
ref. NSYPTZ●●●, ① 57 mm with one transparent door.

Technical changes reserved. Information provided without guarantee. Images are for illustrative purposes only.

Upright

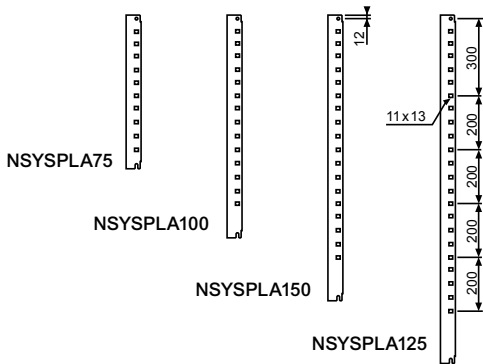

Plate

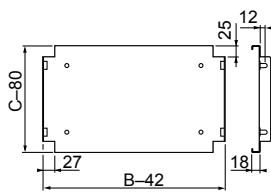

Plain cover plate

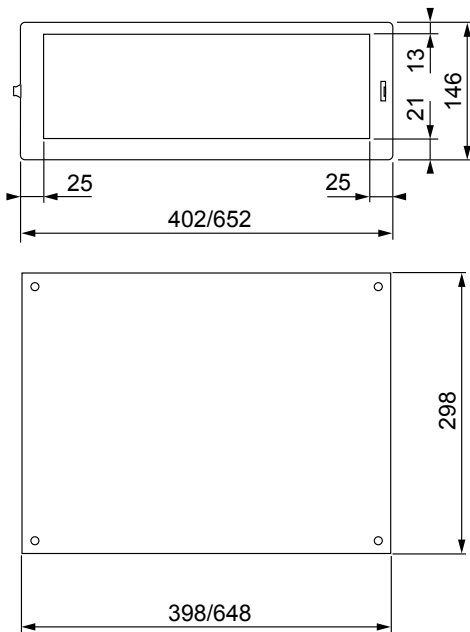

For enclosure	Height	Thickness	References
Width (mm)	A (mm)	(mm)	
500	146	2	NSYCTL500DLPG
500	298	4	NSYCTL500DLP2
750	146	2	NSYCTL750DLPG
750	298	4	NSYCTL750DLP2

Plain mounting plate

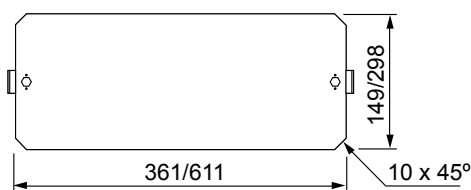

For enclosure	Height	Thickness	References
Width (mm)	A (mm)	(mm)	
500	149	2	NSYPMP500DLP
500	298	2	NSYPMP500DLP2
750	149	2	NSYPMP750DLP
750	298	2	NSYPMP750DLP2

Polyester Floor-Standing Enclosures

19" fixed chassis

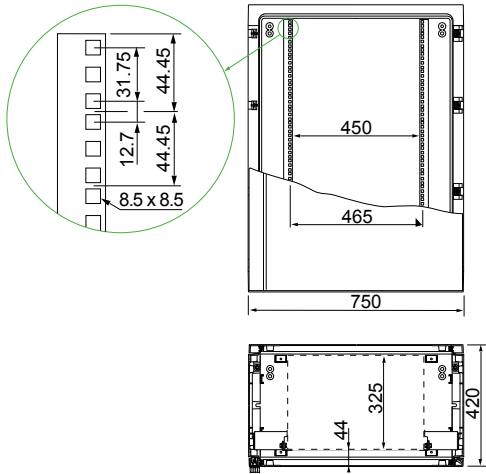

19" swing chassis

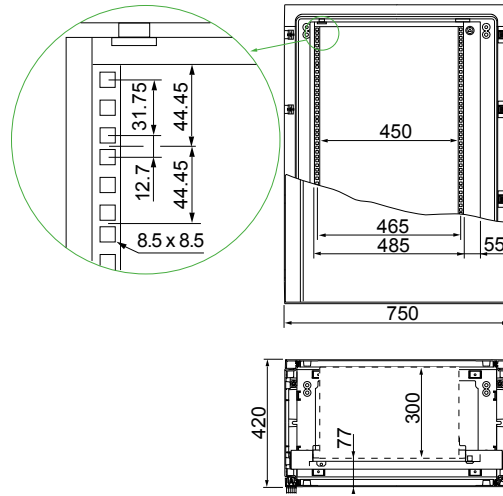

Accessories

Mounting



Cable management

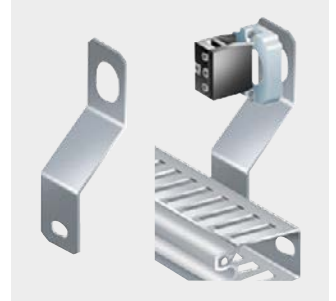

Terminal blocks



Lighting and power sockets



Floor accessories



10

Door accessories



Other accessories



Content

Mounting	260
Cable management	292
Lighting and power sockets	314
Floor accessories	317
Door accessories	318
Other accessories	323
Dimensions	325

Mounting Plates for Wall-Mounted Enclosures

Accessories - Mounting

		S3D		S3X		PLM					
											
Characteristics		Mounting plates, plain		Mounting plates, silkscreened		Mounting plates, microperforated**		Telequick Mounting plate**			
		-		Silkscreened for easier distribution of the products to be installed. Centimetric grid pattern.		They considerably reduce products installation time thanks to the holes prepared to receive the self-tapping screws. Holes with Ø 3.6 mm in steps of 12.5 mm.		They allow cable guides and ducting and other installation accessories to be clipped on, making it easier to install switchgear. 11 x 26 mm slots. Switchgear fixing by clip-on nuts.			
Material		Galvanized steel		Galvanized steel		Galvanized steel		Zinc-coated steel			
Maximum load		PLM: 150 kg/m ² S3D, S3X, CRN, CRNG: 250 kg/m ²						PLM: 150 kg/m ² S3D, S3X, CRN: 250 kg/m ²			
Supply		One mounting plate without fixing elements						One mounting plate without fixing elements			
For enclosures (mm)		Dimensions (mm)		References		References		No. of perforations in		References	
Height	Width	H	W	References	References	References	H	W	References	References	
200	200	150	150	NSYMM22	-	-	-	-	-	-	
200	300	150	250	NSYMM23	-	-	-	-	-	-	
250	200	200	150	NSYMM2520	-	-	-	-	-	-	
250	300	250	200	NSYMM3025	-	-	-	-	-	-	
250	400	200	350	NSYMM2540	-	-	-	-	-	-	
250	500	200	450	NSYMM2550	-	-	-	-	-	-	
300	200	250	150	NSYMM32	-	NSYMF32	16	5	NSYMR32		
300	250	250	200	NSYMM3025*	-	-	16	8	NSYMR3025		
300	300	250	250	NSYMM33	-	NSYMF33	16	9	NSYMR33		
300	400	250	350	NSYMM43*	NSYMS43*	NSYMF43*	18	11	NSYMR34		
300	450	250	400	NSYMM3045	-	-	-	-	-	-	
300	500	450	250	NSYMM53*	-	-	-	-	-	-	
300	600	250	550	NSYMM36	-	-	-	-	-	-	
400	300	230	350	NSYMM43*	NSYMS43	NSYMF43	22	9	NSYMR43		
400	400	350	350	NSYMM44	NSYMS44	NSYMF44	24	11	NSYMR44		
400	600	350	550	NSYMM64*	NSYMS64*	-	24	19	NSYMR46		
400	800	350	750	NSYMM48	-	-	-	-	-	-	
500	300	450	250	NSYMM53*	NSYMS53*	NSYMF53	29	9	NSYMR53		
500	400	450	350	NSYMM54	NSYMS54	NSYMF54	31	11	NSYMR54		
500	500	450	450	NSYMM55*	NSYMS55*	NSYMF55	31	14	NSYMR55		
500	600	550	450	NSYMM65	-	-	-	-	-	-	
600	400	550	350	NSYMM64	NSYMS64	NSYMF64*	38	11	NSYMR64		
600	500	550	450	NSYMM65	-	NSYMF65	38	14	NSYMR65		
600	600	550	550	NSYMM66	NSYMS66	NSYMF66	38	17	NSYMR66		
600	800	-	-	-	-	-	36	24	NSYMR68		
700	500	650	450	NSYMM75	NSYMS75	NSYMF75	44	14	NSYMR75		
700	600	650	550	NSYMM76	-	-	44	17	NSYMR76		
800	600	750	550	NSYMM86*	NSYMS86*	NSYMF86*	51	17	NSYMR86		
800	800	750	750	NSYMM88	-	NSYMF88	51	24	NSYMR88		
800	1000	-	-	NSYMM108	-	NSYMF108	49	31	NSYMR810		
800	1200	-	-	NSYMM128	-	NSYMF128	-	-	2 x NSYMR86		
1000	600	950	550	NSYMM106	-	NSYMF106	64	17	NSYMR106		
1000	800	950	750	NSYMM108*	-	NSYMF108*	64	24	NSYMR108		
1000	1000	950	950	NSYMM1010	-	NSYMF1010	62	31	NSYMR1010		
1000	1200	-	-	-	-	-	62	37	NSYMR1012		
1200	600	1150	550	NSYMM126	-	NSYMF126	75	17	NSYMR126		
1200	800	1150	750	NSYMM128*	-	NSYMF128	75	24	NSYMR128		
1200	1000	1150	950	NSYMM1210*	-	NSYMF1210*	75	31	NSYMR1210		
1200	1200	1150	1150	NSYMM1212	-	2 x NSYMF126	-	-	2 x NSYMR126		
1400	1000	1350	950	NSYMM1410	-	-	88	31	NSYMR1410		

10

* Plate with reversible dimensions; It can be installed in enclosures with inverted dimensions. Example: Plate ref. **NSYMM64** can be used for the following enclosures: H 600 x W 400 mm or H 400 x W 600 mm. For plain and silkscreened mounting plates: In wall-mounted enclosures with widths of 1000 and 1200 mm, it is possible to install two mounting plates at different depths using an additional central step slide **NSYSDRSDCR***** (more information on [page 263](#)).

** To install two mounting plates in a single enclosure, also order reference **NSYCRNGSDR**. See details on [page 263](#).
To install the plate in an enclosure with six studs, also order reference **NSYEMR**.

- S3D
- S3X
- PLM

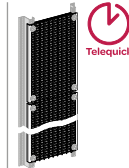

Characteristics	Bakelite mounting plate**	Polyester mounting plate**	DIN rail chassis	Joinable Telequick mounting plate
	<ul style="list-style-type: none"> They are coupled directly to the rear of the actual enclosure or to the sliding plate supports. Double-door enclosures offer the option of installing two plates. 		Components supplied with a DIN rail chassis: <ul style="list-style-type: none"> Aluminum uprights. DIN rails (symmetric section A or B, according to the reference). Screws, washers and nuts need to mount the DIN rails to the uprights. Set of four adapters, ref. NSYAMCSF, needed to fix the uprights to the enclosure. 	<ul style="list-style-type: none"> 20/10e mm Telequick mounting plates. These mounting plates are suitable for mounting vertically multiple plates. 11 x 26 mm slots. Switchgear fixing by clip-on nuts.

Material	Bakelite	Polyester reinforced with fiberglass	Aluminum or zinc-coated steel	Zinc-coated steel
Color	RAL 9005 black	RAL 7035 grey	-	-
Maximum load	100 kg/m ²	150 kg/m ²	-	-
Supply	One mounting plate without fixing elements		One DIN rail chassis	One mounting plate and fixing elements

For enclosures (mm)		Dimensions (mm)				Dimensions (mm)				Type of rails	No. of rails	References	Dimensions (mm)		
Height	Width	H (P)	W (S)	Thick.	References	H (P)	W (S)	Thick.	References			References	H	W	References
60	700	-	-	-	-	-	-	-	-	-	-	-	120	734	AM1PA0670
120	700	-	-	-	-	-	-	-	-	-	-	-	180	734	AM1PA1270
300	150	-	-	-	-	-	-	-	-	-	-	-	349	228	AM1PA3015
300	195	-	-	-	-	-	-	-	-	-	-	-	349	258	AM1PA3020
300	200	265	150	4	NSYMB32	265	150	4	NSYMPP32	-	-	-	-	-	-
300	250	265	200	4	NSYMB3025	265	200	4	NSYMPP3025	-	-	-	-	-	-
300	300	265	250	4	NSYMB33	-	-	-	-	B	4	NSYMD33	-	-	-
300	500	-	-	-	-	-	-	-	-	-	-	-	360	534	AM1PA3050
300	700	-	-	-	-	-	-	-	-	-	-	-	360	734	AM1PA3070
400	300	325	250	4	NSYMB43	325	250	4	NSYMPP43	B	4	NSYMD43	-	-	-
405	300	-	-	-	-	-	-	-	-	-	-	-	465	334	AM1PA4030
500	400	465	350	4	NSYMB54	465	350	4	NSYMPP54	B	4	NSYMD54	-	-	-
600	400	565	350	4	NSYMB64	565	350	4	NSYMPP64	B	6	NSYMD64	660	434	AM1PA6040
600	500	565	450	4	NSYMB65	-	-	-	-	-	-	-	660	534	AM1PA6050
600	600	-	-	-	-	-	-	-	-	A	6	NSYMD66	660	634	AM1PA6060
600	700	-	-	-	-	-	-	-	-	-	-	-	660	734	AM1PA6070
700	500	665	450	4	NSYMB75	665	450	4	NSYMPP75	B	6	NSYMD75	-	-	-
705	500	-	-	-	-	-	-	-	-	-	-	-	765	534	AM1PA7050
795	600	-	-	-	-	-	-	-	-	-	-	-	855	634	AM1PA8060
800	600	765	550	4	NSYMB86	765	550	5	NSYMPP86	A	6	NSYMD86	-	-	-
800	1000	-	-	-	NSYMB108	-	-	-	-	-	-	-	-	-	-
800	1200	-	-	-	2 x NSYMB86	-	-	-	-	-	-	2 x NSYMD86	-	-	-
900	500	-	-	-	-	-	-	-	-	-	-	-	960	534	AM1PA9050
900	600	-	-	-	-	-	-	-	-	-	-	-	960	634	AM1PA9060
900	700	-	-	-	-	-	-	-	-	-	-	-	960	734	AM1PA9070
1000	600	965	550	4	NSYMB106	-	-	-	-	-	-	-	-	-	-
1000	800	965	750	4	NSYMB108	965	750	5	NSYMPP108	A	6	NSYMD108	-	-	-
1200	800	-	-	-	-	-	-	-	-	A	7	NSYMD128	-	-	-
1200	1000	1150	950	4	NSYMB1210	-	-	-	-	-	-	-	-	-	-

* Plate with reversible dimensions; It can be installed in enclosures with inverted dimensions. Example: Plate ref. **NSYMM64** can be used for the following enclosures: H 600 x W 400 mm or H 400 x W 600 mm. For plain and silkscreened mounting plates: In wall-mounted enclosures with widths of 1000 and 1200 mm, it is possible to install two mounting plates at different depths using an additional central step slide **NSYSDRSDCR**** (more information on [page 263](#)).

** To install two mounting plates in a single enclosure, also order reference **NSYCRNGSDR**. See details on [page 263](#).
To install the plate in an enclosure with six studs, also order reference **NSYEMR**.

S3D S3X PLM Elevator for microperforated mounting plate



AZ1CA04

- Mounting plate elevator to mount the microperforated mounting plate on the same level as the other Telequick system components.

Supply:
Four units

Characteristics	Reference
Elevator for microperforated mounting plate	AZ1CA04

Clip-on nuts for Telequick mounting plate



AF1EA3

- Used to easily fix devices on the Telequick mounting plate with the option of converting the layout as much as needed.

Supply:
100 units. Reference by unit. Order by multiples of 100 (100, 200, 300...)

Characteristics	Reference
Clip-on nuts for Telequick mounting plate, Model M3	AF1EA3
Clip-on nuts for Telequick mounting plate, Model M4	AF1EA4
Clip-on nuts for Telequick mounting plate, Model M5	AF1EA5
Clip-on nuts for Telequick mounting plate, Model M6	AF1EA6

S3D S3X Step slides for mounting plate



NSYSDCR200

- Set of four supports intended for installation in enclosures with depths of 200, 250, 300 and 400 mm.
- The rail allows the depth of the plate and other accessories to be adjusted in steps of 12.5 mm.

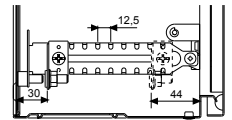

Supply:
Four step slides

Characteristics	Enclosure depth (mm)	Reference
Step slides for mounting plate	200	NSYSDCR200
Step slides for mounting plate	250	NSYSDCR250

S3D S3X Slide bracket for two mounting plates at different depths



NSYCRNGSDR

- Additional slide bracket to be installed on the central step slides in order to mount two mounting plates, side by side, in different depths.

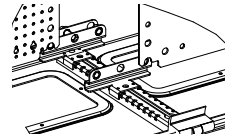

Supply:
Two slide brackets

Characteristics	Reference
Slide bracket for two mounting plates at different depths	NSYCRNGSDR

S3D S3X PLM PLA Aluminum vertical rails

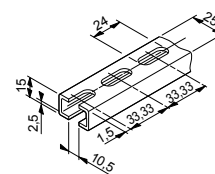

- Fixing in the enclosure with M8 nuts, ref. **NSYAMCSF** (set of 4 adapters to be ordered separately).



NSYMDVR3

Characteristics	Height (mm)	Supply (units)	References
Aluminum vertical rail, aluminum	300	10	NSYMDVR3
Aluminum vertical rail, aluminum	400	10	NSYMDVR4
Aluminum vertical rail, aluminum	500	10	NSYMDVR5
Aluminum vertical rail, aluminum	600	10	NSYMDVR6
Aluminum vertical rail, aluminum	700	10	NSYMDVR7
Aluminum vertical rail, aluminum	800	10	NSYMDVR8
Aluminum vertical rail, aluminum	1000	10	NSYMDVR10
Aluminum vertical rail, steel	1200	2	NSYMDVR12
Aluminum vertical rail, aluminum	3000	10	NSYMDVR3M

S3D S3X PLM 20/10° mm zinc-coated pre-drilled uprights



DZ6MZ121

- Ø 11 mm holes enable to adjust the rows of equipment by 20 mm steps.

Comment:
Details, see [page 326](#)

Characteristics	Height (mm)	Weight (g)	References
20/10e mm zinc-coated pre-drilled uprights	1020	2330	DZ6MZ121
20/10e mm zinc-coated pre-drilled uprights	1320	2920	DZ6MZ151
20/10e mm zinc-coated pre-drilled uprights	1620	3375	DZ6MZ181
20/10e mm zinc-coated pre-drilled uprights	1920	4000	DZ6MZ211

Sliding Nuts



NSYNM5

- Sliding nuts to be used on aluminum vertical rails.

Supply:
100 Sliding nuts

Characteristics	Type	References
Sliding Nut	M4	NSYNM4
Sliding Nut	M5	NSYNM5
Sliding Nut	M6	NSYNM6

Brass nuts to fix the upright to the enclosures



NSYAMCSF

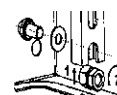

Supply:
Four Brass nuts

Characteristics	References
Brass nuts for screws M8 to fix the upright to the enclosures	NSYAMCSF

Slides and brackets



NSYSB90



NSYFB

- They allow the depth of the plates and rails to be adjusted.



Supply:
10 units. References per unit. To be ordered in multiples of 10 (10, 20, 30, etc.).

Characteristics	Width (mm)	Enclosure depth (mm)	References
Slide with bracket	90	150 and 200	NSYSB90
Slide with bracket	130	250 and 300	NSYSB130
Bracket for slides (customized mounting plate)			NSYFB

Notched clamp nuts

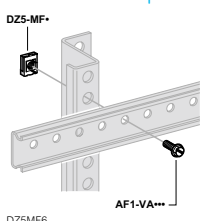

DZ5MF6

- Specially designed for pre-drilled uprights.

Supply:
100 units. References per unit. To be ordered in multiples of 100 (100, 200, 300, etc.).

Characteristics	Type	Weight (g)	References
Notched clamp nuts	M6	7.0	DZ5MF6
Notched clamp nuts	M8	8.0	DZ5MF8

SM SMX SF SFX Plain mounting plate

- Depth adjustable with a pitch of 25 mm, provided with plastic shoe for easier sliding.
- Once the plate is fixed, in advanced position, the sliding shoe can be easily removed to increase the available plate surface.
- In sets made up of two or more enclosures with mounting plates, it is possible to obtain a continuous plate surface using intermediate mounting plates (see [page 267](#)).
- Load: 300 kg/ m²
- Maximum load: 600 kg in the back of the enclosure and 500 kg in the intermediate position
- Material: Galvanized steel

Fixing options:

- At the sides of the enclosure with the orthogonal brackets (see [page 267](#))
- Back-to-back, with the brackets for fixing the mounting plates in back-to-back position (see [page 267](#))
- For 400 mm wide plates: with sliding rails and brackets, orthogonal brackets when mounted at back position, or with standard fixing brackets when mounted at middle position.

Note:

Accessories must be purchased separately (depending on the fixation at the back or in the mid position)

NSYSMPS rails always needed

NSYSMPB brackets for intermediate position

NSYSMPS B brackets for back position

Supply:

One mounting plate and sliding shoes



NSYMP184

Characteristics	Width (mm)	Height (mm)	References
Plain mounting plate	400	1800	NSYMP184 New
Plain mounting plate	400	2000	NSYMP204 New
Plain mounting plate	400	2200	NSYMP224 New
Plain mounting plate	600	1200	NSYMP126
Plain mounting plate	600	1400	NSYMP146
Plain mounting plate	600	1600	NSYMP166
Plain mounting plate	600	1800	NSYMP186
Plain mounting plate	600	2000	NSYMP206
Plain mounting plate	600	2200	NSYMP226
Plain mounting plate	800	1200	NSYMP128
Plain mounting plate	800	1400	NSYMP148
Plain mounting plate	800	1600	NSYMP168
Plain mounting plate	800	1800	NSYMP188
Plain mounting plate	800	2000	NSYMP208
Plain mounting plate	800	2200	NSYMP228
Plain mounting plate	1000	1200	NSYMP1210
Plain mounting plate	1000	1400	NSYMP1410
Plain mounting plate	1000	1600	NSYMP1610
Plain mounting plate	1000	1800	NSYMP1810
Plain mounting plate	1000	2000	NSYMP2010
Plain mounting plate	1000	2200	NSYMP2210
Plain mounting plate	1200	1200	NSYMP1212
Plain mounting plate	1200	1400	NSYMP1412
Plain mounting plate	1200	1600	NSYMP1612
Plain mounting plate	1200	1800	NSYMP1812
Plain mounting plate	1200	2000	NSYMP2012
Plain mounting plate	1200	2200	NSYMP2212
Plain mounting plate	1600	1800	NSYMP1816
Plain mounting plate	1600	2000	NSYMP2016

SM SMX SF SFX SD SDX Perforated mounting plate Telequick



- Allows the installation of switchgear without drilling or screwing.
- Plate designed for quick-fixing of switchgear by means of clip-on nuts ref. **AF1EA3** to **AF1EA6**.
- Vertical continuity is reinforced by the vertical installation of plates.
- The top plate must be fixed in the third hole, 80 mm from the top frame.
- Load: 150 kg/m²
- Material: Zinc-coated steel

Fixing options:

- Directly to the vertical uprights of the structure, by means of self-tapping screws (only Spacial SF)
- To the technical vertical uprights, by means of sliding nuts, see [page 271](#);
- To standard uprights by means of flat nuts, see [page 271](#) or self-tapping screws, and to cross-rails

Comment:

Examples of combination see [page 327](#)

Supply:

One perforated mounting plate and fixing elements for technical uprights and screws for fixing to the structure or cross-rails



NSYSTMP4560

Characteristics	Width (mm)	Plate height (mm)				Useful surface (dm ²)	References
		D	E	F	G		
Perforated mounting plate Telequick	600	450	200	-	100	11.4	NSYSTMP2260
Perforated mounting plate Telequick	600	450	425	-	325	22.8	NSYSTMP4560
Perforated mounting plate Telequick	600	450	575	125	475	30.4	NSYSTMP6060
Perforated mounting plate Telequick	600	450	800	250	700	11.9	NSYSTMP8260
Perforated mounting plate Telequick	800	650	200	-	100	15.9	NSYSTMP2280
Perforated mounting plate Telequick	800	650	425	-	325	31.8	NSYSTMP4580
Perforated mounting plate Telequick	800	650	575	125	475	42.4	NSYSTMP6080
Perforated mounting plate Telequick	800	650	800	250	700	58.4	NSYSTMP8280
Perforated mounting plate Telequick	1000	850	200	-	100	20.4	NSYSTMP22100
Perforated mounting plate Telequick	1000	850	425	-	325	40.8	NSYSTMP45100
Perforated mounting plate Telequick	1000	850	575	125	475	54.4	NSYSTMP60100
Perforated mounting plate Telequick	1000	850	800	250	700	74.9	NSYSTMP82100
Perforated mounting plate Telequick	1200	1050	200	-	100	24.9	NSYSTMP22120
Perforated mounting plate Telequick	1200	1050	425	-	325	49.9	NSYSTMP45120
Perforated mounting plate Telequick	1200	1050	575	125	475	66.5	NSYSTMP60120
Perforated mounting plate Telequick	1200	1050	800	250	700	91.5	NSYSTMP82120

SM SF SFX Partial mounting plate

- Partial mounting plate, provided with reinforcement flange on its four sides.
- Load: 250 kg/m²
- Material: Galvanized steel

Fixing options:

Spacial SF, SFX:

- Fixing to the vertical uprights of the structure
- Fixing to the technical or standard vertical uprights, see [page 271](#)
- For installations in advanced position, fixing to cross-rails, see [page 274](#)

Spacial SM:

- Fixing by means of adaptation profiles and 40 mm universal cross-rails (one row) in vertical position, or also on horizontal universal cross-rails
- It can be mounted horizontally, as a tray, by means of depthwise cross-rails, see [page 274](#)

Supply:

Partial mounting plate and fixing elements



NSYSPMP2560

Characteristics	Width (mm)	Plate height (mm)	Plate length (mm)	References
	B	H	B-100	
Partial mounting plate	600	247	500	NSYSPMP2560
Partial mounting plate	600	247	750	NSYSPMP2575
Partial mounting plate	600	397	500	NSYSPMP4060
Partial mounting plate	600	597	500	NSYSPMP6060
Partial mounting plate	800	247	700	NSYSPMP2580
Partial mounting plate	800	397	700	NSYSPMP4080
Partial mounting plate	800	597	700	NSYSPMP6080
Partial mounting plate	1000	247	900	NSYSPMP25100
Partial mounting plate	1000	397	900	NSYSPMP40100
Partial mounting plate	1000	597	900	NSYSPMP60100
Partial mounting plate	1200	247	1100	NSYSPMP25120
Partial mounting plate	1200	397	1100	NSYSPMP40120
Partial mounting plate	1200	597	1100	NSYSPMP60120
Partial mounting plate	1600	397	1100	NSYSPMP40160

SF SFX Intermediate mounting plate



- Obtains a continuous surface of the mounting plate at enclosure suites.
- Adjustable depth with a pitch of 25 mm. When the mounting plates are located in the back of the enclosure, the vertical profiles of the structure are flush with the plates, acting as an intermediate mounting plate. In this case the intermediate plate cannot be installed.
- Material: Galvanized steel

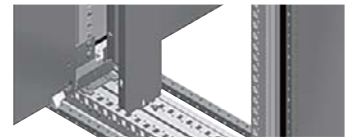

Supply:
One intermediate plate and fixing elements

Characteristics	Height (mm)	References
Intermediate mounting plate	1200	NSYSIMP12
Intermediate mounting plate	1400	NSYSIMP14
Intermediate mounting plate	1600	NSYSIMP16
Intermediate mounting plate	1800	NSYSIMP18
Intermediate mounting plate	2000	NSYSIMP20
Intermediate mounting plate	2200	NSYSIMP22

SF SFX Intermediate fixing of the mounting plate, located in the back of the enclosure

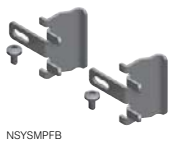

- Support for additional fixing of the mounting plate, at any height of the plate when the plate is mounted in the back of the enclosure.
- The supports minimize the vibration of the plate during the transport and operation of the panel.
- Material: Zinc-coated steel
- **Fixing:** The supports are fixed to the structure when the plate is already located in the back of the enclosure
Spacial SM: Fixing to 40 mm universal cross-rails (one row), installed vertically in the back of the enclosure, see [page 274](#)

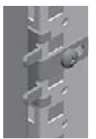

Supply:
Ten units and fixing elements.
Reference by unit. Order by multiples of 10 (10, 20, 30...)

Characteristics	References
Intermediate fixing of the mounting plate, located in the back of the enclosure	NSYSMPFB

SF SFX Intermediate fixing of the mounting plate, in advanced position



- Support for additional fixing of the mounting plate, at any height of the plate when the plate is mounted in advanced position.
- The supports minimize the vibration of the plate during the transport and operation of the panel.
- Material: Zinc-coated steel
- **Fixing:** The supports are mounted on light cross-rails or on 40 mm (one row) universal or quick-fixing cross-rails (not supplied), see [page 274](#)



Supply:
Ten units and fixing elements.
Reference by unit. Order by multiples of 10 (10, 20, 30...)

Characteristics	References
Intermediate fixing of the mounting plate, in advanced position	NSYSMPFA

SF SFX Reinforcement for mounting plate



- Reinforcement kit for transversal mounting plate.
- Provides extra rigidity to the mounting plates and absorbs vibrations.
- Can be used as a support for fixing very heavy elements.
- Material: Zinc-coated steel
- Thickness: 15/10^e mm

Supply:
Two profiles, four supports for fixing to the mounting plate and fixing elements

Characteristics	Width (mm)	References
Reinforcement for mounting plate	800	NSYMPRK8
Reinforcement for mounting plate	1000	NSYMPRK10
Reinforcement for mounting plate	1200	NSYMPRK12
Reinforcement for mounting plate	1600	NSYMPRK16

Mounting plate accessories

Self-tapping screw



- Hexagonal head, 4.8 x 16 mm thread.
- Drilling capacity: Thicknesses between 17.5/10^e and 40/10^e mm.

Supply:
100 units. To be ordered in multiples of 100 (100, 200, 300, etc.).

Characteristics	References
Self-tapping screw	NSYS16M5HS

Mounting Plate Brackets for Floor-Standing Enclosures

SM SMX SF SFX Mounting plate fixing brackets



NSYSFPB

- For direct mounting on the structure of the enclosure.
- Adjustable depth with a pitch of 25 mm.
- Material: Zinc-coated steel
- Maximum load: Four brackets: 600 kg

Characteristics	References
Spacial SF Mounting plate fixing brackets	NSYSFPB
Spacial SM/SMX/SFX Mounting plate fixing brackets	NSYSMPB

Supply:
Four brackets and fixing elements

SF SFX Orthogonal brackets



NSYSMPB

- Designed for the installation of mounting plates on the sides of the enclosure.
- When installing one plate in the back of the enclosure and one plate at the side, they must both be installed using orthogonal brackets.
- Spacial SFX: Mounting the lateral mounting plate requires the removal of the one on the back and its fixing brackets.
- Material: Zinc-coated steel
- Maximum load: Four brackets: 600 kg

Characteristics	References
Spacial SF/SFX Orthogonal brackets	NSYSMPB

Supply:
Four brackets and fixing elements

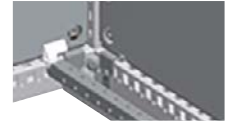

SF Mounting plate sliding rails



NSYSMPS4

- Rail in which the mounting plate slides along when inserted in the enclosure.
- Once the mounting plate is installed and fixed to the brackets, the sliding rails can be removed to maximize the cable passage surface, and can be installed depthwise in other positions.
- Material: Zinc-coated steel

Characteristics	Depth (mm)	References
Spacial SF Mounting plate sliding rails	400	NSYSMPS4
Spacial SF Mounting plate sliding rails	500	NSYSMPS5
Spacial SF Mounting plate sliding rails	600	NSYSMPS6
Spacial SF Mounting plate sliding rails	800	NSYSMPS8

Supply:
Four brackets and fixing elements



Brackets for fixing mounting plates in back-to-back position



NSYSBTB

- Doubling the mounting surface.
- Adjustable with a pitch of 25 mm.
- Material: Zinc-coated steel

Characteristics	References
Brackets for fixing mounting plates in back-to-back position	NSYSBTB

Supply:
Four brackets for fixing back-to-back and fixing elements

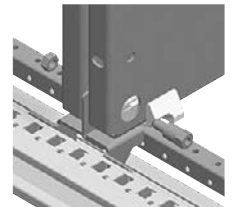
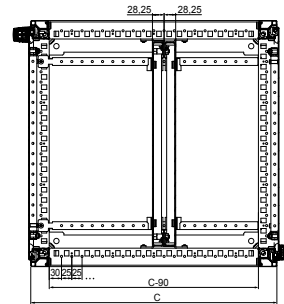

SM SMX SF SFX Brackets for fixing intermediate mounting plates in back-to-back position



NSYSIBTB

- Doubling the mounting surface.
- Adjustable with a pitch of 25 mm.
- Material: Zinc-coated steel

Characteristics	References
Spacial SM/SMX/SF/SDX Brackets for fixing intermediate mounting plates in back-to-back position	NSYSIBTB

Supply:
2 brackets for fixing intermediate plates back-to-back and fixing elements

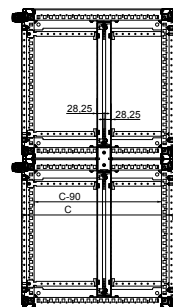

SF **SFX** Side entry rails for the mounting plate

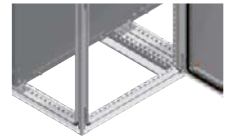

- Side entry device for the mounting plates when coupling Spacial SF enclosures or Spacial SFX.
- The mounting plates can be coupled with one another, and are fixed to the side entry guide by pressure.
- Material: Zinc-coated steel

Supply:
Two rails (top and bottom)
and fixing elements

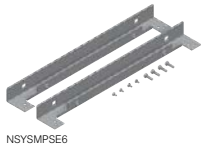

Characteristics	Width (mm)	References
Spacial SF/SFX Side entry rails for the mounting plate	600	NSYSMPSE6
Spacial SF/SFX Side entry rails for the mounting plate	800	NSYSMPSE8
Spacial SF/SFX Side entry rails for the mounting plate	1000	NSYSMPSE10
Spacial SF/SFX Side entry rails for the mounting plate	1200	NSYSMPSE12

SM Top/bottom adjustment rails

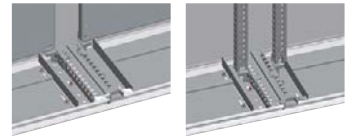

- Allows the installation of two mounting plates or vertical uprights in enclosures with a width of 1200 mm and 1600 mm, as if in two independent enclosures.
- A set of mounting plate fixing brackets ref. **NSYSMPB** is required.
- Optional installation of an intermediate mounting plate.
- Material: Galvanized steel

Comment:
Examples of combination see [page 328](#)

Supply:
Two rails, top and bottom



NSYSTBR3

Characteristics	Depth (mm)	References
Spacial SM Top/bottom adjustment rails	300	NSYSTBR3
Spacial SM Top/bottom adjustment rails	400	NSYSTBR4
Spacial SM Top/bottom adjustment rails	500	NSYSTBR5
Spacial SM Top/bottom adjustment rails	600	NSYSTBR6

SF Kit for adapting two-door enclosures

- Allows the installation of two mounting plates as if in two independent enclosures.
- A set of brackets for fixing mounting plates ref. **NSYSMPB** is required.
- Option of installing an intermediate mounting plate.
- Valid for enclosures with widths of 1200 and 1600 mm.
- If installing a cable gland plate for a width of 1200 mm, it is necessary to install two with a width of 600 mm, and for widths of 1600 mm, two with a width of 800 mm.

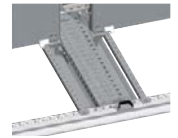

Comment:
Examples of combination see [page 328](#)



NSYSMP2D4

Characteristics	Depth (mm)	References
Spacial SF Kit for adapting two-door enclosures	400	NSYSMP2D4
Spacial SF Kit for adapting two-door enclosures	500	NSYSMP2D5
Spacial SF Kit for adapting two-door enclosures	600	NSYSMP2D6
Spacial SF Kit for adapting two-door enclosures	800	NSYSMP2D8

SM SMX SF SFX Technical uprights
SD SDX PLA PHD

- Vertical uprights for fixing plates and rails.
- They can be fixed to the fixing brackets of the mounting plate or to the uprightfixing bracket (ref. **NSYMFB**).
- Adjustable height in steps of 2.5 mm (with quarter-turn nuts, ref. **NSYSNM6** or **NSYSNM8**) or 25 mm (with cage nuts, ref. **NSYCNM6** or **NSYCNM8**).
- Material: Galvanized steel
- Thickness: 20/10^e mm

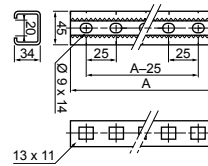

Comment:
NSYTVR20 is not compatible with PLA or PHD 2000 mm high enclosures. Use 2 x **NSYTVR10**.

Supply:
Set of two uprights



Characteristics	Height (mm)	A (mm)	References
SM/SMX/SF/SFX/SD/SDX/PLA/PHD Technical uprights	750	625	NSYTVR7
SM/SMX/SF/SFX/SD/SDX/PLA/PHD Technical uprights * Control desk.	1000*	675	NSYTVR8
SM/SMX/SF/SFX/SD/SDX/PLA/PHD Technical uprights	1000	875	NSYTVR10
SM/SMX/SF/SFX/SD/SDX/PLA/PHD Technical uprights	1200	1075	NSYTVR12
SM/SMX/SF/SFX/SD/SDX/PLA/PHD Technical uprights	1250	1125	NSYTVR125
SM/SMX/SF/SFX/SD/SDX/PLA/PHD Technical uprights	1400	1275	NSYTVR14
SM/SMX/SF/SFX/SD/SDX/PLA/PHD Technical uprights	1500	1375	NSYTVR15
SM/SMX/SF/SFX/SD/SDX/PLA/PHD Technical uprights	1600	1475	NSYTVR16
SM/SMX/SF/SFX/SD/SDX/PLA/PHD Technical uprights	1800	1675	NSYTVR18
SM/SMX/SF/SFX/SD/SDX Technical uprights	2000	1875	NSYTVR20
SM/SMX/SF/SFX/SD/SDX/PLA/PHD Technical uprights	2200	2075	NSYTVR22

SM SMX SF SFX Standard uprights

- Vertical uprights for fixing plates and rails.
- They can be fixed on the mounting plate fixing brackets or on the upright fixing bracket, ref. **NSYMFB**.
- Adjustable height with a pitch of 25 or 50 mm.
- Material: Galvanized steel
- Thickness: 20/10^e mm

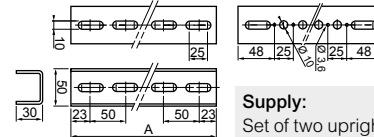

Supply:
Set of two uprights



Characteristics	Height (mm)	A (mm)	References
SM/SMX/SF/SFX Standard uprights	1800	1696	NSYVR18
SM/SMX/SF/SFX Standard uprights	2000	1896	NSYVR20
SM/SMX/SF/SFX Standard uprights	2200	2096	NSYVR22

Nuts and screws for technical uprights



Characteristics	Supply (units)	References
M6 quarter-turn sliding nut	10	NSYSNM6
M8 quarter-turn sliding nut	10	NSYSNM8
M6 quarter-turn serrated sliding nut	10	NSYSNSM6
M8 quarter-turn serrated sliding nut	10	NSYSNSM8
M6 renewable nut	50	NSYCNM6
M8 renewable nut	50	NSYCNM8
M6 x 12 screw	100	AF1VA612
M6 x 18 screw	100	AF1VA618
M8 x 20 screw	100	AF1VC820

Nuts and screws for standard uprights



Characteristics	Supply (units)	References
M6 flat nut	50	NSYFNM6
M8 flat nut	50	NSYFNM8
M6 x 12 screw	100	AF1VA612
M6 x 18 screw	100	AF1VA618
M8 x 20 screw	100	AF1VC820

Bracket for fixing uprights



- Brackets for fixing the uprights, standard or technical, at the same level as the structure, obtaining a greater working surface inside the enclosure.
- They allow two pairs of uprights to be fixed back-to-back, doubling the working surface.
- The brackets are fixed to the structure by means of M6 self-tapping screws.
- Adjustable depth with a pitch of 25 mm.
- Material: Zinc-coated steel.

Supply:
Four brackets for fixing uprights and fixing elements.

Characteristics	References
Bracket for fixing uprights	NSYMFB

Technical changes reserved. Information provided without guarantee. Images are for illustrative purposes only.

SM SMX SF SFX SD SDX

Rail support bracket



NSYFB45

- Bracket for fixing rails at an angle of 45°.
- Material: Zinc-coated steel
- Installation: Spacial SF: Mounted on the structure and/or mounting plates
Spacial SM: Mounted on the bottom mounting rail and/or mounting plates



Supply:
Ten units and fixing elements.
Reference by unit. Order by multiples of 10 (10, 20, 30...)



Characteristics	References
Rail support bracket	NSYFB45

Combined support bracket



NSYETF

- Allows the installation of a DIN rail and an earthing strip on different planes to minimize the cable radiuses.
- Material: Zinc-coated steel
- Installation: Spacial SF: Directly on the structure and/or using mounting plates
Spacial SM: On the bottom adjustment rails and/or on mounting plates

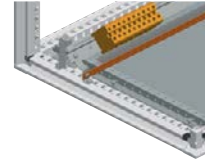

Supply:
Ten combined support brackets and fixing elements.
Reference by unit. Order by multiples of 10 (10, 20, 30...)

Characteristics	References
Combined support bracket	NSYETF

Terminal-block support bracket



NSYEDCO

- Allow the mounting of a DIN rail.
- Tilted to 45°.
- Material: Treated steel

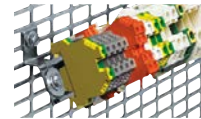

Supply:
Two lugs and fixings



Characteristics	References
Terminal-block support bracket	NSYEDCO

Combined fixing lugs for the earthing strip



NSYEDCOC

- Allows the mounting of an earth collector rail and a DIN rail.
- Tilted to 30°.
- Earthing strip, ref. **NSYECB1M153**. See [page 323](#).

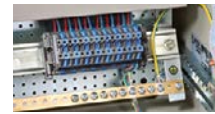

Supply:
Two fixing lugs and fixing elements



Characteristics	References
Combined fixing lugs for the earthing strip	NSYEDCOC

Combined support bracket (vertical)



DZ5MS10

- Allow the installation of a DIN rail and an earthing strip on different planes, to minimize the cable radiuses.
- Material: Zinc-coated steel
- Installation: Spacial SF/SM: Directly on the vertical structure and/or using mounting plates



Supply:
10 brackets

Characteristics	References
Combined support bracket (vertical)	DZ5MS10

Clicked support plate



AX2DL01

- For screw mounted equipment.
- For mounting on 35 mm symmetric and double profile DIN rails or Telequick mounting plate.
- Material: Zinc-plate coated

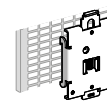

Supply:
Ten units and fixing elements.
Reference by unit. Order by multiples of 10 (10, 20, 30...)



Characteristics	References
Clicked support plate, 44 x 65 - 9 screws	AX2DL01
Clicked support plate, 49 x 65 - 4 screws	AX2DL02

Bracket for fixing control units (Ø 22)



DX1AP52

- To mount any 22 mm diameter device directly on mounting plates.

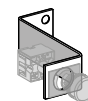

Supply:
Ten units and fixing elements.
Reference by unit. Order by multiples of 10 (10, 20, 30...)



Characteristics	References
Bracket for fixing control units (Ø 22)	DX1AP52

Cross-Rails and Profiles for Floor-Standing Enclosures

- SM
- SMX
- SF
- SFX
- SD
- SDX



In the Spacial SF, SM, SFX and SMX enclosures, it is possible to create a fixing at any point of the inner volume, providing mounting planes with different widths, heights and depths. In the case of the Spacial SM, it may be necessary to install vertical/horizontal adaptation profiles and 40-mm universal cross-rails (one row).



Four types of cross-rails are available to create fixing points:

- Universal cross-rails (see [page 274](#))
- Quick-fixing cross-rails (see [page 275](#))
- Integrated cross-rails (see [page 276](#))
- Light cross-rails (see [page 276](#))

Universal, quick-fixing and integrated cross-rails are available in 3 sizes:

- 40 mm (1 row)
- 65 mm (2 rows)
- 90 mm (3 rows)

Cross-rails for specific applications are also available:

- Cross-rails for heavy loads (see [page 277](#)) to be fixed on the bottom part of the enclosure or to be combined with a "heavy load kit" (see [page 280](#)) to be used at any height in the enclosure
- Cross-rails for Lütze chassis (see [page 277](#))

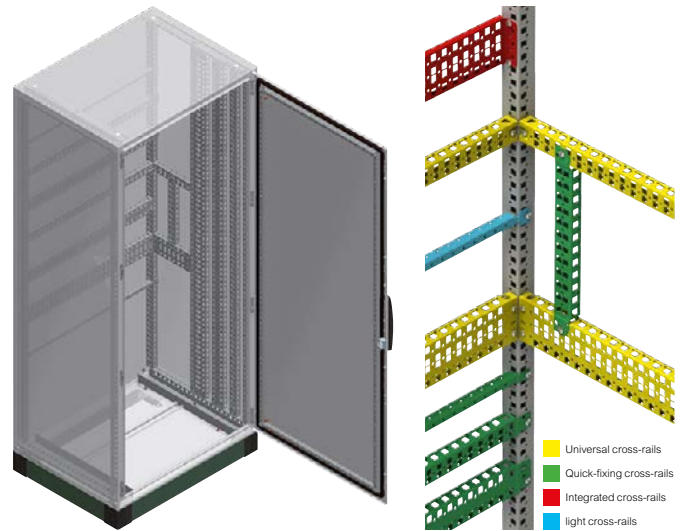
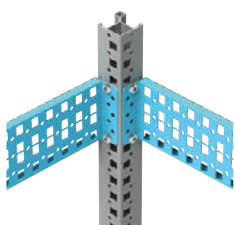

Combination examples



Spacial SF and SFX:
The cross-rails can be fixed to the structure and among each other, offering multiple options.

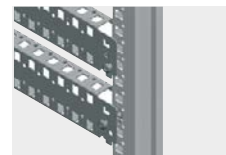

The quick-fixing cross-rails can be fixed directly to the structure, quickly and easily. Spacial SF and SFX*:

- They clip onto the structure and are fixed by M6 self-tapping screws, or optionally with M6 caged nuts.

Spacial SM:

- Option of clipping onto the adaptation profile or another cross-rail.
- Fixing by means of M6 self-tapping screws.
- Fixing by means of M6 caged nuts.

* In Spacial SFX enclosures, it cannot be mounted depthwise.



Universal cross-rails and integrated cross-rails can be simultaneously mounted at the same height, on all the sides of the enclosure. To perform this type of installation in a Spacial SM enclosure, the vertical adaptation profile and the vertical 40 mm universal cross-rail (one row) are required, mounted in the back of the enclosure.

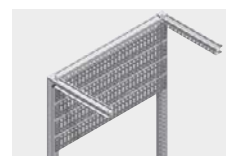

Quick-fixing cross-rails can be used to support equipments at the back of the enclosure or be fixed every 25 mm on two cross-rails (universal or integrated) in vertical position.

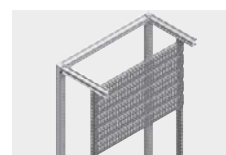

40 mm wide universal and integrated cross-rails can be used as uprights, adjustable every 25 mm in depth. They enable the fixing of diverse equipment supports and are adjustable every 25 mm in height.



Spacial SF:
Universal cross-rails and integrated cross-rails can be mounted in vertical position.

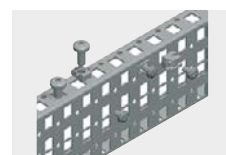

The main fixing point to the quick-fixing cross-rails is the 5.2 mm drill hole for M6 self-tapping screw, although they can also receive M6 and M8 caged nuts.

SM SMX SF SFX Universal cross-rails
SD SDX



- Used for the creation of structures inside the enclosure.
- Cross-rails available in three sizes:
40 mm (one row), 65 mm (two rows) and 90 mm (three rows).
- Each row is perforated every 25 mm with a 5.2 mm diameter hole and a 11x13 mm cutout which enables fixing by means of M6 self-tapping screws, ref **NSYST30M6S**.
- Equipment is fixed by means of caged nuts or self-tapping screws.
- Material: Zinc-coated steel
- Thickness: 15/10^e mm

Fixing to the structure:

Fixing accordingly to uprights axis.
Option to mount cross-rails simultaneously on all sides, at the same height of the enclosure.

Comment:

- (1) For vertical assembly only.
 - (2) Cross-rails only for fixing cables.
 - (3) These cross-rails have not been sized to be used in the width, depth or height of the enclosure, but to be mounted in other positions or in between cross-rails.
- Dimensions see [page 329](#)

Supply:

Two cross-rails, four supports for cross-rails and fixing elements



NSYSUCR4030

Characteristics	Width of the cross-rails (mm)	H / L / P (Dn) of enclosure (mm)	Maximum load by rail (kg)	References
Universal cross-rails	40 (1 row)	300	70	NSYSUCR4030
Universal cross-rails	40 (1 row)	400	60	NSYSUCR4040
Universal cross-rails	40 (1 row)	500	60	NSYSUCR4050
Universal cross-rails	40 (1 row)	600	50	NSYSUCR4060
Universal cross-rails	40 (1 row)	700 (3)	50	NSYSUCR4070
Universal cross-rails	40 (1 row)	800	40	NSYSUCR4080
Universal cross-rails	40 (1 row)	900 (3)	40	NSYSUCR4090
Universal cross-rails	40 (1 row)	1000	30	NSYSUCR40100
Universal cross-rails	40 (1 row)	1100 (3)	30	NSYSUCR40110
Universal cross-rails	40 (1 row)	1200	20	NSYSUCR40120
Universal cross-rails	40 (1 row)	1400	(1)	NSYSUCR40140
Universal cross-rails	40 (1 row)	1600	(1)	NSYSUCR40160
Universal cross-rails	40 (1 row)	1800	(1)	NSYSUCR40180
Universal cross-rails	40 (1 row)	2000	(1)	NSYSUCR40200
Universal cross-rails	40 (1 row)	2200	(1)	NSYSUCR40220
Universal cross-rails	65 (2 rows)	300	110	NSYSUCR6530
Universal cross-rails	65 (2 rows)	400	100	NSYSUCR6540
Universal cross-rails	65 (2 rows)	500	90	NSYSUCR6550
Universal cross-rails	65 (2 rows)	600	80	NSYSUCR6560
Universal cross-rails	65 (2 rows)	800	70	NSYSUCR6580
Universal cross-rails	65 (2 rows)	1000	50	NSYSUCR65100
Universal cross-rails	65 (2 rows)	1200	50	NSYSUCR65120
Universal cross-rails	65 (2 rows)	1400	(1)	NSYSUCR65140
Universal cross-rails	65 (2 rows)	1600	(1)	NSYSUCR65160
Universal cross-rails	65 (2 rows)	1800	(1)	NSYSUCR65180
Universal cross-rails	65 (2 rows)	2000	(1)	NSYSUCR65200
Universal cross-rails	65 (2 rows)	2200	(1)	NSYSUCR65220
Universal cross-rails	90 (3 rows)	300	130	NSYSUCR9030
Universal cross-rails	90 (3 rows)	400	120	NSYSUCR9040
Universal cross-rails	90 (3 rows)	500	120	NSYSUCR9050
Universal cross-rails	90 (3 rows)	600	110	NSYSUCR9060
Universal cross-rails	90 (3 rows)	700 (3)	110	NSYSUCR9070
Universal cross-rails	90 (3 rows)	800	100	NSYSUCR9080
Universal cross-rails	90 (3 rows)	900 (3)	100	NSYSUCR9090
Universal cross-rails	90 (3 rows)	1000	70	NSYSUCR90100
Universal cross-rails	90 (3 rows)	1100 (3)	70	NSYSUCR90110
Universal cross-rails	90 (3 rows)	1200	70	NSYSUCR90120
Universal cross-rails	90 (3 rows)	1400	(1)	NSYSUCR90140
Universal cross-rails	90 (3 rows)	1600	(1)	NSYSUCR90160
Universal cross-rails	90 (3 rows)	1800	(1)	NSYSUCR90180
Universal cross-rails	90 (3 rows)	2000	(1)	NSYSUCR90200
Universal cross-rails	90 (3 rows)	2200	(1)	NSYSUCR90220

10

SM SMX SF SFX Quick-fixing cross-rails
SD SDX



- Used for the creation of structures inside the enclosure.
- Cross-rails available in three sizes: 40 mm (one row), 65 mm (two rows) and 90 mm (three rows).
- Each row is perforated every 25 mm with a 5.2 mm diameter hole and a 11x13 mm cutout which enables fixing by means of M6 self-tapping screws, ref **NSYST30M6S**.
- Equipment are fixed by means of caged nuts or self-tapping screws.
- Material: Zinc-coated steel
- Thickness: 15/10^e mm

Comment:

- (1) For vertical assembly only.
- (2) Cross-rails only for fixing cables.
- (3) These cross-rails have not been sized to be used in the width, depth or height of the enclosure, but to be mounted in other positions or in between cross-rails.

Dimensions see [page 329](#)

Fixing to the structure:

Fixing accordingly to uprights axis.

It is not possible to mount two cross-rails on one level with an upright

Supply:

Two cross-rails and fixing elements



Characteristics	Width of the cross-rails (mm)	H / L / P (Dn) of enclosure (mm)	Maximum load by rail (kg)	References
Quick-fixing cross-rails	40 (1 row)	400	60	NSYSQCR4040
Quick-fixing cross-rails	40 (1 row)	500	60	NSYSQCR4050
Quick-fixing cross-rails	40 (1 row)	600	50	NSYSQCR4060
Quick-fixing cross-rails	40 (1 row)	800	40	NSYSQCR4080
Quick-fixing cross-rails	40 (1 row)	1000	30	NSYSQCR40100
Quick-fixing cross-rails	40 (1 row)	1200	20	NSYSQCR40120
Quick-fixing cross-rails	65 (2 rows)	400	100	NSYSQCR6540
Quick-fixing cross-rails	65 (2 rows)	500	90	NSYSQCR6550
Quick-fixing cross-rails	65 (2 rows)	600	80	NSYSQCR6560
Quick-fixing cross-rails	65 (2 rows)	800	70	NSYSQCR6580
Quick-fixing cross-rails	65 (2 rows)	1000	50	NSYSQCR65100
Quick-fixing cross-rails	65 (2 rows)	1200	50	NSYSQCR65120
Quick-fixing cross-rails	90 (3 rows)	400	120	NSYSQCR9040
Quick-fixing cross-rails	90 (3 rows)	500	120	NSYSQCR9050
Quick-fixing cross-rails	90 (3 rows)	600	110	NSYSQCR9060
Quick-fixing cross-rails	90 (3 rows)	800	100	NSYSQCR9080
Quick-fixing cross-rails	90 (3 rows)	1000	70	NSYSQCR90100
Quick-fixing cross-rails	90 (3 rows)	1200	70	NSYSQCR90120
Set of 2 quick cross-rails 120 x 400 mm				NSYSQCR12040
Set of 2 quick cross-rails 120 x 500 mm				NSYSQCR12050
Set of 2 quick cross-rails 120 x 600 mm				NSYSQCR12060
Set of 2 quick cross-rails 120 x 800 mm				NSYSQCR12080

Integrated cross-rails

- Used for the creation of structures inside the enclosure.
- Cross-rails available in three sizes: 40 mm (one row), 65 mm (two rows) and 90 mm (three rows).
- Each row is perforated every 25 mm with a 5.2 mm diameter hole and a 11x13 mm cutout which enables fixing by means of M6 self-tapping screws, ref **NSYST30M6S**.
- Equipment are fixed by means of caged nuts or self-tapping screws
- Material: Zinc-coated steel
- Thickness: 15/10^e mm

Fixing to the structure:

Fixing is shifted by 30 mm relatively to uprights axis.
Option to mount cross-rails simultaneously on all sides, at the same height of the enclosure.

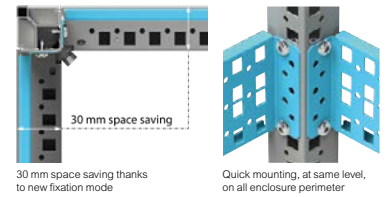

Comment:

Dimensions see [page 329](#)

Supply:

Two cross-rails and fixing elements



Characteristics	Width of the cross-rails (mm)	H / L / P (Dn) of enclosure (mm)	Maximum load by rail (kg)	References
Integrated cross-rails	40 (1 row)	300	70	NSYSICR4030
Integrated cross-rails	40 (1 row)	400	60	NSYSICR4040
Integrated cross-rails	40 (1 row)	500	60	NSYSICR4050
Integrated cross-rails	40 (1 row)	600	50	NSYSICR4060
Integrated cross-rails	40 (1 row)	800	40	NSYSICR4080
Integrated cross-rails	40 (1 row)	1000	30	NSYSICR40100
Integrated cross-rails	40 (1 rows)	1200	20	NSYSICR40120
Integrated cross-rails	65 (2 rows)	300	110	NSYSICR6530
Integrated cross-rails	65 (2 rows)	400	100	NSYSICR6540
Integrated cross-rails	65 (2 rows)	500	90	NSYSICR6550
Integrated cross-rails	65 (2 rows)	600	80	NSYSICR6560
Integrated cross-rails	65 (2 rows)	800	70	NSYSICR6580
Integrated cross-rails	65 (2 rows)	1000	50	NSYSICR65100
Integrated cross-rails	65 (2 rows)	1200	50	NSYSICR65120
Integrated cross-rails	90 (3 rows)	300	130	NSYSICR9030
Integrated cross-rails	90 (3 rows)	400	120	NSYSICR9040
Integrated cross-rails	90 (3 rows)	500	120	NSYSICR9050
Integrated cross-rails	90 (3 rows)	600	110	NSYSICR9060
Integrated cross-rails	90 (3 rows)	800	100	NSYSICR9080
Integrated cross-rails	90 (3 rows)	1000	70	NSYSICR90100
Integrated cross-rails	90 (3 rows)	1200	70	NSYSICR90120

10

SM SF SFX Light cross-rails

- **Spacial SF and SFX:** Direct fixing to the structure or between cross-rails.
- **Spacial SM:** Fixing by means of adaptation profiles and 40 mm universal cross-rails (one row), or between cross-rails in any other position.
- Adjustable with a pitch of 25 mm.
- The light cross-rails are equipped with a row of drill holes with a diameter of 5.2 mm and a pitch of 25 mm, which allows fixing with an M6 self-tapping screw, ref. **NSYST30M6S**.
- Material: Zinc-coated steel



Characteristics	Width/Depth (mm)	References
Spacial SF/SFX/SM Light cross-rails	400	NSYSLCR40
Spacial SF/SFX/SM Light cross-rails	500	NSYSLCR50
Spacial SF/SFX/SM Light cross-rails	600	NSYSLCR60
Spacial SF/SFX/SM Light cross-rails	800	NSYSLCR80

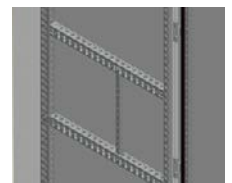

Comment:

Dimensions see [page 329](#)

Supply:

Two light cross-rails and fixing elements

SF Rails for heavy loads

- They can be mounted with a cable gland plate or with a previously mounted mounting plate.
- Laterally adjustable with a pitch of 25 mm.
- Elongated holes, for adjusting the center-to-center distance of the switchgear.
- Fixing to the structure: Directly fixed on the bottom frame of the enclosure
- Thickness: 30/10^e mm
- Material: Galvanized steel



Supply:
Two rails for heavy loads and fixing elements



NSYHLCR40

Characteristics	Maximum load (kg)	Depth (mm)	References
Rail for heavy loads	575	400	NSYHLCR40
Rail for heavy loads	525	500	NSYHLCR50
Rail for heavy loads	500	600	NSYHLCR60
Rail for heavy loads	500	700	NSYHLCR70
Rail for heavy loads	475	800	NSYHLCR80

SF Cross-rail for Lütze chassis

- Cross-rail for fixing and adjusting the depth of the Lütze chassis.
- Thickness: 25/10^e mm
- Material: Galvanized steel

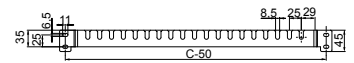

Supply:
Six cross-rails for Lütze chassis and fixing elements

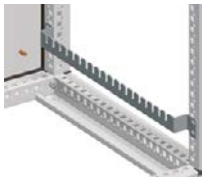

NSYLCR40

Characteristics	Depth (mm)	References
Cross-rail for Lütze chassis	400	NSYLCR40
Cross-rail for Lütze chassis	500	NSYLCR50
Cross-rail for Lütze chassis	600	NSYLCR60

Support for Lütze chassis

- Support for installing Lütze chassis in the back of the enclosure.
- Thickness: 25/10^e mm
- Material: Galvanized steel

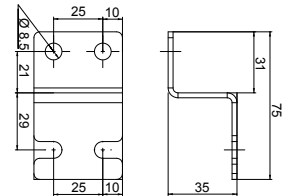

Comment:
Dimensions see [page 329](#)

Supply:
Six supports and fixing elements



NSYLSUP

Characteristics	References
Spacial SF Support for Lütze chassis	NSYLSUP

SM Vertical adaptation profiles



NSYSMVR12

- The vertical adaptation profiles provide fixing points at the entrance to the enclosure.
- Fixing on the screws of the hinge and catches of the lock.
- Allows the depthwise fixing of cross-rails, etc.
- Thickness: 15/10^e mm
- Material: Zinc-coated steel



Comment:
Dimensions see [page 330](#)

Supply:
2 vertical adaptation profiles and fixing screws

Characteristics	Height (mm)	References
Vertical adaptation profiles	1200	NSYSMVR12
Vertical adaptation profiles	1400	NSYSMVR14
Vertical adaptation profiles	1600	NSYSMVR16
Vertical adaptation profiles	1800	NSYSMVR18
Vertical adaptation profiles	2000	NSYSMVR20

SM Horizontal adaptation profiles



NSYSMHR6

- The horizontal adaptation profiles provide fixing points at the entrance to the enclosure.
- Thickness: 15/10^e mm
- Material: Zinc-coated steel



Comment:
Dimensions see [page 330](#)

Supply:
2 horizontal adaptation profiles and fixing screws

Characteristics	Width (mm)	References
Horizontal adaptation profiles	600	NSYSMHR6
Horizontal adaptation profiles	800	NSYSMHR8
Horizontal adaptation profiles	1000	NSYSMHR10
Horizontal adaptation profiles	1200	NSYSMHR12
Horizontal adaptation profiles	1600	NSYSMHR16

SM SF Fixed tray

- Provided with cut-outs for improving air circulation inside.
- Material: Steel
- Finish: Painted with epoxy polyester resin
- Color: RAL 7035 grey
- Maximum load: 150 kg direct fixed to the structure, 40 kg when universal cross-rails are used



NSYFXT6040

Characteristics	Width (mm)	Depth (mm)	References
Fixed tray	600	400	NSYFXT6040
Fixed tray	800	400	NSYFXT8040
Fixed tray	600	500	NSYFXT6050
Fixed tray	800	500	NSYFXT8050
Fixed tray	600	600	NSYFXT6060
Fixed tray	800	600	NSYFXT8060
Fixed tray	800	800	NSYFXT8080

Supply:
1 fixed tray and fixing elements

Options for fixing the tray to the enclosure:

- If the tray has the same dimensions as the enclosure:
- Spacial SF: Direct fixing to the structure.
 - Spacial SFX: Installation possible only with universal cross-rails, see [page 274](#).
 - Spacial SM: Fixing by means of adaptation profiles and 40 mm universal cross-rails (1 row) in vertical position.
- If the tray is smaller than the dimensions of the enclosure:
- Fixing on depth cross-rails.
 - Depth-adjustable tray with a pitch of 25 mm.

SM SF Telescopic rails

- End-of-travel stop of the rails in open and closed position.
- Material: Zinc-coated steel
- Finish: Painted with epoxy polyester resin
- Maximum load: 25 kg evenly distributed



NSYTTG40

Characteristics	Width (mm)	Depth (mm)	References
Telescopic rails	600/800	400	NSYTTG40
Telescopic rails	600/800	500	NSYTTG50
Telescopic rails	600/800	600/800	NSYTTG60

Supply:
2 telescopic rails and fixing elements

Options for fixing the tray to the enclosure:

- Spacial SF: Installation directly on the structure of the enclosure or on universal cross-rails.
- Spacial SFX: Installation possible only with universal cross-rails, see [page 274](#).
- Spacial SM: Installation by means of adaptation profiles and 40 mm universal cross-rails (1 row) in vertical position, or on horizontal universal cross-rails.

The installation of a telescopic tray consists of the following:

- 1 fixed tray.
- 2 telescopic rails.

Handle for telescopic trays

- Designed for easy extraction of the sliding trays.
- Material: Polyamide 6 (black).



NSY1TH

Characteristics	References
Handle for telescopic trays	NSY1TH

Supply:
2 units and fixing elements

SM SMX SF SFX Tray cross-rails

- Allow the installation of fixed trays and telescopic rails. Quick and universal cross-rails, see [page 274 - 275](#)

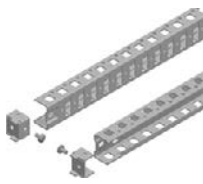

NSYSUCR4040



NSYSQCR4040

Characteristics	Depth (mm)	References
Tray cross-rails, Universal cross-rail, 40 mm (1 row)	400	NSYSUCR4040
Tray cross-rails, Universal cross-rail, 40 mm (1 row)	500	NSYSUCR4050
Tray cross-rails, Universal cross-rail, 40 mm (1 row)	600	NSYSUCR4060
Tray cross-rails, Universal cross-rail, 40 mm (1 row)	800	NSYSUCR4080
Tray cross-rails, Quick-fixing cross-rail, 40 mm (1 row)	400	NSYSQCR4040
Tray cross-rails, Quick-fixing cross-rail, 40 mm (1 row)	500	NSYSQCR4050
Tray cross-rails, Quick-fixing cross-rail, 40 mm (1 row)	600	NSYSQCR4060
Tray cross-rails, Quick-fixing cross-rail, 40 mm (1 row)	800	NSYSQCR4080



SF Heavy load kit

- 4 parts designed to strengthen installation supports (shelves or cross-rails) in case of heavy loads.
- Several kits can be set up in the same enclosure as long as the maximum load of 1000 kg is not exceeded.
- Strengthen the stiffness of the enclosure.
- Supports set up in the depth direction embed cut-outs to help secure equipment fixing.
- Material: Steel
- Color: RAL 7035 grey
- Maximum load: Up to 350 kg

The kit can be used with following rails:

- Standard crossrails delivered with Spacial SF,
- Quick-fixing cross-rails **NSYSQCR●●●●●**,
- DIN rails **NSYSDR●●** and **NSYDPR●●**,
- **NSYCN●●** rails,
- Heavy load cross-rails **NSYHLCR●●**.

Comment:

Combination examples see [page 330](#)

Supply:

2 cross-rails (front/rear)
+ 2 supports to be mounted according to depth direction



NSYSHLT6040

Characteristics	Width (mm)	Depth (mm)	References
Heavy load kit	600	400	NSYSHLT6040
Heavy load kit	800	400	NSYSHLT8040
Heavy load kit	600	600	NSYSHLT6060
Heavy load kit	800	600	NSYSHLT8060
Heavy load kit	600	800	NSYSHLT6080
Heavy load kit	800	800	NSYSHLT8080

SF Ventilated shelf

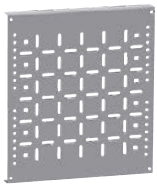

NSYDHLT6040

- Airing is ensured by two cut-out sizes: 11 x 13 mm rectangles for fixation on both sides with self-tapping screws, 40 x 8.5 mm rectangles.
- The ventilated shelf must be fixed in the enclosure with a heavy load kit.
- Material: Steel
- Color: RAL 7035 grey
- Maximum load: 350 kg



Supply:

1 tray and fixing elements

Characteristics	Tray dimensions W x D x H (mm)	Width (mm)	Depth (mm)	References
Ventilated shelf	500 x 559 x 50	600	600	NSYDHLT6060
Ventilated shelf	700 x 559 x 50	800	600	NSYDHLT8060
Ventilated shelf	500 x 759 x 50	600	800	NSYDHLT6080
Ventilated shelf	700 x 759 x 50	800	800	NSYDHLT8080

NSYSHLT6040

10

SF Partially ventilated shelf

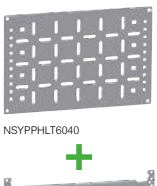

NSYPPHLT6040

- In order to support the maximum load, the shelf must be mounted either in the rear or in the front of the enclosure.
- An intermediary cross-rail must be set up in the middle to bear a heavy loads.
- Airing is ensured by two cut-out sizes: 11 x 13 mm rectangles for fixation on both sides with selftapping screws, 40 x 8.5 mm rectangles.
- The partially ventilated shelf must be fixed in the enclosure with a heavy load kit.
- Material: Steel
- Color: RAL 7035 grey
- Maximum load: 250 kg



Supply:

1 tray and fixing elements

Characteristics	Tray dimensions W x D x H (mm)	Width (mm)	Depth (mm)	References
Partially ventilated shelf	500 x 325 x 2	600	400	NSYPPHLT6040
Partially ventilated shelf	700 x 325 x 2	800	400	NSYPPHLT8040

NSYSHLT6040

SF Plain shelf for battery



NSYPHLT6040



NSYSHLT6040

- Painted shelf with rims to avoid potential liquid leakage.
- Electrical continuity is ensured by specific staples.
- Access and replacement (thus maintenance) are eased by mounting brackets.
- The plain shelf must be fixed in the enclosure with a heavy load kit.
- Material: Steel
- Color: RAL 7035 grey
- Maximum load: 350 kg



Supply:
1 tray and fixing elements

Characteristics	Tray dimensions W x D x H (mm)	Depth (mm)	Width (mm)	References
Plain shelf for battery	500 x 300 x 16	400	600	NSYPHLT6040
Plain shelf for battery	700 x 300 x 16	400	800	NSYPHLT8040
Plain shelf for battery	500 x 500 x 16	600	600	NSYPHLT6060
Plain shelf for battery	700 x 500 x 16	600	800	NSYPHLT6080
Plain shelf for battery	500 x 700 x 16	800	600	NSYPHLT6080
Plain shelf for battery	700 x 700 x 16	800	800	NSYPHLT8080

SF Heavy load cross-rails



NSYHLCR40

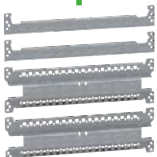

NSYSHLT6040

- Can be fixed anywhere in the enclosure with a heavy load kit.
- Free space useful for thermal management.
- Nominal width of cross-rails must be 100 mm shorter than the associated heavy load kit width.
- Material: Steel

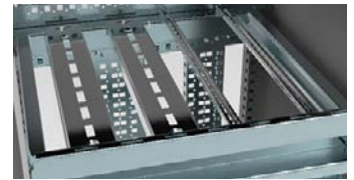

Supply:
2 cross-rails and fixing elements

Characteristics	Associated heavy load kit references	Maximum load (kg)	Nominal width (mm)	References
Heavy load cross-rails	Not usable with heavy load kit	575	400	NSYHLCR40
Heavy load cross-rails	NSYSHLT6040 NSYSHLT6060 NSYSHLT6080	525	500	NSYHLCR50
Heavy load cross-rails	Not usable with heavy load kit	500	600	NSYHLCR60
Heavy load cross-rails	NSYSHLT8040 NSYSHLT8060 NSYSHLT8080	500	700	NSYHLCR70
Heavy load cross-rails	Not usable with heavy load kit	475	800	NSYHLCR80

Heavy load supports



Combination examples



- Heavy load kit + Ventilated shelf
- Heavy load kit + Partially ventilated shelf
- Heavy load kit + Plain shelf for battery
- Heavy load kit + Heavy load cross-rails

S3D S3X PLM Symmetric mounting rail for the wall-mounted enclosures



- 2 types: Type A: 35 x 15 mm, Type B: 35 x 7.5 mm
- Material: Zinc-coated steel
- Standards: IEC 715
- Thickness: Type A: 15/10° mm, Type B: 10/10° mm
- Fixing: Fixed to mounting plates or another fixing elements, uprights not included in the supply

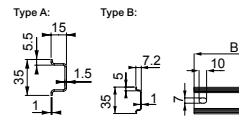

Supply:
10 rails and fixings for direct assembling to the structure. References by unit. Order by multiples of 10 units(10, 20, etc.)



Characteristics	Type	Enclosure width (mm)	Rail length (mm)	References
Symmetric mounting rail for the wall-mounted enclosures	B	300	250	NSYSDR30B
Symmetric mounting rail for the wall-mounted enclosures	B	400	350	NSYSDR40B
Symmetric mounting rail for the wall-mounted enclosures	A	500	450	NSYSDR50A
Symmetric mounting rail for the wall-mounted enclosures	A	600	550	NSYSDR60A
Symmetric mounting rail for the wall-mounted enclosures	A	800	750	NSYSDR80A
Symmetric mounting rail for the wall-mounted enclosures	A	1000	950	NSYSDR100A

SM SMX SF SFX Symmetric DIN rails for the floor-standing enclosures



- Help ensure horizontal continuity in case of enclosure assembly.
- Rail type: Type A: 35 x 15 mm.
- Material: Zinc-coated steel
- Standards: IEC 715
- Thickness: 15/10° mm
- Fixing: Fixed to the standard or technical uprights (see [page 271](#)) or directly to the structure

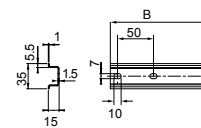

Supply:
10 rails and fixings for direct assembling to the structure. References by unit. Order by multiples of 10 units(10, 20, etc.)



Characteristics	Enclosure width (mm)	Rail length (mm)	References
Symmetric DIN rail for the floor-standing enclosures	600	588	NSYSDR60
Symmetric DIN rail for the floor-standing enclosures	800	788	NSYSDR80
Symmetric DIN rail for the floor-standing enclosures	1000	988	NSYSDR100
Symmetric DIN rail for the floor-standing enclosures	1200	1188	NSYSDR120

Symmetric rails

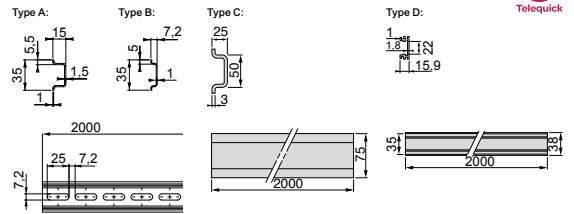

- Material: Galvanized steel, zinc-coated steel or aluminum
- Length: 2000 mm



NSYSDR200D

Characteristics	Type	Order by Multiples	Perforations	References
Symmetric rail, Galvanized steel	A	10	Perforated	NSYSDR200D
Symmetric rail, Galvanized steel	B	10	Perforated	NSYSDR200BD
Symmetric rail, Galvanized steel	A	10	Not perforated	NSYSDR200
Symmetric rail, Galvanized steel	B	10	Not perforated	NSYSDR200B
Symmetric rail, Zinc-coated steel	C	6	Not perforated	AM1DL201
Symmetric rail, Aluminum	D	10	Not perforated	AM1EA200

Asymmetric DIN rails

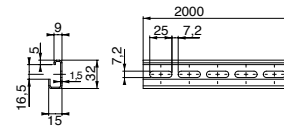

- Material: Galvanized steel
- Length: 2000 mm



NSYADR200D

Supply:
10 rails with a length of 2 m.
References by unit. Order by multiples of 10 units (10, 20, etc.)

Characteristics	Perforations	References
Asymmetric DIN rail	Perforated	NSYADR200D
Asymmetric DIN rail	Not perforated	NSYADR200

Double-profile DIN rails

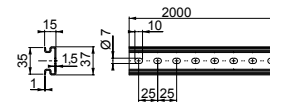

- Material: Galvanized steel
- Length: 2000 mm



NSYDPR200D

Supply:
10 rails with a length of 2 m.
References by unit. Order by multiples of 10 units (10, 20, etc.)
ref. **NSYDPR200T** multiples 20

Characteristics	Thickness (mm)	Perforations	Order by Multiples	References
Double-profile DIN rail	15/10°	Perforated	10	NSYDPR200D
Double-profile DIN rail	10/10°	Perforated	20	NSYDPR200T
Double-profile DIN rail	15/10°	Not perforated	10	NSYDPR200

Nuts for symmetric rails



AF1GC4

- Clip-on nut.

Characteristics	Type	References
Nuts for symmetric rails	M4	AF1GC4
Nuts for symmetric rails	M5	AF1GC5
Nuts for symmetric rails	M6	AF1GC6

Supply:
100 nuts



Nuts for asymmetric DIN rails, 2000 mm version



DZ5ME5

- Quarter-turn sliding nut.

Characteristics	Type	References
Nuts for asymmetric DIN rails, 2000 mm version	M4	DZ5ME5
Nuts for asymmetric DIN rails, 2000 mm version	M5	DZ5ME8
Nuts for asymmetric DIN rails, 2000 mm version	M6	DZ5ME9

Supply:
100 nuts



Nuts for double-profile DIN rails



AF1CF34

- Quarter-turn sliding nut.

Characteristics	Type	References
Nuts for double-profile DIN rails	M3 + M4	AF1CF34
Nuts for double-profile DIN rails	M5 + M6	AF1CF56

Supply:
100 nuts



Nuts for serrated C-shaped rails



NSYSNM6

- Quarter-turn sliding nuts.

Characteristics	Type	References
M6 quarter-turn sliding nut	M6	NSYSNM6
M8 quarter-turn sliding nut	M8	NSYSNM8
M6 quarter-turn serrated sliding nut	M6	NSYSNSM6
M8 quarter-turn serrated sliding nut	M8	NSYSNSM8

Supply:
10 nuts



Connectors for Symmetric C-Shaped Rails

- The connectors enable the formation of chassis or frames and structures for fixing switchgear, in any position inside the enclosures, allowing the fixing of DIN rails or other elements.
- See symmetric C-shaped rails.

EMA connectors



NSYEMA20

- To join two symmetric C-shaped rails, C20 and C40 types, at right angles; They can also be used to obtain a T-shaped assembly.
- Material: Zinc-coated steel
- Thickness: 20/10^e mm

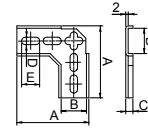

Comment:
Dimensions
see [page 332](#)

Supply:
20 units. References by unit. Order by multiples of 20 units (20, 40, 60, etc.)

Characteristics		References
EMA connectors		NSYEMA20
EMA connectors		NSYEMA40

EVA connectors



NSYEVA20

- To join two symmetric C-shaped rails, C20 and C40 types, forming an overlapping assembly with plane change, or also at right angles for the formation of spacers or supports at a different level.
- Material: Zinc-coated steel

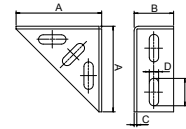

Comment:
Dimensions
see [page 332](#)

Supply:
20 units. References by unit. Order by multiples of 20 units (20, 40, 60, etc.)

Characteristics		References
EVA connectors		NSYEVA20
EVA connectors		NSYEVA40

UCA connectors



NSYUCA22

- To join symmetric C-shaped rails, types C20 and C40, forming a cross-shaped assembly of three rails located on the same plane, for example inside a frame.
- Material: Zinc-coated steel

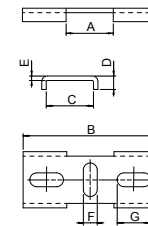

Comment:
Dimensions
see [page 333](#)

Supply:
20 units. References by unit. Order by multiples of 20 units (20, 40, 60, etc.)

Characteristics		References
UCA connectors		NSYUCA22
UCA connectors		NSYUCA44

UTA connectors



NSYUTA22

- To create a T-shaped assembly between two symmetric C-shaped rails, C20 and C40 types, especially recommended for forming crossbars on chassis and frames.
- The **UTA42** connectors type allows C20 rails to be joined with C40 rails.
- Material: Zinc-coated steel

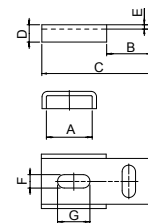

Comment:
Dimensions
see [page 333](#)

Supply:
20 units. References by unit. Order by multiples of 20 units (20, 40, 60, etc.)

Characteristics		References
UTA connectors		NSYUTA22
UTA connectors		NSYUTA42
UTA connectors		NSYUTA44

10

Connectors for Symmetric C-Shaped Rails

ECA connectors



NSYECA22

- To form a cross-shaped assembly with two symmetric C-shaped rails, C20 and C40 types, located perpendicularly on different planes.
- The **ECA42** connector type makes it possible to join C20 rails with C40 rails.
- Material: Zinc-coated steel

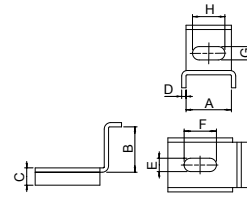

Comment:
Dimensions
see [page 333](#)

Supply:
20 units. References by unit. Order by multiples of 20 units (20, 40, 60, etc.)

Characteristics		References
ECA connectors		NSYECA22
ECA connectors		NSYECA42
ECA connectors		NSYECA44

UR connectors



NSYUR20

- For rectilinear joining of symmetric C-shaped rails.
- Recommended when the standard length is not sufficient or for maximising fractions.
- Material: Zinc-coated steel

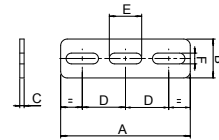

Comment:
Dimensions
see [page 333](#)

Supply:
20 units. References by unit. Order by multiples of 20 units (20, 40, 60, etc.)

Characteristics		References
UR connectors		NSYUR20
UR connectors		NSYUR40
UR connectors		NSYUR60

UT connectors



NSYUT20

- To form T-shaped assemblies between symmetric C-shaped rails.
- They are used to form crossbars on frames and structures.
- Material: Zinc-coated steel

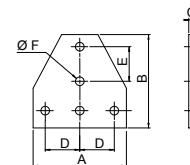

Comment:
Dimensions
see [page 333](#)

Supply:
20 units. References by unit. Order by multiples of 20 units (20, 40, 60, etc.)

Characteristics		References
UT connectors		NSYUT20
UT connectors		NSYUT40
UT connectors		NSYUT60

EN connectors



NSYEN20

- To create L-shaped assemblies with plane change in the symmetric C-shaped rails, between them or with any other section.
- Material: Zinc-coated steel

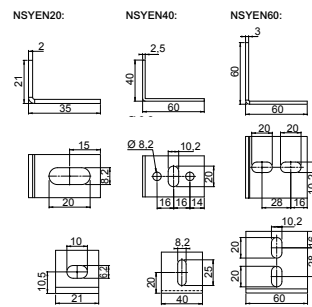

Comment:
Dimensions
see [page 333](#)

Supply:
20 units. References by unit. Order by multiples of 20 units (20, 40, 60, etc.)

Characteristics		References
EN connectors		NSYEN20
EN connectors		NSYEN40
EN connectors		NSYEN60

Hexagonal spacers

- Hexagonal spacers for raising switchgear, mounting plates, etc. They can be linked to achieve variable heights with gradual elevation.
- Their assembly requires M6 or M8 caged nuts.
- Material: Zinc-coated steel
- Installation: If used to raise a mounting plate, the maximum load of the mounting plate is decreased

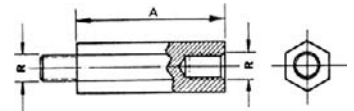

Supply:
100 hexagonal connectors.
References by unit.
Order by multiples of 100 units
(100, 200, 300, etc.)



NSYE1025

Characteristics	Thread type	Spacer height (mm)	References
Hexagonal spacers	M5	10	NSYE1025
Hexagonal spacers	M5	15	NSYE1525
Hexagonal spacers	M5	20	NSYE2025
Hexagonal spacers	M6	10	NSYEX106
Hexagonal spacers	M6	12	NSYEX126
Hexagonal spacers	M6	14	NSYEX146
Hexagonal spacers	M6	16	NSYEX166
Hexagonal spacers	M6	18	NSYEX186
Hexagonal spacers	M6	20	NSYEX206
Hexagonal spacers	M6	30	NSYEX306
Hexagonal spacers	M6	40	NSYEX406
Hexagonal spacers	M6	50	NSYEX506
Hexagonal spacers	M6	100	NSYEX1006
Hexagonal spacers	M8	15	NSYEX158
Hexagonal spacers	M8	20	NSYEX208
Hexagonal spacers	M8	30	NSYEX308
Hexagonal spacers	M8	40	NSYEX408
Hexagonal spacers	M8	50	NSYEX508
Hexagonal spacers	M8	60	NSYEX608
Hexagonal spacers	M8	100	NSYEX1008

ETU modular spacers

10



NSYETU48

- Modular spacers for installing devices or rails at a different level from that achieved with the basic chassis or mounting plate.
- Material: Zinc-coated steel

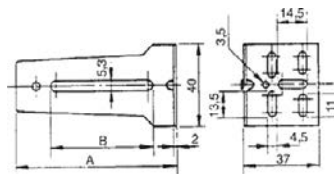

Note:
Combination of spacers
see [page 334](#)

Supply:
20 units. References by unit.
Order by multiples of 20 units
(20, 40, 60, etc.)

Characteristics	A (mm)	B (mm)	References
ETU modular spacers	48	25	NSYETU48
ETU modular spacers	58	25	NSYETU58
ETU modular spacers	79	55	NSYETU79
ETU modular spacers	118	55	NSYETU118

S3D S3X 19" fixed chassis for wall-mounted enclosure

- 19" fixed chassis comprising 2 19" uprights with fixing.
- Adjustable in depth by fixing on the step slides available as accessory.
- Material: Galvanized steel
- Thickness: 20/10° mm
- Maximum load: 3 kg per unit



Characteristics	Enclosure dimensions (mm)		Unit number	References
	Height	Width		
19" fixed chassis for wall-mounted enclosure	400	600	8	NSYVDM8UF
19" fixed chassis for wall-mounted enclosure	600	600	12	NSYVDM12UF
19" fixed chassis for wall-mounted enclosure	800	600	17	NSYVDM17UF
19" fixed chassis for wall-mounted enclosure	1000	600	21	NSYVDM21UF

S3D S3X 19" swing chassis for wall-mounted enclosure

- 19" swing chassis opening to 120° with locking system by 3-mm double-bar insert.
- Material: Steel
- Finish: Structured finish, epoxy polyester powder
- Color: RAL 7035 grey
- Maximum load: 3 kg per unit



Characteristics	Enclosure dimensions (mm)		Unit number	References
	Height	Width		
19" swing chassis for wall-mounted enclosure	400	600	7	NSYVDM7UP
19" swing chassis for wall-mounted enclosure	600	600	11	NSYVDM11UP
19" swing chassis for wall-mounted enclosure	800	600	16	NSYVDM16UP
19" swing chassis for wall-mounted enclosure	1000	600	20	NSYVDM20UP
19" swing chassis for wall-mounted enclosure	1000	800	20	NSYVDM20U8P
19" swing chassis for wall-mounted enclosure	1200	800	25	NSYVDM25U8P

Fixings for 19" rack

- They allow 19" accessories to be mounted.
- Caged nut compatible with 8.5 x 8.5 mm and 9.5 x 9.5 mm holes.









Characteristics	Set of	References
M6 screws + washers + nuts 8,5 mm	30	NSYGFR95M63
M6 x 16 screws and washers	50	NSYGFR166P
M6 caged nuts 9,5 mm	100	NSYCN9M625
M6 screws + washers + nuts 9,5 mm	50	NSYGFR95M65
M5 screws + washers + nuts 9,5 mm	50	NSYGFR95M55
M6 12 mm	50	NSYGFR12M65

Nuts and Screws Overview

Characteristics		Clip-on nuts				Combiplas slide nuts				Metal sliding nut				Screws with captive washer		
																
Usage		For Telequick mounting plates				C - shaped rail - 20/40/60 mm								Hexagonal head All nuts		
																
Type	Supply	References	Rail type	Supply	References	Supply	References	Models	Supply	References						
M3	100	AF1EA3	-	-	-	-	-	-	-	-						
M4	100	AF1EA4	C20	100	NSYBN204	100	NSYB204	M4 x 10 mm	100	AF1VA410						
M4	100	AF1EA4	C40	100	NSYBN404	100	NSYB404	M4 x 16 mm	100	AF1VA416						
M5	100	AF1EA5	-	-	-	-	-	M5 x 12 mm	100	AF1VA512						
M5	100	AF1EA5	-	-	-	-	-	M5 x 18 mm	100	AF1VA518						
M6	100	AF1EA6	C20	100	NSYBN206	-	-	M6 x 12 mm	100	AF1VA612						
M6	100	AF1EA6	C40	100	NSYBN406	-	-	M6 x 18 mm	100	AF1VA618						
M6	100	AF1EA6	C60	100	NSYBN606	100	NSYB406	-	-	-						
M8	-	-	C40	100	NSYBN408	-	-	M8 x 20 mm	100	AF1VC820						
M8	-	-	C60	100	NSYBN608	-	-	-	-	-						
M10	-	-	C60	100	NSYBN610	-	-	-	-	-						

Supply:

References by unit. Order by multiples of the units specified in the supply.

Characteristics		Fixings and nuts for serrated uprights				Nuts for uprights and cross-rails					
											
		Fixing brackets		1/4 turn		Serrated 1/4 turn		Removable nut		Cage nut	
Usage		2 x serrated mounting uprights for floor-standing enclosures									
											
Type	Supply	References	Supply	References	References	Supply	References	Supply	References		
M4	4	NSYMF8	-	-	-	-	-	-	-		
M5	-	-	-	-	-	-	-	-	-		
M6	-	-	10	NSYSNM6	NSYSNSM6	50	NSYCNM6	50	NSYCNFM6		
M8	-	-	10	NSYSNM8	NSYSNSM8	50	NSYCNM8	50	NSYCNFM8		
-	-	-	-	-	-	-	-	-	-		
-	-	-	-	-	-	-	-	-	-		

Supply:







References by unit. Order by multiples of the units specified in the supply.

Torx screws			Self-tapping screw			Fixings and nuts for aluminum uprights					
											
Nuts and 6 mm Spacial enclosures holes						Mounting uprights for wall-mounted enclosures					
											
Models	Supply	References	Models	Supply	References	Supply	References	Supply	References	Type	
-	-	-	-	-	-	-	-	4	NSYAMCSF	M3	
-	-	-	-	-	-	100	NSYNM4			M4	
-	-	-	-	-	-	-	-			M4	
-	-	-	M5 x 13 mm	100	NSYS13M5HS	100	NSYNM5			M5	
-	-	-	M5 x 16 mm	100	NSYS16M5HS	-	-			M5	
T30 M6 x 16 mm	100	NSYST30M6	M6 x 16 mm	100	NSYS16M6HS	100	NSYNM6			M6	
T30 M6 x 12 mm self-tapping	100	NSYST30M6S	-	-	-	-	-			M6	
-	-	-	-	-	-	-	-			M6	
T40 M8 x 16 mm	100	NSYST40M8	-	-	-	-	-			M8	
-	-	-	-	-	-	-	-			M8	
-	-	-	-	-	-	-	-			M10	

Flat nuts for standard uprights		Clip nut for symmetric DIN rail		Quarter turn nut for double profile DIN rail			Quarter turn nut for asymmetric DIN rail		
									
2 x standard mounting uprights for floor-standing enclosures		35 x 15 mm symmetric DIN rail		35 mm double profile DIN rail			35 mm asymmetric DIN rail		
									
Supply	References	Supply	References	Models	Supply	References	Supply	References	Type
-	-	100	AF1CG4	-	-	-	100	DZ5ME5	M4
-	-	100	AF1CG5	-	-	-	100	DZ5ME8	M5
50	NSYFNM6	100	AF1CG6	-	-	-	100	DZ5ME9	M6
50	NSYFNM8	-	-	-	-	-	-	-	M8
-	-	-	-	M3 + M4	100	AF1CF34	-	-	-
-	-	-	-	M5 + M6	100	AF1CF56	-	-	-

Multiple Cable Entries Overview

• For details enter the reference into the search engine of www.se.com

Characteristics	FlexiCable	Multi-A	Multi-C	Multi-R	Multi-CS	Multi-T
						
	Full membrane cable gland plate.	FL13 and FL21 type membranes.	Circular connector-free entries.	Rectangular connector-free entries.	Modular entry allowing the passing of up to 48 pre-assembled cables.	FL21-type membranes.
Material	HCE for membrane. Steel for frame	TPE, SBS, SEBS and PP co-polymer - halogen-free	Polyamide	Polyamide	Reinforced polypropylene and TPE. halogen-free	TPE
Color	Frame: RAL 7035 grey	RAL 7035 grey	-	-	Black	RAL 7035 grey
Cable entry material	Soft membrane	Combined	Soft membrane			
Cable glands to be fitted	No	Optional: Specific cable clamp ref. NSYAECPLACA●● to be used	No	No	No	No
Installation options	Replaces cable gland plate (S3D) or directly on enclosure	On cable gland plate adapter or directly on enclosure	On modified cable gland plate or directly on enclosure	On cable gland plate with special cut-out or directly on enclosure	On cable gland plate adapter or directly on enclosure	
Flexibility of the installation	Full	Medium	Medium	Medium	Full	Medium
Reversibility	Medium	Medium	Full	Full	Full	Medium
Ingress protection rating	IP55 according to IEC 60529	IP65 according to IEC 60529	IP65 according to IEC 60529	IP65 according to IEC 60529	IP65 according to IEC 60529	IP66 according to IEC 60529*
Cable retention	Low	High with cable clamp. (up to 18 daN)	Medium	Medium	Medium	Low
Cable diameter (mm)	Up to 26	From 13 to 30	From 3 to 15.9	From 4.3 to 15.9	Up to 22	From 5 to 60
Cable Installation time	Fast	Medium	Fast	Fast	Fast	Fast
Quantity of cables to be fitted for a given surface	+++	++	++	++	+++	++
Cable entries for cables with connectors	No	No	No	No	Yes	No
Cut-out dimensions (mm)	178 x 63 to 478 x 63	134 x 52 (FL13) 214 x 90 (FL21)	Ø 50.5 Ø 63.5	112 x 36	112 x 36	214 x 90 (FL21)
External dimensions (mm)	245 x 130 to 545 x 130 or 495 x 220	216 x 84	Ø 58 Ø 71	146 x 14 x 58	148 x 58 x 15 148 x 58 x 18	214 x 88
Certificates	Tested on short-circuit effect 250 A, 25 kA following IEC 61439-1	Cable anchorage pull test: EN 50262. Long term UV- resistance: ASTM G 154-06	UL recognized (UsR) V-0	UL recognized (UsR) V-0	-	-
Fire resistance	650 °C	750 °C	650 °C	650 °C	-	650 °C
Temperature range	-	-40 °C to +85 °C	-	-	-30 °C to +100 °C	-40 °C to +100 °C
References	See page 300 NSYTL●●●	See page 300 NSYAECPLA●●	See page 300 NSYTSAM●●●●●	See page 301 NSYSA24●●●●●	See page 302 NSYDCD24●●	See page 301 NSYAECPL●●●





10

* IP65 for NSYAECPLBP.

Technical changes reserved. Information provided without guarantee. Images are for illustrative purposes only.

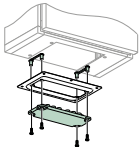
Multiple Cable Entries Overview

• For further information please have a look on the next page



Characteristics	PrismaSeT	Multi-F	Multi-CF	Multi-CR	Multi-H
					
	FL21 or rectangular.	FL13 and FL21 pre-configured flanges.	Cable entry for protected cables.	Cable entries with dies for cables equipped with connectors.	FL21 insulated flange with ISO knock-outs.
Material	Insulated material	Fiberglass-reinforced polypropylene and TPE - Calogen Free	Reinforced polypropylene and TPE. Halogen-free	Polyamide	Polycarbonate glass-fiber reinforced
Color	RAL 9003	RAL 7035 grey	Black	-	RAL 7035 grey
Cable entry material	Soft membrane			Hard-plastic	
Cable glands to be fitted	No	No	No	Yes	Yes
Installation options	On cable gland plate adapter or directly on enclosure				
Flexibility of the installation	Medium	Medium	Full	Low	Low
Reversibility	Medium	Medium	Full	Medium	Medium
Ingress protection rating	IP55 according to IEC 60529	IP65 according to IEC 60529	IP65 according to IEC 60529	IP54 according to IEC 60529	IP65 according to IEC 60529
Cable retention	Low	Low	Medium	High (with fastener)	High (with cable clamp)
Cable diameter (m)	From 28 to 60 (FL21) From 7 to 72 (rectangular)	From 16 to 50	From 9 to 30	From 3 to 31	From 12 to 25
Cable Installation time	Fast	Fast	Fast	Slow	Slow
Quantity of cables to be fitted for a given surface	++	++	+++	++	++
Cable entries for cables with connectors	No	No	Yes	Yes	No
Cut-out dimensions (mm)	214 x 90 (FL21)	134 x 52 (FL13) 214 x 90 (FL21)	112 x 36	36 x 91 (NSYDCE168) 36 x 112 (NSYDCE24•)	214 x 90 (FL21)
External dimensions (mm)	216 x 84	From 134 x 52 to 214 x 90	148 x 60 x 10	146 x 58	215 x 85
Certificates	-	<ul style="list-style-type: none"> • Test standard EN 60529:1991 + A1 • EN 60670-1:2005, • EN 50262:1998 EMKO-TUI (03-SEC) FI001/84. • Semko report 816003 • UL-approved materials 	-	-	-
Flame resistance	-	-	-	650 °C	750 °C
Temperature range	-	-20 °C to +125 °C Pop-out membranes only.	-30 °C to +70 °C	-40 °C to +80 °C	<ul style="list-style-type: none"> • For normal operation: -40 °C to +80 °C • For a short time: -40 °C to +120 °C
References	See page 304 LVS088●●	See page 301 NSYAECPKFL●●	See page 303 NSYTLK24●●	See page 302 NSYDCE●●●●	See page 301 NSYTSKFL

Simple Cable Entries Overview





• For details enter the reference into the search engine of www.se.com

Characteristics	Simple-1	Simple-2	Simple-3	Simple-4	Simple-5
					
	Mixed membrane entries for enclosure thickness 20/10° - 32/10° mm.	PVC adjustable cone-shaped entries for enclosure thickness 30/10° - 32/10° mm.	Quick cable entries for enclosure thickness 10/10° - 40/10° mm (5/10° - 20/10° mm for ref. IMT36179).	PVC adjustable cone-shaped entries for PG tubes or for enclosure thickness 12/10° - 15/10° mm.	ISO cable gland.
Material	SBS	PVC	EPDM plastic	PVC	PA6 Polyamide, neoprene gasket
Color	RAL 7035 grey or RAL 9010 white	-	Grey cable entries: NCS 5500 Black cable entries: NCS 9000	Black	RAL 7035 grey
Cable entry material	Soft membrane		Combined		
Cable glands to be fitted	Not applicable				
Installation options	On cable gland plate or directly on enclosure				
Flexibility of the installation	Low				
Reversibility	Medium				
Ingress protection rating	IP55 according to IEC 60529	IP55 according to IEC 60529	IP67 according to IEC 60529	IP55 according to IEC 60529	IP68 according to IEC 60529
Cable retention	Low	Low	Medium	Low	High
Cable diameter (mm)	From 20 to 40	From 5 to 87	From 12 to 50	From Ø 13 to Ø 44	From 12 to 40
Cable Installation time	Fast	Fast	Fast	Fast	Slow
Quantity of cables to be fitted for a given surface	+	+	+	+	+
Cable entries for cables with connectors	No	No	No	No	No
Cut-out dimensions (mm)	Various circular hole diameters according to cable diameter				
External dimensions (mm)	From Ø 23 to 44	From Ø 25 to 98	From Ø 12.5 to 50.7	52	From Ø 15 to 46
Certificates	-	-	-	-	-
Standard	-	-	-	-	Compliance with VDE and UL
Flame resistance	750 °C	-	750 °C	-	750 °C
References	See page 305 IMT36●●●/ SM71●●●	See page 305 NSYECPC●●	See page 306 IMT361●●	See page 306 NSYEC●	See page 306 ISM71●●●

10

Characteristics	Synthetic snap-in cable gland	Stainless-steel cable gland with lamellar insert
		
	Without thread. Easy assembly and disassembly. Suitable for walls from 0.5 to 4 mm thick.	Lamellar technology provides excellent resistance to traction as well as excellent torsional protection. For outdoor use, or for aggressive environments.
Material	PA6 Polyamide, neoprene gasket	Stainless-steel AISI 304L or AISI 316L, neoprene gasket
Color	RAL 7035 grey, RAL 7001, RAL 9005. Other colors on demand	-
Cable entry material	Non armoured	Non armoured
Installation options	On cable gland plate or directly on enclosure	
Flexibility of the installation	Low	
Reversibility	Medium	
Ingress protection rating	IP68	IP68
Cable retention	High	High
Cable diameter (mm)	From 16 to 40	From 12 to 40
Cable Installation time	Slow	Slow
Quantity of cables to be fitted for a given surface	+	+
Cable entries for cables with connectors	No	No
Thread type	Metric EN 60423, other types are available on demand	Metric EN 60423
Cut-out dimensions (mm)	Various circular hole diameters according to cable diameter	
External dimensions (mm)	From Ø 22 to 46	From Ø 14 to 43
Certificates	UL recognized (cURus). Rated Type 4X according UL50E	UL recognized (cURus). Rated Type 4X according UL50E
Standard	DIN EN 62444, UL 514B, UL 514B§8.26.7	DIN EN 62444, UL 514
Temperature range	-20 °C to + 100 °C	-20 °C to + 100 °C
References	See page 307, NSYCGSP●●	See page 309 NSYCGX●●●

Technical changes reserved. Information provided without guarantee. Images are for illustrative purposes only.

Characteristics	Multi-cable disc		Cable gland gasket	Blanking plug	Transport plug
					
	The multi-cable bushing permits several cables to be passed through a single cable gland.			It is screwed into the cable gland's plate.	It is installed to block the cable gland during transport or during maintenance operations.
Material	EDPM rubber		EDPM rubber	PA6	PA6
Color	Black		Black	RAL 7035 grey	Black
Ingress protection rating	-		IP68	-	-
Standards	-		-	-	-
Other characteristics	-		-	-	-
Supply	Set of 40 (M16 and M20), 20 (M25 and M32)		Set of 100 (M12 to M20), 50 (M25 and M32), 25 (M40)	Pack of 40 plugs (M12 to M20), 20 plugs (M25 and M32), 10 plugs (M40)	Pack of 40 plugs (M16 to M20), pack of 20 (M25 and M32), pack of 10 (M40)
Ø	Number / Ø (mm)	References	References	References	References
M12	-	-	IMT36151	IMT36161	-
M16	2 x Ø 4	IMT36157	IMT36152	IMT36162	IMT36167
M20	3 x Ø 4	IMT36158	IMT36153	IMT36163	IMT36168
M25	4 x Ø 5	IMT36159	IMT36154	IMT36164	IMT36169
M32	6 x Ø 5	IMT36160	IMT36155	IMT36165	IMT36170
M40	-	-	IMT36156	IMT36166	IMT36171

Key features when selecting a cable entry (1/4)

1



Multiple



Single

Multiple cable entries or single cable entries?

- This choice depends on the number of cables going through the cable entry: Generally, for 3 or more cables, choose a multiple cable entry. This will make your installation faster and more economical.
- In other words, your final costs will not necessarily be lower if you use single cable entry!
- Flexibility of installation: For high flexibility, multiple cable entry is the right choice.

2

Cable entry material

- **Soft membranes** allow cables to be easily pushed through, but still offer a good IP rating and protection from moisture and physical intrusion. Cable retention force, however, is lower than with other alternatives.



Push the membrane into a standard hole.



Make a small hole in the membrane.



Push the cable or tube through the guide hole.



Pull the cable or tube back some 20 mm to lock it.

- **Hard-plastic cable entry plates** require tools to create the opening (drill or knife) but, thanks to the cable gland, they offer a very high retention force. Another use of this solution is for public places, since the hard surface prevents objects being pushed in.

- **Combined:** The material of the cable entry plate is hard-plastic, but the cable is pushed through a soft membrane. In this case you have the advantages of both soft membranes (easy and fast installation, flexibility) and hard-plastic membranes (high retention force when using specific cable clamps).



3



Cable glands to be fitted

- Some multiple cable entries require a cable gland to be able to retain the cables and ensure the degree of protection

Key features when selecting a cable entry (2/4)

4



Installation options

There are 4 ways to install your cable entries on the enclosure:

- **Using a cable entry:**

The standard cable gland plate of your S3D wall-mounted enclosure is unscrewed and replaced by the cable entry. A gasket between enclosure and cable entry will ensure good water and dust tightness.



- **Modifying the standard cable gland plate:**

The standard cable gland plate is unscrewed and machined. A cut-out is made.



- **On cable gland plate adapter:**

This plate, which has the outer dimensions of a standard cable gland plate, has one or more pre-cut cut-outs of standard dimensions (FL13 and FL21).

On steel wall-mounted enclosures, the plate can replace the standard cable gland plate once the cable entry is fitted into it. On polyester enclosures, a cut-out must be created. Schneider Electric provides this service: a precise laser cut-out can be made at the factory upon request.

On steel floor-standing enclosures, you may either use the specific cable gland roof or create a cut-out (see expert's tip 1 - page 299).

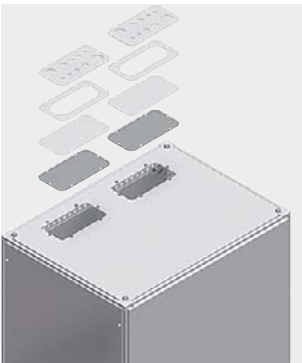

Cable gland plate adapters				
Enclosure range	1 membrane	2 membranes	3 membranes	4 membranes
Spacial S3D	 NSYTL●FL	 NSYTL●2FL	-	 NSYTLG4FL

- **Drilling directly the enclosure:** A cut-out is created on the enclosure's side according to the cable entry's dimensions (see expert's tip 1 - page 299).



Spotlight On...

FL13 and FL21 are standard cut-out dimensions frequently used in northern European countries and also used by our enclosures for several years now.

Key features when selecting a cable entry (3/4)



Full flexibility

5 Flexibility of the installation

- **Full flexibility:** This means that cables can be added/removed easily, changing:
 - quantity
 - diameter
 - position
 (see expert's tip 2, page 299)
- **Medium flexibility:**
 - The amount, diameter or position of cables can be changed to a limited extent.
- **Low flexibility:**
 - It is not possible to change the above parameters.



Medium flexibility

6 Reversibility

- **Full reversibility:** This means that cables can be added/ removed easily without losing their initial characteristics, such as water tightness.
- **Medium reversibility:** For soft membranes, once the cable has been removed, there may be a loss of IP degree depending on the size of the cable and the cut. For hard-plastic entries or combined material entries, initial characteristics are regained by adding plugs.
- **Low reversibility:** The cable entry must be completely replaced in order to regain the initial characteristics.

7 Degree of protection (IP)

- If an enclosure is to be used in a clean, dry and well insulated environment, lower levels of IP may be acceptable (IP54 or IP55).
- In a dusty environment, a higher IP level such as IP65 or IP68 may be required (see expert's tip 4, page 299).

8 Cable retention

- Choose the right level of cable retention according to your needs. For locations accessible to the public, preferably choose a high level of cable retention.

9 Cable diameter

- Choose the cable entry seal according to the cable diameter. Take into account cable diameter tolerances.

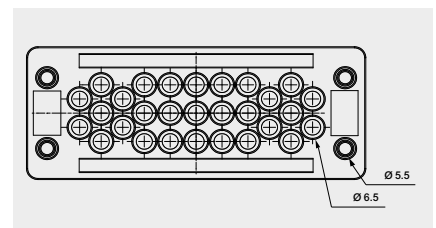
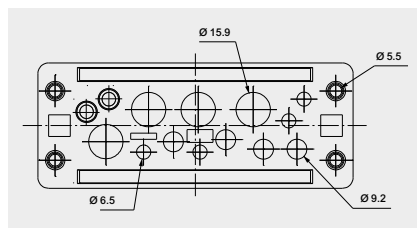

10 Cable installation time

- Each cable entry has different installation characteristics. Some can be installed easily and quickly thanks to the soft membrane. Take this into account depending on labour costs in your region.

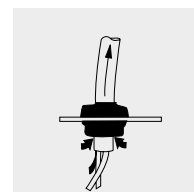
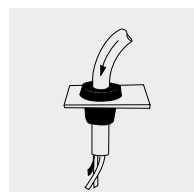
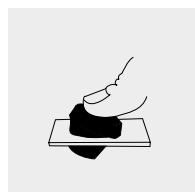

Key features when selecting a cable entry (4/4)



11 Number of cables for a given surface

- For some installations, a large quantity of cables must go through the cable entry. Some cable entries can handle a high density of cables, which can result in a more economical installation (fewer cable entries to be purchased). For small enclosures, it may simply be impossible to install too many cable entries due to the available space on the enclosure's wall (see expert's tip 3, page 299).



12 Cable entries for cables with connectors

- Some cables have large connectors which cannot be pushed through tight cable clamps or cable seals. These cable entries have the unique advantage of not requiring the cable to be cut, thanks to the snap-fitting system.

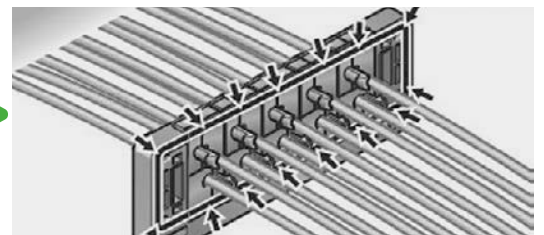
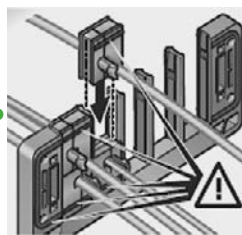
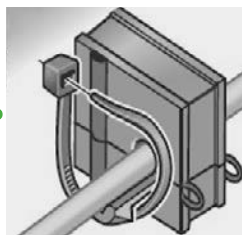
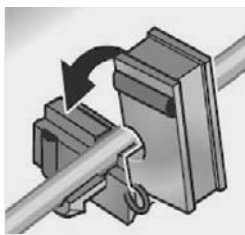

A high cable retention force is provided thanks to the integrated cable fastener

Expert's tip



Specific



Configured



- 1 Some cable entries require cut-outs to be machined on the enclosure or cable gland plate. Our customized offer provides this service. The quality of your enclosure will therefore be improved since the painting operation is performed after creating the cut-outs.

- 2 Installing a cable entry with full flexibility is the solution when a large number of enclosures is being prepared for different types of installations. By using one combination of enclosure cable entries, you can cover a large variety of installations!

- 3 When the cable entry has been defined, the next step is cable management inside the enclosure. For correct thermal management, all cables must be fitted and attached so as not to create an obstacle for correct air flow. Consult our Universal Enclosures catalog for cable management accessories (such as cable ducts) and consumables (such as cable ties).

- 4 If your environment requires a high IP level for your installation, make sure you have an appropriate thermal management system to avoid condensation or overheating problems. Consult our Thermal Management offer in our Universal Enclosures catalog and our Control Panel Technical Guide related to this issue.

FlexiCable cable entries

Mount FlexiCable on your S3D enclosure.



Create a hole with a screw driver.



Push the cable through FlexiCable and complete your installation.



Note:
Details see [page 292](#)

Supply:
1 metal frame with pre-mounted membrane, 1 gasket, fixing hardware



Characteristics	Type	Plate width (mm)	Plate depth (mm)	Effective cable entrance dimensions (mm)	References
FlexiCable cable entries	C	245	130	178 x 63	NSYTLGME
FlexiCable cable entries	D	345	130	278 x 63	NSYTLGME
FlexiCable cable entries	E	445	130	378 x 63	NSYTLGME
FlexiCable cable entries	F	545	130	478 x 63	NSYTLGME
FlexiCable cable entries	G	495	220	428 x 153	NSYTLGME
FlexiCable cable entries for enclosure with 2 cable gland plates	D	345	130	-	2x NSYTLGME
FlexiCable cable entries for enclosure with 2 cable gland plates	E	445	130	-	2x NSYTLGME

Multi-A



Note:
Details see [page 292](#)

Characteristics	Height (mm)	Width (mm)	Depth (mm)	Diameter of the cable entry (Ø mm)								References
				No.	13	14	15	16	18	21	30	
Multi-A Type FL13	20	135	47	7	-	-	4	-	-	3	-	NSYAECPFLA7
Multi-A Type FL13	20	135	47	10	6	-	4	-	-	-	-	NSYAECPFLA10
Multi-A Type FL21	25	215	86	25	-	16	-	-	6	-	3	NSYAECPFLA25
Multi-A Type FL21	25	215	86	33	-	24	-	-	9	-	-	NSYAECPFLA33

10

Multi-C

Position of the holes on the circular cable entries with diameters 50 and 63 mm:

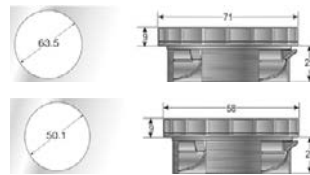

Note:
Details see [page 292](#)

Supply:
10 units.
Reference by unit.
Order by multiples of 10 (10, 20, 30...)



Characteristics	Cut-out Ø (mm)	Diameter of the cable entry (Ø mm)						References
		No.	3-5.5	3-6.5	3.6-6.5	5-9.2	6-10	
Multi-C	50.5	4	-	-	-	3	1	NSYTSAM504SE
Multi-C	50.5	8	-	-	7	1	-	NSYTSAM508SE
Multi-C	63.5	8	-	2	-	4	2	NSYTSAM638SE
Multi-C	63.5	13	6	-	6	1	-	NSYTSAM6313SE

Multi-R

- Material: Polyamide
- Cable entry material: Soft membrane
- Cable glands to be fitted: No
- Installation options: On cable gland plate with special cut-out or directly on enclosure
- Flexibility of the installation: Medium
- Reversibility: Full
- Ingress protection rating: IP55 according to IEC 60529
- Cable retention: Medium
- Cable diameter (mm): From 4.3 to 15.9
- Cable Installation time: Fast
- Quantity of cables to be fitted for a given surface: ++
- Cable entries for cables with connectors: No

- Cut-out dimensions (mm): 112 x 36
- External dimensions (mm): 146 x 14 x 58
- Certificates: UL Certified (UsR)
- Flame resistance: 650 °C

Note:
Dimensions and positions of the holes on a rectangular cable entry see [page 335](#)
Details see [page 292](#)

Supply:
1 unit

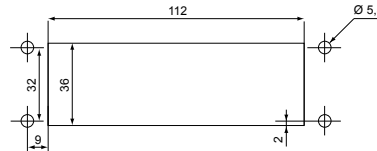

NSYTSA2414SE

Characteristics	Cut-out Ø (mm)	Diameter of the cable entry (Ø mm)					References
		No.	4.3-8.1	3-6.5	5-9.2	8-12.5	
Multi-R	112 x 36	14	-	6	4	-	NSYTSA2414SE
Multi-R	112 x 36	17	-	-	17	-	NSYTSA2417SE
Multi-R	112 x 36	22	-	16	4	2	NSYTSA2422SE
Multi-R	112 x 36	23	23	-	-	-	NSYTSA2423SE
Multi-R	112 x 36	29	-	29	-	-	NSYTSA2429SE

Multi-T

- Type FL21

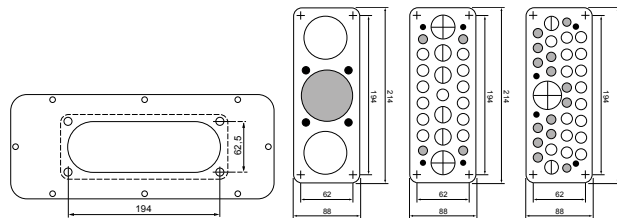

Note:
Details see [page 292](#)



NSYAECPFLT25

Characteristics	Diameter of the cable entry (Ø mm)											References	
	No.	5-7	6-10	8-12	8-16	10-14	12-18	14-20	17-32	20-26	24-54		30-60
Multi-T, metal plate	0	-	-	-	-	-	-	-	-	-	-	-	NSYAECPFLBP
Multi-T	7	-	-	-	4	-	-	-	-	2	1	-	NSYAECPFLT7
Multi-T	27	4	-	4	-	13	-	4	-	2	-	-	NSYAECPFLT25
Multi-T	37	-	4	14	-	16	2	-	1	-	-	-	NSYAECPFLT35

Multi-H

- Type FL21

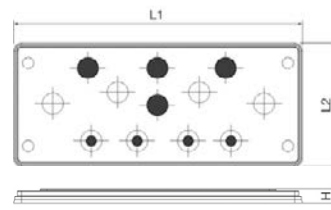

Note:
Details see [page 293](#)



NSYTSAKFL

Characteristics	L1 (mm)	L2 (mm)	H (mm)	Diameter of the cable entry (Ø mm)			References
	M12	M12 or M20	M16 or M25				
Multi-H	10	215	85	4	4	4	NSYTSAKFL

Multi-F

- Type FL13 or FL21
- Diameter of the cable entry 4-10 mm: Pop-out membranes only
- Diameter of the cable entry M16, M20 or M25: Pop-out membranes or cable gland installation
- Diameter of the cable entry M32, M40 or M50: Knock-out system

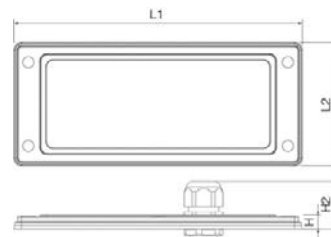

Note:
Details see [page 293](#)



NSYAECPKFL11

Characteristics	Dimensions (mm)				Diameter of the cable entry (Ø mm)					References
	L1	L2	H	H2	4-10	M16 (5-10)	M20 (6-13)	M25 (8-17)	M32, M40 or M50	
MMulti-F FL13	134	52	6.5	~ 35	10	-	1	-	-	NSYAECPKFL11
Multi-F	214	90	9	~ 35	-	2	2	2	1	NSYAECPKFL7A
Multi-F	214	90	9	~ 35	-	4	2	4	-	NSYAECPKFL10

Multi-CR



NSYDCE168



NSYDCE244



NSYDCE2410

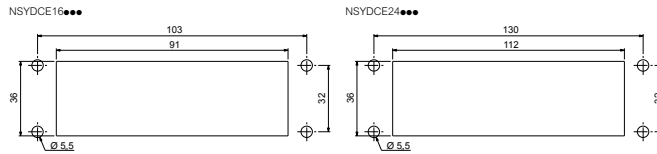

Note:
Details see [page 293](#)

Supply:
1 molded part and fixing elements

Characteristics	Connector cut-out type	Number of cable entries	References
Multi-CR	16	8	NSYDCE168
Multi-CR	24	4	NSYDCE244
Multi-CR	24	10	NSYDCE2410

Split seals for cable entries equipped with connectors



NSYCEJD

- Split seals suited to the diameter of the cable to be mounted on the cable entry molded parts for the connectors. Ref. **NSYDCE●●●**

Supply:
10 units. Reference per unit. To be ordered in multiples of 10 (10, 20, 30, etc.).

Characteristics	For cables Ø (mm)	References
Split seals for cable entries equipped with connectors	0	NSYCEJD
Split seals for cable entries equipped with connectors	3-4	NSYCEJD3
Split seals for cable entries equipped with connectors	5-6	NSYCEJD5
Split seals for cable entries equipped with connectors	7-8	NSYCEJD7
Split seals for cable entries equipped with connectors	9-10	NSYCEJD9
Split seals for cable entries equipped with connectors	11-12	NSYCEJD11
Split seals for cable entries equipped with connectors	13-14	NSYCEJD13
Split seals for cable entries equipped with connectors, large seal, 24/4 die only	16-17	NSYCEJD16
Split seals for cable entries equipped with connectors, large seal, 24/4 die only	18-19	NSYCEJD18
Split seals for cable entries equipped with connectors, large seal, 24/4 die only	20-21	NSYCEJD20
Split seals for cable entries equipped with connectors, large seal, 24/4 die only	22-23	NSYCEJD22
Split seals for cable entries equipped with connectors, large seal, 24/4 die only	24-25	NSYCEJD24
Split seals for cable entries equipped with connectors, large seal, 24/4 die only	26-27	NSYCEJD26
Split seals for cable entries equipped with connectors, large seal, 24/4 die only	28-29	NSYCEJD28
Split seals for cable entries equipped with connectors, large seal, 24/4 die only	30-31	NSYCEJD30

10

Multi-CS

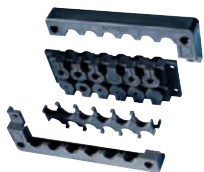

NSYDCC2412

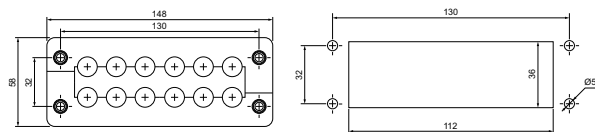

Note:
Details see [page 292](#)

Supply:
1 unit

Characteristics	Cut-out (mm)	No.	Diameter of the cable entry (Ø mm)		References
			2-12	12-24	
Multi-CS	112 x 36	12	12	-	NSYDCC2412
Multi-CS	112 x 36	4	-	4	NSYDCC244
Multi-CS	112 x 36	8	6	2	NSYDCC248
Multi-CS	112 x 36	9	8	1	NSYDCC249

Cable gland



NSYCEJDS2

Supply:

Small plugs: 12 units. Reference per unit.
To be ordered in multiples of 12 (12,24,36, etc.).
Large ... plugs: 4 units. Reference per unit.
To be ordered in multiples of 4 (4,8,12, etc.)

Characteristics	Cable Ø (mm)	References
Cable gland, small	2-3	NSYCEJDS2
Cable gland, small	3-4	NSYCEJDS3
Cable gland, small	4-5	NSYCEJDS4
Cable gland, small	5-6	NSYCEJDS5
Cable gland, small	6-7	NSYCEJDS6
Cable gland, small	7-8	NSYCEJDS7
Cable gland, small	8-9	NSYCEJDS8
Cable gland, small	9-10	NSYCEJDS9
Cable gland, small	10-11	NSYCEJDS10
Cable gland, small	11-12	NSYCEJDS11
Cable gland, large	12-13	NSYCEJDL12
Cable gland, large	13-14	NSYCEJDL13
Cable gland, large	14-15	NSYCEJDL14
Cable gland, large	15-16	NSYCEJDL15
Cable gland, large	16-17	NSYCEJDL16
Cable gland, large	17-18	NSYCEJDL17
Cable gland, large	18-19	NSYCEJDL18
Cable gland, large	19-20	NSYCEJDL19
Cable gland, large	20-21	NSYCEJDL20
Cable gland, large	21-22	NSYCEJDL21

Blanking plugs



NSYCEJDS0

Supply:

Small plugs: 12 units. Reference per unit.
To be ordered in multiples of 12 (12,24,36, etc.).
Large ... plugs: 4 units. Reference per unit.
To be ordered in multiples of 4 (4,8,12, etc.)

Characteristics	References
Blanking plugs, small	NSYCEJDS0
Blanking plugs, large	NSYCEJDL0

Multi-CF



NSYTLK2414



NSYTLK2422

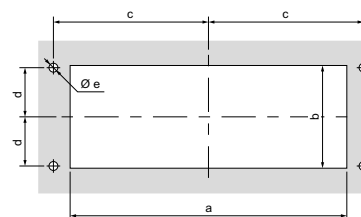

Note:
Details see [page 293](#)

Supply:
1 unit

Characteristics	Diameter of the cable entry (Ø mm)							References
	No.	No. x Ø max.	a	b	c	d	e	
Multi-CF	14	6 x 9 4 x 11 4 x 18	112	36	65	16	5.5	NSYTLK2414
Multi-CF	22	16 x 9 4 x 11 2 x 15	112	36	65	16	5.5	NSYTLK2422
Multi-CF	28	28 x 9	112	36	65	16	5.5	NSYTLK2428
Multi-CF	46	46 x 9	112	36	65	16	5.5	NSYTLK2446
Multi-CF	multi	3 / 27 x 300	112	36	65	16	5.5	NSYTLK24M

PrismaSeT, plain



- Solid cable gland plates

Note:
Details see [page 293](#)

Characteristics	Type	References
PrismaSeT, plain	FL21	LVS08881

PrismaSeT, pre-drilled

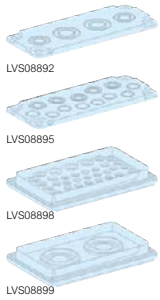

- Suitable for receiving cable glands with metric pitch

Note:
Reference **LVS08898** is made up of:
3 cables with diameters from 14 to 26.
4 cables with diameters from 10 to 20.
32 cables with diameters from 7 to 16.
Details see [page 293](#)

Characteristics	Type	References
PrismaSeT, pre-drilled, with 4 entries 2 x M20 or M32 + 2 x M25 or M40	FL21	LVS08892
PrismaSeT, pre-drilled, with 13 entries 5 x M16 or M25 + 8 x M20	FL21	LVS08895
PrismaSeT, pre-drilled, with 39 entries Ø 7 - 26 mm	opening 225 x 137 mm	LVS08898
PrismaSeT, pre-drilled, with 2 entries Ø 33 - 72 mm	opening 225 x 137 mm	LVS08899

PrismaSeT, membrane

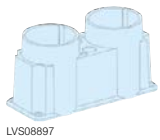

- Membrane to be drilled according to the required diameter

Note:
Details see [page 293](#)

Characteristics	Type	References
PrismaSeT, membrane, 2 entries, 2 x Ø 28 - 60 mm	FL21	LVS08897

Cable clamp for improved cable retention for Multi-A

- Installation on FL 21 membrane type "A" for cable entrance to block cables when installed. It can be easily removed.
- Material: PA6
- Temperature range: -40 to +85 °C

Installation:
1. Push the cable through the membrane entrance to the desired position
2. Put the cable clamp around the cable and slide it into the cable entry
3. Push the cable clamp fully into the membrane entrance and the cable will be fixed

Note:
Secure your installation with an easy solution for cable anchorage.



Characteristics	Cable clamp outer Ø (mm)	Membrane entrance Ø (mm)	Cable Ø range (mm)	References
Set of 8 cable clamps for improved cable retention for Multi-A	15	14	7-9	NSYAECPLACA14
Set of 6 cable clamps for improved cable retention for Multi-A	18	18	9-11	NSYAECPLACA18
Set of 6 cable clamps for improved cable retention for Multi-A	20	18	10-12	NSYAECPLACA20
Set of 3 cable clamps for improved cable retention for Multi-A	30	30	20-23	NSYAECPLACA30

Steel adapter plate for FL13 and FL21 membranes

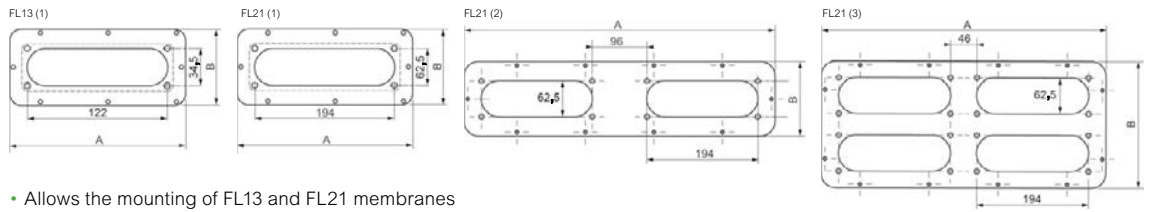

- Allows the mounting of FL13 and FL21 membranes on every type of enclosure.
- Our membrane can be easily adapted to fit onto all our metal enclosures using the adapter plate.
- Ingress protection rating IP55 according to IEC 60529

Supply:
Delivered with fixing screws and gasket



Characteristics	Type	Plate dimensions (mm)		Cut-out dimensions (mm)		References
		A	B	H	I	
Steel adapter plate for FL13 membranes (1)	B	245	80	212	47	NSYTLBFL
Steel adapter plate for FL21 membranes (1)	C	245	130	212	97	NSYTL CFL
Steel adapter plate for FL21 membranes (1)	D	345	130	312	97	NSYTL DFL
Steel adapter plate for FL21 membranes (1)	E	445	130	412	97	NSYTL EFL
Steel adapter plate for FL21 membranes (1)	F	545	130	512	97	NSYTL FFL
Steel adapter plate for FL21 membranes (2)	F	545	130	512	97	NSYTL F2FL
Steel adapter plate for FL21 membranes (1)	G	495	220	462	187	NSYTL GFL
Steel adapter plate for FL21 membranes (2)	G	495	220	462	187	NSYTL G2FL
Steel adapter plate for FL21 membranes (3)	G	495	220	462	187	NSYTL G4FL

Mixed membrane entries for IP55 direct cable entries

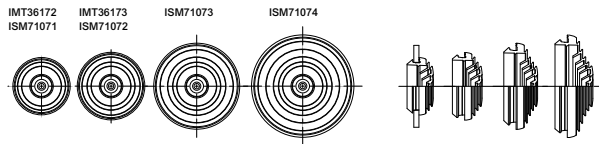

Note:
Details see [page 294](#)

Supply:
Minimal packaging of 10 pieces



Characteristics	Drill hole Ø (mm)	Cable / conduit Ø (mm)	References
Mixed membrane entries for IP55 direct cable entries, RAL 9010	23	4 - 20	IMT36172
Mixed membrane entries for IP55 direct cable entries, RAL 9010	29	4 - 25	IMT36173
Mixed membrane entries for IP55 direct cable entries, RAL 7035	23	4 - 20	ISM71071
Mixed membrane entries for IP55 direct cable entries, RAL 7035	29	4 - 25	ISM71072
Mixed membrane entries for IP55 direct cable entries, RAL 7035	36	4 - 32	ISM71073
Mixed membrane entries for IP55 direct cable entries, RAL 7035	44	4 - 40	ISM71074

PVC adjustable cone-shaped entries

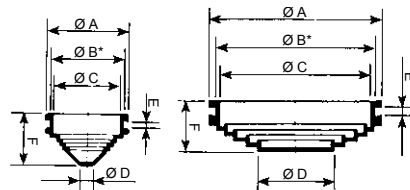

Note:
* Drill-hole for mounting.
Details see [page 294](#)

Supply:
NSYECPC3 50 cable entries,
NSYECPC5 and NSYECPC6
each 25 cable entries,
NSYECPC9 and NSYECPC15
each 10 cable entries



Characteristics	Dimensions (mm)						Capacity		References
	Ø A	Ø B*	Ø C	Ø D	E	F	Cable (Ø mm)	Tube	
PVC adjustable cone-shaped entries	25	21.5	18	5	3.2	13	5-18	PG 9-11	NSYECPC3
PVC adjustable cone-shaped entries	33	29.5	26	5	3.2	20	5-26	PG 9-16	NSYECPC5
PVC adjustable cone-shaped entries	43	38.5	36	5	3.2	22	5-36	PG 9-21	NSYECPC6
PVC adjustable cone-shaped entries	70	63	60	28	3	20	28-60	PG 21-48	NSYECPC9
PVC adjustable cone-shaped entries	98	90	87	28	3	23	28-87	PG 21-48	NSYECPC15

ISO cable gland



ISM71503

- The cable gland (ref. **IMT36150**) is especially recommended for security circuits.

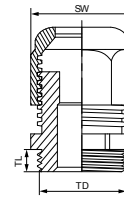

Note:
* In brackets: Tolerance.
Details see [page 294](#)

Supply:
The cable glands are supplied with nuts. Pack of 20 (M12 to M20), 10 (M25 and M32), 5 (M40)

Characteristics	Dimensions						References
	ISO	Cable Ø (mm)	Drill hole* Ø (mm)	TD	TL		
Cable gland	M12	3 / 6.5	12.2 (0 + 0.2)	12	6	15	ISM71501
Cable gland	M16	4 / 8	16.2 (0 + 0.2)	16	8	19	ISM71502
Cable gland	M20	6 / 12	20.2 (0 + 0.2)	20	10	24	ISM71503
Cable gland with high resistance to fire	M20	6 / 12	20.2 (0 + 0.2)	20	10	24	IMT36150
Cable gland	M25	11 / 17	25.2 (0 + 0.2)	25	8	29	ISM71504
Cable gland	M32	15 / 21	32.2 (0 + 0.3)	32	10	36	ISM71505
Cable gland	M40	19 / 28	40.5 (0 + 0.3)	40	10	46	ISM71506

Quick cable entries



IMT36179

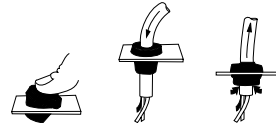

Note:
Details see [page 294](#)

Supply:
50 (M12 to M32), 25 (M40 and M50)

Characteristics	Dimensions			References
	Ø	Drill hole Ø (mm)	Cable Ø (mm)	
Quick cable entries	M12	12.5	3 - 5	IMT36179
Quick cable entries	M16	16	5 - 7	IMT36180
Quick cable entries	M20	20.3	7 - 10	IMT36181
Quick cable entries	M25	25.3	10 - 14	IMT36182
Quick cable entries	M32	32.4	14 - 20	IMT36183
Quick cable entries	M40	40.7	20 - 26	IMT36184
Quick cable entries	M50	50.7	26 - 35	IMT36185

PVC adjustable cone-shaped entries

10



NSYEC7

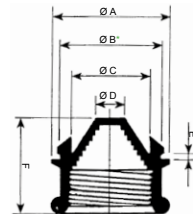

Note:
Details see [page 294](#)

Supply:
25 cable entries

Characteristics	Dimensions (mm)						Capacity		References
	Ø A	Ø B	Ø C	Ø D	E	F	Cable Ø (mm)	Tube	
PVC adjustable cone-shaped entries	52	48.5	44	13	1.5	30	13 to 44	PG 36	NSYEC7

Synthetic snap-in cable gland



NSYCGSP16

- Wall thickness : E = 0.5 à 4 mm.

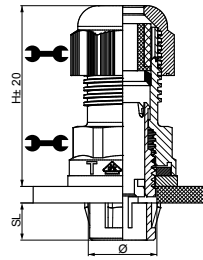

Note:
Details see [page 294](#)

Supply:
The cable glands are supplied with nuts. Pack of 20 (M16 and M20), of 10 (M25 and M32), of 5 (M40)

Characteristics	Dimensions								References
	Ø	Ø min / max	Drill Ø	SL	SD	H			
Synthetic snap-in cable gland	M16	5/10	16.2 to 16.4	9	15.9	42.5	22	NSYCGSP16	
Synthetic snap-in cable gland	M20	6/12	20.2 to 20.4	9	19.9	41.5	24	NSYCGSP20	
Synthetic snap-in cable gland	M25	11/17	25.2 to 25.4	9	24.9	43.5	29	NSYCGSP25	
Synthetic snap-in cable gland	M32	15/21	32.2 to 32.4	9	31.9	49.5	36	NSYCGSP32	
Synthetic snap-in cable gland	M40	19/28	40.2 to 40.4	11.5	39.9	56	46	NSYCGSP40	

Snap-in cable gland disassembling tool

- Tool to quickly disassemble cable gland.
- Material: Plastic



NSYDT16



NSYDT20

Note:
Details see [page 294](#)

Characteristics	Ø	References
Snap-in cable gland disassembling tool	M16	NSYDT16
Snap-in cable gland disassembling tool	M20	NSYDT20
Snap-in cable gland disassembling tool	M25	NSYDT25
Snap-in cable gland disassembling tool	M32	NSYDT32
Snap-in cable gland disassembling tool	M40	NSYDT40

Stainless-steel cable gland with lamellar insert

- Lamellar technology provides excellent resistance to traction as well as excellent torsional protection. For aggressive environments.
- Material: Stainless-steel AISI 304L or AISI 316L, neoprene gasket
- Cable entry material: Non armoured
- Installation options:
 - On cable gland plate or directly on enclosure
- Flexibility of the installation: Low
- Reversibility: Medium
- Ingress protection rating: IP68
- Cable retention: High
- Cable diameter (mm): From 12 to 40
- Cable Installation time: Slow
- Quantity of cables to be fitted for a given surface: +
- Cable entries for cables with connectors: No
- Thread type: Metric EN 60423
- Cut-out dimensions (mm):
 - Various circular hole diameters according to cable diameter
- External dimensions (mm): From Ø 14 to 43
- Certificates: UL recognized (cURus). Rated Type 4, 4X according UL50E
- Standard: DIN EN 62444, UL 514
- Temperature range: -20 °C to + 100 °C



Supply:
The cable glands are supplied with nuts Pack of 5 (M12 and M16), of 4 (M20 and M25), of 2 (M32 and M40)



NSYCGX12

Characteristics	Dimensions						Outer Ø D mm	max. Height H mm	References
	Ø	Ø min-max mm	Thread Length TL mm	SW Cap mm					
AISI 304L	M12x1.5	3.0 - 6.5	6	14	14	15.5	24	NSYCGX12	
AISI 304L	M16x1.5	4.0 - 8.0	7	17	19	21	25.5	NSYCGX16	
AISI 304L	M20x1.5	10.0 - 14.0	8	24	24	26.5	30	NSYCGX20	
AISI 304L	M25x1.5	10.0 - 14.0	8	24	27	30	30	NSYCGX25	
AISI 304L	M32x1.5	13.0 - 18.0	9	30	36	39.8	35	NSYCGX32	
AISI 304L	M40x1.5	18.0 - 25.0	9	41	46	51.4	40.5	NSYCGX40	
AISI 316L	M12x1.5	3.0 - 6.5	6	14	14	15.5	24	NSYCGX12H	
AISI 316L	M16x1.5	4.0 - 8.0	7	17	19	21	25.5	NSYCGX16H	
AISI 316L	M20x1.5	10.0 - 14.0	8	24	24	26.5	30	NSYCGX20H	
AISI 316L	M25x1.5	10.0 - 14.0	8	24	27	30	30	NSYCGX25H	
AISI 316L	M32x1.5	13.0 - 18.0	9	30	36	39.8	35	NSYCGX32H	
AISI 316L	M40x1.5	18.0 - 25.0	9	41	46	51.4	40.5	NSYCGX40H	

SM SMX SF SFX Lower cable-guide cross-rail

- It allows the quick fixing of cables entering and exiting the enclosure.
- Depth adjustable every 25 mm.
- Material: Galvanized steel

Fixing:

- Spacial SF: for suitable enclosures with widths of 1200 and 1600 mm, use the adaptation kit for 2-door suitable enclosures, see [page 270](#)
- Spacial SM: for floor-standing enclosures with a width of 1200 mm, a top/bottom mounting rail installed in central position is required
- Spacial SFX: no adaptation piece is required for the 1200 mm suitable enclosures
- Spacial SMX: no adaptation piece is required for the 1600 mm floor-standing enclosures

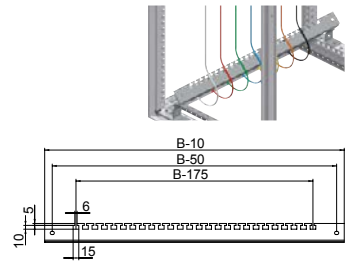

Supply:
1 cable-guide cross-rail and fixing elements



Characteristics	Width (mm)	References
Lower cable-guide cross-rail	600	NSYCFP60
Lower cable-guide cross-rail	800	NSYCFP80
Lower cable-guide cross-rail	1000	NSYCFP100
Lower cable-guide cross-rail	1200	2x NSYCFP60
Lower cable-guide cross-rail	1600	2x NSYCFP80

SM SMX SF SFX Cable-guide cross-rails for framework

- Support types:
- Angle support at 90°: For vertical cable fixing.
 - Angle support at 120°: For fixing cables near the cable entry.
 - Material: Zinc-coated steel

Fixing:

- Spacial SF/SFX: support for direct mounting on the framework, cross-rails or rails
- Spacial SM: fixing on the bottom mounting rail, or on the floor-standing enclosure by means of adaptation rails and 40 mm universal cross-rails (1 row) in vertical position
- Spacial SMX: fixing on the bottom mounting rail and 40 mm universal cross-rails (1 row) in vertical position

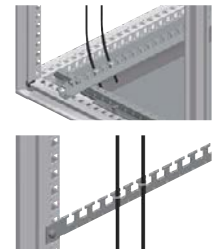

Supply:
2 supports and fixing elements



Characteristics	Support angle	Width (mm)	References
Cable-guide cross-rails for framework	90°	600	NSYCF96
Cable-guide cross-rails for framework	120°	600	NSYCF126
Cable-guide cross-rails for framework	90°	800	NSYCF98
Cable-guide cross-rails for framework	120°	800	NSYCF128

10

SM SMX SF SFX L-rail for fixing cables

- Rail for fixing cables entering from the bottom.
- Adjustable depth with a pitch of 25 mm.
- It is not possible to mount it on a plinth cross-rail.
- Material: Zinc-coated steel

Fixing:

- Spacial SF/SFX: fixing to the bottom frame, above the cable entry, or else to the plinth, using the plinth cross-rails, see [page 124](#)
- Spacial SM/SMX: fixing to the bottom adjustment rails, above the cable entry, or else to the plinth, using the plinth cross-rails, see [page 124](#)
- The cables are fixed to the rail by means of metal clamps

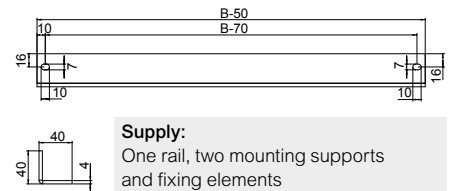

Supply:
One rail, two mounting supports and fixing elements



Characteristics	Width (mm)	References
L-rail for fixing cables	600	NSYFCG60
L-rail for fixing cables	800	NSYFCG80
L-rail for fixing cables	1000	NSYFCG100
L-rail for fixing cables	1200	NSYFCG120
L-rail for fixing cables	1600	NSYFCG160

SM SMX SF SFX Door cable-guide cross-rail

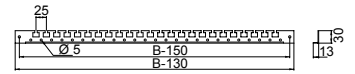

- Recommended for fixing cables in the internal equipment of the door.
- Height adjustable every 25-mm.
- Material: Zinc-coated steel
- Fixing: Direct fixing on the reinforcement frame

Supply:
2 cable-guide cross-rails and fixing elements



NSYSDGCR5

Characteristics	Width (mm)	References
Door cable-guide cross-rail	600	NSYSDGCR5
Door cable-guide cross-rail	600	NSYSDGCR6
Door cable-guide cross-rail	800	NSYSDGCR8
Door cable-guide cross-rail	1000	NSYSDGCR10

Plastic cable support

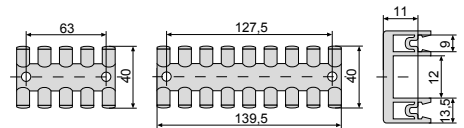

- It clips or screws onto 35-mm symmetric rails or a C-shaped rail.
- Fixing: Quick and easy fixing of cables using cable ties

Supply:
10 units. Reference by unit. Order by multiples of 10 (10, 20, 30...)



NSYSCCDINLG75

Characteristics	Max. no. of cables	Width (mm)	References
Plastic cable support	5	75	NSYSCCDINLG75
Plastic cable support	9	140	NSYSCCDINLG140

CRN S3D S3X Door cable-guide cross-rails for wall-mounted enclosures

- They are installed on wall-mounted enclosures with heights from 400 mm for Spacial S3D and 500 mm for Spacial S3X.
- They make it easy to equip the inside of the door.
- Installation cable ties, see [page 334](#).
- Fixing: They are fixed to the door reinforcement frame by 2 self-tapping screws. The angle can be directed towards the body of the enclosure or towards the door

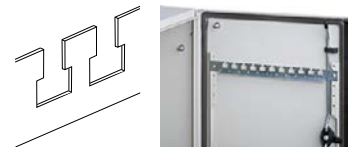

Supply:
2 cable-guide cross-rails and fixing elements



NSYTFPCR4

Characteristics	Width (mm)	References
Door cable-guide cross-rails for wall-mounted enclosures	400	NSYTFPCR4
Door cable-guide cross-rails for wall-mounted enclosures	500	NSYTFPCR5
Door cable-guide cross-rails for wall-mounted enclosures	600	NSYTFPCR6
Door cable-guide cross-rails for wall-mounted enclosures	800	NSYTFPCR8
Door cable-guide cross-rails for wall-mounted enclosures	1000	NSYTFPCR10

10

Thorsman cable ties

Description

- Cable ties are used for a wide range of applications including bundle up and fix cables, conduits and tubing
- Material: PA6.6
- Available in black and clear color
- Max operating temperature -40 °C to +85 °C
- Minimum installation temperature -20 °C.

Application

- There are two types of Thorsman cable ties available: made of clear polyamide, for indoor use
- made of UV-stabilized black polyamide for both indoor and outdoor use

Benefits

- The cable ties are self-locking. They cannot be opened and re-used.
- The cable ties have smooth rounded edges for easier handling and safer installation.
- The rounded tip allows easier insertion through the head of the cable tie.
- User-friendly re-sealable packaging and documented quality.
- Manufactured and tested to EN62275, RoHS compliant.



IMT46026

Characteristics	Type	Length (mm)	Color	Qty per package	References
Thorsman cable ties	2.5 mm	100	Clear	100	IMT46026
Thorsman cable ties	2.5 mm	100	Black	100	IMT46033
Thorsman cable ties	2.5 mm	120	Clear	100	IMT46035
Thorsman cable ties	2.5 mm	120	Black	100	IMT46036
Thorsman cable ties	2.5 mm	160	Clear	100	IMT46074
Thorsman cable ties	2.5 mm	160	Black	100	IMT46073
Thorsman cable ties	2.5 mm	200	Clear	100	IMT46158
Thorsman cable ties	2.5 mm	200	Black	100	IMT46157
Thorsman cable ties	3.6 mm	150	Clear	100	IMT46064
Thorsman cable ties	3.6 mm	150	Black	100	IMT46071
Thorsman cable ties	3.6 mm	200	Clear	100	IMT46149
Thorsman cable ties	3.6 mm	200	Black	100	IMT46156
Thorsman cable ties	3.6 mm	300	Clear	100	IMT46921
Thorsman cable ties	3.6 mm	300	Black	100	IMT46922
Thorsman cable ties	4.8 mm	200	Clear	100	IMT46101
Thorsman cable ties	4.8 mm	200	Black	100	IMT46118
Thorsman cable ties	4.8 mm	250	Clear	100	IMT46918
Thorsman cable ties	4.8 mm	250	Black	100	IMT46968
Thorsman cable ties	4.8 mm	300	Clear	100	IMT46919
Thorsman cable ties	4.8 mm	300	Black	100	IMT46969
Thorsman cable ties	4.8 mm	370	Clear	100	IMT46248
Thorsman cable ties	4.8 mm	370	Black	100	IMT46970
Thorsman cable ties	7.6 mm	300	Black	100	IMT46923
Thorsman cable ties	7.6 mm	380	Clear	100	IMT46286
Thorsman cable ties	7.6 mm	380	Black	100	IMT46293
Thorsman cable ties	8.8 mm	550	Clear	100	IMT46926
Thorsman cable ties	8.8 mm	550	Black	100	IMT46924
Thorsman cable ties	8.8 mm	780	Black	100	IMT46927
Thorsman cable ties	2.5 mm	100	Black	20	IMT46231
Thorsman cable ties	2.5 mm	100	Clear	20	IMT46221
Thorsman cable ties	4.6 mm	200	Black	20	IMT46232
Thorsman cable ties	4.6 mm	200	Clear	20	IMT46222
Thorsman cable ties	4.8 mm	280	Black	20	IMT46233
Thorsman cable ties	4.8 mm	280	Clear	20	IMT46223
Thorsman cable ties	4.8 mm	380	Clear	20	IMT46224
Thorsman cable ties	4.8 mm	380	Black	20	IMT46234

Thorsman accessories



IMT47000



IMT47002



IMT47004

- Self-adhesive base for fixing of cable ties. Available in two sizes, one for max. tie width 3.6 mm and the other for max. tie width 4.8 mm. Both self-adhesive bases use high-end 3M foam. There are additional screw-fix option cradle for fixing cable tie and cable tie with identification and marking tab.
- Material: PA6.6

Characteristics	Type	Dimensions H x W x D (mm)	Color	Qty per package	References
Self-adhesive bases	For max. tie width 3.6 mm	19/19/5.8	Clear	100	IMT47000
Self-adhesive bases	For max. tie width 4.8 mm	28/28/6.4	Clear	100	IMT47001
Cradle	For max. tie width 7.8 mm	22/16/9.6	Clear	100	IMT47002
Cable tie with ID tab	Cable tie with ID tab 100 x 2.5 mm	100/2.5	Clear	100	IMT47004

Technical changes reserved. Information provided without guarantee. Images are for illustrative purposes only.

Corrugated cable tube

- Corrugated tube allowing cable entry between the structure and the door.
- Free from halogens and heavy metals.
- UV protection.
- Material: Low-density polyethylene (LDPE)
- Color: Black

Supply:
One 25 m reel



NSYCPT17

Characteristics	Ø Nominal (mm)	Ø Inner (mm)	Ø Outer (mm)	References
Corrugated cable tube	17	16.6	21.2	NSYCPT17
Corrugated cable tube	29	29	34.5	NSYCPT29
Corrugated cable tube	37	36	42.4	NSYCPT37
Corrugated cable tube	50	47.7	54.5	NSYCPT50

Fixing support for corrugated tube

- Mounting options: Directly on the enclosure, on a 19" swing rack and/or on cross-rails, by means of a fixing point.
- The supports can be assembled with one another to form sets of tubes that allow a better arrangement of the cables.
- It allows the rotation of the tube once it is fixed on the support and prevents the corrugated tube from coming loose if subject to pulling movements.
- Material: Polyamide (PA), black.



Supply:
10 units and fixing elements.
The support is supplied with its cover.



NSYCPTS17

Characteristics	Model (nominal Ø)	References
Fixing support for corrugated tube	17	NSYCPTS17
Fixing support for corrugated tube	29	NSYCPTS29
Fixing support for corrugated tube	37	NSYCPTS37
Fixing support for corrugated tube	50	NSYCPTS50

Spiral cable duct

- Spiral strip for bundling cables.
- Allows cables to enter between the body and the door.
- Color: Colorless

Supply:
One 50 m reel



NSYTC12100

Characteristics	Tightening range (mm)	Ø Inner (mm)	Ø Outer (mm)	References
Corrugated cable tube	12 to 100	9	12	NSYTC12100

Lyre-shaped clamps

- Clip-on clamps designed for direct installation on the 19" racks, Telequick mounting plates and symmetric DIN rails.
- Color: Black

Supply:
10 units. Reference by unit.
Order by multiples of 10 (10, 20, 30...)



AK2LA39

Characteristics	Use	References
Lyre-shaped clamps	For Telequick mounting plates and 19" racks	AK2LA39
Lyre-shaped clamps	For symmetric DIN rail 90 x 2.5 mm cables	AK2LD01
Lyre-shaped clamps	For symmetric DIN rail 75 x 2.5 mm cables	AK2LD02

Steel wired cable tray

- Mounting on the cable supports.
- Dimensions (2 types):
1845 x 200 x 35 mm.
1845 x 200 x 54 mm.
- Material: Zinc-coated steel wire

Supply:
1 vertical steel wired cable tray
and fixing elements



NSYBPC3

Characteristics	Necessary depth (mm)	References
Steel wired cable tray	35	NSYBPC3
Steel wired cable tray	54	NSYBPC5

Cable-duct

- Temperature resistance: -5 ... +60 °C
- Behaviour in fire: Material V0 according to UL 94
- Fire resistance: 960 °C according to IEC 60695-2-1/1
- Maximum capacity of H07.V.K 1.5 mm² flexible cable (filling factor: 0.6)
- With lateral through slots and rear perforations.
- Material: Rigid PVC
- Color: RAL 7030 grey or RAL 5000 blue
- Standards: Compliance with standards VDE 0660/506 and DIN 43659

Supply:
8 units. Supplied in lengths of 2 m



AK2GD7550

Characteristics	Width (mm)	Height (mm)	Color	References
Cable-duct	25	25	Grey	AK2GD2525
Cable-duct	25	50	Grey	AK2GD2550
Cable-duct	37.5	50	Grey	AK2GD3750
Cable-duct	37.5	75	Grey	AK2GD3775
Cable-duct	50	50	Grey	AK2GD5050
Cable-duct	50	75	Grey	AK2GD5075
Cable-duct	75	50	Grey	AK2GD7550
Cable-duct	75	75	Grey	AK2GD7575
Cable-duct	100	75	Grey	AK2GD10075
Cable-duct	125	75	Grey	AK2GD12575
Cable-duct	30	35	Blue	AK2GA33
Cable-duct	30	55	Blue	AK2GA35
Cable-duct	30	90	Blue	AK2GA39
Cable-duct	30	144	Blue	AK2GA315
Cable-duct	60	55	Blue	AK2GA65
Cable-duct	60	90	Blue	AK2GA69
Cable-duct	60	144	Blue	AK2GA615



AK2GA65

Covers for cable-duct

- Temperature resistance: -5 ... +60 °C
- Behaviour in fire: Material V0 according to UL 94
- Fire resistance: 960 °C according to IEC 60695-2-1/1
- Maximum capacity of H07.V.K 1.5 mm² flexible cable (filling factor: 0.6)
- Replacement covers.
- Material: Rigid PVC
- Color: RAL 7030 grey or RAL 5000 blue
- Standards: Compliance with standards VDE 0660/506 and DIN 43659

Supply:
8 units. Supplied in lengths of 2 m



AK2CD75

Characteristics	Width (mm)	Height (mm)	Color	For Cable-duct Ref.	References
Covers for cable-duct	25	25	Grey	AK2GD2525	AK2CD25
Covers for cable-duct	25	50	Grey	AK2GD2550	AK2CD25
Covers for cable-duct	37.5	50	Grey	AK2GD3750	AK2CD37
Covers for cable-duct	37.5	75	Grey	AK2GD3775	AK2CD37
Covers for cable-duct	50	50	Grey	AK2GD5050	AK2CD50
Covers for cable-duct	50	75	Grey	AK2GD5075	AK2CD50
Covers for cable-duct	75	50	Grey	AK2GD7550	AK2CD75
Covers for cable-duct	75	75	Grey	AK2GD7575	AK2CD75
Covers for cable-duct	100	75	Grey	AK2GD10075	AK2CD100
Covers for cable-duct	125	75	Grey	AK2GD12575	AK2CD125
Covers for cable-duct	30	35	Blue	AK2GA33	AK2CA3
Covers for cable-duct	30	55	Blue	AK2GA35	AK2CA3
Covers for cable-duct	30	90	Blue	AK2GA39	AK2CA3
Covers for cable-duct	30	144	Blue	AK2GA315	AK2CA3
Covers for cable-duct	60	55	Blue	AK2GA65	AK2CA6
Covers for cable-duct	60	90	Blue	AK2GA69	AK2CA6
Covers for cable-duct	60	144	Blue	AK2GA615	AK2CA6



AK2CA6

S3D SM SF S3X Ø 22 mm cable-duct support

SFX SDX PLA



- Installed on the door of the wall-mounted or floor-standing enclosure combined with Ø 22 mm elements.
- Material: Treated steel

Characteristics
Ø 22 mm cable-duct support

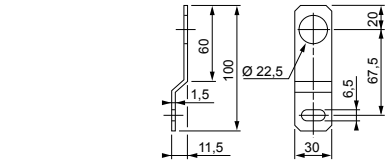

Supply:
10 units. Reference by unit.
Order by multiples of 10 (10, 20, 30...)

References
NSYSPCP

SM SF SD SMX Cable-duct support on technical upright

SFX SDX PLA



- Allows cable ducts to be installed on technical uprights, while increasing the usable surface of the equipment (up to 20% according to the width of the cable duct).
- Material: Galvanized steel

Characteristics
Cable-duct support on technical upright

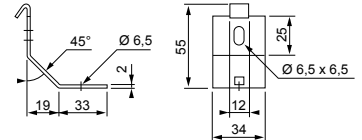

Supply:
10 units. Reference by unit.
Order by multiples of 10 (10, 20, 30...)

References
NSYCDL

Plastic cable-duct support



- Clips onto the Telequick mounting plate or the 35-mm DIN rail.
- Includes a screw for fixing the cable ducts through the 6.5 x 14 mm drill holes made in the back.
- The 2 functions, clipping and bolting, provide considerable time savings.
- Respects electrical insulation.
- Material: Black polyamide. Behaviour in fire: V0 according to UL 94

Characteristics
Plastic cable-duct support

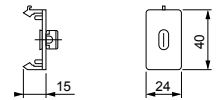

Supply:
20 units. Reference by unit.
Order by multiples of 20 (20, 40, 60...)

References
NSYSPC

Label frame

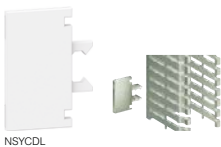

- In transparent plastic, clips onto the slats of the cable ducts.
- Material: Polycarbonate

Characteristics
Label frame

Supply:
50 units. Reference by unit.
Order by multiples of 50 (50, 100, 150...)
Paper labels supplied

References
NSYCDL

Insulated-head screw



- M5 x 10 mm slotted hexagonal head.
- Provides electrical insulation.

Characteristics
Insulated-head screw

Supply:
100 units. Reference by unit.
Order by multiples of 100 (100, 200, 300...)

References
NSYSM10M5HP

Cable-duct support with quick-fixing system



- Fixing mode: By screws - upright location
- Material: Galvanized steel

Characteristics
Cable-duct support with quick-fixing system





Supply:
Set of 3

References
NSYSPCD

Note:
For dimensions see [page 339](#)



Characteristics		Multi-Fixing LED Lamps
		These LED lamps are designed to optimize the life time, consumption, space and accessibility inside the enclosure, they are available with three fixing options as standard.
Color	Black RAL 9005	
Ingress protection rating	IP20 according to IEC60529	
Standards	<ul style="list-style-type: none"> IEC 60598 UL 94: For plastic components UL508A: Control Panel 	<ul style="list-style-type: none"> UL1598: Lamps UL8750: LED for lighting EN55015: EMC
Other characteristics	<ul style="list-style-type: none"> Built-in switch Power consumption: 10 W Frequency: 50/60 Hz Power factor: <ul style="list-style-type: none"> V AC lamps: 0.9 V DC lamps: 1 Luminosity: 640 lm* Light temperature: 4000 K* LED service life: 25000 h* 	<ul style="list-style-type: none"> Casing: Plastic UL94 V-0 Degree of insulation: <ul style="list-style-type: none"> Class I - Lamps with socket Class II - Lamps without socket NSYLAMLDVDC is Class III according to ENEC Certificate Compliant with RoHS and Reach Ambient temperature: <ul style="list-style-type: none"> Operation: -16 °C to +65 °C (-3 °F to +149 °F) Storage: -10 °C to +60 °C (-14 °F to +140 °F) Max. 2 Amps and 5 lamps in serial connection
Connections	<ul style="list-style-type: none"> 3 m power black or orange cable with quick connector (Not supplied. See reference below) 1.5 m interconnection black or orange cable with quick connectors (Not supplied. See reference below) According to the directive IEC 60204-1: <ul style="list-style-type: none"> Black cables: Power circuits for switch or DC voltage. Orange cables: External voltage that may be present even if the cabinet is turned off. 	
Supply	<ul style="list-style-type: none"> 1 lamp and fixing elements 	

Lamp model	Lamps		Cables			
	Socket		Black cables		Orange cables	
		References	Power (3 m) References	Interconnection (1.5 m) References	Power (3 m) References	Interconnection (1.5 m) References
With socket 120 / 230 V AC	SCHUKO 	NSYLAMLDS	NSYLAM3M	NSYLAM1M	NSYLAM3MN	NSYLAM1MN
With socket 120 / 230 V AC	UTE 	NSYLAMLDF	NSYLAM3M	NSYLAM1M	NSYLAM3MN	NSYLAM1MN
With socket 120 / 230 V AC	British 	NSYLAMLDB	NSYLAM3M	NSYLAM1M	NSYLAM3MN	NSYLAM1MN
With socket 120 V AC	USA 	NSYLAMLDU	NSYLAM3MUL	-	NSYLAM3MULN	NSYLAM1MULN
Without socket 120 / 230 V AC	-	NSYLAML	NSYLAM3M	NSYLAM1M	NSYLAM3MN	NSYLAM1MN
Without socket 120 / 230 V AC	-	-	NSYLAM3MUL	-	NSYLAM3MULN	NSYLAM1MULN
Without socket	-	NSYLAMLDD	NSYLAM3M	NSYLAM1M	NSYLAM3MN	NSYLAM1MN
With presence detection 230 V AC	-	-	NSYLAM3MUL	-	NSYLAM3MULN	NSYLAM1MULN
Without socket	-	-	NSYLAM3MUL	-	NSYLAM3MULN	NSYLAM1MULN
Without socket	-	NSYLAMLDVDC	NSYLAM3MDC	-	-	-
Without socket - DC 24-48 V DC	-	-	NSYLAM3MDCUL	-	-	-

Rack for VDI

- 1 U, 19" rack. For lamp installation in VDI enclosures.

Supply:
supplied with fixing elements.



Characteristics
Rack for VDI

References
NSYLAM1U

Fixing options

Fixing by sliding brackets



Magnetic fixing.



Fixing to DIN rail.

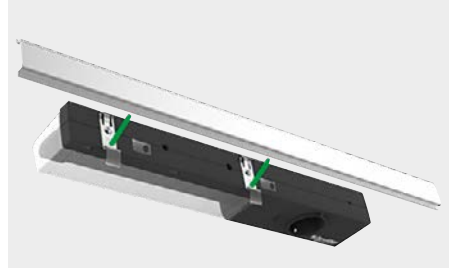

3-pole connectors



NSYLAMACF



NSYLAMDCE



NSYLAMACM



NSYLAMDCEM

- Designed to connect Multi-Fixing LED Lamps.
- Color:
AC: Black
DC: Black (body) and brown (head)
- Ingress protection rating: IP20
- Rated current: 16 A
- Rated voltage: 250 V
- Strain relief: Yes
- Connection type for cabling: Screw connection
- Material: Polyamide
- Dimensions:
Length: 53.2 mm
Width: 23 mm
Height: 13.8 mm

- **Connection data:**
Cable diameter: 9 mm
Cable diameter 2: 5.5 mm
Cross section solid: 2.5 mm²
Cross section solid 2: 0.5 mm²
Connection cross section stranded (max.): 2.5 mm²
Cross section stranded 2: 0.5 mm²

Characteristics	References
3-pole female connectors AC model	NSYLAMACF
3-pole female connectors DC model	NSYLAMDCE
3-pole male connectors AC model	NSYLAMACM
3-pole male connectors DC model	NSYLAMDCEM

Cost-effective LED lamps

- This LED lamp is designed to optimize costs and can be used in almost all enclosures respecting the dimensions. It can be interconnected using a single power source:
 - 5 W lamps: Max. 10 lamps interconnected,
 - 10 W lamps: Max. 5 lamps interconnected.
- Built-in switch
- Light temperature: 4000 K*
- LED service life: 25000 h*
- Casing:
 - Plastic for transparent cover and connectors
 - Aluminum for body
- Degree of insulation: Class I
- Compliant with RoHS and Reach
- Ambient temperature:
 - Operating: -10 °C to +60 °C (-14 °F to +140 °F)
 - Storage: -16 °C to +65 °C (-3 °F to +149 °F)
- Color: Aluminum
- Ingress protection rating: IP20 according to IEC60529
- Standards: IEC 60598

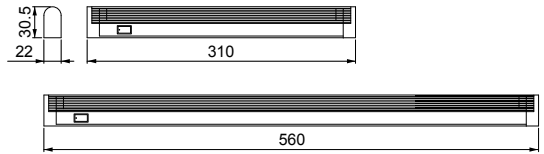

Supply:
 1 lamp and fixing elements
 3 m connection cable with quick connector
 1 m interconnection cable with quick connectors

* Approximate values.



Characteristics	Voltage (V)	Power (W)	Power factor	Frequency (Hz)	Luminous flux (lm)*	References
Cost-effective LED lamps	120/230 V AC	5	0.8	50-60	500	NSYLAMT5LD1
Cost-effective LED lamps	120/230 V AC	10	0.9	50-60	1100	NSYLAMT5LD2
Cost-effective LED lamps	24/48 V DC	5	1	-	470	NSYLAMT5LD1VDC

Portable LED lamp

- This LED portable lamp is designed to be installed as enclosure lamp or maintenance lamp providing mobility, resistance, versatility and durability.
- Double function:
 - internal enclosure lamp,
 - maintenance lamp.
- E27 LED lamp
- Built-in recessed switch
- Light temperature: 4000 K*
- LED service life: 25000 h*
- Power cable 3 m long with male plug (European standard type)
- Casing: Plastic, UL94 V-0
- Degree of insulation: Class II
- Compliant with RoHS and Reach
- Ambient temperature:
 - Operating: -16 °C to +65 °C (-3 °F to +149 °F)
 - Storage: -10 °C to +60 °C (-14 °F to +140 °F)
- Color: Black RAL 9005
- Ingress protection rating: IP20 according to IEC60529
- Standards:
 - IEC 60598
 - UL 94: For plastic components

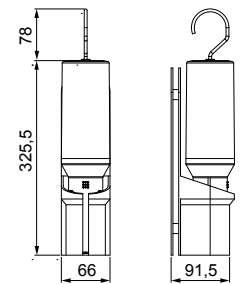

Supply:
 1 lamp with 3 m power cable with European universal plug
 1 fix base
 Fixing elements

* Approximate values.

10



Characteristics	Voltage (V)	Power (W)	Power factor	Frequency (Hz)	Luminous flux (lm)*	References
Portable LED lamp	120/230 V AC	10	0.5	50-60	1100	NSYLAMPORLTD

Fixing options



Possible uses



SM SF SD Transport casters*



- Quick installation on plinths with heights of 100 and 200 mm, except the plinth for enclosure sets.
- They can be installed in front or side position.
- Clipping and fixing to the corner by screws.
- For use on flat surfaces.
- Height: 110 mm
- Maximum load: 200 kg

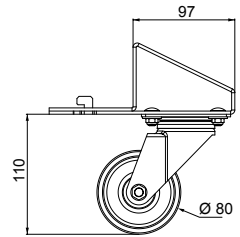

Supply:
4 transport casters
(2 with a blocking system)
and fixing elements

Characteristics
Transport casters

References
NSYSTW

NSYSTW

SM SF SD Enclosure casters

SMX SFX SDX



- Double casters.
- Height: 92 mm.
- Diameter: 64 mm.
- Maximum load:
135 kg per caster
1000 kg when it is installed directly on the upright,
400 kg when it is installed on the frame

Supply:
4 casters and fixing elements

Characteristics
Enclosure casters

References
NSYSW

NSYSW

SM SF SD Levelling feet

SMX SFX SDX



- Height: 42 mm
- Material: Steel
- Maximum load: 400 kg

Supply:
Set of 4 floor feet

Characteristics
Levelling feet fixed

References
NSYSPSJ

NSYSPSJ

SM SF SD Levelling feet

SMX SFX SDX



- Height: 22 mm
- Maximum load: 400 kg

Supply:
Set of 4 floor feet

Characteristics
Levelling feet adjustable

References
NSYSPRJ

NSYSPRJ

SM SF SD Hygienic stainless-steel feet

SMX SFX SDX



- Recommended for applications that require special hygiene conditions.
- Material: 316L stainless-steel
- Installation: Adjustable between 140 mm and 200 mm in height
- Maximum load: 200 kg per foot.

Supply:
Set of 4 hygienic feet

Characteristics
Hygienic stainless-steel feet

References
NSYPHX200

NSYPHX200

S3D S3X Door switch for wall-mounted enclosures



- Switch/commutator unit equipped with support and fixings for direct fixing to the enclosure.
- Can be used to control lighting, air-conditioning units, etc.
- Not compatible with the 19" swing rack and the internal door.
- NC + NO contact, 240 V AC / 3 A.

Supply:
1 door switch and fixing elements

Characteristics	References
Door switch for wall-mounted enclosures	NSYINLCRN

SM SF SFX Door switch for floor-standing enclosures



- The switch is fixed to the structure of the enclosure.
- Drilled M20 cable entry for cable gland.
- NC + NO contact, 240 V AC / 3 A (IEC 60947-5-1) 250 V DC / 0,1 A (IEC 0947-5-1).

Supply:
1 door switch and fixing elements

Characteristics	For ranges	References
Door switch for floor-standing enclosures	SF and SFX	NSYDCM20
Door switch for floor-standing enclosures	SM	NSYDCM20



SF SM Metal document pocket



- Direct mounting on the reinforcement frame of the door.
- Adjustable depth with a pitch of 25 mm.
- Material: Steel
- Finish: Structured finish, epoxy polyester powder
- Color: RAL 7035 grey

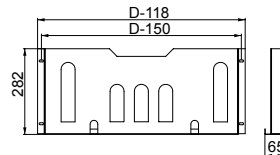

Supply:
1 metal document pocket and fixing elements

Characteristics	Width (mm)	References
Spacial SF/SM Metal document pocket	600	NSYSDP6M
Spacial SF/SM Metal document pocket	800	NSYSDP8M

SF SM Plastic document pocket



- Attachment by adhesive tape.
- Material: Polystyrene (PS)
- Color: RAL 7035 grey (NSYDPA4: RAL 9001)

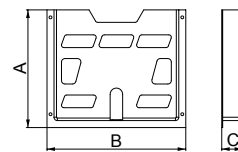

Note:
NSYDPA44 not compatible with 19" chassis or modular distribution.

Supply:
1 plastic document pocket

Characteristics	Doc. format	A (mm)	B (mm)	C (mm)	References
Spacial SF/SM Plastic document pocket	A5	174	188	22	NSYDPA5
Spacial SF/SM Plastic document pocket	A4	230	247	23	NSYDPA4
Spacial SF/SM Plastic document pocket	A4	234	278	40	NSYDPA44
Spacial SF/SM Plastic document pocket	A3	285	476	35	NSYDPA3

SF SM Folding support tray



NSYSDT5

- Adjustable horizontal support for laptop computers, documents or any other element.
- Installation on the reinforcement frame of the door.
- Can also be installed on the door cross-rails.
- 4 positions: 45°, 60°, 75° and 90°.
- Maximum load: 30 kg
- Material: Steel
- Finish: Structured finish, epoxy polyester powder
- Color: RAL 7035 grey

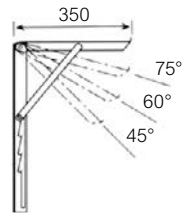

Supply:
1 folding support tray and fixing elements

Characteristics	Width of enclosure (mm)	Width of tray (mm)	References
Spacial SF/SM-Folding support tray	500	325	NSYSDT5
Spacial SF/SM-Folding support tray	600	425	NSYSDT6
Spacial SF/SM-Folding support tray	800	625	NSYSDT8



NSYSDT8

Door cross-rails

- Direct mounting cross-rails on the profiles of the reinforcement frame of the door.
- Adjustable height with a pitch of 25 mm.
- Material: Galvanized steel
- Thickness: 20/10° mm

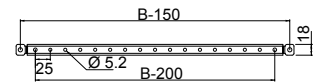

Supply:
2 cross-rails and bag of fixings



NSYSDCR4

Characteristics	Width (B)	References
Door cross-rails	400	NSYSDCR4
Door cross-rails	500	NSYSDCR5
Door cross-rails	600	NSYSDCR6
Door cross-rails	800	NSYSDCR8
Door cross-rails	1000	NSYSDCR10

SM Door retainer for floor-standing enclosure



NSYSMDR

- Door retainer locking the door in open position.
- It is fixed directly to the front frame of them enclosure and to the reinforcement frame of the door.
- It can be installed on doors that open both to the right and to the left.

Supply:
Door stop and fixing elements

Characteristics	Limit	References
Door retainer for floor-standing enclosure	90°	NSYSMDR
Door retainer for floor-standing enclosure, compatible with SFX	90° and 120°	NSYSMNR

SF Door retainer for floor-standing enclosure

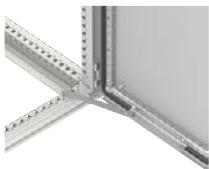

NSYSFMDR

- Door retainer locking the door in open position
- It is fixed directly to the front frame of them enclosure and to the reinforcement frame of the door.
- It can be installed on doors that open both to the right and to the left.

Supply:
Door stop and fixing elements

Characteristics	Limit	References
Floor-standing door retainer	90° and 120°	NSYSFMDR
Floor-standing door retainer	120°	NSYSFNDR

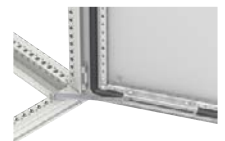

CRN S3D S3X Door retainer for wall-mounted steel enclosure

- Door retainer locking the door in open position
- It is installed on enclosures with heights from 400 mm and widths from 300 mm.
 - Door opening angle: 120°.
 - Earthing connection of the enclosure by means of the reinforcement rail.
 - Earthing accessories supplied with the enclosure (earth-connection cable to be ordered separately), see [page 323](#).
 - Material: Steel

Note:
Cannot be installed on 19" mounting plates or on enclosures equipped with internal door.



Characteristics	References
Door retainer for wall-mounted steel enclosure	NSYAEDRSCST

S3D Door retainer for wall-mounted polyamide enclosure

- Door retainer locking the door in open position
- It is installed on the perforated rails of the enclosure doors at the required height.
 - Material: Polyamide 6 (PA6)

Note:
It is only installed on enclosures with a height of less than 400 mm (no perforated rails).



Characteristics	References
Door retainer for wall-mounted polyamide enclosure	NSYAEDRS3DPA6

Window for modular equipment

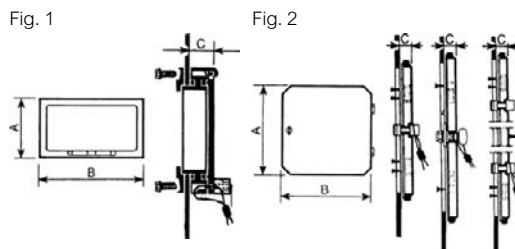

NSYVA2728M



NSYVA2724M

- Material: Transparent polycarbonate

Supply:
1 window

Characteristics	N.° of modules	Fig. n.°	A	B	C	References
Window for modular equipment, Low cover	2	1	78	60	15	NSYVA272M
Window for modular equipment, Low cover	4	1	78	95	15	NSYVA274M
Window for modular equipment, Low cover	6	1	78	130	15	NSYVA276M
Window for modular equipment, Low cover	8	1	78	165	15	NSYVA278M
Window for modular equipment, Low cover	10	1	78	200	15	NSYVA2710M
Window for modular equipment, Low cover	12	1	78	235	15	NSYVA2712M
Window for modular equipment, High cover	2	1	78	60	25	NSYVA272MA
Window for modular equipment, High cover	4	1	78	95	25	NSYVA274MA
Window for modular equipment, High cover	6	1	78	130	25	NSYVA276MA
Window for modular equipment, High cover	8	1	78	165	25	NSYVA278MA
Window for modular equipment, High cover	10	1	78	200	25	NSYVA2710MA
Window for modular equipment, High cover	12	1	78	235	25	NSYVA2712MA
Window for modular equipment, Low cover	16	2	195	165	13	NSYVA2716M
Window for modular equipment, Low cover	24 in 2 rows	2	196	235	13	NSYVA2724M

Plastic window



NSYMW10M

- Plastic window with hinged cover for installation in front panel.
- External dimensions: 213 x 133 mm.
- Internal dimensions of the window: 180 x 78 mm.
- Material:
 - Cover: Polycarbonate
 - Body: PVC

Supply:
1 plastic window delivered with a drilling template

Characteristics	References
Plastic window	NSYMW10M

Plastic window for modular equipment



NSYMW10MK

- Frame with transparent hinged cover for mounting modular switchgear on the front panel.
- Opening: 46 x 180 mm (10 modules).
- Material:
 - Cover: Polycarbonate
 - Body: PVC

Supply:
1 modular front panel

Characteristics	References
Plastic window for modular equipment	NSYMW10MK

Kit for fixing the switchgear



NSYMW10MR

- The unit is delivered assembled.

Supply:
1 DIN rail and two supports.

Characteristics	References
Kit for fixing the switchgear	NSYMW10MR

Mounting example

NSYMW10MK + NSYMW10MR.



Control window

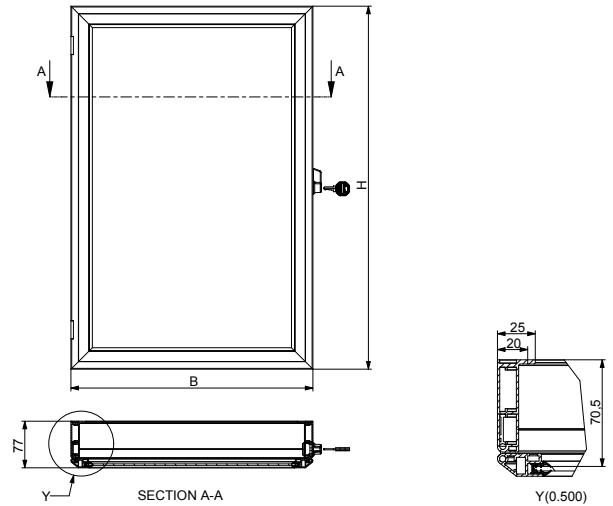

- To prevent accidental operation of the control units by any unauthorised person.
- Allows the displayed information to be read without opening the door.
- Equipped with hinges for opening (180°).
- Locked by a n° 2233X lock.
- Indoor installation.
- Material: Aluminum frame and 3 mm acrylic window

Supply:
1 window, fixings
and instruction sheet



NSYCW33

Characteristics	Dimensions A (mm)	Dimensions B (mm)	References
Control window	300	300	NSYCW33
Control window	400	400	NSYCW44
Control window	400	500	NSYCW45
Control window	400	600	NSYCW46
Control window	500	400	NSYCW54
Control window	500	500	NSYCW55
Control window	500	600	NSYCW56
Control window	600	500	NSYCW65
Control window	600	600	NSYCW66
Control window	800	600	NSYCW86

Earthing strip

- Perforated brass bar, 15 x 3 mm.
- 1 m long.
- 87 connection points, M5 drill holes



Characteristics
Earthing strip

Supply:
1 earthing strip
and fixing elements

References

NSYECB1M153

S3D S3X Fixing lugs for the earthing strip



- They allow the mounting of an earth collector rail or a DIN rail at the top and bottom of an enclosure.
- Mounting incompatible with certain accessories. Please consult us.
- Fixing: On holes made in the gutter of the enclosure.

Characteristics
Fixing lugs for the earthing strip

Supply:
2 lugs and fixings.

References

NSYEDCOS

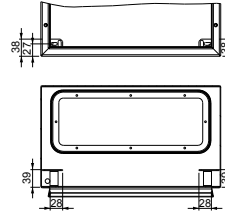

SM SF SD Central earthing point

SMX SFX SDX



- Connects earthing braids and cables to the structure of the enclosure.
- The earth connection is made by means of the M8 x 18 mm screw.
- Fixing: Fixing to the structure by means of self-tapping screws

Characteristics
Central earthing point

Supply:
1 central earthing point, elements
for fixing to the structure,
and fixings for fixing to the screw

References

NSYCEP

Earth braids

- They guarantee the earth connection for high frequencies, avoiding the disturbing electric currents that are produced.
- Material: Tinned copper.



Characteristics	Section (mm ²)	Terminal Ø (mm)	Length (mm)	Width (mm)	References
Earth braids	6	7	150	12	NSYEB156D6
Earth braids	10	6.5	150	17	NSYEB1510D6
Earth braids	16	8.5	155	17	NSYEB1516D8
Earth braids	25	8.5	200	27	NSYEB2025D8
Earth braids	50	8.5	200	33	NSYEB2050D8

Supply:
10 earth braids
(nuts and washers not included)

Earth cables

- Make it easier to install a safe earth connection, with a perfect contact, with optimized length.
- Material: Brass and copper alloy terminal, green and yellow PVC insulated sheath



Characteristics	Section (mm ²)	Terminal Ø (mm)	Length (mm)	References
Earth cables	6	6.4	130	NSYEL136D6
Earth cables	6	6.4	160	NSYEL166D6
Earth cables	6	8.3	160	NSYEL166D8
Earth cables	10	8.3	170	NSYEL1710D6
Earth cables	6	6.4	220	NSYEL226D6
Earth cables	6	13	220	NSYEL226D13
Earth cables	25	8.3	220	NSYEL225D8
Earth cables	10	6.4	250	NSYEL2510D6
Earth cables	25	8.3	350	NSYEL3525D8

Supply:
10 earth cables (nuts and washers
not included). Reference by unit.
Order by multiples of 10
(10, 20, 30...)

Aerosol paint can



NSYBPA7032

- Air-drying paint.
- Content: 150 g.

Note:

Not available for destinations outside Europe.

Characteristics	References
Aerosol paint can, RAL 7032	NSYBPA7032
Aerosol paint can, RAL 7035 grey	NSYBPA7035

Touch-up paint



NSYTUP7032

- Paint for touching up with a brush.
- Air-drying paint.

Characteristics	References
Touch-up paint, RAL 7032	NSYTUP7032
Touch-up paint, RAL 7035 grey	NSYTUP7035

Renovation and anti-graffiti paint

- Paint kit with 2 components (base 80% + hardener 20%)
- Specially designed for polyester enclosures, for their renovation and/or as prevention to allow easy removal of graffiti.
- Color: RAL 7035 grey

Supply: NSYAUPG1G

The 1 kg reference includes 1 pot with 800 g of base paint and 200 g of hardener (It is enough to paint a surface of around 5 m2)



NSYAUPG1G

Characteristics	References
Renovation and anti-graffiti paint	NSYAUPG1G

- Solvent bottles to be used as a paint thinner or to clean brushes.

Supply:
1 kg

Characteristics	References
Renovation and anti-graffiti paint solvent	NSYAUPGS

Plain and silkscreened mounting plates

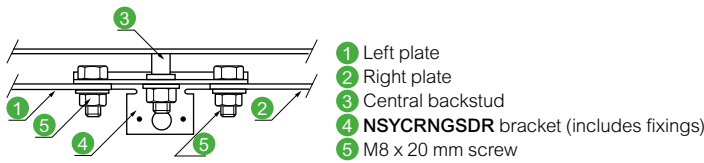
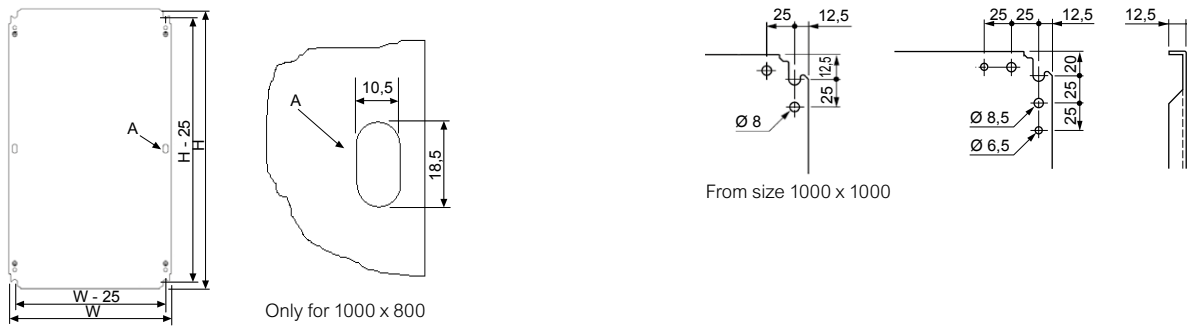

Microperforated mounting plate

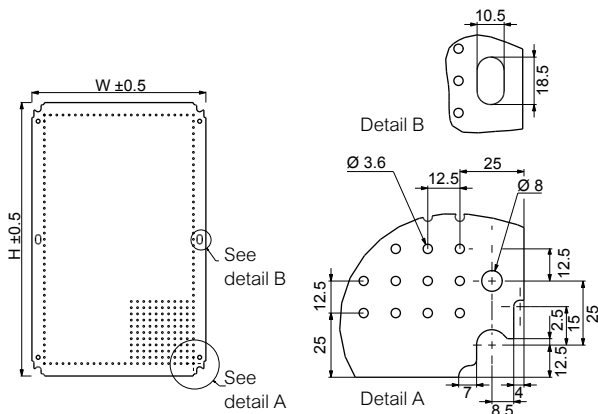

Telequick mounting plate

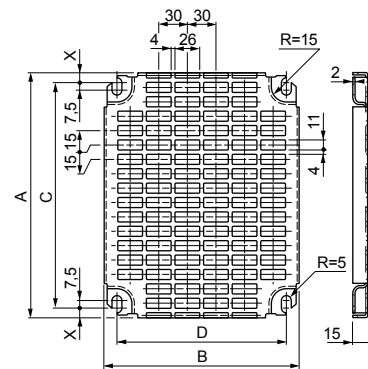

Joinable Telequick mounting plate

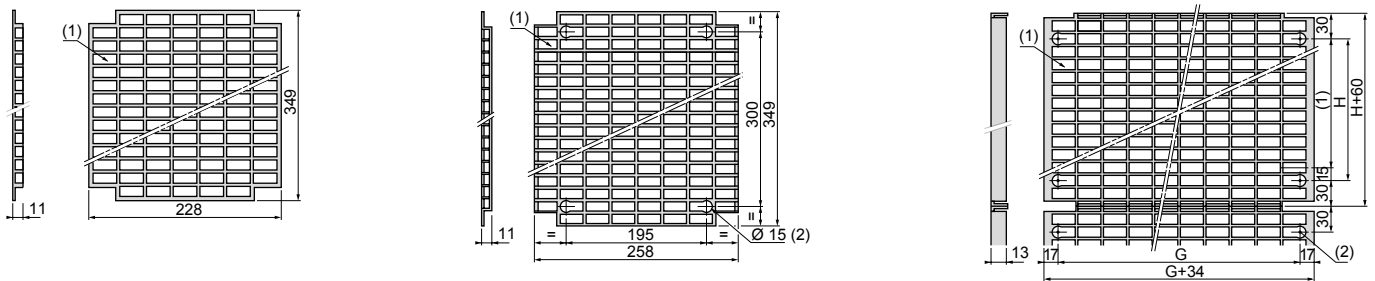

Mounting Plates for Wall-Mounted Enclosures

Dimensions

Bakelite and polyester mounting plate

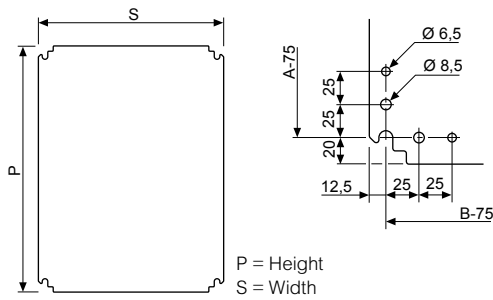

DIN rail chassis

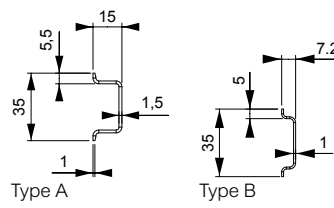

Step slides for mounting plate

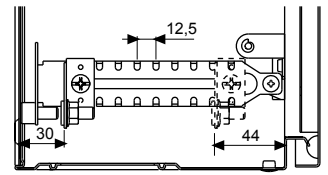

Step slides for 2 mounting plates in one enclosure

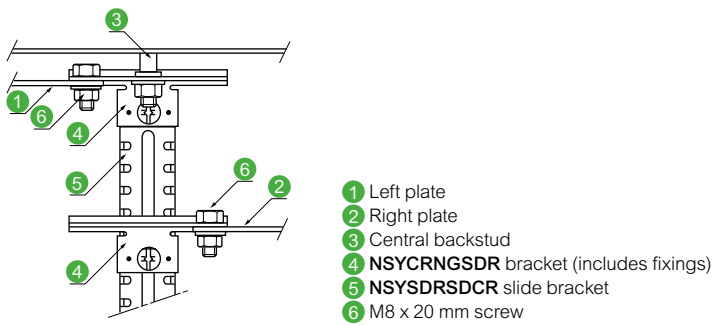

Vertical Rails for Wall-Mounted Enclosures

Dimensions

Slides and brackets

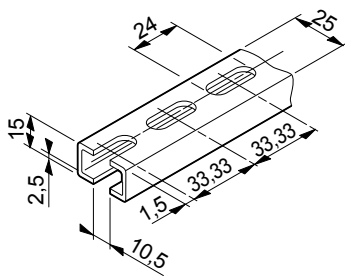

Uprights

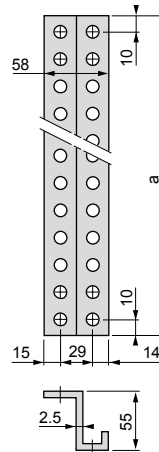

10

Plain mounting plate

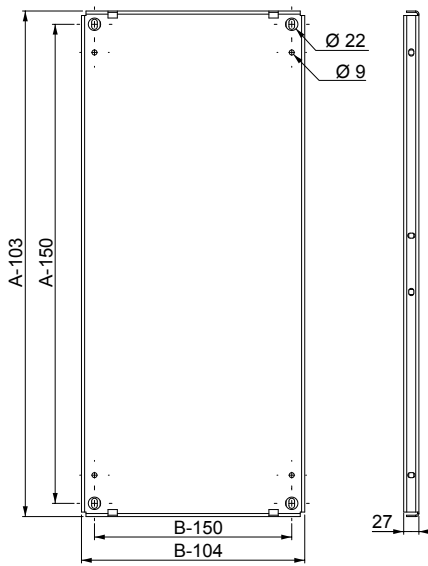

Partial mounting plate

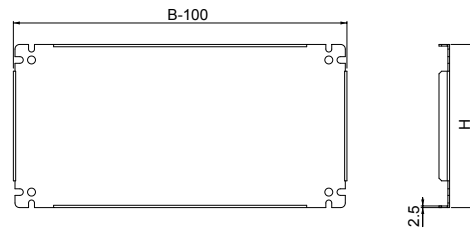

Perforated mounting plate Telequick

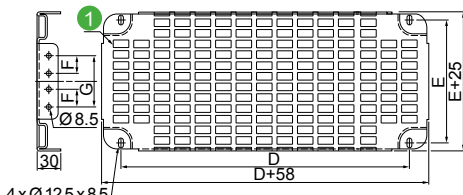

1 Cut-outs 11 x 26 with a pitch of 15 x 30.

Examples of perforated mounting plate installation

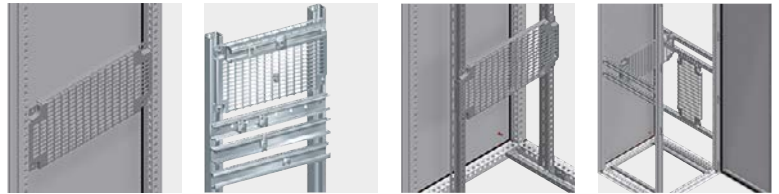

- Perforated plate mounted on structure.
- Perforated plate mounted on technical vertical uprights.
- Perforated plate mounted on standard vertical uprights.
- Perforated plate mounted on cross-rails.

Intermediate mounting plate

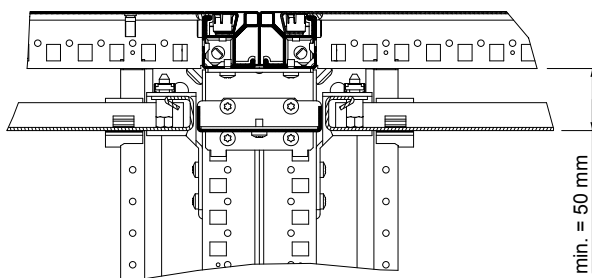

Reinforcement for mounting plate

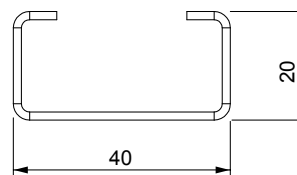

Mounting Plate Brackets for Floor-Standing Enclosures Dimensions

Brackets for fixing mounting plates in back-to-back position

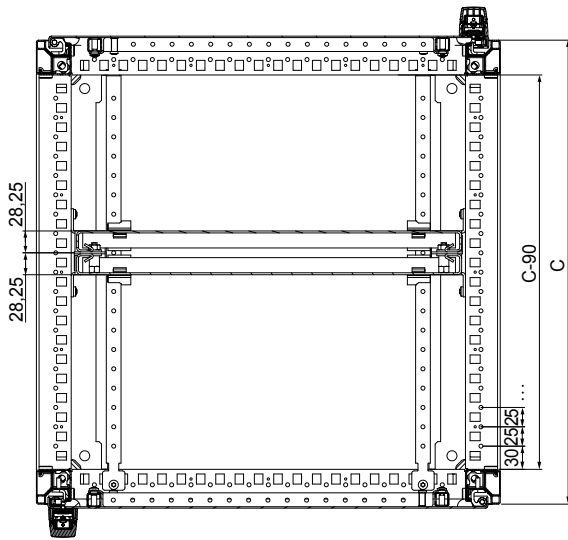

Brackets for fixing intermediate mounting plates in back-to-back position

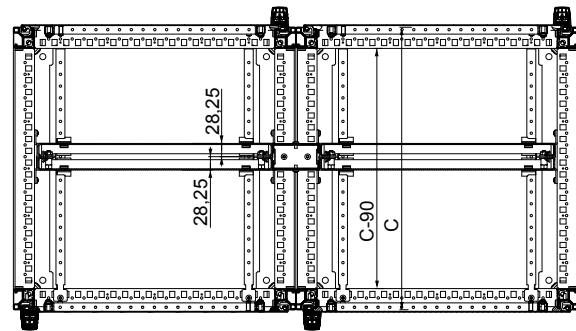

Mounting Plates for Floor-Standing Enclosures Dimensions

Examples of combination

Length of joined Spacial SF enclosures (mm)	Example of Spacial SF enclosure combination width (mm) (B)	Example of combining mounting plates by width (mm)	Useful length (mm)
1200	1200	600 + 800	1192
1400	600 + 800	600 + 1000	1392
1600	2 x 800	800 + 1000	1592
1800	3 x 600	800 + 1200	1792
2000	2 x 1000	1000 + 1200	1992
2200	600 + 2 x 800	1200 + 1200	2192
2400	3 x 800	1600 + 1000	2392
2400	3 x 800	3 x 600 + 1000	2384
2600	2 x 1000 + 600	1600 + 1200	2592
2600	2 x 1000 + 600	3 x 600 + 1200	2584
2800	2 x 1000 + 800	4 x 800	2784
3000	3 x 1000	3 x 800 + 1000	2984
3200	2 x 1000 + 1200	3 x 800 + 1200	3184
3400	3 x 800 + 1000	800 + 3 x 1000	3384
3600	3 x 1200	4 x 1000	3584
3800	800 + 3 x 1000	600 + 3 x 1200	3784
4000	4 x 1000	800 + 3 x 1200	3984

Technical uprights

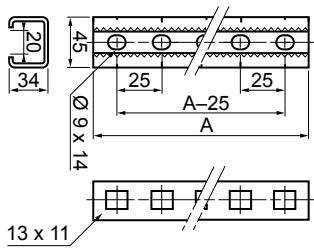

Standard uprights

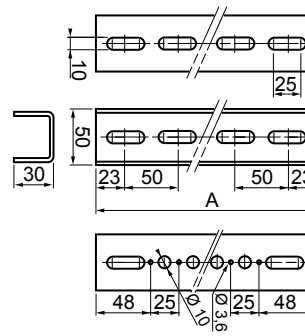

Cross-Rails for Floor-Standing Enclosures

Universal cross-rails

40 mm (1 row)



65 mm (2 rows)

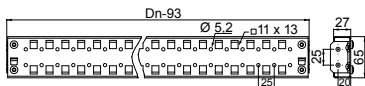

90 mm (3 rows)

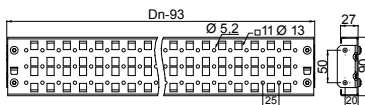

Quick-fixing cross-rails

40 mm (1 row)



65 mm (2 rows)

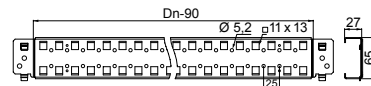

90 mm (3 rows)

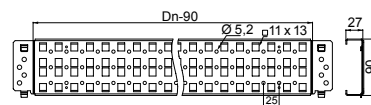

Light cross-rails

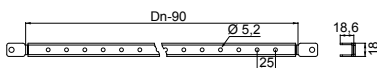

Cross-rail for Lütze chassis

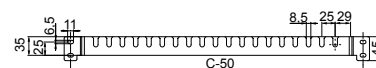

Support for Lütze chassis

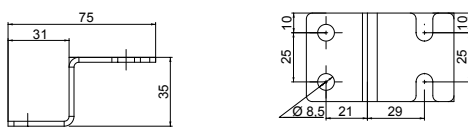

10

Vertical adaptation profiles

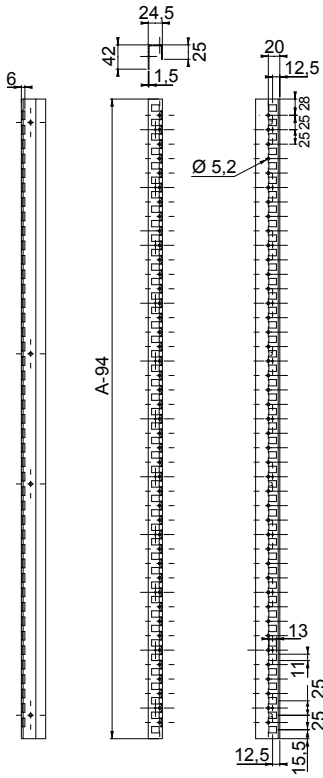

Horizontal adaptation profiles

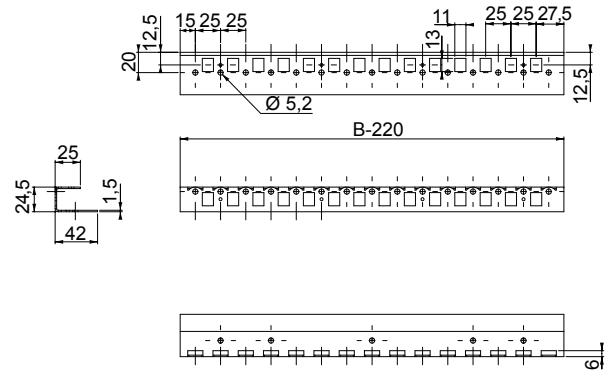

Symmetric mounting rail for wall-mounted enclosures

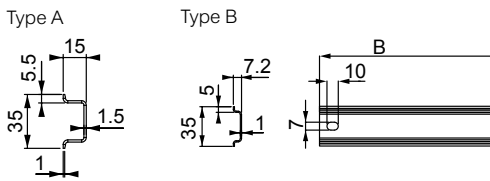

Symmetric DIN rails for floor-standing enclosures

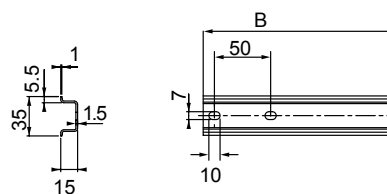

Asymmetric DIN rails for floor-standing enclosures

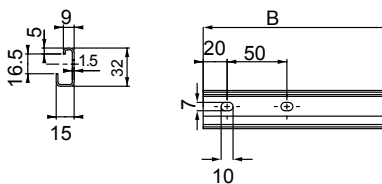

Double-profile DIN rails

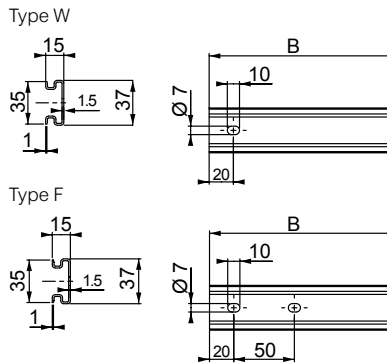

Serrated C-shaped rail for heavy loads

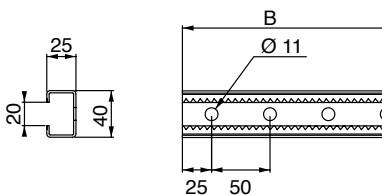

Symmetric C-shaped rails

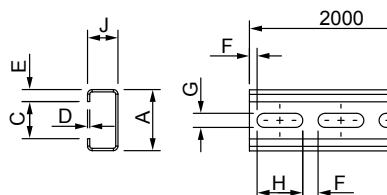

Type	Dimensions (mm)								References
	A	J	C	D	E	F	G	H	
C20 Not perforated	21	11	10	1.5	5.5	-	-	-	NSYCN20
C20	21	11	10	1.5	5.5	5	6.2	15	NSYCNT20
C40 Not perforated	40	20	24	1.5	8	-	-	-	NSYCN40
C40	40	20	24	1.5	8	10	8.5	30	NSYCNT40

Symmetric rails

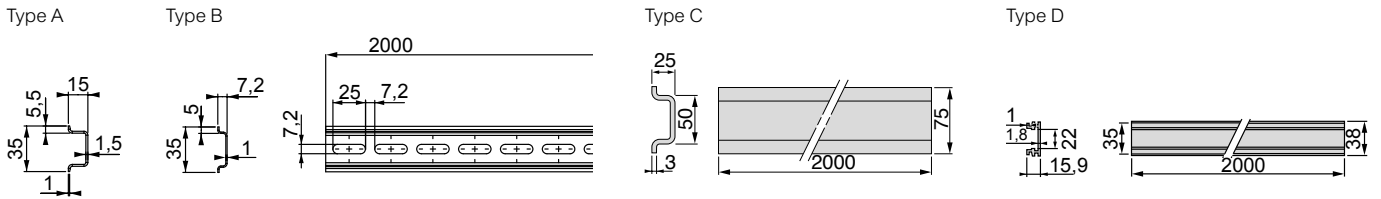

Asymmetric DIN rails

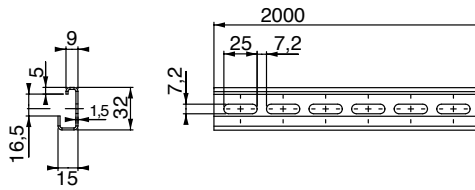

Double-profile DIN rails

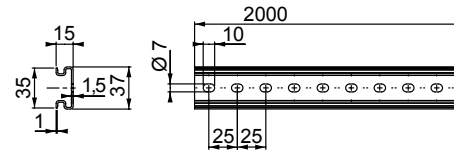

Connectors for Symmetric C-Shaped Rails

Examples



Combinations with connectors for symmetric C-shaped rails

10

EMA connectors

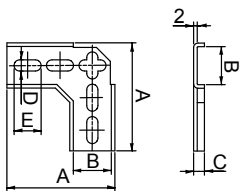

EVA connectors

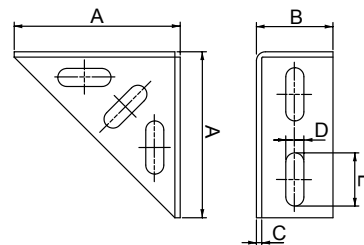

Dimensions (mm)					References
A	B	C	D	E	
60	21.3	6	6.2	15	NSYEMA20
100	40.3	10	8.5	25	NSYEMA40

Dimensions (mm)					References
A	B	C	D	E	
43	19	2	6.2	15	NSYEVA20
78	36	2.5	8.5	25	NSYEVA40

Connectors for Symmetric C-Shaped Rails

UCA connectors

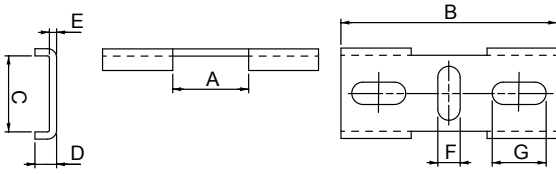

Dimensions (mm)							References
A	B	C	D	E	F	G	
21.3	60	21.3	6	2	6.2	15	NSYUCA22
40.3	116	40.3	10	2.5	8.5	25	NSYUCA44

UTA connectors

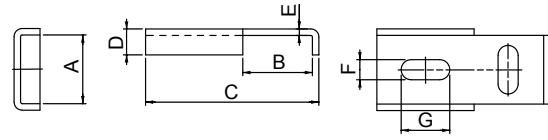

Dimensions (mm)							References
A	B	C	D	E	F	G	
21.3	21.5	53.5	8	2	6.2	15	NSYUTA22
21.3	40.5	72.5	8	2	6.2	15	NSYUTA42
40.3	40.5	81	10	2.5	8.5	25	NSYUTA44

ECA connectors

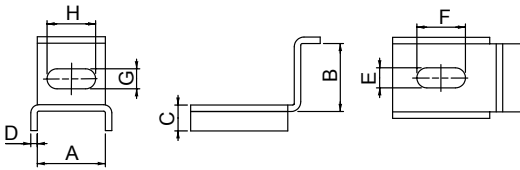

Dimensions (mm)								References
A	B	C	D	E	F	G	H	
21.3	21.5	8	2	6.2	15	6.2	15	NSYECA22
21.3	40.5	8	2	6.2	15	6.2	13	NSYECA42
40.3	40.5	10	2.5	8.5	25	8.5	25	NSYECA44

UR connectors

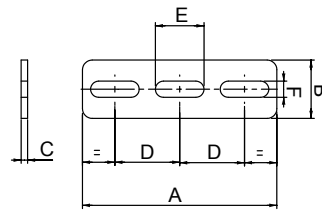

Dimensions (mm)						References
A	B	C	D	E	F	
60	18	2	20	15	5	NSYUR20
130	36	3	40	30	10	NSYUR40
130	55	3	40	30	10	NSYUR60

UT connectors

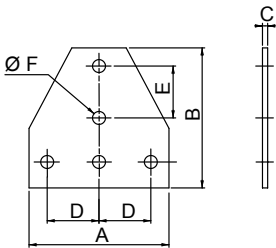

Dimensions (mm)						References
A	B	C	D	E	F	
54	54	2	20	20	5	NSYUT20
60	80	2	20	25	8	NSYUT40
80	110	2	20	29	10	NSYUT60

EN connectors

NSYEN20

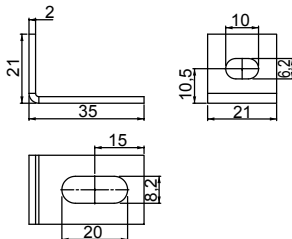

NSYEN40

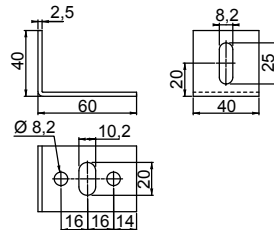

NSYEN60

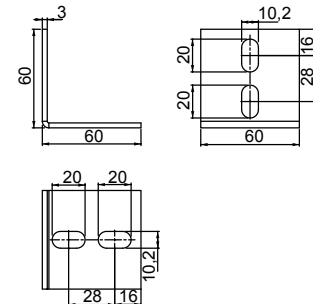

Technical changes reserved. Information provided without guarantee. Images are for illustrative purposes only.

Mounting Spacers

Dimensions

Hexagonal spacers

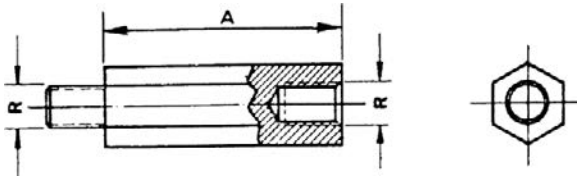

ETU modular spacers

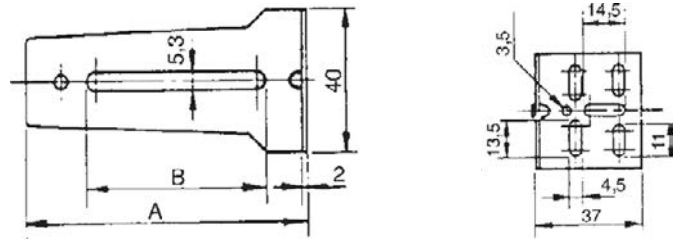

Dimensions (mm)		Combination of spacers
Minimum height	Maximum height	References
53	53	NSYETU48 + NSYETU48
63	63	NSYETU48 + NSYETU58
85	85	NSYETU48 + NSYETU79
124	124	NSYETU48 + NSYETU118
73	73	NSYETU58 + NSYETU58
94	94	NSYETU58 + NSYETU79
134	134	NSYETU58 + NSYETU118
84	84	NSYETU79 + NSYETU79
124	124	NSYETU79 + NSYETU118
164	164	NSYETU118 + NSYETU118

Cable Management – Cable Entries

Dimensions

Multi-C

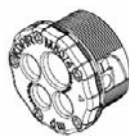

NSYTSAM504SE

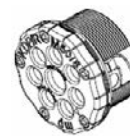

NSYTSAM638SE



NSYTSAM508SE



NSYTSAM6313SE

Position of the holes
on the circular cable entries
with diameters 50 and 63 mm

Multi-R

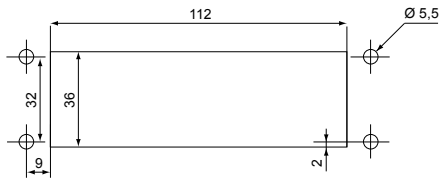

Diagrams of dimensions and positions of the holes on a rectangular cable entry

NSYTSA2414SE

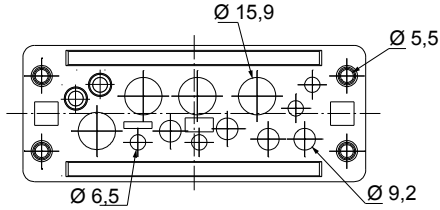

NSYTSA2417SE

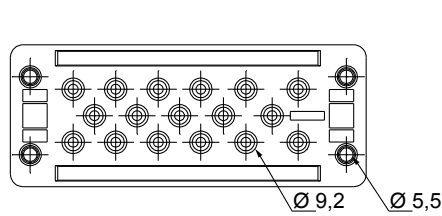

NSYTSA2429SE

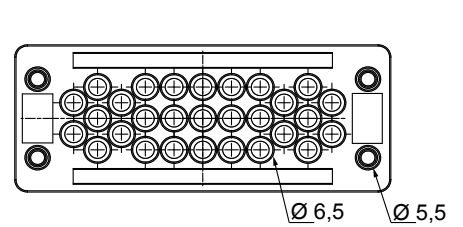

NSYTSA2422SE

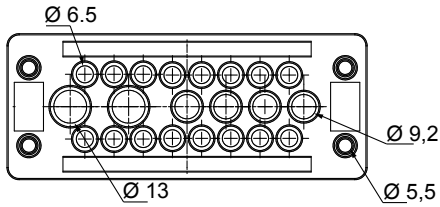

NSYTSA2423SE

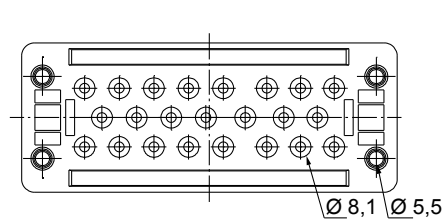

Multi-T

NSYAECFLBP

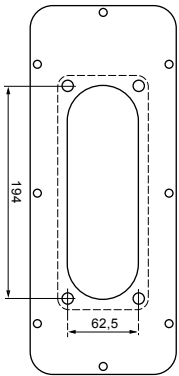

NSYAECFLT7

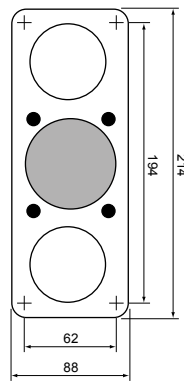

NSYAECFLT25

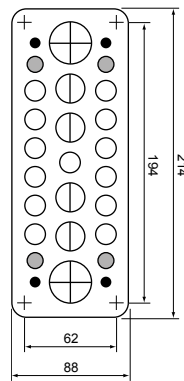

NSYAECFLT35

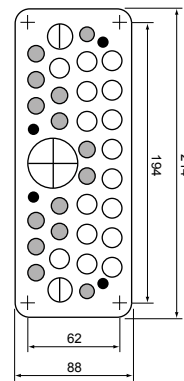

Multi-H

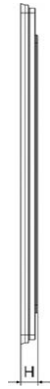
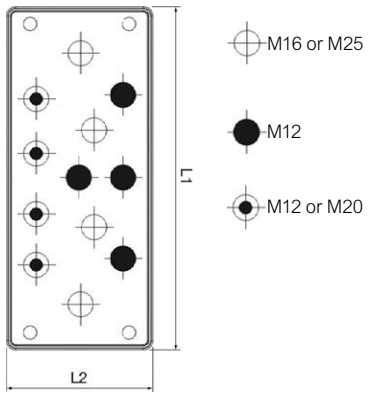

Multi-F

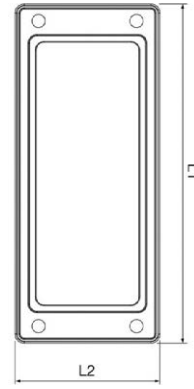

Multi-CR

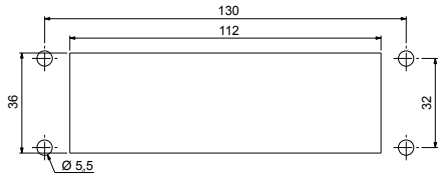

Cut-out for reference NSYDCE24●●●

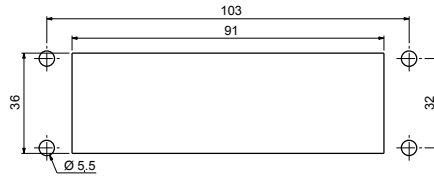

Cut-out for reference NSYDCE16●●●

Multi-CS

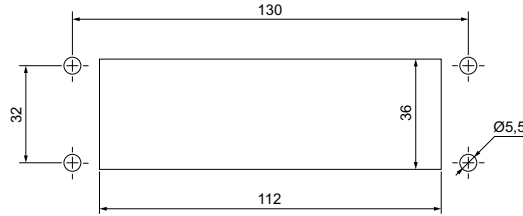
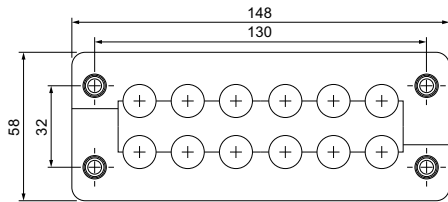

10

Multi-CF

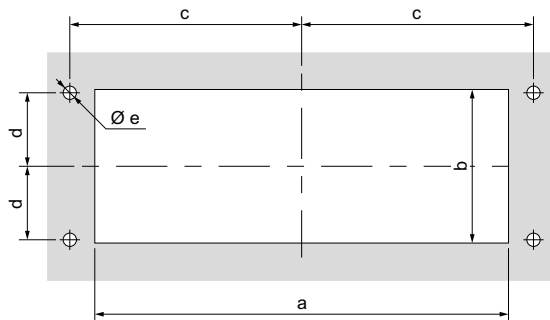

Steel adapter plate for FL13 and FL21 membranes

Application example

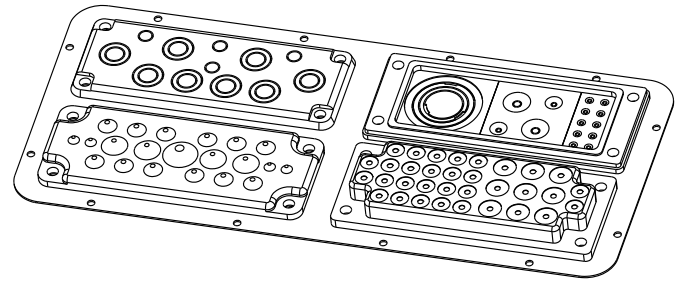
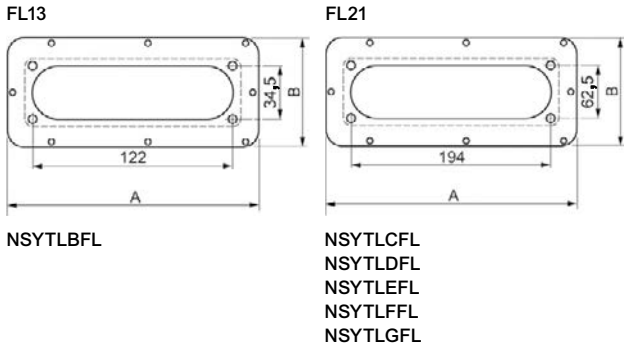

Our membrane can be easily adapted to fit onto all our metal enclosures using the adapter plate.

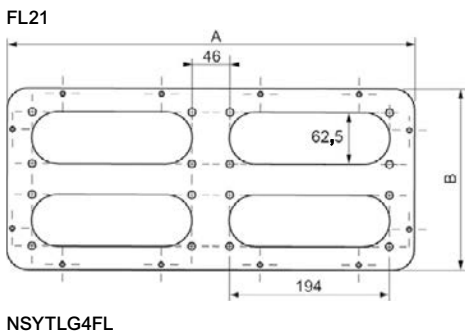
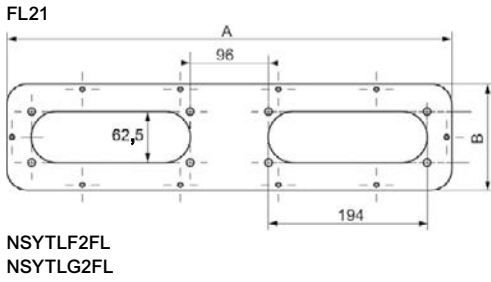

Lower cable-guide cross-rail

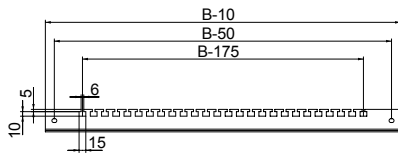

L-rail for fixing cables

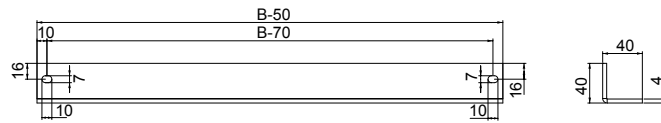

Door cable-guide cross-rail

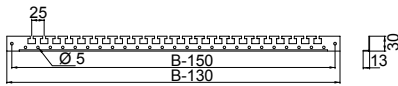

Plastic cable support

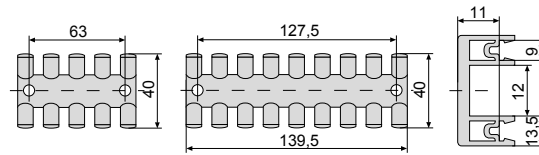

Door cable-guide cross-rails for wall-mounted enclosures

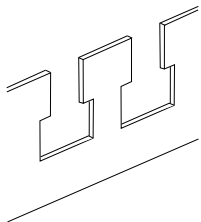

Ø 22 mm cable-duct support

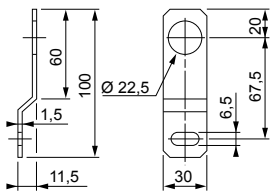

Cable-duct support on technical upright

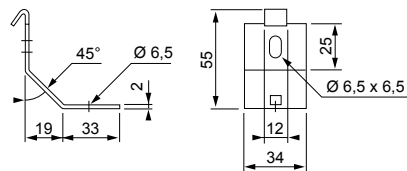

Plastic cable-duct support

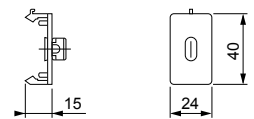

Technical changes reserved. Information provided without guarantee. Images are for illustrative purposes only.

Multi-Fixing LED Lamps

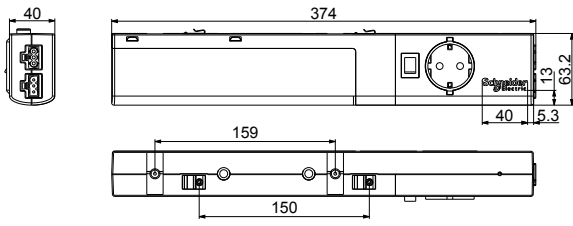

Fixing options

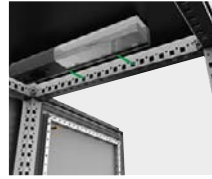

Fixing by sliding brackets



Magnetic fixing.



Fixing to DIN rail.

Cost-effective LED Lamps

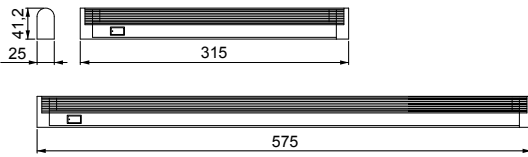

Fixing options



Magnetic fixing



Fixing by adapter brackets

Portable LED lamp

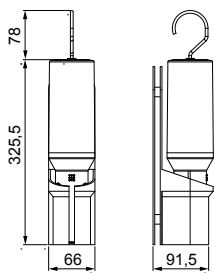

Possible uses



Fixing by adhesive or by screws



Used on workbench

Casters and Feet for Floor-Standing Enclosures

Transport casters only for Spacial SM, SF and SD

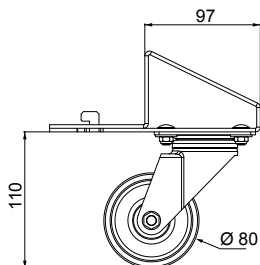

Door accessories - plastic document pocket

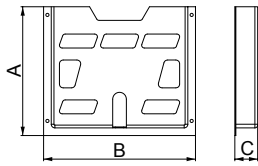

Door accessories - metal document pocket

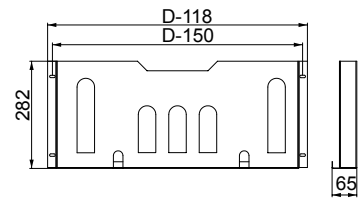

Door Accessories for Floor-Standing Enclosures

Folding support tray

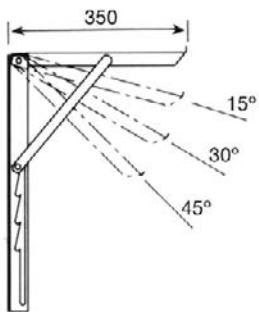

Door cross-rails

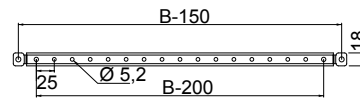

Window for modular equipment

Fig. 1

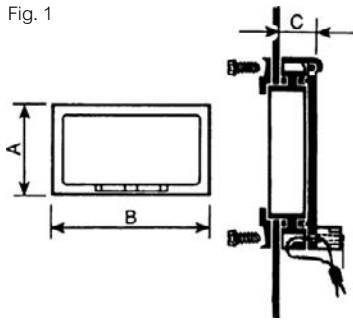
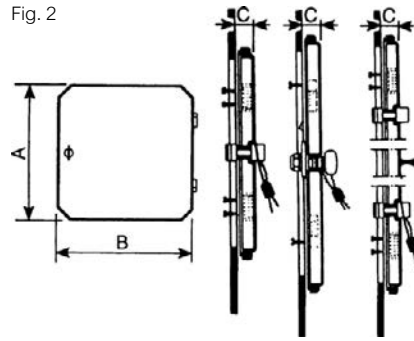

Fig. 2



Plastic window for modular equipment

Mounting example



NSYMW10MK + NSYMW10MR.

Control window

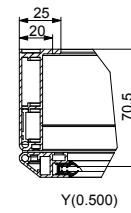
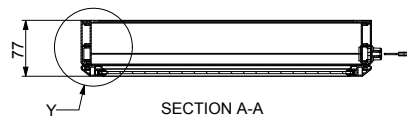
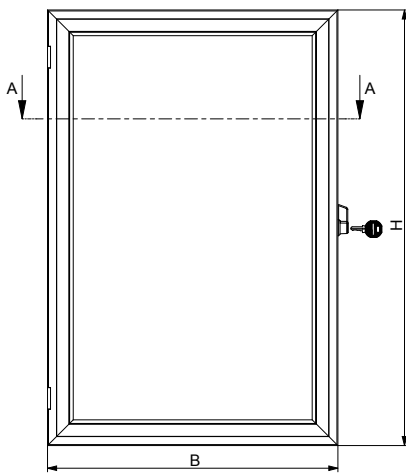

Other Accessories - Earthing Accessories

Fixing lugs for earthing strip

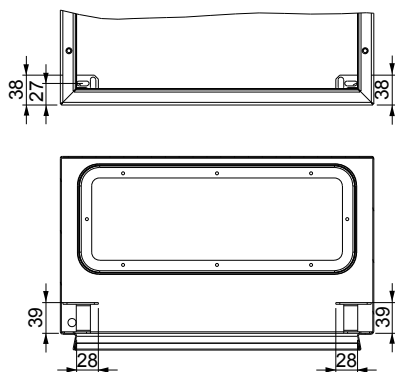

Applicative Solutions



11

Contents

Solutions for electrical distribution	344
Terminal blocks	344
Modular wall-mounted enclosures	347
Accessories for modular floor-standing enclosures	351
Accessories for low-voltage switchboards	358
PrismaSeT functional system	382
Solutions for Motor Control Centers	402
Outdoor Heavy-Duty enclosures	434
Thalassa PLM landscape enclosures	448
Seismic and nuclear enclosures	450
Electronic applications	468
Steel enclosures with protection against electromagnetic interference (EMC)	488
Enclosures for explosive atmospheres (ATEX)	496
Human-Machine Interface Control enclosure, PC racks and control desks	504
Variable-speed drive flush-mounting kits	540
Automotive applications	544

The **Spacial S3DB** enclosure is made to be equipped with terminal blocks. It is ready to be equipped with a ladder mounting plate and a symmetrical DIN rail (to be ordered separately). The body does not have cable gland openings. The Spacial S3DB enclosure is the ideal coupling enclosure with FL21 cut-outs.

Spacial S3DB



Vertical position

Horizontal position

11



Safe

Welded studs on door and body
(earth cables to be ordered separately).



Smart

Example of installation with the ladder mounting plate.

Spacial S3DB

Body

Single-piece body, folded and welded. Front rail with double sheet thickness, guttershaped.

- Depth 150 mm
- The terminal enclosure can be installed vertically (width becoming height, and vice versa)
- Wall-mounted directly or by means of fixing lugs (to be ordered separately).
- 4 M8 x 25 shouldered backstuds.
- Body without cable gland openings.

Door

- Easily removable and reversible door, with 20 mm return with double sheet thickness granting excellent rigidity; equipped with 2 hinges opening to 180°.
- Door opening to more than 180° for maximum accessibility (the door comes to rest on the body of the enclosure in top position).
- Maximum acceptable load on the door: 20 kg/m².
- Wall-mounted enclosure supplied with 3-mm double-bar lock as standard.
- M6 x 16 earthing screw for equipotential connection between the door and the body of the enclosure.

Dedicated accessories

The terminal enclosure, with a depth of 150 mm, can be equipped:

- With 2 rails to be installed on the 4 M8 x 25 shouldered backstuds. See [page 17](#).
- With a symmetrical rail to be installed on the rails.
- With a 6 mm² earth braid to be placed between the body and the door.
- It can also be equipped with a plain mounting plate, see [page 260](#).
- Finish: Structured finish, epoxy polyester powder
- Color: RAL 7035 grey
- Ingress protection rating: IP66 according to IEC 60529
- Mechanical protection rating: IK10 according to IEC 62262

For more details see [page 346](#)



NSYS3DB25315

Characteristics	Height (mm)	Width (mm)	Depth (mm)	References
Spacial S3DB	250	300	150	NSYS3DB25315
Spacial S3DB	250	400	150	NSYS3DB25415
Spacial S3DB	250	500	150	NSYS3DB25515
Spacial S3DB	300	300	150	NSYS3DB3315
Spacial S3DB	300	400	150	NSYS3DB3415
Spacial S3DB	300	500	150	NSYS3DB3515
Spacial S3DB	300	600	150	NSYS3DB3615
Spacial S3DB	400	300	150	NSYS3DB4315
Spacial S3DB	400	800	150	NSYS3DB4815
Spacial S3DB	500	400	150	NSYS3DB5415
Spacial S3DB	600	400	150	NSYS3DB6415

Enclosures for Power Distribution, Terminal Blocks Spacial S3DB - S3DBFL

Spacial S3DB

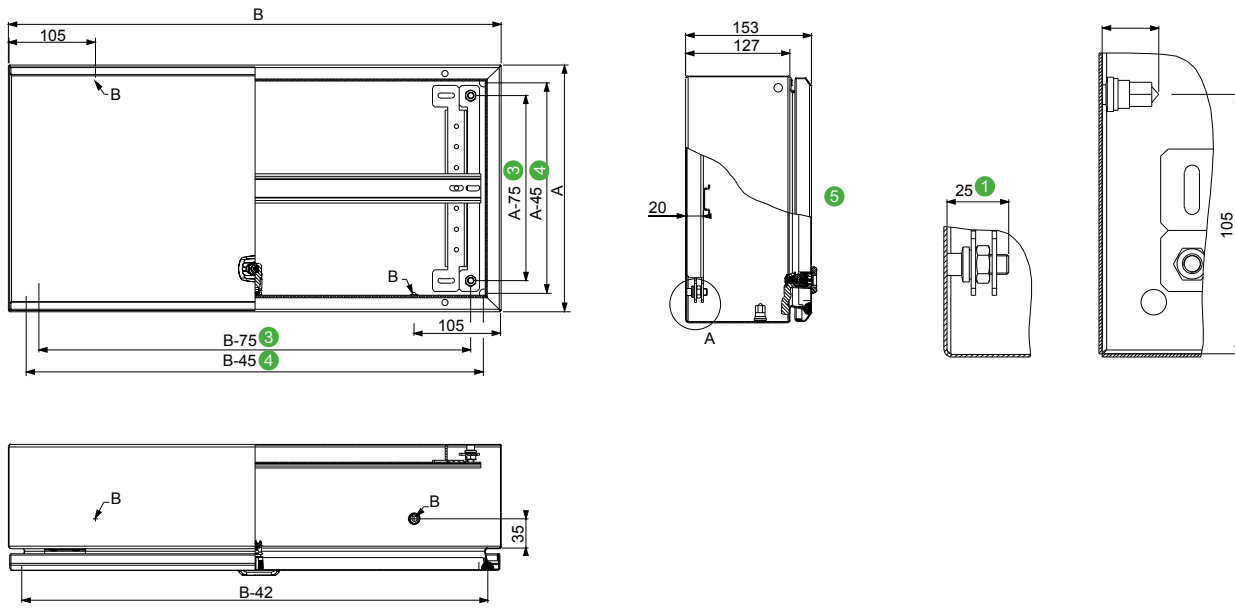

A: Enclosure height
B: Enclosure width
C: Enclosure depth

- ① With ladder mounting plate installed.
- ② M6 x 17.5 mm earthing stud.
- ③ Stud center-to-center distance.
- ④ Center-to-center distance of the holes for direct fixing.
- ⑤ Drop-leaf door.

The dimensions provided include the ladder mounting plate which is the most commonly used accessory with this enclosure.

The **Spacial S3DM** enclosure for modular switchgear can be equipped with:

- a modular chassis (**NSYDLM...**) with cut-out front panels for 24 to 234 modules according to the dimensions and references,
- a 6 mm² earth connection placed between the body and the door.

The enclosure can be equipped with accessories from the Spacial standard wall-mounted range.

Spacial S3DM



S3DM enclosure (standard delivery).



S3DM enclosure equipped with a DLM modular chassis.



Easily removable and reversible door

- With 20 mm return with double thickness granting excellent rigidity, opening to 120°, equipped with 2 or 3 invisible hinges.
- Three locking points for heights of more than 600 mm.
- Perforated rails on the hinge side of the door, with drill holes with a diameter of 4.2 mm in steps of 25 mm.



Dedicated accessories

- The DLM modular chassis consists of metal cut-out front panels which can clip on with any screws. Rigid structure made from galvanized steel. The depth of the chassis can be adjusted from 40 to 85 mm between the rail and the front panel, allowing the installation of all types of devices.
- For enclosures with a depth of 150 mm, the chassis can be installed at the front or on the backstuds at the rear. It is possible to adjust its depth using the adjustable supports (**NSYSDCR...** type).
- It can also be equipped with a plain mounting plate, see [page 260](#).

Spacial S3DM

- Single-piece body, folded and welded.
- Front rail with double sheet thickness, gutter-shaped.
- 4 M8 x 25 mm shouldered backstuds for installing chassis and step slides, leaving a space of 10 mm behind them.
- Cable gland plate (245 x 80) at the top and bottom of the enclosure, guaranteeing the maximum access surface (also available in plain door).
- Finish: Structured finish, epoxy polyester powder
- Color: RAL 7035 grey
- Ingress protection rating: IP66 according to IEC 60529
- Mechanical protection rating: IK08 according to IEC 62262

Supply:
Wall-mounted enclosure supplied with 3-mm double-bar lock as standard



NSYS3DM10615T

Characteristics	Height (mm)	Width (mm)	Depth (mm)	References
Spacial S3DM	400	300	150	NSYS3DM4315T
Spacial S3DM	500	400	150	NSYS3DM5415T
Spacial S3DM	600	400	150	NSYS3DM6415T
Spacial S3DM	600	600	150	NSYS3DM6615T
Spacial S3DM	700	500	150	NSYS3DM7515T
Spacial S3DM	800	600	150	NSYS3DM8615T
Spacial S3DM	1000	600	150	NSYS3DM10615T
Spacial S3DM	1000	800	150	NSYS3DM10815T

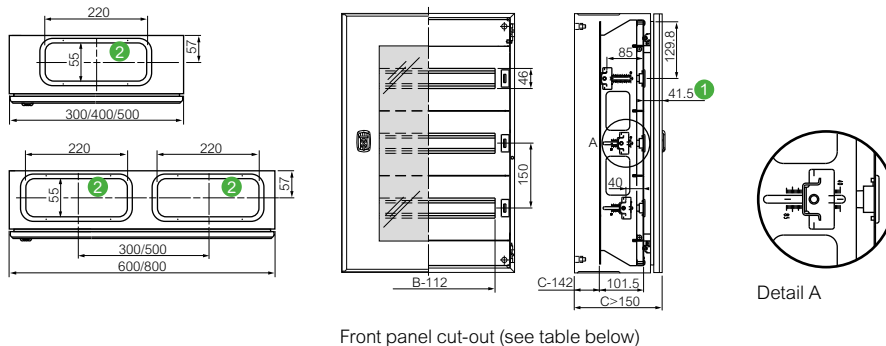

Front panel cut-out (see table below)

- ① Front face of the modular chassis / front face of the door
- ② Cable gland plates at the top and bottom of the enclosure.

Number of modules per chassis** (every 18 mm)

1 module = 2 steps = 18 mm

	NSYDLM24	NSYDLM48	NSYDLM48P	NSYDLM84P	NSYDLM66	NSYDLM88	NSYDLM84	NSYDLM112	NSYDLM168	NSYDLM240
Enclosure height (mm)	400	500	600	600	700	700	800	800	1000	1000
Enclosure width (mm)	300	400	400	600	500	500	600	600	600	800
Number of rows	2	3	3	3	3	4	3	4	6	6
Modules per row	12	16	16	28	22	22	28	28	28	39
Total n. of modules	24	48	48	84	66	88	84	112	168	234

Note:

References **NSYDLM48**, **NSYDLM48P** and **NSYDLM84P**: the central row cannot receive modules at the height of the lock (check our technical instructions) when installed at the front of the enclosure. In this case, 1 module is sealed up. ** DLM modular chassis. The dimensions provided include the modular chassis which is the most commonly used accessory with this enclosure.

DLM modular chassis

- The chassis consists of metal cut-out front panels, which can be clipped on without screws.
- The depth of the chassis can be adjusted from 40 to 85 mm, between the rail and the front panel, allowing the installation of all types of devices.
- Material: Rigid galvanized steel structure
- Finish: Structured finish, epoxy polyester powder
- Color: RAL 7035 grey

Note:
1 module = 2 steps = 18 mm



NSYDLM24

Characteristics	Number of modules	Height (mm)	Width (mm)	References
DLM modular chassis	24	400	300	NSYDLM24
DLM modular chassis	48	500	400	NSYDLM48
DLM modular chassis	48	600	400	NSYDLM48P
DLM modular chassis	84	600	600	NSYDLM84P
DLM modular chassis	66	700	500	NSYDLM66
DLM modular chassis	88	700	500	NSYDLM88
DLM modular chassis	84	800	600	NSYDLM84
DLM modular chassis	112	800	600	NSYDLM112
DLM modular chassis	168	1000	600	NSYDLM168
DLM modular chassis	234	1000	800	NSYDLM240

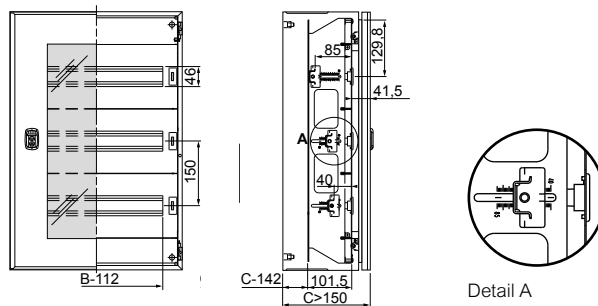

Front panel cut-out

Detail A
Rail adjustment: 45 mm

Plain front panel

- Metal front panels to be clipped on without screws.
- Finish: Structured finish, epoxy polyester powder
- Color: RAL 7035 grey

Supply:
2 plain front panel and fixings



NSYCTL300DLM

Characteristics	Width (mm)	References
Plain front panel	300	NSYCTL300DLM
Plain front panel	400	NSYCTL400DLM
Plain front panel	500	NSYCTL500DLM
Plain front panel	600	NSYCTL600DLM
Plain front panel	800	NSYCTL800DLM

Plain mounting plate

- Mounting plate for fixing non-modular devices.
- Material: Galvanized steel
- Thickness: 20/10e mm

Supply:
2 plain chassis and fixings



NSYPMP300DLM

Characteristics	Width (mm)	References
Plain mounting plate	300	NSYPMP300DLM
Plain mounting plate	400	NSYPMP400DLM
Plain mounting plate	500	NSYPMP500DLM
Plain mounting plate	600	NSYPMP600DLM
Plain mounting plate	800	NSYPMP800DLM

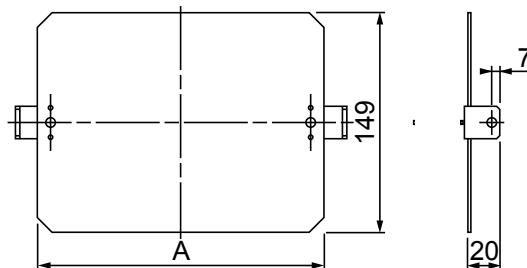

DL modular chassis

- Dinimel chassis designed for devices with heights of 53 and 68 mm, which can be coupled directly to the enclosure plate-support screws.
- Distance between device rail and protective cover plate: 45 mm.
- Material: Steel
- Finish: Metal protective cover plate
- Color: RAL 7035 grey

Note:

For Spacial S3D please consult us
 Depth 150 mm: For coupling to enclosures with a depth of 200 mm, the stand-offs (ref. **NSYEX608**) are to be ordered separately (4 per chassis).



NSYDLCR24

Characteristics	Height (mm)	Width (mm)	Depth (mm)	References
DL modular chassis	300	250	150	NSYDLCR18
DL modular chassis	400	300	150	NSYDLCR24
DL modular chassis	400	300	150	NSYDLCR36
DL modular chassis	500	400	150	NSYDLCR48
DL modular chassis	600	400	150/200	NSYDLCR64
DL modular chassis	600	500	150/200	NSYDLCR88
DL modular chassis	700	500	200	NSYDLCR110
DL modular chassis	800	600	200	NSYDLCR135

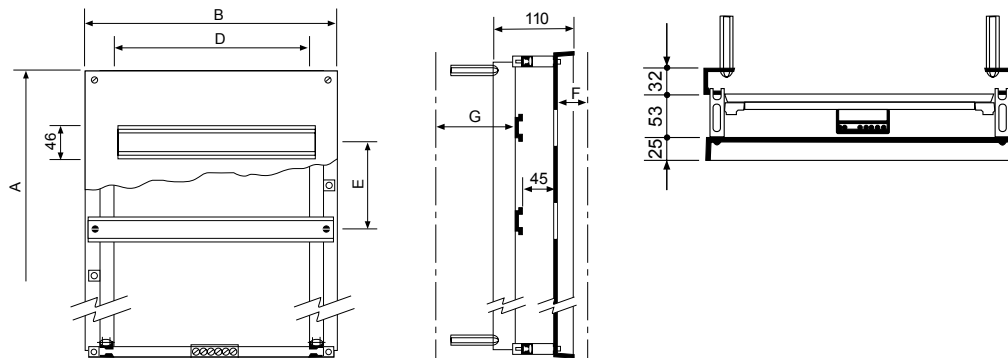

Dimension F: Distance from the protective cover plate to the inside of the door.
Dimension G: Distance from the device-support rail to the rear of the enclosure.

References	Dimensions (mm)						No. of 18 mm modules	No. of rows	Approx. weight (kg)
	A	B	D	E	F	G			
NSYDLCR18	255	205	162	120	41	51	18	2	1.2
NSYDLCR24	355	255	216	160	41	51	24	2	1.7
NSYDLCR36	355	255	216	110	41	51	36	3	1.7
NSYDLCR48	455	355	288	130	41	51	48	3	2.4
NSYDLCR64	555	355	288	130	41	51/101	64	4	3.3
NSYDLCR88	555	455	396	130	41	51/101	88	4	4.5
NSYDLCR110	655	455	396	125	41	101	110	5	5.1
NSYDLCR135	755	555	486	140	41	101	135	5	7.5

Note: For enclosures with transparent door, the F dimension is reduced by 4 mm

Blanking plate

- Blanking plate for full or partial covering of the circuit-breaker windows; it can easily be cut to the required size.
- Material: Plastic



NSYATP72M

Characteristics	Number of modules	Color	Length (mm)	References
Blanking plate	4	RAL 7035 grey	72	NSYATP72M
Blanking plate	6	RAL 7035 grey	108	NSYATP6DTM
Blanking plate	24	RAL 7035 grey	432	NSYATP24DTM
Blanking plate	-	RAL 7035 grey	1100	NSYATPUND

Modular distribution system based on accessories to create electric panels with high distribution capacity

The accessories are installed on a chassis mounted at the front of the enclosure, such as:

- cover plates for enclosures with widths of 600 and 800 mm, solid or cut-out, screw-mounted or hinged. They cover 24 or 36 modules per row, depending on the width of the enclosure,
- material support rails, fixed or with adjustable depth,
- mounting plate supports for coupling non-modular equipment,
- supports for fixing cable-distribution cable ducts.

Sets of accessories made up of material-supporting frames with chassis and cover plates are offered for the construction of double or busbar modular chassis. All accessories of the individual chassis system can also be combined in the same way with a double chassis or with a chassis with busbar area.



Single-chassis coupling set

- Chassis made up of vertical uprights and horizontal crossbars:
- Spacial SF: They are screwed to the front frame of the enclosure.
- Spacial SM: They are screwed to the front frame of the enclosure by means of vertical adaptation profiles, see [page 278](#).
- Easy access to the inside for component installation.
- Material: Steel
- Finish: Structured finish, epoxy polyester powder
- Color: RAL 7035 grey

Note:

Installation example: See [page 353](#).

Supply:

2 vertical uprights, 2 horizontal crossbars and fixing elements

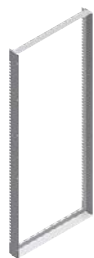

NSYCSH126

Characteristics	Maximum no. of 18 mm modules	Height (mm)	Width (mm)	References
Single-chassis coupling set	144	1200	600	NSYCSH126
Single-chassis coupling set	216	1200	800	NSYCSH128
Single-chassis coupling set	192	1400	600	NSYCSH146
Single-chassis coupling set	288	1400	800	NSYCSH148
Single-chassis coupling set	216	1600	600	NSYCSH166
Single-chassis coupling set	324	1600	800	NSYCSH168
Single-chassis coupling set	240	1800	600	NSYCSH186
Single-chassis coupling set	360	1800	800	NSYCSH188
Single-chassis coupling set	288	2000	600	NSYCSH206
Single-chassis coupling set	432	2000	800	NSYCSH208

Double-chassis coupling set

- Mounting on enclosures with widths of 1200 and 1600 mm.
- Spacial SF: The double-door enclosure adaptation kit is required for enclosure widths of 1200 and 1600 mm, see [page 270](#).
- Spacial SM: They are screwed to the front frame of the enclosure by means of the vertical adaptation profiles, see [page 278](#). For enclosures with a width of 1200 mm the top/bottom adjustment rails are necessary.
- Set made up of two modular chassis with an intermediate central upright.
- Material: Steel
- Finish: Structured finish, epoxy polyester powder
- Color: RAL 7035 grey

Note:

Installation example: See [page 353](#).

Supply:

2 single-chassis coupling sets,
1 intermediate central upright and fixing elements



NSYDCSH1412

Characteristics	Maximum no. of 18 mm modules	Set made up of columns with a width (mm)	Height (mm)	Width (mm)	References
Double-chassis coupling set	384	600 + 600	1200	800	NSYDCSH1412
Double-chassis coupling set	432	600 + 600	1400	800	NSYDCSH1612
Double-chassis coupling set	480	600 + 600	1600	800	NSYDCSH1812
Double-chassis coupling set	720	800 + 800	1800	600	NSYDCSH1816
Double-chassis coupling set	576	600 + 600	2000	600	NSYDCSH2012
Double-chassis coupling set	864	800 + 800	2000	800	NSYDCSH2016

Chassis-coupling set with zone for busbars

- Set for mounting on enclosures with widths of 1000 and 1200 mm.
- Spacial SF: They are screwed to the front frame enclosure.
- Spacial SM: They are screwed to the front frame of the enclosure by means of the vertical and horizontal adaptation profiles, see [page 278](#).
- Assembly made up of a modular chassis with an intermediate central upright and a blanking cover plate for busbars (width 300 mm).
- Material: Steel
- Finish: Structured finish, epoxy polyester powder
- Color: RAL 7035 grey

Note:

Installation example: See [page 353](#).

Supply:

1 single-chassis coupling set,
1 intermediate central upright,
1 busbar blanking cover plate and fixing elements

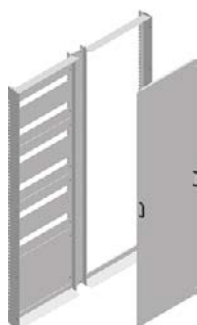

NSYCSHB2010

Characteristics	Maximum no. of 18 mm modules	Set made up of columns with a width (mm)	Height (mm)	Width (mm)	References
Chassis-coupling set with zone for busbars	288	600 + 400	2000	1000	NSYCSHB2010
Chassis-coupling set with zone for busbars	432	800 + 400	2000	1200	NSYCSHB2012

Combination of cut-out screw-mounted cover plates and single-chassis coupling set

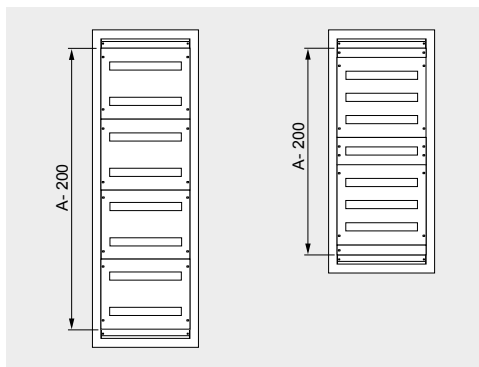

Dimensions (mm)		No. of 18 mm modules	1 single-chassis coupling set	5 screwed-on cut-out cover plates	2 adjustment cover plates
H (A)	W (B)		References	References	References
1800	600	240	1 x NSYCSH186	5 x NSYMUC306	1 x NSYADC16

Single-chassis coupling set

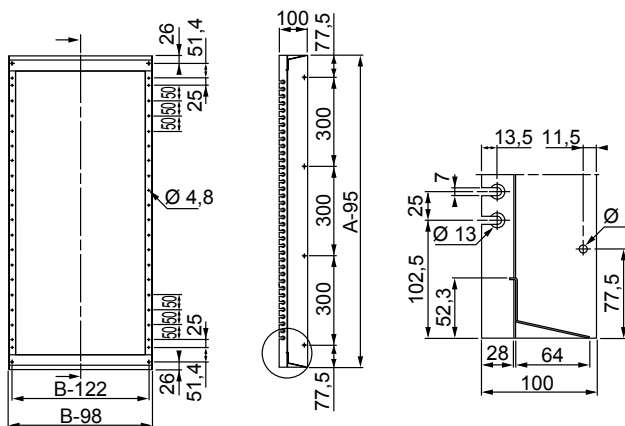

Combination of cut-out screw-mounted cover plates and double-chassis coupling

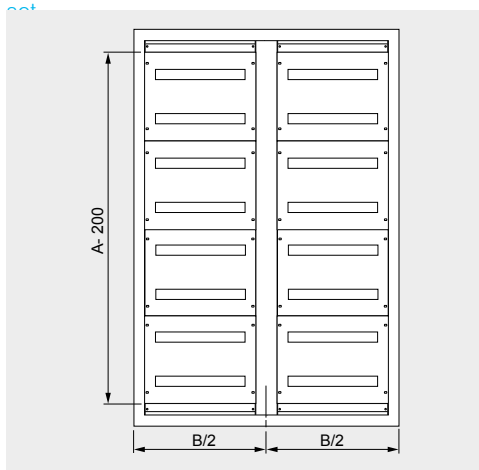

Dimensions (mm)			No. of 18 mm modules	1 double-chassis coupling set	12 screwed-on cut-out 300 mm cover plates	Double-door enclosure adaptation kit
H (A)	W (B)	D (C)		References	References	References
2000	1200	500	576	1 x NSYDCSH2012	12 x NSYMUC306	NSYSMP2D5
2000	1600	500	864	1 x NSYDCSH2016	12 x NSYMUC308	-

Plain cover plates

- Metal cover plates for protecting control devices.
- The cut-outs in non-modular control devices are at user's request.
- Suitable by modules of 150 or 200 mm.
- Material: Steel
- Finish: Structured finish, epoxy polyester powder
- Color: RAL 7035 grey

Versions:

- Screwed-on plain cover plate,
- Hinged plain cover plate.
- 120° opening with flat hinge.

Supply:

1 plain cover plate and fixing elements

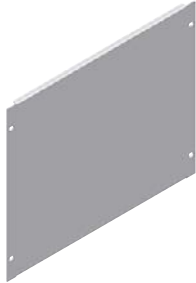

NSYMPC156

Characteristics	Height (mm)	Width (mm)	References
Screwed-on plain cover plate	150	600	NSYMPC156
Screwed-on plain cover plate	150	800	NSYMPC158
Screwed-on plain cover plate	200	600	NSYMPC206
Screwed-on plain cover plate	200	800	NSYMPC208
Screwed-on plain cover plate	300	600	NSYMPC306
Screwed-on plain cover plate	300	800	NSYMPC308
Screwed-on plain cover plate	400	600	NSYMPC406
Screwed-on plain cover plate	400	800	NSYMPC408
Screwed-on plain cover plate	450	600	NSYMPC456
Screwed-on plain cover plate	450	800	NSYMPC458
Screwed-on plain cover plate	600	600	NSYMPC606
Screwed-on plain cover plate	600	800	NSYMPC608

Plain cover plates

- Metal cover plates for protecting control devices.
- The cut-outs in non-modular control devices are at user's request.
- Suitable by modules of 150 or 200 mm.
- Material: Steel
- Finish: Structured finish, epoxy polyester powder
- Color: RAL 7035 grey

Versions:

- Screwed-on plain cover plate,
- Hinged plain cover plate.
- 120° opening with flat hinge.

Supply:

1 plain cover plate and fixing elements



NSYMPCH156

Characteristics	Height (mm)	Width (mm)	References
Hinged plain cover plate	150	600	NSYMPCH156
Hinged plain cover plate	150	800	NSYMPCH158
Hinged plain cover plate	200	600	NSYMPCH206
Hinged plain cover plate	200	800	NSYMPCH208
Hinged plain cover plate	300	600	NSYMPCH306
Hinged plain cover plate	300	800	NSYMPCH308
Hinged plain cover plate	400	600	NSYMPCH406
Hinged plain cover plate	400	800	NSYMPCH408
Hinged plain cover plate	450	600	NSYMPCH456
Hinged plain cover plate	450	800	NSYMPCH458
Hinged plain cover plate	600	600	NSYMPCH606
Hinged plain cover plate	600	800	NSYMPCH608

Plain cover plates

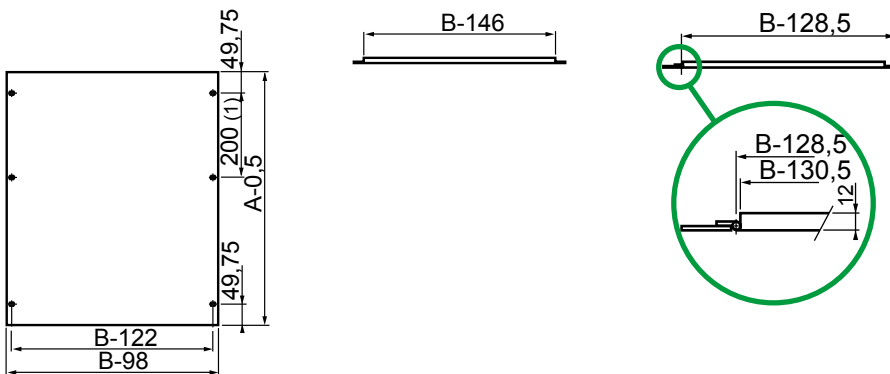

Screwed-on cut-out cover plate

- Cut-out metal cover plates for modular switchgear (1 module = 18 mm).
- Suitable by modules of 150 or 200 mm.
- Cover plates for 600 mm width enclosures: 24 modules per row,
- Cover plates for 800 mm width enclosures: 36 modules per row.
- Material: Steel
- Finish: Structured finish, epoxy polyester powder
- Color: RAL 7035 grey

Versions:

- Screwed-on cut-out cover plate,
- Hinged cut-out cover plate. 120° opening with flat hinge.

Supply:

1 cut-out cover plate and fixing elements



NSYMUC156

Characteristics	Maximum no. of 18 mm modules	No. of cut-outs	Height (mm)	Width (mm)	References
Screwed-on cut-out cover plate	24	1	150	600	NSYMUC156
Screwed-on cut-out cover plate	36	1	150	800	NSYMUC158
Screwed-on cut-out cover plate	24	1	200	600	NSYMUC206
Screwed-on cut-out cover plate	36	1	200	800	NSYMUC208
Screwed-on cut-out cover plate	48	2	300	600	NSYMUC306
Screwed-on cut-out cover plate	72	2	300	800	NSYMUC308
Screwed-on cut-out cover plate	48	2	400	600	NSYMUC406
Screwed-on cut-out cover plate	72	2	400	800	NSYMUC408
Screwed-on cut-out cover plate	72	3	450	600	NSYMUC456
Screwed-on cut-out cover plate	108	3	450	800	NSYMUC458
Screwed-on cut-out cover plate	72	3	600	600	NSYMUC606
Screwed-on cut-out cover plate	108	3	600	800	NSYMUC608

Hinged cut-out cover plate

- Cut-out metal cover plates for modular switchgear (1 module = 18 mm).
- Suitable by modules of 150 or 200 mm.
- Cover plates for 600 mm width enclosures: 24 modules per row,
- Cover plates for 800 mm width enclosures: 36 modules per row.
- Material: Steel
- Finish: Structured finish, epoxy polyester powder
- Color: RAL 7035 grey

Versions:

- Screwed-on cut-out cover plate,
- Hinged cut-out cover plate. 120° opening with flat hinge.

Supply:

1 cut-out cover plate and fixing elements



NSYMUCH156

Characteristics	Maximum no. of 18 mm modules	No. of cut-outs	Height (mm)	Width (mm)	References
Hinged cut-out cover plate	24	1	150	600	NSYMUCH156
Hinged cut-out cover plate	36	1	150	800	NSYMUCH158
Hinged cut-out cover plate	24	1	200	600	NSYMUCH206
Hinged cut-out cover plate	36	1	200	800	NSYMUCH208
Hinged cut-out cover plate	48	2	300	600	NSYMUCH306
Hinged cut-out cover plate	72	2	300	800	NSYMUCH308
Hinged cut-out cover plate	48	2	400	600	NSYMUCH406
Hinged cut-out cover plate	72	2	400	800	NSYMUCH408
Hinged cut-out cover plate	72	3	450	600	NSYMUCH456
Hinged cut-out cover plate	108	3	450	800	NSYMUCH458
Hinged cut-out cover plate	72	3	600	600	NSYMUCH606
Hinged cut-out cover plate	108	3	600	800	NSYMUCH608

Cut-out cover plates

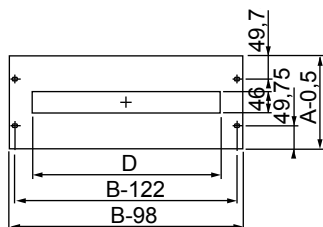

A = 150 and 200 mm

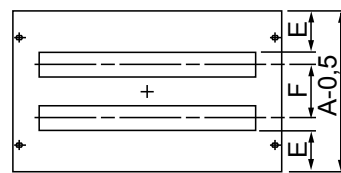

A = 300 and 400 mm

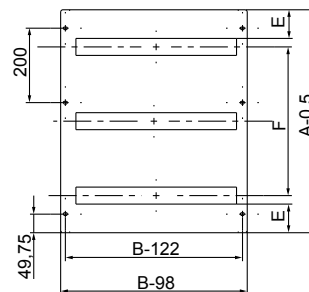

Cut-out at 200 mm when A = 600

Dimensions (mm)		
D	E	F
432	51.75	150
642	51.75	150
432	76.75	200
642	76.75	200
432	51.75	150
642	51.75	150
432	76.75	200
642	76.75	200

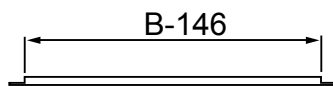

Screwed-on cover plate

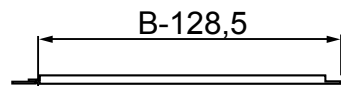

Hinged cover plate

Adjustment cover plates

- Metal adjustment cover plates designed to complete the front of the modular chassis according to the combinations made by modules of 150 or 200 mm.
- Material: Steel
- Finish: Structured finish, epoxy polyester powder
- Color: RAL 7035 grey

Supply:
2 adjustment cover plates and fixing elements



NSYADC16

Characteristics	Height (mm)	Width (mm)	References
Adjustment cover plates	50	600	NSYADC16
Adjustment cover plates	50	800	NSYADC18

Set of fixed rail with supports

- Set made up of a galvanized symmetric DIN rail, 35 x 15 mm, and fixed mounting supports, for the installation of modular devices or not.
- Material: Zinc-coated steel
- Fixing: Mounting by screws directly on the uprights of the chassis-coupling set

Maximum number of 18 mm modules:

- Enclosure width 600 mm: 24 modules,
- Enclosure width 800 mm: 36 modules.

Supply:
1 DIN rail, 2 fixed supports and fixing elements



NSYMFSC60

Characteristics	Width (mm)	References
Set of fixed rail with supports	600	NSYMFSC60
Set of fixed rail with supports	800	NSYMFSC80

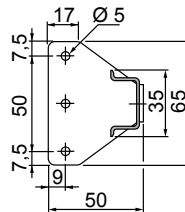
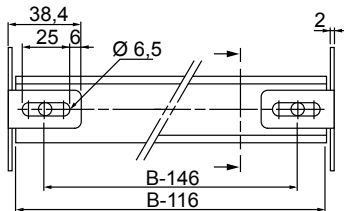

Set of depth-adjustable rail with supports

- Set made up of a galvanized symmetric DIN rail, 35 x 15 mm, and depth adjustable mounting supports, for the installation of modular devices or not.
- Material: Zinc-coated steel
- Fixing: Mounting by screws directly on the uprights of the modular chassis-coupling set

Maximum number of 18 mm modules:

- Enclosure width 600 mm: 24 modules,
- Enclosure width 800 mm: 36 modules.

Supply:
1 DIN rail, 2 adjustable supports and fixing elements



NSYMFSC60D

Characteristics	Width (mm)	References
Set of depth-adjustable rail with supports	600	NSYMFSC60D
Set of depth-adjustable rail with supports	800	NSYMFSC80D

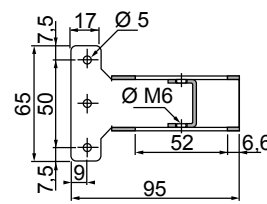
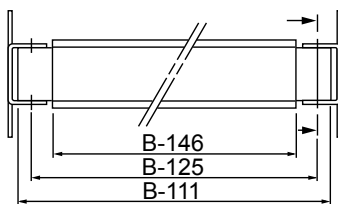

Cable duct fixing supports

- Supports for fixing cable-distribution gutters in the modular chassis.
- Allows the fixing of gutters in horizontal and vertical position on the same plane to facilitate cable distribution.
- Material: Zinc-coated steel

Fixing: Installation by screws directly on the rail supplied with the fixed or adjustable rail

Supply:

6 supports (3 on the right and 3 on the left) and fixing elements



NSYMCDFIX

Characteristics	References
Cable duct fixing supports	NSYMCDFIX

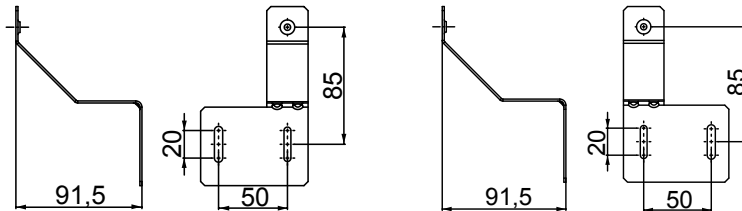

Reinforced plate supports

- Supports for fixing the partial mounting plate for small non-modular equipment or material-supporting cross-rails for heavy equipment. See partial mounting plate, [page 266](#).
- Material: Zinc-coated steel

Fixing: Direct fixing by screws to the vertical uprights of the modular chassis-coupling set and at the rear directly to the structure (Spacial SF) and on universal or quick-fixing cross-rails (see [page 275](#)) installed vertically in the back of the enclosure (Spacial SM)

Supply:

2 supports and fixing elements



NSYMP30

Characteristics	No. of cut-outs (Ø 5.2 mm)	Depth (mm)	References
Reinforced plate supports	4	300	NSYMP30
Reinforced plate supports	8	400	NSYMP40
Reinforced plate supports	12	500	NSYMP50
Reinforced plate supports	16	600	NSYMP60
Reinforced plate supports	24	800	NSYMP80

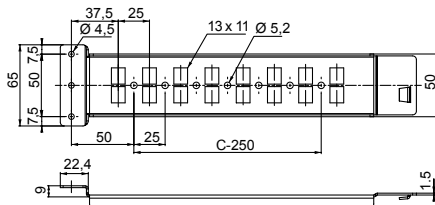

Fixed supports with no rail

Supply:

2 fixed supports and fixing elements.



NSYMFS1

Characteristics	References
Fixed supports with no rail	NSYMFS1

Adjustable supports with no rail

Supply:

2 adjustable supports and fixing elements



NSYMFS1D

Characteristics	References
Adjustable supports with no rail	NSYMFS1D

Top busbar chamber

- Chamber which protects and supports the sets of horizontal bars.
- Enables new switchgear by tapping and isolates the sets of bars from the rest of the equipment.
- It is only installed at the top of the enclosure.
- Material: Steel
- Finish: Structured finish, epoxy polyester powder
- Color: RAL 7035 grey
- Ingress protection rating: IP55 according to IEC 60529

Supply:

One structure of the busbar chamber as a kit
Two front panels
Reinforced coupling kit
One sealing gasket

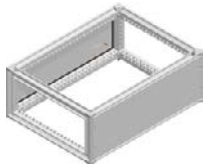

NSYTBC336

Characteristics	Height (mm)	Width (mm)	Depth (mm)	References
Top busbar chamber	300	300	500	NSYTBC335
Top busbar chamber	300	300	600	NSYTBC336
Top busbar chamber	300	300	800	NSYTBC338
Top busbar chamber	300	400	500	NSYTBC345
Top busbar chamber	300	400	600	NSYTBC346
Top busbar chamber	300	400	800	NSYTBC348
Top busbar chamber	300	600	500	NSYTBC365
Top busbar chamber	300	600	600	NSYTBC366
Top busbar chamber	300	600	800	NSYTBC368
Top busbar chamber	300	800	500	NSYTBC385
Top busbar chamber	300	800	600	NSYTBC386
Top busbar chamber	300	800	800	NSYTBC388
Top busbar chamber	300	1000	500	NSYTBC3105
Top busbar chamber	300	1000	600	NSYTBC3106
Top busbar chamber	300	1000	800	NSYTBC3108
Top busbar chamber	300	1200	500	NSYTBC3125
Top busbar chamber	300	1200	600	NSYTBC3126
Top busbar chamber	300	1200	800	NSYTBC3128

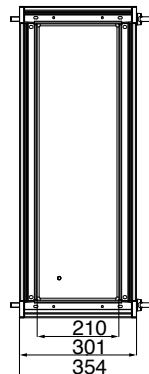
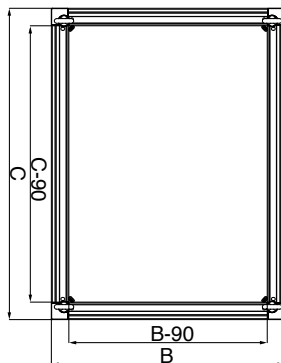

Side panels for the top busbar chamber

- Set of two side panels for coupling with the busbar chamber.
- Captive screws.
- Material: Steel
- Finish: Structured finish, epoxy polyester powder
- Color: RAL 7035 grey

Supply:

Two side panels and fixing elements

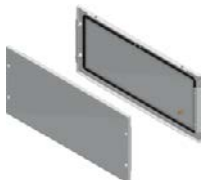

NSYSPBC35

Characteristics	Depth (mm)	References
Side panels for the top busbar chamber	500	NSYSPBC35
Side panels for the top busbar chamber	600	NSYSPBC36
Side panels for the top busbar chamber	800	NSYSPBC38

Side busbar chamber

- Protects and supports the sets of vertical bars.
- Enables new switchgear by tapping and isolates the sets of bars from the rest of the equipment.
- It can be installed on either of the two sides of the enclosure.
- Material: Steel
- Finish: Structured finish, epoxy polyester powder
- Color: RAL 7035 grey
- Ingress protection rating: IP55 according to IEC 60529
- UL-certified (cULus): Rating according UL50E: Type 1,12 AND 3R

Supply:

One structure of the busbar chamber
One roof
One rear panel
One door with handle (5 mm DB lock)



NSYSF18440

Characteristics	Height (mm)	Width (mm)	Depth (mm)	References
Side busbar chamber	1800	400	400	NSYSF18440
Side busbar chamber	1800	400	500	NSYSF18450
Side busbar chamber	1800	400	600	NSYSF18460
Side busbar chamber	2000	300	500	NSYSF20350
Side busbar chamber	2000	300	600	NSYSF20360
Side busbar chamber	2000	300	800	NSYSF20380
Side busbar chamber	2000	400	400	NSYSF20440
Side busbar chamber	2000	400	500	NSYSF20450
Side busbar chamber	2000	400	600	NSYSF20460
Side busbar chamber	2000	400	800	NSYSF20480
Side busbar chamber	2200	400	600	NSYSF22460

Side panels for the side busbar chamber

- Set of 2 side panels fixed to the outside.
- Captive screws.
- Material: Steel
- Finish: Structured finish, epoxy polyester powder
- Color: RAL 7035 grey

Supply:

Two side panels with external fixing and fixing elements



NSY2SP184

Characteristics	Height (mm)	Depth (mm)	References
Side panels	1800	400	NSY2SP184
Side panels	1800	500	NSY2SP185
Side panels	1800	600	NSY2SP186
Side panels	2000	500	NSY2SP205
Side panels	2000	600	NSY2SP206
Side panels	2000	800	NSY2SP208
Side panels	2000	400	NSY2SP204
Side panels	2000	500	NSY2SP205
Side panels	2000	600	NSY2SP206
Side panels	2000	800	NSY2SP208
Side panels	2200	600	NSY2SP226

630-A bar support

Spacial SF:

- Support prepared for coupling directly to the structure of the enclosure.

Spacial SFX:

- A universal cross-rail is needed, in some cases, to replace the 400 mm quick-fixing cross-rail.

Spacial SM:

- Installation by means of a vertical adaptation profile and 40 mm universal cross-rails (1 row).
- Maximum nominal rating 630 A.
- Determine according to the enclosed table the cross-section of the bars and the distance between supports, according to the nominal and short-circuit current respectively.

Supply:

One 630-A bar support, one 40 mm quick-fixing cross-rail and fixing elements



Characteristics	Width (mm)	References
630-A bar support	400	NSYBS400
630-A bar support	500	NSYBS500
630-A bar support	600	NSYBS600
630-A bar support	800	NSYBS800

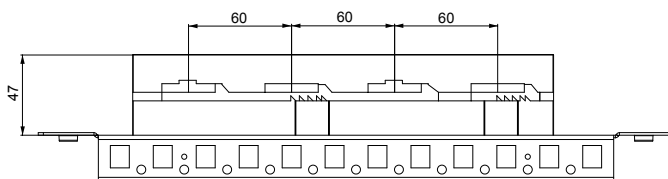

Nominal rating IP55 NR (A)	No. of bars per phase	Bar cross-section (mm)	Bar cross-section (mm ²)	Maximum distance between bar supports according to the short-circuit current (mm) I _{cc} kA							Neutral (mm)	Earth (mm)
				12	23	30	39	52	66	69		
200	1	12 x 5	60	525	525	525	400	250	-	-	-	-
250	1	15 x 5	75	575	575	575	450	325	-	-	-	-
320	1	20 x 5	100	600	600	600	475	350	150	-	12 x 5-10	-
390	1	25 x 5	125	600	600	600	475	350	150	-	12 x 5-10	6 x 3
440	1	30 x 5	150	650	650	650	650	525	400	350	20 x 5-10	10 x 3
500	1	20 x 10	200	675	675	675	525	350	150	-	25 x 5-10	10 x 6
600	1	30 x 10	300	675	675	675	600	475	325	275	30 x 5-10	10 x 6

630 A busbar end cover

- Busbar end protection.
- Fixing: Direct installation on the actual bar support (insulator)

Supply:

Two 630-A bar support plates and fixing elements



Characteristics	References
630 A busbar end cover	NSYBSC630

630-A multi-stage bar support

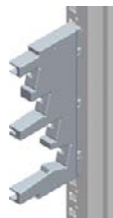

LVS04192

- Support for fixing bars with cross-sections: 15 x 5, 20 x 5, 32 x 5, 32 x 8.
- The orientation of the copper bars makes tightening easier and allows better circulation of the cables.
- It can be 3-pole or 4-pole, with gauges from 160 to 630 A.

Electrical characteristics:

- Rated peak withstand current I_{pk} (kA):
 - 30 kA for 160 A busbar,
 - 40 kA for 250 A busbar,
 - 55 kA for 400 A and 630 A busbar.
- Rated insulation voltage $U_i = 750$ V.
- Material: Insulated plastic
- Fixing: Mounting on mounting plates (see page 266) or cross-rails (see page 275) M6 x 25 self-tapping screws are required for fixing on the cross-rails, not included

Supply:

1 multi-stage bar support and fixing elements

Characteristics	References
630-A multi-stage bar support	LVS04192

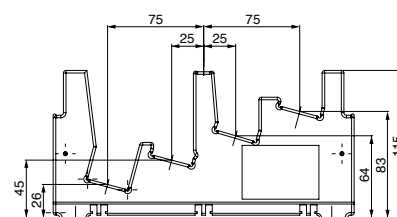
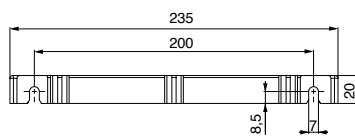
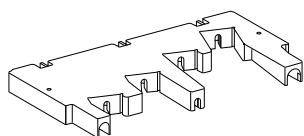

The following table shows:

- The cross-section of the bars that will be used according to the current-carrying capacity in the busbar.
- The distance between the bar supports that will be installed according to the rated short-time withstand current: I_{cw} .

Rating (A)	Bar crossection (mm)	Center-to-center distance of the supports (mm) I_{cw} (kA eff/1 s)				
		10	13	15	20	25
160	15 x 5	450	–	–	–	–
250	20 x 5	450	450	–	–	–
400	32 x 5	450	450	450	300	300 I_{cw} (kA eff/0.6 s)
630	32 x 8	450	450	450	300	300

Display for 630-A multi-stage busbar



LVS04197

- Protects against direct contact from the front in the connections of the busbar.
- Length: 1500 mm.
- Fixing: Direct mounting on the actual support

Supply:

1 display for multi-stage busbar and fixing elements

Characteristics	References
Display for 630-A multi-stage busbar	LVS04197

Vertical bar support

- Support prepared for fixing bars in vertical position, mounted directly on the structure of the enclosure. Adjustable height with a pitch of 25 mm.
- For a nominal rating $I_n \geq 3000$ A and ≤ 4000 A you must add one spacer ref. **LVS04646**.

Supply:
2 insulated bar supports,
1 metal vertical support and fixing elements



NSYBVS400

Characteristics	Width / Depth (B) (mm)	References
Vertical bar support	400	NSYBVS400
Vertical bar support	500	NSYBVS500
Vertical bar support	600	NSYBVS600
Vertical bar support	800	NSYBVS800

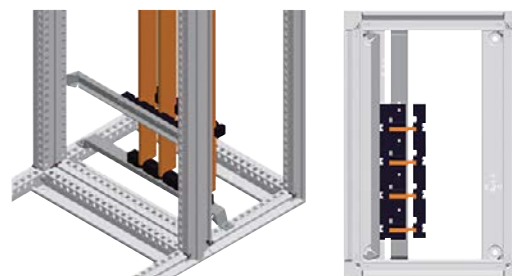
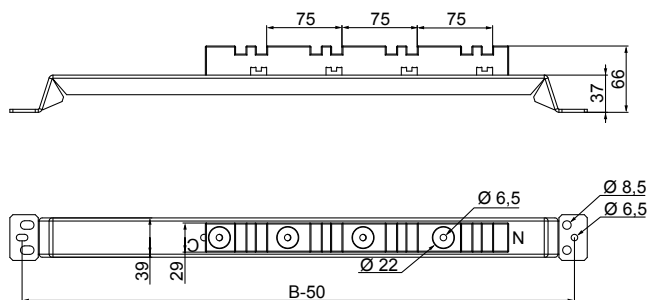

Setting support

- Bottom support for bars in vertical position.
- It is fixed to the bottom frame of the enclosure.
- It is required for supporting the bars.
- It is not considered a bar support when calculating the number of supports

Supply:
1 insulated bar support,
1 metal vertical support and fixing elements



NSYAS400

Characteristics	Width / Depth (B) (mm)	References
Setting support	400	NSYAS400
Setting support	500	NSYAS500
Setting support	600	NSYAS600
Setting support	800	NSYAS800

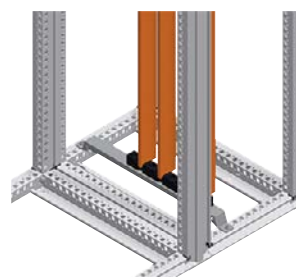
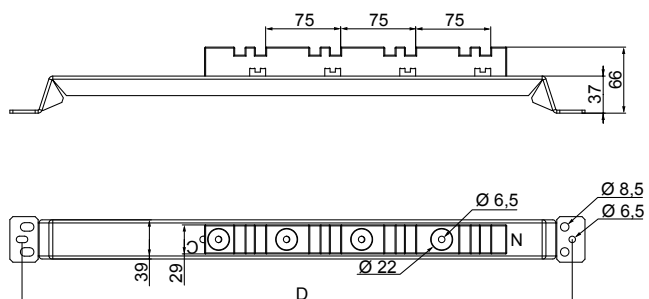

Horizontal bar support

- Support prepared for fixing bars in horizontal position.
- Direct mounting to the structure of the enclosure, on the vertical uprights, at any height, adjustable with a pitch of 25 mm.
- For a nominal rating $I_n \geq 3000$ A and ≤ 4000 A you must add one spacer ref. **LVS04646**.

Supply:

2 insulated bar supports,
1 metal horizontal support and fixing elements



NSYBHS500

Characteristics	Width / Depth (B) (mm)	References
Horizontal bar support	500	NSYBHS500
Horizontal bar support	600	NSYBHS600
Horizontal bar support	800	NSYBHS800

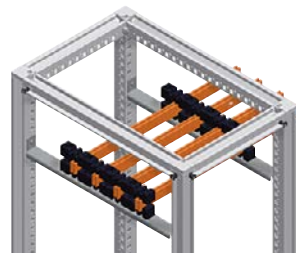
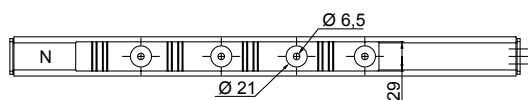
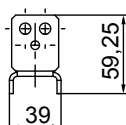
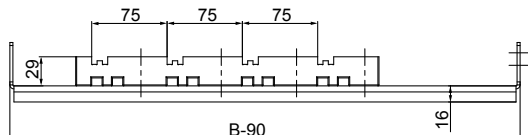

Bar support arm

- Support without fixing to the enclosure, required to guarantee the distance between the bars.
- It is used on bars in both vertical and horizontal position.
- For a nominal rating $I_n \geq 3000$ A and ≤ 4000 A you must add one spacer ref. **LVS04646**.

Supply:

2 insulated bar supports and fixing elements



NSYBSA

Characteristics	Width / Depth (B) (mm)	References
Bar support arm	500	NSYBSA

Overview of the offer Masterpact NT and NW



Circuit breakers

Ratings:

- Masterpact NT: 630 to 1600 A
- Masterpact NW: 800 to 4000 A.
- Circuit breakers type N1, H1, H2, H3, L1.
- Switch-disconnectors type NA, HA, HF, HH.
- 3 or 4 poles.
- Fixed or drawout versions.
- Option with neutral on the right.
- Protection derating.



Micrologic control units

Ammeter A and Energy E

- 2.0 basic protection
- 5.0 selective protection
- 6.0 selective + earth-fault protection
- 7.0 selective + earth-leakage protection (Only for ammeter A).

Power meter P

- 5.0 selective protection
- 6.0 selective + earth-fault protection
- 7.0 selective + earth-leakage protection

Harmonic meter H

- 5.0 selective protection
- 6.0 selective + earth-fault protection
- 7.0 selective + earth-leakage protection
- External sensor for earth-fault protection.
- Rectangular sensor for earth-leakage protection.
- Setting options (long-time rating plug):
- Low setting 0.4 to 0.8 x I_r
- High setting 0.8 to 1 x I_r
- Without long-time protection.
- External AD power-supply module.
- Battery module.



Power meter functions

Masterpact equipped with Micrologic 2 / 5 / 6 / 7 trip units offer type A (ammeter) or E (energy) metering functions as well as communication. Using Micrologic sensors and intelligence, Masterpact provides access to measurements of all the main electrical parameters on the built-in display, on a dedicated FDM display unit or via the communication system.



Operating assistance functions

Integration of measurement functions provides operators with operating assistance functions including alarms tripped by user-selected measurement values, time-stamped event tables and histories, and maintenance indicators.



Communication

- COM option in Masterpact.
- Masterpact in a communication network.
- IFM: Modbus interface module.
- IFE: Ethernet interface module.
- I/O application module.
- Electrical Asset Manager.



Overview of the offer Masterpact MTZ



Circuit breakers

MTZ1
From 630 to 1600 A



MTZ2
From 800 to 4000 A

Micrologic™ X control units

2.0X | 5.0X | 6.0X | 7.0X

Only four references



Digital Modules



Protection



Measurement



Diagnostics and Maintenance



Five performance levels N1, H1, H2, H3, L1

I_{cu} (kA rms)
at 415 V AC

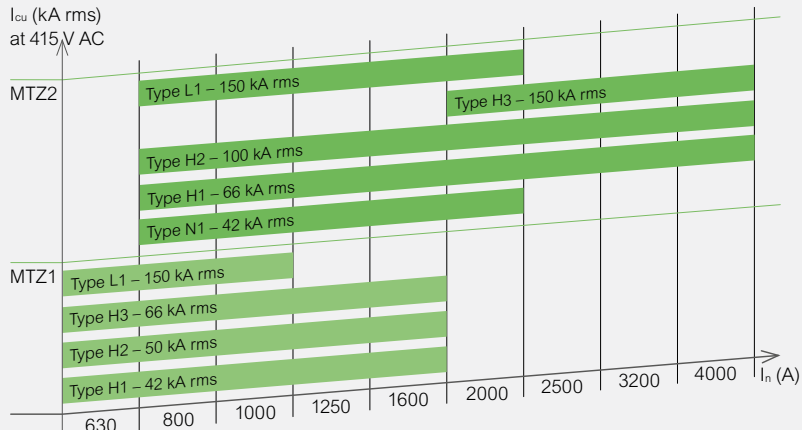

Masterpact MTZ1

Find all functions
and technical
characteristics in:
Masterpact MTZ catalog
LVPED216026EN



Masterpact support

Introduction

Installation of a Masterpact in a SF switchboard requires:

- Lateral cross-rails (**NSYSQCR65●●**, **NSYSUCR90●●**) (See table below)
- 1 specific transversal Masterpact support (**NSYFXMN●●●**) fixed to the lateral cross-rails
- Bar supports to reduce bar movements due to constraints

Masterpact supports

Dedicated offer to secure and facilitate Masterpact positioning in the switchboard

- Less distortion
- Reduced installation time
- Option to use bar CAD library



Masterpact supports W600

- Cut-outs already defined
- Available in the Schneider CAD library
- Material: Galvanized steel
- Mounting instructions: Screwdriver: T30, Tightening torque: 4.5 Nm/39.82 lb-in

Supply:

1 support delivered with fixing elements
(self tapping screws M6/T30 + type 9/M6 cage nuts)



NSYFXMNT60F

Characteristics	Masterpact combination	References
Masterpact MTZ1 and NT	Fixed	NSYFXMNT60F
Masterpact MTZ1 and NT	Withdrawable	NSYFXMNWT60FW
Masterpact MTZ2 and NW	Fixed	NSYFXMNWT60FW
Masterpact MTZ2 and NW	Withdrawable	NSYFXMNWT60FW

Masterpact supports W800

- Cut-outs already defined
- Available in the Schneider CAD library
- Material: Galvanized steel
- Mounting instructions: Screwdriver: T30, Tightening torque: 4.5 Nm/39.82 lb-in

Supply:

1 support delivered with fixing elements
(self tapping screws M6/T30 + type 9/M6 cage nuts)



NSYFXMNT80F

Characteristics	Masterpact combination	References
Masterpact MTZ1 and NT	Fixed	NSYFXMNT80F
Masterpact MTZ1 and NT	Withdrawable	NSYFXMNT80W
Masterpact MTZ2 and NW	Fixed	NSYFXMNW80F
Masterpact MTZ2 and NW	Withdrawable	NSYFXMNW80W

Associated cross-rails

- Material: Zinc-coated steel

Supply:

2 cross-rails and fixing elements (see cross-rail section [page 273](#) for more information)

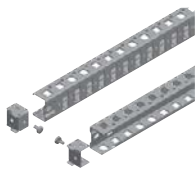

NSYSUCR65●●

Characteristics	References
in Masterpact combination: MTZ1 and NT	NSYSUCR65●●
in Masterpact combination: MTZ2 and NW	NSYSUCR90●●

Associated cross-rails

- Material: Zinc-coated steel

Supply:

2 cross-rails and fixing elements (see cross-rail section [page 273](#) for more information)

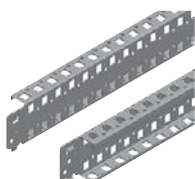

NSYSQCR65●●

Characteristics	References
in Masterpact combination: MTZ1 and NT	NSYSQCR65●●
in Masterpact combination: MTZ2 and NW	NSYSQCR90●●

Bar supports

Supports for Masterpact MTZ1 and NT

- Fixing by screw with hexagonal head.
- Material: Metal support: Zinc-coated steel, Isolating supports: thermosetting painting

Supply:
2 insulated bar supports,
1 metal horizontal support and fixing element



NSYBHNT500

Characteristics	Width (mm)	References
Fixed support	500	NSYBHNT500
Fixed support	600	NSYBHNT600
Fixed support	800	NSYBHNT800

Supports for Masterpact MTZ1 and NT

- Fixing by screw with hexagonal head.
- Material: Isolating supports: Thermosetting painting

Supply:
2 insulated bar supports and fixing elements



NSYBSA70

Characteristics	References
Free support	NSYBSA70

Supports for Masterpact MTZ2 and NW

- Fixing by screw with hexagonal head.
- Material: Metal support: Zinc-coated steel, Isolating supports: thermosetting painting

Supply:
2 insulated bar supports,
1 metal horizontal support and fixing element



NSYBHNW600

Characteristics	Width (mm)	References
Fixed support	600	NSYBHNW600
Fixed support	800	NSYBHNW800

Supports for Masterpact MTZ2 and NW

- Fixing by screw with hexagonal head.
- Material: Isolating supports: Thermosetting painting





Supply:
2 insulated bar supports and fixing elements











LVS04678

Characteristics	References
Free support	LVS04678

Quick-connection distribution blocks

Linery DX					
					
	63 A	63 A	125 A	160 A	160 A
Characteristics	LVS04040	LVS04041	LVS04045 + LVS04047	LVS04046	LVS04031
	<ul style="list-style-type: none"> Incoming through the top. Clip-on to rail. 	<ul style="list-style-type: none"> Incoming through the bottom. Clip-on to rail. 	<ul style="list-style-type: none"> Set of 4 35 mm² flexible connections, length 210 mm to be ordered separately (cat. no. 04047). Clip-on to rail. 	<ul style="list-style-type: none"> Set of 4 prefabricated flexible connections supplied, for connection with an INS100/160 or NSA160 switch, installed on the right or left. Clip-on to rail 	Clip-on to rail.
Number of poles	4P			1P	
Total connection capacity (dia. for flexible cables)					
4 mm ²	-			-	
6 mm ²	12 per phase + 12 neutral			3	
10 mm ²	-			2	
16 mm ²	-			1 tunnel terminal	
25 mm ²	4 tunnel terminals per phase + 1 neutral			-	
35 mm ²	-			1 tunnel terminal	
70 mm ²	-			-	
Size in 9 mm- modules	8			12	
Size in 18 mm- modules	4			6	





Screw distribution blocks

Linery DS							Linery BS			
										
	125 A	160 A	250 A	100 A	125 A	160 A	160 A	250 A	400 A	
Characteristics	LGY112510	LGY116013	LGY125014	LGY410028	LGY412548	LGY412560	LGY416048	LVS04052	LVS04053	LVS04054
	Clip-on to rail.			Clip-on to rail.				<ul style="list-style-type: none"> To be screwed on back. 13 M6 tapped holes + 4 plain holes of dia. 12.2 mm. 		
Number of poles	1P			4P				4P		
Total connection capacity	10	13	14	4 x 7	4 x 12	4 x 15	4 x 12	4 + 13 (dia. for flexible cables: 50 mm ²)		
Size in 9 mm- modules	3	4	5	8	14	20	18	-	-	-
Neutral terminal strip (optional)	-	-	-	LGYN1007	LGYN12512	LGYN12515	LGYN12512	-	-	-

Quick device feeders

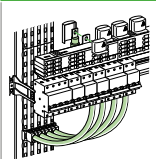
Linergy FM: For cable links							
							
	63 A	80 A	160 A	200 A			
Characteristics	LVS04008	LVS04000	LVS04018	LVS04012	LVS04013	LVS04014	LVS04026
	4P Cable to be used without ferrules.	4P -	4P Cable to be used without ferrules.	2P.	3P	4P	4P
Length in 9-mm modules	24	48	24	48			72
Length in 18-mm modules	12	24	12	24			36
Supply at incoming terminals	Enclosed terminals for cables up to 25 mm ²	Enclosed terminals for flexible cables 6 to 25 mm ² or rigid cables 10 to 35 mm ²	Direct onto the row by cable 70 mm ² with crimped lug, or flexible bar 20 x 3 from busbar with prefabricated connection				
Downstream connection capacity							
Max. 4 mm ² , Phase	6	-	-	-	-	-	-
Max. 4 mm ² , Neutral	4	-	-	-	-	-	-
Max. 6 mm ² , Phase	6	18	-	-	-	-	-
Max. 6 mm ² , Neutral	4	18	-	-	-	-	-
Max. 10 mm ² , Phase	-	-	18	12	36	36	54
Max. 10 mm ² , Neutral	-	-	9	12	-	18	27
Accessories included							
Pre-stripped copper connections	10 of 4 mm ² + 6 of 6 mm ² (L=100 mm)	12 blue + 12 black	12 of 10 mm ² (L=100 mm)	24 of 10 mm ²			36 of 10 mm ²
Protective cover	-	-	For pads (IPxxB)	-	-	-	-
Screws and nuts	-	-	For pads	-	-	-	-

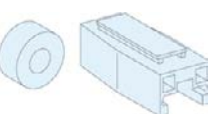
Linergy FM with upstream device

Connection of Linergy FM with upstream device					
					
Characteristics	LVS04021 + LVS04150 insulated covers	LVS04024	LVS04029	LVS04030	LVS04743
Upstream device	Linergy BW busbar	Multi-stage Linergy BS busbar	Rear Linergy BS busbar	Device 160 A	Busbar
Connection hardware	4P 200 A connection (supplied with fixing accessories)	4P 200 A connection (supplied with fixing accessories)	4P 200 A connection (supplied with fixing accessories)	4P 160 A connection for Linergy FM 1/2 row	200 A connection (20 x 3 mm) for Linergy FM

Feeders for Compact NSX et INS

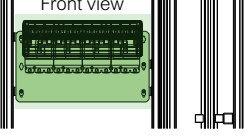
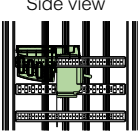
Linery FC													
	 <p>Compact NSX100/250 and INS/INV250 - All controls, fixed and withdrawable</p>												
	 												
Characteristics	<table border="1"> <thead> <tr> <th>LVS04407</th> <th>LVS04408</th> </tr> </thead> <tbody> <tr> <td colspan="2"> <ul style="list-style-type: none"> • Linery FC without prefabricated connections: • The connection of a Linery FC distribution block using pre-wired connectors or insulated flexible bars is not compatible with Form 2 partitioning (LVS04922). In this case, use the form 2 restoration kit (LVS04924). • For the connection, use insulated flexible bars, 32 x 8 mm (LVS04753). Each connection must not be longer than 500 mm. This size is validated with Schneider Electric insulated flexible bars. </td> </tr> <tr> <td>Number of poles</td> <td>3P</td> </tr> <tr> <td>Connection to</td> <td>Linery BS, Linery LGY or Linery LGYE busbars</td> </tr> <tr> <td>Number of devices</td> <td>4</td> </tr> <tr> <td>Composition</td> <td>Self-adhesive labels to mark the phases for connections to the busbars.</td> </tr> </tbody> </table>	LVS04407	LVS04408	<ul style="list-style-type: none"> • Linery FC without prefabricated connections: • The connection of a Linery FC distribution block using pre-wired connectors or insulated flexible bars is not compatible with Form 2 partitioning (LVS04922). In this case, use the form 2 restoration kit (LVS04924). • For the connection, use insulated flexible bars, 32 x 8 mm (LVS04753). Each connection must not be longer than 500 mm. This size is validated with Schneider Electric insulated flexible bars. 		Number of poles	3P	Connection to	Linery BS, Linery LGY or Linery LGYE busbars	Number of devices	4	Composition	Self-adhesive labels to mark the phases for connections to the busbars.
LVS04407	LVS04408												
<ul style="list-style-type: none"> • Linery FC without prefabricated connections: • The connection of a Linery FC distribution block using pre-wired connectors or insulated flexible bars is not compatible with Form 2 partitioning (LVS04922). In this case, use the form 2 restoration kit (LVS04924). • For the connection, use insulated flexible bars, 32 x 8 mm (LVS04753). Each connection must not be longer than 500 mm. This size is validated with Schneider Electric insulated flexible bars. 													
Number of poles	3P												
Connection to	Linery BS, Linery LGY or Linery LGYE busbars												
Number of devices	4												
Composition	Self-adhesive labels to mark the phases for connections to the busbars.												

Accessories

Tooth caps

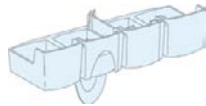

LVS04809

- The caps block off the reserve terminals on a Linery FC distribution block.
- Made of an insulated material, they simply clip on from the front.

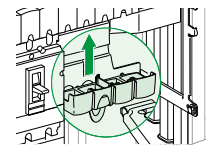

Characteristics	References
Tooth caps	LVS04809

Sigma safety terminals

- Safety terminals made from self-extinguishing Polyamide-6, with matt black base, MS-58 brass terminal (DIN 17660), tempered, zinc-plated and dichromated steel ring, and cover made from orange-colored self-extinguishing polypropylene.
- Anti-shearing: The connection is made by means of a tightening mechanism which distributes the pressure across the entire contact surface, avoiding friction and occasional stress that can damage the conductors.
- Unloosenable: The ring that surrounds the brass body guarantees that the pressure exerted by the actual conductors cannot open the terminal and loosen the connection.
- Full insulation: All SIGMA "S" terminals are supplied with a terminal-covering cap, avoiding any accidental contact with live parts. All the gauges can be coupled together, forming strips of any length. Operating voltage: 500 V.

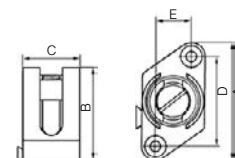

Note:
Each terminal accepts up to 2 conductors with the specified section.
20 units
(except for ref. **NSYS95100**: 10 units)



NSYS16

Characteristics	Section (mm ²)	A	B	C	D	E	References
Sigma safety terminals	1 x 4	30	20	13	21	4	NSYS04
Sigma safety terminals	1 x 6	33	25	16	24	7	NSYS06
Sigma safety terminals	1 x 10	38	28	16	28	6	NSYS10
Sigma safety terminals	1 x 16	42	32	19	32	9	NSYS16
Sigma safety terminals	1 x 35	46	38	23	34	11	NSYS2535
Sigma safety terminals	1 x 50	52	45	27	40	15	NSYS50
Sigma safety terminals	1 x 70	55	50	30	40	15	NSYS70
Sigma safety terminals	1 x 100	58	54	33	40	20	NSYS95100

Bimetal terminals

- Terminals specially designed for the junction of cables on plates, their main application is in busbar connections. The bimetal terminals are made from a copper alloy, hot-stamped and tin-plated, suitable for connecting a copper or aluminum conductor indistinctly (bimetal).

Supply:
4 bimetal terminals



NSYBBH29

Characteristics	Main section (mm ²)	Junction section (mm ²)	References
Bimetal terminals	6-50	-	NSYBBH29
Bimetal terminals	10-95	-	NSYBBH30
Bimetal terminals	16-150	-	NSYBBH31
Bimetal terminals	50-240	-	NSYBBH32

Plate/cable terminals

- Entry by plate and junction by cable, plate or terminal

Supply:
1 junction terminal



Fig. 1

Fig. 2

Characteristics	Junction cable section (mm ²)	Plate thickness (mm)	Fig.	References
Plate/cable terminals	1.5 to 16	5	2	NSYBPCH516
Plate/cable terminals	1.5 to 50	5	2	NSYBPCH550
Plate/cable terminals	16 to 120	5	2	NSYBPCH5120
Plate/cable terminals	1.5 to 16	10	1	NSYBPCH1016
Plate/cable terminals	1.5 to 50	10	1	NSYBPCH1050

Earthing strips

- For the junction of neutral and earth cables.
- Models **NSYRBL●●** (Fig. 3) for installation in boxes with insulated rear or by means of insulators, not supplied.
- Models **NSYRBLZ●●** (Fig. 4) with insulated plinth for fitting under pressure on 12 x 2 mm rail.

Supply:
10 earthing strips

Fig. 3



NSYRBL21656M

Fig. 4



NSYRBLZ21656

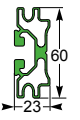
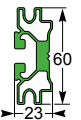
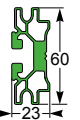
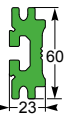
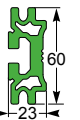



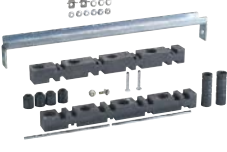

Fig. 4









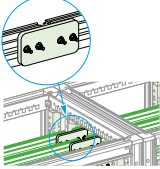
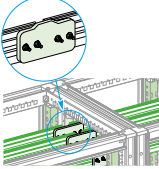
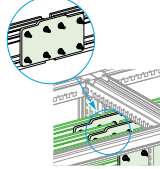



NSYRBLZ21656

Characteristics	Number of terminals x section	Fig	References
Earthing strips	2 x 16 mm ² + 5 x 6 mm ²	3	NSYRBL21656M
Earthing strips	2 x 16 mm ² + 8 x 6 mm ²	3	NSYRBL21686M
Earthing strips	2 x 16 mm ² + 14 x 6 mm ²	3	NSYRBL216146M
Earthing strips	2 x 16 mm ² + 29 x 6 mm ²	3	NSYRBL216296M
Earthing strips	2 x 16 mm ² + 5 x 6 mm ²	4	NSYRBLZ21656
Earthing strips	2 x 16 mm ² + 8 x 6 mm ²	4	NSYRBLZ21686
Earthing strips	2 x 16 mm ² + 14 x 6 mm ²	4	NSYRBLZ216146
Earthing strips	2 x 16 mm ² + 29 x 6 mm ²	4	NSYRBLZ216296

Linery LGYE - Horizontal profiles up to 4000 A

Installation in Spacial SF		Up to 1600 A					Up to 4000 A				
Linery profiles, 2000 mm length											
		630 A	800 A	1000 A	1250 A	1600 A	2000 A	2500 A	3200 A	4000 A	
Permissible current for an ambient temperature of 35 °C around the switchboard	IP > 31	530 A	680 A	850 A	1050 A	1480 A	1650 A	2100 A	2800 A	3350 A	
Number of profiles per phase		1									
Height available (mm)		150					150	200			
References		LVS04560	LVS04561	LVS04562	LVS04563	LVS04564	LVS04565	LVS04566	LVS04567	LVS04568	
Busbar supports											
		Fixed support NSYBHS●●		Free support NSYBSA							
		2 supports shall mandatorily be fastened to the structure of the 800 mm wide Spacial SF enclosure. If the width is greater, add a NSYSUCR40●● cabinet cross-rail to add a third fixed support. 1 support shall mandatorily be fastened to the structure of the enclosures of width 300 mm and 400 mm. If more supports are required, use free supports.									
Number of supports depending on I _{cw} (kA rms/1 s)	≤ 15	2 x NSYBHS●● *									
	≤ 25	2 x NSYBHS●● *									
	≤ 30	2 x NSYBHS●● *									
	≤ 40	- 2 x NSYBHS●● *									
	≤ 50	- 2 x NSYBHS●● *									
	≤ 60	- 2+1 ** 2 x NSYBHS●● *									
	≤ 65	- 2+1 **									
	≤ 75	- 2+1 **									
	≤ 85	- 2+1 **									
≤ 100	- 2+4 ***										
References Fixed support		NSYBHS●●							NSYBHS●● + LVS04646		
References Free support		NSYBSA							NSYBSA + LVS04646		
		* If spacing between supports > 800 mm add 1 NSYBSA free support. ** If spacing between supports > 300 mm add 1 NSYBSA free support. *** If spacing between supports > 135 mm add 1 NSYBSA free support.									
Joints		Up to 1600 A					Up to 4000 A				
		630 A	800 A	1000 A	1250 A	1600 A	2000 A	2500 A	3200 A	4000 A	
References (3P)		3x LVS04620					3x LVS04621		3x LVS04623		
References (4P)		4x LVS04620					4x LVS04621		4x LVS04623		
Note:											
If insulation clearance < 20 mm add an insulated shield between the busbar and the metal part of the cabinet.		LVS04620					LVS04621		LVS04623		



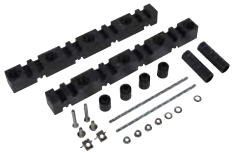

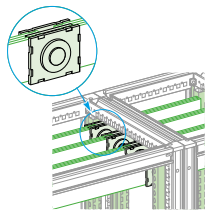
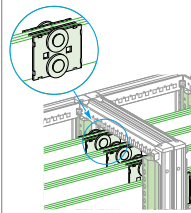
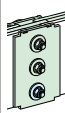

Linergy BS - Horizontal busbars up to 4000 A

Installation in Spacial SF		Up to 1600 A				Up to 4000 A					
Copper without holes, 2000 mm length											
Permissible current for an ambient temp. of 35 °C around the switchboard	IP > 31	750 A	900 A	1250 A	1600 A	1600 A	1800 A	2000 A	2500 A	2900 A	3340 A
Size of bars (mm)		60 x 5	80 x 5	60 x 5	80 x 5	80 x 10	50 x 10	60 x 10	80 x 10	100 x 10	120 x 10
Number of bars per phase		1	1	2	2	1	2	2	2	2	2
Height available (mm)		150									200
References		LVS04536	LVS04538	LVS04536	LVS04538	LVS04548	LVS04545	LVS04546	LVS04548	LVS04550	LVS04552
Busbar supports		 Fixed support NSYBHS●●				 Free support NSYBSA					
		2 supports shall mandatorily be fastened to the structure of the 800 mm wide Spacial SF enclosure. If the width is greater, add a NSYSUCR40●● cabinet cross-rail to add a third fixed support. 1 support shall mandatorily be fastened to the structure of the enclosures of width 300 mm and 400 mm. If more supports are required, use free supports.									
Number of supports depending on low (KA rms/1 s)	≤ 15	2 x NSYBHS●● *									
	≤ 25	2+1 **	2 x NSYBHS●● *								
	≤ 30	2+1 **	2 x NSYBHS●● *								
	≤ 40	2+1 **	2 x NSYBHS●● *								
	≤ 50	-	2+1 **	2 x NSYBHS●● *						2 x NSYBHS●● *	
	≤ 60	-	2+1 **				2+1 **				
	≤ 65	-	2+1 **				2+1 **				
	≤ 75	-	2+4 ***				2+1 **		2+1 **		
≤ 85	-	-				2+1 **		2+1 **			
References Fixed support		NSYBHS●●									NSYBHS●● + LVS04646
References Free support		NSYBSA									NSYBSA + LVS04646

* If spacing between supports > 800 mm add 1 NSYBSA free support.
 ** If spacing between supports > 300 mm add 1 NSYBSA free support.
 *** If spacing between supports > 135 mm add 1 NSYBSA free support.

Joints Installation dans Spacial SF		Up to 1600 A				Up to 4000 A					
		1 vertical bar per phase		2 vertical bars per phase		1 vert. bar per phase		2 vertical bars per phase			
Size of bars (mm)		60 x 5	80 x 5	60 x 5	80 x 5	80 x 10	50 x 10	60 x 10	80 x 10	100 x 10	120 x 10
References		LVS04640	LVS04641	LVS04640	LVS04641	LVS04641	LVS04640	LVS04640	LVS04641	LVS04641	LVS04643
Sliding joints with torque nut		 LVS04640				 LVS04641					



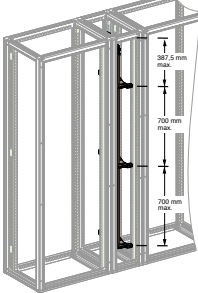
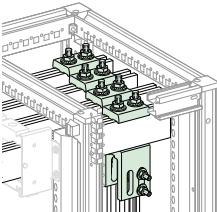
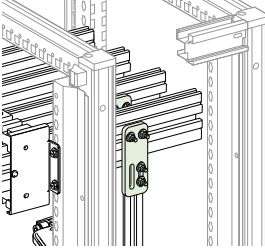





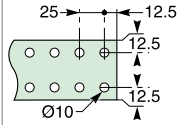

Linergy LGY - Lateral profiles up to 1600 A

Installation in Spacial SF		L 300				
		 630 A	 800 A	 1000 A	 1250 A	 1600 A
Permissible current for an ambient temp. of 35 °C around the switchboard	IP ≤ 31	590 A	760 A	950 A	1170 A	1480 A
Number of profiles per phase		1				
References		LVS04502	LVS04503	LVS04504	LVS04505	LVS04506
Busbar supports		 Fixed support LVS04651		Note: An end stop must be fitted on the bottom support: LVS01109 (sold in lots of 12)		
	Number depending on I_{cw} (kA rms/1 s)	≤ 25	3			
		≤ 30	3			
		≤ 40	3			
		≤ 50	4			
		≤ 60	5			
		≤ 65	5			
		≤ 75	7			
		≤ 85	8			
Only for enclosures with a depth ≥ 500 mm						
References		LVS04651 + upright adapters NSYSFPA + NSYSUCR40●●				
Connections to the Linergy BS horizontal busbar				Note: Supplied with mounting hardware. Reference include 1 connection only. Order 1 connection per phase.		
References according to horizontal busbar size	5 mm thick	LVS04634		LVS04635		
	10 mm thick Width ≤ 80 mm	LVS04636				
	10 mm thick Width > 80 mm	LVS04636 + LVS04642 LVS04638 + LVS04642				
Connections to the Linergy LGYE horizontal busbar		 ≤ 1600 A		Note: Supplied with mounting hardware. Reference include 1 connection only. Order 1 connection per phase.		
References (vertical connection)		LVS04602				
References (vertical shifted connection)		LVS04603				

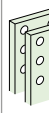
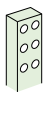
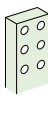
Linery LGYE - Lateral profiles up to 4000 A

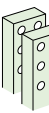
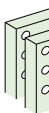
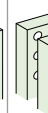
Installation in Special SF		L 300								
Linery profile, 2000 mm length										
		630 A	800 A	1000 A	1250 A	1600 A	2000 A	2500 A	3200 A	4000 A
Permissible current for an ambient temperature of 35 °C around the switchboard	IP > 31	530 A	680 A	850 A	1050 A	1480 A	1650 A	2100 A	2800 A	3350 A
Number of profiles per phase		1			1			2		
Height available (mm)		150			150			200		
References		LVS04560	LVS04561	LVS04562	LVS04563	LVS04564	LVS04565	LVS04566	LVS04567	LVS04568
Busbar supports										
		Fixed support NSYBVS			Free support NSYBSA			Bottom support NSYAS		
		3 fixed supports are compulsory to hold the busbar in position. If more than 3 supports are needed, use free supports (in addition).								
	Number depending on I _{ew} (kA rms/1 s)	≤ 30	3							
		≤ 40	-	3+2 *			3			
		≤ 50	-	3+2 *			3			
		≤ 60	-	3+2 *			3			
		≤ 65	-	3+2 *			3			
		≤ 75	-	3+4 **			3+2 *			
		≤ 85	-	3+4 **			3+2 *			
	≤ 100	-				3+6 ***				
References Fixed support		NSYBVS						NSYBHS + LVS04646		
References Bottom support		NSYAS						NSYAS + LVS04646		
References Free support		NSYBSA						NSYBSA + LVS04646		
		* If spacing between supports > 400 mm add 1 NSYBSA free support. ** If spacing between supports > 250 mm add 1 NSYBSA free support. *** If spacing between supports > 130 mm add 1 NSYBSA free support.								
Wedging busbars in position										
		Wedge fitted on bottom support			Wedge fitted on bottom support					
		The bottom support NSYAS + LVS0465 is used to place profiles and ensure they are in the correct position. It is not considered to be a busbar support.								
References		LVS04658 (set of 12 wedges)						LVS04659 (set of 12 wedges)		
Connections to the Linery LGYE horizontal busbar		2000/2500 A						3200/4000 A		
		Supplied with mounting hardware. Reference include 1 connection only. Order 1 connection per phase.								
References (short connection)		LVS04604						LVS04607		
References (long connection)		LVS04605								

Linery BS - Lateral flat busbars up to 3200 A

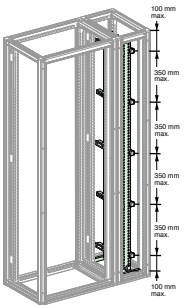
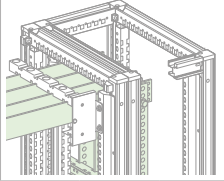
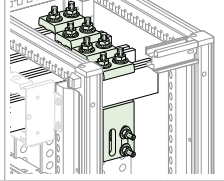
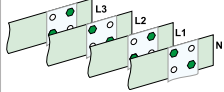
Installation in Spacial SF		Up to 1600 A				Up to 3200 A							
Pre-slotted copper, 1675 mm length 	IP > 31												
		750 A	900 A	1250 A	1600 A	1080 A	1250 A	1600 A	1850 A	2000 A	2500 A	2820 A	
Permissible current for an ambient temp. of 35 °C around the switchboard		60 x 5	80 x 5	60 x 5	80 x 5	50 x 10	60 x 10	80 x 10	50 x 10	60 x 10	80 x 10	100 x 10	
Busbar cross-section (mm)		1		2		1		2					
Number of profiles per phase		LVS04516	LVS04518	LVS04516	LVS04518	LVS04525	LVS04526	LVS04528	LVS04525	LVS04526	LVS04528	LVS04550	
References													
Busbar supports		 Fixed support NSYBVS				 Free support NSYBSA				 Bottom support NSYAS			
		3 fixed supports are compulsory to hold the busbar in position. If more than 3 supports are needed, use free supports (in addition). The bottom wedge support is used to place the busbar and ensure it is in the correct position. It does not count as a busbar support.											
	Number of supports depending on I_{cr} (kA rms/1 s)	≤ 15	3 *										
	≤ 25	3+2 *		3 *									
	≤ 30	3+2 *				3 *							
	≤ 40	3+4		3+2 *									
	≤ 50	3+4				3+2 *							
	≤ 60					3+4				3+2 *			
	≤ 65					3+4				3+2 *			
	≤ 75					3+6		3+4					
≤ 85					3+4								
References Fixed support		NSYBVS											
References Bottom support		NSYAS											
References Free support		NSYBSA											
		* If spacing between supports > 350 mm add 1 NSYBSA free support.											
Connections to the Linery BS horizontal busbar													
		For a busbar with 75 mm distance between bars, the bars must be completely covered. Staggered assembly points between one bar and the next, to maintain the necessary clearance distances.(3)				References LVS04636, LVS04637, LVS04638 are supplied individually: 1 connection per phase. Reference LVS04642 consists of 2 M8 x 140 screws which can replace the original M8 x 120 screws.							
													
		1 bar per phase	2 bars per phase	1 bar per phase	2 bars per phase	1 bar per phase	2 bars per phase	1 bar per phase	2 bars per phase	1 bar per phase	2 bars per phase	1 bar per phase	2 bars per phase
		60 x 5	80 x 5	60 x 5	80 x 5	50 x 10	60 x 10	80 x 10	50 x 10	60 x 10	80 x 10	100 x 10	100 x 10
References depending on horizontal busbar size	Width ≤ 80 mm	LVS04645				LVS04636		LVS04637		LVS04645			
	Width > 80 mm	LVS04645				LVS04636 + LVS04642		LVS04637 + LVS04642		LVS04645			

(1) Drill hole dimensions for 5 mm thick horizontal busbars.

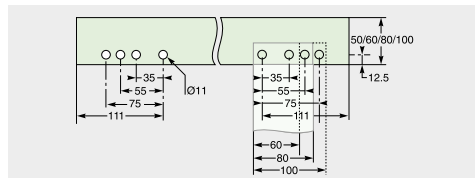

Drill hole dimensions for 10 mm thick horizontal busbars.

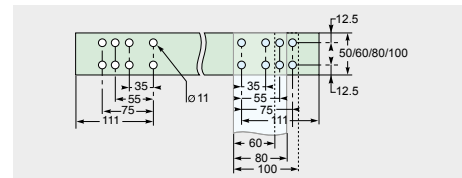

Linery TB

PE conductor								
Characteristics		Vertical PE conductor with Linergy LGY profile (W = 1670 mm)			Vertical PE conductor with Linergy BS busbar (W = 1675 mm)		Horizontal PE conductor with Linergy BS busbar	
Rated short-time current (Isc)		≤ 65	> 65... ≤ 80	= 100	≤ 40	> 40	≤ 40	> 40
Permissible current (A)		630	800	1250	-	-	-	-
Bar size (mm)		-	-	-	25 x 5	50 x 5	25 x 5	50 x 5
Characteristics		-	-	-	Drilled flat bar Ø10.6 mm (one 10.6 mm hole every 25 mm along the entire length)	Drilled flat bar Ø10.6 mm (two 10.6 mm hole every 25 mm along the entire length)	-	-
References		LVS04502	LVS04503	LVS04505	LVS04512	LVS04515	LVS04512	LVS04512

Connection between PE conductors



LVS04672

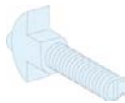

LVS04766

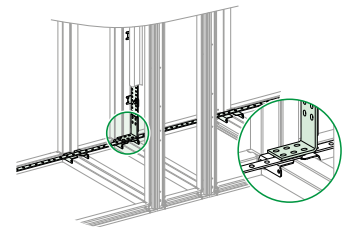

Characteristics	Composition	References
Connection plates for horizontal/vertical PE bars	2 copper angle brackets	LVS04672
Linerary connection hardware	20 M8 screws (W = 25 mm) + 20 nuts + 20 contact washers for connection to cable lugs or flexible bars	LVS04766

PEN conductor



LVS04656

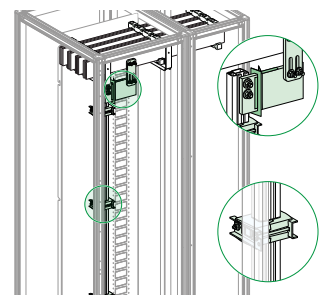

Characteristics	References
Linerary TB PEN installation kit with LGY vertical profile	LVS04656
1600-A connection 10-mm horizontal busbar with Linergy LGY profile	LVS04636
Linerary LGYE vertical connection 1600 A	LVS04602

Accessories For Low Voltage Switchboards Special SF Insulated Flexible Bars

Connection between device and busbars

- The flexible bars are determined taking into account the connected device, whatever the internal temperature of the switchboard.
- The bar sizes indicated below take into account the derating curves of devices.
- Width: 1800 mm
- Rated insulation voltage (Ui): 1000 V
- Maximum withstand temperature for the insulated material: 125 °C



04742

Characteristics	Size (mm)	References
NSX100	20 x 2	LVS04742
NSX160/250	20 x 3	LVS04743
NSX400	32 x 5	LVS04751
NSX630	32 x 8	LVS04753
FM 200 A Linergy	20 x 3	LVS04743
FC 3P Linergy	32 x 8	LVS04753
FC 4P Linergy	32 x 8	LVS04753
Fupact 250	24 x 5	LVS04746
Fupact 400	32 x 5	LVS04751
Fupact 630	32 x 8	LVS04753

Accessories for Low Voltage Switchboards

Spacial SF Assemblies with IEC 61439-2 Certification

Introduction

Because low-voltage switchboards must comply with the IEC 61439-2 standard, we have tested the most unfavourable and the most representative configurations (§ 10.10.2 of IEC 61439-1 ed2 2011) ranging up to 4000 A. We offer the entire product range, based on the Spacial SF universal assembly system, allowing you to comply with all requirements of the standard.

Whether you are an OEM or a panelbuilder using universal enclosures and looking for advice on how to flexibly and reliably assemble and integrate the equipment: In this guide you can learn how to build up an electrical switchboard fitted with Schneider Electric products.



11

To ensure continuity of service and compliance with electrical safety requirements, we provide you with certificates based on assemblies tested by a third-party organization in accordance with the IEC 61439-2 standard. These tests have been performed with the most commonly used configurations to assist you finalize your switchboard with complete confidence, based on useful, reliable and verified information.

These tests cover the entire Spacial SF range of dimensions. They supplement our range of tested PrismaSeT HD enclosures based on the functional unit system of PrismaSeT and Spacial SFM for MCC applications. This guide may also be used to brush up the knowhow of the fundamental rules of how to use an enclosure and how to install devices in Spacial SF enclosures.

Accessories for Low Voltage Switchboards

Spacial SF IEC 61439-2 certified assemblies

Compatibility table

Dimensions			Intensity (A)				
Height (mm)	Width (mm)	Depth (mm)	≤ 800 A	≤ 1250 A	≤ 1600 A	≤ 2500 A	≤ 4000 A
1200	600	400	●				
	600	600	●				
	800	400	●				
	800	600	●				
1400	600	400	●	●			
	800	400	●	●			
1600	600	600	●	●			
	600	800	●	●			
	800	600	●	●			
	800	800	●	●			
1800	600	400	●	●	●		
	600	500	●	●	●		
	600	600	●	●	●	●	
	600	800	●	●	●	●	
	800	400	●	●	●		
	800	500	●	●	●		
	800	600	●	●	●	●	
	1000	400	●	●	●		
	1000	500	●	●	●		
	1000	600	●	●	●	●	
	1200	400	●	●	●		
	1200	500	●	●	●		
	1200	600	●	●	●	●	
	2000	600	400	●	●	●	
600		500	●	●	●		
600		600	●	●	●	●	
600		800	●	●	●	●	●
800		400	●	●	●		
800		500	●	●	●		
800		600	●	●	●	●	
800		800	●	●	●	●	●
1000		400	●	●	●		
1000		500	●	●	●		
1000		600	●	●	●	●	
1000		800	●	●	●	●	●
1200		400	●	●	●		
1200		500	●	●	●		
1200		600	●	●	●	●	
1200		800	●	●	●	●	●
1600		400	●	●	●		
1600		500	●	●	●		
1600		600	●	●	●	●	
2200		600	600	●	●	●	●
	600	800	●	●	●	●	●
	800	600	●	●	●	●	
	800	800	●	●	●	●	●
	1000	600	●	●	●	●	
	1200	600	●	●	●	●	
	1200	800	●	●	●	●	●
	1200	800	●	●	●	●	●

●: Certified dimensions for indicated intensity



How to assemble a Spacial SF switchboard
 (Implementation of the standard IEC 61439) Technical guide
 Ref : UE17MK01EN



IEC 61439-2 certification (IECEE CB scheme issued by DEKRA) is valid only once installation has been carried out, according to the recommendations indicated in the technical guide, "how to assemble a Spacial SF switchboard", with the Schneider Electric devices featured in this guide.

The PrismaSeT system can be used for all types of low-voltage distribution switchboards up to 6300 A for harsh environments.



Switchboard design is very simple



1 Metal structure

Made up of one or more pre-assembled frameworks combined side-by-side or back-to-back.

2 Distribution system

Horizontal busbars running on the top or bottom and vertical busbars positioned in a lateral compartment or at the rear of the enclosure are used to distribute electricity throughout the switchboard.

3 Complete functional units

- Dedicated mounting plate for device installation
- Front plate to block direct access to live parts
- Devices for on-site connections.

Each functional unit contributes to a function in the switchboard. The functional units are modular and are arranged rationally. The system includes everything required for functional unit mounting, supply and onsite connection. The components of the PrismaSeT HD and those of the functional units in particular have been designed and tested taking into account device characteristics. This design approach ensures a high degree of reliability in system operation and optimal safety for personnel.



Advantages of Prisma system switchboards



1 Safe electrical installation

The total compatibility of Schneider Electric devices with the PrismaSeT HD system is a key advantage in ensuring a high level of installation dependability.

2 Upgradeable electrical installation

Thanks to modular design, PrismaSeT HD switchboards can be modified easily to integrate new functional units as needed or to be combined with your Spacial SF control panel cabinets.

3 Total safety for personnel

Work in a switchboard must only be carried out by authorised persons in compliance with all applicable safety regulations. To increase the safety of personnel, devices are installed behind protective front plates; only the operating handles are accessible. Additional internal protection (partitions, barriers) is available for protection against direct contact with live parts according to form of separation 2, 3 or 4. Terminal shields are mandatory for installation of Compact NSX and INS/INV devices in PrismaSeT HD enclosures.

4 Connected solution up to 4000 A

- Fire prevention
- Power availability
- Energy management

Components in the PrismaSeT HD system ensure the compliance of switchboards with standards IEC 61439-1 + 2.



Mechanical characteristics up to 4000 A*



- Steel sheet metal.
- Structured finish, epoxy polyester powder.
- Two options:
 - White color RAL 9003 outside and inside
 - Grey color RAL 7035 and white color inside (for the PrismaSeT references)
- Can be dismantled.
- Can be combined side-by-side and back-to-back.
- Degree of protection: IP55 according to IEC 60529.
- Degree of protection against mechanical impacts: IK10 (IK08 for the glazed-door) according to IEC 62262.

Framework dimensions

Two widths:

- W 300: Cable compartment
- W 700: Device compartment or cable compartment

Three depths:

- D500 up to 1600 A with incoming Masterpact NT and MTZ1 only
- D600 up to 1600 A with incoming Masterpact NT and MTZ1 only. Option to connect with cables from rear
- D800 up to 4000 A with incoming Masterpact NT and MTZ1 or NW and MTZ2. Option to connect to cables from rear or to connect to rear vertical busbars
- Height: 2000 mm
- Enclosures for indoor installation.



* For more information about PrismaSeT 6300 and for solutions up to 6300 A see the catalog PrismaSeT 6300 UEMKCAT008EN

Electrical characteristics



- Rated insulation level of main busbars: 1000 V.
- Rated operational current I_e : 4000 A.
- Rated peak withstand current I_{pk} : 220 kA.
- Rated short-time withstand current I_{cw} : 100 kA rms/1 second.
- Frequency: 50/60 Hz.



Electrical switchboards built using the PrismaSeT functional system and Schneider Electric recommendations fully comply with international standard IEC 61439-2.

Forms according to IEC 61439-2

Decisions concerning the form of separation and the degree of protection are subject to a joint agreement between manufacturer and client.

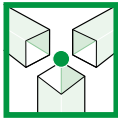

In most installations, PrismaSeT HD enclosures do not require partitioning. In this case, the switchboard is a Form 1.

Safety being one of its foremost goals, Schneider Electric offers options and features that go well beyond the recommendations of the standard.

The protection of life and property is a standard feature due to:

- Front plates that require a tool to be removed
- Keylock on doors providing access to live parts
- The systematic installation of terminal shields on Compact NSX circuit breakers and Compact INS and INV switch-disconnectors
- Covering of the upstream and downstream terminals on the incoming device so that operators are perfectly safe at all points in the switchboard when the incoming device is off (open).

What is more, PrismaSeT HD offers different levels of partitioning to create separations inside the enclosures, thereby creating Form 2b, 3b, 4a and 4b electrical switchboards. Electrical switchboards must meet the IP2X degree of protection to comply with standard IEC 61439-2

Form 1

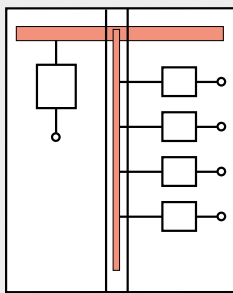

In most installations, PrismaSeT HD enclosures do not require partitioning. In this case, the switchboard is a Form 1.

Safety being one of its foremost goals, Schneider Electric offers options and features that go well beyond the recommendations of the standard.

Form 2b

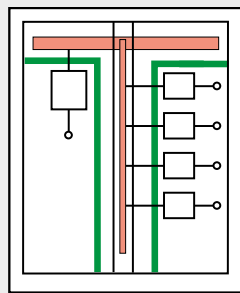

- Terminals for external conductors separated from busbars.
- The functional units and the terminals are separated from the busbars.

Form 3b

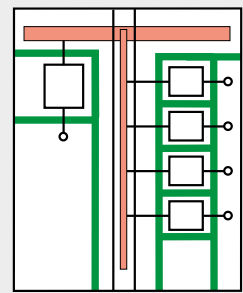

- Terminals for external conductors separated from busbars.
- The functional units are separated from each other and from the busbars.
- The terminals are separated from the busbars, but not from each other.

Form 4a

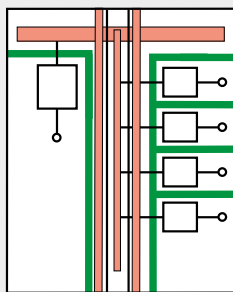

Terminals for external conductors in the same compartment as the associated functional unit.

Form 4b

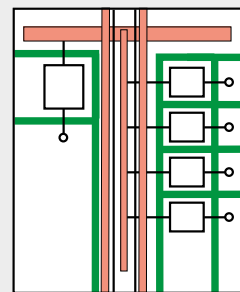

Terminals for external conductors not in the same compartment as the associated functional unit, but in individual, separate, enclosed protected spaces or compartments.

Upgradeable functional units

Functional units include switchgear mounting plates, front plates, connection supports, barriers, etc.



MasterPact MTZ2
from 800 to 4000 A



MasterPact MTZ1
from 600 to 1600 A



ComPact NSX
up to 630 A



ComPact NS
from 630b to 1600 A



ComPact NS
up to 3200 A



EasyPact
from 100 to 630 A



ComPact INS-INV250-630 A



ComPact INS-INV630-2500 A



Source changeover systems
ComPact/MasterPact



Source changeover systems
ComPact INS





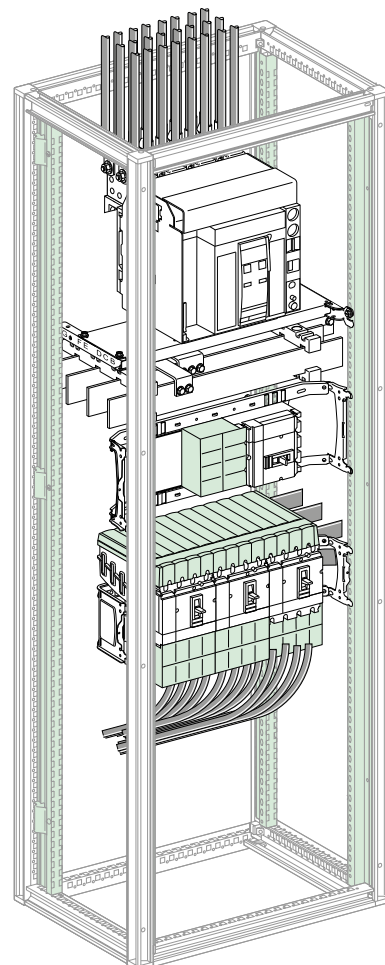













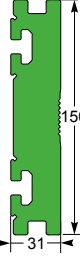
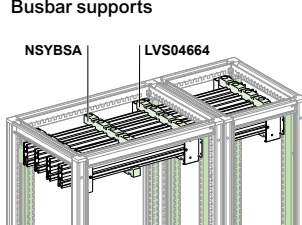

FuPact from 32 to 1250 A

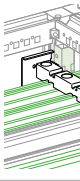

For more information see catalog PrismaSeT P [DESW024EN](#)

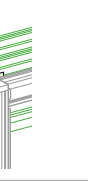











Linery LGYE - Horizontal profiles up to 4000 A

Installation in PrismaSeT HD		Up to 1600 A					Up to 4000 A					
Linery profile, 2000 mm length												
		630 A	800 A	1000 A	1250 A	1600 A	2000 A	2500 A	3200 A	4000 A		
Permissible current for an ambient temperature of 35 °C around the switchboard	IP ≤ 31	630 A	800 A	1000 A	1250 A	1650 A	2000 A	2440 A	3200 A	3620 A		
	IP > 31	530 A	680 A	850 A	1050 A	1480 A	1650 A	2100 A	2800 A	3350 A		
Number of profiles per phase		1										
Total number of vertical modules (50 mm)		3					3		4			
References		LVS04560	LVS04561	LVS04562	LVS04563	LVS04564	LVS04565	LVS04566	LVS04567	LVS04568		
Busbar supports		 <p>Fixed support LVS04664 Free support NSYBSA</p> <p>2 fixed supports for PrismaSeT HD 700 wide frame are compulsory. 1 fixed support for 300/400 wide frame are compulsory. If more supports are needed, add free supports.</p>										
In enclosure: W700 Busbar supports 75 mm distance between bars	Number of supports depending on I _{cw} (kA rms/1 s)	≤ 15	2									
		≤ 25	2									
		≤ 30	2									
		≤ 40	2									
		≤ 50	2									
		≤ 60	2+1				2					
		≤ 65						2+1				
		≤ 75						2+1				
		≤ 85						2+1				
≤ 100							2+2					
References Fixed support		LVS04664				LVS04664 + LVS04671 (order 1 per support)		LVS04664 + LVS04646 (sold in lots of 12 spacers)				
References Free support		NSYBSA				NSYBSA + LVS04671 (order 1 per support)		NSYBSA + LVS04646 (sold in lots of 12 spacers)				
In duct: W300 Busbar supports 75 mm distance between bars	Number of supports depending on I _{cw} (kA rms/1 s)	≤ 15	1									
		≤ 25	1									
		≤ 30	1									
		≤ 40	1									
		≤ 50	1									
		≤ 60	1									
		≤ 65	1 + 1									
		≤ 75	1 + 1									
		≤ 85	1 + 1									
≤ 100							1 + 1					
References Fixed support		LVS04664				LVS04664 + LVS04671 (order 1 per support)		LVS04664 + LVS04646 (sold in lots of 12 spacers)				
References Free support		NSYBSA				NSYBSA + LVS04671 (order 1 per support)		NSYBSA + LVS04646 (sold in lots of 12 spacers)				
Joints		Up to 1600 A					Up to 4000 A					
												
		LVS04620		LVS04623		LVS04624						
References (3P)		3x LVS04620				3x LVS04621		3x LVS04623				
References (4P)		4x LVS04620 + LVS04624				4x LVS04621 + LVS04624		4x LVS04623 + LVS04624				
		Reference LVS04624 is compulsory when installing jointed Linery LGYE 4P busbars and must be fitted where the frames meet. When installed at the bottom of an enclosure, the busbar must be partitioned.										

Linergy BS - Horizontal flat busbars up to 4000 A



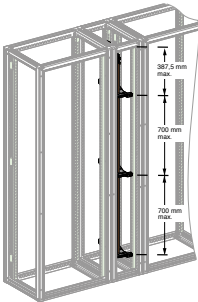

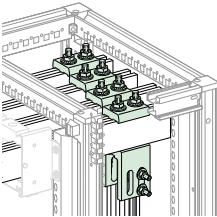
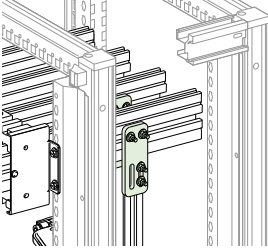

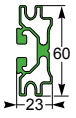

Installation in PrismaSeT HD		Up to 1600 A				Up to 4000 A						
Copper bar, 2000 mm length												
Note: When installed at the bottom of an enclosure, the busbar must be partitioned.												
Permissible current for an ambient temp. of 35 °C around the switchboard	IP ≤ 31	800 A	1000 A	1400 A	1800 A	1800 A	2050 A	2300 A	2820 A	3300 A	3760 A	
	IP > 31	750 A	900 A	1250 A	1600 A	1600 A	1850 A	2000 A	2500 A	2900 A	3340 A	
Busbar cross-section (mm)		60 x 5	80 x 5	60 x 5	80 x 5	80 x 10	50 x 10	60 x 10	80 x 10	100 x 10	120 x 10	
Number of busbars per phase		1	1	2	2	1	2	2	2	2	2	
Total number of vertical modules (50 mm)		3									4	
References		LVS04536	LVS04538	LVS04536	LVS04538	LVS04548	LVS04545	LVS04546	LVS04548	LVS04550	LVS04552	
Busbar supports		<p>Fixed support LVS04664 Free support NSYBSA</p> <p>2 fixed supports for PrismaSeT HD 700 wide frame are compulsory. 1 fixed support for 300/400 wide frame are compulsory. If more supports are needed, add free supports.</p>										
In enclosure: W700 with 75 mm distance between bars	Number of supports depending on I_{ew} (kA rms/1 s)	≤ 15	2									
		≤ 25	2+1	2								
		≤ 30	2+1	2								
		≤ 40	2+1	2								
		≤ 50	-	2+1	2							
		≤ 60	-			2+1						
		≤ 65	-			2+1						
		≤ 75	-			2+2	2+1					
≤ 85	-			-	2+1							
References Fixed support		LVS04664				LVS04664		LVS04664 + LVS04671				
References Free support		NSYBSA				NSYBSA		NSYBSA + LVS04671				
In duct: W300 with 75 mm distance between bars	Number of supports depending on I_{ew} (kA rms/1 s)	≤ 30	1									
		≤ 50	1+1		1							
		≤ 85			2							
References (depending on depth) Fixed support		NSYBHS500 (D500) or NSYBHS600 (D600) or NSYBHS800 (D800)				NSYBHS500 (D500) or NSYBHS600 (D600) or NSYBHS800 (D800)		NSYBHS500 (D500) or NSYBHS600 (D600) or NSYBHS800 (D800) + LVS04671				
References (depending on depth) Free support		NSYBSA				NSYBSA		NSYBSA + LVS04671				
Joints		Up to 1600 A				Up to 4000 A						
		1 vertical bar per phase		2 vertical bars per phase		1 vert. bar per phase		2 vertical bars per phase				
Busbar cross-section (mm)		60 x 5	80 x 5	60 x 5	80 x 5	80 x 10	50 x 10	60 x 10	80 x 10	100 x 10	120 x 10	
Sliding joints with self-breaking lock nut		<p>LVS04640</p>				<p>LVS04641</p>				<p>LVS04643</p>		
References		LVS04640	LVS04641	LVS04640	LVS04641	LVS04641	LVS04640	LVS04640	LVS04641	LVS04641	LVS04643	

Linergy LGY - Lateral profiles up to 1600 A

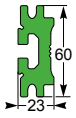
In PrismaSeT HD duct		W300																				
																						
																						
		630 A	800 A	1000 A	1250 A	1600 A																
Permissible current for an ambient temp. of 35 °C around the switchboard	IP ≤ 31	590 A	760 A	950 A	1170 A	1480 A																
	IP > 31	590 A	760 A	950 A	1170 A	1480 A																
Number of profiles per phase		1																				
References		LVS04502	LVS04503	LVS04504	LVS04505	LVS04506																
 <p>Number depending on I_{cw} (kA rms/1 s)</p> <table border="1"> <tr><td>≤ 25</td><td>3</td></tr> <tr><td>≤ 30</td><td>3</td></tr> <tr><td>≤ 40</td><td>3</td></tr> <tr><td>≤ 50</td><td>4</td></tr> <tr><td>≤ 60</td><td>5</td></tr> <tr><td>≤ 65</td><td>5</td></tr> <tr><td>≤ 75</td><td>7</td></tr> <tr><td>≤ 85</td><td>8</td></tr> </table> <p>Only for enclosures with a depth ≥ 500 mm</p>		≤ 25	3	≤ 30	3	≤ 40	3	≤ 50	4	≤ 60	5	≤ 65	5	≤ 75	7	≤ 85	8	 <p>Fixed support LVS04651</p>		<p>Note: An end stop must be fitted on the bottom support: LVS01109 (sold in lots of 12)</p>		
		≤ 25	3																			
		≤ 30	3																			
		≤ 40	3																			
		≤ 50	4																			
		≤ 60	5																			
		≤ 65	5																			
		≤ 75	7																			
≤ 85	8																					
References		LVS04651 (set of 2 upright adapters NSYSFPA for installation in PrismaSeT HD enclosure)																				
Connections to the Linergy BS horizontal busbar				<p>Note: Supplied with mounting hardware. Reference include 1 connection only. Order 1 connection per phase.</p>																		
References according to horizontal busbar size	5 mm thick	LVS04634		LVS04635																		
	10 mm thick Width ≤ 80 mm	LVS04636																				
	10 mm thick Width > 80 mm	LVS04636 + LVS04642 LVS04638 + LVS04642																				
Connections to the Linergy LGYE horizontal busbar				<p>Note: Supplied with mounting hardware. Reference include 1 connection only. Order 1 connection per phase.</p>																		
References (vertical connection)		LVS04602																				
References (vertical shifted connection)		LVS04603																				

(1) Dedicated connection LVS04603 for Linergy LGYE busbar in 150 mm duct with horizontal jointing.

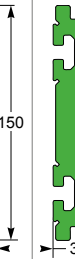
Linery LGYE - Lateral profiles up to 4000 A

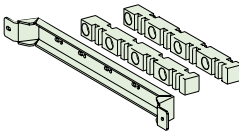
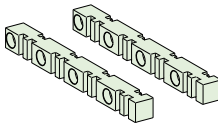
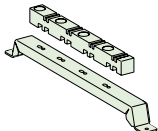
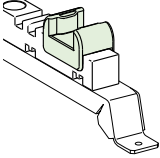
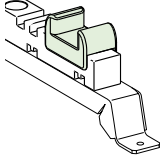
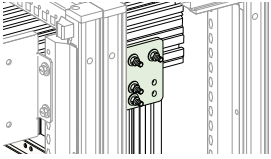
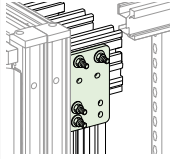
In PrismaSeT HD duct		W300									
Linery profile, 2000 mm length											
		630 A	800 A	1000 A	1250 A	1600 A	2000 A	2500 A	3200 A	4000 A	
Permissible current for an ambient temperature of 35 °C around the switchboard	IP <= 31	630 A	800 A	1000 A	1250 A	1650 A	2000 A	2440 A	3200 A	3620 A	
	IP > 31	530 A	680 A	850 A	1050 A	1480 A	1650 A	2100 A	2800 A	3350 A	
Length to cut for side-mounted		1675 mm						1625 mm			
Number of profiles per phase		1									
Height available (mm)		150					150		200		
References		LVS04560	LVS04561	LVS04562	LVS04563	LVS04564	LVS04565	LVS04566	LVS04569	LVS04510	
											
		Fixed support NSYBVS500			Free support NSYBSA			Bottom support NSYAS500			
		3 fixed supports are compulsory to hold the busbar in position. If more than 3 supports are needed, use free supports (in addition).									
	Number depending on I _{cw} (kA rms/1 s)	≤ 30	3								
		≤ 40	-	3+2 *			3				
		≤ 50	-	3+2 *			3				
	≤ 60	-	3+2 *					3			
	≤ 65	-				3+2 *					
	≤ 75	-				3+4 **		3+2 *			
	≤ 85	-				3+4 **					
	≤ 100	-						3+6 ***			
References* 75 mm distance between bars	W300, D500	NSYBVS500 (fixed) + NSYBSA (free) + NSYAS500 (spacer) (1)									
	W300, D600	NSYBVS600 (fixed) + NSYBSA (free) + NSYAS600 (spacer) (1)									
	W300, D800	NSYBVS800 (fixed) + NSYBSA (free) + NSYAS800 (spacer) (1)									
References* 115 mm distance between bars	W300, D800	NSYBVS800L (fixed) + LVS04678 (free) + NSYAS800L (spacer) (1)									
* References of supports depending on distance between bars and duct depth		(1) If using a 100 x 10 bars, add a pack of screws ref. LVS04671 for each fixed support and free support.									
Wedging busbars in position											
		Wedge fitted on bottom support LVS04658				Wedge fitted on bottom support LVS04659					
		The bottom support is used to place profiles and ensure they are in the correct position. It is not considered to be a busbar support.									
References Wedge		LVS04658				LVS04659					
Connections to the Linery LGYE horizontal busbar		2000/2500 A						3200/4000 A			
											
		Supplied with mounting hardware. Reference include 1 connection only. Order 1 connection per phase.									
References (short connection)		LVS04604						LVS04607			
References (long connection)		LVS04605									

Linery BS - Lateral flat busbars up to 3200 A

In PrismaSeT HD duct		W300																								
Pre-slotted copper, 1675 mm length																										
		<table border="1"> <tr> <th>Permissible current for an ambient temp. of 35 °C around the switchboard</th> <th>IP ≤ 31</th> <th>800 A</th> <th>1000 A</th> <th>1400 A</th> <th>1800 A</th> <th>1200 A</th> <th>1400 A</th> <th>1800 A</th> <th>2050 A</th> <th>2300 A</th> <th>2820 A</th> <th>3200 A</th> </tr> <tr> <th>IP > 31</th> <td></td> <td>750 A</td> <td>900 A</td> <td>1250 A</td> <td>1600 A</td> <td>1080 A</td> <td>1250 A</td> <td>1600 A</td> <td>1850 A</td> <td>2000 A</td> <td>2500 A</td> <td>2820 A</td> </tr> </table>	Permissible current for an ambient temp. of 35 °C around the switchboard	IP ≤ 31	800 A	1000 A	1400 A	1800 A	1200 A	1400 A	1800 A	2050 A	2300 A	2820 A	3200 A	IP > 31		750 A	900 A	1250 A	1600 A	1080 A	1250 A	1600 A	1850 A	2000 A
Permissible current for an ambient temp. of 35 °C around the switchboard	IP ≤ 31	800 A	1000 A	1400 A	1800 A	1200 A	1400 A	1800 A	2050 A	2300 A	2820 A	3200 A														
IP > 31		750 A	900 A	1250 A	1600 A	1080 A	1250 A	1600 A	1850 A	2000 A	2500 A	2820 A														
Busbar cross-section (mm)		60 x 5	80 x 5	60 x 5	80 x 5	50 x 10	60 x 10	80 x 10	50 x 10	60 x 10	80 x 10	100 x 10														
Number of profiles per phase		1			2		1			2																
References		LVS04516	LVS04518	LVS04516	LVS04518	LVS04525	LVS04526	LVS04528	LVS04525	LVS04526	LVS04528	LVS04550 (1)														

Busbar supports		3 fixed supports are compulsory to hold the busbar in position. If more than 3 supports are needed, use free supports (in addition). The bottom wedge support is used to place the busbar and ensure it is in the correct position. It does not count as a busbar support.												
	Number of supports depending on I_{cw} (kA rms/1 s)	≤ 15	3 *											
		≤ 25	3+2 *			3 *								
		≤ 30	3+2 *						3 *					
		≤ 40	3+4			3+2 *								
		≤ 50				3+4			3+2 *					
		≤ 60							3+4			3+2 *		
		≤ 65							3+4			3+2 *		
		≤ 75							3+6			3+4		
≤ 85										3+4				

References* 75 mm distance betw. bars	W300, D500	NSYBVS500 (fixed) + NSYBSA (free) + NSYAS500 (spacer) ⁽²⁾
	W300, D600	NSYBVS600 (fixed) + NSYBSA (free) + NSYAS600 (spacer) ⁽²⁾
	W300, D800	NSYBVS800 (fixed) + NSYBSA (free) + NSYAS800 (spacer) ⁽²⁾
References* 115 mm distance betw. bars	W300, D800	NSYBVS800L (fixed) + LVS04678 (free) + NSYAS800L (spacer) ⁽²⁾

* References. of supports depending on distance between bars and duct depth
⁽¹⁾ Copper bar without holes.
⁽²⁾ If using a 100 x 10 bars, add a pack of screws ref. LVS04671 for each fixed support and free support.

Connections to the Linery BS horizontal busbar													
		<p>For a busbar with 75 mm distance between bars, the bars must be completely covered. Staggered assembly points between one bar and the next, to maintain the necessary clearance distances⁽³⁾</p>						<p>References LVS04636, LVS04637, LVS04638 are supplied individually: 1 connection per phase. Reference LVS04642 consists of 2 M8 x 140 screws which can replace the original M8 x 120 screws.</p>					
References depending on horizontal busbar size	≤ 80 mm	LVS04645					LVS04636	LVS04637	LVS04637		LVS04645		
	> 80 mm	LVS04645					LVS04636 + LVS04642	LVS04637 + LVS04642	LVS04637 + LVS04642		LVS04645		



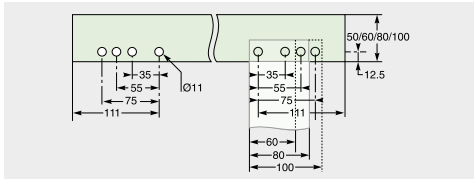



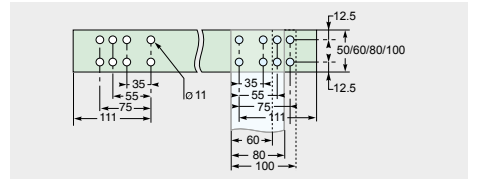



⁽¹⁾ Drill hole dimensions for 5 mm thick horizontal busbars.



Drill hole dimensions for 10 mm thick horizontal busbars.

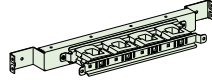
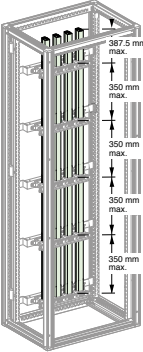
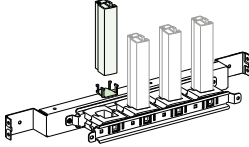
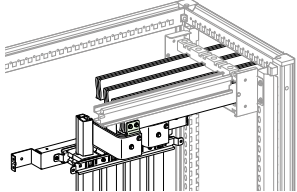
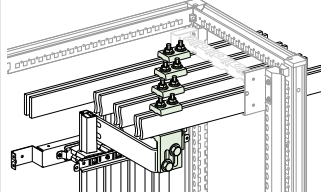
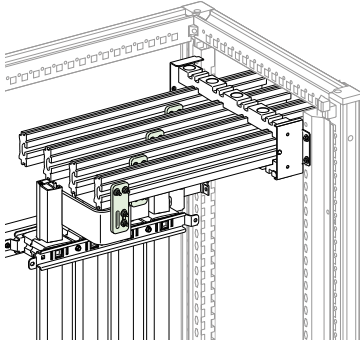

Linergy LGYE - Rear profiles up to 1600 A

At the rear of a PrismaSeT HD enclosure			W700				
							
							
			630 A	800 A	1000 A	1250 A	1600 A
Permissible current for an ambient temp. of 35 °C around the switchboard	IP ≤ 31		680 A	840 A	1040 A	1290 A	1650 A
	IP > 31		590 A	760 A	950 A	1170 A	1480 A
Number of profiles per phase			1				
References			LVS04502	LVS04503	LVS04504	LVS04505	LVS04506
Busbar supports			 <p>Fixed support LVS04652</p>				
	Number depending on I _{ow} (kA rms/1 s)	≤ 25	3				
		≤ 30	4				
		≤ 40	5				
		≤ 50	7				
					 <p>Note: An end stop must be fitted on the bottom support LVS01109 (sold in lots of 12)</p>		
References			LVS04652				
Connections to the Linergy BS horizontal flat busbar			 <p>LVS04635 connection to 5 mm thick horizontal busbar</p>  <p>LVS04636 connection to 10 mm thick horizontal busbar</p>				
			Fixings supplied, order 1 connection per phase. Some parts of the connection require flexible insulated busbars.				
References according to horizontal busbar size	5 mm thick		LVS04635				
	10 mm thick	Width ≤ 80 mm	LVS04636				
	10 mm thick	Width > 80 mm	LVS04636 + LVS04642				
Connections to the Linergy LGYE horizontal flat busbar			 <p>LVS04602 connection to the Linergy LGYE horizontal flat busbar</p>				
			Fixings supplied, order 1 connection per phase. Some parts of the connection require flexible insulated busbars.				
References			LVS04602				

Linery BS - Rear flat busbars up to 1600 A

At the rear of a PrismaSeT HD enclosure			W700																																								
Pre-slotted copper, 1670 mm length																																											
	800 A	1000 A	1400 A	1000 A	1200 A	1600 A																																					
Permissible current for an ambient temperature of 35 °C around the switchboard	IP ≤ 31		800 A	1000 A	1400 A	-	-	-																																			
	IP > 31		750 A	900 A	1250 A	1080 A	1250 A	1600 A																																			
Busbar cross-section (mm)			60 x 5	80 x 5	60 x 5	50 x 10	60 x 10	80 x 10																																			
Number of busbars per phase			1	2	2	1																																					
References			LVS04516	LVS04518	LVS04516	LVS04525	LVS04526	LVS04528																																			
Busbar supports			<p>Fixed busbar support LVS04653 Busbar free support NSYBSA Mounting chocks LVS04669</p> <p>3 fixed supports ref. LVS04653 are compulsory to keep the busbar vertical. If more than 3 supports are needed, use free support ref. NSYBSA (in addition). Metal shim ref. LVS04669 (sold in lots of 100), 5 mm thick, is screwed onto the busbar. It rests on a fixed support and is used to wedge the busbar in position.</p> <p>Wedging: 1 busbar/phase</p> <p>Wedging: 2 busbars/phase</p> <table border="1"> <thead> <tr> <th rowspan="2">Number depending on I_{CW} (kA rms/1 s)</th> <th>≤ 15</th> <td>3</td> <td>3</td> </tr> <tr> <th>≤ 25</th> <td>3+2</td> <td>3</td> </tr> <tr> <th>≤ 30</th> <td>3+2</td> <td>3+2</td> <td>3+2</td> </tr> <tr> <th>≤ 40</th> <td>3+4</td> <td>3+2</td> <td>3+2</td> </tr> <tr> <th>≤ 50</th> <td></td> <td>3+4</td> <td>3+2</td> </tr> <tr> <th>≤ 60</th> <td></td> <td></td> <td>3+4</td> </tr> <tr> <th>≤ 65</th> <td></td> <td></td> <td>3+4</td> </tr> <tr> <th>≤ 75</th> <td></td> <td></td> <td>3+6</td> </tr> <tr> <th>≤ 85</th> <td></td> <td></td> <td></td> </tr> </thead></table>						Number depending on I _{CW} (kA rms/1 s)	≤ 15	3	3	≤ 25	3+2	3	≤ 30	3+2	3+2	3+2	≤ 40	3+4	3+2	3+2	≤ 50		3+4	3+2	≤ 60			3+4	≤ 65			3+4	≤ 75			3+6	≤ 85			
Number depending on I _{CW} (kA rms/1 s)	≤ 15	3	3																																								
	≤ 25	3+2	3																																								
≤ 30	3+2	3+2	3+2																																								
≤ 40	3+4	3+2	3+2																																								
≤ 50		3+4	3+2																																								
≤ 60			3+4																																								
≤ 65			3+4																																								
≤ 75			3+6																																								
≤ 85																																											
References			LVS04653 (fixed) + NSYBSA (free) + LVS04669 (spacer)																																								
Connections to the Linery BS horizontal flat busbar			<p>LVS04635 connection to horizontal busbar 5 mm thick</p> <p>LVS04636 connection to horizontal busbar 10 mm thick</p> <p>For part of the connection, flexible insulated busbars are needed. References LVS04635, LVS04636 are supplied individually = 1 connection per phase. Reference LVS04642 consists of 2 M8 x 140 screws which can replace the original M8 x 120 screws.</p>																																								
References according to horizontal busbar size	5 mm thick		LVS04635																																								
	10 mm thick	Width ≤ 80 mm	LVS04636 ⁽¹⁾																																								
	10 mm thick	Width > 80 mm	LVS04636 + LVS04642 ⁽¹⁾																																								

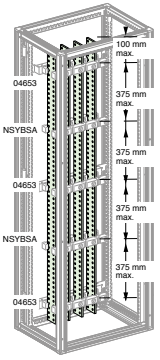

Linery LGYE - Accessories

Linery screw

- Sold in lots of 20: 20 screws + 20 nuts + 20 contact washers, grade 8.8. The screws slide into the profile and are then locked in the desired position.

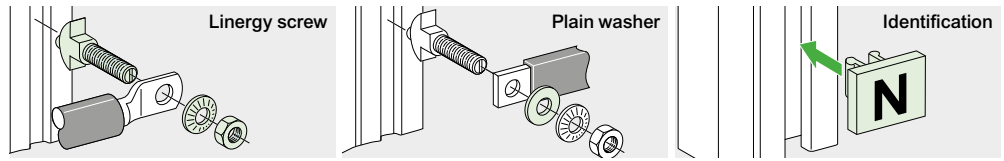

Characteristics	AD	References
M8 sold in lots of 20	20 mm	LVS04772
Steel plain washers		
M8 sold in lots of 20	24 mm	LVS04773
M8 sold in lots of 20	28 mm	LVS04774
Brass plain washers		
M8 sold in lots of 20 for connection of $\leq 25 \text{ mm}^2$ lugs to Linery	20 mm	LVS04775
Identification		
12 clip-on supports + N, L1, L2, L3, PE, PEN labels		LVS04794
Linery LGYE busbar screw plate kit after sales service		LVS01130

M8 screws

- Set of 20 screws + 20 nuts + 40 contact washers.

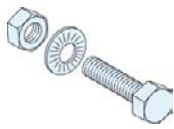

LVS04782

Characteristics	References
Linery BS, 20 screws grade 8.8, M8 x 20	LVS04782
Linery BS, 20 screws grade 8.8, M8 x 25	LVS04783
Linery BS, 20 screws grade 8.8, M8 x 30	LVS04784
Linery BS, 20 screws grade 8.8, M8 x 35	LVS04785
Linery BS, 20 screws grade 8.8, M8 x 40	LVS04786
Linery BS, 20 screws grade 8.8, M8 x 45	LVS04787
Linery BS, 20 screws grade 8.8, M8 x 50	LVS04788

Torque nuts

- Can be used to obtain the correct tightening torque (28 Nm) recommended by the manufacturer, without using a torque wrench. Torque nuts may be used for all electrical connections.



LVS04759

Characteristics	References
20 M8 torque nuts	LVS04759

Voltage tap-offs

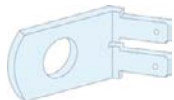

LVS04229

- For small lugs (on low-current cables or measurement tap-offs), insert a conducting washer (ref. LVS04775) between the busbar and the lug.

Characteristics	References
20 M10 voltage tap-offs for two 6.35 mm tab connectors	LVS04229

Connections on Linery LGYE and LGY

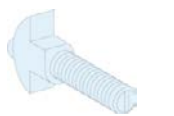

LVS04766



LVS04768



LVS04769

Characteristics	InA	bar	Utilisation	References
Use the 25 mm Linery screw	0 A to 630 A	Cable Insulated flexible bar	Recommended	LVS04766
Use the 39 mm Linery screw is only compatible with Linery LGY.	0 A to 630 A	Cable Insulated flexible bar	Possible	LVS04767
Use the 25 mm Linery screw	800 A to 1250 A	5 mm thick bar	Recommended	LVS04766
Use the 39 mm Linery screw is only compatible with Linery LGY.	800 A to 1250 A	5 mm thick bar	Possible	LVS04767
Use the flat plate screw with 2 studs	800 A to 1250 A	5 mm thick bar	Possible	LVS04768
Use the flat plate screw with 2 studs	1600 A to 2500 A	5 or 10 mm thick bar	Recommended	LVS04768
Use the 39 mm Linery screw is only compatible with Linery LGY.	1600 A to 2500 A	5 or 10 mm thick bar	Possible	LVS04767
Use the flat plate screw with 3 studs	3200 A to 4000 A	10 mm thick bar	Recommended	LVS04769

Form 1 partitioning

Presentation:

Decisions concerning the form of separation and the degree of protection are the subject of an agreement between the manufacturer and the user.

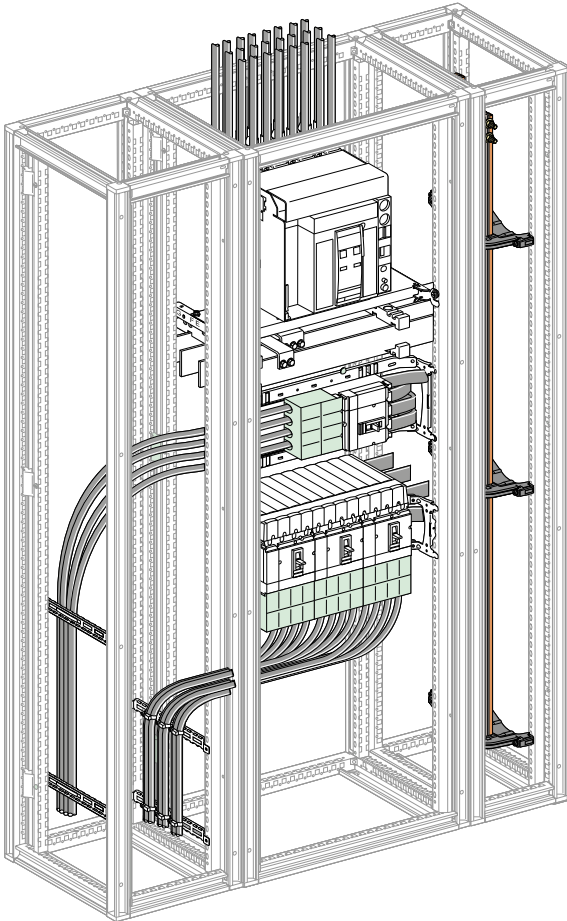

The protection of life and property is ensured by the systematic installation of terminal shields on Compact NSX circuit breakers and on Compact INS and INV switch-disconnectors (see the pages on the functional units).

11

In most installations, PrismaSeT HD enclosures do not require partitioning. In this case, the switchboard is a Form 1. Safety being one of its foremost goals, Schneider Electric offers options and features that go well beyond the requirements of the standard.

The protection of life and property is a standard feature due to:

- Front plates that require a tool to be removed
- Keylocks on doors, some of which provide access to live parts
- The systematic installation of terminal shields on Compact NSX circuit breakers and Compact INS and INV switch-disconnectors.

What is more, PrismaSeT HD offers different levels of partitioning to create separations inside the enclosures and thus create Form 2b, 3b, 4a and 4b electrical switchboards.

Electrical switchboards must meet the IP2X degree of protection to comply with standard IEC 61439-2

Form 2b partitioning

Note:

If the busbars are at the bottom of the enclosure, gland plates are mandatory.

Separation of busbars from the functional units:

- Protection against contact with live parts upstream of the outgoing circuits
- Protection against penetration by foreign solid bodies.

Lateral partitioning; Form 2 restoration for side-barrier cut-out

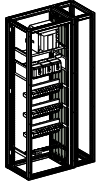

LVS06545

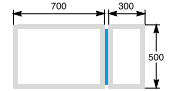

Characteristics	References
Lateral partitioning <ul style="list-style-type: none"> • Vertical barrier made of insulated slats. • Can be installed on both sides of Linergy and flat busbars. • The space between the slats is sufficient for prefabricated connections (one copper bar, 5 or 10 mm thick, or insulated flexible bars) or for cables up to 35 mm², while maintaining the IP2X degree of protection in compliance with standard IEC 60695.2.1 concerning fire resistance. 	LVS06545
Form 2 restoration for side-barrier cut-out <ul style="list-style-type: none"> • This kit enables the passage of the connection between a device > 1600 A (MTZ2, INS) and lateral vertical busbars. • It is made up of an insulated plate (six modules H 300 mm) that can be cut as required, supplied with supports and the necessary hardware. 	LVS04924

Partitioning extension

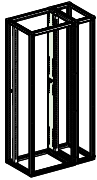

LVS06541

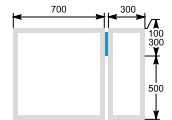

- The partitioning extension is required for PrismaSeT system switchboards with a depth of 600 or 800 mm.

Characteristics	References
D600	LVS06541
D800	LVS06543

Front and rear barrier

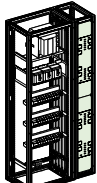

LVS06540

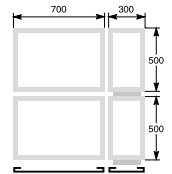

Characteristics	References
<ul style="list-style-type: none"> • Front protection is realized by the combination of door W300 and this barrier. • Metal barrier, composed of 2 parts H850, pre-cut at both ends. • Rear protection, a barrier is required at the rear of the busbar compartment in enclosures that are 800, 1000 or 1300 mm deep. 	LVS06540

Inter-enclosure partitioning

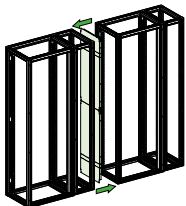

LVS06555

- Metal partition, used to separate two adjacent enclosures.
- It is made up of two panels, each 850 mm high.
- The top and bottom ends have knock-outs for horizontal busbars.
- Supplied with the necessary supports and hardware, the partition is mounted on the framework and does not hinder installation of the functional mounting plates.

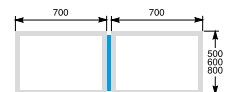

Characteristics	References
D500	LVS06555
D600	LVS06555 + LVS06541
D800	LVS06555 + LVS06543

Partitioning of horizontal busbars

- Set of two barriers (front and rear), plus a slotted rear panel for efficient natural convection in the switchboard.
- The set can be used to partition horizontal busbars installed at the top or bottom of the enclosure.
- The space required for the busbars is not increased.



LVS06560

Characteristics	References
3M-busbar, W300, D500	LVS06560
3M-busbar, W300, D600	LVS06561
3M-busbar, W300, D800	LVS06563
4M-busbar, W300, D500 or D600 or D800	LVS06568

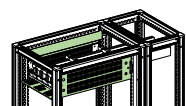

LVS06570

3M-busbar, W700, D500 or D600 or D800	LVS06570
4M-busbar, W700, D500 or D600 or D800	LVS06567

Form 3b partitioning

Separation of busbars from the functional units and separation of all functional units from one another.
 Separation of the terminals for external conductors from the functional units, but not from each other.

- Protection against contact with live parts
- Reduction in the risk of faults between the functional units (propagation of electrical arcs, etc.).

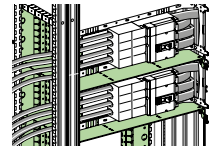

Front connection

- A horizontal metal partition can be used to physically separate functional units from one another.

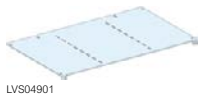

LVS04901

Characteristics	References
Horizontal metal partition, W650 mm	LVS04901

- It is fixed at the rear by a support (two uprights) secured to the framework (500 mm deep) or to the intermediate uprights (800 mm deep frameworks).

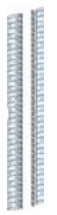

LVS04943

Characteristics	References
Rear support for partitions, W650 mm	LVS04943

- A set of brackets can be used to install partial Form 3 partitioning in the enclosure.
- It does not take up any useful space in the switchboard.

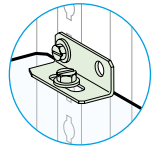

LVS03583

Characteristics	References
6 universal angle brackets	LVS03583

Rear connection

- Vertical partitions (two cat. no. per functional unit)

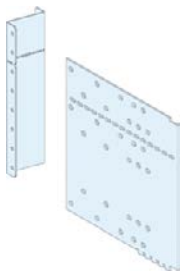
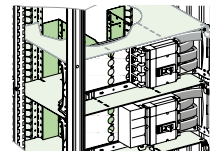

LVS04955

Characteristics	References
3 to 4 modules	LVS04955
5 to 6 modules	LVS04956

Form 4 partitioning

Separation of busbars from the functional units and separation of all functional units from one another, including the terminals for external conductors which are an integral part of the functional unit.

- Protection against contacts with live parts and reduction in the risk of faults between the functional units (propagation of electrical arcs, etc.).
- Form 4a: Terminal for external conductors in the same compartment as the associated.
- Form 4b: Terminals for external conductors not in the same compartment as the associated functional unit, but in individual, separate, enclosed protected spaces or compartments.

Form 4a partition for front connection

- Backplate (one cat. no. per enclosure) made up to two metal half panels mounted on the rear supports for Form 3 partitions. This backplate is not indispensable for 500 mm deep frameworks.

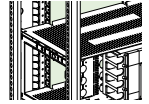

LVS04946

Characteristics	References
Form 4a backplate (one cat. no. per enclosure)	LVS04946

Form 4a gland plate

- Plastic gland plate that can be easily cut-out (one for each functional unit) and is mounted on the framework.

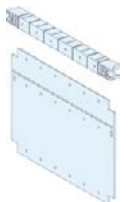
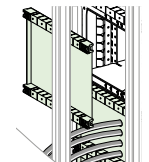

LVS04951

Characteristics	References
3 or 4 modules	LVS04951
5 or 6 modules	LVS04952

Form 4b partition

- Cover with metal gland plates that can be easily cut-out on the side and bottom. It is available in two heights:

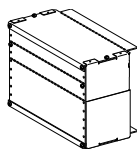
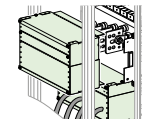

LVS06600

Characteristics	References
3 to 5 modules	LVS06600
4 to 6 modules	LVS06601

Connection transfer assembly, 3 to 5 modules, 250 A

- Transfer assembly without connections to simplify cable installation.

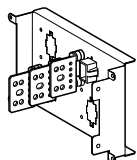

LVS06606

Characteristics	References
3P	LVS06606
4P	LVS06607

Connection transfer assembly, 4 to 6 modules, 630 A

- Transfer assembly without connections to simplify cable installation.

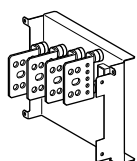



LVS06605

Characteristics	References
3P	LVS06604
4P	LVS06605

Common characteristics

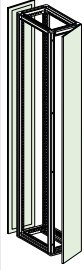
- Roof characteristics:
 - equipped with a factory-mounted polyurethane (PUR) gasket
 - supplied with mounting hardware
 - with markings for clear identification of cable-running zones
- The cable compartment can be mounted on the right or left.
- Can be combined side-by-side or back-to-back.
- Receive the IP55 cover panels.

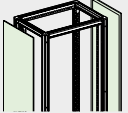
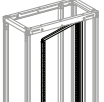
Mounting			W700			W300		
								
Depth			D500	D600	D800	D500*	D600	D800
Enclosures for front connection H2000	Plain-door enclosure	White RAL 9003	NSYSFP20750ED	-	NSYSFP20780ED	NSYSF20350ED	-	NSYSF20380ED
		Grey RAL 7035	NSYSFP20750G	NSYSFP20760G	NSYSFP20780G	NSYSF20350	NSYSF20360	NSYSF20380
Additional enclosure for rear connection H2000	Transparent-door enclosure	White RAL 9003	NSYSFP20750TED	-	NSYSFP20780TED	-	-	-
		Grey RAL 7035	NSYSFP20750TG	NSYSFP20760TG	NSYSFP20780TG	-	-	-
	Vertical uprights	White RAL 9003	NSYSFV20ED	-	-	NSYSFV20ED	-	-
		Grey RAL 7035	NSYSFV20	-	-	NSYSFV20	-	-
		Bottom and top frame wit roof	White RAL 9003	NSYSFC75ED	-	-	NSYSFC35ED	-
		Grey RAL 7035	NSYSFC75	-	-	NSYSFC35	-	-
Adapter uprights for busbar installation in vertical on Linergy LGY			-	-	-	NSYSFPAED	NSYSFPAED + NSYSUCR40200	NSYSFPAED + NSYSUCR40200
	Side panel (Set of 2)**	White RAL 9003	NSY2SP205ED	NSY2SP206ED	NSY2SP208ED	NSY2SP205ED	NSY2SP206ED	NSY2SP208ED
		Grey RAL 7035	NSY2SP205	NSY2SP206	NSY2SP208	NSY2SP205	NSY2SP206	NSY2SP208
	Hinged front plate support frame***		LVS08566	LVS08566	LVS08566	-	-	-
								

* For cables and to install Linergy LGY, LGYE, BS Busbars.

** An earthing braid must be installed between the lateral panels and the frame.

*** Reversible for left or right-hand opening.

Accessories

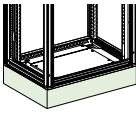
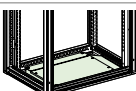
Width			W700			W300		
Depth			D500	D600	D800	D500	D600	D800
	Plinth H100*	Front and rear cross-pieces	NSYSPF7100	NSYSPF7100	NSYSPF7100	NSYSPF3100	NSYSPF3100	NSYSPF3100
		Lateral cross-pieces	NSYSPS5100	NSYSPS6100	NSYSPS8100	NSYSPS5100	NSYSPS6100	NSYSPS8100
	Plinth H200*	Front and rear cross-pieces	NSYSPF7200	NSYSPF7200	NSYSPF7200	NSYSPF3200	NSYSPF3200	NSYSPF3200
Lateral cross-pieces		NSYSPS5200	NSYSPS6200	NSYSPS8200	NSYSPS5200	NSYSPS6200	NSYSPS8200	
	Single-entry gland-plates		NSYEC751	NSYEC761	NSYEC781	NSYEC351	NSYEC361	NSYEC381

* The plinth is made up of two catalog numbers: Front and rear cross-pieces + lateral cross-pieces.

Technical changes reserved. Information provided without guarantee. Images are for illustrative purposes only.

Coupling kit

- Side-by-side combination
- Back-to-back combination: D500+D500, D800+D500
- Back-to-back combination must be shipped individually and combined during on-site installation

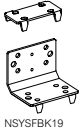

NSYSFBK19

Characteristics	References
Spacial SF coupling kit for SF enclosures equipped with swinging 19" rack, IP55	NSYSFBK19

4 lifting rings

- Use a set of lifting rings for each framework for one framework (W700 mm) containing devices



NSYSFEB

Characteristics	References
Spacial SF M12 lifting eyebolt, galvanized cast steel	NSYSFEB

4 lifting brackets

- When two enclosures with devices have been combined, use a lifting beam.

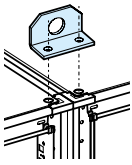

NSYSFELB

Characteristics	References
Set of 4 Spacial SF lifting bracket, zinc-coated steel	NSYSFELB

Set of 20 screws + M6 nuts



LVS06461

Characteristics	References
20 screws and M6 nuts	LVS06461

Earthing cable, 6 mm²

The cable is equipped with a 4 mm diameter lug at one end and a 6 mm diameter lug on the other.

The earthing cable is used to earth:

- A door or wicket door with devices
- A front-plate support frame equipped with switchgear in an enclosure.



LVS08911

Characteristics	References
Earthing cable 6 mm	LVS08911

Earthing braid

- An earthing braid must be installed between the roof and the frame.
- For NSYEL166D8: Length 160 mm, Section 6 mm², Terminal 8.3 mm.
- For NSYEL3525D8: Length 350 mm, Section 25 mm², Terminal 8.3 mm.



NSYEL166D8

Characteristics	References
Earth leads section 6 mm ² , length 160 mm	NSYEL166D8
Earth leads section 25 mm ² , length 350 mm	NSYEL3525D8

Ground fastening

Note:
Incoming by pre-fabricated busbar trunking is forbidden for seismic applications.

Seismic plinth H100 mm for seismic application 3G withstand

1600 A configuration *	Height (mm)	Width (mm)	Depth (mm)	References
PrismaSeT HD	2000	700	500	NSYS5GPC75
Busbar duct	2000	300	NSYS5GPC35	
configuration 3200 A	Height (mm)	Width (mm)	Depth (mm)	References
PrismaSeT HD	2000	700	800	NSYS5GPC78
Busbar duct	2000	300	800	NSYS5GPC38

* Not compatible for depth 600 mm.

Ground fastening

Front connection

(Example: device enclosure W700 mm + compartment W300 mm)

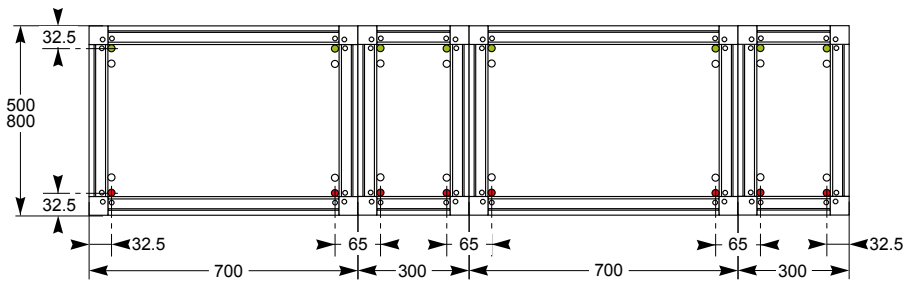

Rear connection D1000

(Example: device enclosure + compartment D500 + D500 mm)

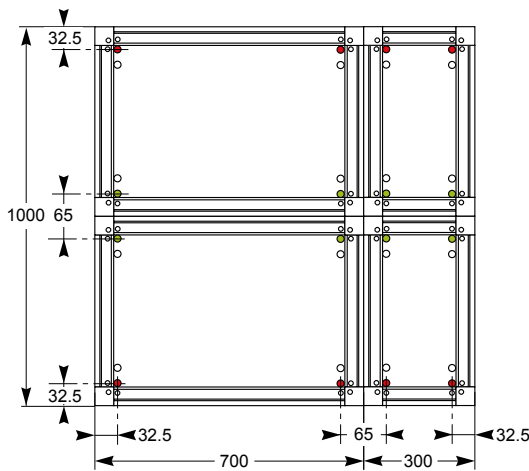

Rear connection D1300

(Example: device enclosure + compartment D800 + D500 mm)

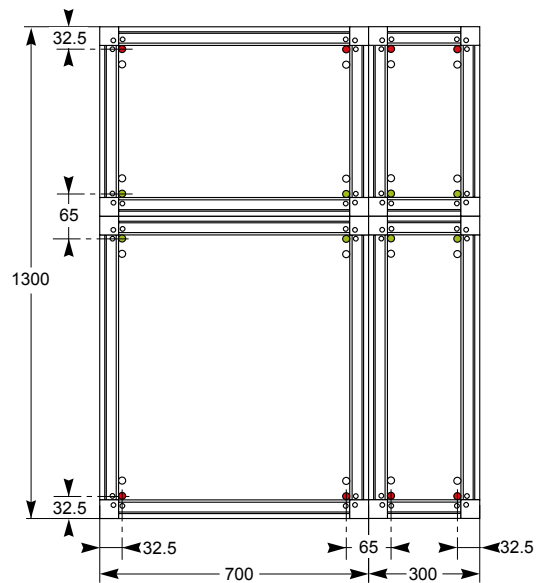

- compulsory fixing point
- optional fixing point

- 8.8-class screws: Screw M10 TH
- + washers (external Ø 25 mm, thickness 3 mm)
- + CS contact washers Ø 10 mm.

Enclosures

Profile

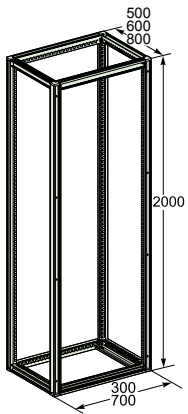

Cover panels, plain or transparent door, lateral panel

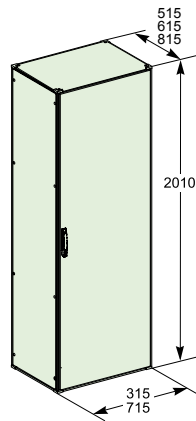

Standard plinth

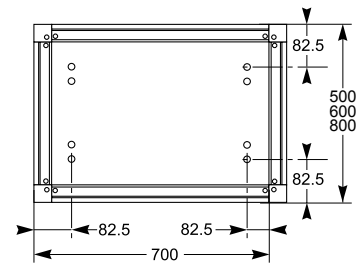

Gland plates

W300

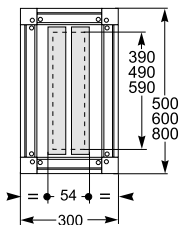

W700

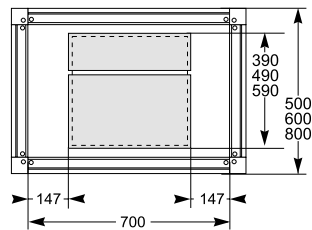

Functional system in PrismaSeT HD switchboards, enclosure mounting

D500, D600, D800

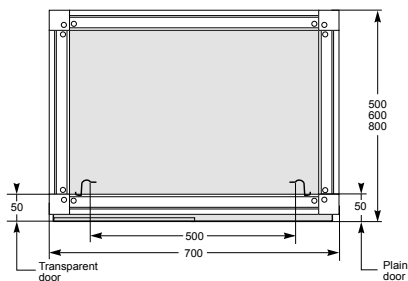

Busbars mounting, lateral vertical busbars

1600 A

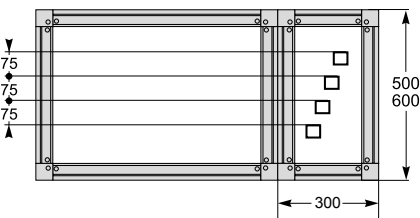

2000

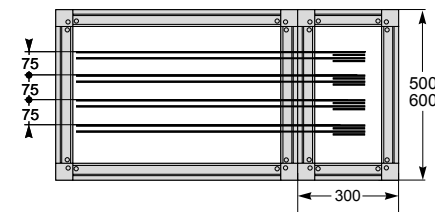

2500 A up to 4000 A

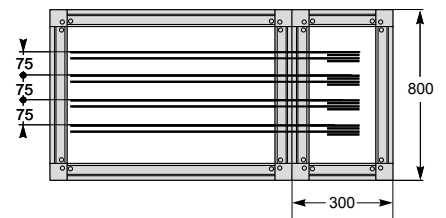

Enclosure with compartments for Motor Control Centers

SFM

Switchboards with fixed compartments for Motor Control Centers

Spacial SFM enclosures with fixed compartments are used for Motor Control Centers in industrial environments (IP54).

They have been tested taking into account device characteristics.

This ensures a high degree of reliability in system operation and optimal safety.

Devices can be mounted on universal mounting plates on a workout-out to simplify installation in the switchboard.

Fixed functional system for Motor Control

The fixed functional system for Motor Control Centers is designed for installation of motor starters up to 250 kW.



In addition to the motor power and the starter type (direct, reversing, star-delta...), 4 main criteria must be considered when choosing a motor starter:

- The operating voltage,
- The type of thermal protection, electro-mechanical or electronic,
- The type of magnetic protection according to the switchboard's Isc,
- The type of installation according to the required availability level.

Operating voltage

A network's operating voltage is a decisive parameter in the choice of motor protection. The operating voltage will have an impact on the device performance and the installation constraints.

For instance, the voltage will influence:

- The breaking performances,
- The safety areas.

Motor protection

Protecting the motors to extend their lifetime

- Overheating in electric motors is caused by copper and ferro-magnetic losses:
 - the current I is proportional to the motor's load. Copper losses are proportional to I^2 (stator and rotor),
 - hysteresis cycles in ferro-magnetic materials and the induced Foucault currents cause overheating, which is in particular proportional to frequency.
- The consequence of abnormal overheating is a reduced isolation capacity of the materials, thus leading to a significant shortening of the motor lifetime, as shown in the opposite diagram.
- In continuous or semi-continuous processes, availability is a major issue. It is therefore decisive to observe accurately the operating conditions of the motors.
- Motor protection relays are the components dedicated to this task. They provide various levels of accuracy and functionalities, in order to meet the expectations of the process manager.

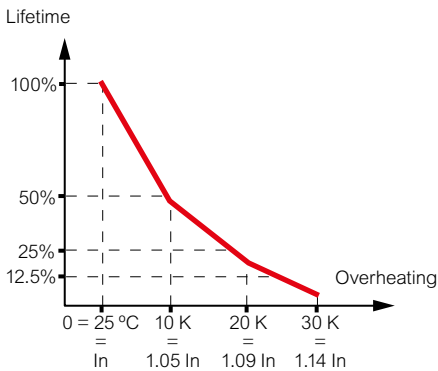
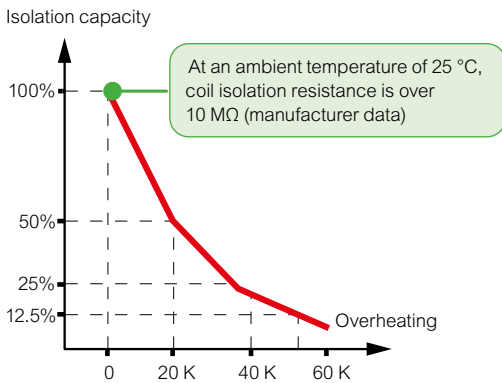

Supervising finely the motors to improve process availability

- An electric motor converts electric energy into mechanical energy. When voltage, current and frequency change, the speed and torque of the motor change as well. And conversely, any changes in charge have a direct impact on the electrical parameters.
- Electromechanical thermal relays protect the motor against overloads.
- Electronic relays protect the motor against overloads on the basis of very sophisticated and highly accurate thermal patterns.
- These relays can identify motor overload conditions and transmit the information, alerting the operator of problems,
- These relays transmit many complementary parameters, providing information to operators and allowing them to take action against motor stops or to restart a motor quickly if a stop has occurred.

Examples:

- Motor underload may indicate pump cavitation,
- Phase inversion may indicate a maintenance fault that would be difficult to diagnose without such information.
- In addition to the current, electronic relays can also monitor voltage, and consequently power and power factor. They can also monitor leakage current and measure coil temperature if a sensor is integrated. These data can be used for preventive maintenance and are helpful when resolving problems.
- Finally, electronic relays assume information processing functions such as state and fault statistics. They are also able to provide logical solutions and to respond to process-specific requirements.

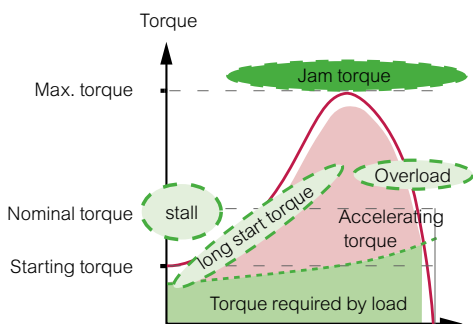

Motor Protection

Magnetic protection: Circuit-breakers and fuses

Schneider Electric have chosen to promote circuit-breakers wherever possible because of their advantages in terms of maintenance and quick reactivation.

Universal solution that can be exported to all countries, unlike fuses which must differ national standards,

- Reduced dimensions,
- Limited temperature rise,
- Faster maintenance,
- No risk of over-rating the fuse cartridge (causing motor destruction) or underrating (untimely tripping).

Special SFM: A combination for motor starter control

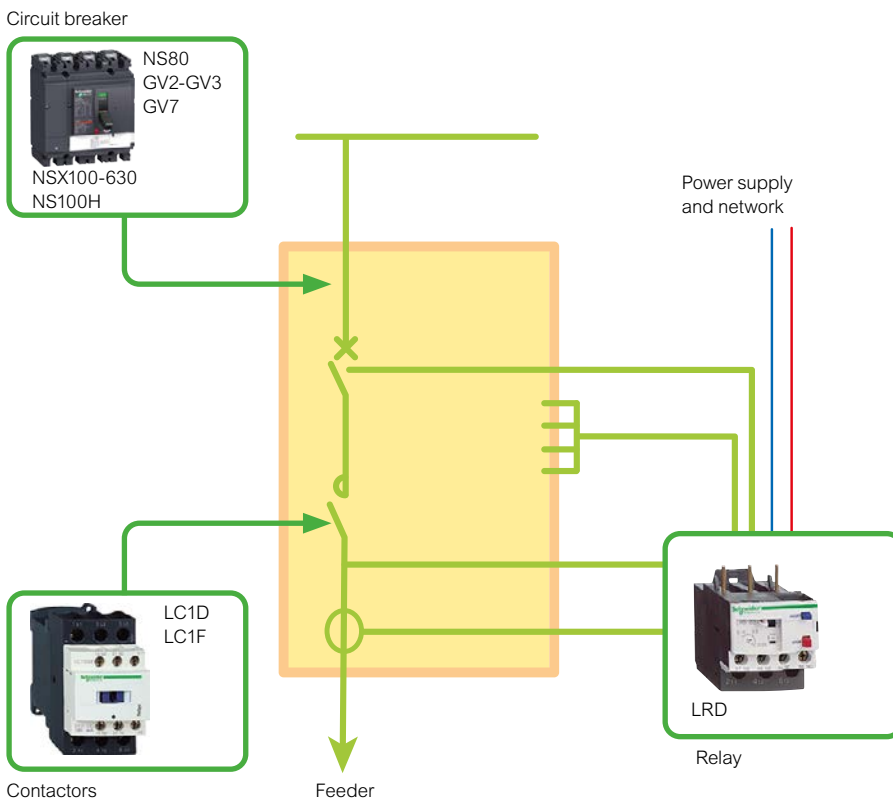

Type 1 coordination

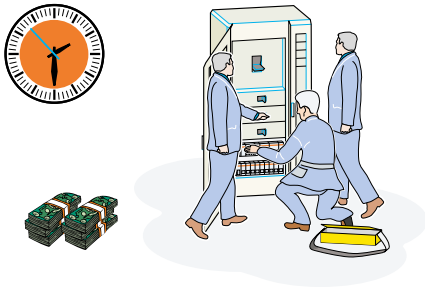

Type 2 coordination

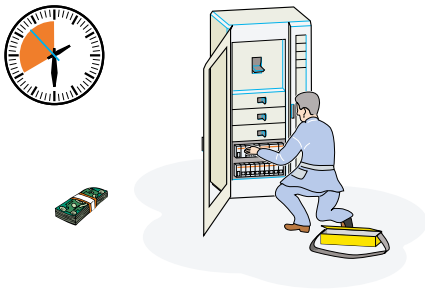

Total coordination

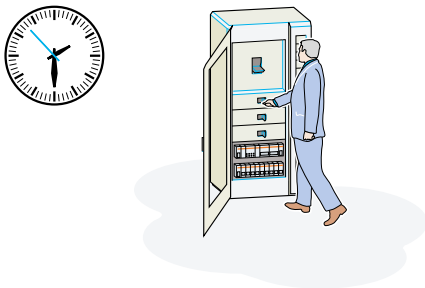

Coordination, what is it about?

A motor starter can be made up of 1, 2, or 3 different devices. They have to be coordinated in a way they ensure an optimal operation of the installation.

Aims of coordination

In the case of a fault, coordination serves the following purposes:

- To protect persons and equipment,
- To ensure continuity of service,
- To reduce maintenance costs (manpower and replacement equipment).

Types of coordination as per IEC 60947-4-1

- Type 1 coordination: Basic solution
 - no continuity of service,
 - high maintenance costs in case of a fault (manpower and equipment).
- Type 2 coordination: Solution ensuring continuity of service
 - reduced machine downtime,
 - reduced cost of replacement equipment.
- Total coordination: Withdrawable solutions as per IEC 60947-6-2:
 - no damage nor resetting of devices following a fault,
 - installation immediate return to operation.

Schneider Electric's choice as regards coordination

For applications in Spacial SFM high-availability switchboard, Schneider Electric applies:

- Type 2 coordination because of:
 - Low cost for repairing the equipment,
 - Reduced machine downtime,

and does no longer apply:

- Type 1 coordination and non-coordinated feeders because of:
 - Expensive return to operation,
 - Extended machine shutdowns.



2-component motor starter

Thermomagnetic circuit-breaker + contactor

Advantages

- Very economic solutions.
- Suitable for all types of diagrams.
- Manual reset following a thermal fault.
- Type 2 coordination.

Applications

- Manufacturing and continuous and semi-continuous processes.



3-component motor starter

Advantages

- Wide choice of solutions.
- Suitable for all types of diagrams.
- Manual or automatic reset following a thermal fault.
- 2 starting classes (10 and 20).
- Type 2 coordination.
- Separation of thermal and magnetic faults.

Magnetic circuit-breaker + contactor + thermal protection

- For manufacturing and continuous and semi-continuous processes.

Switch-disconnector fuse + contactor + thermal protection

- For all types of machines.
- For manufacturing and continuous and semi-continuous processes.



Presentation

The Spacial SFM system of enclosures with compartments used for MCC purposes is based on the Spacial SF range.

They offer the same functions:

- Various configuration options, combined side-by-side or back-to-back.
- The built-in partial doors and panels ensure the required degree of protection.

And the same advantages:

- Save time through all assembly phases.
- Enclosure robustness.

Modularity and Versatility

The enclosures feature offer 36 vertical modules, each 50 mm high, of usable space. They are available in 4 sizes and with 2 additional chambers for distribution busbars or cabling management. They can also be coupled with PrismaSet HD for power distribution switchboards.



The functional system

Metal structure

The switchboard is made up of one or more frameworks combined side-by-side or back-to-back, on which a complete selection of cover panels and partial doors can be mounted.

They are used to build IP54 configurations and can be fitted with ClimaSys options for airing.

Electrical continuity is achieved using earthing braids.

Plain partial doors are reversible for quick left or right-hand mounting by a single person, 120° opening.

The robustness of the locking system ensure the accurate alingment of the assembly. A system with 1 to 4 locking points and 5-mm double-bar inserts are standard, other shaped inserts are available as options.

Distribution system

Vertical busbars positioned in a lateral compartment and horizontal busbars are used to distribute electricity inside the switchboard.

Complete functional units

Functional units comprise the following components:

- Motor control and protection devices,
- A dedicated plain mounting plate for device installation,
- Gland boxes for terminal isolation on the back of the switchboard or on the side of the cabling chamber to obtain form 4b,
- Devices for on-site connections.

The functional units are modular and designed for stacked installation. The system includes everything needed for the mounting, supply and onsite connection of the functional unit. The components of the Spacial SFM compartment system and those of the functional units in particular have been designed and tested in accordance with device characteristics. This design approach ensures a high degree of reliability in system operation and optimal safety for personnel. Electrical switchboards built according to Schneider Electric's recommendations fully comply with international standards IEC 61439-2 and IEC 62208.



Resistant to the most demanding environments

- IP54 degree of protection for dusty and/or damp industrial environments.
- Seismic resistance.
- Optional forced-airing for environments with ambient temperatures above 45 °C or for devices with considerable heat loss (see ClimaSys offer options).



Type-tested

Spacial SFM enclosures are fully type-tested in accordance with IEC 61439-2.

- Certified by independent laboratories.
- Permanent quality control through Schneider Electric testing laboratories.

Type-testing includes the following tests:

- Temperature-rise limit,
- Dielectric properties,
- Short-circuit withstand,
- Effectiveness of protective circuit,
- Conformity of the clearance and creepage distances,
- Mechanical operation,
- Degree of protection.

Partitioning

Partitioning is essential to ensure the utmost protection of the installation and the personnel carrying out work in the switchboard.

Used in conjunction with the standard protection (terminal shields, factory-built connections), partitioning prevents any direct contact with live parts.

Form 2b

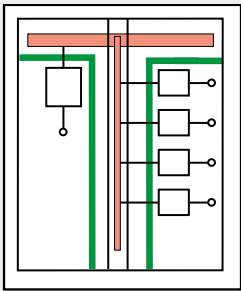

- Terminals for external conductors separated from busbars.
- The functional units and the terminals are separated from the busbars.

Form 3b

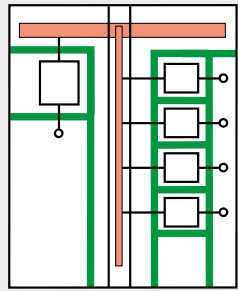

- Separation of busbars from the functional units and separation of all functional units from one another. Separation of the terminals for external conductors from the functional units, but not from each other.
- Protection against contact with live parts.
 - Reduction in the risk of faults between the functional units (propagation of electrical arcs, etc.).

Form 4a

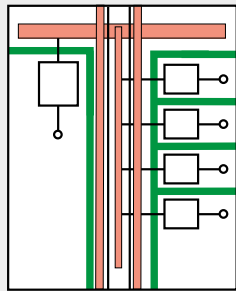

- Terminals for external conductors in the same compartment as the associated functional unit.

Form 4b

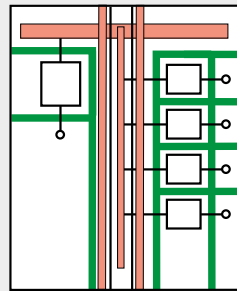

- Terminals for external conductors not in the same compartment as the associated functional unit, but in individual, separate, enclosed protected spaces or compartments.



General data	
Applications	MCC
Standards	IEC 61439-2
Internal	No
Seismic	3G
Installation	Indoor

Mechanical data	
Cable inlet	Top / Bottom
Access	Front / Rear Side
IP	54
IK	10
Form	4b type 7
Withdrability	FFF
Dimensions	H 2000 / W 600 and 800 / D 600 and 800
Color	RAL 7035 grey

Electrical data	
Insulation voltage (Ui)	1000 V
Rated voltage (Ue)	415 V
Coordination	Type 2
Frequency	50/60 Hz
Auxiliary circuit voltage	230 V
Degree of pollution	3
Rated current (IP>31)	2500 A (with Copper and Linergy)
Short circuit (I _{cw} - 1s)	85 kA

Mounting plates for fixed MCC switchboards

Motor control functional units

The plain mounting plates can be used to install all the devices making up an MCC motor starter on a single support.

Easy installation

Motor feeders can be prepared on a bench making the cut-outs needed. The quick-fixing system allows holding the mounting plate during device installation and wiring. The mounting plate can be fixed on the side partitions in adjustable depth with a pitch of 50 mm.

Switchboard upgradeability

- Functional units with partitioning of Form 3b and 4b.
- Access from sides and rear.
- Separation panels with pre-cuts for cable glands ref. **LVS01215**.

Functional unit reliability

- 3 to 24 module (150 to 1200 mm) mounting plates are installed in 600 and 800 mm wide enclosures.
- Capacity of Spacial SFM enclosures: 36 modules (50 mm each).
- Cables are routed in dedicated 300 or 400 mm wide lateral compartments.

Plain mounting plates

Dimension of the compartment				
Number of modules	Height (mm)	Width (mm)	Mounting plate	Fixing kit
3M	150	600	NSYMP3M6	NSYMPFIX
3M	150	800	NSYMP3M8	
4M	200	600	NSYMP4M6	
4M	200	800	NSYMP4M8	
5M	250	600	NSYMP5M6	
5M	250	800	NSYMP5M8	
6M	300	600	NSYMP6M6	
6M	300	800	NSYMP6M8	
8M	400	600	NSYMP8M6	
8M	400	800	NSYMP8M8	
9M	450	600	NSYMP9M6	
9M	450	800	NSYMP9M8	
12M	600	600	NSYMP12M6	
12M	600	800	NSYMP12M8	
16M	800	600	NSYMP16M6	
16M	800	800	NSYMP16M8	
18M	900	600	NSYMP18M6	
18M	900	800	NSYMP18M8	
20M	1000	600	NSYMP20M6	
20M	1000	800	NSYMP20M8	
24M	1200	600	NSYMP24M6	
24M	1200	800	NSYMP24M8	

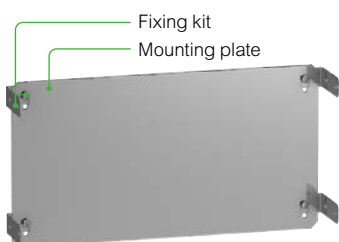

2-component motor starter, direct on line and reversing, GV2, GV3 and GV7

Selection of recommended combinations

GV2							
I _q (kA)		Motor characteristics		Motor starter solution		Number of modules on mounting plate (1M = 50 mm)	
Without limiter	With GV1L3	P _{max} (kW)	I _{max} (A)	Circuit breaker	Contactor ¹	DOL	Reversing
85	-	0.18	0.6	GV2-P04	LC1D09	3M	3M
85	-	0.25	0.9	GV2-P05	LC1D09	3M	3M
85	-	0.37	1.1	GV2-P06	LC1D09	3M	3M
85	-	0.55	1.5	GV2-P06	LC1D09	3M	3M
85	-	0.75	1.8	GV2-P07	LC1D09	3M	3M
85	-	1.1	2.6	GV2-P08	LC1D09	3M	3M
85	-	1.5	3.4	GV2-P08	LC1D09	3M	3M
85	-	2.2	4.8	GV2-P10	LC1D09	3M	3M
85	-	3	6.5	GV2-P14	LC1D09	3M	3M
85	-	4	8.2	GV2-P14	LC1D18	3M	3M
50	85	5.5	11	GV2-P16	LC1D25	3M	3M
50	85	7.5	14	GV2-P20	LC1D25	3M	3M
50	85	10	19	GV2-P21	LC1D32	3M	3M
50	85	11	21	GV2-P22	LC1D32	3M	3M
50	85	15	28	GV2-P32	LC1D32	3M	3M
50	-	18.5	34	GV3-P40	LC1D50A	3M	4M
50	-	22	40	GV3-P50	LC1D50A	3M	4M
50	-	30	55	GV3-P65	LC1D65	3M	4M
70	-	15	28	GV7-RS40	LC1D40	3M	6M
70	-	18.5	34	GV7-RS40	LC1D50	3M	6M
70	-	22	40	GV7-RS50	LC1D80	3M	6M
70	-	30	55	GV7-RS80	LC1D80	3M	6M
70	-	37	66	GV7-RS80	LC1D80	3M	6M
70	-	45	80	GV7-RS100	LC1D115	4M	9M
70	-	55	100	GV7-RS150	LC1D150	6M	9M
70	-	75	135	GV7-RS150	LC1F185	9M	12M
70	-	90	160	GV7-RS220	LC1F225	9M	12M
70	-	110	200	GV7-RS220	LC1F265	9M	12M

¹ 2xLC1-D for reversing

Plain mounting plates

Dimension of compartment			Mounting plate	Fixing kit
Number of modules	Height (mm)	Width (mm)	References	References
3M	150	600	NSYMP3M6	NSYMPFIX
3M	150	800	NSYMP3M8	
4M	200	600	NSYMP4M6	
4M	200	800	NSYMP4M8	
6M	300	600	NSYMP6M6	
6M	300	800	NSYMP6M8	
9M	450	600	NSYMP9M6	
9M	450	800	NSYMP9M8	
12M	600	600	NSYMP12M6	
12M	600	800	NSYMP12M8	

3-Component Motor Starter

Compartmentalised Enclosure
for Motor Control Centers

3-component motor starter Direct on line and reversing GV2 and GV3

U _e	IP	Ambient temperature
415 V	≤ IP54	35 °C

Selection of recommended combinations

I _q (kA)		Motor characteristics		Motor starter solution			Number of modules on mounting plate (1M = 50 mm)	
Without limiter	With LA9LB920	P _{max} (kW)	I _{max} (A)	Circuit breaker	Contactors ¹	Thermal relay	DOL	Reversing
85	-	0.18	0.6	GV2-L04	LC1D09	LRD04	3M	3M
85	-	0.25	0.9	GV2-L05	LC1D09	LRD05	3M	3M
85	-	0.37	1.1	GV2-L06	LC1D09	LRD06	3M	3M
85	-	0.55	1.5	GV2-L06	LC1D09	LRD06	3M	3M
85	-	0.75	1.8	GV2-L07	LC1D09	LRD07	3M	3M
85	-	1.1	2.6	GV2-L08	LC1D09	LRD08	3M	3M
85	-	1.5	3.4	GV2-L08	LC1D09	LRD08	3M	3M
85	-	2.2	4.8	GV2-L10	LC1D09	LRD10	3M	3M
85	-	3	6.5	GV2-L14	LC1D09	LRD12	3M	3M
85	-	4	8.2	GV2-L14	LC1D18	LRD14	3M	3M
50	85	5.5	11	GV2-L16	LC1D25	LRD16	3M	3M
50	85	7.5	14	GV2-L20	LC1D25	LRD21	3M	3M
50	85	10	19	GV2-L21	LC1D32	LRD22	3M	3M
50	85	11	21	GV2-L22	LC1D32	LRD22	3M	3M
50	85	13	24	GV2-L32	LC1D32	LRD32	3M	3M
50	-	18.5	34	GV3-L40	LC1D50A	LRD340	3M	4M
50	-	22	40	GV3-L50	LC1D50A	LRD350	3M	4M
50	-	26	49	GV3-L65	LC1D65A	LRD365	3M	4M

¹ 2xLC1-D for reversing

Selection of the mounting plate

Dimension of the compartment			Mounting plate	Fixing kit
Number of modules	Height (mm)	Width (mm)	References	References
3M	150	600	NSYMP3M6	NSYMPFIX
3M	150	800	NSYMP3M8	
4M	200	600	NSYMP4M6	
4M	200	800	NSYMP4M8	

3-Component Motor Starter

Compartmentalised Enclosure
for Motor Control Centers

3-component motor starter, direct on line and reversing, NS80H and NSX

U _e	IP	Ambient temperature
415 V	≤ IP54	35 °C

Selection of recommended combinations

I _q (kA)	Motor characteristics		Motor starter solution			Number of modules on mounting plate (1M = 50 mm)	
	P _{max} (kW)	I _{max} (A)	Circuit breaker	Contactors ¹	Thermal relay	DOL	Reversing
70	18.5	34	NS80H-MA	LC1D50	LRD3355	3M	6M
70	22	40	NS80H-MA	LC1D50	LRD3357	3M	6M
70	30	55	NS80H-MA	LC1D65	LRD3359	3M	6M
70	37	66	NS80H-MA	LC1D80	LRD3363	3M	6M
NSX...F = 36 kA	18.5	34	NSX100 MA	LC1D80	LRD3355	3M	6M
NSX...N = 50 kA	22	40	NSX100 MA	LC1D80	LRD3357	3M	6M
NSX...H = 70 kA	30	55	NSX100 MA	LC1D80	LRD3359	3M	6M
NSX...S = 85 kA	37	64	NSX100 MA	LC1D80	LRD3363	3M	6M
NSX400L = 150 kA	45	80	NSX100 MA	LC1D115	LR9D5367	6M	9M
NSX630L = 150 kA	55	100	NSX160 MA	LC1D150	LR9D5369	6M	9M
	75	135	NSX160 MA	LC1F185	LR9F5369	9M	12M
	90	160	NSX250 MA	LC1F225	LR9F5371	9M	12M
	100	187	NSX250 MA	LC1F265	LR9F5371	9M	12M
	132	230	NSX400 1.3-M	LC1F330	LR9F7375	12M	16M
	160	270	NSX400 1.3-M	LC1F330	LR9F7375	12M	16M
	200	361	NSX630 1.3-M	LC1F500	LR9F7379	16M	16M
	220	380	NSX630 1.3-M	LC1F500	LR9F7379	16M	16M
	250	430	NSX630 1.3-M	LC1F500	LR9F7379	16M	16M

¹ 2xLC1-D for reversing

Selection of the mounting plate

Dimension of the compartment			Mounting plate	Fixing kit
Number of modules	Height (mm)	Width (mm)	References	References
3M	150	600	NSYMP3M6	NSYMPFIX
3M	150	800	NSYMP3M8	
6M	300	600	NSYMP6M6	
6M	300	800	NSYMP6M8	
9M	450	600	NSYMP9M6	
9M	450	800	NSYMP9M8	
12M	600	600	NSYMP12M6	
12M	600	800	NSYMP12M8	
16M	800	600	NSYMP16M6	
16M	800	800	NSYMP16M8	

3-Component Motor Starter

Compartmentalised Enclosure
for Motor Control Centers

2-component motor starter, Star-delta, GV2, GV3 and GV7

U _e	IP	Ambient temperature
415 V	≤ IP54	35 °C

Selection of recommended combinations

I _q (kA)		Motor characteristics		Motor starter solution		Number of modules on mounting plate (1M = 50 mm)
Without limiter	With GV1L3	P _{max} (kW)	I _{max} (A)	Circuit breaker	Contactors	Star-delta
85	-	0,37	1,1	GV2-P06	3xLC1D09	4M
85	-	0,55	1,5	GV2-P06	3xLC1D09	4M
85	-	0,75	1,8	GV2-P07	3xLC1D09	4M
85	-	1,1	2,6	GV2-P08	3xLC1D09	4M
85	-	1,5	3,4	GV2-P08	3xLC1D09	3M
85	-	2,2	4,8	GV2-P10	3xLC1D18	4M
85	-	3	6,5	GV2-P14	3xLC1D18	3M
85	-	4	8,2	GV2-P14	3xLC1D18	4M
50	85	5,5	11	GV2-P16	3xLC1D25	4M
50	85	7,5	14	GV2-P20	3xLC1D25	4M
50	85	10	19	GV2-P21	3xLC1D32	5M
50	85	11	21	GV2-P22	3xLC1D32	4M
35	85	15	28	GV2-P32	3xLC1D32	4M
50	-	18,5	34	GV3-P40	3xLC1D50A	5M
50	-	22	40	GV3-P50	3xLC1D50A	5M
50	-	30	55	GV3-P65	3xLC1D65A	5M
70	-	15	28	GV7-RS40	3xLC1D80	9M
70	-	18,5	34	GV7-RS40	3xLC1D50	9M
70	-	22	40	GV7-RS50	3xLC1D80	9M
70	-	30	55	GV7-RS80	3xLC1D80	9M
70	-	45	80	GV7-RS100	3xLC1D115	12M
70	-	55	100	GV7-RS150	3xLC1D150	12M
70	-	75	135	GV7-RS150	3xLC1F185	16M
70	-	90	160	GV7-RS220	3xLC1F225	16M
70	-	110	200	GV7-RS220	3xLC1F265	16M

Selection of the mounting plate

Dimension of the compartment			Mounting plate	Fixing kit
Number of modules	Height (mm)	Width (mm)	References	References
3M	150	600	NSYMP3M6	NSYMPFIX
3M	150	800	NSYMP3M8	
4M	200	600	NSYMP4M6	
4M	200	800	NSYMP4M8	
5M	250	600	NSYMP5M6	
5M	250	800	NSYMP5M8	
9M	450	600	NSYMP9M6	
9M	450	800	NSYMP9M8	
12M	600	600	NSYMP12M6	
12M	600	800	NSYMP12M8	
16M	800	600	NSYMP16M6	
16M	800	800	NSYMP16M8	

3-component motor starter, Star-delta, GV2 and GV3

U _e	IP	Ambient temperature
415 V	≤ IP54	35 °C

Selection of recommended combinations

I _q (kA)		Motor characteristics		Motor starter solution			Number of modules on mounting plate (1M = 50 mm)
Without limiter	With LA9LB920	P _{max} (kW)	I _{max} (A)	Circuit breaker	Contactors	Thermal relay	Star-delta
85	-	0,37	1,1	GV2-L06	3xLC1D09	LRD06	4M
85	-	0,55	1,5	GV2-L06	3xLC1D09	LRD06	4M
85	-	0,75	1,8	GV2-L07	3xLC1D09	LRD07	4M
85	-	1,1	2,6	GV2-L08	3xLC1D09	LRD08	4M
85	-	1,5	3,4	GV2-L08	3xLC1D09	LRD08	4M
85	-	2,2	4,8	GV2-L10	3xLC1D18	LRD10	4M
85	-	3	6,5	GV2-L14	3xLC1D18	LRD12	4M
85	-	4	8,2	GV2-L14	3xLC1D18	LRD14	4M
50	85	5,5	11	GV2-L16	3xLC1D25	LRD16	4M
50	85	7,5	14	GV2-L20	3xLC1D25	LRD21	4M
50	85	10	19	GV2-L21	3xLC1D32	LRD22	4M
50	85	11	21	GV2-L22	3xLC1D32	LRD22	4M
35	85	15	24	GV2-L32	3xLC1D32	LRD32	4M
50	-	18,5	34	GV3-L40	3xLC1D50A	LRD340	5M
50	-	22	40	GV3-L50	3xLC1D50A	LRD350	5M
50	-	30	49	GV3-L65	3xLC1D65A	LRD365	5M

Selection of the mounting plate

Dimension of the compartment			Mounting plate	Fixing kit
Number of modules	Height (mm)	Width (mm)	References	References
4M	200	600	NSYMP4M6	NSYMPFIX
4M	200	800	NSYMP4M8	
5M	250	600	NSYMP5M6	
5M	250	800	NSYMP5M8	

3-component motor starter, Star-delta, NS80H and NSX

U _e	IP	Ambient temperature
415 V	≤ IP54	35 °C

Selection of recommended combinations

I _q (kA)	Motor characteristics		Motor starter solution			Number of modules on mounting plate (1M = 50 mm)
	P _{max} (kW)	I _{max} (A)	Circuit breaker	Contactors	Thermal relay	Star-delta
70	18.5	34	NS80H-MA	3xLC1D50	LRD3355	9M
70	22	40	NS80H-MA	3xLC1D50	LRD3357	9M
70	30	55	NS80H-MA	3xLC1D65	LRD3359	9M
70	37	66	NS80H-MA	3xLC1D80	LRD3363	9M
NSX...F = 36 kA	18.5	34	NSX100 MA	3xLC1D80	LRD3355	9M
NSX...N = 50 kA	22	40	NSX100 MA	3xLC1D80	LRD3357	9M
NSX...H = 70 kA	30	55	NSX100 MA	3xLC1D80	LRD3359	9M
NSX...S = 85 kA	37	64	NSX100 MA	3xLC1D80	LRD3363	9M
NSX400L = 150 kA	45	80	NSX100 MA	3xLC1D115	LR9D5367	12M
NSX630L = 150 kA	55	100	NSX160 MA	3xLC1D150	LR9D5369	12M
	75	135	NSX160 MA	3xLC1F185	LR9F5369	16M
	90	160	NSX250 MA	3xLC1F225	LR9F5371	16M
	110	187	NSX250 MA	3xLC1F265	LR9F5371	16M
	132	230	NSX400 1.3-M	3xLC1F330	LR9F7375	20M
	160	270	NSX400 1.3-M	3xLC1F330	LR9F7375	20M
	200	361	NSX630 1.3-M	3xLC1F500	LR9F7379	24M
	220	380	NSX630 1.3-M	3xLC1F500	LR9F7379	24M
	250	430	NSX630 1.3-M	3xLC1F500	LR9F7379	24M

Selection of the mounting plate

Dimension of the compartment			Mounting plate	Fixing kit
Number of modules	Height (mm)	Width (mm)	References	References
9M	450	600	NSYMP9M6	NSYMPFIX
9M	450	800	NSYMP9M8	
12M	600	600	NSYMP12M6	
12M	600	800	NSYMP12M8	
16M	800	600	NSYMP16M6	
16M	800	800	NSYMP16M8	
20M	1000	600	NSYMP20M6	
20M	1000	800	NSYMP20M8	
24M	1200	600	NSYMP24M6	
24M	1200	800	NSYMP24M8	

Linergy LGYE-LGY a breakthrough in busbar systems

Safe, reliable,
flexible and with
the highest level
of performance

The Linergy LGYE-LGY busbar system now includes horizontal busbars for greater performance, reliability and costeffectiveness of the switchboard enclosure.

Manufactured using a revolutionary process, patented Linergy busbars are unique on the market, taking your electrical switchboard installations a giant leap into the future.



Discover how
Linergy LGYE-LGY
can place the next
generation of low-voltage
switchboards in your hands.



Linergy Distribution Systems

Innovative technology from an energy expert you can trust

Patented Linergy LGYE-LGY is backed by Schneider Electric's decades of expertise in electrical distribution systems and is certified IEC 61439-2 compliant by ASEFA.

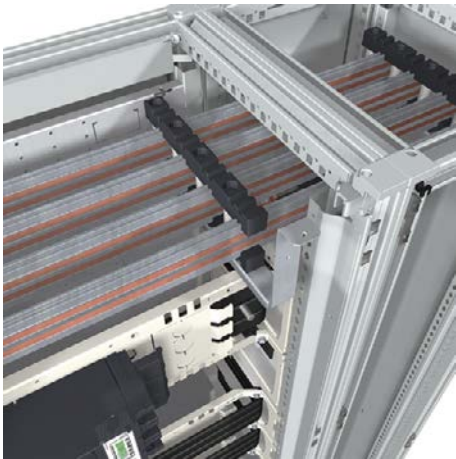

Linergy unique profile

was designed with the ratings you need, a commitment to performance backed by regular testing up to 4000 A.

Heat is dissipated by conduction

and radiation for performance only a market leader can provide.

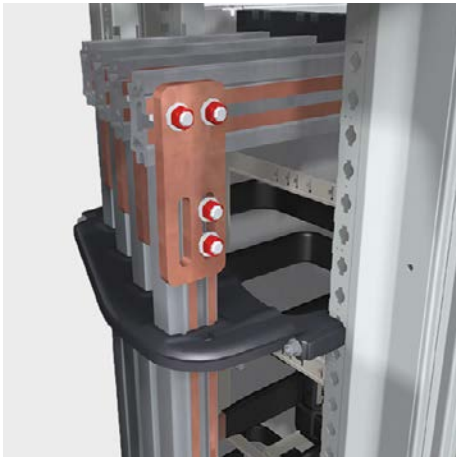

Linergy LGYE-LGY busbars

performances are identical or better than traditional Linergy BS busbars.

Unlike tin-plated aluminum busbars, rugged Linergy LGYE-LGY

busbars are resistant to scratching during assembly to ensure optimal connection quality and reliability.



High-Velocity Oxy-Fuel, unique on the busbar market

Patented Linergy LGYE-LGY uses a supersonic high-temperature painting process for a robust copper contact surface.

A revolutionary design for greater efficiency

The Lineryg line now includes horizontal busbars, helping you achieve better electrical switchboard performance while optimizing busbar layout and facilitating assembly.

Schneider Electric™ has drawn upon 30 years of expertise in electrical distribution systems and a decade of hands-on experience with the proven and reliable Lineryg line of products. It brings you a revolutionary design featuring a high-quality copper contact surface that delivers even better results than traditional Lineryg BS-to-Lineryg BS connections. Lineryg LGYE-LGY busbars offer a number of benefits to help you enhance performance and boost your competitiveness.

Lightweight

Lineryg is half the weight of equivalently rated Lineryg BS bars for more fuel-efficient transport, easier handling, and smoother installation.

Higher capacity

A single Lineryg LGYE bar can withstand ratings up to 2500 A. It would take two or three Lineryg BS bars per pole to achieve similar ratings.

Robust and flexible

Lineryg LGYE bars are extruded for a unique profile that includes both closed and ribbed sections, improving rigidity, thermal dissipation, and resistance to short circuits, with a shortcircuit withstand capacity (I_{cw}) of 85 kA/1s for SFM and 100 kA/1s for PrismaSeT HD.

Attractive

The revolutionary copper contact strips, anodized aluminum surface, and unique shapes give a modern appearance and a soft touch.

IEC standards-compliant

The latest standards were factored in from the early design stages to ensure that temperatures are kept below the values specified in standard IEC61439-2 for optimal performance regardless of the switchboard configuration.

Environmentally-friendly

Instead of increasingly-scarce copper, Lineryg LGYE is made from 70% recycled raw materials offering the same performance as primary raw materials.

Cost-effective

Lineryg LGYE-LGY helps you achieve cost savings now and provides protection against fluctuating copper prices in the future, plus all the advantages of a raw material that is easy to purchase and store.



Lineryg LGYE
is 50% lighter than
Lineryg BS

Reduce costs and
assembly times over
Lineryg BS busbars

Linery accessories are evolving as well!

Linery LGYE is a full-featured busbar system that includes all the connections, screws, isolating supports, and other accessories you need for drill-free assembly.

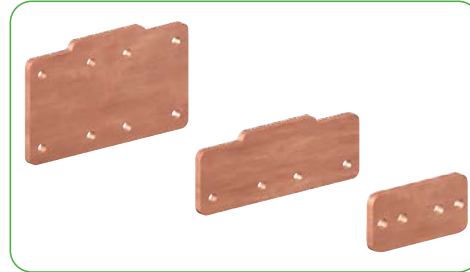
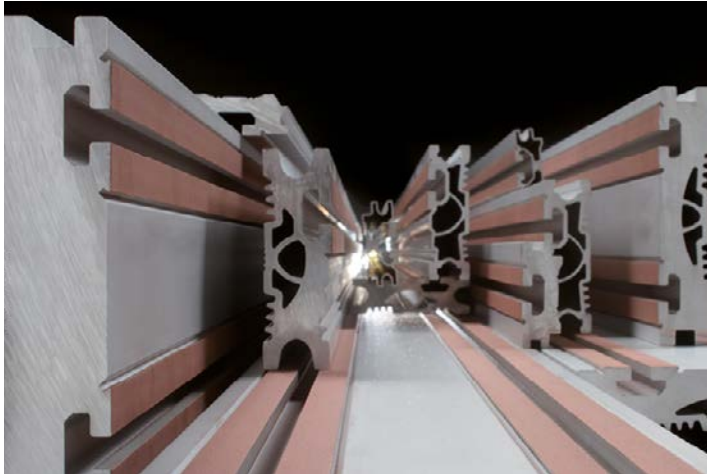

Panel builders, we've thought of everything to make your life easier!



- Linery LGYE-LGY busbars are lightweight, making them easy to transport and handle in the workshop.
- With Linery LGYE-LGY, you can continue to use the familiar PrismaSet HD busbar supports you already know from Linery BS bars. There's no new system to learn.
- Linery LGYE-LGY offers single bars for each rating, making handling during installation faster and more convenient.
- Linery LGYE-LGY bars are fast and easy to position without drilling, thanks to a sliding screw and track system.
- Linery screws let you add extra outgoing connections without drilling new holes or dismantling previous connections or busbar supports, saving you time and giving you greater flexibility in the event of last-minute changes.
- Linery LGYE-LGY busbars offer a unique shape with no sharp edges for safer, smoother handling and installation the bars simply slide right in to the busbar supports.
- Existing Linery LGY vertical busbars are easy to connect to Linery LGYE with ready-to-install accessories like vertical connectors.
- Linery materials are easy to recycle via well-established aluminum recycling services already in use for materials like aluminum cans, coffee capsules, door and window frames, and engine blocks.

Linery also offers the most advanced busbar solutions while remaining simple.

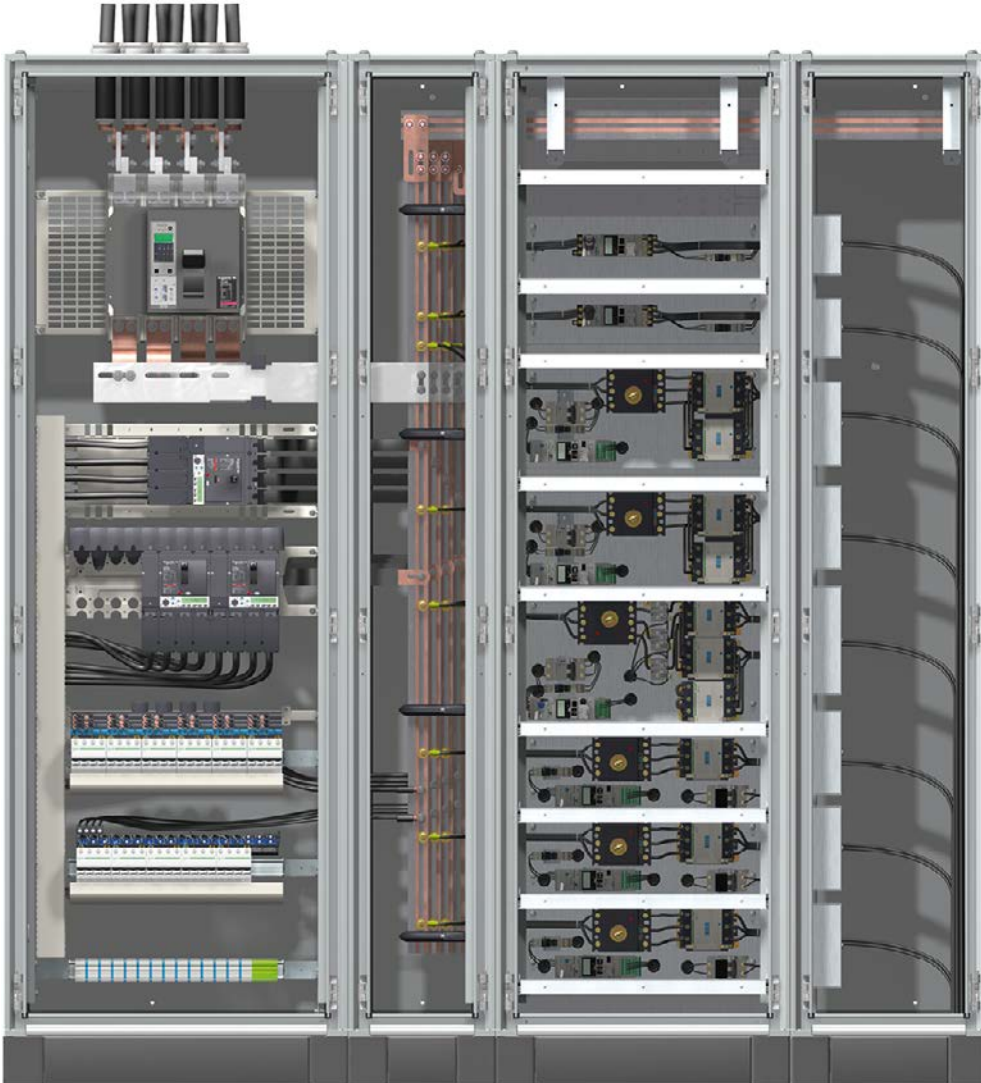

Linery LGYE / LGY /BS

Power busbars

- > Solutions available up to 2500 A for Spacial SFM up to 4 000 A for PrismaSeT HD.
- > Connection everywhere without drilling (with LGY and LGYE profile).

Lateral Linery busbars up to 1600 A

Busbar calculation

The following table indicates:

- The catalog numbers of the bars to be used, depending on the permissible current level in the busbars,
- The number of supports required, depending on the rated short-time withstand current (I_{cw} in kA rms / 1 second).

Linery busbars	Permissible current at 35 °C for switchboard		No. of supports I_{cw} (kA effrms / 1 s)								References
	IP ≤ 31	IP > 31	≤ 25	≤ 30	≤ 40	≤ 50	≤ 60	≤ 65	≤ 75	≤ 85	
Linery 630	680	590	3								LVS04502
Linery 800	840	760	3	3							LVS04503
Linery 1000	1040	950	3	3	3						LVS04504
Linery 1250	1290	1170	3	3	3	4	5				LVS04505
Linery 1600	1650	1480	3	3	3	4	5	5	7	8	LVS04506

Note: The permissible current values for the busbars are given for an ambient temperature of 35 °C around the switchboard. The bottom support also maintains the bars in position. Each catalog number represents one bar.

Busbar selection

Linery busbars, L = 1670 mm

Cat. no. selection: See the table below.

Each bar is supplied with a stop for the bottom support.

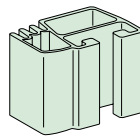
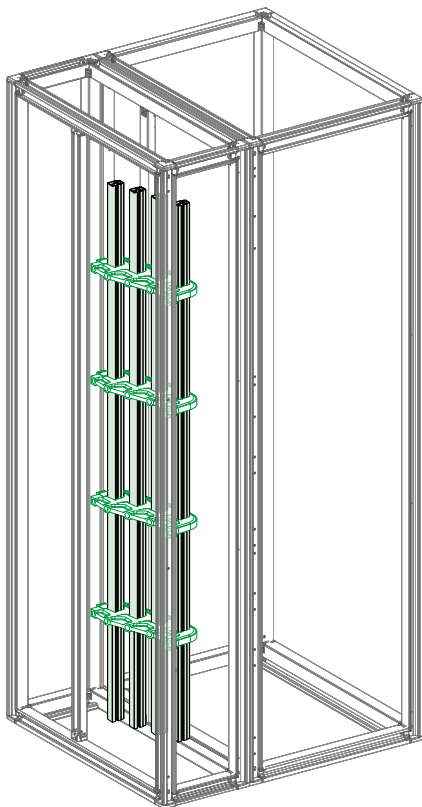

Bar 630 A.
LVS04502

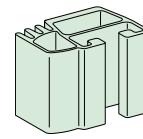

Bar 800 A.
LVS04503

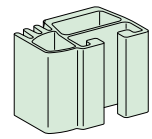

Bar 1000 A.
LVS04504

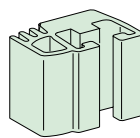

Bar 1250 A.
LVS04505

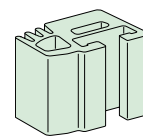







Bar 1600 A.
LVS04506

Busbars up to 1600 A.



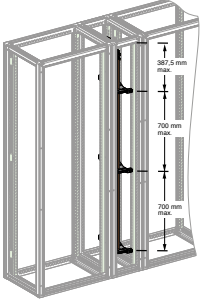

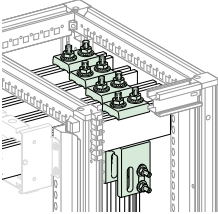
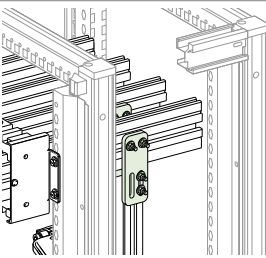
The bottom support is used for wedging busbars in position.

Linergy LGY - lateral profiles up to 1600 A

In Spacial SF duct		W300				
Linergy profile, 1670 mm length		 630 A	 800 A	 1000 A	 1250 A	 1600 A
Permissible current for an ambient temp. of 35 °C around the switchboard	IP ≤ 31	680 A	840 A	1040 A	1290 A	1650 A
	IP > 31	590 A	760 A	950 A	1170 A	1480 A
Number of profiles per phase		1				
References		LVS04502	LVS04503	LVS04504	LVS04505	LVS04506
		The bottom wedge support is used to place the busbar and ensure it is in the correct position. It is count as a busbar support (included in the number of supports).				
				Note: An end stop must be fitted on the bottom support: LVS01109 (sold in lots of 12)		
Number depending on I_{cw} (kA rms/1 s)	≤ 25	3				
	≤ 30	-	3			
	≤ 40	-	3			4
	≤ 50	-	5			
	≤ 60	-	5			
	≤ 65	-	5			
	≤ 75	-	7			
	≤ 85	-	8			
Only for enclosures with a depth ≥ 500 mm						
References		LVS04651 (set of 2 upright adapters NSYSFPA and set of 2 40 mm universal cross-rail NSYSUCR40200 for installation in Spacial SF busbar chamber)				
Connections to the Linergy BS horizontal busbar					Note: Supplied with mounting hardware. Reference includes 1 connection only. Order 1 connection per phase.	
References according to horizontal busbar size	5 mm thick	LVS04634			LVS04635	
	10 mm thick, width ≤ 80 mm	LVS04636				
Connections to the Linergy LGYE horizontal busbar					Note: Supplied with mounting hardware. Reference includes 1 connection only. Order 1 connection per phase.	
References (vertical connection)		LVS04602				
References (vertical shifted connection)		LVS04603				

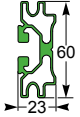
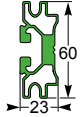
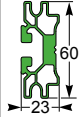
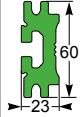
Linery LGYE - horizontal profiles up to 2500 A

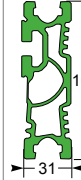
Note:
For accessories, see page 427.

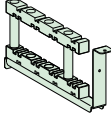
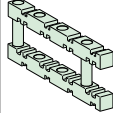
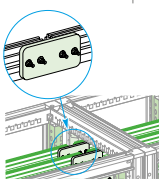
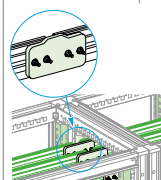
Installation in Spacial SFM compartmentalised		Up to 1600 A					Up to 2500 A		
Linery profile, 2000 mm length									
		630 A	800 A	1000 A	1250 A	1600 A	2000 A	2500 A	
Permissible current for an ambient temp. of 35 °C around the switchboard		530 A	680 A	850 A	1050 A	1480 A	1650 A	2100 A	
Number of profiles per phase		1							
Total number of vertical modules (50 mm)		3					3		
References		LVS04560	LVS04561	LVS04562	LVS04563	LVS04564	LVS04565	LVS04566	
Busbar supports									
		Fixed support		Free support					
		2 fixed supports for Spacial SF wide enclosure are compulsory according compartment depth (400 or 500 mm). 1 fixed support for Spacial SF 300/400 wide chamber are compulsory. Fixed directly on framework. If more supports are needed, add free supports.							
In enclosure SFM: W600/800 Busbar supports 75 mm distance between bars	Number of supports depending on I _{ew} (kA rms/1 s)	≤ 15	2						
		≤ 25	2						
		≤ 30	2						
		≤ 40		2					
		≤ 50			2				
		≤ 60			2+1			2	
		≤ 65					2+1		
		≤ 75					2+1		
≤ 85					2+1				
References Fixed support		D400	NSYMBHS4						
References Fixed support		D500	NSYMBHS5						
References Free support		NSYBSA							
In busbar chamber SF: W300/400 Busbar supports 75 mm distance between bars	Number of supports depending on I _{ew} (kA rms/1 s)	≤ 15	1						
		≤ 25	1						
		≤ 30	1						
		≤ 40		1					
		≤ 50			1				
		≤ 60			1				
		≤ 65					1 + 1		
		≤ 75					1 + 1		
≤ 85					1 + 1				
References Fixed support		D600	NSYBHS600						NSYBHS600
References Fixed support		D800	NSYBHS800						NSYBHS800
References Free support		NSYBSA							
Joints		Up to 1600 A					Up to 2500 A		
		630 A	800 A	1000 A	1250 A	1600 A	2000 A	2500 A	
									
		LVS04620					LVS04621		
References 3P		3x LVS04620					3x LVS04621		
References 4P		4x LVS04620					4x LVS04621		

Linery BS - lateral flat busbars up to 2500 A

In Spacial SF busbar chamber		W300 D500/600/800, up to 1600 A				W300 D500/600/800, up to 2500 A								
Pre-slotted copper, 1675 mm length														
Permissible current for an ambient temp. of 35 °C around the switchboard		IP > 31	750 A	900 A	1250 A	1600 A	1080 A	1250 A	1600 A	1850 A	2000 A	2500 A		
Busbar cross-section (mm)			60 x 5	80 x 5	60 x 5	80 x 5	50 x 10	60 x 10	80 x 10	50 x 10	60 x 10	80 x 10		
Number of busbars per phase			1		2		1			2				
References			LVS04516	LVS04518	LVS04516	LVS04518	LVS04525	LVS04526	LVS04528	LVS04525	LVS04526	LVS04528		
Busbar supports		<p>3 fixed supports are compulsory to hold the busbar in position. If more than 3 supports are needed, use free supports (in addition). The bottom wedge support is used to place the busbar and ensure it is in the correct position. It does not count as a busbar support.</p>												
		Number of supports depending on I_{low} (kA rms/1 s)	≤ 15	3				3						
			≤ 25	3+2		3		3						
			≤ 30	3+2							3			
			≤ 40	3+4			3+2		3+2					
			≤ 50	3+4					3+2					
			≤ 60						3+4					3+2
			≤ 65						3+4					3+2
			≤ 85						3+6		3+4			
References* Spacial SF busbar chamber		W300, D600	NSYBVS600 (fixed) + NSYBSA (free) + NSYAS600 (end stop support)											
75 mm distance between bars		W300, D800	NSYBVS800 (fixed) + NSYBSA (free) + NSYAS800 (end stop support)											
* References of supports depending on distance between bars and busbar chamber depth														
Connections to the Linery BS horizontal busbar														
		<p>For a busbar with 75 mm distance between bars, the bars must be completely covered. Staggered assembly points between one bar and the next, to maintain the necessary clearance distances.⁽¹⁾</p>					<p>References LVS04636, LVS04637 are supplied individually: 1 connection per phase. Reference LVS04642 consists of 2 M8 x 140 screws which can replace the original M8 x 120 screws.</p>							
		1 vertical bar per phase		2 vertical bars per phase		1 vertical bar per phase		2 vertical bars per phase						
		60 x 5	80 x 5	60 x 5	80 x 5	50 x 10	60 x 10	80 x 10	50 x 10	60 x 10	60 x 10	80 x 10		
References*		≤ 80 mm		LVS04645		LVS04636		LVS04637		LVS04637				
* References of the connection piece depending on horizontal busbar size														

⁽¹⁾ Drill hole dimensions for 5 mm thick horizontal busbars.

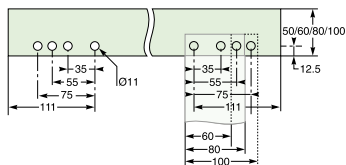



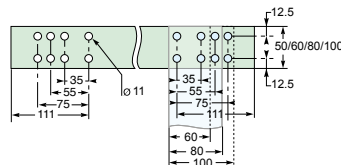





Drill hole dimensions for 10 mm thick horizontal busbars.



Linery BS - horizontal flat busbars up to 2500 A

Note:
When installed at the bottom of an enclosure, the busbar must be partitioned.

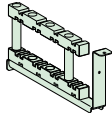
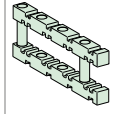
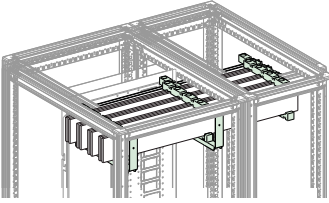
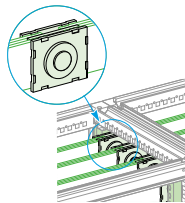
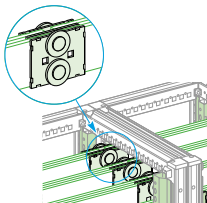
Installation in Spacial SFM compartmentalised		Up to 1600 A				Up to 2500 A			
Copper bar, 2000 mm length									
Permissible current for an ambient temp. of 35 °C around the switchboard		750 A	900 A	1250 A	1600 A	1600 A	1850 A	2000 A	2500 A
Busbar cross-section (mm)		60 x 5	80 x 5	60 x 5	80 x 5	80 x 10	50 x 10	60 x 10	80 x 10
Number of busbars per phase		1	1	2	2	1	2	2	2
Total number of vertical modules (50 mm)		3							
References		LVS04536	LVS04538	LVS04536	LVS04538	LVS04548	LVS04545	LVS04546	LVS04548
Busbar supports		 Fixed support		 Free support					
		2 fixed supports for Spacial SF wide enclosure are compulsory according compartment depth (400 or 500 mm). 1 fixed support for Spacial SF 300/400 wide chamber are compulsory. Fixed directly on framework. If more supports are needed, add free supports.							
In enclosure SFM: W600/800 with 75 mm distance between bars	Number of supports depending on I_{cw} (kA rms/1 s)	≤ 15	2						
		≤ 25	2+1	2					
		≤ 30	2+1	2					
		≤ 40	2+1			2			
		≤ 50	-	2+1				2	
		≤ 60	-			2+1			
		≤ 65	-			2+1			
		≤ 75	-			2+2	2+1		
≤ 85	-			-			2+1		
References Fixed support		NSYMBHS4 (D400) or NSYMBHS5 (D500)							
References Free support		NSYBSA							
In busbar chamber SF: W300/400 with 75 mm distance between bars	Number depending on I_{cw} (kA rms/1 s)	≤ 30	1						
		≤ 50	1+1				1		
		≤ 85	-				2		
References* Fixed support		NSYBHS600 (D600) or NSYBHS800 (D800)				NSYBHS600 (D600) or NSYBHS800 (D800)			
References* Free support		NSYBSA				NSYBSA			
* References depending on depth									
Joints, Installation in Spacial SF		Up to 1600 A				Up to 2500 A			
		1 vertical bar per phase		2 vertical bars per phase		1 vert. bar per phase		2 vertical bars per phase	
Busbar cross-section (mm)		60 x 5	80 x 5	60 x 5	80 x 5	80 x 10	50 x 10	60 x 10	80 x 10
Sliding joints with self-breaking lock nut									
		LVS04640				LVS04641			
References		LVS04640	LVS04641	LVS04640	LVS04641	LVS04641	LVS04640	LVS04640	LVS04641

Linergy LGYE - accessories

Linergy screw

- Sold in lots of 20: 20 screws + 20 nuts + 20 contact washers, grade 8.8. The screws slide into the profile and are then locked in the desired position.

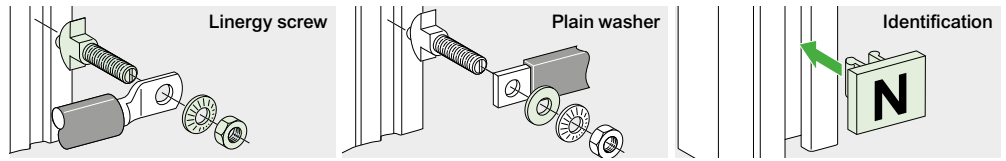

Characteristics	AD	References
Steel plain washers	M8 sold in lots of 20 20 mm	LVS04772
	M8 sold in lots of 20 24 mm	LVS04773
	M8 sold in lots of 20 28 mm	LVS04774
Brass plain washers	M8 sold in lots of 20 for connection of $\leq 25 \text{ mm}^2$ lugs to Linergy 20 mm	LVS04775
Identification	12 clip-on supports + N, L1, L2, L3, PE, PEN labels Linergy LGYE busbar screw plate kit after sales service	LVS04794 LVS01130

M8 screws

- Set of 20 screws + 20 nuts + 40 contact washers.

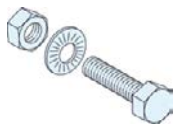

LVS04782

Characteristics	References
Linergy BS, 20 screws grade 8.8, M8 x 20	LVS04782
Linergy BS, 20 screws grade 8.8, M8 x 25	LVS04783
Linergy BS, 20 screws grade 8.8, M8 x 30	LVS04784
Linergy BS, 20 screws grade 8.8, M8 x 35	LVS04785
Linergy BS, 20 screws grade 8.8, M8 x 40	LVS04786
Linergy BS, 20 screws grade 8.8, M8 x 45	LVS04787
Linergy BS, 20 screws grade 8.8, M8 x 50	LVS04788

Torque nuts

- Can be used to obtain the correct tightening torque (28 Nm) recommended by the manufacturer without using a torque wrench. Torque nuts may be used for all electrical connections.



LVS04759

Characteristics	References
20 M8 torque nuts	LVS04759

Voltage tap-offs

- For small lugs (on low-current cables or measurement tap-offs), insert a conducting washer (ref. LVS04775) between the busbar and the lug.

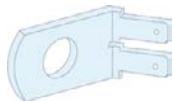

LVS04229

Characteristics	References
20 M10 voltage tap-offs for two 6.35 mm tab connectors	LVS04229

Connections on Linergy LGYE and LGY

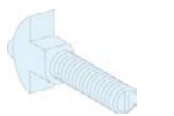

LVS04766



LVS04768



LVS04769

Characteristics	InA	bar	Use	References
Use the 25 mm Linergy screw	0 A to 630 A	Cable Insulated flexible bar	Recommended	LVS04766
Use the 39 mm Linergy screw is only compatible with Linergy LGY.	0 A to 630 A	Cable Insulated flexible bar	Possible	LVS04767
Use the 25 mm Linergy screw	800 A to 1250 A	5 mm thick bar	Recommended	LVS04766
Use the 39 mm Linergy screw is only compatible with Linergy LGY.	800 A to 1250 A	5 mm thick bar	Possible	LVS04767
Use the flat plate screw with 2 studs	800 A to 1250 A	5 mm thick bar	Possible	LVS04768
Use the flat plate screw with 2 studs	1600 A to 2500 A	5 or 10 mm thick bar	Recommended	LVS04768
Use the 39 mm Linergy screw is only compatible with Linergy LGY.	1600 A to 2500 A	5 or 10 mm thick bar	Possible	LVS04767
Use the flat plate screw with 3 studs	3200 A to 4000 A	10 mm thick bar	Recommended	LVS04769

Partitioning Form 2

Separation of busbars from the functional units:

- Protection against contact with live parts upstream of the outgoing circuits,
- Protection against penetration by foreign solid bodies.

Note:

When the busbars are at the bottom of the enclosure, gland plates are mandatory.

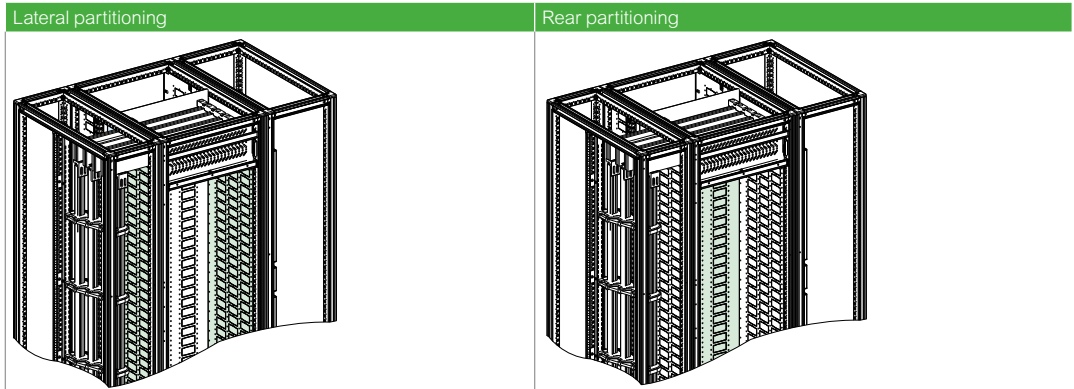

Diagrams	
Characteristics	<ul style="list-style-type: none"> • Set of 2 vertical metal separation which guarantees good insulation of the sides of the compartment (IP2x). • Top and bottom ends have knock-outs for installation of horizontal busbars and pre-cuts of 40 x 70 mm for cable glands using grommets ref. LVS01215 when Form 4b is required. • Partition extension required for D800 mm. • Direct fixing on structure of enclosure.
References	<p>D600: NSYMSC206 D800: NSYMSC206 + NSYMSC202 + NSYSUCR40200</p> <p>W600: NSYMBC206 W800: NSYMBC208</p>

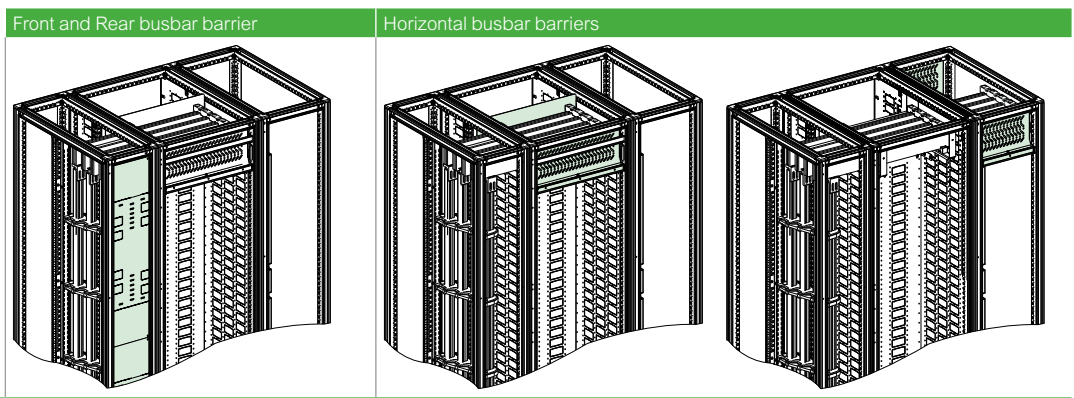

Diagrams									
Characteristics	<table border="1"> <thead> <tr> <th>W600</th> <th>W800</th> <th>W300</th> <th>W400</th> </tr> </thead> <tbody> <tr> <td> <ul style="list-style-type: none"> • Front protection is realized by the combination of the door W300 and this barrier. Metal barrier, composed of 2 parts H850, pre-cut at both ends • Rear protection is realized by the combination of the back panel of the enclosure. </td> <td> <ul style="list-style-type: none"> • Horizontal protection by the combination of slotted front barrier and horizontal partition for efficient natural convection in the switchboard. • The set can be used to partition horizontal busbar at the top or bottom of the enclosure. • The space required for the busbars is not increased. </td> <td> <ul style="list-style-type: none"> • Set of 2 slotted barriers (front and rear), plus horizontal panel to be used when busbars cross the cable chamber. </td> <td></td> </tr> </tbody> </table>	W600	W800	W300	W400	<ul style="list-style-type: none"> • Front protection is realized by the combination of the door W300 and this barrier. Metal barrier, composed of 2 parts H850, pre-cut at both ends • Rear protection is realized by the combination of the back panel of the enclosure. 	<ul style="list-style-type: none"> • Horizontal protection by the combination of slotted front barrier and horizontal partition for efficient natural convection in the switchboard. • The set can be used to partition horizontal busbar at the top or bottom of the enclosure. • The space required for the busbars is not increased. 	<ul style="list-style-type: none"> • Set of 2 slotted barriers (front and rear), plus horizontal panel to be used when busbars cross the cable chamber. 	
W600	W800	W300	W400						
<ul style="list-style-type: none"> • Front protection is realized by the combination of the door W300 and this barrier. Metal barrier, composed of 2 parts H850, pre-cut at both ends • Rear protection is realized by the combination of the back panel of the enclosure. 	<ul style="list-style-type: none"> • Horizontal protection by the combination of slotted front barrier and horizontal partition for efficient natural convection in the switchboard. • The set can be used to partition horizontal busbar at the top or bottom of the enclosure. • The space required for the busbars is not increased. 	<ul style="list-style-type: none"> • Set of 2 slotted barriers (front and rear), plus horizontal panel to be used when busbars cross the cable chamber. 							
References	<table border="1"> <tbody> <tr> <td>W300: LVS06540 W400: NSYVVF2B4</td> <td>D600 ①: NSYHPF2B3M64 D800 ①: NSYHPF2B3M65</td> <td>D600 ①: NSYHPF2B3M84 D800 ①: NSYHPF2B3M85</td> <td>D600: LVS06561 D800: LVS06563</td> <td>D600: NSYHPF2B3M4 D800: NSYHPF2B3M4</td> </tr> </tbody> </table>	W300: LVS06540 W400: NSYVVF2B4	D600 ①: NSYHPF2B3M64 D800 ①: NSYHPF2B3M65	D600 ①: NSYHPF2B3M84 D800 ①: NSYHPF2B3M85	D600: LVS06561 D800: LVS06563	D600: NSYHPF2B3M4 D800: NSYHPF2B3M4			
W300: LVS06540 W400: NSYVVF2B4	D600 ①: NSYHPF2B3M64 D800 ①: NSYHPF2B3M65	D600 ①: NSYHPF2B3M84 D800 ①: NSYHPF2B3M85	D600: LVS06561 D800: LVS06563	D600: NSYHPF2B3M4 D800: NSYHPF2B3M4					

① For an enclosure with a depth of 600 mm the compartment depth is 400 mm. For an enclosure with a depth of 800 mm the compartment depth is 500 mm

Technical changes reserved. Information provided without guarantee. Images are for illustrative purposes only.

Accessories for partitioning Form 2

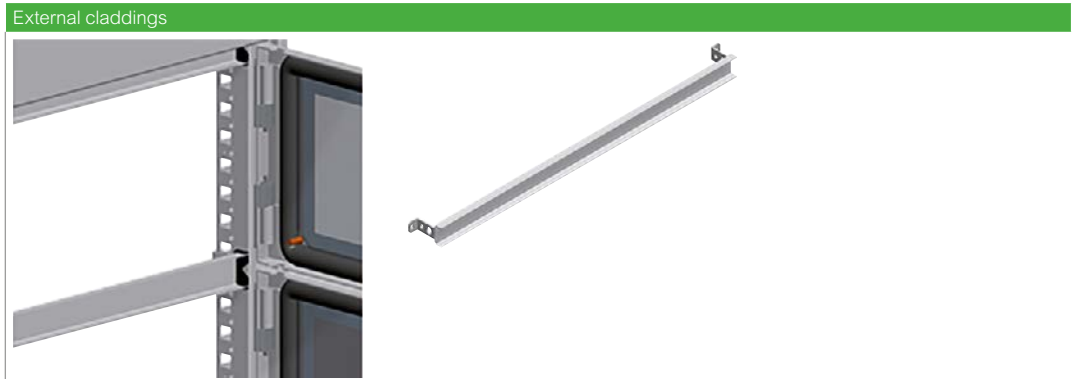

Intermediate Crossbar	
Characteristics	<ul style="list-style-type: none"> • It is mounted between partial doors, guaranteeing good sealing. • To be used in the absence of the partition tray. • Direct fixing to the structure. • Available in 2 widths (mm).
Supply	2 crossbars with fixing elements
References	W600: NSYMIC6 W800: NSYMIC8

Partitioning Form 3

Separation of busbars from the functional units and separation of all functional units from one another.

Separation of the terminals for external conductors from the functional units, but not from each other.

- Protection against contact with live parts
- Reduction in the risk of faults between the functional units (propagation of electrical arcs, etc.).

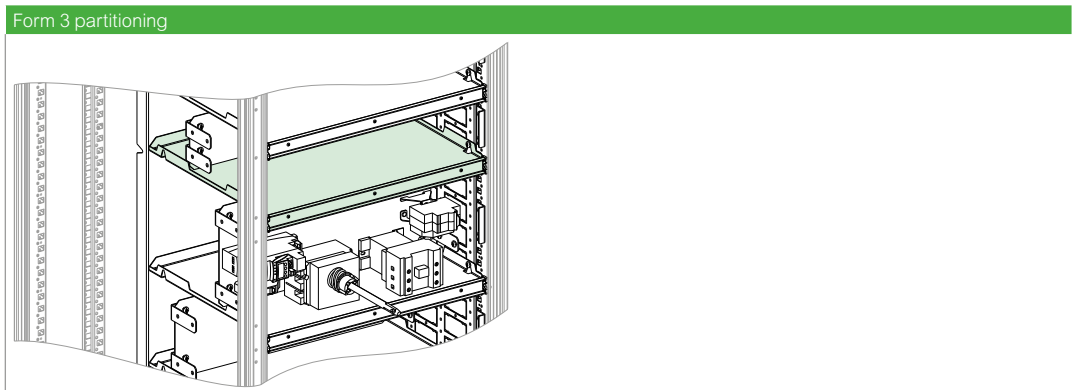

Horizontal partitioning	W600	W800
Characteristics	<ul style="list-style-type: none"> • A horizontal metal partition to separate functional units from one another and guarantees insulation of the compartments (IP2x). • It is fixed to the front uprights of the enclosure and the side partitions. • Quick-fixing system with intermediate crossbar to ensure the degree of protection of the partial doors. • Order by multiples of 2 (2, 4, 6...). 	
References	D600 ①: NSYMTR64 D800 ①: NSYMTR65	D600 ①: NSYMTR84 D800 ①: NSYMTR85

① For an enclosure with a depth of 600 mm the compartment depth is 400 mm. For an enclosure with a depth of 800 mm the compartment depth is 500 mm.

Partitioning Form 4

Separation of busbars from the functional units and separation of all functional units from one another, including the terminals for external conductors which are an integral part of the functional unit:

- Protection against contacts with live parts and reduction in the risk of faults between the functional units (propagation of electrical arcs, etc.).
- Form 4a: Terminal for external conductors in the same compartment as the associated.
- Form 4b: Terminals for external conductors not in the same compartment as the associated functional unit, but in individual, separate, enclosed protected spaces or compartments.

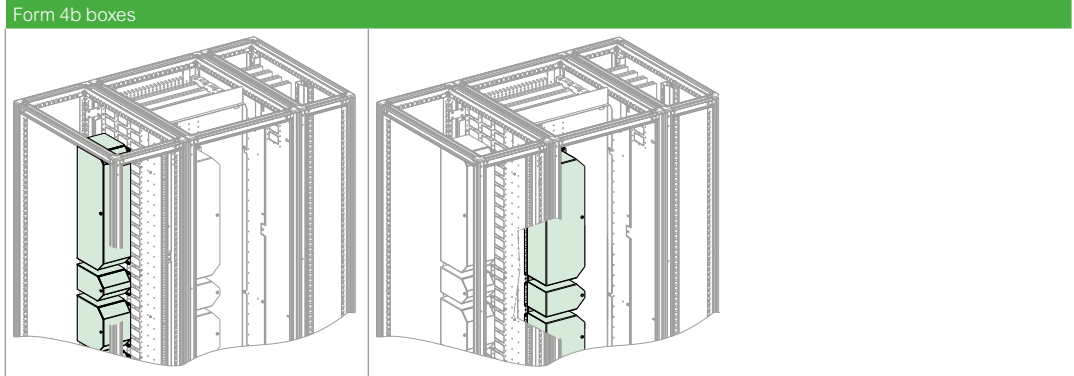

Characteristics	<ul style="list-style-type: none"> • Metal plain box composed by 2 parts that can be easily installed for side or rear connection to separate the terminals for external conductors of the functional unit. • Quick-fixing system on the side or on the back partition. • Available in 6 heights: 					
References	3M: NSYBF4B3M	4M: NSYBF4B4M	5M: NSYBF4B5M	6M: NSYBF4B6M	8M: NSYBF4B8M	9M: NSYBF4B9M

Rail support bracket



- Bracket for fixing rails at an angle of 45°.
- Material: Zinc-coated steel
- Spacial SF: Mounted on the structure and/or mounting plates
- Spacial SM: Mounted on the bottom mounting rail and/or mounting plates



Characteristics	References
Rail support bracket	NSYFB45

Other common accessories







References	See on Universal Enclosure catalog
-------------------	------------------------------------

Selection of Spacial Enclosures

Common characteristics

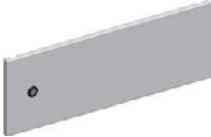

- Spacial SFM framework with compartment system that can be combined side-by-side with busbar and cable chambers.
- Receive the cover panels and partial doors IP54.
- Material: Steel.
- Finish: Painted with epoxy polyester resin.
- Color: RAL 7035 grey.
- Available pre-assembled or as kit.

	Assembled supply		Kit supply	
				
Compartmentalised enclosure	W600	W800	W600	W800
Characteristics	<ul style="list-style-type: none"> • Structure: Top and bottom frame and vertical uprights with a height of 2000 mm. • Useful height for doors with a height of 1800 mm/36M if top and bottom fix panels are installed for modularity (mandatory for installation of partial doors). • Equipped with removable roof, external fixing rear panel and top and bottom fixed panels (H100 mm) to allow modularity of partial doors. • 4 dimensions available. 			
References	D600: NSYSF20660M D800: NSYSF20680M	D600: NSYSF20860M D800: NSYSF20880M	-	-
Vertical uprights, height 2000 mm	-	-	NSYSFV20	NSYSFV20
Top and Bottom frame with roof	-	-	D600: NSYSFC66 D800: NSYSFC68	D600: NSYSFC86 D800: NSYSFC88
Rear panel	-	-	NSYBP206	NSYBP208
Fixed panels for modularity, height 100 mm/2M (intermediate crossbars included)	-	-	See table below	See table below

	Front Fix panel for modularity		Frontal partial doors		Side panels	
						
External claddings	W600	W800	W600	W800	D600	D800
Characteristics	<ul style="list-style-type: none"> • Top and bottom fix panel to obtain modularity required to install partial doors. • If there is no horizontal partitioning on top or bottom, the intermediate cross-bar has to be ordered separately, ref. NSYMIC6 (W600 mm) or NSYMIC8 (W800 mm). • 2M fixed panels are delivered as standard for the enclosure with compartments. Can be ordered separately for Spacial SFM framework in kit supply. • Available in 2 heights(M) Heights according modularity (1M = 50 mm). 		<ul style="list-style-type: none"> • Plain partial door with lock with 5-mm double-bar insert. • They are fixed to the uprights of the framework by means of hinges. • Drilling template for uprights ref. NSYMDT (Only 1 drilling template by order is needed). • Opening to right or left. • 1, 2 or 4 locking points depending on height. • Replaceable locking insert (see page 433). • Available in following heights(M) Heights according modularity (1M = 50 mm). 		<ul style="list-style-type: none"> • Set of 2 side panels fixed to the outside of the enclosure. • Captive screws pre-mounted on • The panels. • Available in 2 depths (mm). 	
References	2M: NSYMF2M6 5M: NSYMF5M6	2M: NSYMF2M8 5M: NSYMF5M8	3M: NSYMPD3M6 4M: NSYMPD4M6 5M: NSYMPD5M6 6M: NSYMPD6M6 8M: NSYMPD8M6 9M: NSYMPD9M6 12M: NSYMPD12M6 16M: NSYMPD16M6 18M: NSYMPD18M6 20M: NSYMPD20M6 24M: NSYMPD24M6	3M: NSYMPD3M8 4M: NSYMPD4M8 5M: NSYMPD5M8 6M: NSYMPD6M8 8M: NSYMPD8M8 9M: NSYMPD9M8 12M: NSYMPD12M8 16M: NSYMPD16M8 18M: NSYMPD18M8 20M: NSYMPD20M8 24M: NSYMPD24M8	NSY2SP206	NSY2SP208

Technical changes reserved. Information provided without guarantee. Images are for illustrative purposes only.

Selection of Spacial enclosures for Motor Control Centers

	Assembled supply		Kit supply	
				
Busbar and cabling chambers	W300	W400	W300	W400
Characteristics	<ul style="list-style-type: none"> • Structure: Top and bottom frame and vertical uprights with a height of 2000 mm. • Equipped with removable roof, external fixing rear panel and front plain door with 4-point locking system with handle and DB 5 mm insert. • 4 dimensions available. 			
References	D600: NSYSF20360 D800: NSYSF20380	D600: NSYSF20460 D800: NSYSF20480	-	-
Vertical uprights, height 2000 mm	-	-	NSYSFV20	NSYSFV20
Top and Bottom frame with roof	-	-	D600: NSYSFC36 D800: NSYSFC38	D600: NSYSFC46 D800: NSYSFC48
Rear panel	-	-	NSYBP203	NSYBP204
Front plain door	-	-	NSYSFD203	NSYSFD204

Other assembly accessories

			Cable gland plates			Plinth (100 mm height)		Plinth (200 mm height)	
H (mm)	W (mm)	D (mm)	Plain	1 entry	2 entries	Front kit	Side kit	Front kit	Side kit
2000	600	600	NSYEC66	NSYEC661	NSYEC662	NSYSPPF6100	NSYSPS6100	NSYSPPF6200	NSYSPS6200
2000	600	800	NSYEC68	NSYEC681	NSYEC682	NSYSPPF6100	NSYSPS8100	NSYSPPF6200	NSYSPS8200
2000	800	600	NSYEC86	NSYEC861	NSYEC862	NSYSPPF8100	NSYSPS6100	NSYSPPF8200	NSYSPS6200
2000	800	800	NSYEC88	NSYEC881	NSYEC882	NSYSPPF8100	NSYSPS8100	NSYSPPF8200	NSYSPS8200
2000	300	600	NSYEC36	NSYEC361	-	NSYSPPF3100	NSYSPS6100	NSYSPPF3200	NSYSPS6200
2000	300	800	-	NSYEC381	-	NSYSPPF3100	NSYSPS8100	NSYSPPF3200	NSYSPS8200
2000	400	600	NSYEC64	NSYEC461	-	NSYSPPF4100	NSYSPS6100	NSYSPPF4200	NSYSPS6200
2000	400	800	NSYEC84	NSYEC481	-	NSYSPPF4100	NSYSPS8100	NSYSPPF4200	NSYSPS8200

	Coupling kit	4 lifting eyebolts	4 lifting brackets	Earth braids	Earthing cables
	NSYSFBK19	NSYSFEB	NSYSFELB	NSYEB1516D8	NSYEL166D8
Characteristics	<ul style="list-style-type: none"> Side-by-side combination. Back-to-back combination (back-to-back combination must be shipped individually and combined during on-site installation). 	<ul style="list-style-type: none"> Use a set of lifting eyebolts rings for each framework ①. 	<ul style="list-style-type: none"> When two enclosures with devices have been combined, use lifting brackets. ② 	<p>NSYEB1516D8:</p> <ul style="list-style-type: none"> Length 155 mm, Section 16 mm², Terminal 8.5 mm. <p>NSYEB2025D8:</p> <ul style="list-style-type: none"> Length 200 mm, Section 25 mm², Terminal 8.5 mm. <p>NSYEB2050D8:</p> <ul style="list-style-type: none"> Length 200 mm, Section 50 mm², Terminal 8.5 mm. 	<p>NSYEL166D8:</p> <ul style="list-style-type: none"> Length 160 mm, Section 6 mm², Terminal 8.3 mm. <p>NSYEL2225D8:</p> <ul style="list-style-type: none"> Length 220 mm, Section 25 mm², Terminal 8.3 mm. <p>NSYEL3525D8:</p> <ul style="list-style-type: none"> Length 350 mm, Section 25 mm², Terminal 8.3 mm.
References	NSYSFBK19	NSYSFEB	NSYSFELB	NSYEB1516D8 NSYEB2025D8 NSYEB2050D8	NSYEL166D8 NSYEL2225D8 NSYEL3525D8

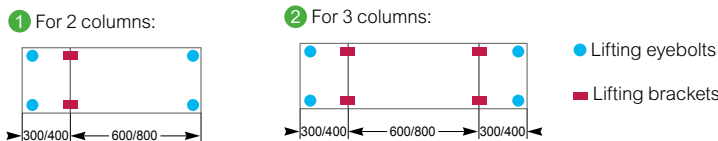

For more than 3 columns, lengths > 1600 mm, see Lifting bars options on Universal Enclosures catalog.

Locks for partial doors

Standard insert can be replaced by a lock from the table below (CRN range), keeping the standard latch.

Type of lock	Insert references	Key references
3-mm double-bar	NSYTDBCRN*	NSYLDB5
6 mm	NSYTC6CRN	NSYLC7
7 mm	NSYTC7CRN	NSYLC7
8 mm	NSYTC8CRN	NSYLC8
6.5 mm	NSYTT6CRN	NSYLT8
7 mm	NSYTT7CRN	NSYLT8
8 mm	NSYTT8CRN	NSYLT8

* Delivered with 1 metal key.

Thalassa PHD enclosures are suitable for outdoor public areas thanks to their multiple features:

- pressure and shock resistant (IEC 61439-5: 2010),
- anti-posting surface thanks to the special ribbed door surface,
- insulated (ready for Class II according to IEC 61439-1: 2011).

This range can be configured according to your needs

4 different services available:



Assemble to order



Mounting of standard accessories



Painting



Machining



Tough

- PHD: Heavy-Duty polyester reinforced with a double layer of fiberglass. Ultra-resistant, vandalism-deterring.



Upper airing module

- The newly engineered roof airing accessory
- Prevents condensation (one of the causes of corrosion).

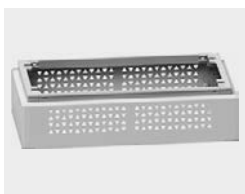

Heavy-Duty accessories

- Dedicated accessories to resist harsh outdoor environments.



Anti-vandalism

- PHD and SFHD: The handle with keylock and additional padlock hole (padlock not included)
- Protects the equipment inside.
- It is standard equipment.



Simplicity

- Installation simplified: Easy lifting even when loaded with up to 1000 kg of equipment. HD lifting accessories also available.



Fully equipped

- Standard, pre-installed equipment includes:
- A curved canopy to avoid water stagnation
 - A door retainer to keep the door open even with strong wind or when a vehicle passes by
 - An aluminum cable gland plate to easily drill holes and avoid corrosion
 - A document pocket to hold your documents in a practical place.

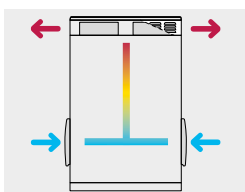

Thermal management solutions

- 3 airing architectures help protecting the equipment installed inside from overheating and humidity.

See page 546 for details or consult our web site www.se.com



Prolonged exposure to UV radiation, wind and rain can cause aesthetics changes in the external surface of the enclosure. Without affecting the technical properties according to IEC 62208. For long exposure applications, it is recommended to use painted enclosures available through the P&S offer.



Polyester outdoor Heavy-Duty enclosures

Steel outdoor Heavy-Duty enclosures

Characteristics	Polyester outdoor Heavy-Duty enclosures		Steel outdoor Heavy-Duty enclosures	
	Wall-mounted enclosure	Floor-standing enclosure	Wall-mounted enclosure	Floor-standing enclosure
	Outdoor Heavy-Duty (HD) enclosures made of polyester insulated material. Suitable to be installed in public areas thanks to its features: <ul style="list-style-type: none"> • Pressure and shock-resistant • Posting-deterrent • Insulated. 		Outdoor Heavy-Duty (HD) enclosures made of coated steel. Suitable to be installed in private areas with harsh environments thanks to its capacity to resist: <ul style="list-style-type: none"> • Corrosion (up to C4H level according ISO 12944:2018) • UV. 	
Material	HD Polyester reinforced with fiberglass to meet standard EN 439-5		HD steel with anti-corrosive painting	
Finish	-		Structured finish, 100% polyester powder	
Color	RAL 7035 grey		RAL 7035 grey	
Conditions of use	Outdoor and/or harsh environments		Outdoor and/or harsh environments	
Temperature range	-40...80 °C		-40...80 °C	
Ingress protection rating	IP65 according to IEC 60529	IP55 according to IEC 60529	IP66 according to IEC 60529	IP55 according to IEC 60529
Mechanical protection rating	IK10 according to IEC 62262		IK10 according to IEC 62262	
Standards	IEC 61439-5: 2010, IEC 62208: 2011, IEC 61439-1: 2011, IEC 61969-3: 2011, IEC 60297-3-100: 2009		IEC 61439-5: 2010, IEC 62208: 2011, IEC 61969-3: 2011, IEC 60297-3-100: 2009, ISO 12.944: 2018 (C4H)	
Certifications	See table page 446		See table page 446	
Fixing	On wall by means of optional wall fixing accessory	2 options for installation on floor: <ul style="list-style-type: none"> • With floor fixing kit NSYMF2PLAZ4 or NSYMF2PLAZ6 for integrated plinth (50 mm) • With additional ZZ plinths • (ventilated or non-ventilated) available as accessory • (200 mm) (see page 437) 	<ul style="list-style-type: none"> • On wall by means of optional stainless-steel wall fixing lugs • On post by means of optional HD post fixing device 	<ul style="list-style-type: none"> • Directly on floor by means of optional plinth (see page 441)
Maximum load according to IEC 62208	500 kg		200 kg	1000 kg
Other characteristics	<ul style="list-style-type: none"> • Fire resistant (EN 1794-2:2011) • Lifting possible from top with eyebolt accessory • New dedicated airing solutions to be integrated in roof, lateral or plinth. 3 airing architectures proposed (see page 444 and 445) 		New dedicated airing solutions to be integrated in roof, side or plinth	
Options	Plain door or ribbed door		-	
Supply	<ul style="list-style-type: none"> • Curved canopy • Handle with keylock (1242E type) and padlock • Door retainer • Plastic document pocket (A4 size) 	<ul style="list-style-type: none"> • Curved canopy • Integrated plinth • Handle with keylock (1242E type) and padlock • Aluminum cable gland plate • Door retainer • Plastic document pocket (A4 size) 	<ul style="list-style-type: none"> • Curved canopy • 3-mm double-bar lock • Plastic document pocket (A4 size) • Door retainer • Aluminum cable gland plate 	<ul style="list-style-type: none"> • Curved canopy • Rear panel • Handle with keylock (1242E type) and padlock • Aluminum cable gland plate • Door retainer • Plastic document pocket (A4 size)

Polyester outdoor Heavy-Duty enclosures

- Outdoor Heavy-Duty (HD) enclosures made of polyester insulated material. Suitable to be installed in public areas thanks to its features: Pressure and shock-resistant, posting-deterrent, insulated.
 - Material: HD Polyester reinforced with fiberglass to meet standard EN 439-5
 - Color: RAL 7035 grey
 - Conditions of use: Outdoor and/or harsh environments
 - Temperature range: -40...80 °C
 - Mechanical protection rating: IK10 according to IEC 62262
 - Standards: IEC 61439-5: 2010, IEC 62208: 2011, IEC 61439-1: 2011, IEC 61969-3: 2011, IEC 60297-3-100: 2009
- Certifications: See table [page 446](#)
- Maximum load according to IEC 62208: 500 kg
 - Other characteristics: Fire resistant (EN 1794-2:2011), Lifting possible from top with eyebolt accessory, new dedicated airing solutions to be integrated in roof, lateral or plinth.
3 airing architectures proposed (see [page 444](#) and [445](#))
 - Options: Plain door or ribbed door

Wall-mounted enclosure



NSYPHDT553

- Ingress protection rating: IP65 according to IEC 60529
- Fixing: On wall by means of optional wall fixing accessory

Characteristics	Door type	No. of doors	Dimensions (H x W x D)	References
Wall-mounted enclosure	Anti-posting	1	538 x 500 x 320	NSYPHDT553
Wall-mounted enclosure	Anti-posting	1	788 x 500 x 320	NSYPHDT753
Wall-mounted enclosure	Plain	1	538 x 500 x 320	NSYPHDT553P
Wall-mounted enclosure	Plain	1	788 x 500 x 320	NSYPHDT753P

Supply:

Curved canopy
Handle with keylock (1242E type) and padlock
Door retainer
Plastic document pocket (A4 size)

Floor-standing enclosure



NSYPHDZT774

- Ingress protection rating: IP55 according to IEC 60529
- Fixing: 2 options for installation on floor:
- With floor fixing kit **NSYMF2PLAZ4** or **NSYMF2PLAZ6** for integrated plinth (50 mm)
- With additional ZZ plinths (ventilated or non-ventilated) available as accessory (200 mm) (see [page 437](#))

Characteristics	Door type	No. of doors	Dimensions (H x W x D)	References
Floor-standing enclosure	Anti-posting	1	843 x 750 x 420	NSYPHDZT774
Floor-standing enclosure	Anti-posting	1	843 x 750 x 620	NSYPHDZT776
Floor-standing enclosure	Anti-posting	1	1093 x 500 x 420	NSYPHDZT1054
Floor-standing enclosure	Anti-posting	1	1093 x 750 x 420	NSYPHDZT1074
Floor-standing enclosure	Anti-posting	1	1343 x 500 x 420	NSYPHDZT1254
Floor-standing enclosure	Anti-posting	1	1343 x 750 x 420	NSYPHDZT1274
Floor-standing enclosure	Anti-posting	1	1343 x 750 x 620	NSYPHDZT1276
Floor-standing enclosure	Anti-posting	2	1343 x 1250 x 420	NSYPHDZT12124
Floor-standing enclosure	Anti-posting	2	1343 x 1250 x 620	NSYPHDZT12126
Floor-standing enclosure	Anti-posting	1	1593 x 750 x 420	NSYPHDZT1574
Floor-standing enclosure	Anti-posting	1	1593 x 750 x 620	NSYPHDZT1576
Floor-standing enclosure	Anti-posting	2	1593 x 1250 x 420	NSYPHDZT15124
Floor-standing enclosure	Anti-posting	2	1593 x 1250 x 620	NSYPHDZT15126
Floor-standing enclosure	Anti-posting	2 Vertical	2093 x 750 x 420	NSYPHDZT2074
Floor-standing enclosure	Plain	1	843 x 750 x 420	NSYPHDZT774P
Floor-standing enclosure	Plain	1	843 x 750 x 620	NSYPHDZT776P
Floor-standing enclosure	Plain	1	1093 x 500 x 420	NSYPHDZT1054P
Floor-standing enclosure	Plain	1	1093 x 750 x 420	NSYPHDZT1074P
Floor-standing enclosure	Plain	1	1343 x 500 x 420	NSYPHDZT1254P
Floor-standing enclosure	Plain	1	1343 x 750 x 420	NSYPHDZT1274P
Floor-standing enclosure	Plain	1	1343 x 750 x 620	NSYPHDZT1276P
Floor-standing enclosure	Plain	2	1343 x 1250 x 420	NSYPHDZT12124P
Floor-standing enclosure	Plain	2	1343 x 1250 x 620	NSYPHDZT12126P
Floor-standing enclosure	Plain	1	1593 x 750 x 420	NSYPHDZT1574P
Floor-standing enclosure	Plain	1	1593 x 750 x 620	NSYPHDZT1576P
Floor-standing enclosure	Plain	2	1593 x 1250 x 420	NSYPHDZT15124P
Floor-standing enclosure	Plain	2	1593 x 1250 x 620	NSYPHDZT15126P
Floor-standing enclosure	Plain	2 Vertical	2093 x 750 x 420	NSYPHDZT2074P

Supply:

Curved canopy
Integrated plinth
Handle with keylock (1242E type) and padlock
Aluminum cable gland plate
Door retainer
Plastic document pocket (A4 size)



NSYPHDZT774P

Eyebolts



NSYPLHD

- Top lifting accessory for polyester outdoor Heavy-Duty enclosure.
- Maximum load per enclosure: 500 kg.
- Material: Galvanized cast steel



Supply:
4

Characteristics	References
Eyebolts	NSYPLHD

Wall fixing accessory



NSYFMPHD

- Wall fixing support for polyester outdoor Heavy-Duty enclosure.
- No change in ingress protection rate.
- Maximum load per enclosure: 180 kg
- Material: Zinc-coated steel
- Finish: Zinc painting



Supply:
6

Characteristics	References
Wall fixing accessory	NSYFMPHD

Floor fixing kit



NSYMF2PLAZ4

- To fix the enclosure on the floor without a plinth.
- Material: Steel
- Finish: Insulated painting
- Installation: On dry concrete



Supply:
1

Characteristics	Depth (mm)	References
Floor fixing kit	420	NSYMF2PLAZ4
Floor fixing kit	620	NSYMF2PLAZ6

Ventilated ZZ plinth 200 mm

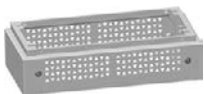

NSYZZ254VHD

- Height: 200 mm.
- The front part can be removed with a 1242 key.
- Includes a polyester anti-insect filter.
- Material: Glass-reinforced polyester
- Color: RAL 7035 grey



Note:

The coupling kit **NSYMUPLA●●●** is not applicable for enclosures using ZZ or ZH type plinths.

Supply:
1

Characteristics	Dimensions (W x D)	References
Ventilated ZZ plinth 200 mm	500 x 420	NSYZZ254VHD
Ventilated ZZ plinth 200 mm	750 x 420	NSYZZ274VHD
Ventilated ZZ plinth 200 mm	750 x 620	NSYZZ276VHD
Ventilated ZZ plinth 200 mm	1250 x 420	NSYZZ2124VHD
Ventilated ZZ plinth 200 mm	1250 x 620	NSYZZ2126VHD

ZZ plinth 200 mm



NSYZZ254G

- Height: 200 mm.
- The front and back plates can only be removed from the inside.
- It is provided with one or two reinforcement cross-rails, adjustable to adapt to the position of the cables.
- Material: Glass-reinforced polyester
- Color: RAL 7035 grey



Note:

The coupling kit **NSYMUPLA●●●** is not applicable for enclosures using ZZ or ZH type plinths.

Supply:
1

Characteristics	Depth (mm)	References
ZZ plinth 200 mm	500 x 420	NSYZZ254G
ZZ plinth 200 mm	750 x 420	NSYZZ274G
ZZ plinth 200 mm	750 x 620	NSYZZ276G
ZZ plinth 200 mm	1250 x 420	NSYZZ2124G
ZZ plinth 200 mm	1250 x 620	NSYZZ2126G

Plain mounting plate

- The enclosures with height of ≥ 1000 mm have intermediate bosses to fix the mounting plate (M8 inserts, ref. **NSYTEX8**, to be ordered separately).
- Material: Galvanized steel
- Installation:**
- Direct installation on M8 inserts at the rear of the enclosure or on step slides for depth adjustment (see [page 250](#))
- In the 2-door enclosures, it is possible to install 1 complete mounting plate or 2 individual mounting plates



NSYPMM55

Supply:
1

Characteristics	Dimensions (H x W)	References
Plain mounting plate	538 x 500	NSYPMM55
Plain mounting plate	788 x 500	NSYPMM75
Plain mounting plate	843 x 750	NSYPMM77
Plain mounting plate	1093 x 500	NSYPMM105
Plain mounting plate	1093 x 750	NSYPMM107
Plain mounting plate	1343 x 500	NSYPMM125
Plain mounting plate	1343 x 750	NSYPMM127
Plain mounting plate	1343 x 1250	NSYPMM1212
Plain mounting plate	1583 x 750	NSYPMM157
Plain mounting plate	1583 x 1250	NSYPMM1512
Plain mounting plate (or 2 x NSYPMM107)	2093 x 750	NSYPMM207

Roof airing module

- Airing module to enable airing from the top of the enclosure (H = 95 mm).
- Material: Steel with anti-corrosive painting (C4H according ISO 12.944: 2018)
- Finish: Structured finish, 100% polyester powder
- Color: RAL 7035 grey



Supply:
1



NSYPCVR54HD

Characteristics	Dimensions (W x D)	References
Roof airing module	500 x 420	NSYPCVR54HD
Roof airing module	750 x 420	NSYPCVR74HD
Roof airing module	750 x 620	NSYPCVR76HD
Roof airing module	1250 x 420	NSYPCVR124HD
Roof airing module	1250 x 620	NSYPCVR126HD

Anti burglary accessory

- Anti burglary accessory for polyester outdoor Heavy-Duty in accordance with ENV 1627-1630:2011 class 2
- It keeps the Insulation Class II
- Material: Steel with anti-corrosive painting (C4H according ISO 12.944: 2018)
- Finish: Structured finish, 100% polyester powder
- Color: RAL 7035 grey
- Installation: Easy installation on the outside of the enclosure



Supply:
1



NSYBGN774HD

Characteristics	Dimensions (H x W x D)	References
Anti burglary accessory	843 x 750 x 420	NSYBGN774HD
Anti burglary accessory	843 x 750 x 620	NSYBGN776HD
Anti burglary accessory	1093 x 500 x 420	NSYBGN1054HD
Anti burglary accessory	1093 x 750 x 420	NSYBGN1074HD
Anti burglary accessory	1343 x 500 x 420	NSYBGN1254HD
Anti burglary accessory	1343 x 750 x 420	NSYBGN1274HD
Anti burglary accessory	1343 x 750 x 620	NSYBGN1276HD
Anti burglary accessory	1343 x 1250 x 420	NSYBGN12124HD
Anti burglary accessory	1343 x 1250 x 620	NSYBGN12126HD
Anti burglary accessory	1593 x 750 x 420	NSYBGN1574HD
Anti burglary accessory	1593 x 750 x 620	NSYBGN1576HD
Anti burglary accessory	1593 x 1250 x 420	NSYBGN15124HD
Anti burglary accessory	1593 x 1250 x 620	NSYBGN15126HD
Anti burglary accessory	2093 x 750 x 420	NSYBGN2074HD

Steel outdoor HD enclosures

- Outdoor Heavy-Duty (HD) enclosures made of coated steel.
- Suitable to be installed in private areas with harsh environments thanks to its capacity to resist: corrosion (up to C4H level according to ISO 12944:2018), UV
- Material: HD steel with anti-corrosive painting
- Finish: Structured finish, 100% polyester powder
- Color: RAL 7035 grey
- Conditions of use: Outdoor and/or harsh environments
- Temperature range: -40...80 °C
- Mechanical protection rating: IK10 according to IEC 62262
- Standards: IEC 61439-5: 2010, IEC 62208: 2011, IEC 61969-3: 2011, IEC 60297-3-100: 2009, ISO 12.944: 2018 (C4H)
- Certifications: See table [page 446](#)
- Other characteristics: New dedicated airing solutions to be integrated in roof, side or plinth

Supply:
 Curved canopy
 Plastic document pocket (A4 size)
 Door retainer
 Aluminum cable gland plate

Wall-mounted enclosure

- Ingress protection rating: IP66 according to IEC 60529
- Fixing: On wall by means of optional stainless-steel wall fixing lugs, on post by means of optional HD post fixing device
- Maximum load according to IEC 62208: 200 kg
- cUL according to 508A CSA C.22.2 N° 14 .
- Environmental rating according to UL50E 4, 4x and 13

Supply:
 3-mm double-bar lock



NSYS3HD3215

Characteristics	Dimensions (H x W x D)	References
Wall-mounted enclosure	343 x 200 x 180	NSYS3HD3215
Wall-mounted enclosure	448 x 300 x 230	NSYS3HD4320
Wall-mounted enclosure	548 x 400 x 230	NSYS3HD5420
Wall-mounted enclosure	653 x 400 x 280	NSYS3HD6425
Wall-mounted enclosure	658 x 600 x 330	NSYS3HD6630
Wall-mounted enclosure	753 x 500 x 280	NSYS3HD7525
Wall-mounted enclosure	858 x 600 x 330	NSYS3HD8630
Wall-mounted enclosure	862 x 800 x 430	NSYS3HD8840
Wall-mounted enclosure	1062 x 600 x 430	NSYS3HD10640
Wall-mounted enclosure	1062 x 800 x 430	NSYS3HD10840

Floor-standing enclosure

- Ingress protection rating: IP55 according to IEC 60529
- Fixing: Directly on floor by means of optional plinth
- Maximum load according to IEC 62208: 1000 kg
- Coupling only possible on demand
- cUL according to UL508a.
- Environmental ratings according to UL50E,12 and 3R

Supply:
 Rear panel
 Handle with keylock (1242E type) and padlock



NSYSFHD12640

Characteristics	Dimensions (H x W x D)	References
Floor-standing enclosure	1262 x 600 x 430	NSYSFHD12640
Floor-standing enclosure	1262 x 800 x 430	NSYSFHD12840
Floor-standing enclosure	1262 x 1200 x 430	NSYSFHD1212402D
Floor-standing enclosure	1281 x 600 x 630	NSYSFHD12660
Floor-standing enclosure	1281 x 800 x 630	NSYSFHD12860
Floor-standing enclosure	1281 x 1200 x 630	NSYSFHD1212602D
Floor-standing enclosure	1662 x 800 x 430	NSYSFHD16840
Floor-standing enclosure	1662 x 1200 x 430	NSYSFHD1612402D
Floor-standing enclosure	1681 x 600 x 630	NSYSFHD16660
Floor-standing enclosure	1681 x 800 x 630	NSYSFHD16860
Floor-standing enclosure	1681 x 1200 x 630	NSYSFHD1612602D
Floor-standing enclosure	2062 x 800 x 430	NSYSFHD20840

Side panels for floor-standing enclosures



NSY2SPHD124

- Side panel fixing for SFHD.
- Material: Steel with anti-corrosive painting (C4H according ISO 12.944: 2018)
- Finish: Structured finish, 100% polyester powder
- Color: RAL 7035 grey

Supply:
2 side panels with fixing elements and sealing gasket

Characteristics	Dimensions (H x D)	References
Side panels, external fixing	1262 x 430	NSY2SPHD124
Side panels, external fixing	1281 x 630	NSY2SPHD126
Side panels, external fixing	1662 x 430	NSY2SPHD164
Side panels, external fixing	1681 x 630	NSY2SPHD166
Side panels, external fixing	2060 x 430	NSY2SPHD204
Side panels, internal fixing	1262 x 430	NSY2SPIHD124
Side panels, internal fixing	1281 x 630	NSY2SPIHD126
Side panels, internal fixing	1662 x 430	NSY2SPIHD164
Side panels, internal fixing	1681 x 630	NSY2SPIHD166
Side panels, internal fixing	2060 x 430	NSY2SPIHD204

Stainless-steel wall fixing lugs



NSYAEFFXSC

- Set of 4 wall fixing lugs.
- Mounted directly on the rear of the enclosure, either in horizontal or vertical position.
- Wall-enclosure separation of 12 mm.
- Do not use for dynamic loads.
- Maximum load: 250 kg

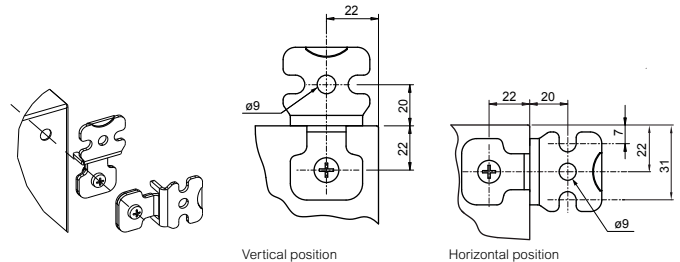

Supply:
Supplied with fixing screws and pre-mounted sealing gaskets

Characteristics	References
Wall fixing lugs, 304L stainless-steel, for outdoor enclosure	NSYAEFFXSC

Heavy-Duty padlockable double lock, for wall-mounted enclosures



NSYAEFLPADS3DHD

- Easy mounting instead of the standard lock.
- Material: Zamak
- Finish: Anti-corrosive painting

Supply:
Delivered with 3-mm double-bar metal key

Characteristics	References
Heavy-Duty padlockable double lock	NSYAEFLPADS3DHD

Stainless-steel plinths 200 mm

- Material: Stainless-steel AISI 304L
- Finish: Scotch-Brite® brushing

Installation: For wall-mounted enclosure: It is necessary to order separately the plinth fixing kit (ref. **NSYAPFXWM**) composed by fixing hardware and drilling template, for floor-standing enclosure: Mounting in the holes for fixing the enclosures to the floor

Ventilated plinths, front and rear kit



NSYSPFVX6200

- The front and rear of the plinth consists of 4 corners with 2 panels.

Characteristics	Width (mm)	References
Ventilated plinths, front and rear kit	600	NSYSPFVX6200
Ventilated plinths, front and rear kit	800	NSYSPFVX8200
Ventilated plinths, front and rear kit	1200	NSYSPFVX12200

Supply:
1 kit

Ventilated plinths, lateral kit



NSYSPLVX4200SF

- They are fixed to the corner of the plinth by fixing screws.

Characteristics	Depth (mm)	References
Ventilated plinths, for wall-mounted enclosure	330	NSYSPLVX3200
Ventilated plinths, for wall-mounted enclosure	430	NSYSPLVX4200
Ventilated plinths, for floor-standing enclosure	430	NSYSPLVX4200SF
Ventilated plinths, for floor-standing enclosure	630	NSYSPLVX6200SF

Supply:
1 kit

Standard plinths, front and rear kit



NSYSPFX6200

- The front and rear of the plinth consists of 4 corners with 2 panels.

Characteristics	Width (mm)	References
Plinth height 200 mm, Kit (4 corners + front and back), AISI 304L	600	NSYSPFX6200
Plinth height 200 mm, Kit (4 corners + front and back), AISI 304L	800	NSYSPFX8200
Plinth height 200 mm, Kit (4 corners + front and back), AISI 304L	1200	NSYSPFX12200

Supply:
1 kit

Standard plinths, lateral kit

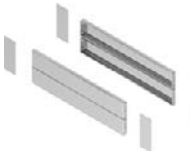

NSYSPSX3200

- They are fixed to the corner of the plinth by fixing screws.

Characteristics	Depth (mm)	References
Standard plinths height 200 mm, for wall-mounted enclosure, AISI 304L	330	NSYSPSX3200
Standard plinths height 200 mm, for wall-mounted enclosure, AISI 304L	430	NSYSPSX4200
Standard plinths height 200 mm, for floor-standing enclosure, AISI 304L	430	NSYSPSX4200SF
Standard plinths height 200 mm, for floor-standing enclosure, AISI 304L	630	NSYSPSX6200SF

Supply:
1 kit

Plain mounting plate



- Material: Galvanized steel

Supply:
1 mounting plate

Characteristics	Dimensions (H x W)	References
Plain mounting plate, for wall-mounted enclosure	300 x 200	NSYMM32
Plain mounting plate, for wall-mounted enclosure	500 x 400	NSYMM54
Plain mounting plate, for wall-mounted enclosure	600 x 400	NSYMM64
Plain mounting plate, for wall-mounted enclosure	600 x 600	NSYMM66
Plain mounting plate, for wall-mounted enclosure	700 x 500	NSYMM75
Plain mounting plate, for wall-mounted enclosure ⁽¹⁾	800 x 600	NSYMM86
Plain mounting plate, for wall-mounted enclosure	800 x 800	NSYMM88
Plain mounting plate, for wall-mounted enclosure	1000 x 600	NSYMM106
Plain mounting plate, for wall-mounted enclosure ⁽¹⁾	1000 x 800	NSYMM108
Plain mounting plate, for floor-standing enclosure	1200 x 600	NSYMP126
Plain mounting plate, for floor-standing enclosure	1200 x 800	NSYMP128
Plain mounting plate, for floor-standing enclosure	1200 x 1200	NSYMP1212
Plain mounting plate, for floor-standing enclosure	1600 x 600	NSYMP168
Plain mounting plate, for floor-standing enclosure	1600 x 800	NSYMP1612
Plain mounting plate, for floor-standing enclosure	1600 x 1200	NSYMP166
Plain mounting plate, for floor-standing enclosure	2000 x 800	NSYMP208

Roof airing module



- Airing module to enable airing from the top of the enclosure (H = 95 mm).
- Material: Steel with anticorrosive painting
- Finish: Structured finish, 100% polyester powder
- Color: RAL 7035 grey

Supply:
1

Characteristics	For enclosure dimensions (W x D)	References
Roof airing module, for wall-mounted enclosure	600 x 430	NSYS3CVR64HD
Roof airing module, for wall-mounted enclosure	800 x 430	NSYS3CVR84HD
Roof airing module, for floor-standing enclosure	600 x 430	NSYSFCVR64HD
Roof airing module, for floor-standing enclosure	600 x 630	NSYSFCVR66HD
Roof airing module, for floor-standing enclosure	800 x 430	NSYSFCVR84HD
Roof airing module, for floor-standing enclosure	800 x 630	NSYSFCVR86HD
Roof airing module, for floor-standing enclosure	1200 x 430	NSYSFCVR124HD
Roof airing module, for floor-standing enclosure	1200 x 630	NSYSFCVR126HD

Airing system Heavy-Duty

Fanbox



NSYCVF550M24FB

- Free flow rate: 550 m³/h (50/60 Hz).
- Minimal depth inside the enclosure (90 mm).
- Allows multiple cooling architectures (see page 444 and 445).
- Material: Plastic
- Color: RAL 7016 dark grey

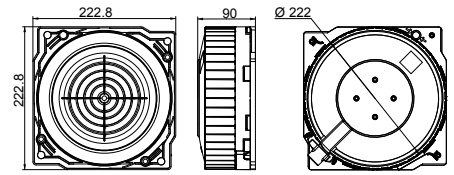

Supply:
1 (grille not included)

Characteristics	Voltage	References
Fanbox	24 V DC	NSYCVF550M24FB
Fanbox	115 V AC	NSYCVF550M115FB
Fanbox	230 V AC	NSYCVF550M230FB

Filter



NSYCAF223T

- Replacement G3 M1 type synthetic filter for HD metal grille.
- Dimensions: 215 x 215 mm.
- Material: 100% polyester fibers
- Color: White

Supply:
5

Characteristics	Height (mm)	Width (mm)	Depth (mm)	Cut-out (mm)	References
G3 M1 synthetic fine filters	268	248	18	223 x 223	NSYCAF223T

Roof filter for fanbox



NSYCAF190

- Roof G2 round synthetic filter designed to cover the fanbox. Covers completely the fanbox and helps to protect it from dust and humidity. Mandatory for fanbox installation in the roof airing module for IP55 configurations.
- Material: 100% polyester fibers
- Color: White

Supply:
1

Characteristics	References
Roof filter for fanbox	NSYCAF190

IP55 HD Metal Grille



NSYCAAG223LFHD

- Slim grille (35 mm external depth).
- Includes a G3 M1
- Material: Steel with anti-corrosive painting + plastic PA6 / GF25 for fixing frame
- Finish: Structured finish, 100% polyester powder
- Color: RAL 7035 grey
- Ingress protection rating: IP55 according to IEC 60529
- Mechanical protection rating: IK10 according to IEC 62262

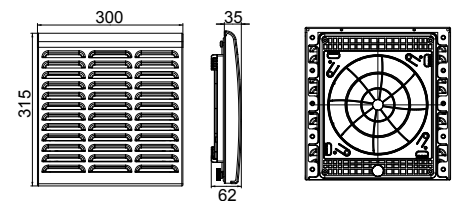

Supply:
1 grille delivered with G3 M1 type synthetic filter (215 x 215 mm) and fixings

Characteristics	References
IP55 HD Metal Grille	NSYCAAG223LFHD

Anti-vandalism kit for HD metal grille



NSYCAAPVHD

- Fixings that help to prevent to open the grille from the outside with standard tools (EN 1627-1630:2011 Class 2).
- Quick installation without tools.
- Material: Steel with anticorrosive painting + plastic for fixing screws

Note:
not compatible with NSYSPLA150

Supply:
4 grip knob
4 clip nuts

Characteristics	References
Anti-vandalism kit for HD metal grille	NSYCAAPVHD

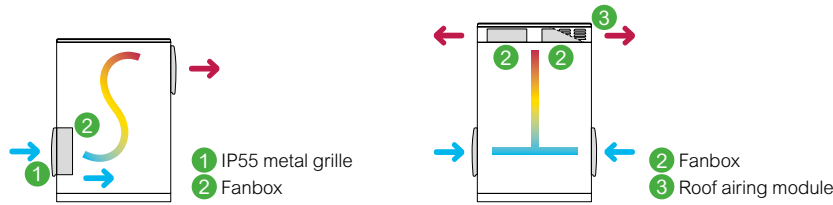

	S-Line				T-Line				
Architecture benefits	<ul style="list-style-type: none"> • Most common and competitive architecture • Maximum heat dissipation to extract 800 W-1000 W • ΔT° of 5 $^\circ C$ • Easy access to mount-dismount fanbox • Air flow in horizontal axis 				<ul style="list-style-type: none"> • High thermal extraction capacity up to 1500 W • Noise level with 1 fan: 55 dB when installed inside the upper airing module • ΔT° of 5 $^\circ C$ • Air flow in vertical axis 				
	IP55 metal grille		Fanbox		IP55 metal grille		Fanbox (1 filter NSYCAF190 for each Fanbox)		Roof airing module
	Door	Side	Door	Side	Door	Side			

Polyester outdoor HD enclosure									
References	Amount to be installed				Amount to be installed				References
NSYPHDT553	-	-	-	-	-	-	-	-	-
NSYPHDT553P	-	-	-	-	-	-	-	-	-
NSYPHDT753	-	-	-	-	-	-	-	-	-
NSYPHDT753P	1 to 2	-	1 to 2	-	1 to 2	-	-	-	-
NSYPHDT774	-	1 to 2	-	1 to 2	-	1 to 2	1 to 2	1	NSYPCVR74HD
NSYPHDT774P	1 to 2	1 to 2	1 to 2	1 to 2	1 to 2	1 to 2	1 to 2	1	NSYPCVR74HD
NSYPHDT776	-	1 to 2	-	1 to 2	-	1 to 2	1 to 2	1	NSYPCVR76HD
NSYPHDT776P	1 to 2	1 to 2	1 to 2	1 to 2	1 to 2	1 to 2	1 to 2	1	NSYPCVR76HD
NSYPHDT1054	-	1	-	1	-	1	1	1	NSYPCVR54HD
NSYPHDT1054P	1 to 2	1	1 to 2	1	1 to 2	1	1	1	NSYPCVR54HD
NSYPHDT1074	-	1 to 2	-	1 to 2	-	1 to 2	1 to 2	1	NSYPCVR74HD
NSYPHDT1074P	1 to 4	1 to 2	1 to 4	1 to 2	1 to 4	1 to 2	1 to 2	1	NSYPCVR74HD
NSYPHDT12124	-	1 to 3	-	1 to 3	-	1 to 3	1 to 3	1	NSYPCVR124HD
NSYPHDT12124P	1 to 4	1 to 3	1 to 4	1 to 3	1 to 4	1 to 3	1 to 3	1	NSYPCVR124HD
NSYPHDT12126	-	1 to 3	-	1 to 3	-	1 to 3	1 to 3	1	NSYPCVR126HD
NSYPHDT12126P	1 to 4	1 to 3	1 to 4	1 to 3	1 to 4	1 to 3	1 to 3	1	NSYPCVR126HD
NSYPHDT1254	-	1	-	1	-	1	1	1	NSYPCVR54HD
NSYPHDT1254P	1 to 3	1	1 to 3	1	1 to 3	1	1	1	NSYPCVR54HD
NSYPHDT1274	-	1 to 2	-	1 to 2	-	1 to 2	1 to 2	1	NSYPCVR74HD
NSYPHDT1274P	1 to 4	1 to 2	1 to 4	1 to 2	1 to 4	1 to 2	1 to 2	1	NSYPCVR74HD
NSYPHDT1276	-	1 to 2	-	1 to 2	-	1 to 2	1 to 2	1	NSYPCVR76HD
NSYPHDT1276P	1 to 4	1 to 2	1 to 4	1 to 2	1 to 4	1 to 2	1 to 2	1	NSYPCVR76HD
NSYPHDT15124	-	1 to 3	-	1 to 3	-	1 to 3	1 to 3	1	NSYPCVR124HD
NSYPHDT15124P	1 to 4	1 to 3	1 to 4	1 to 3	1 to 4	1 to 3	1 to 3	1	NSYPCVR124HD
NSYPHDT15126	-	1 to 3	-	1 to 3	-	1 to 3	1 to 3	1	NSYPCVR126HD
NSYPHDT15126P	1 to 4	1 to 3	1 to 4	1 to 3	1 to 4	1 to 3	1 to 3	1	NSYPCVR126HD
NSYPHDT1574	-	1 to 2	-	1 to 2	-	1 to 2	1 to 2	1	NSYPCVR74HD
NSYPHDT1574P	1 to 4	1 to 2	1 to 4	1 to 2	1 to 4	1 to 2	1 to 2	1	NSYPCVR74HD
NSYPHDT1576	-	1 to 2	-	1 to 2	-	1 to 2	1 to 2	1	NSYPCVR76HD
NSYPHDT1576P	1 to 4	1 to 2	1 to 4	1 to 2	1 to 4	1 to 2	1 to 2	1	NSYPCVR76HD
NSYPHDT2074	-	1 to 2	-	1 to 2	-	1 to 2	1 to 2	1	NSYPCVR74HD
NSYPHDT2074P	1 to 4	1 to 2	1 to 4	1 to 2	1 to 4	1 to 2	1 to 2	1	NSYPCVR74HD

Steel outdoor HD enclosure									
NSYS3HD8630	1 to 2	-	1 to 2	-	1 to 2	-	-	-	-
NSYS3HD8840	1 to 2	1 to 2	1 to 2	1 to 2	1 to 2	1 to 2	1 to 2	1	NSYS3CVR84HD
NSYS3HD10640	1 to 2	1 to 2	1 to 2	1 to 2	1 to 2	1 to 2	1	1	NSYS3CVR64HD
NSYS3HD10840	1 to 4	1 to 2	1 to 4	1 to 2	1 to 4	1 to 2	1 to 2	1	NSYS3CVR84HD
NSYSFHD12640	1 to 3	1 to 3	1 to 3	1 to 3	1 to 3	1 to 3	1	1	NSYSFCVR64HD
NSYSFHD12660	1 to 3	1 to 3	1 to 3	1 to 3	1 to 3	1 to 3	1	1	NSYSFCVR66HD
NSYSFHD12840	1 to 4	1 to 3	1 to 4	1 to 3	1 to 4	1 to 3	1 to 2	1	NSYSFCVR84HD
NSYSFHD12860	1 to 4	1 to 3	1 to 4	1 to 3	1 to 4	1 to 3	1 to 2	1	NSYSFECA66HD
NSYSFHD16660	1 to 4	1 to 4	1 to 4	1 to 4	1 to 4	1 to 4	1	1	NSYSFCVR66HD
NSYSFHD16840	1 to 4	1 to 4	1 to 4	1 to 3	1 to 4	1 to 3	1 to 2	1	NSYSFCVR84HD
NSYSFHD16860	1 to 4	1 to 4	1 to 4	1 to 4	1 to 4	1 to 4	1 to 2	1	NSYSFECA66HD
NSYSFHD20840	1 to 4	1 to 4	1 to 4	1 to 4	1 to 4	1 to 4	1 to 2	1	NSYSFCVR84HD
NSYSFHD1212402D	1 to 4	1 to 3	1 to 4	1 to 2	1 to 4	1 to 2	1 to 3	1	NSYSFCVR124HD
NSYSFHD1212602D	1 to 4	1 to 3	1 to 4	1 to 3	1 to 4	1 to 2	1 to 3	1	NSYSFCVR126HD
NSYSFHD1612402D	1 to 4	1 to 4	1 to 4	1 to 3	1 to 4	1 to 3	1 to 3	1	NSYSFCVR124HD
NSYSFHD1612602D	1 to 4	1 to 4	1 to 4	1 to 3	1 to 4	1 to 3	1 to 3	1	NSYSFCVR126HD

Technical changes reserved. Information provided without guarantee. Images are for illustrative purposes only.

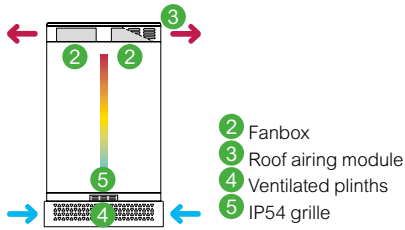

This table helps to configure thermal architectures, but it is highly recommended to use ProClima Software to ensure the right thermal solution according to the selected architecture.

I-Line

- Integrated architecture particularly suitable for public areas
- High thermal extraction capacity up to 1500 W
- Noise level with 1 fan: 55 dB when installed inside the upper airing module
- Good extraction flow rate power
- Air flow in vertical axis

IP54 outlet grille (NSYCAG223LPF + G3 filter NSYCAF223T)	Ventilated plinths	Fanbox (1 filter NSYCAF190 for each Fanbox)	Roof airing module
--	--------------------	---	--------------------

Amount to be installed		References		Amount to be installed		References	
-	-	-	-	-	-	-	-
-	-	-	-	-	-	-	-
-	-	-	-	-	-	-	-
-	-	-	-	-	-	-	-
1 to 2	1	NSYZZ274VHD	-	1 to 2	1	NSYPCVR74HD	-
1 to 2	1	NSYZZ274VHD	-	1 to 2	1	NSYPCVR74HD	-
1 to 2	1	NSYZZ276VHD	-	1 to 2	1	NSYPCVR76HD	-
1 to 2	1	NSYZZ276VHD	-	1 to 2	1	NSYPCVR76HD	-
1	1	NSYZZ254VHD	-	1	1	NSYPCVR54HD	-
1	1	NSYZZ254VHD	-	1	1	NSYPCVR54HD	-
1 to 2	1	NSYZZ274VHD	-	1 to 2	1	NSYPCVR74HD	-
1 to 2	1	NSYZZ274VHD	-	1 to 2	1	NSYPCVR74HD	-
1 to 3	1	NSYZZ2124VHD	-	1 to 3	1	NSYPCVR124HD	-
1 to 3	1	NSYZZ2124VHD	-	1 to 3	1	NSYPCVR124HD	-
1 to 3	1	NSYZZ2126VHD	-	1 to 3	1	NSYPCVR126HD	-
1 to 3	1	NSYZZ2126VHD	-	1 to 3	1	NSYPCVR126HD	-
1	1	NSYZZ254VHD	-	1	1	NSYPCVR54HD	-
1	1	NSYZZ254VHD	-	1	1	NSYPCVR54HD	-
1 to 2	1	NSYZZ274VHD	-	1 to 2	1	NSYPCVR74HD	-
1 to 2	1	NSYZZ274VHD	-	1 to 2	1	NSYPCVR74HD	-
1 to 2	1	NSYZZ276VHD	-	1 to 2	1	NSYPCVR76HD	-
1 to 2	1	NSYZZ276VHD	-	1 to 2	1	NSYPCVR76HD	-
1 to 3	1	NSYZZ2124VHD	-	1 to 3	1	NSYPCVR124HD	-
1 to 3	1	NSYZZ2124VHD	-	1 to 3	1	NSYPCVR124HD	-
1 to 3	1	NSYZZ2126VHD	-	1 to 3	1	NSYPCVR126HD	-
1 to 3	1	NSYZZ2126VHD	-	1 to 3	1	NSYPCVR126HD	-
1 to 2	1	NSYZZ274VHD	-	1 to 2	1	NSYPCVR74HD	-
1 to 2	1	NSYZZ274VHD	-	1 to 2	1	NSYPCVR74HD	-
1 to 2	1	NSYZZ276VHD	-	1 to 2	1	NSYPCVR76HD	-
1 to 2	1	NSYZZ276VHD	-	1 to 2	1	NSYPCVR76HD	-
1 to 2	1	NSYZZ274VHD	-	1 to 2	1	NSYPCVR74HD	-
1 to 2	1	NSYZZ274VHD	-	1 to 2	1	NSYPCVR74HD	-

1	1	NSYSPFVX6200	NSYSPSX3200	-	-	-	-
1 to 2	1	NSYSPFVX8200	NSYSPLVX4200	1 to 2	1	NSYS3CVR84HD	-
1	1	NSYSPFVX6200	NSYSPLVX4200	1	1	NSYS3CVR64HD	-
1	1	NSYSPFVX8200	NSYSPLVX4200	1 to 2	1	NSYS3CVR84HD	-
1	1	NSYSPFVX6200	NSYSPLVX4200	1	1	NSYSFCVR64HD	-
1	1	NSYSPFVX6200	NSYSPLVX6200	1	1	NSYSFCVR66HD	-
1 to 2	1	NSYSPFVX8200	NSYSPLVX4200	1 to 2	1	NSYSFCVR84HD	-
1 to 2	1	NSYSPFVX8200	NSYSPLVX6200	1 to 2	1	NSYSFECA66HD	-
1	1	NSYSPFVX6200	NSYSPLVX6200	1	1	NSYSFCVR66HD	-
1 to 2	1	NSYSPFVX8200	NSYSPLVX4200	1 to 2	1	NSYSFCVR84HD	-
1 to 2	1	NSYSPFVX8200	NSYSPLVX6200	1 to 2	1	NSYSFECA66HD	-
1 to 2	1	NSYSPFVX8200	NSYSPLVX4200	1 to 2	1	NSYSFCVR84HD	-
1 to 3	1	NSYSPFVX12200	NSYSPLVX4200	1 to 3	1	NSYSFCVR124HD	-
1 to 3	1	NSYSPFVX12200	NSYSPLVX6200	1 to 3	1	NSYSFCVR126HD	-
1 to 3	1	NSYSPFVX12200	NSYSPLVX4200	1 to 3	1	NSYSFCVR124HD	-
1 to 3	1	NSYSPFVX12200	NSYSPLVX6200	1 to 3	1	NSYSFCVR126HD	-

Technical changes reserved. Information provided without guarantee. Images are for illustrative purposes only.

POLYESTER Thalassa PHD				
Test description	Standard	Standard title	Certification	Declaration
IP55, IK10, lifting: 500 kg max. (IP65 for wall-mounted)	IEC 62208: 2011	Empty enclosures for low-voltage switchgear and controlgear assemblies - General requirements	●	-
Class II Insulation	IEC 61439-1: 2011	Low-voltage switchgear and controlgear assemblies Part 1: General rules	-	✓
Strength of materials and parts	IEC 61439-5: 2010	Low-voltage switchgear and controlgear assemblies Part 5: Assemblies for power distribution in public networks	●	-
Corrosion resistance C4H. It affects the painted accessories (ventilated roof, anti-burglary kit). All other metal parts have special treatment to pass the same test.	ISO 12.944: 2018	Paints and varnishes-corrosion protection of steel structures by protective paint systems Part 6: laboratory performance testing methods	-	✓
Climatic test, Biological Test, Resistance against chemically and mechanical active substances. Mechanical test, Lifting and stiffness test	IEC 61969-3: 2011	Electronic "Mechanical structures for electronic equipment - Outdoor enclosures" Part 3: Environmental requirements, tests and safety aspects	●	-
Space for electronics	IEC 60297-3-100: 2009	Mechanical structures for electronic equipment Dimensions of mechanical structures of the 482.6 mm (19 in) series - Part 3-100: Basic dimensions of front panels, subracks, chassis, racks and cabinets	-	✓
Dimensional	EIA-310-E	Cabinets, Racks, Panels, and associated equipment	-	✓
Fire resistance	EN 1794-2:2011	Vandalism: Fire resistance	-	✓
Posting	Internal test	Door anti-posting internal test	-	✓
Single-door: types 1, 2, 3, 3R, 4, 4X, 5, 12 and 13 Double-door: types 1, 2, 3, 3R, 5, 12 and 13	UL 508 A CSA c.22.2 No 14	Standard for Industrial Control Panels. Standard for Industrial Control Equipment.	●	-
Spacial SFHD (floor-standing enclosures)				
IP55, IK10, lifting: 1000 kg max.	IEC 62208: 2011	Empty enclosures for low-voltage switchgear and controlgear assemblies - General requirements	●	-
Strength of materials and parts	IEC 61.439-5: 2010	Low-voltage switchgear and controlgear assemblies Part 5: Assemblies for power distribution in public networks	●	-
Corrosion resistance C4H	ISO 12.944: 2018	Paints and varnishes-corrosion protection of steel structures by protective paint systems Part 6: laboratory performance testing methods	●	-
Climatic test, Biological Test, Resistance against chemically and mechanical active substances. Mechanical test, Lifting and stiffness test	IEC 61969-3: 2011	Electronic "Mechanical structures for electronic equipment - Outdoor enclosures" Part 3: Environmental requirements, tests and safety aspects	●	-
Space for electronics	IEC 60297-3-100: 2009	Mechanical structures for electronic equipment Dimensions of mechanical structures of the 482.6 mm (19 in) series - Part 3-100: Basic dimensions of front panels, subracks, chassis, racks and cabinets	-	✓
Dimensional	EIA-310-E	Cabinets, Racks, Panels, and associated equipment	-	✓
Single-door: Types 1, 3R, 12 Double-door: Types 1, 3R, 12	UL 508 A CSA C.22 No 14-18 UL50E	Standard for Industrial Control Panels. Standard for Industrial Control Equipment.	●	-
Spacial S3HD (wall-mounted enclosures)				
IP66, IK10, lifting: 200 kg max.	IEC 62208: 2011	Empty enclosures for low-voltage switchgear and controlgear assemblies - General requirements	●	-
Strength of materials and parts	IEC 61.439-5: 2010	Low-voltage switchgear and controlgear assemblies Part 5: Assemblies for power distribution in public networks	●	-
Corrosion resistance C4H	ISO 12.944: 2018	Paints and varnishes-corrosion protection of steel structures by protective paint systems Part 6: Laboratory performance testing methods	●	-
Climatic test, Biological Test, Resistance against chemically and mechanical active substances. Mechanical test, Lifting and stiffness test	IEC 61969-3: 2011	Electronic "Mechanical structures for electronic equipment - Outdoor enclosures" Part 3: Environmental requirements, tests and safety aspects	●	-
Space for electronics	IEC 60297-3-100: 2009	Mechanical structures for electronic equipment Dimensions of mechanical structures of the 482.6 mm (19 in) series - Part 3-100: Basic dimensions of front panels, subracks, chassis, racks and cabinets	-	✓
Dimensional	EIA-310-E	Cabinets, Racks, Panels, and associated equipment	-	✓
Single-door: Types 1, 2, 3, 3R, 4, 4X, 5, 12 and 13	UL 508 A: 2007 CSA c.22.2 No 14	Standard for Industrial Control Panels. Standard for Industrial Control Equipment.	●	-

Technical changes reserved. Information provided without guarantee. Images are for illustrative purposes only.

HD ACCESSORIES HD THERMAL Management, Fanbox				
Test description	Standard	Standard title	Certification	Declaration
NSYCVF Series are intended for mounting on the flat surface of a Type 12 or 12K enclosure	UL 508A CAN/CSA-C22.2 No. 14, CAN/CSA C22.2 No. 94-M91 CAN/CSA C22.2 No. 73	Industrial Control Panels Industrial Control Equipment Special Purpose Enclosures Electrically Equipped Machine Tools	●	-
IP55 HD Metal grille (NSYCAG223LFHD)				
IP55 (in conditions of use)	IEC 60529: 2013	Degrees of protection provided by enclosures (IP Code)	-	✓
Corrosion resistance C4H	ISO 12.944: 2018	Paints and varnishes-corrosion protection of steel structures by protective paint systems - part 6: Laboratory performance testing methods	●	-
Anti-vandalism kit for HD metal grille (NSYCAAPVHD)				
Resistance Class 2	ENV 1627:2011	Burglar resistance - Requirements and classification	●	-
Upper airing module (PHD / SFHD / S3HD)				
IP55 (in conditions of use)	IEC 60529: 2013	Degrees of protection provided by enclosures (IP Code)	-	✓
Corrosion resistance at level C4H	ISO 12.944: 2018	Paints and varnishes-corrosion protection of steel structures by protective paint systems Part 6: Laboratory performance testing methods	●	-
HD POLYESTER ENCLOSURES				
Anti burglary accessory (NSYBGN•••HD)				
Resistance Class 2	ENV 1627:2011	Burglar resistance - Requirements and classification	●	-
Corrosion resistance at level C4H	ISO 12.944: 2018	Paints and varnishes-corrosion protection of steel structures by protective paint systems Part 6: Laboratory performance testing methods	●	-
ZZ plinths (NSYZZ••• and NSYZZ•••VHD)				
ZZ Plinth: IP44 (in conditions of use) Ventilated ZZ Plinth: IP43 (in conditions of use)	IEC 60.529:2013	Degrees of protection provided by enclosures (IP Code)	-	✓
Eyebolts (NSYPLHD)				
Maximum load 500 kg	IEC 62208: 2011	Empty enclosures for low-voltage switchgear and controlgear assemblies - General requirements	-	✓
HD STEEL ENCLOSURES				
Stainless-steel plinths (NSYSFVX••• / NSYSPLVX••• / NSYSPSX••• / NSYSPSX•••)				
Ventilated plinth: IP20 (in conditions of use) Standard plinth: IP30 (in conditions of use)	IEC 60.529:2013	Degrees of protection provided by enclosures (IP Code)	-	✓

Horizontal wall-mounted enclosures designed for photovoltaic and multiple outdoor applications installed in harsh environments

New

- Wall-mounted enclosures made of **fiberglass reinforced polyester** molded by hot compression.
- Monobloc body with polyurethane gasket.
- **Wider sizes with more space available in the bottom of the enclosure** to install additional cable entries.
- **Impact resistance IK10**, IEC 62262.
- **Protection degree IP 66**, IEC 60529.
- Class II insulation.
- Certifications: **IEC 62208 & UL 508A - NEMA type: 1, 2, 3, 3R, 3S, 4, 4X, 5, 12 and 13.**
- Reach & RoHs compliance.
- Color: **RAL 7035.**

Removable door system

- Removable door system that allows:
 - Total access without limitations to the internal part of the enclosure.
 - Easy and quick assembly/disassembly of the door. (without dismantling the hinges and removing the pin)



Self-adhesive and fixable canopy

- Self-adhesive and fixable canopy made of PVC available as an accessory - black RAL 9005 Color. Die-cut to be easily fixed by two screws. IP degree is maintained.
- For outdoor use, the canopy must be installed to protect the door gasket against water stagnation.

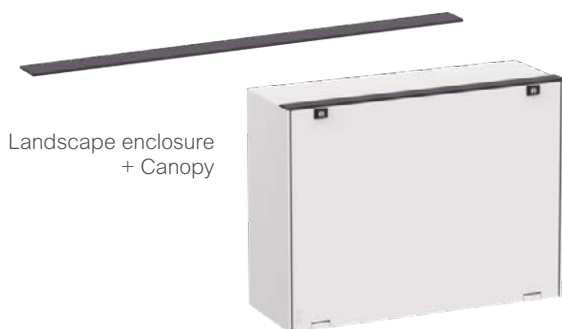

Wall fixing lugs

- Set of 4 wall fixing lugs (plastic or stainless-steel) available as an accessory.
- Quick and easy assembly through the inserts, without drilling the enclosure. IP guaranteed.



Landscape enclosures. RAL 7035



NSYS3HD3215



NSYPLM810G

Characteristics	Height (mm)	Width (mm)	Depth (mm)	Number of locks	References
Landscape enclosures. RAL 7035	536	747	300	2	NSYPLM57G New
Landscape enclosures. RAL 7035	636	847	300	2	NSYPLM68G New
Landscape enclosures. RAL 7035	852	1056	350	1	NSYPLM810G New

Canopy PVC - RAL 9005

- Self-adhesive & fixable by screws
- Holes pre die-cut
- IP is maintained



NSYS3HD3215

Characteristics	Height (mm)	Width (mm)	Depth (mm)	Enclosure	References
Canopy PVC - RAL 9005	5	747	62	NSYPLM57G	NSYCSA57 New
Canopy PVC - RAL 9005	5	847	62	NSYPLM68G	NSYCSA68 New
Canopy PVC - RAL 9005	5	1056	62	NSYPLM810G	NSYCSA810 New

Plain mounting plate



NSYMM75

- Material: Galvanized steel

Characteristics	Dimensions (H x W)	Enclosure	References
Plain mounting plate, for wall-mounted enclosure	700 x 500	NSYPLM57G	NSYMM75
Plain mounting plate, for wall-mounted enclosure	800 x 600	NSYPLM68G	NSYMM86
Plain mounting plate, for wall-mounted enclosure	1000 x 800	NSYPLM810G	NSYMM108

Plain mounting plate



NSYMPP75

- Material: Polyester

Characteristics	Dimensions (H x W)	Enclosure	References
Plain mounting plate, for wall-mounted enclosure	700 x 500	NSYPLM57G	NSYMPP75
Plain mounting plate, for wall-mounted enclosure	800 x 600	NSYPLM68G	NSYMPP86
Plain mounting plate, for wall-mounted enclosure	1000 x 800	NSYPLM810G	NSYMPP108

Wall fixing lugs



NSYFPPLMG

Set of 4 wall fixing lugs. Mounted directly on the enclosure, either in horizontal position or in vertical position.

- Material: Fiberglass-reinforced polyamide
- Color: RAL 7035 grey
- **Maximum load:**

On PLM32: Vertical or horizontal: 10 kg

Other PLM models: Vertical position: 200 kg, horizontal position: 100 kg

Supply:

Delivered with fixings

Characteristics	Reference
Wall fixing lugs	NSYFPPLMG

Wall fixing lugs



NSYFPXPLM

Set of 4 wall fixing lugs. Mounted directly on the enclosure, either in horizontal position or in vertical position.

- Material: Stainless-steel
- Color: RAL 7035 grey
- **Maximum load:**

Other PLM models: Vertical position: 200 kg, horizontal position: 100 kg

Supply:

Delivered with fixings

Characteristics	Reference
Wall fixing lugs	NSYFPXPLM



Customized Service

Machining service available. Please consult your Universal Enclosure sales representative.



Scan or click for video



The seismic risk

No point of the globe is immune to an earthquake. However, the probability of being subjected to an earthquake of a given intensity varies from one location to another. The map below, taken from IEC 60721-2-6, shows the distribution of the seismic risk on the 5 continents.

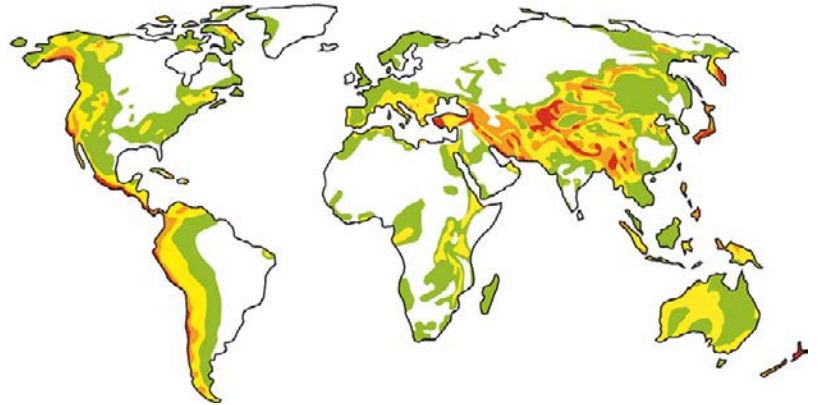
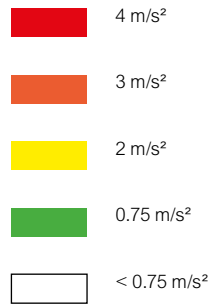

Spacial enclosures and the seismic constraint

Spacial standard range solutions

The Spacial standard offers have been qualified for use in areas subject to medium intensity earthquakes (ground acceleration $\leq 3 \text{ m/s}^2$).

For details of the seismic resistance of the standard offers, refer to the individual chapters of the following offers:

- S3D, CRN, CRNG et 19" wall-mounted enclosures,
- SBM industrial boxes,
- SF enclosures (automation and monitoring/control),
- PrismaSeT HD enclosures (functional system for low-voltage electricity distribution),
- 19" SF enclosures (pivoting rack).

Enclosures for strong earthquakes

In order to meet the requirements of high-seismic zones (ground acceleration $\geq 4 \text{ m/s}^2$), Schneider Electric has developed 2 offers:

- Floor-standing enclosures SF 6G and PrismaSeT HD 5G,
- Wall-mounted enclosure S3D 6G,

Certifications

All tests have been performed according to the following technical regulations:

- IEC 60068-3-3 (first edition): International standard. Environmental testing – Part 3 : Guidance – Seismic test methods for equipment
- CRT 91-C-112-00: Seismic resistance of equipment Generic provisions for bi-axial testing using accelerograms

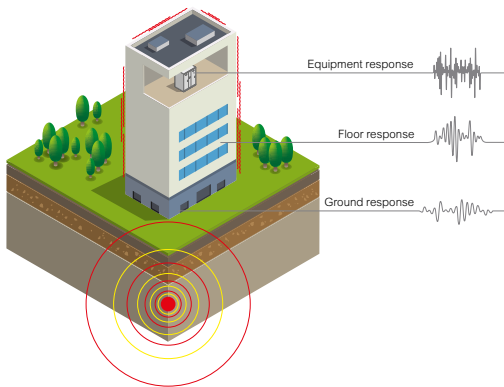

Technical information

Seismic standards

There is no single international standard. The standards depend on each country/zone and are linked to civil engineering standards.

The main ones are:

- International Building Code (I.B.C. Ex UBC)
- IEC 60068-3-3,
- EDF specification CRT 91C11200 (ex-HN-20-E-53)

The Spacial enclosures have been tested according to standards IEC 60068-3-3 and CRT 91-C-112-00. CRT 91-C-112-00 is one of the most restrictive specifications, and for which it is therefore more difficult to obtain certification.

To define the seismic resistance of equipment, it is necessary to take into account the geological characteristics of the earthquake and the behavior of the building, and compare these with the equipment's seismic performance.

Geology
Equivalence between scales characterizing the earthquake

MSK	Richter	IEC 60068-3-3 (ground acc.)
<VIII	< 5.5	2 m/s ²
VIII to IX	≥ 5.5 and ≤ 7	3 m/s ²
>IX	> 7	5 m/s ²

Civil engineering
Example acceleration levels on the floor of a building (RRS)
All types of building (IEC 60068-3-3)

6 m/s ²
9 m/s ²
15 m/s ²

Equipment performance tested according to CRT 91 C 112 00

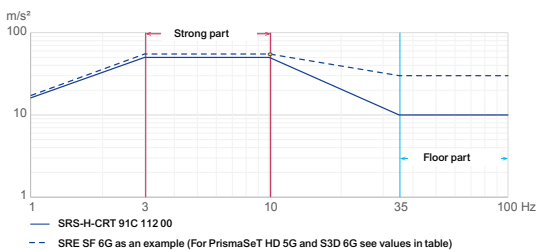

Products	Floor part acc	Strong part acc
PrismaSeT HD 5G	20 m/s ²	50 m/s ²
SF 6G*	30 m/s ²	50 m/s ²
S3D 6G*	30 m/s ²	55 m/s ²

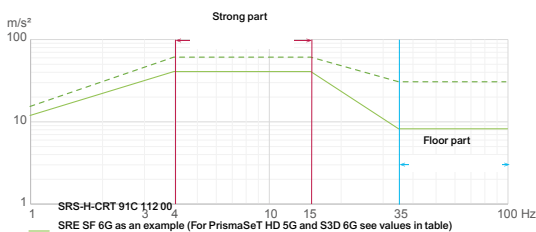

Products	Floor part acc	Strong part acc
PrismaSeT HD 5G	20 m/s ²	40 m/s ²
SF 6G*	30 m/s ²	60 m/s ²
S3D 6G*	30 m/s ²	80 m/s ²

Definitions

Ground acceleration: Ground acceleration resulting from an earthquake. Note: In practice, ground acceleration can be broken down into horizontal and vertical components.

Floor acceleration: Ground acceleration measured on a particular floor in a building (at the location of an equipment item).

Note: In practice, floor acceleration can be broken down into horizontal and vertical components.

Required response spectrum (RRS): Representation of the amplification of the ground acceleration caused by the structure or equipment according to the wave frequency. Used for determining equipment dimensions and qualifying the equipment.

Test response spectrum (TRS): Representation of the amplification of tested products during tests on vibrating table.

Two parts are defined in the response spectra:

- **Floor part:** On the product zone in contact with the vibrating table there is no amplification of the acceleration. The acceleration value recorded for the spectrum is that measured on the ground.
- **Strong part:** The acceleration value recorded for the spectrum is the maximum amplified acceleration expected at the center of gravity of the equipment. This is not a measurable quantity but a mathematical representation.

Conclusion: The TRS values must be compared to the RRS values. If they are greater, the equipment will resist the effects of the earthquake.

The **Spacial SF 6G** enclosures have been designed to withstand earthquakes corresponding to UBC Zone 4.

Spacial SF 6G for seismic risks



11



Panel mounting

- 12 fastening points by M6 screws per panel..

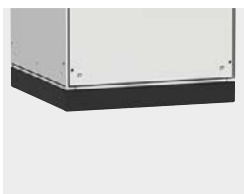

Plinths

- Enhanced mechanical strength (monobloc structure).
- Assembled on the enclosure.
- Floor fixing: 10 fastening points by M12 screws.



Security locking system

- Seismic locking system.
- Special connecting rods and handle to prevent any accidental door opening under severe vibration conditions.



Multi-purpose corners

- To strengthen the enclosure and respond to seismic risks.
- To strengthen fastening of the side panels and rear panel.
- To fasten the door connecting rods.

Spacial SF 6G for seismic risks



NSYSF6G20680

- Enclosures designed to be installed in UBC Zone 4.
- They have been tested with a plain mounting plate and 19" rack.
- Integrated plinth.
- Material: Steel
- Ingress protection rating: IP55 according to IEC 60529
- Mechanical protection rating: IK10 according to IEC 62262
- Maximum load: 80 kg/m² on plain mounting plate,
- Standards: IEC 62208 (enclosure) - IEC 60068-3-3 (seismic methods to apply for materials)
- Certifications: 6G certification as per CRT 91-C-112-00 (EDF) - UL50E types 1, 12

Supply:

Framework

- 1 upper frame with roof
- 1 lower frame
- 1 rear panel
- 4 uprights
- 8 multi-purpose reinforcement corners
- 8 cross-rails fastened to the framework contributing to the seismic resistance (3 left, 3 right, 2 rear)

Plinth

- Monobloc base 4 mm thick, 100 mm high

Door

- Plain door with EDF 1600 captive key lock
- 3 fastening points with connecting rods
- Door hinges on right (opposite direction available on request)

Coupling

- Option to couple SF 6G enclosures with the coupling kits ref. **NSYSFBK19** + **NSYSFBKR**
- Option to couple plinth with the ref. **NSYPLK6G**

Characteristics	Height (mm)	Width (mm)	Depth (mm)	References
Spacial SF 6G	2000	600	800	NSYSF6G20680
Spacial SF 6G	2000	800	600	NSYSF6G20860
Spacial SF 6G	2000	800	800	NSYSF6G20880

Side panels

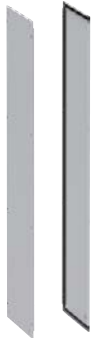

NSY6G2SP204

- Enclosures designed to be installed in UBC Zone 4.
- They have been tested with a plain mounting plate and 19" rack.
- Integrated plinth.
- Material: Steel
- Installation: 12 fastening points

Supply:

2 side panels and fasteners

Characteristics	Height (mm)	Depth (mm)	References
Side panel	2000	600	NSY6G2SP206
Side panel	2000	800	NSY6G2SP208

Mounting plate



NSYMP206

- Material: Galvanized steel
- Installation: Mounting plate to be installed with **NSYSFPB6G** fastening kit + **NSYHLCR●●** cross-rails

Supply:

1 mounting plate and sliding shoes

Characteristics	Height (mm)	Depth (mm)	References
Mounting plate	2000	600	NSYMP206
Mounting plate	2000	800	NSYMP208

Rails for heavy load



- Material: Zinc-coated steel

Supply:
2 cross-rails and fixing elements

Characteristics	Depth (mm)	References
Rails for heavy load	400	NSYHLCR40
Rails for heavy load	600	NSYHLCR60
Rails for heavy load	800	NSYHLCR80

Reinforced fixing kit for mounting plate

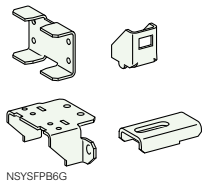

- Material: Steel

Supply:
6 anti-vibration supports
4 mounting brackets
4 supports
2 connectors and fixing elements

Characteristics	References
Reinforced fixing kit for mounting plate	NSYSFPB6G

Trim cap for SF 6G panels



- Material: Plastic

Supply:
50 units

Characteristics	References
Trim cap for SF 6G panels	NSYCSP6G

19" fixed uprights

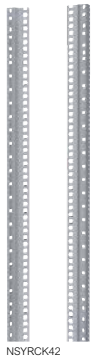

- Uprights designed to be assembled on enclosures 800 mm wide and 800 mm deep.
- Material: Zinc-coated steel
- Fixing: To fasten the 19" uprights, it is necessary to use the fixing kit **NSYRCK19KIT6G**

Note:
For a 19" seismic configuration, 4 uprights must be used

Supply:
2 uprights and fasteners,

Characteristics	References
19" fixed uprights	NSYRCK42

19" fixed uprights

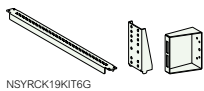

- Material: Steel

Supply:
4 cross-rails
8 fastening brackets
4 reinforcements
Fixing elements

Characteristics	References
19" fixed uprights	NSYRCK19KIT6G

Optional locks for enclosure



- With captive key.
- Material: Polyamide handle, metal connecting rods and cam

Supply:
3-point lock with
1 lock button and
1 cremone screw

Characteristics	References
Optional lock for enclosure, EDF 900	NSYAEDLEDF9K33
Optional lock for enclosure, EDF 1300	NSYAEDLEDF13K33
Optional lock for enclosure, EDF 1400	NSYAEDLEDF14K33
Optional lock for enclosure, 1242E	NSYAEDL1242K33
Optional lock for enclosure, 405E	NSYAEDL405K33
Optional lock for enclosure, 455E	NSYAEDL455K33

Local seismic standards: Conformity with acceleration severity levels (not considered other aspects)

Standards	Specifications
EDF book of technical rules CRT 91C11200	"Large equipment" MRI RRS: Horizontal: Floor acceleration = 2 g Amplified max. acceleration at center of gravity = 5 g Vertical: Floor acceleration = 2.4 g Amplified max. acceleration at center of gravity = 6 g
EAK 2000 Greece	Seismic risk zone: IV Importance category: S4
ENDESA 1986	All seismic categories Ground acceleration = 0.5 g
RPA 99 2003 Algeria	All types of soil class Ground acceleration factor A = 0.36 Behavior factor R = 2 Quality factor Q = 1.35
Turkish Seismic Code 2009	All types of site class Importance factor = 1.5 Ground acceleration factor: A0 = 0.4
GOST 17516.1-90 Russia	Civil market: MSK intensity 9, level 3. Nuclear market: MSK intensity 9, level 2.
Eurocode 8	All soil types agR = 3 m/s ² Importance factor = 1.3

Spacial SF 6G for seismic risks

Busbar compartment enclosure, available depths with conformity declaration

Height	Width			
	300	400	600	800
2200	-	600	-	-
2000	500 / 600 / 800	400 / 500 / 600 / 800	-	-
1800	-	400 / 500 / 600	-	-
1600	-	-	-	-
1400	-	-	-	-
1200	-	-	-	-

Enclosure equipped with plain mounting plate, available depths

Height	Width			
	300	400	600	800
2200	-	-	800	600 / 800
1800	-	-	600 / 800	600
1600	-	-	600 / 800	600 / 800
1200	-	-	400 / 600	400 / 600

Enclosure equipped with 19" fixed rack, available depths

Height	Width			
	300	400	600	800
2200	-	-	-	800
2000	-	-	-	-
1600	-	-	-	800
1400	-	-	-	-
1200	-	-	-	-

SF enclosures for seismic risks Compatibility of accessories

Accessories		SF 6G compatibility	PrismaSet HD 5G compatibility (PrismaSet system)	Comments
Trade references impacted	Description			
NSYSDT●	Folding mounting shelf	Please contact us	Compatible	Depends on size
NSYSDP●M	Metal document holder	Please contact us	Compatible	Depends on size
NSYDPA●●	Plastic document holder	Compatible	Compatible	-
NSYMP●●●	Mounting plate	Compatible	-	Position 200 mm mini from the rear panel
NSYSUCR●●	Universal cross-rail	Compatible	-	-
NSYSQCR●●	Quick cross-rail	Compatible	-	-
NSYSICR●●	Integrated cross-rail	Compatible	-	-
NSYHLCR●●	Cross-rail for heavy loads	Compatible	-	-
NSYSLCR●●	Light cross-rail	Compatible	-	-
NSYFXT●●●●	Fixed Trays	Compatible	-	-
NSYSPMP●	Partial plain mounting plate	Compatible	-	-
NSYSTMP●●	Telequick mounting plate	Compatible	-	-
NSYSDCR●●	Door cable-guide cross-rail	Compatible	Compatible	Select the smaller-sized cross-rail

11

Spacial SF 6G for seismic risks

Cut-outs

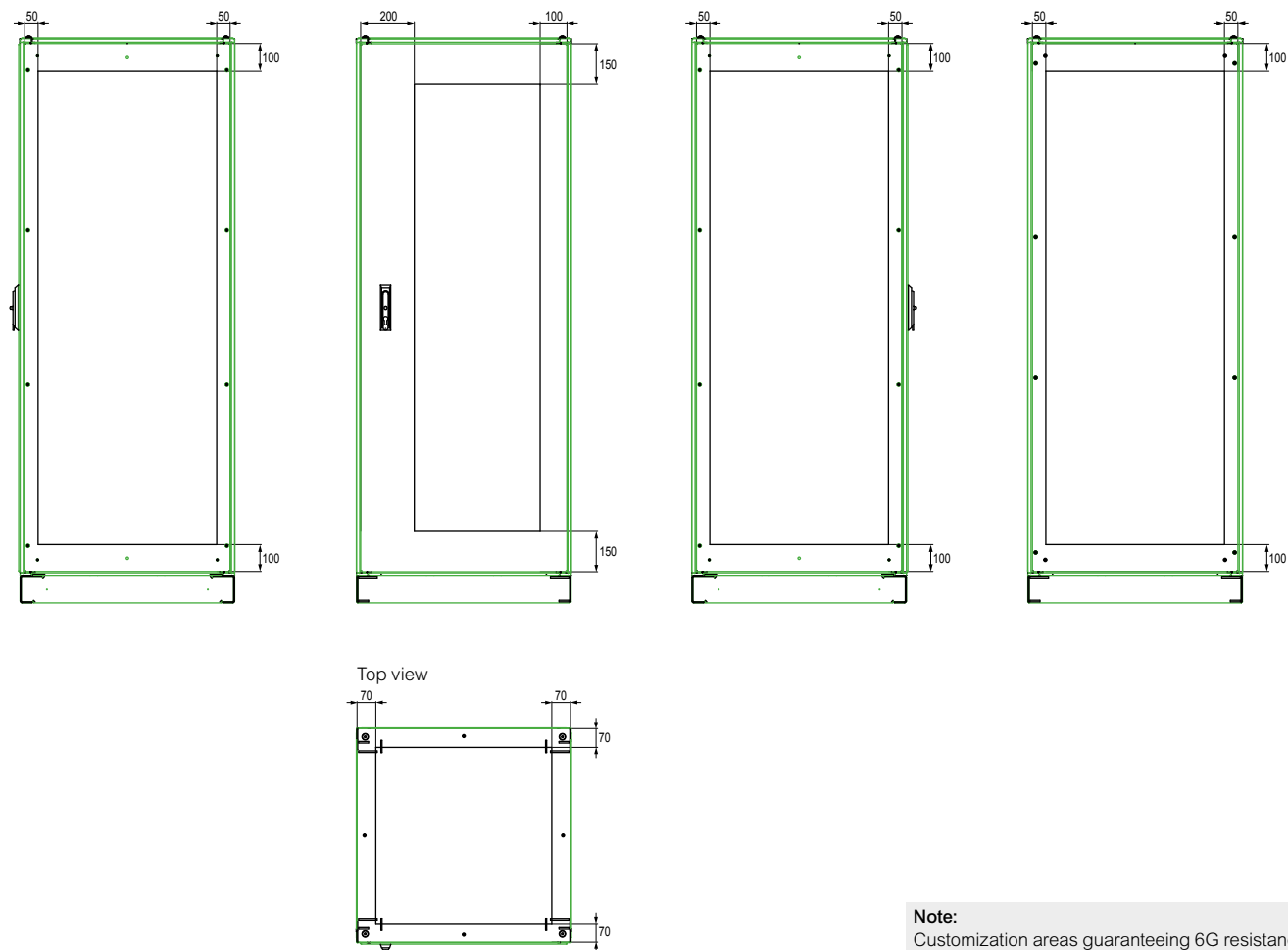

Note:
Customization areas guaranteeing 6G resistance

Spacial S3D 6G enclosures are designed to withstand earthquakes up to UBC zone 4.



11



Strength

Panel thickness:

- Casing + door: 20/10 mm;
- Entry flange: 15/10 mm.

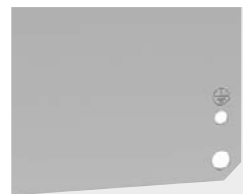

Reinforced mounting plate

- Mounting plate reinforcement.
- Increased number of attachment points.



Security locking system

- EDF 1600 security locking system with captive key.



Wall-mounted

- Reinforced bracket for wall-mounted.

Spacial S3D 6G solutions for seismic risks

- Seismic applications up to UBC zone 4.
- Material: Steel
- Ingress protection rating: IP65 according to IEC 60529
- Mechanical protection rating: IK10 according to IEC 62262
- Maximum load: 80 kg/m² on plain mounting plate, 250 kg on 19" fixed uprights
- Standards: IEC 62208 (enclosure) - IEC 60068-3-3 (seismic methods to apply for materials)
- Certifications: 6G certification as per CRT 91-C-112-00 (EDF)

Supply:

Body

- Monobloc casing (cross structure). Gutter-shaped front profile. Flat back
- M6 x 16 earthing screws and earth strap for equipotential connection between the enclosure door and casing
- Entry flange
- Maximum load: 10 kg

Door

- Plain door with EDF 1600 captive key lock
 - H < 600: 1 fastening point
 - H ≥ 600: 3 fastening points
- Non-reversible door (for reversibility, please contact us)
- M6 x 16 earthing screws and earth strap for equipotential connection between the enclosure door and casing
- 120° door opening
- Maximum load: 10 kg

Mounting plate

- Mounting plate galvanized before mounting
- Maximum load: 80 kg/m²
- Two wall-mounted brackets



NSYS3D6G32515P

Characteristics	Height (mm)	Width (mm)	Depth (mm)	References
Spacial S3D seismic plain door with mount.plate	300	250	150	NSYS3D6G32515P
Spacial S3D seismic plain door with mount.plate	400	300	200	NSYS3D6G4320P
Spacial S3D seismic plain door with mount.plate	600	500	250	NSYS3D6G6525P
Spacial S3D seismic plain door with mount.plate	700	500	250	NSYS3D6G7525P
Spacial S3D seismic plain door with mount.plate	800	600	300	NSYS3D6G8630P
Spacial S3D seismic plain door with mount.plate	1200	800	400	NSYS3D6G12840P

Locks for enclosure

- ≤ H 600
- With captive key.
- Material: Zamak lock and metal cam

Supply:

- 1- or 3-point lock with 1 lock button and 1 cremone screw



NSYAEDLEDF9K31

Characteristics	Key lock	References
Lock for enclosure	EDF 900	NSYAEDLEDF9K31
Lock for enclosure	EDF 1300	NSYAEDLEDF13K31
Lock for enclosure	EDF 1400	NSYAEDLEDF14K31
Lock for enclosure	1242E	NSYAEDL1242K31
Lock for enclosure	405E	NSYAEDL405K31
Lock for enclosure	455E	NSYAEDL455K31

Locks for enclosure

- > H 600
- With captive key.
- Material: Polyamide handle, metal connecting rods and cam

Supply:

- 3-point lock with 1 lock button and 1 cremone screw



NSYAEDLEDF9K33

Characteristics	Key lock	References
Lock for enclosure	EDF 900	NSYAEDLEDF9K33
Lock for enclosure	EDF 1300	NSYAEDLEDF13K33
Lock for enclosure	EDF 1400	NSYAEDLEDF14K33
Lock for enclosure	1242E	NSYAEDL1242K33
Lock for enclosure	405E	NSYAEDL405K33
Lock for enclosure	455E	NSYAEDL455K33

Padlocking lug

- Securing of enclosure access.
- Material: White galvanized steel



NSYAEDLPADS3DK3

Characteristics	References
Padlocking lug	NSYAEDLPADS3DK3

Local seismic standards: Conformity with acceleration severity levels, not considered other aspects

Standards	Specifications
EDF book of technical rules CRT 91C11200	Large equipment" MRI RRS: Horizontal: <ul style="list-style-type: none"> Floor acceleration = 2 g Amplified max. acceleration at center of gravity = 5 g Vertical: <ul style="list-style-type: none"> Floor acceleration = 2.4 g Amplified max. acceleration at center of gravity = 6 g
EAK 2000 Greece	Seismic risk zone: IV Importance category: S4
ENDESA 1986	All seismic categories Ground acceleration = 0.5 g
RPA 99 2003 Algeria	All types of soil class Ground acceleration factor A = 0.36 Behavior factor R = 2 Quality factor Q = 1.35
Turkish Seismic Code 2009	All types of site class Importance factor = 1.5 Ground acceleration factor: A0 = 0.4
GOST 17516.1-90 Russia	Civil market: MSK intensity 9, level 3.
Eurocode 8	All soil types agR = 3 m/s ² Importance factor = 1.3

Table of Compatibility of accessories in 6G seismic S3D enclosures

Accessories		Compatibility	Comments	Trade references impacted
	19" rack	Limited	Conditions: Drilling by customization department to be provided for	NSYVDM●●●●
	Door switch	Limited	Conditions: Drilling by customization department to be provided for	NSYINLCRN
	Diagram holder	Yes	-	NSYDPA●●
	Lifting rings	Limited	Conditions: Drilling by customization department to be provided for	NSYAELYTCRG8

Comment: None of the accessories is certified 6G.

The **Spacial S3D 6G K3** enclosure meets K3 requirements in accordance with RCCE 2012.



11



Strength

Panel thickness:

- Casing + door: 20/10 mm;
- Entry flange: 15/10 mm.

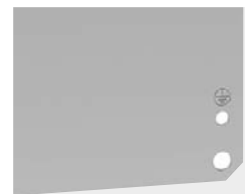

Reinforced mounting plate

- Mounting plate reinforcement.
- Increased number of attachment points.



Decontaminable smooth paint, PID 100 series

- In compliance with CCTR 91.C.031.06
Two coats of paint
(minimum thickness: 60 μ).
- Epoxy polyester powder, PID 100 series.
- PIA-PIC 100 on request.



Earth continuity

- Earth continuity between the interior and exterior of the enclosure is provided by 2 opposite welded studs (external earth screw principle).



Security locking system

- EDF 1600 security locking system with captive key.



Wall-mounted

- Reinforced bracket for wall-mounted.

Technical changes reserved. Information provided without guarantee. Images are for illustrative purposes only.

Spacial S3D 6G K3 solutions for nuclear applications

Seismic application for nuclear power station.

- Material: Steel
- Ingress protection rating: IP65 according to IEC 60529
- Mechanical protection rating: IK10 according to IEC 62262
- Standards: IEC 62208 - IEC 60068-3-3 (seismic methods to apply for materials)
- Certifications: 6G certification as per CRT 91-C-112-00 (EDF)
- Meets K3 requirements in accordance with RCCE 2012
- EDF reference documents:
 - CCTR paint and FNP file;
 - RCC-E: Electrical equipment construction code;
 - Packaging technical specification;
 - "PMUC" (products and materials used in nuclear generating stations)



NSYS3D32515PK3

Characteristics	Height (mm)	Width (mm)	Depth (mm)	References
Spacial S3D seismic plain door with mount.plate	300	250	150	NSYS3D32515PK3
Spacial S3D seismic plain door with mount.plate	400	300	200	NSYS3D4320PK3
Spacial S3D seismic plain door with mount.plate	600	500	250	NSYS3D6525PK3
Spacial S3D seismic plain door with mount.plate	700	500	250	NSYS3D7525PK3
Spacial S3D seismic plain door with mount.plate	800	600	300	NSYS3D8630PK3
Spacial S3D seismic plain door with mount.plate	1200	800	400	NSYS3D12840PK3

Supply:

Body

- Monobloc casing (cross structure). Gutter-shaped front profile. Flat back
- M6 x 16 earthing screws and earth strap for equipotential connection between the enclosure door and casing
- Entry flange
- Maximum load: 10 kg

Door

- Plain door with EDF 1600 captive key lock
 - H < 600: 1 fastening point
 - H ≥ 600: 3 fastening points
- Non-reversible door (for reversibility, please contact us)
- M6 x 16 earthing screws and earth strap for equipotential connection between the enclosure door and casing
- 120° door opening
- Maximum load: 10 kg

Mounting plate

- Mounting plate galvanized before mounting
- Maximum load: 80 kg/m²
- Two wall-mounted brackets

Locks for enclosure

- ≤ H 600
- With captive key.
- Material: Zamak lock and metal cam



NSYAEDLEDF9K31

Supply:

- 1- or 3-point lock with 1 lock button and 1 cremone screw

Characteristics	Key lock	References
Lock for enclosure	EDF 900	NSYAEDLEDF9K31
Lock for enclosure	EDF 1300	NSYAEDLEDF13K31
Lock for enclosure	EDF 1400	NSYAEDLEDF14K31
Lock for enclosure	1242E	NSYAEDL1242K31
Lock for enclosure	405E	NSYAEDL405K31
Lock for enclosure	455E	NSYAEDL455K31

Locks for enclosure

- > H 600
- With captive key.
- Material: Polyamide handle, metal connecting rods and cam



NSYAEDLEDF9K33

Supply:

- 3-point lock with 1 lock button and 1 cremone screw

Characteristics	Key lock	References
Lock for enclosure	EDF 900	NSYAEDLEDF9K33
Lock for enclosure	EDF 1300	NSYAEDLEDF13K33
Lock for enclosure	EDF 1400	NSYAEDLEDF14K33
Lock for enclosure	1242E	NSYAEDL1242K33
Lock for enclosure	405E	NSYAEDL405K33
Lock for enclosure	455E	NSYAEDL455K33

Padlocking lug

- Securing of enclosure access.
- Material: White galvanized steel



NSYAEDLPADS3DK3

Characteristics	References
Padlocking lug	NSYAEDLPADS3DK3

Table of Compatibility of accessories in 6G seismic S3D enclosures

Accessories		Compatibility	Comments	Trade references impacted
	19" rack	Limited	Conditions: Drilling by customization department to be provided for	NSYVDM●●●●
	Door switch	Limited	Conditions: Drilling by customization department to be provided for	NSYINLCRN
	Diagram holder	Yes	-	NSYDPA●●
	Lifting rings	Limited	Conditions: Drilling by customization department to be provided for	NSYAELYTCR8

Comment: None of the accessories is certified 6G.

Special dimensions

Height	Width					
	250	300	400	500	600	800
1200	-	-	-	-	200/250/300/400	200/250/300/400
1000	-	-	-	-	200/250/300/400	200/250/300/400
800	-	-	200/250/300	200/250/300	200/250/400	200/250/300
700	-	-	200/250/300	200/300	200/250/300/400	-
600	-	-	200/250/300	200/300	200/250/300/400	-
500	200	150/200/250	200/250/300	200/250/300	-	-
400	150/200	150/250	-	-	-	-
300	150/200	150/200/250	-	-	-	-

Note:

We meet the K3 requirements as per RCCE 2012 for the special dimensions mentioned below. These dimensions appear in the Reference File.

Cut-outs

Customization areas ensuring K3 certification

Door

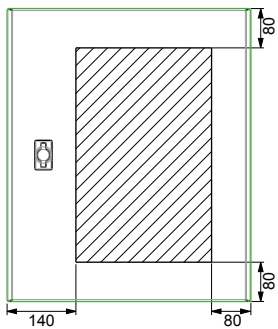

Entry flange

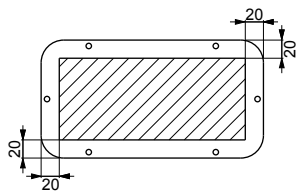

Casing

Hinge side view

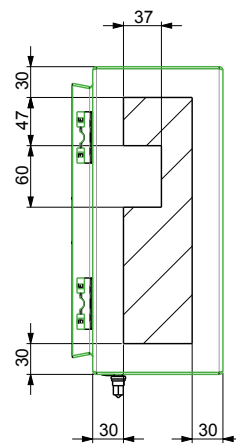

Bottom view

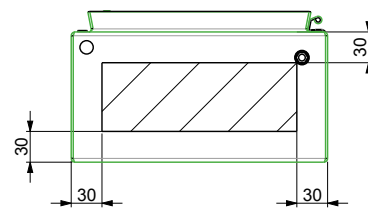

Closing lock side view

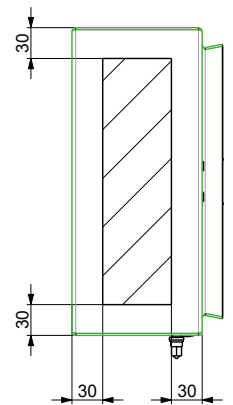

Top view

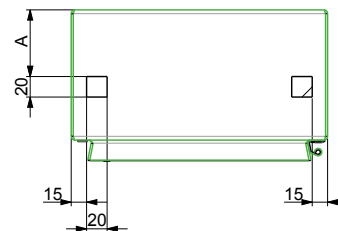

Depth	A
150	65
200	82
250	98
300	115
400	148

Note:

We meet the K3 requirements as per RCCE 2012 for the cut-outs mentioned below. These cut-outs appear in the Reference File.

Paints

AFNOR / RAL	Colors of PIA-PID 100 series	Colors of PIC 100 series
AFNOR	1550	1550
AFNOR	1570	1570
AFNOR	2550	2550
AFNOR	2570	2570
RAL	1003	1003
RAL	5005	5005
RAL	5024	5024
RAL	7036	7036

Note:

Referencing of the following paints in the FNP (national paint file):
Others colors available: Consult us.

Packaging



Note:

We can produce a special corrosion protection packaging (Gardac type).

S3D

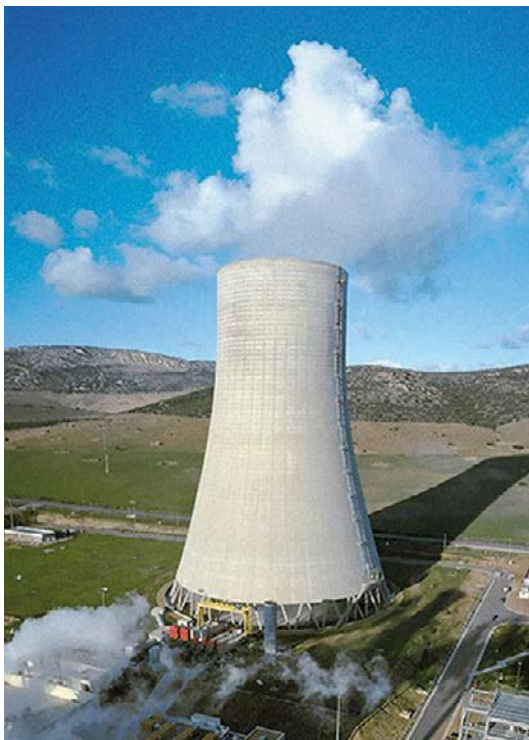

Our range of Spacial 3D nuclear enclosures meets the K3 requirements of RCCE 2012. The Schneider Electric enclosure production plant has established processes to ensure K3 certification.

Establishment of a line architecture adapted to the requirements mentioned in RCCE 2012, implying:

- Hold points;
- Check points;
- Control of "AIP" activities that are important for protection

Manufacturing completion report with:

- Declaration of conformity.
- Monitoring document.
- Report and test report.

Establishment of a Particular Quality Assurance Plan (PQAP)

Reference documents for the nuclear industry:

- RCC-E, CCTR, FNP, packaging technical specification, "PMUC" (products and materials used in nuclear generating stations), SGAQ-2013-03, Arrêté INB 2012

S3D

Nuclear safety has 3 objectives

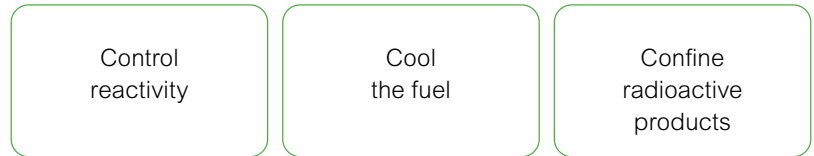

Technical choices and safety rules

The technical choices and safety rules are stipulated by the operator with full responsibility relative to the French nuclear safety authority (ASN) (representing the state) depending on the location in the installation and whether or not they form part of the safety circuits. The products undergo tests to ensure their operation in accidental conditions.

Nuclear island Conventional island

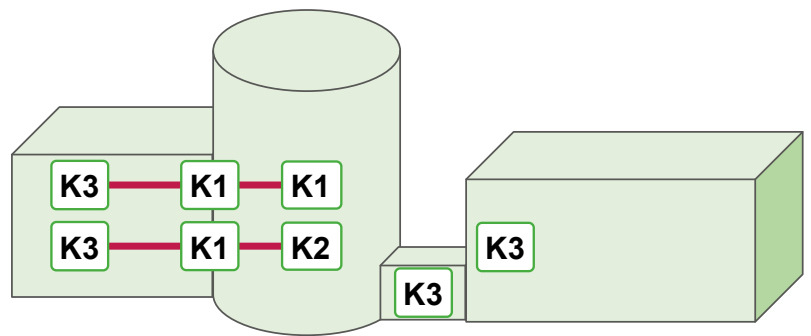

A safety circuit consists of several equipment items. Their certification depends on their location. Equipment interfacing between the core and the other buildings is always K1 (risk of radioactive leakage).

Certifications necessary to work in the nuclear industry

2 certifications are necessary to work in the nuclear industry

- 1• Product and equipment certifications imply demanding performances validated by technical documents and by tests. In the event of a change in the product, it must be explained and justified that the initial certification is maintained.
- 2• Certifications of industrial organizations and services related to products and equipment.

The products equipping French nuclear facilities in this catalog comply with the RCC-E 2012 standard.

Terminology of equipment classifications used in nuclear power stations

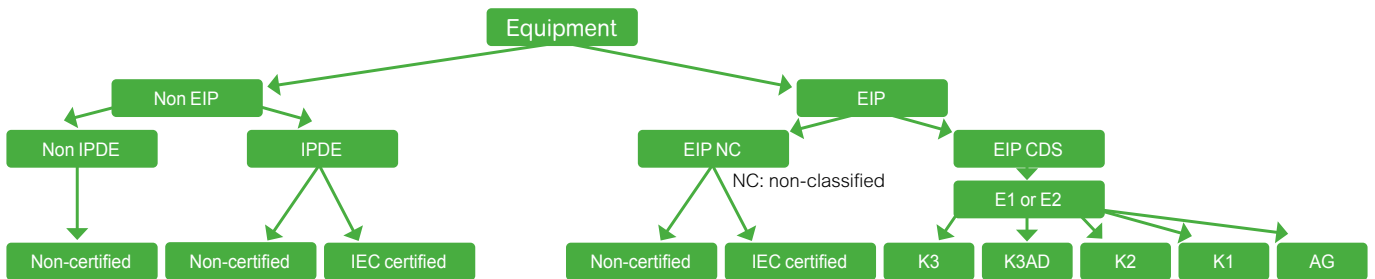

EIP: Equipment Important for Protection.
 IPDE: Important for operating availability.
 CDS: Safety-classified.
 Schneider is concerned only by E1 (elec. classification).

Tests corresponding to specific classifications for EIP equipment

- K3 > ref. tests + functional operating limits + ageing + earthquake
- K3AD > K3 + environmental resistance (irradiation, heat, spraying)
- K2 > K3 + resistance to ageing irradiation (250 Kgy)
- K1 > K2 + resistance to accidental irradiation (600 Kgy) + ADR
- AG > K1 reinforced only for EPR power stations

This range can be configured according to your needs

4 differents services available



Assemble to order



Mounting of standard accessories



Painting



Machining

Spacial VDM



Spacial SF

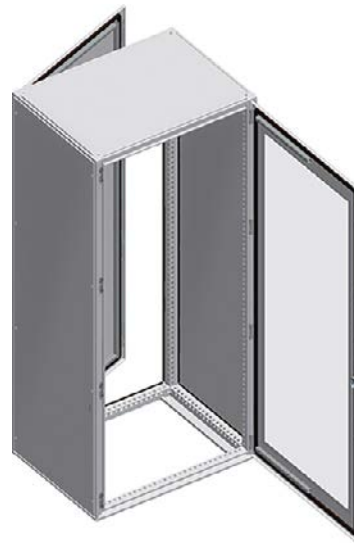

Spacial S3D



11



Practical

- Cable gland plates at top and bottom:
- On the rear part (2-body enclosure),
- On the body (1-body enclosure).

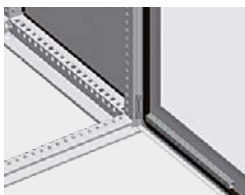

Suitable metal enclosure

- Enclosure prepared for the installation of standard 19" racks in professional telecommunication, voice, data and electronic facilities, by means of 19" fixed and swing racks, see [page 478](#).



Simplified installation

- Pre-installed fixed or swing rack; Earth connection placed between the door and the body; The enclosure is ready to use; The cardboard packaging can be reused after cabling.

See [page 546](#) for details or consult our web site www.se.com

Spacial VDM 19"

- Single-piece body, folded and welded.
Front rail with double sheet thickness, gutter-shaped.
- Perforated rails on the door, with drill holes of Ø 4.2 mm in steps of 25 mm.
- Transparent door, Securit® glass, easily removable and reversible, with 20 mm return with double thickness granting excellent rigidity, opening to 120°, equipped with 2 or 3 invisible hinges. Three locking system points for heights of more than 600 mm.
- Polyurethane gasket.
- 6-mm² earth connection between door and body of the enclosure.
- Material: Steel
- Finish: Structured finish, epoxi-polyester powder
- Color: RAL 7035 grey
- Ingress protection rating: IP66 according to IEC 60529 (only single-body enclosures)
- Mechanical protection rating: IK08 according to IEC 62262
- Rated 4, 4X and 13 according to UL50E (only single-body enclosures)

Supply:

Wall-mounted enclosure supplied with 3-mm double-bar lock as standard

Fixed rack



NSYVDM5U4F

- Maximum load: 3 kg per unit

Characteristics	Number of U	Height (mm)	Width (mm)	Depth (mm)	References
Fixed rack, 1-body	5	300	600	400	NSYVDM5U4F
Fixed rack, 1-body	8	400	600	400	NSYVDM8U4F
Fixed rack, 1-body	10	500	600	400	NSYVDM10U4F
Fixed rack, 1-body	14	700	600	400	NSYVDM14U4F
Fixed rack, 1-body	17	800	600	400	NSYVDM17U4F

Swing rack



NSYVDM4U4P

- Maximum load: 3 kg per unit

Characteristics	Number of U	Height (mm)	Width (mm)	Depth (mm)	References
Swing rack, 1-body	4	300	600	400	NSYVDM4U4P
Swing rack, 1-body	7	400	600	400	NSYVDM7U4P
Swing rack, 1-body	9	500	600	400	NSYVDM9U4P
Swing rack, 1-body	13	700	600	400	NSYVDM13U4P
Swing rack, 1-body	16	800	600	400	NSYVDM16U4P

Other characteristics:

- Enclosure in 2 pieces: Body + door
- Cable gland plate at the bottom of the enclosure
- Fixed rack depth-adjustable in steps of 25 mm using the step slides

Fixed rack



NSYVD2M5U4

- Maximum load: 2 kg per unit

Characteristics	Number of U	Height (mm)	Width (mm)	Depth (mm)	References
Fixed rack, 2-bodies	5	300	600	380	NSYVD2M5U4
Fixed rack, 2-bodies	5	300	600	480	NSYVD2M5U5
Fixed rack, 2-bodies	8	400	600	380	NSYVD2M8U4
Fixed rack, 2-bodies	8	400	600	480	NSYVD2M8U5
Fixed rack, 2-bodies	10	500	600	380	NSYVD2M10U4
Fixed rack, 2-bodies	10	500	600	480	NSYVD2M10U5
Fixed rack, 2-bodies	14	700	600	380	NSYVD2M14U4
Fixed rack, 2-bodies	14	700	600	480	NSYVD2M14U5
Fixed rack, 2-bodies	17	800	600	380	NSYVD2M17U4
Fixed rack, 2-bodies	17	800	600	480	NSYVD2M17U5

Other characteristics:

Rear

- Depth: 150 mm
- Internal attachment point for fixing various supports
- Hinges and locking system
- Cable gland plate at the top and bottom on the rear part

Body

- Usable depth of 183 or 283 mm
- Two 19" uprights made from steel, installed 65 mm back from the front panel
- Intermediate body installed on the rear with 120° hinge

Spacial S3D empty enclosure

- Single-piece body (cross-shaped structure). Gutter-shaped front profile with double fold. Flat rear.
- Cable gland plate with marking for easy drilling and to guarantee the maximum access surface; Delivered with the enclosure. This plate is flush with the body of the enclosure.
- Glazed door, 4 mm-thick Securit® glass, easily removable and reversible, with 20 mm return with double thickness granting excellent rigidity, opening to 120°, equipped with 2 or 3 invisible hinges (From the height of 800 mm).
- Material: Steel
- Finish: Structured finish, epoxy polyester powder
- Color: RAL 7035 grey
- Ingress protection rating according to IEC 60529: IP66 for the single-door enclosures, IP55 for the double-door enclosures
- Mechanical protection rating according to IEC 62262: IK10 for the plain-door enclosures, IK08 for the glazed-door enclosures
- Maximum load: 50 kg/m²
- Fixing: Direct wall-mounted (4 Ø 10 holes for the sealing plugs guaranteeing the IP) or with the help of fixing lugs installed from the outside (to be ordered separately, see [page 76](#))
- Other characteristics: For heights from 600 mm, three locking points with linkage, with a single control point. Simple reversal of linkage

Delivery includes a handle with two functions:

- Operating key
- Tool for loosening the stud protection caps.

This handle can be solidly attached to the locking system by means of a captive element.

Perforated rails on the door, with drill holes with a diameter of 4.2 mm in steps of 25 mm:

- 2 vertical rails from the height of 400 mm
- 2 vertical rails and 2 horizontal rails from the width of 800 mm

Note:

Door opening to 180° with optional hinges ([page 88](#))

Supply:

Wall-mounted enclosure supplied with 3-mm double-bar lock as standard

Glazed door



NSYS3D4620T

Characteristics	Fixed rack	Swing rack	Height (mm)	Width (mm)	Depth (mm)	References
Glazed door	NSYVDM8UF	NSYVDM7UP	400	600	200	NSYS3D4620T
Glazed door	NSYVDM8UF	NSYVDM7UP	400	600	250	NSYS3D4625T
Glazed door	NSYVDM12UF	NSYVDM11UP	600	600	200	NSYS3D6620T
Glazed door	NSYVDM12UF	NSYVDM11UP	600	600	250	NSYS3D6625T
Glazed door	NSYVDM12UF	NSYVDM11UP	600	600	300	NSYS3D6630T
Glazed door	NSYVDM12UF	NSYVDM11UP	600	600	400	NSYS3D6640T
Glazed door	NSYVDM17UF	NSYVDM16UP	800	600	200	NSYS3D8620T
Glazed door	NSYVDM17UF	NSYVDM16UP	800	600	250	NSYS3D8625T
Glazed door	NSYVDM17UF	NSYVDM16UP	800	600	300	NSYS3D8630T
Glazed door	NSYVDM17UF	NSYVDM16UP	800	600	400	NSYS3D8640T
Glazed door	NSYVDM21UF	NSYVDM20UP	1000	600	250	NSYS3D10625T
Glazed door	-	-	1000	600	300	NSYS3D10630T
Glazed door	NSYVDM21UF	NSYVDM20UP	1000	600	400	NSYS3D10640T
Glazed door	-	NSYVDM20U8P	1000	800	250	NSYS3D10825T
Glazed door	-	NSYVDM20U8P	1000	800	300	NSYS3D10830T
Glazed door	-	NSYVDM20U8P	1000	800	400	NSYS3D10840T
Glazed door	-	NSYVDM25U8P	1200	800	300	NSYS3D12830T
Glazed door	-	NSYVDM25U8P	1200	800	400	NSYS3D12840T

11

Plain door



NSYS3D4620

Characteristics	Fixed rack	Swing rack	Height (mm)	Width (mm)	Depth (mm)	References
Plain door	NSYVDM8UF	NSYVDM7UP	400	600	200	NSYS3D4620
Plain door	NSYVDM8UF	NSYVDM7UP	400	600	250	NSYS3D4625
Plain door	NSYVDM12UF	NSYVDM11UP	600	600	200	NSYS3D6620
Plain door	NSYVDM12UF	NSYVDM11UP	600	600	250	NSYS3D6625
Plain door	NSYVDM12UF	NSYVDM11UP	600	600	300	NSYS3D6630
Plain door	NSYVDM12UF	NSYVDM11UP	600	600	400	NSYS3D6640
Plain door	NSYVDM17UF	NSYVDM16UP	800	600	200	NSYS3D8620
Plain door	NSYVDM17UF	NSYVDM16UP	800	600	250	NSYS3D8625
Plain door	NSYVDM17UF	NSYVDM16UP	800	600	300	NSYS3D8630
Plain door	NSYVDM17UF	NSYVDM16UP	800	600	400	NSYS3D8640
Plain door	NSYVDM21UF	NSYVDM20UP	1000	600	250	NSYS3D10625
Plain door	-	-	1000	600	300	NSYS3D10630
Plain door	NSYVDM21UF	NSYVDM20UP	1000	600	400	NSYS3D10640
Plain door	-	NSYVDM20U8P	1000	800	250	NSYS3D10825
Plain door	-	NSYVDM20U8P	1000	800	300	NSYS3D10830
Plain door	-	NSYVDM20U8P	1000	800	400	NSYS3D10840
Plain door	-	NSYVDM25U8P	1200	800	300	NSYS3D12830
Plain door	-	NSYVDM25U8P	1200	800	400	NSYS3D12840

Spacial S3D Fixed rack (Racks to be ordered separately)

- 19" fixed chassis composed by 2 19" uprights with fixing hardware.
- Thickness: 20/10° mm.
- Material: Galvanized steel
- Maximum load: 3 kg per unit

Note:

Adjustable in depth by fixing on the step slides in accessories (see [page 76](#)).



NSYVDM8UF

Characteristics	Number of U	Height (mm)	Width (mm)	Depth (mm)	References
Fixed rack	8	400	600	200	NSYVDM8UF
Fixed rack	8	400	600	250	NSYVDM8UF
Fixed rack	12	600	600	200	NSYVDM12UF
Fixed rack	12	600	600	250	NSYVDM12UF
Fixed rack	12	600	600	300	NSYVDM12UF
Fixed rack	12	600	600	400	NSYVDM12UF
Fixed rack	17	800	600	200	NSYVDM17UF
Fixed rack	17	800	600	250	NSYVDM17UF
Fixed rack	17	800	600	300	NSYVDM17UF
Fixed rack	17	800	600	400	NSYVDM17UF
Fixed rack	21	1000	600	250	NSYVDM21UF
Fixed rack	21	1000	600	400	NSYVDM21UF

Spacial S3D Swing rack (Racks to be ordered separately)

- 19" swing chassis opening to 120° with locking system by 3-mm double-bar insert.
- Material: Steel
- Finish: Epoxy polyester powder
- Color: RAL 7035 grey
- Maximum load: 3 kg per unit



NSYVDM7UP

Characteristics	Number of U	Height (mm)	Width (mm)	Depth (mm)	References
Swing rack	7	400	600	200	NSYVDM7UP
Swing rack	7	400	600	250	NSYVDM7UP
Swing rack	11	600	600	200	NSYVDM11UP
Swing rack	11	600	600	250	NSYVDM11UP
Swing rack	11	600	600	300	NSYVDM11UP
Swing rack	11	600	600	400	NSYVDM11UP
Swing rack	16	800	600	200	NSYVDM16UP
Swing rack	16	800	600	250	NSYVDM16UP
Swing rack	16	800	600	300	NSYVDM16UP
Swing rack	16	800	600	400	NSYVDM16UP
Swing rack	20	1000	600	250	NSYVDM20UP
Swing rack	20	1000	600	400	NSYVDM20UP
Swing rack	20	1000	800	250	NSYVDM20U8P
Swing rack	20	1000	800	300	NSYVDM20U8P
Swing rack	20	1000	800	400	NSYVDM20U8P
Swing rack	25	1200	800	300	NSYVDM25U8P
Swing rack	25	1200	800	400	NSYVDM25U8P

Spacial SF 19" electronic enclosure

- Structure: Top and bottom frame and vertical uprights.
- Transparent front door with Securit® glass.
- Plain rear door.
- Standard locking system with handle and 5-mm double-bar insert.
- Removable roof.
- External fixing of double-folded side panels to increase rigidity, captive fixing screws that reduce installation time.
- In enclosures with widths of 600 and 800 mm, it is possible to install fixed or swing racks, to be ordered separately.
- Material: Steel
- Finish: Structured finish, epoxy polyester powder
- Color: RAL 7035 grey
- Certifications: UL (cULus) Rated type 1 and 12 according to UL50E

For more details see [page 486](#)



NSYSF12660E

Characteristics	Height (mm)	Width (mm)	Depth (mm)	References
Spacial SF 19" electronic enclosur	1200	600	600	NSYSF12660E
Spacial SF 19" electronic enclosur	1200	600	800	NSYSF12680E
Spacial SF 19" electronic enclosur	1200	800	600	NSYSF12860E
Spacial SF 19" electronic enclosur	1200	800	800	NSYSF12880E
Spacial SF 19" electronic enclosur	2000	600	600	NSYSF20660E
Spacial SF 19" electronic enclosur	2000	600	800	NSYSF20680E
Spacial SF 19" electronic enclosur	2000	800	600	NSYSF20860E
Spacial SF 19" electronic enclosur	2000	800	800	NSYSF20880E
Spacial SF 19" electronic enclosur	2000	800	1000	NSYSF208100E
Spacial SF 19" electronic enclosur	2200	600	600	NSYSF22660E
Spacial SF 19" electronic enclosur	2200	600	800	NSYSF22680E
Spacial SF 19" electronic enclosur	2200	600	1000	NSYSF226100E
Spacial SF 19" electronic enclosur	2200	800	600	NSYSF22860E
Spacial SF 19" electronic enclosur	2200	800	800	NSYSF22880E
Spacial SF 19" electronic enclosur	2200	800	1000	NSYSF228100E

Single ventilated door for 19" racks

- Door designed to achieve natural airing of the enclosure.
- Installation on enclosures with a width of 800 mm, equipped with centered fixed or swing racks. Opening of 120°.
- Standard locking system with handle and 5-mm double-bar insert.
- Material: Steel
- Finish: Structured finish, epoxy polyester powder
- Color: RAL 7035 grey

Supply:
1 ventilated door for racks



NSYPCVD126

Characteristics	Height (mm)	Width (mm)	References
Single ventilated door	1200	600	NSYPCVD126
Single ventilated door	1200	800	NSYPCVD128
Single ventilated door	1400	800	NSYPCVD148
Single ventilated door	1600	800	NSYPCVD168
Single ventilated door	1800	800	NSYPCVD188
Single ventilated door	2000	600	NSYPCVD206
Single ventilated door	2000	800	NSYPCVD208
Single ventilated door	2200	600	NSYPCVD226
Single ventilated door	2200	800	NSYPCVD228

Front and rear plinths

- The front and rear of the plinth consists of 4 corners with 2 or 4 panels.
- Material: Folded sheet steel, corner with a thickness of 25/10° mm
- Finish: Epoxy polyester paint
- Color: RAL 7022 grey
- Ingress protection rating: IP30 according to IEC 60529
- Mechanical protection rating: IK10 according to IEC 62262

Note:

For more information see [page 124](#)

Supply:

Height 100 mm: 4 corners, 2 panels (front and rear), 4 corner covers and fixing elements. Height 200 mm: 4 corners, 4 panels (2 front and 2 rear), 4 corner covers and fixing elements



Characteristics	Width (mm)	Height (mm)	References
Front plinths for Spacial	600	100	NSYSPF6100
Front plinths for Spacial	800	100	NSYSPF8100
Front plinths for Spacial	600	200	NSYSPF6200
Front plinths for Spacial	800	200	NSYSPF8200

Plinth side panels

- They are fixed to the corner of the plinth by 2 fixing screws.
- Folded sheet steel
- Finish: Epoxy polyester paint
- Color: RAL 7022 grey
- Ingress protection rating: IP30 according to IEC 60529
- Mechanical protection rating: IK10 according to IEC 62262

Supply:

Height 100 mm: 2 side panels, 4 corner covers and fixing elements. Height 200 mm: 4 side panels (height of 100 mm, 2 for each side), 4 corner covers and fixing elements



Characteristics	Depth (mm)	Height (mm)	References
Side plinths for Spacial	600	100	NSYSPS6100
Side plinths for Spacial	800	100	NSYSPS8100
Side plinths for Spacial	1000	100	NSYSPS10100
Side plinths for Spacial	600	100	NSYSPS6100
Side plinths for Spacial	800	100	NSYSPS8100
Side plinths for Spacial	1000	100	NSYSPS10100
Side plinths for Spacial	600	200	NSYSPS6200
Side plinths for Spacial	800	200	NSYSPS8200
Side plinths for Spacial	1000	200	NSYSPF10200
Side plinths for Spacial	600	200	NSYSPS6200
Side plinths for Spacial	800	200	NSYSPS8200
Side plinths for Spacial	1000	200	NSYSPF10200

Ventilated front plinth



NSYSPFV6100

- The front and rear of the ventilated plinth is made up of 4 corners with 2 front panels.
- Material: Folded sheet steel, corner with a thickness of 25/10° mm
- Finish: Structured finish, epoxy polyester powder
- Color: RAL 7022 grey
- Ingress protection rating: IP20 according to IEC 60529
- Mechanical protection rating: IK10 according to IEC 62262

Supply:
Height 100 mm: 4 corners, 2 ventilated panels (front and rear), 4 corner covers and fixing elements

Characteristics	Height (mm)	Width (mm)	References
Ventilated front plinth for Spacial SF-SM	100	600	NSYSPFV6100
Ventilated front plinth for Spacial SF-SM	100	800	NSYSPFV8100

Ventilated side panels

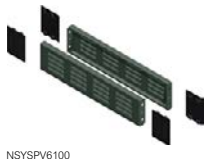

NSYSPV6100

- They are fixed to the corner of the plinth by fixing screws.
- Material: Folded sheet steel
- Finish: Structured finish, epoxy polyester powder
- Color: RAL 7022 grey
- Ingress protection rating: IP20 according to IEC 60529
- Mechanical protection rating: IK10 according to IEC 62262

Supply:
Height 100 mm: 2 ventilated side panels, 4 corner covers and fixing elements

Characteristics	Height (mm)	Depth (mm)	References
Ventilated side panels for Spacial SF-SM	100	600	NSYSPV6100
Ventilated side panels for Spacial SF-SM	100	800	NSYSPV8100

Plain cable gland plate



NSYEC66

- The design of the compact cable gland plate, coupled with the use of the sealing gasket **NSYCEK** enable the maximum dust/water tightness.
- Material: Galvanized steel
- Thicknesses: 15/10° mm

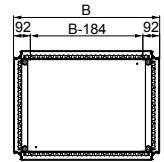

Supply:
Plain plate and fixing elements

Characteristics	(B) Width (mm)	(C) Depth (mm)	References
Spacial SF Plain cable gland plate	600	600	NSYEC66
Spacial SF Plain cable gland plate	600	800	NSYEC68
Spacial SF Plain cable gland plate	600	1000	NSYEC610
Spacial SF Plain cable gland plate	800	600	NSYEC86
Spacial SF Plain cable gland plate	800	800	NSYEC88
Spacial SF Plain cable gland plate	800	1000	NSYEC810

Plate with 1 entry



NSYEC661

- Facilitates the entry of cables thanks to a longitudinal opening.
- Material: Galvanized steel
- Thicknesses: 15/10° mm

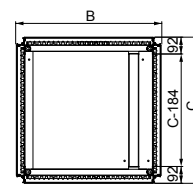

Enclosures of 300 and 400 mm width.

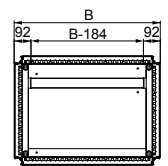

Enclosures of 600, 800, 1000 and 1200 mm width.

Supply:
Plate with 1 entry; Self-extinguishing polyurethane adhesive gasket with cross-section of 15 x 25 mm (guarantees good sealing) and fixing elements

Characteristics	(B) Width (mm)	(C) Depth (mm)	References
Spacial SF Plate with 1 entry	600	600	NSYEC661
Spacial SF Plate with 1 entry	600	800	NSYEC681
Spacial SF Plate with 1 entry	600	1000	NSYEC6101
Spacial SF Plate with 1 entry	800	600	NSYEC861
Spacial SF Plate with 1 entry	800	800	NSYEC881
Spacial SF Plate with 1 entry	800	1000	NSYEC8101

Plate with 2 entries

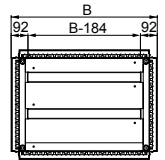

- Cable entry for very deep enclosures (600 and 800 mm).
- Two longitudinal openings allowing a large number of cables through.
- Material: Galvanized steel
- Thicknesses: 15/10^ø mm

Supply:

1 plate with 2 entries; Polyurethane adhesiv gasket with cross-section of 15 x 25 mm (guarantee good sealing) and fixing elements



NSYEC662

Characteristics	(B) Width (mm)	(C) Depth (mm)	References
Spacial SF Plate with 2 entries	600	600	NSYEC662
Spacial SF Plate with 2 entries	600	800	NSYEC682
Spacial SF Plate with 2 entries	600	1000	NSYEC6102
Spacial SF Plate with 2 entries	800	600	NSYEC862
Spacial SF Plate with 2 entries	800	800	NSYEC882
Spacial SF Plate with 2 entries	800	1000	NSYEC8102

Actassi plain plate for roof

- Removable plate made from folded sheet steel, to be installed on roof ref. **NSYSRSYS8•**.
- Option of installing roof elevators for aeration, ref. **NSYEX206**, and cable glands.
- Material: Steel
- Finish: Structured finish, epoxy polyester powder
- Color: RAL 7035 grey

Supply:
1 plain plate and fixing elements



NSYTSPC450

Characteristics	References
Actassi plain plate for roof	NSYTSPC450

Actassi plate with brush gasket for roof

- Removable folded sheet steel plate, equipped with a gasket with cable gland brush, to be installed on roof ref. **NSYSRSYS8•**.
- Optional installation of roof elevators for aeration, ref. **NSYEX206**, and cable gland plates.
- Material: Steel
- Finish: Structured finish, epoxy polyester powder
- Color: RAL 7035 grey

Supply:
1 plate with brush gasket and fixing elements



NSYTSP450

Characteristics	References
Actassi plate with brush gasket for roof	NSYTSP450

Actassi ventilated plate for roof

- Removable plate made from folded sheet steel, to be installed on roof ref. **NSYSRSYS8•**.
- Optional installation of roof elevators for aeration, ref. **NSYEX206**, cable gland plates and fans.
- Material: Steel
- Finish: Structured finish, epoxy polyester powder
- Color: RAL 7035 grey

Supply:
1 ventilated plate and fixing elements



NSYTSPV450

Characteristics	References
Actassi ventilated plate for roof	NSYTSPV450

Roof plate elevators for aeration

- Columns with a height of 20 mm.
- Fixing: Between the roofplate and the roof.

Supply:
100 units. Reference by unit.
Order by multiples of 100 (100, 200, 300...).



NSYEX206

Characteristics	References
Roof plate elevators for aeration	NSYEX206

11

Actassi ventilated support with filter

- Fixing: To be mounted on the cable gland plate with or without fan or on the self-ventilated cable gland plate.
- Color: RAL 9011

Supply:
1 mounting support and filter



NSYFECVT440

Characteristics	References
Actassi ventilated support with filter	NSYFECVT440

Spare filter for Actassi ventilated support

Supply:
5 units



NSYCEFILS

Characteristics	References
Spare filter for Actassi ventilated support	NSYCEFILS

Actassi plain cable gland plate



NSYEC440

- Material: Galvanized steel
- Fixing: Fixing on the outside of the roof and bottom support plate
Can be combined with other types of cable gland plates

For more details see [page 485](#)

Supply:
1 plain cable gland plate and fixing elements

Characteristics	References
Actassi plain cable gland plate	NSYEC440

Actassi cable gland plate with brush



NSYEC440

- Material: Galvanized steel
- Fixing: Fixing on the outside of the roof and bottom support plate
Can be combined with other types of cable gland plates

Supply:
1 cable gland plate with brush and fixing elements

Characteristics	References
Actassi cable gland plate with brush	NSYEC440

Actassi self-ventilated cable gland plate

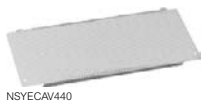

NSYEC4V440

- Material: Galvanized steel
- Fixing: Fixing on the outside of the roof and bottom support plate
Can be combined with other types of cable gland plates

Supply:
1 self-ventilated cable gland plate and fixing elements

Characteristics	References
Actassi self-ventilated cable gland plate	NSYEC4V440

Actassi airing plate with or without fans, symbol diameter before 120 mm



NSYECVT3440

- Fixing: Fixing on the outside of the roof and bottom support plate
Can be combined with other types of cable gland plates
- Other characteristics: Sound level: 34 dB (A)

Supply:
1 cable gland plate with or without fans, 2-m power cord (version with fans) and fixing elements
Versions with 2 or 3 fans: Each of them has an output capacity of 170 m³/h, 220 V-50/60 Hz, installed and wired to a terminal strip. A 2-m power cord is supplied connected

Characteristics	Description	References
Actassi airing plate with or without fans, symbol diameter before 120 mm	No fans, 3 positions	NSYECVT3440
Actassi airing plate with or without fans, symbol diameter before 120 mm	With 3 fans	NSYECVT3V440
Actassi airing plate with or without fans, symbol diameter before 120 mm	No fans, 2 positions	NSYECVT2440
Actassi airing plate with or without fans, symbol diameter before 120 mm	With 2 fans	NSYECVT2V440

Top frame - 3 blanking plates					
Width	Depth	Example 1	Example 2	Example 3	Example 4
600 mm 800 mm	600 mm 800 mm 1000 mm				
Cut-out = 400 x 450 mm		400 mm	400 mm	400 mm	400 mm
Top frame - 2 Blanking plates					
Width	Depth	Example 1	Example 2	Example 3	Example 4
600 mm 800 mm	600 mm				
Cut-out = 400 x 300 mm		400 mm	400 mm	400 mm	400 mm

Ventilated roof

- Roof for providing natural airing for the enclosure, with IP30 protection.
- Height: An extra 63 mm in relation to the structure.
- Material: Steel
- Finish: Structured finish, epoxy polyester powder
- Color: RAL 7035 grey

For more details see [page 485](#)

Supply:
1 ventilated roof and fixing elements



NSYSVR606

Characteristics	Width (mm)	Depth (mm)	References
Spacial SF Ventilated roof	600	600	NSYSVR606
Spacial SF Ventilated roof	600	800	NSYSVR608
Spacial SF Ventilated roof	800	600	NSYSVR806
Spacial SF Ventilated roof	800	800	NSYSVR808

Partial 19" fixed rack

- Rack designed for coupling in enclosures with a width of 600 mm.
- Adjustable depth with a pitch of 25 mm.
- Material: Zinc-coated steel
- Maximum load: 2 kg/U

Installation:

Spacial SF:

- Installation at the top front of the enclosure, no cross-rails needed⁽¹⁾
- Depth adjustment of the partial rack:
two cross-rails need to be installed, see [page 275](#)
- For installation at any other height, four cross-rails are required⁽²⁾

Spacial SM:

- At the front of the enclosure⁽¹⁾: Install two front vertical adaptation profiles, see [page 278](#)
- For depth adjustment⁽²⁾: Install two front vertical adaptation profiles, see [page 278](#) and two rear vertical 40 mm (1 row) cross-rails and four cross-rails, see [page 275](#)

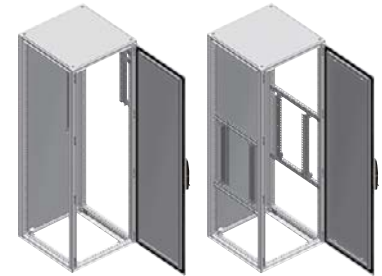

(1)

(2)

Supply:
2 uprights and fixing elements

Characteristics	No. of units	Height (mm)	References
Partial 19" fixed rack	4	200	NSYRCKP4
Partial 19" fixed rack	8	400	NSYRCKP8
Partial 19" fixed rack	12	600	NSYRCKP12
Partial 19" fixed rack	17	800	NSYRCKP17
Partial 19" fixed rack	21	1000	NSYRCKP21
Partial 19" fixed rack	26	1200	NSYRCKP26



NSYRCKP4

19" fixed rack

- Rack designed for installation in enclosures with a width of 600 mm.
- Adjustable depth with a pitch of 25 mm.
- Material: Zinc-coated steel
- Maximum load: 400 kg for 4 uprights
- Maximum load: 200 kg for 2 uprights

Installation:

Spacial SF:

- Direct fixing on the structure of the enclosures:
- For installation on enclosures with a width of 800 mm, use the 19" fixed-rack support brackets,
- To reinforce the rigidity of the uprights in enclosures with a width of 800 mm, it is advisable to use the central fixing kit, for enclosure heights above 1800 mm, ref. [NSYRCK19KIT](#).

Spacial SM:

- Fixing on the top/bottom adjustment rails.

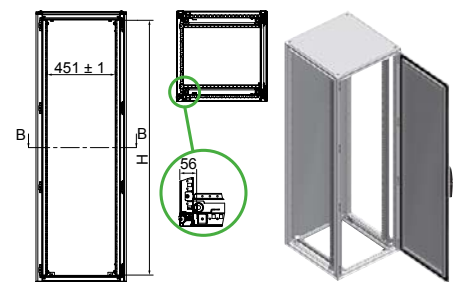

Supply:
2 uprights and fixing elements

Characteristics	No. of units	Height (mm)	References
19" fixed rack	24	1200	NSYRCK24
19" fixed rack	29	1400	NSYRCK29
19" fixed rack	33	1600	NSYRCK33
19" fixed rack	38	1800	NSYRCK38
19" fixed rack	42	2000	NSYRCK42
19" fixed rack	47	2200	NSYRCK47

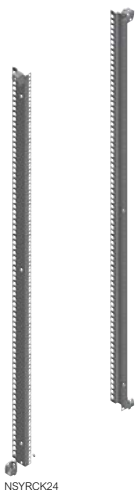

NSYRCK24

Support brackets for 19" fixed rack with a width of 800 mm

- Support brackets for coupling the fixed rack to enclosures with a width of more than 600 mm.
- They allow the depth of the fixed rack to be adjusted with a pitch of 25 mm.
- The fixed sizes are delivered in pairs.
- Material: Zinc-coated steel
- Maximum load: 400 kg



Supply:
4 support brackets and fixing elements



Characteristics	Depth (mm)	References
Support brackets for 19" fixed rack	600	NSYRCKS6
Support brackets for 19" fixed rack	800	NSYRCKS8
Support brackets for 19" fixed rack	1000	NSYRCKS10

Side plates of the centered fixed rack for a width of 800 mm

- Side plates for coupling to the fixed rack in enclosures with a width of 800 mm.
- Direct installation on the rack by screws.
- The fixed sizes are delivered in pairs.
- Material: Steel
- Finish: Structured finish, epoxy polyester powder
- Color: RAL 7035 grey

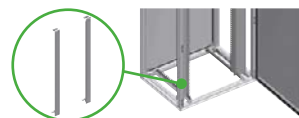

Supply:
2 side plates and fixing elements



Characteristics	Height (mm)	References
Side plates of the centered fixed rack	1200	NSYRC12
Side plates of the centered fixed rack	1400	NSYRC14
Side plates of the centered fixed rack	1600	NSYRC16
Side plates of the centered fixed rack	1800	NSYRC18
Side plates of the centered fixed rack	2000	NSYRC20
Side plates of the centered fixed rack	2200	NSYRC22

Central fixing kit

- To reinforce the rigidity of the 19" fixed racks in enclosures with a width of 800 mm.
- Fixing to the enclosure by cross-rails or light cross-rails installed depthwise. See [page 276](#).
- Material: Zinc-coated steel

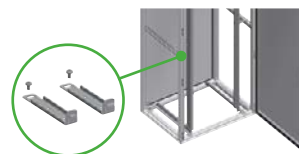

Supply:
2 supports and fixing elements



Characteristics	References
Central fixing kit	NSYRCK19KIT

Partial 19" swing rack for 600 and 800 mm enclosures

- Rack for coupling to enclosures with widths of 600 and 800 mm.
- In enclosures with a width of 800 mm, the rack can be installed centered or off-center.
- Maximum opening: 120°.
- Reversible opening direction: Left/right.
- Locking system, top and bottom, with 5-mm double-bar key.
- The 6 and 9 units racks only with bottom lock.
- Maximum equipment installation depth: 180 mm, in enclosures with a width of 600 mm.
- Material: Zinc-coated steel

Installation:

Spacial SF:

- To install at the front at any height of the enclosure: directly to the framework by rack fixing elements
- For depth adjustment: Install two (for top height) or four (for any height) 65 mm (2 rows) cross-rails, see [page 275](#)

Spacial SM:

- To install at the front at any height of the enclosure: install two front vertical adaptation profiles, see [page 278](#)
- For depth adjustment: Install two front vertical adaptation profiles, see [page 278](#) and two rear vertical 40 mm cross-rails and four 65 mm (2 rows) cross-rails, see [page 275](#)
- Maximum load: 2 kg/U



For more details see [page 486](#)

⁽¹⁾ Optional installation in enclosures with height of 1200 mm.

Supply:

1 partial 19" swing rack



NSYRSWP6

Characteristics	No. of units (H)	Height (mm)	References
Partial 19" swing rack	6	355	NSYRSWP6
Partial 19" swing rack	9	468	NSYRSWP9
Partial 19" swing rack	12	601	NSYRSWP12
Partial 19" swing rack	15	735	NSYRSWP15
Partial 19" swing rack	18	868	NSYRSWP18
Partial 19" swing rack ⁽¹⁾	21	1002	NSYRSWP21

Partial 19" swing rack support for 600 and 800 mm enclosures

- Supports for coupling the partial swing rack to enclosures with widths of 600 and 800 mm.
- Height or depth adjustment, with a pitch of 25 mm, by two 65 mm (2 rows) universal cross-rails and a 19" multiple bracket, ref. **NSYMBR19**.
- Spacial SF: Direct fixing to the structure.
- Spacial SM: Fixing to the enclosure by means of the vertical adaptation profile, see [page 278](#).
- Material: Zinc-coated steel

Installation:

- Installation of the rack in centered or off-center position, for enclosures with a width of 800 mm

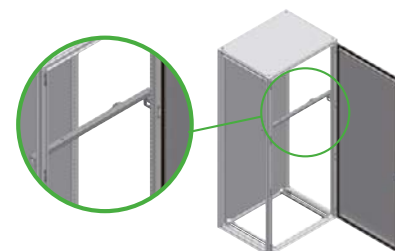

Supply:

2 supports and fixing elements

Characteristics	Width (mm)	References
Partial 19" swing rack support	600	NSYRSWSP6
Partial 19" swing rack support	800	NSYRSWSP8



NSYRSWSP6

19" multiple bracket

- Bracket for fixing 65 mm universal cross-rails (2 rows), depthwise, to position the partial 19" swing rack in any direction, up and down and/or depthwise.
- Material: Zinc-coated steel.

Supply:

4 brackets and fixing elements

Characteristics	Width (mm)	References
19" multiple bracket	600	NSYMBR19



NSYMBR19

19" swing rack for 600 mm enclosures



NSYRSW627

- To be coupled to enclosures with widths of 600 mm.
- Can be moved depthwise with a pitch of 25 mm.
- Reversible opening direction: Left/right.
- Locking system, top and bottom, with 5-mm double-bar key.
- Maximum opening: 130°.
- Maximum equipment installation depth: 180 mm.
- Not compatible with 120° mechanical retainer **NSYRCDR12**

Fixing to the enclosure structure:

Spacial SF:

- Fixing to the enclosure structure.

Spacial SM:

- Fixing to the enclosure on top/bottom adjustment rails.

Components:

- Zinc-coated steel central structure.
- Mounting cross-rail on structure made from steel painted with epoxy polyester resin, textured RAL 7035 grey. Fixed to the central structure by screws.

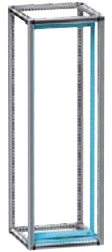

For more details see [page 486](#)

Supply:

1 19" swing rack with no panels

Characteristics	No. of units (H)	Height (mm)	References
19" swing rack	27	1400	NSYRSW627
19" swing rack	31	1600	NSYRSW631
19" swing rack	36	1800	NSYRSW636
19" swing rack	40	2000	NSYRSW640
19" swing rack	45	2200	NSYRSW645

19" swing rack for 800 mm enclosures, off-center



NSYRSW27

- To be coupled to enclosures with widths of 800 mm.
- Can be moved depthwise with a pitch of 25 mm.
- Reversible opening direction: Left/right.
- Locking system, top and bottom, with 5-mm double-bar key.
- Maximum opening: 130° (option of opening to 180° using 180° hinges).
- Material: Zinc-coated steel and steel painted
- Maximum load: 3.75 kg/unit with a max of 150 kg

Installation:

- Spacial SF - SM
- Other mounting options: Consult us

Maximum equipment installation depth:

- Off-center 19" swing rack: 470 mm
- Centered 19" swing rack: 390 mm

Fixing to the enclosure structure:

- Spacial SF: Fixing to the entire height of the enclosure structure.
- Spacial SM: Fixing to the enclosure on top/bottom adjustment rails.

Components:

- Zinc-coated steel central structure.
- Mounting cross-rail on structure made from steel painted with epoxy polyester resin, textured RAL 7035 grey.
- Fixed to the central structure by screws.
- Side plate made from steel painted with epoxy polyester resin, textured RAL 7035 grey. Fixed to the central structure by screws.

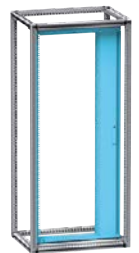

For more details see [page 486](#)

Spare handle:

Order ref. **NSYTEDB5ML** (handle) + **NSYTMME** (blind barrel).

Supply:

Centered and off-center 19" swing rack: hinged rack, 800 mm swing rack supports, side plates with locking system double-bar and fixing elements

Characteristics	No. of units (H)	Height (mm)	References
19" swing rack, off-center	27	1400	NSYRSW27
19" swing rack, off-center	31	1600	NSYRSW31
19" swing rack, off-center	36	1800	NSYRSW36
19" swing rack, off-center	40	2000	NSYRSW40
19" swing rack, off-center	45	2200	NSYRSW45

19" swing rack for 800 mm enclosures, centered

- To be coupled to enclosures with widths of 800 mm.
- Can be moved depthwise with a pitch of 25 mm.
- Reversible opening direction: Left/right.
- Locking system, top and bottom, with 5-mm double-bar key.
- Maximum opening: 130° (option of opening to 180° using 180° hinges).
- Material: Zinc-coated steel and steel painted
- Maximum load: 3.75 kg/unit with a max of 150 kg

Installation:

- Spacial SF - SM
- Other mounting options: Consult us

Maximum equipment installation depth:

- Off-center 19" swing rack: 470 mm
- Centered 19" swing rack: 390 mm

Fixing to the enclosure structure:

- Spacial SF: Fixing to the entire height of the enclosure structure.
- Spacial SM: Fixing to the enclosure on top/bottom adjustment rails.

Components:

- Zinc-coated steel central structure.
- Mounting cross-rail on structure made from steel painted with epoxy polyester resin, textured RAL 7035 grey.
- Fixed to the central structure by screws.
- Side plate made from steel painted with epoxy polyester resin, textured RAL 7035 grey. Fixed to the central structure by screws.



NSYRSW27



For more details see [page 486](#)

Supply:

Centered and off-center 19" swing rack: hinged rack, 800 mm swing rack supports, side plates with locking system double-bar and fixing elements

Characteristics	No. of units (H)	Height (mm)	References
19" swing rack, centered	27	1400	NSYRSWC27
19" swing rack, centered	31	1600	NSYRSWC31
19" swing rack, centered	36	1800	NSYRSWC36
19" swing rack, centered	40	2000	NSYRSWC40
19" swing rack, centered	45	2200	NSYRSWC45

180° hinge

- Hinge for installation on centered and off-center 19" swing racks.
- Allows the swing rack to be opened to 180°.
- Fixing by M8 screws directly to the swing rack.
- Material: Zamak 5

Maximum equipment installation depth:

Off-center 19" swing rack: 425 mm,
Centered 19" swing rack: 345 mm.



NSYRSWH180

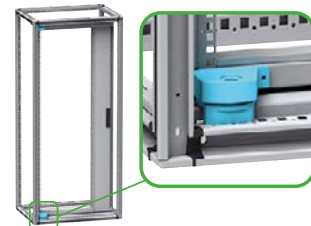

Supply:

2 hinges and fixing elements

Characteristics	References
180° hinge	NSYRSWH180

1 U / 3 U support

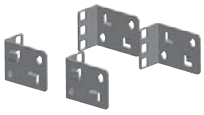

NSYRC1U

- Support prepared for installing equipment 1 U or 3 U high.
- Designed with quick-locking for easy installation.
- **Spacial SF:** Direct fixing to the structure.
- **Spacial SM:** Fixing to the enclosure by means of the vertical adapter section, see [page 278](#).
- Material Zinc-coated steel

Characteristics	References
1 U / 3 U support	NSYRC1U

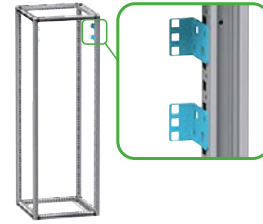

For more details see [page 486](#)

Supply:
4 1 U/3 U supports (2 units right and 2 units left) and fixing elements

19" partial single slides



NSYGB140

- Rails for installation on fixed or swing racks.
- Direct fixing on the structure of the enclosure, by quick-locking.
- Material: Zinc-coated steel
- Thickness: 12/10e mm
- Maximum load: 15 kg

Characteristics	References
19" partial single slides	NSYGB140

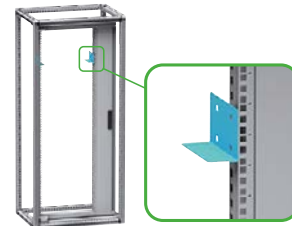

Supply:
2 rails and fixing elements

Fixing of cable ducts on 19" racks



NSYRCDFIX

- Allows vertical fixing of cable ducts for cable guide.
- Service depth: 150 mm.
- Fixed by quick-locking to the 19" rack profile.
- Material: Zinc-coated steel

Characteristics	References
Fixing of cable ducts on 19" racks	NSYRCDFIX

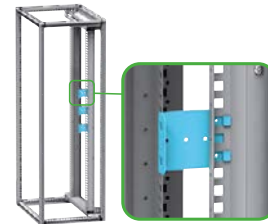

Supply:
3 units and fixing elements

Rear cable-guide support



NSYRCSUP15

- Supports used for installation on the rear of the swing racks.
- Suitable for fixing cable-guide accessories.
- Allow vertical fixing of cable ducts: Adjustable depth with a pitch of 44.45 mm.
- Material: Zinc-coated steel

Characteristics	Service depth (mm)	References
Rear cable-guide support	150	NSYRCSUP15
Rear cable-guide support	250	NSYRCSUP25

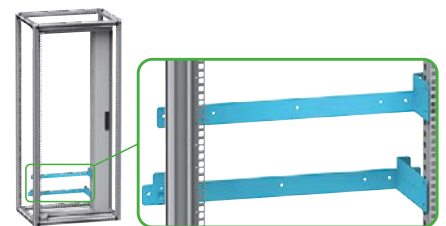

Supply:
2 cable-guide supports, crossbar and fixing elements

120° mechanical retainer

- Retainer for installation on the swing racks.
- Maximum opening: 120°.
- Not compatible with the 19" swing racks for 600 mm enclosures (NSYRSW6*)

Fixing:

Direct fixing to the rack support and the 19" rack



NSYRCDR12

Supply:
1 mechanical door stop and fixing elements

Characteristics	References
120° mechanical retainer	NSYRCDR12

180° pneumatic retainer

- Retainer for installation on the swing racks installed with 180° hinges, in enclosures with a depth of 600, 800 or 1000 mm.
- Maximum opening: 180°.

Fixing:

Spacial SF:

Fixing to the base of the structure and to the rack.

Spacial SM:

Direct fixing to the rack support and to the 19" rack.



NSYRCDR18

Supply:
1 pneumatic door stop and fixing elements

Characteristics	References
180° pneumatic retainer	NSYRCDR18

Flat escutcheon for swing 19" rack



NSYRCLOCK

- Flat escutcheon with 5-mm double-bar insert lock, for installation on swing 19" racks

Supply:
1 flat escutcheon, 5-mm double-bar insert and fixing elements

Characteristics	References
Flat escutcheon for swing 19" rack	NSYRCLOCK

Switch for swing 19" rack



NSYRCINT

- Switch for direct fixing on the bottom or top support of the swing rack.
- M20 connection.
- NO + NC contact, 10 A/500 V.

Supply:
1 19" rack switch and fixing elements

Characteristics	References
Switch for swing 19" rack	NSYRCINT

Fixings for 19" rack

- They allow 19" accessories to be mounted.
- Caged nut compatible with 8.5 x 8.5 mm and 9.5 x 9.5 mm holes.



NSYGFR95M63

Characteristics	Set of	References
M6 screws + washers + nuts	30	NSYGFR95M63
M6 x 16 screws and washers	50	NSYGFR166P
M6 caged nuts	100	NSYCN9M625
M6 screws + washers + nuts	50	NSYGFR95M65
M5 screws + washers + nuts	50	NSYGFR95M55

1-body 19" enclosure

Fixed chassis

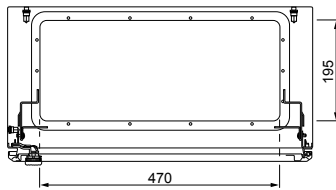
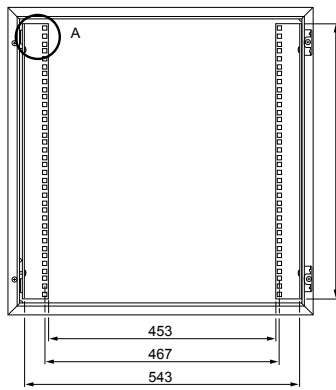

Swing chassis

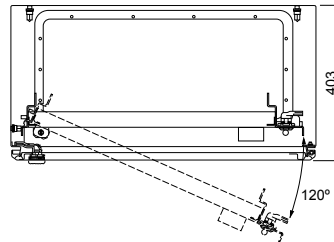
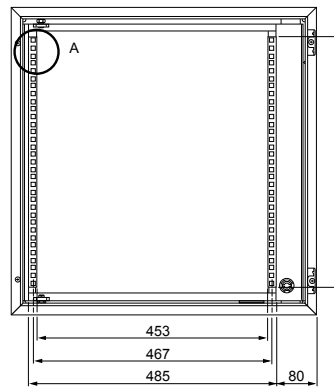

Fixed chassis mounted on the step slides

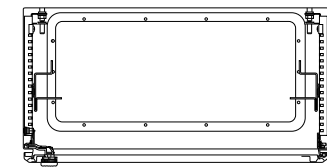
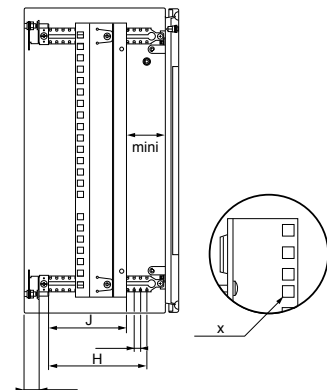

Cable gland plate 495 x 220 mm.

H (bars) (mm)	J (travel) (mm)
200	100
250	150
300	200
400	300

Double-body 19" enclosure

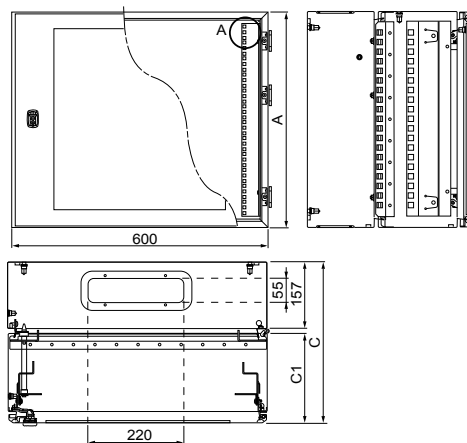

A (mm)	C (mm)	C1 (mm)	References
300	373	183	NSYVD2M5U4
400	373	183	NSYVD2M5U5
500	373	183	NSYVD2M8U4
700	373	183	NSYVD2M8U5
800	373	183	NSYVD2M10U4
300	473	283	NSYVD2M10U5
400	473	283	NSYVD2M14U4
500	473	283	NSYVD2M14U5
700	473	283	NSYVD2M17U4
800	473	283	NSYVD2M17U5

Cable gland plate S3D type dimensions 245 x 80 mm.

Ventilated roof

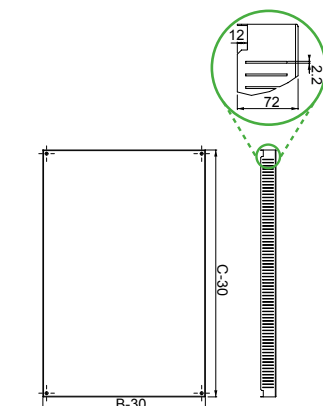

Examples of possible combinations

Cable gland plates for the roof

Spacial SF dimensions		Combination 1	Combination 2
Width (mm)	Depth (mm)		
600/800	600		
600/800	800		
600/800	1000		

Technical changes reserved. Information provided without guarantee. Images are for illustrative purposes only.

Spacial SF 19" electronic enclosure

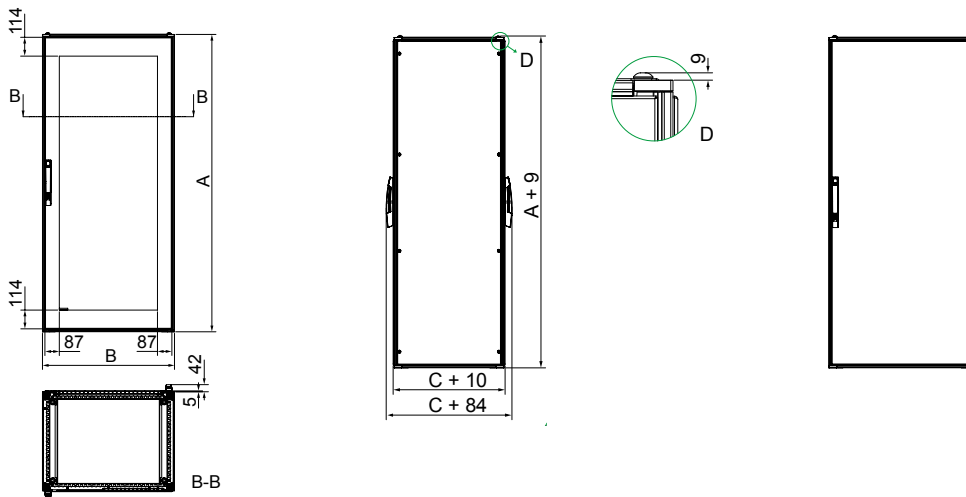

Partial 19" swing rack for 600 and 800 mm enclosures

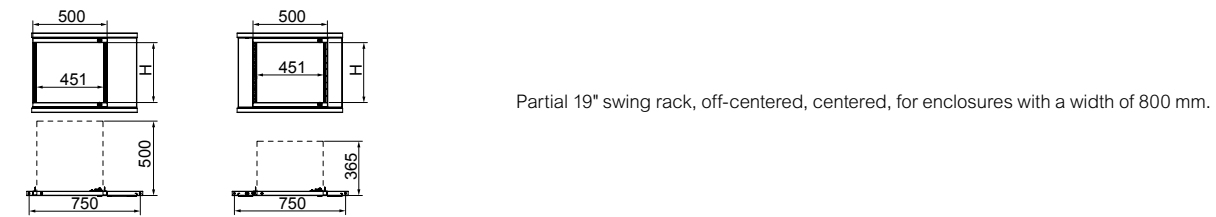
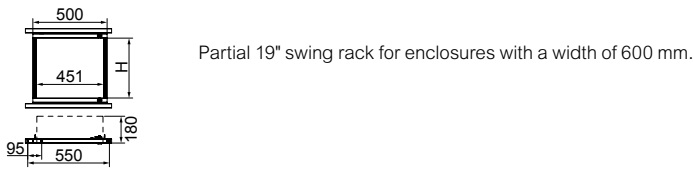

19" swing rack for 600 mm enclosures

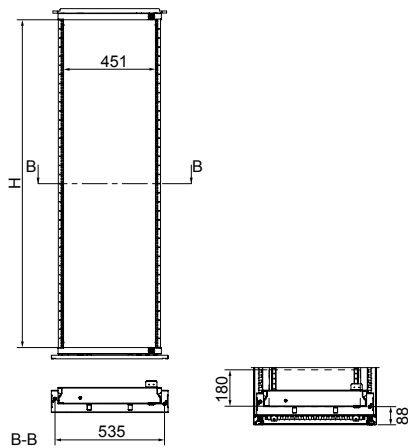

19" swing racks for 800 mm enclosures

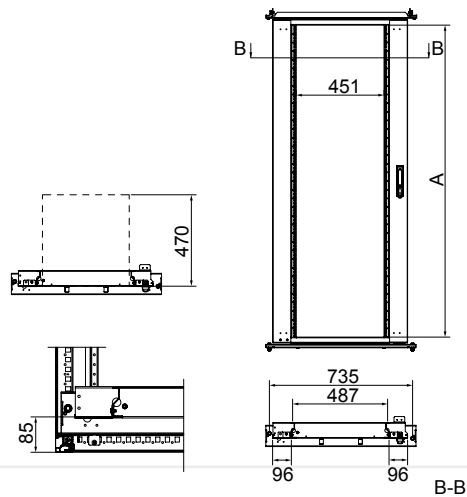

1 U / 3 U support

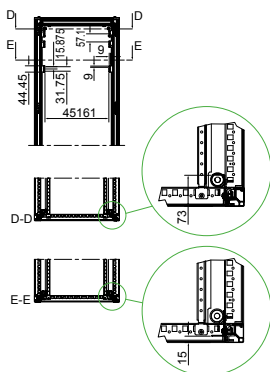

Technical changes reserved. Information provided without guarantee. Images are for illustrative purposes only.

EcoStruxure™ Micro Data Center for Rugged Environments

Spacial SF 19" electronic enclosure

Solution at a Glance

IOT and Industry 4.0 transformations mean that critical IT and OT equipment is moving closer to where it's used. That's why Schneider Electric™ has expanded its EcoStruxure™ Micro Data Center R-series to include all new NEMA and IP ratings for harsh environments. It's everything you already love about EcoStruxure Micro Data Center – a complete, simple-to-deploy, simple-to-manage solution – fine-tuned for industrial use.



Up and running in weeks, not months.



Costs 42-48% less than typical data center build!



Securely manage from anywhere.

Secure physically to ensure cybersecurity

- NEMA and IP rating for harsh environments
- Essential access control
- Environmental monitoring and alerts
- Remote video surveillance



Enclosure description



- Structure: Top and bottom frame and vertical uprights.
- Plain front door
- Plain rear door.
- Locking system with handle and insert key NSYIN405E1
- Removable roof assembled
- External fixing of double-folded side panels to increase rigidity, captive fixing screws that reduce installation time.
- Side panels mounted
- Plinth H=100mm mounted
- Gland plate mounted
- 4 crossrails mounted (2 on each side) for 1200mm heights
- 6 crossrails mounted (3 on each side) for 2000mm heights
- 4 x 19" upright mounted
- Enclosure width 800 with support bracket NSYCRKS.... and NSYRCK19KIT in order to mount 19" upright
- 5 earthcable NSYEL2225D8 mounted
- Material: Steel
- Finish: Structured finish, epoxy polyester powder
- Color: RAL 7035 grey
- UL, CUL according to UL 508A and CSA C22.2 NO.14
- Nema 1 and 12 according to NEMA 250
- RoHS and REACH directive compliance.

For more details Please consult us

Characteristics	Height (mm)	Width (mm)	Depth (mm)	References
Spacial SF 12x8x6 Solution Edge Micro data center	1200	600	800	NSYSFRSEDC1268E
Spacial SF 20x6x8 Solution Edge Micro data center	2000	600	800	NSYSFRSEDC268E
Spacial SF 20x8x10 Solution Edge Micro data center	2000	800	1000	NSYSFRSEDC281E
Spacial SF 20x6x10 Solution Edge Micro data center	2000	600	1000	NSYSFRSEDC261E
Spacial SF 20x8x12 Solution Edge Micro data center	2000	800	1200	NSYSFRSEDC2812E

Technical changes reserved. Information provided without guarantee. Images are for illustrative purposes only.

Electromagnetic interference

Introduction

LV networks are highly polluted and subject to a large number of aggressions. Electrotechnical equipment and in particular electronic devices, which are increasingly numerous and process ever lower signals, must withstand a harsh electromagnetic environment. At the same time availability requirements, whether for production, management or commerce, are steadily increasing.

Definition

Electromagnetic interference is defined as any electromagnetic phenomenon capable of impairing the performance of a device, equipment or system, etc. An electromagnetic disturbance can be electromagnetic noise, an unwanted signal or a change in the propagation medium itself.

An electromagnetic disturbance, as its name suggests, consists of an electric field \vec{E} generated by a potential difference and a magnetic field \vec{H} difference caused by the flow of a current I along a conductor.

Unwanted electromagnetic interference is simply an unwanted electrical signal that is added to the useful signal.

This unwanted signal is propagated via conductors and by radiation.

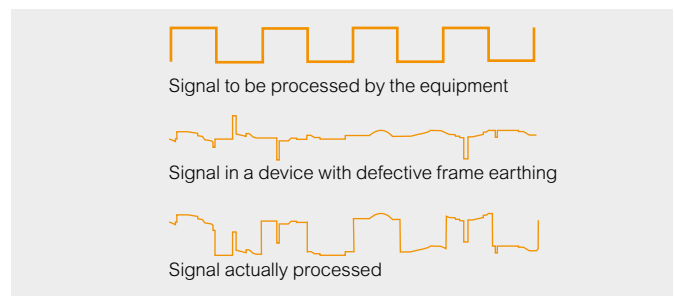
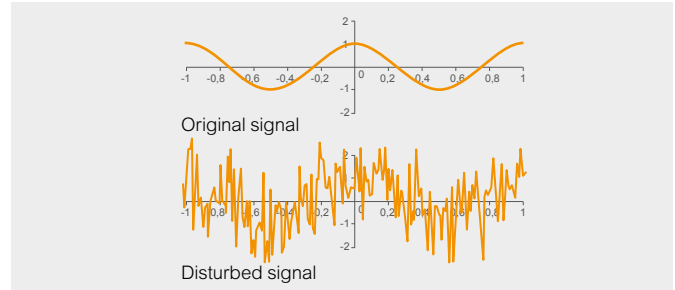

Examples of sources of electromagnetic interference

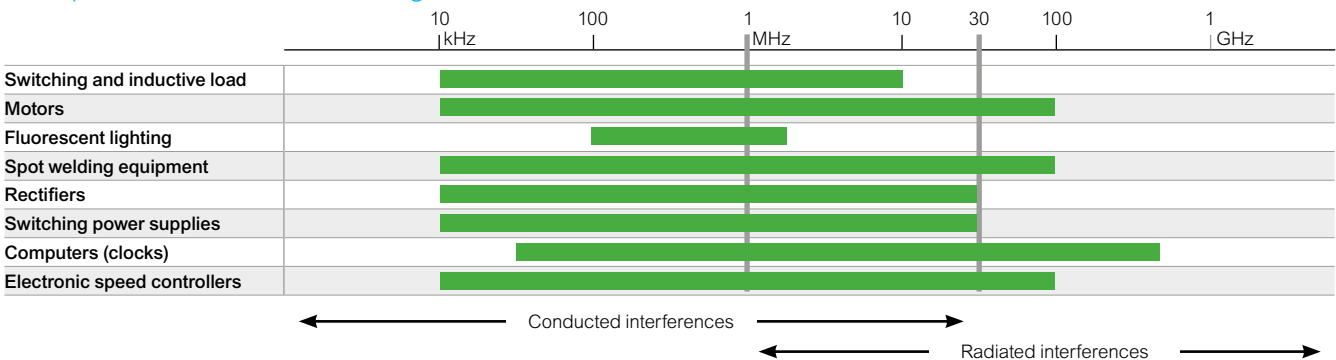

EMC standards

The standards define electromagnetic compatibility (EMC) as "the ability of a device, equipment or a system to function satisfactorily in its electromagnetic environment without introducing intolerable disturbances to that environment or to other equipment".

Classification

In an electrical switchboard, the signals coming from these sources of disturbance will coexist with more sensitive devices. These signals may be classified as follows (sources: standards IEC 61000-5-2 and IEC 60364-4-44):

Class	Examples
1 Sensitive	<ul style="list-style-type: none"> Low-power devices with analog output, transducers etc. Instrument circuits (probe, sensors...)
2 Not very sensitive	<ul style="list-style-type: none"> Control/command circuits with resistive load Digitalized low-level circuits (Bus...) Low-level circuits with on-off output unit (sensors...) Low-level direct power supply
3 Not very disturber	<ul style="list-style-type: none"> Control/command circuits with inductive load (relay, contactors, coils, inverters...) with adapted protection Alternating power supply Main power supply connected to power devices
4 Disturber	<ul style="list-style-type: none"> Welding machines Power circuits Drives, switched-mode power supplies ...

How to obtain EMC

Rules to be followed: General description

Electromagnetic interference generated by devices is classified in 2 categories according to its frequency:

- Low frequency (up to 30 MHz): Interference conducted by sensor cables;
- High frequency (above 1 MHz): Interference radiated by a device.

The rules to be followed concern the selection and installation of the electrical installation's components. Overall, they break down as follows:

Conducted interferences

- Importance of the choice of architecture for the power supplies and associated protective devices.
- Use of filters.

Radiated interferences

- Specification of installation rules: grounding, length and cross-section of cables, cabling rules, choice of cable tray, connections, choice and installation of the enclosure.
- Use of filters.

Shielding connection

Shielding connections eliminate interference by conducting them to earth. The decision to connect one or both ends to earth means priority is given to protection against low or high frequencies:

- If one end is earthed, 50-Hz stray current cannot flow, HF protection is moderate;
- if both ends are earthed, 50-Hz current may occur but the barrier against higher frequencies is enhanced.

Isolation transformers

Isolation transformers are used to guard against high-frequency disturbances generated by the network power supply (primary circuit). An electrostatic shield is connected to earth by a short link. This link must be free of paint and any other insulated material. Physical separation of the cables of the primary circuit (network power supply) and those of the secondary circuit (power distribution) is also essential.

Earth connection of metal raceways

Increasing shielding efficiency of highly disturbing cables

The radiation from a shielded variable speed drive/motor connecting cable will be further reduced if it runs in a closed metal raceway or, even better, in a metal conduit. The raceway and tube need to be connected to earth at either end.

Enclosures

The interfering and sensitive components, cables etc. should be installed in separate enclosures or located at some distance from each other.

Note:

For further information, consult your local sales office or our educational leaflet entitled "Electromagnetic compatibility" - ref. **UE17MK08FR**.

Connect the shielding

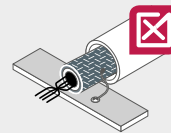

Example 1
Shielding connected to frame earth by a wire (pigtail) and no mechanical fastener.

Arrangement to be avoided.

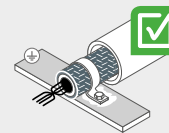

Example 2
Shielding connected to frame earth over its entire circumference, but no mechanical fastener.

Acceptable arrangement.

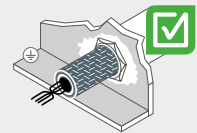

Example 3
Shielding connected to frame earth over its entire circumference, and a mechanical fastener.

Recommended arrangement.

Isolation transformers

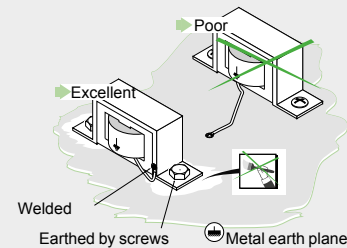

Earth connection of metal raceways

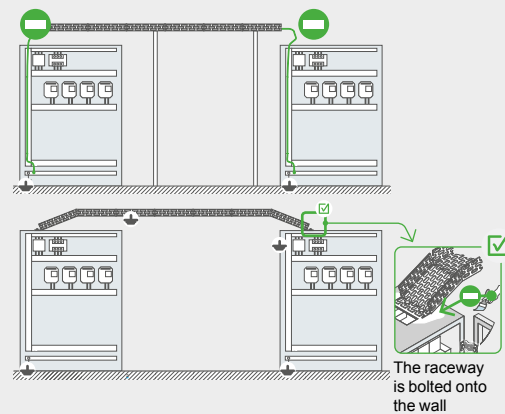

Enclosures

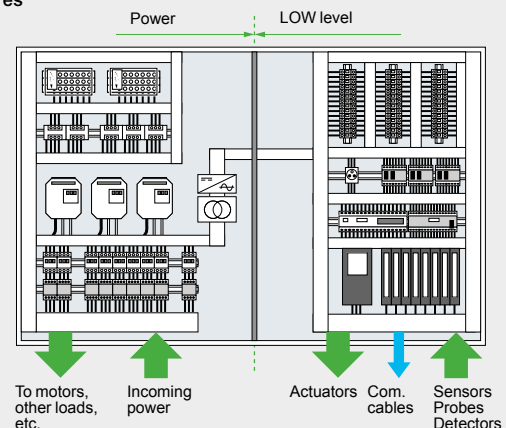

EMC offer of Schneider Electric

This range can be configured according to your needs

4 different services available:



Assemble to order



Mounting of standard accessories



Painting



Machining



Spacial S3HF wall-mounted enclosure, IP55, IK10

- From 400 x 300 x 200 mm to 1200 x 800 x 300 mm (W x D x H)
- Metal monobloc enclosures constructed from special ALU-ZINC 150 sheet.
- Body constructed from single folded and welded sheet.
- The enclosure surface, comprising 55% aluminum, ensures good reflection of radiated electromagnetic interference.
- Ingress protection rating: IP55.
- Mechanical protection rating: IK10.
- Structured finish, exclusively epoxy polyester paint on the outside
- RAL 7035 grey

Spacial SFHF suitable enclosure IP55 IK10

- From 1800 x 600 x 600 mm to 2200 x 800 x 800 mm (W x D x H)
- Metal, extendable enclosure constructed from a closed triangular profile, door and panel from special ALU-ZINC 150 sheet.
- The enclosure surface, comprising 55% aluminum, ensures good reflection of radiated electromagnetic interference.
- Ingress protection rating: IP55.
- Mechanical protection rating: IK10.
- Structured finish, exclusively epoxy polyester paint on the outside
- RAL 7035 grey

See page 546 for details or consult our web site www.se.com

Attenuation of electromagnetic interference

The next illustrations indicates the attenuation (dB) curves related to the frequency (MHz).

Attenuation of the Spacial S3HF enclosure

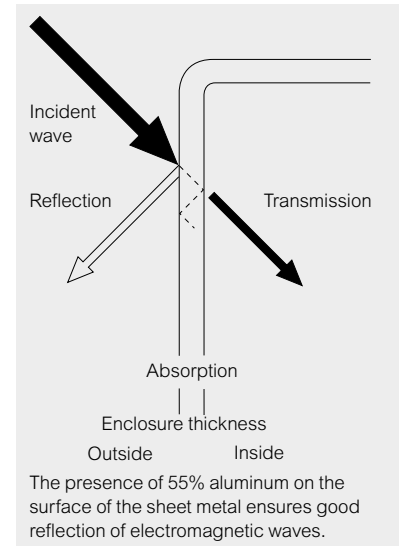
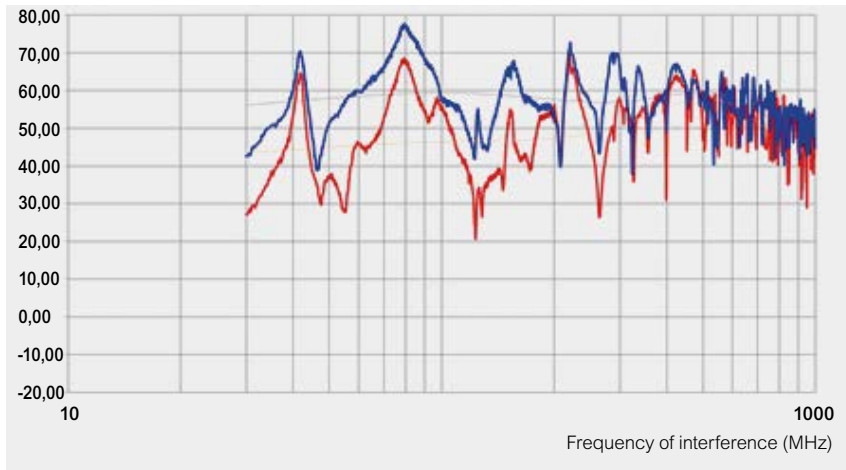

Attenuation of the Spacial SFHF suitable enclosure

Enclosure is tested with its sides panels and earth braids mounted on all claddings (test performed following IEC 61587-3).

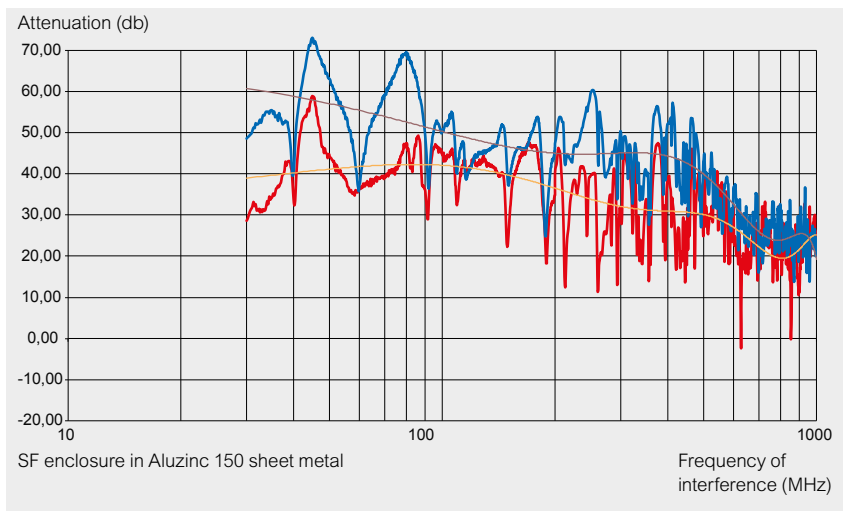

Attenuation curves

— Horizontal attenuation — Vertical attenuation

Trend curves (polynomial of order 6)

— Horizontal attenuation — Vertical attenuation

Spacial S3HF

- Single-piece metal enclosures made from special sheets of ALUZINC 150.
- The presence of 55% aluminum on the surface of the sheet metal ensures good reflection of electromagnetic waves.

Body

- Single-piece body, folded and welded,
- Entirely sealed body with no cable entry and no opening,
- Equipped with four shouldered backstuds allowing direct fixing of the mounting plate,
- Low resistivity for good earth continuity
- Direct fixing or using wall fixing lugs, ref. **NSYPFCR** (to be ordered separately).

Door

- The special body-door gasket (IP + EMC) provides, in addition to water and dust tightness, electric continuity between the door and the body of the enclosure,
- The metal lock with earth continuity helps improve the general shielding,
- An earthing braid added to the enclosure between the body and the door guarantees a good earth connection and, consequently, good electromagnetic compatibility,
- 3-mm double-bar lock as standard delivery (if a 405 key is needed it is possible to mount ref. **NSYCLL405CRN**).
- Other sizes: Consult us.
- Finish: Structured finish, epoxy polyester powder (inside not painted)
- Color: RAL 7035 grey
- Ingress protection rating: IP55 according to IEC 60529
- Mechanical protection rating: IK10 according to IEC 62262
- Certifications and declarations: UL, CE declaration
- Fixing: Fixing lugs, ref. **NSYPFCR** to be ordered separately (1 set of 4 lugs)

For more details see [page 495](#)

Supply:

Enclosure delivered with galvanized mounting plate.



NSYS3HF4320P

Characteristics	Fig.	Weight (kg)	Width (mm)	Height (mm)	Depth (mm)	References
Spacial S3HF	1	7.5	300	400	200	NSYS3HF4320P
Spacial S3HF	2	13.0	400	600	200	NSYS3HF6420P
Spacial S3HF	2	20.5	600	600	250	NSYS3HF6625P
Spacial S3HF	2	32.8	600	800	300	NSYS3HF8630P
Spacial S3HF	2	53.2	800	1000	300	NSYS3HF10830P

Support bracket for enclosure with anti-tilt kit and reinforcement

- The support bracket is used when the enclosure cannot be mounted to a wall or post.
- Maximum enclosure dimensions: 1000 x 800 x 300 mm.
- Floor attachment by standard M12 fasteners.
- Material: Steel
- Finish: Painted
- Color: RAL 7035 grey
- Maximum load: 120 kg



NSYCOENS1400

Characteristics	Height (mm)	References
Support bracket for enclosure with anti-tilt kit and reinforcement	1400	NSYCOENS1400
Support bracket for enclosure with anti-tilt kit and reinforcement	1800	NSYCOENS1800

Spacial SFHF

Structure

- Galvanized steel structure,
- Top and bottom frame, vertical upright.

Claddings

- Enclosure with screwed panels (on side and rear) and front plain door (with reinforcement frame) made from Aluzinc steel,
- Side panels to be ordered separately,
- Special gasket (IP + EMC) between body, door and panels.
- Finish: Epoxy polyester paint on the outside (inside not painted)
- Color: RAL 7035 grey
- Ingress protection rating: IP55
- Mechanical protection rating: IK10
- Certifications: RoHS compliant
- Dimensions manufacturing on demand

Note:

Only available on demand.
For more details see [page 495](#)

Supply:

- 1 single plain door with door-reinforcement frame (double-door on request, please consult us).
- Left or right opening to 120°.
- Delivered with standard locking system handle and 5-mm double-bar insert.
- 1 rear panel screwed from the outside.
- 1 removable roof.
- 1 part cable gland plate with special gasket (IP + EMC).



Characteristics	Height (mm)	Width (mm)	Depth (mm)	References
Spacial SFHF	1800	600	600	
Spacial SFHF	1800	800	400	
Spacial SFHF	1800	800	600	
Spacial SFHF	2000	600	400	
Spacial SFHF	2000	600	600	
Spacial SFHF	2000	600	800	
Spacial SFHF	2000	600	1000	
Spacial SFHF	2000	800	400	
Spacial SFHF	2000	800	600	
Spacial SFHF	2000	800	800	
Spacial SFHF	2000	800	1000	
Spacial SFHF	2200	600	600	
Spacial SFHF	2200	800	600	
Spacial SFHF	2200	800	800	

Side panel

- Finish: Epoxy polyester paint on the outside (inside not painted)
- Color: RAL 7035 grey
- Dimensions manufacturing on demand

Note:

Only available on demand.

Characteristics	Height (mm)	Width (mm)	References
Side panel	1800	600	
Side panel	1800	400	
Side panel	2000	400	
Side panel	2000	600	
Side panel	2000	800	
Side panel	2000	1000	
Side panel	2200	600	
Side panel	2200	800	

All mounting accessories are compatible with the SF and SM standard range.

- Mounting plate (see page 265).
- Rails (see page 273).
- 19" frame (fixed and swing-out) (see page 478).



Earth braids

- They guarantee the earth connection for high frequencies, avoiding the disturbing electric currents that are produced.
- Material: Tinned copper.

Supply:

10 earth braids (nuts and washers not included)



Characteristics	Section (mm ²)	Terminal Ø (mm)	Length (mm)	Width (mm)	References
Earth braids	6	6.5	150	12	NSYEB156D6
Earth braids	10	6.5	150	17	NSYEB1510D6
Earth braids	16	8.5	155	17	NSYEB1516D8
Earth braids	25	8.5	200	27	NSYEB2025D8
Earth braids	50	8.5	200	33	NSYEB2050D8

EMC coupling kit

- Used to join enclosures side-by-side or back-to-back. Special gasket for EMC solution.
- Attenuation level is decreased by 5 db when enclosures are joined (please consult us).
- Ingress protection rating: IP55.



Characteristics	Height (mm)	Depth (mm)	References
EMC coupling kit	1800	400	NSYSFHFBK184
EMC coupling kit	1800	600	NSYSFHFBK186
EMC coupling kit	2000	400	NSYSFHFBK204
EMC coupling kit	2000	600	NSYSFHFBK206
EMC coupling kit	2000	800	NSYSFHFBK208
EMC coupling kit	2000	1000	NSYSFHFBK2010
EMC coupling kit	2200	600	NSYSFHFBK226
EMC coupling kit	2200	800	NSYSFHFBK228

EMC cable gland with contact spring

- Thread type: Metric EN 60423, other types are available upon request
- Material: Nickel-plated brass, neoprene gasket
- Ingress protection rating: IP66
- Flame resistance: UL94 V-2
- Temperature range: -20 °C to + 100 °C
- Cable type: Unshielded

Supply:

The cable glands are supplied with nuts.
Pack of 10 (M12 and M16), of 5 (M20 and M25),
of 4 (M32 and M40)



Characteristics	Ø	Ø min/max	Drill Ø	TD	TL	Wrench width	References
New EMC cable gland with contact spring	M12	3/6.5	12 to 12.2	12	6	14	NSYCGHF12
New EMC cable gland with contact spring	M16	5/10	16 to 16.2	16	7	20	NSYCGHF16
New EMC cable gland with contact spring	M20	6/12	20 to 20.2	20	8	22	NSYCGHF20
New EMC cable gland with contact spring	M25	11/17	25 to 25.2	25	8	27	NSYCGHF25
New EMC cable gland with contact spring	M32	15/21	32 to 32.3	32	8	34	NSYCGHF32
New EMC cable gland with contact spring	M40	19/28	40 to 40.3	40	9	43	NSYCGHF40

Spacial S3HF

Fig. 1

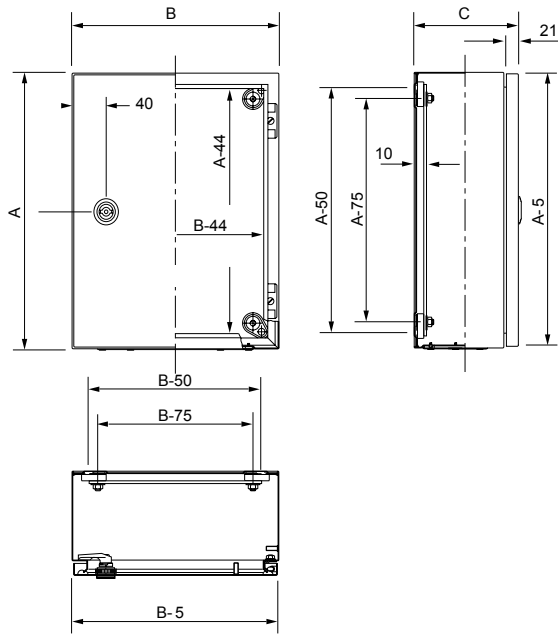
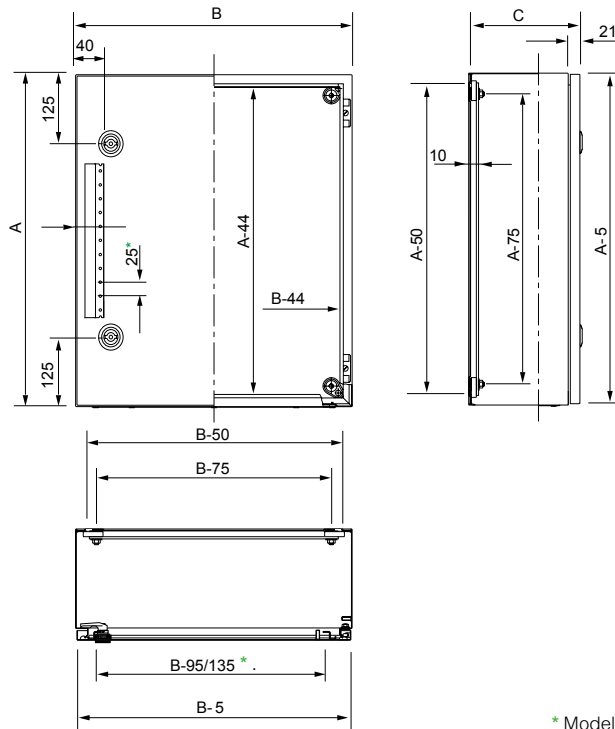

Fig. 2



A: Height.
B: Width.
C: Depth.

* Model 1200 x 800.

Spacial SFHF

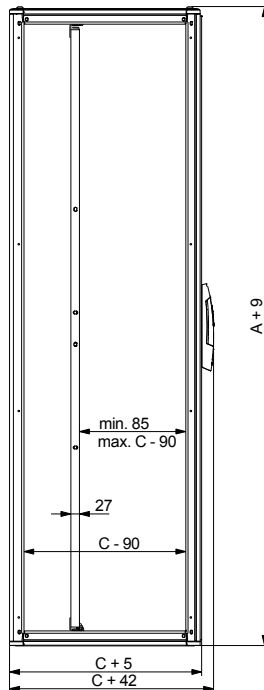
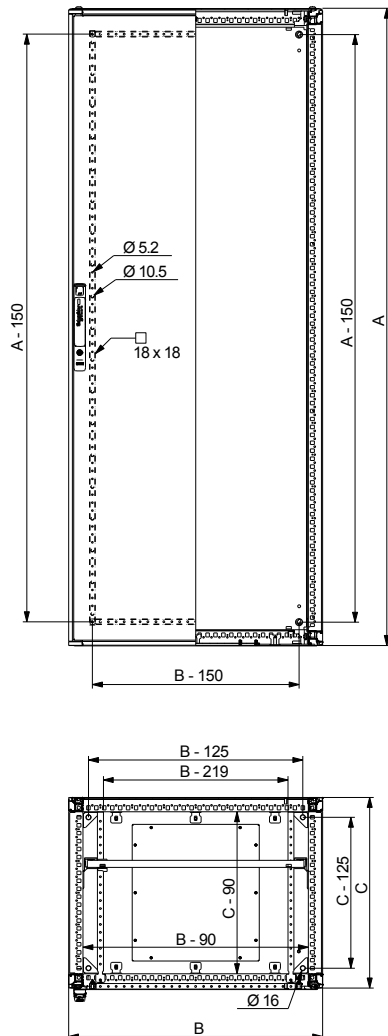

A: Height.
B: Width.
C: Depth.

Industrial environments, equipment rooms

Spacial S3DEX steel enclosure

The Spacial S3DEX steel enclosure is certified by the LCIE with no. LCIE 02ATEX0037U (component certification).

- Ten sizes: From 300 x 200 x 150 mm to 1000 x 800 x 300 mm.
- Degree of protection: IP66 according to IEC 60529.
- Ambient temperature range: $-20\text{ °C} \leq T_a \leq +40\text{ °C}$.
- Resistance to external mechanical impacts: IK10.
- Structured finish, epoxy polyester powder paint, RAL 7035 grey.



Safety

- Blind nut for external earth connection.



- The 4 fixing holes are blocked by 4 crimped blind nuts.



- Earthing studs welded to the door and inside the body.

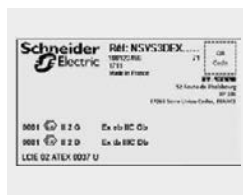

Label

- Example of specific ATEX marking (description: [Page 723](#)).

11



Robust

- The chassis is mounted on four 10 mm shouldered backstuds.

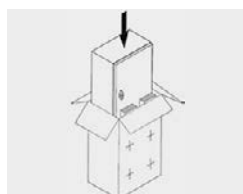

Easy handling

- Reusable, eco-friendly packaging.
- No sharp edges.



In accordance with the ATEX directive

- The enclosures bear the marking shown on [page 723](#).
- The enclosures offer a degree of protection of IP66 according to EN 60529, reaching the highest dust protection according to ATEX standards.
- The certification of our production sites and inspection procedures guarantees the observance and regularity of the quality level.

Protection of all applications in ATEX II2 or II3 areas

- Surface installations with occasional or accidental
- Thanks to ATEX-certified steel.

ATEX enclosures from Schneider Electric



Steel enclosures

- All the wall-mounted enclosures presented in this brochure comply with standards for protection against the potential risk of explosion in atmospheres containing gas (G) or dust (D).
- The Schneider Electric offer, designed to be used in group II, is classified as category 2.

Protection of equipment against explosion			ATEX	
Group *	Category	Level	Probability	Zone
I	M1	Very high	Permanent	0 / 20
I	M2	High	Occasional	1 / 21
II	1	Very high	Permanent	0 / 20
II	2	High	Occasional	1 / 21
II	3	Normal	Accidental	2 / 22

* I = equipment designed to be used in the mining and quarrying industries
 II = equipment designed to be used in surface industries

 Zone of application of Schneider Electric ATEX wall-mounted enclosures.

- Products of category 2 can be used as category 3.

Our products are certified:

- For gas environments: Increased safety "e" (Ex e) but not flameproof safety "d" (Ex d);
- For dust environments: Protection by enclosure "t" or "tb".
- The wall-mounted enclosures offer a degree of protection of IP66 according to IEC 60529, exceeding the recommendations of the ATEX directive.
- Certification of our production sites and inspection procedures guarantees observance and consistency of the quality level.

Potentially explosive atmospheres (ATEX)

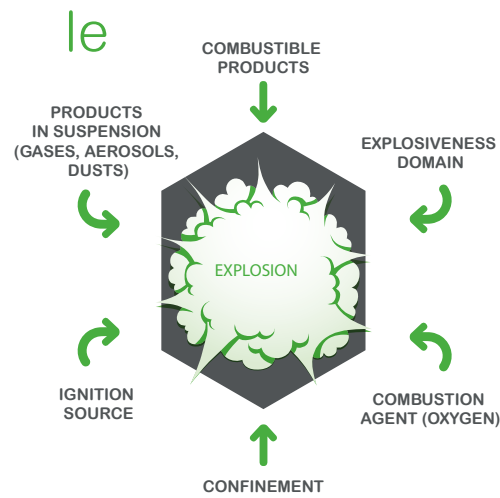

Explosion hexagon

Process leading to an explosion in an explosive atmosphere

For an explosion to occur, six conditions must be met simultaneously (see explosion hexagon opposite). The process is as follows:

- Mixing combustible substances (gases, dusts) with air whose oxygen acts as combustion agent;
- Dosing of combustible products and combustion agents in precise proportions; thereby obtaining a potentially explosive atmosphere;
- Confining the explosive atmosphere thus obtained in a place conducive to explosion;
- Exposing it to an ignition source having sufficient energy to cause an explosion.

ATEX regulations

Two EU directives and an international standard regulate potentially explosive atmospheres:

- The objective of the two EU directives (the so-called ATEX directives) is to enhance protection from explosions by making various technical and organizational measures compulsory;
- The 2014/34/EU directive (a revision of the 94/9/EC directive) came into application on 20 April 2016. It describes the requirements that must be met by protection devices and systems, and the conformity assessment procedures;
- The 99/92/EC directive, a labour relations supplement to the preceding one, presents the minimum requirements to be met to improve the protection of workers liable to be exposed to ATEX-related risks.



Definition



Product directive 2014/34/UE: defines the manufacturers' obligations.



Personal protection directive 99/92/CE: defines the users' obligations.

Degree of protection:

In hazardous areas, equipment is required to offer a minimum degree of protection of IP54, but it can be tested or certified for a higher degree of protection.

- An IEC international standard harmonized with the European standard EN:
- IEC 60079: electrical equipment for potentially explosive gaseous atmospheres.

Classification

Locations liable to be in the presence of an explosive atmosphere have been classified according to 2 criteria:

- The probability assessed on a scale comprising 3 levels;
- The nature of the combustible product.

The following 6 ATEX zones are obtained:

Probability of an explosive atmosphere	Gas / vapor or mist	Dust
Place in which an explosive atmosphere is present constantly , or for long periods or frequently	Zone 0	Zone 20
Place in which an explosive atmosphere is likely to occur occasionally in normal operation	Zone 1	Zone 21
Place in which an explosive atmosphere is not likely to occur in normal operation or, if it does occur, will persist for a short period only	Zone 2	Zone 22

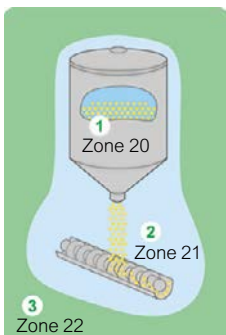
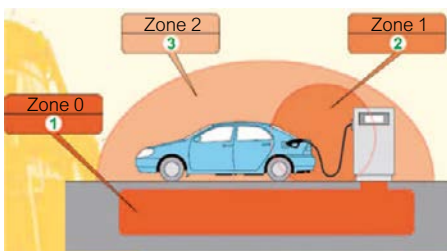

Equipment installed in an explosive-atmosphere zone must be protected against the risk of explosion. Three levels of protection have been defined, corresponding to the three probabilities of existence of an explosive atmosphere. They are broken down into 5 categories depending on the type of industry.

Protection of equipment against explosions			ATEX	
Group *	Category	Level	Probability	Zone
I	M1	Very high	Permanent	0 / 20
I	M2	High	Occasional	1 / 21
II	1	Very high	Permanent	0 / 20
II	2	High	Occasional	1 / 21
II	3	Normal	Accidental	2 / 22

* I = equipment designed to be used in the mining and quarrying industries

II = equipment designed to be used in surface industries

Protection of electrical equipment

The standards define various methods of protection for electrical equipment according to the application in explosive atmospheres containing gas or dust.

Electrical equipment		ATEX	Methods of protection	
CENELEC	IEC		Symbol	Title
EN 50015	IEC 60079-6	G, D	o	Immersion in oil
EN 50016	IEC 60079-2	G, D	p	Enclosures with internal overpressure
EN 50017	IEC 60079-5	G, D	q	Filling with powder product
EN 60079-1	IEC 60079-1	G, D	d	Explosion-proof enclosures
EN 60079-7	IEC 60079-7	G, D	e	Increased safety "e"
EN 50020	IEC 60079-11	G, D	i	Intrinsic safety
EN 60079-15	IEC 60079-15	G, D	n	Product design
EN 60079-31	IEC 60079-31	G, D	tD	Protection by enclosure "t"

G = gas / vapor or mist
D = dust

ATEX certification of electrical switchboards

- Since 1 July 2003, the European Union has made it compulsory to use certified equipment (electrical or non-electrical) when it is to be installed in areas where the atmosphere is potentially explosive.
- The certification must be established by an approved organization in accordance with the 2014/34/EU directive.
- The organization certifies that the product complies with the health and safety requirements defined in the European directive and the international standards.
- The certificate indicates, via the marking, the product's category and accordingly the zone and the atmosphere in which it may be used.
- Enclosures are certified as components. They will be assembled with other ATEX components (electrical, pneumatic, hydraulic, etc.), to form a final solution which must itself be ATEX-certified and covered by a declaration of conformity.

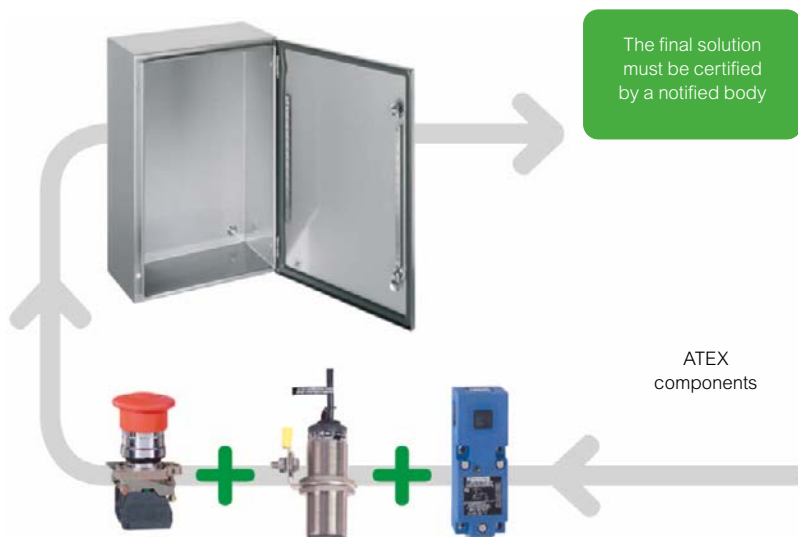

Spacial S3DEX

Protection for users

- Earthing: The Spacial S3DEX steel enclosures are provided with M6 x 16 earth studs welded to the casing and door for equipotential connection. Earth strap to be ordered separately.
- Closing: Enclosures higher than 600 mm are provided with three locking points with connecting rods, with a single control point preventing the enclosures from being left half-open.

Casing

- Monobloc casing (cross-structure). Gutter-shaped front profile.
- 4 bottom shoulder studs M8 x 25 for mounting the chassis and notched bars to provide a space of 10 mm at the rear.

Door

- Standard fastening by 3-mm double-bar lock
- Polyurethane door seal
- Double-thickness 20 mm return conferring excellent rigidity;
- 2 concealed hinges (3 above H = 800 mm) to facilitate dismantling and reversibility of the door. Opening angle: 120°
- Maximum load: 50 kg/m².
- Perforated sections on the door, with holes of diameter 4.2 mm every 25 mm for mounting accessories:
- 2 vertical sections from H = 400 mm;
- 2 vertical sections and 2 horizontal sections from L = 800 mm.

Specific ATEX features

- 4 fastening holes closed by 4 crimped blind nuts.
- One crimped M8 blind nut for an external frame earth link (strap not provided)
- Ambient temperature: -20 °C ≤ Ta ≤ +40 °C
- Marking: See [page 723](#).
- Material: Steel
- Finish: Structured finish, epoxi-polyester powder painting
- Color: RAL 7035 grey
- Ingress protection rating: IP66 (enclosures with single-door) according to IEC 60529
- Mechanical protection rating: IK10 (enclosures with plain door) according to IEC 62262
- Fixing: Wall fixing lugs:

Passivated zinc-coated steel: Reference **NSYAEFPFSC**

304L stainless-steel: Reference **NSYAEFPFXSC**



NSYS3DEX3215

Characteristics	Height (mm)	Width (mm)	Depth (mm)	References
Spacial S3DEX	300	200	150	NSYS3DEX3215
Spacial S3DEX	300	300	200	NSYS3DEX3320
Spacial S3DEX	400	300	200	NSYS3DEX4320
Spacial S3DEX	400	400	200	NSYS3DEX4420
Spacial S3DEX	500	400	200	NSYS3DEX5420
Spacial S3DEX	600	400	250	NSYS3DEX6425
Spacial S3DEX	600	600	250	NSYS3DEX6625
Spacial S3DEX	700	500	250	NSYS3DEX7525
Spacial S3DEX	800	600	300	NSYS3DEX8630
Spacial S3DEX	1000	800	300	NSYS3DEX10830



The accessories of the Spacial standard wall-mounted enclosures can be installed in the Spacial S3DEX wall-mounted enclosures. However, plastic accessories should not be used due to the risk of a static charge.

Mounting plate Plain



NSYMM32

Characteristics	Height (mm)	Width (mm)	References
Mounting plate Plain	300	200	NSYMM32
Mounting plate Plain	300	300	NSYMM33
Mounting plate Plain	308	255	NSYMM3025
Mounting plate Plain	400 / 430	300 / 330	NSYMM43
Mounting plate Plain	400	400	NSYMM44
Mounting plate Plain	500 / 530	400 / 430	NSYMM54
Mounting plate Plain	600 / 647	400 / 436	NSYMM64
Mounting plate Plain	600	600	NSYMM66
Mounting plate Plain	700 / 747	500 / 536	NSYMM75
Mounting plate Plain	800 / 847	600 / 636	NSYMM86
Mounting plate Plain	1000 / 1056	800 / 852	NSYMM108

Mounting plate Silkscreened



NSYMS43

Characteristics	Height (mm)	Width (mm)	References
Mounting plate Silkscreened	400 / 430	300 / 330	NSYMS43
Mounting plate Silkscreened	400	400	NSYMS44
Mounting plate Silkscreened	500 / 530	400 / 430	NSYMS54
Mounting plate Silkscreened	600 / 647	400 / 436	NSYMS64
Mounting plate Silkscreened	600	600	NSYMS66
Mounting plate Silkscreened	700 / 747	500 / 536	NSYMS75
Mounting plate Silkscreened	800 / 847	600 / 636	NSYMS86

Mounting plate Microperforated

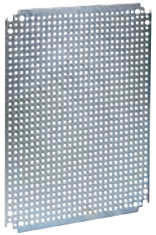

NSYMF33

Characteristics	Height (mm)	Width (mm)	References
Mounting plate Microperforated	300	300	NSYMF33
Mounting plate Microperforated	400 / 430	300 / 330	NSYMF43
Mounting plate Microperforated	400	400	NSYMF44
Mounting plate Microperforated	500 / 530	400 / 430	NSYMF54
Mounting plate Microperforated	600 / 647	400 / 436	NSYMF64
Mounting plate Microperforated	600	600	NSYMF66
Mounting plate Microperforated	700 / 747	500 / 536	NSYMF75
Mounting plate Microperforated	800 / 847	600 / 636	NSYMF86
Mounting plate Microperforated	1000 / 1056	800 / 852	NSYMF108

Mounting plate Telequick



NSYMR32

Characteristics	Height (mm)	Width (mm)	References
Mounting plate Telequick	300	200	NSYMR32
Mounting plate Telequick	300	300	NSYMR33
Mounting plate Telequick	308	255	NSYMR3025
Mounting plate Telequick	400 / 430	300 / 330	NSYMR43
Mounting plate Telequick	500 / 530	400 / 430	NSYMR54
Mounting plate Telequick	600 / 647	400 / 436	NSYMR64
Mounting plate Telequick	600	600	NSYMR66
Mounting plate Telequick	700 / 747	500 / 536	NSYMR75
Mounting plate Telequick	800 / 847	600 / 636	NSYMR86
Mounting plate Telequick	1000 / 1056	800 / 852	NSYMR108

Mixed symmetrical chassis



NSYMD33

Characteristics	Height (mm)	Width (mm)	References
Mixed symmetrical chassis	300	300	NSYMD33
Mixed symmetrical chassis	400	300	NSYMD43
Mixed symmetrical chassis	500	400	NSYMD54
Mixed symmetrical chassis	600	400	NSYMD64
Mixed symmetrical chassis	600	600	NSYMD66
Mixed symmetrical chassis	700	500	NSYMD75
Mixed symmetrical chassis	800	600	NSYMD86
Mixed symmetrical chassis	1000	800	NSYMD108

Step slides



NSYSDCR200

Characteristics	Depth (mm)	References
Step slides	200	NSYSDCR200
Step slides	250	NSYSDCR250
Step slides	300	NSYSDCR300

Single-door enclosure

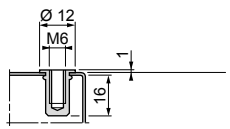
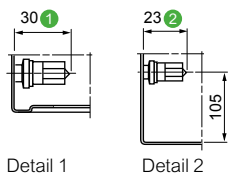

Detail 4
4 crimped blind nuts for direct fixing of the fixing lugs

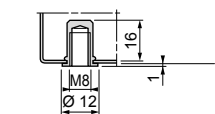

Detail 5
1 crimped blind nut for the external earth

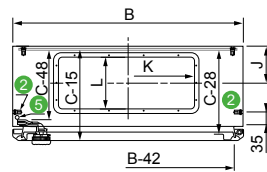
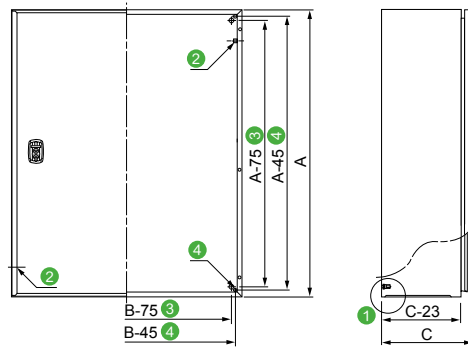

- 1 4 M8 x 25 mm backstuds.
- 2 2 M6 x 17.5 mm earthing studs.
- 3 Stud center-to-center distance.
- 4 Crimped blind nut center-to-center distance.
- 5 Blind nut for external earth.

A: Height
B: Width
C: Depth

Perforated rails on the door

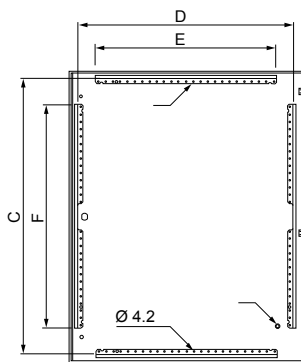

Enclosure (8)		Perforated rails on the door (mm)			
Height (A) (mm)	Width (B) (mm)	Vertical F	Vertical D	Horizontal E	Horizontal C
400	300	320	237	-	-
400	400	320	337	-	-
600	400	370	337	-	-
600	600	370	537	-	-
700	500	470	437	-	-
800	600	570	537	-	-
1000	800	770	737	620	949

- 6 Perforations with a pitch of 25 mm.
- 7 1 M6 x 17.5 mm earthing stud.
- 8 The doors of enclosures with dimensions less than 800 x 600 mm do not have horizontal cable guides.

Human-Machine Interface Solutions

Indoor non-clean industrial environments

Steel

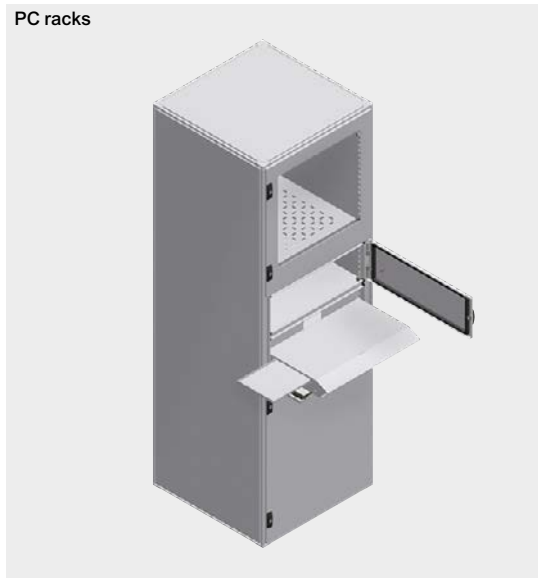

Demanding industrial environments

11

Stainless-steel



Technical changes reserved. Information provided without guarantee. Images are for illustrative purposes only.

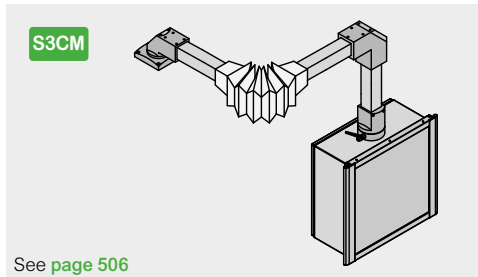

Spacial S3CM control enclosure with suspension system

The Spacial S3CM offer for human-machine interface combines robustness with aesthetics and ergonomics. Consist of:

- Control enclosure,
- A keyboard-box,
- A suspension system of arms and joints, for a fixed or rotating solutions, and support accessories.



Spacial SD Control desks

The range of Spacial SD control desks provides all functions required of a workstation intended for industrial and infrastructure applications. Spacial SD products offer two distinct solutions:

- The SD Compact control desk,
- The SD Control desk with console.

The range has protection ratings of IP55 and IK10 guaranteeing the safety and the protection of the installed devices.



Spacial SF suitable PC rack

The Spacial SF PC rack is designed to protect and control computer equipment in industrial environments. Access to various functions and working heights, guaranteeing optimal comfort. The roof and panels, fixed from the inside, prevent access by unauthorized personnel.



Spacial SDX Control desks

The Spacial SDX range of control desks offers all functions required to set up a control station that meets the industrial or infrastructural needs of applications in harsh environments or in the food and beverage sector. These control panels are easy to implement, compatible with data communication components, and they ensure the safety and protection of control devices. They are available in many dimensions and meet the most stringent user requirements.



Spacial SMX monobloc PC rack

The stainless-steel monobloc PC racks have been especially designed to protect computer equipment installed in corrosive or specially environments that require washing or exposure to sprays of liquid. Access to the various functions and working heights ensure optimal comfort.

The Spacial S3CM offer for human-machine dialogue consists of: control enclosures, a box keyboard, a system of fixed or swiveling arms and joints, accessories. The global dialogue system combines robustness with aesthetics and ergonomics.

This range can be configured according to your needs

4 different services available:



Assemble to order



Mounting of standard accessories



Painting



Machining

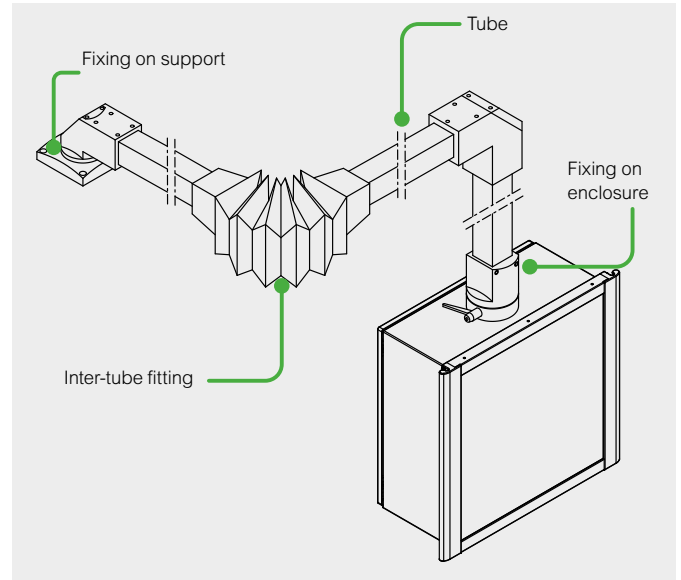

Human-Machine Interface Solutions



Robust

2 tube sizes in extruded steel, 50 and 80 mm square, thickness 40/10e mm. Top wall reinforced by a plate with a thickness of 30/10e mm.



Ease of use

Easy access to the equipment by a rear door, opening to 120°. Direct installation of accessories on the enclosure frame rail:
 - vertical document support,
 - keyboard support,
 - laptop computer support.
 A box keyboard is installed directly on the enclosure.

11



Aesthetics

Extruded aluminum rail frame. Frame: RAL 7040 Window grey. Enclosure: RAL 7035 Light grey. Customization to your image or the aesthetics of your machine: Consult us.



Flexibility

Flexibility



Ergonomics

Frame designed to facilitate the handling and usage of the enclosure by the operator.

See page 546 for details or consult our web site www.se.com

Every model is suitable for tubes with a cross-section of:

- 50 mm for medium loads,
- 80 mm for heavy loads
(see selection table on [page 508](#)).

Steps to choose the suspension system (medium or heavy loads)

- 1 - Define the total load of the system*: a + b + enclosure + installed equipment (Y-axis).
- 2 - Define the length of arm L (X-axis).
- 3 - Define the configuration:

Suspension system without intermediate joint.

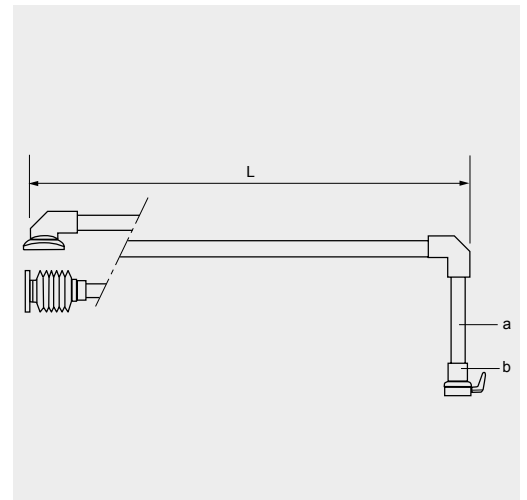
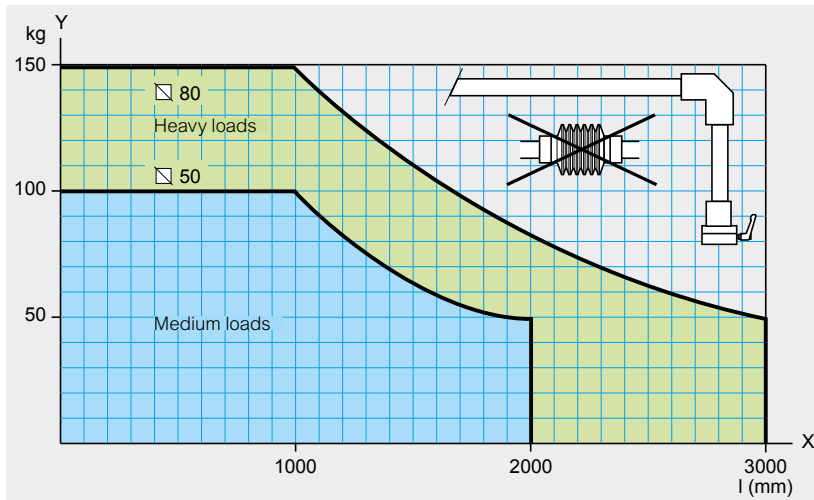

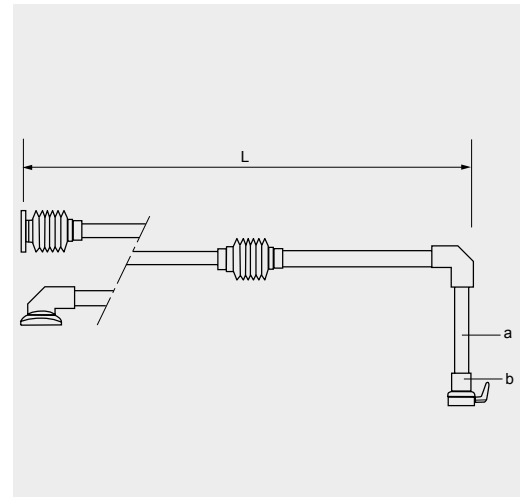
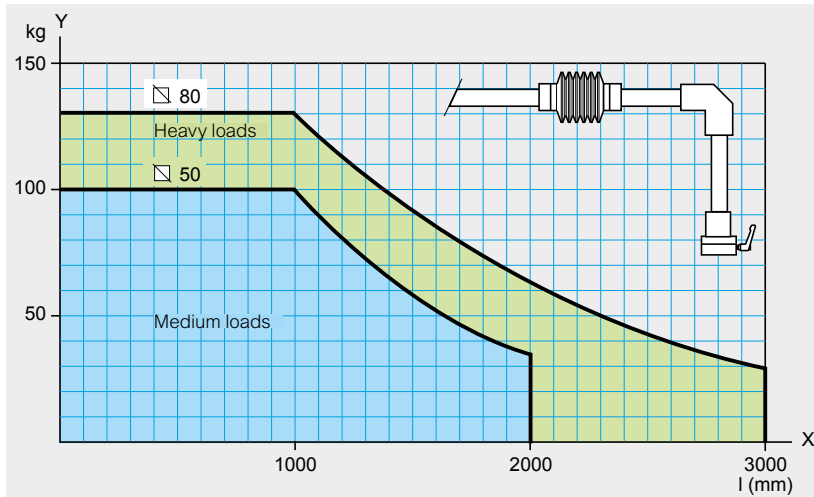

Suspension system with intermediate joint.





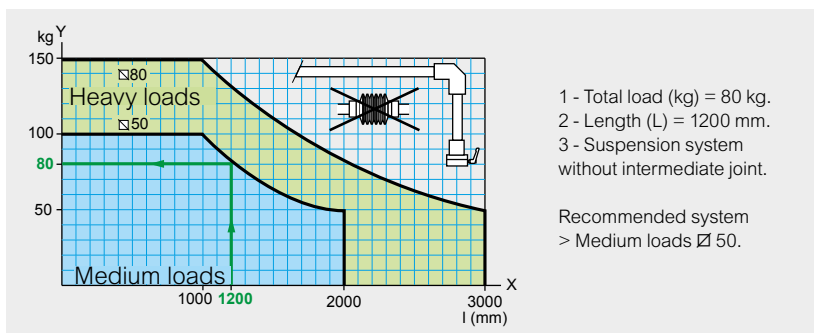

* The load (a + b + enclosure + installed equipment) must be less than the maximum load.



Example





Enclosure dimensions (mm)			Tube section U 50 mm	Tube section U 80 mm	
H (mm)	W (mm)	D (mm)	References	References	
	300	300	200	NSYS3CM303020	-
	300	400	200	NSYS3CM304020	-
	400	400	200	NSYS3CM404020	-
	400	600	250	NSYS3CM406025*	-
	500	500	250	NSYS3CM505025	-
	600	600	200	NSYS3CM606020*	-
	600	800	300	-	NSYS3CM608030
	800	600	300	-	NSYS3CM806030*

Tube	Length (m)	Tube section U 50 mm	Tube section U 80 mm
		References	References
	0.5	NSYCMT5005	NSYCMT8005
	1	NSYCMT5010	NSYCMT8010
	1.5	NSYCMT5015	NSYCMT8015
	2	NSYCMT5020	NSYCMT8020

Fixing on support (steel material)		Tube section U 50 mm	Tube section U 80 mm
		References	References
	1 Fixed base	NSYCMUMR50	NSYCMUMR80
	2 Wall fixing with joint	NSYCMUMA50	NSYCMUMA80
	3 Rotating straight fitting	NSYCMUMC50	NSYCMUMC80

Inter-tube fitting (aluminum material)		Tube section U 50 mm	Tube section U 80 mm
		References	References
	4 Horizontal inter-tube joint	NSYCMUIA50	NSYCMUIA80
	5 Fixed bracket	NSYCMUTC50	NSYCMUTC80

Fixing on enclosure (aluminum material)		Tube section U 50 mm	Tube section U 80 mm
		References	References
	6 Rotating fixing on enclosure	NSYCMUCR50	NSYCMUCR80
	7 Rotating fixing in bracket on enclosure	NSYCMUCC50	NSYCMUCC80
	8 Tilting fixing on enclosure	NSYCMUCP50	NSYCMUCP80 (1)

* Enclosure equipped with a cable gland plate.

(1) Installation on an enclosure D300 requires plate ref. NSYCMUCPAD87 (see page 512).

Technical changes reserved. Information provided without guarantee. Images are for illustrative purposes only.

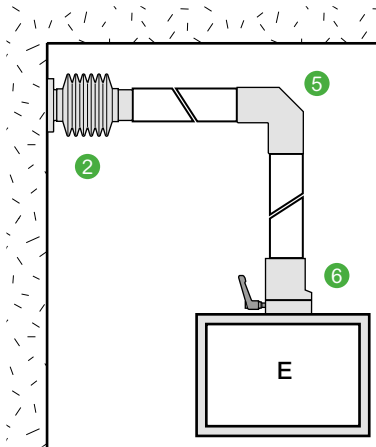

Fixing on support
2 See page 511

Inter-tube fitting
5 See page 512

Fixing on enclosure
6 See page 512

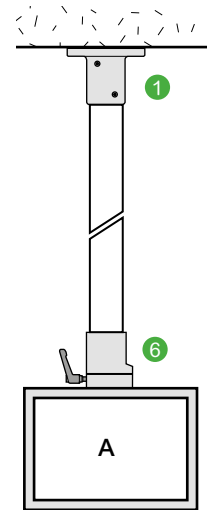

Fixing on support
1 See page 511

Inter-tube fitting

Fixing on enclosure
6 See page 512

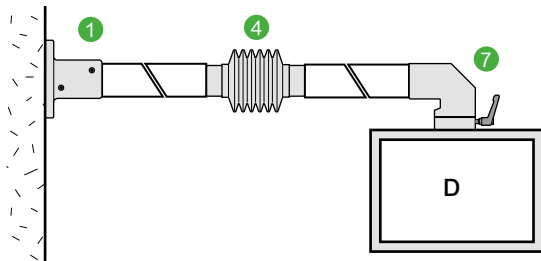

Fixing on support
1 See page 511

Inter-tube fitting
4 See page 511

Fixing on enclosure
7 See page 512

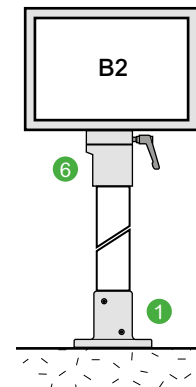

Fixing on support
1 See page 511

Inter-tube fitting

Fixing on enclosure
6 See page 512

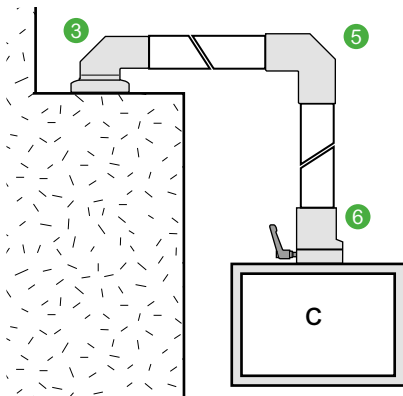

Fixing on support
3 See page 511

Inter-tube fitting
5 See page 512

Fixing on enclosure
6 See page 512

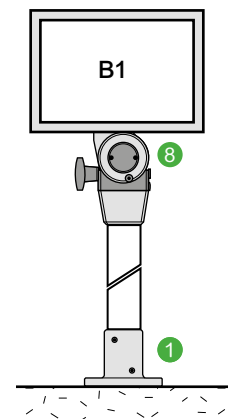

Fixing on support
1 See page 511

Inter-tube fitting

Fixing on enclosure
8 See page 512

Spacial S3CM

The control enclosures consist of:

A steel body equipped with:

- Reinforcement plate: The top wall is reinforced by a plate (3 mm) and pierced with a hole Ø 54 or 87 mm (according to the reference) to allow hanging installation of the enclosure,
- 4 welded studs on the 2 inner vertical walls, for fixing the rails,
- 2 rails (with drill holes) for installing equipment,
- A rear door, opening to 120° and closing with double-bar lock.

⁽¹⁾ Enclosure equipped with a cable gland plate

An aluminum front face (2.5 mm thick):

- This surface is protected on both sides by a plastic film, allowing the installation of the dialogue elements,
- A trim frame made from 4 extruded-aluminum rails.
- Structured finish, epoxy polyester powder, RAL 7040 grey color (other colors on demand).
- The design of these rails takes into account the accessory mounting functions (lamp, document support, keyboard support, laptop support, etc.), the ergonomics for handling the enclosure and its overall aesthetics.
- Finish: Structured finish, epoxy polyester powder
- Color: RAL 7035 grey
- Ingress protection rating: IP54 according to IEC 60529
- Mechanical protection rating: IK10 according to IEC 62262
- UL (cULus) certification with rating 1, 2, 3R, 12 and 13 according to UL50E

For more details see [page 532](#)



NSYS3CM303020

Characteristics	Enclosure load (kg)	Tube section (mm)	Height (mm)	Width (mm)	Depth (mm)	References
HMI encl. Spacial S3CM	8.6	50	300	300	200	NSYS3CM303020
HMI encl. Spacial S3CM	9.5	50	300	400	200	NSYS3CM304020
HMI encl. Spacial S3CM	11.4	50	400	400	200	NSYS3CM404020
HMI encl. Spacial S3CM ⁽¹⁾	17.9	50	400	600	250	NSYS3CM406025
HMI encl. Spacial S3CM	20.2	50	500	500	250	NSYS3CM505025
HMI encl. Spacial S3CM ⁽¹⁾	26.5	50	600	600	200	NSYS3CM606020
HMI encl. Spacial S3CM	34.9	80	600	800	300	NSYS3CM608030
HMI encl. Spacial S3CM ⁽¹⁾	33.6	80	800	600	300	NSYS3CM806030

Human-Machine Interface - specific accessories

Box keyboard for control enclosure

- The box is installed on the control enclosures with a width of 600 mm. It then has an angle of 120° with its front face. All the accessories required for installation are delivered with 2 brackets and 1 trim rail, 1 hose for cable entry.

The box consists of:

- A steel body, structured finish, epoxy polyester powder, RAL 7035 grey color, with a screwed cover, an aluminum front face (2.5 mm thick) for installing a keyboard,

- A trim frame made from 2 extruded-aluminum rails guaranteeing ergonomic handling of the box and the aesthetics of the unit. The frame and the front face are delivered assembled. Structured finish, epoxy polyester powder painting, RAL 7040 grey color.
- Ingress protection rating: IP54
- Mechanical protection rating: IK10
- Weight: 8 kg

For more details see [page 533](#)



NSYCMT2560110

Characteristics	Height (mm)	Width (mm)	References
Box-keyboard for control enclosure	250	600	NSYCMT2560110

Support

- Installation on the left or right rail of the frame of the control enclosure.
- Material: Sheet steel
- Finish: Structured finish, epoxy polyester powder
- Color: RAL 7035 grey
- Thickness: 15/10° mm

For more details see [page 533](#)



NSYCMBPT

Characteristics	References
Support for Keyboard	NSYCMBPT

Tube

The tubes are available in:

- 2 sizes: Square of 50 and 80 mm,
- 4 lengths: 0.5, 1, 1.5 and 2 m
- Material: Extruded steel
- Finish: structured finish, powder
- Color: RAL 7035 grey
- Thickness: 40/10° mm



NSYCMT5005

Characteristics	Square (mm)	Length (m)	Weight (kg/m)	References
Tube	50	0.5	6.5	NSYCMT5005
Tube	50	1	6.5	NSYCMT5010
Tube	50	1.5	6.5	NSYCMT5015
Tube	50	2	6.5	NSYCMT5020
Tube	80	0.5	10.5	NSYCMT8005
Tube	80	1	10.5	NSYCMT8010
Tube	80	1.5	10.5	NSYCMT8015
Tube	80	2	10.5	NSYCMT8020

Fixed base

- Support foot for direct horizontal or vertical connection.
- Material: Molded steel
- Color: RAL 7040 grey

For more details see [page 540](#)



NSYCMUMR50

Characteristics	Square (mm)	Weight (kg)	References
Fixed base	50	3.25	NSYCMUMR50
Fixed base	80	7	NSYCMUMR80

Wall fixing with joint

- Device allowing rotation through 170° of a horizontal tube, with a square section of 50 or 80 mm, and its fixing on a vertical surface.
- Protection by bellows, RAL 7035 grey color.
- Option of passing cables through the inside of the joint.
- Material: Molded steel
- Color: RAL 7040 grey

For more details see [page 540](#)



NSYCMUMA50

Characteristics	Square (mm)	Weight (kg)	References
Wall fixing with joint	50	4.35	NSYCMUMA50
Wall fixing with joint	80	9.45	NSYCMUMA80

Rotating straight fitting

- Device allowing the fixing and rotation through 295° of tubes, with a square section of 50 or 80 mm, in horizontal position.
- Without blocking the chosen position.
- Fixing by 4 screws, not included.
- Material: Molded steel
- Color: RAL 7040 grey

For more details see [page 540](#)



NSYCMUMC50

Characteristics	Square (mm)	Weight (kg)	References
Rotating straight fitting	50	5.4	NSYCMUMC50
Rotating straight fitting	80	15.7	NSYCMUMC80

Horizontal inter-tube joint

- Device allowing the linking and rotation through 170° of 2 horizontal tubes, with a square section of 50 or 80 mm.
- Protection by bellows, RAL 7035 grey color.
- Option of passing cables through the inside of the joint.
- Material: Molded steel
- Color: RAL 7040 grey

For more details see [page 540](#)



NSYCMUIA50

Characteristics	Square (mm)	Weight (kg)	References
Horizontal inter-tube joint	50	4.25	NSYCMUIA50
Horizontal inter-tube joint	80	10	NSYCMUIA80

Adapter part for enclosure D300 / Ø 80 mm



NSYCMUCPAD87

Characteristics	Square (mm)	Weight (kg)	References
Adapter part for enclosure D300 / Ø 80 mm	80	0.5	NSYCMUCPAD87

Fixed bracket



NSYCMUTC50

- Our system of tubes and joints, fixed or rotating, enables all the solutions to respond to the installation needs of the control enclosures for human-machine dialogue.
- Device allowing the combination and fixing of a horizontal tube with a vertical tube.
- Material: Aluminum
- Color: RAL 7040 grey

For more details see [page 541](#)

Characteristics	Square (mm)	Weight (kg)	References
Fixed bracket	50	1.35	NSYCMUTC50
Fixed bracket	80	2.4	NSYCMUTC80

Rotating fixing on enclosure



NSYCMUCR50

- Device allowing the fixing and rotation through 300° of tubes, with a square section of 50 or 80 mm, in vertical position.
- System for blocking in the chosen position.
- Fixing through the support surface by 4 screws.
- Material: Aluminum
- Color: RAL 7040 grey

For more details see [page 541](#)

Characteristics	Square (mm)	Weight (kg)	References
Rotating fixing on enclosure	50	1.25	NSYCMUCR50
Rotating fixing on enclosure	80	3.1	NSYCMUCR80

Rotating fixing in bracket on enclosure



NSYCMUCC50

- Devices allowing the fixing and rotation through 300° of tubes, with a square section of 50 or 80 mm, in horizontal position.
- System for blocking in the chosen position.
- Fixing through the support surface by 4 screws.
- Material: Aluminum
- Color: RAL 7040 grey

For more details see [page 541](#)

Characteristics	Square (mm)	Weight (kg)	References
Rotating fixing in bracket on enclosure	50	2	NSYCMUCC50
Rotating fixing in bracket on enclosure	80	6.55	NSYCMUCC80

Tilting fixing on enclosure



NSYCMUCP50

- This fixing allows the enclosures to be tilted up to 30°.
- System for blocking in the chosen position.
- It is installed on enclosures with depths of 200 and 250 mm.
- The installation on enclosures with a depth of 300 mm requires an adapter plate.
- Material: Aluminum + PA
- Color: RAL 7040 grey + PA black

For more details see [page 541](#)

Characteristics	Square (mm)	Weight (kg)	References
Tilting fixing on enclosure	50	2.98	NSYCMUCP50
Tilting fixing on enclosure	80	3.10	NSYCMUCP80

Adapter for signalling beacon



NSYCMACS50

- It is installed on fixed brackets ref. NSYCMUTC50 and NSYCMUTC80.
- Material: Aluminum.
- Finish: Structured finish, powder.
- Color: RAL 7040 grey

For more details see [page 541](#)

Characteristics	Square (mm)	Weight (kg)	References
Adapter for signalling beacon	50	0.025	NSYCMACS50
Adapter for signalling beacon	80	0.08	NSYCMACS80

The range of **Spacial SD** control desks provides all functions required of a workstation intended for industrial and infrastructure applications.

This range can be configured according to your needs

4 different services available:



Assemble to order



Mounting of standard accessories



Painting



Machining



Steel control desks



Accessibility

There are two versions of the Compact control desk:

- Front accessibility: Designed for straight-forward solutions.
- Front and rear accessibility through a removable panel: Enables the installation of two adjoining plates and to work at the rear. The control desk with console offers full accessibility since it is fully accessible from the rear thanks to the 3-point locking system door it includes. For Spacial SD, the accessibility which allows quick and easy work is one of its main priorities. For this reason, its design excludes the central upright.



Convenience

The option of connecting the modular control desk to the modular consoles affords multiple combinations. The opening direction of the door can be changed quickly thanks to the included hinges.



Ease of use

The console opens easily and safely thanks to the installed pneumatic opening lid stays. Cable entry is optimized because all the models of the range include a cable gland plate with two adjustable parts.



Compatibility

Furthermore, the Spacial SD control desk is compatible with most of the accessories of the Spacial SF and SM ranges.

See page 546 for details or consult our web site www.se.com

The combination of a monobloc control desk with one or more consoles enables all combinations. Complete accessibility to the inside of the control desk thanks to its design without intermediate crossbars.

This range can be configured according to your needs

4 different services available:



Assemble to order



Mounting of standard accessories



Painting



Machining



Examples of combinations

Consoles and control desks

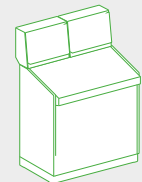
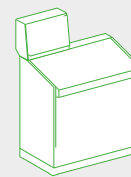
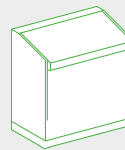

Multiple combinations available.

Stainless-steel control desks

11



Hygiene

The high quality of the standard finish enables very easy maintenance while avoiding contamination. The hygienic feet made from 316L stainless-steel, adjustable between 140 mm and 200 mm height, make it easier to clean under the enclosures.



Compatibility with other ranges

Stainless-steel accessories:

- Plinths, locks.
- Accessories of the steel control desks offer:**
- Mounting plate, pneumatic opening stay, etc.



Resistance to corrosion

High resistance to corrosion. 304L and 316L stainless-steel provide the best solutions for applications in extremely demanding environments.



Convenience

The desk lid and the console are equipped with pneumatic opening stays (opening to 75°) allowing complete access to the inside and preventing sudden falls of the console or the hinged cover. Equipped with adjustment rails for adjusting the depth of the mounting plate. Removable rear panel.

See page 546 for details or consult our web site www.se.com

Compact control desk



- This range is available in 4 widths with fixed rear panel.
- Full accessibility is provided from the front (no central upright).
- Easy removable and reversible door opening to 120°.
- Locking by 3 mm doublebar lock (other inserts or cylinders also available, to be ordered separately, see [page 522](#)).
- Desk lid equipped with a pneumatic opening stay.
- Opens to 75°. Perforated reinforcement rails with a pitch of 25 mm.
- Control desk equipped with adjustment rails with a pitch of 25 mm and brackets allowing adjustment of the mounting plate depth.
- Cable gland plate with 2 adjustable parts, with polyurethane gasket.
- M8 x 18 mm earthing screw for equipotential connection between the door and the body.
- Material: Welded folded steel
- Finish: Structured finish, epoxy polyester powder
- Color: RAL 7035 grey
- Thickness: 15/10° mm
- Ingress protection rating according to IEC 60529: IP55
- Mechanical protection rating according to IEC 62262: IK10

Options:
It can also be equipped with a mounting plate, see [page 523](#)

For more details see [page 536](#)

Characteristics	No. doors	Width (mm)	Height (mm)	Depth (mm)	References
Compact control desk	1	600	1000	469	NSYS D6
Compact control desk	1	800	1000	469	NSYS D8
Compact control desk	2	1000	1000	469	NSYS D10
Compact control desk	2	1200	1000	469	NSYS D12

Control desk with console



- Full accessibility is provided from the front and rear.
- Easy removable and reversible front door, opening to 120°.
- Locking by two-point locks with 3-mm double-bar insert.
- Desk lid equipped with a pneumatic opening stay. Opens to 75°.
- Perforated reinforcement rails with a pitch of 25 mm for quick installation of cables and cable ducts.
- Locking by two-point locks with 3-mm double-bar insert.
- Hinged console cover equipped with a pneumatic opening stay.
- Opens to 75°.
- Locking by two-point locks with 3-mm double-bar insert.
- Easy removable and reversible rear door, opening to 120°.
- Locking by three-point lock with flat escutcheon, 5-mm double-bar insert.
- One entry cable gland plate, with polyurethane gasket.
- Control desk equipped with adjustment rails with a pitch of 25 mm and brackets allowing adjustment of the mounting plate depth.
- M8 x 18 mm earthing screw for equipotential connection between the door and the body.
- Material: Welded folded steel
- Finish: Structured finish, epoxy polyester powder
- Color: RAL 7035 grey
- Thickness: 15/10° mm
- Ingress protection rating according to IEC 60529: IP55
- Mechanical protection rating according to IEC 62262: IK10

Options:
Plinth options see [page 521](#).
It can also be equipped with a mounting plate, see [page 523](#).
Locking system: Other inserts or cylinders also available, see [page 522](#).
The console can support the installation of a 14" display with an optional PC support plate, see [page 523](#).

For more details see [page 536](#)

Characteristics	No. Front doors	No. Rear doors	No. cable gland plates	Width (mm)	Height (mm)	Depth (mm)	References
Control desk with console	1	1	1	800	1400	845	NSYS DF88
Control desk with console	1	1	1	800	1400	1045	NSYS DF810
Control desk with console	2	2	1	1000	1400	845	NSYS DF108
Control desk with console	2	2	1	1000	1400	1045	NSYS DF1010
Control desk with console	2	2	1	1200	1400	845	NSYS DF128
Control desk with console	2	2	1	1200	1400	1045	NSYS DF1210
Control desk with console	2	2	2	1600	1400	845	NSYS DF168
Control desk with console	2	2	2	1600	1400	1045	NSYS DF1610

SD Compact control desk with rear panel

- Removable rear panel. It enables the installation of two mounting plates back-to-back, allowing the installation of a large number of devices, while ensuring full accessibility from the front and the rear.
- At the top, these control desks are equipped with cable entry cut-outs, that allows the installation of one or more modular consoles.
- Easy removable and reversible door, opening to 120°.
- Locking by 3 mm doublebar lock (other inserts or cylinders also available, to be ordered separately, see [page 522](#)).
- Desk lid equipped with a pneumatic opening stay.
- Opens to 75°. Perforated reinforcement rails with a pitch of 25 mm.
- Top cable entry cut-outs covered by a entire blanking cover.
- Control desk equipped with adjustment rails with a pitch of 25 mm and brackets allowing adjustment of the mounting plate depth.
- Cable gland plate with 2 adjustable parts, with polyurethane gasket.
- M8 x 18 mm earthing screw for equipotential connection between the door and the body.
- Material: Welded folded steel
- Finish: Structured finish, epoxy polyester powder paint
- Color: RAL 7035 grey
- Thickness: 15/10° mm
- Ingress protection rating according to IEC 60529: IP55
- Mechanical protection rating according to IEC 62262: IK10



NSYSD6R

Options:

Modular consoles to be installed on top of compact control desk. See details and combinations [page 517](#). It can also be equipped with a mounting plate, see [page 523](#).

For more details see [page 537](#)

Characteristics	No. doors	Width (mm)	Height (mm)	Depth (mm)	References
Compact control desk with rear panel	1	600	1000	600	NSYSD6R
Compact control desk with rear panel	1	800	1000	600	NSYSD8R
Compact control desk with rear panel	2	1000	1000	600	NSYSD10R
Compact control desk with rear panel	2	1200	1000	600	NSYSD12R

SDX Compact control desk with rear panel

- Removable rear panel. It enables the installation of two mounting plates back-to-back, allowing the installation of a large number of devices, while ensuring full accessibility from the front and the rear.
- At the top, these control desks are equipped with cable entry cut-outs, that allows the installation of one or more modular consoles.
- Easy removable and reversible door, opening to 120°.
- Locking by 3 mm doublebar lock (other inserts or cylinders also available, to be ordered separately, see [page 522](#)).
- Desk lid equipped with a pneumatic opening stay.
- Opens to 75°. Perforated reinforcement rails with a pitch of 25 mm.
- Top cable entry cut-outs covered by a entire blanking cover.
- Control desk equipped with adjustment rails with a pitch of 25 mm and brackets allowing adjustment of the mounting plate depth.
- Cable gland plate with 2 adjustable parts, with polyurethane gasket.
- M8 x 18 mm earthing screw for equipotential connection between the door and the body.
- Material: 304L stainless-steel
- Finish: Scotch-Brite® brushed finish
- Thickness: 15/10° mm
- Ingress protection rating according to IEC 60529: IP55
- Mechanical protection rating according to IEC 62262: IK10



NSYSDX6

Options:

Stainless-steel modular consoles to be installed on top of compact control desk. See details and combinations [page 517](#). It can also be equipped with a mounting plate, see [page 523](#).

For more details see [page 537](#)

Characteristics	No. doors	Width (mm)	Height (mm)	Depth (mm)	References
Compact control desk with rear panel	1	600	1000	500	NSYSDX6
Compact control desk with rear panel	1	800	1000	500	NSYSDX8
Compact control desk with rear panel	2	1000	1000	500	NSYSDX10
Compact control desk with rear panel	2	1200	1000	500	NSYSDX12

SD Modular consoles

- Hinged modular console cover equipped with a pneumatic opening stay.
- Opens to 75°. Locking of the hinged modular console cover by two 3-mm double-bar locks (other inserts or barrels also available, to be ordered separately, see [page 522](#)).
- Screw fixed rear panel equipped with step slides in the version with a depth of 300 mm.
- Material: Welded folded steel
- Finish: Structured finish, epoxy polyester powder
- Color: RAL 7035 grey
- Thickness: 15/10^e mm
- Ingress protection rating: IP55 according to IEC 60529
- Mechanical protection rating: IK10 according to IEC 62262

Options:

The link between the control desk and the modular console requires, in certain cases, the addition of one or several blanking covers (to be ordered separately).
Optional galvanized mounting plate.



NSYSDC42

Characteristics	No. of cable entry cut-outs	Width (mm)	Height (mm)	Depth (mm)	References
Modular consoles	2	400	483	200	NSYSDC42
Modular consoles	2	400	483	300	NSYSDC43
Modular consoles	3	600	483	200	NSYSDC62
Modular consoles	3	600	483	300	NSYSDC63

SDX Modular consoles

- Hinged modular console cover equipped with a pneumatic opening stay.
- Opens to 75°. Locking of the hinged modular console cover by two 3-mm double-bar locks (other inserts or barrels also available, to be ordered separately, see [page 522](#)).
- Screw fixed rear panel equipped with step slides in the version with a depth of 300 mm.
- Material: 304L stainless-steel
- Finish: Scotch-Brite® brushed finish
- Thickness: 15/10^e mm
- Ingress protection rating: IP55 according to IEC 60529
- Mechanical protection rating: IK10 according to IEC 62262

Options:

The link between the control desk and the modular console requires, in certain cases, the addition of one or several blanking covers (to be ordered separately).
Optional galvanized mounting plate.



NSYSDCX42

Characteristics	No. of cable entry cut-outs	Width (mm)	Height (mm)	Depth (mm)	References
Modular consoles	2	400	483	200	NSYSDCX42
Modular consoles	2	400	483	300	NSYSDCX43
Modular consoles	3	600	483	200	NSYSDCX62
Modular consoles	3	600	483	300	NSYSDCX63

SD Blanking cover

- To conceal the free space of the control desk when the width of the console or consoles is less than the width of the control desk.
- In any case, it is necessary to first remove the top plate delivered with the control desk.
- Material: Steel
- Finish: Structured finish, epoxy polyester powder
- Color: RAL 7035 grey
- Thickness: 15/10^e mm
- Fixing: Fixing by screws



NSYRP2

Characteristics	Width (mm)	Height (mm)	References
Blanking cover	200	40	NSYRP2

SDX Blanking cover

- To conceal the free space of the control desk when the width of the console or consoles is less than the width of the control desk.
- In any case, it is necessary to first remove the top plate delivered with the control desk.
- Material: 304L stainless-steel
- Thickness: 15/10^e mm
- Fixing: Fixing by screws



NSYRPX2

Characteristics	Width (mm)	Height (mm)	References
Blanking cover	200	40	NSYRPX2

Mounting plates for modular consoles

- Steel mounting plates can be installed at the back of modular consoles (F).
- Material: 304L Galvanized Steel

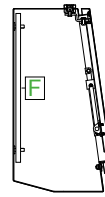

Example installation of a mounting plate in a console depth 200 mm.

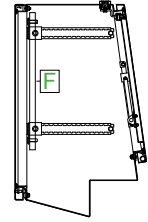

Example installation of a mounting plate in a console depth 300 mm.



NSYMM44

Characteristics	Modular console		Fixing center-to-center distance (mm)		References
	Width (mm)	Height (mm)	Width (mm)	Height (mm)	
Mounting plate	400	325	325	325	NSYMM44
Mounting plate	600	625	325	325	NSYMM64

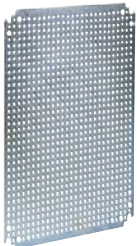

NSYMF44

Characteristics	Modular console		Fixing center-to-center distance (mm)		References
	Width (mm)	Height (mm)	Width (mm)	Height (mm)	
Mounting plate Microperforated	400	325	325	325	NSYMF44
Mounting plate Microperforated	600	625	325	325	NSYMF64



NSYMR44

Characteristics	Modular console		Fixing center-to-center distance (mm)		References
	Width (mm)	Height (mm)	Width (mm)	Height (mm)	
Mounting plate Telequick	400	325	325	325	NSYMR44
Mounting plate Telequick	600	625	325	325	NSYMR64

Combination examples of modular consoles installation		Compact control desk		Modular console		Blanking cover	
600		Spacial SD	Spacial SDX	Spacial SD	Spacial SDX	Spacial SD	Spacial SDX
		NSYSD6R	NSYSDX6	NSYSDC42 / NSYSDC43	NSYSDCX42 / NSYSDCX43	NSYRP2	NSYRPX2
		NSYSD6R	NSYSDX6	NSYSDC62 / NSYSDC63	NSYSDCX62 / NSYSDCX63	-	-
800		Spacial SD	Spacial SDX	Spacial SD	Spacial SDX	Spacial SD	Spacial SDX
		NSYSD8R	NSYSDX8	NSYSDC42 / NSYSDC43	NSYSDCX42 / NSYSDCX43	2 x NSYRP2	2 x NSYRPX2
		NSYSD8R	NSYSDX8	2 x NSYSDC42 / 2 x NSYSDC43	2 x NSYSDCX42 / 2 x NSYSDCX43	-	-
		NSYSD8R	NSYSDX8	NSYSDC62 / NSYSDC63	NSYSDCX62 / NSYSDCX63	NSYRP2	NSYRPX2
1000		Spacial SD	Spacial SDX	Spacial SD	Spacial SDX	Spacial SD	Spacial SDX
		NSYSD10R	NSYSDX10	NSYSDC42 / NSYSDC43	NSYSDCX42 / NSYSDCX43	3 x NSYRP2	3 x NSYRPX2
		NSYSD10R	NSYSDX10	NSYSDC62 / NSYSDC63	NSYSDCX62 / NSYSDCX63	2 x NSYRP2	2 x NSYRPX2
		NSYSD10R	NSYSDX10	NSYSDC62 / NSYSDC63	NSYSDCX62 / NSYSDCX63	2 x NSYRP2	2 x NSYRPX2
		NSYSD10R	NSYSDX10	NSYSDC42 + NSYSDC62 / NSYSDC43 + NSYSDC63	NSYSDCX42 + NSYSDCX62 / NSYSDCX43 + NSYSDCX63	-	-
1200		Spacial SD	Spacial SDX	Spacial SD	Spacial SDX	Spacial SD	Spacial SDX
		NSYSD12R	NSYSDX12	NSYSDC42 / NSYSDC43	NSYSDCX42 / NSYSDCX43	4 x NSYRP2	4 x NSYRPX2
		NSYSD12R	NSYSDX12	NSYSDC62 / NSYSDC63	NSYSDCX62 / NSYSDCX63	3 x NSYRP2	3 x NSYRPX2
		NSYSD12R	NSYSDX12	NSYSDC62 / NSYSDC63	NSYSDCX62 / NSYSDCX63	3 x NSYRP2	3 x NSYRPX2
		NSYSD12R	NSYSDX12	2 x NSYSDC62 / 2 x NSYSDC63	2 x NSYSDCX62 / 2 x NSYSDCX63	-	-
		NSYSD12R	NSYSDX12	NSYSDC42 + NSYSDC62 / NSYSDC43 + NSYSDC63	NSYSDCX42 + NSYSDCX62 / NSYSDCX43 + NSYSDCX63	NSYRP2	NSYRPX2

Technical changes reserved. Information provided without guarantee. Images are for illustrative purposes only.

Floor





Front and rear plinth



Characteristics	NSYSPPF6100	NSYSPFX6100
	<ul style="list-style-type: none"> The front and rear of the plinth consists of 4 corners with 2 or 4 panels. 	
Material	Folded sheet steel, corner with a thickness of 25/10e mm	304L stainless-steel
Finish	Painted with epoxy polyester resin	-
Color	RAL 7022 grey	-
Ingress protection rating	IP30	IP30
Mechanical protection rating	IK10	IK10
Supply	<ul style="list-style-type: none"> Height 100 mm: 4 corners, 2 panels (front and rear), 4 corner covers and fixing elements Height 200 mm: 4 corners, 4 panels (2 front and 2 rear), 4 corner covers and fixing elements The use of 304L stainless-steel plinths on an SD control desk requires an earthing cable reference NSYEL226D13 (description page 323) to be ordered separately. 	

Control desk references	Plinths references			
Compact control desks with fixed rear panel	100 mm	200 mm	100 mm	200 mm
References	References	References	References	References
 NSYSD6	NSYSPPF6100	NSYSPPF6200	NSYSPPFX6100	NSYSPPFX6200
NSYSD8	NSYSPPF8100	NSYSPPF8200	NSYSPPFX8100	NSYSPPFX8200
NSYSD10	NSYSPPF10100	NSYSPPF10200	NSYSPPFX10100	NSYSPPFX10200
NSYSD12	NSYSPPF12100	NSYSPPF12200	NSYSPPFX12100	NSYSPPFX12200

Compact control desks with removable rear panel Sheet steel	100 mm	200 mm	100 mm	200 mm
 NSYSD6R	NSYSPPF6100	NSYSPPF6200	NSYSPPFX6100	NSYSPPFX6200
NSYSD8R	NSYSPPF8100	NSYSPPF8200	NSYSPPFX8100	NSYSPPFX8200
NSYSD10R	NSYSPPF10100	NSYSPPF10200	NSYSPPFX10100	NSYSPPFX10200
NSYSD12R	NSYSPPF12100	NSYSPPF12200	NSYSPPFX12100	NSYSPPFX12200

Compact control desks with removable rear panel Stainless-steel	100 mm	200 mm	100 mm	200 mm
 NSYSDX6	-	-	NSYSPPFX6100	NSYSPPFX6200
NSYSDX8	-	-	NSYSPPFX8100	NSYSPPFX8200
NSYSDX10	-	-	NSYSPPFX10100	NSYSPPFX10200
NSYSDX12	-	-	NSYSPPFX12100	NSYSPPFX12200

Control desk with console	100 mm	200 mm	100 mm	200 mm
 NSYSDF88	NSYSPPF8100	NSYSPPF8200	-	-
NSYSDF108	NSYSPPF10100	NSYSPPF10200	-	-
NSYSDF128	NSYSPPF12100	NSYSPPF12200	-	-
NSYSDF168	NSYSPPF16100	NSYSPPF16200	-	-
NSYSDF810	NSYSPPF8100	NSYSPPF8200	-	-
NSYSDF1010	NSYSPPF10100	NSYSPPF10200	-	-
NSYSDF1210	NSYSPPF12100	NSYSPPF12200	-	-
NSYSDF1610	NSYSPPF16100	NSYSPPF16200	-	-



Plinth side panels



NSYSPSX5100

NSYSPS4100SD

- They are fixed to the corner of the plinth by 2 fixing screws.

Folded sheet steel

Painted with epoxy polyester resin

RAL 7022 grey

IP30

IK10

304L stainless-steel

-

-

IP30

IK10

- Height 100 mm: 2 side panels, 4 corner covers and fixing elements
- Height 200 mm: 4 side panels (height of 100 mm, 2 for each side), 4 corner covers and fixing elements
- The use of 304L stainless-steel plinths on an SD control desk requires an earthing cable reference **NSYEL226D13** (description [page 323](#)) to be ordered separately.

100 mm	200 mm	100 mm	200 mm
References	References	References	References
NSYSPS4100SD	NSYSPS4200SD	NSYSPSX5100	NSYSPSX5200
NSYSPS4100SD	NSYSPS4200SD	NSYSPSX5100	NSYSPSX5200
NSYSPS4100SD	NSYSPS4200SD	NSYSPSX5100	NSYSPSX5200
NSYSPS4100SD	NSYSPS4200SD	NSYSPSX5100	NSYSPSX5200
100 mm	200 mm	100 mm	200 mm
NSYSPS5100SD	NSYSPS5200SD	NSYSPSX5100	NSYSPSX5200
NSYSPS5100SD	NSYSPS5200SD	NSYSPSX5100	NSYSPSX5200
NSYSPS5100SD	NSYSPS5200SD	NSYSPSX5100	NSYSPSX5200
NSYSPS5100SD	NSYSPS5200SD	NSYSPSX5100	NSYSPSX5200
100 mm	200 mm	100 mm	200 mm
-	-	NSYSPSX5100	NSYSPSX5200
-	-	NSYSPSX5100	NSYSPSX5200
-	-	NSYSPSX5100	NSYSPSX5200
-	-	NSYSPSX5100	NSYSPSX5200
100 mm	200 mm	100 mm	200 mm
NSYSPS4100SD	NSYSPS4200SD	-	-
NSYSPS4100SD	NSYSPS4200SD	-	-
NSYSPS4100SD	NSYSPS4200SD	-	-
NSYSPS4100SD	NSYSPS4200SD	-	-
NSYSPS6100SD	NSYSPS6200SD	-	-
NSYSPS6100SD	NSYSPS6200SD	-	-
NSYSPS6100SD	NSYSPS6200SD	-	-
NSYSPS6100SD	NSYSPS6200SD	-	-

Door

Pneumatic opening stay

- Holds the desk lid in open position at an angle of 75°.



Nominal load per stay (N)	Max. load on lid (kg)	Control desk references				Standard supply stay
		With fixed rear panel References	With removable rear panel Sheet steel References	With removable rear panel Stainless-steel References	With console References	
244	13	NSYS6	NSYS6R	NSYS6X	NSYSDF88	NSYPLS24
244	13	NSYS8	NSYS8R	NSYS8X	NSYSDF810	NSYPLS24
300	11	-	-	-	NSYSDF168	NSYPLS30
300	11	-	-	-	NSYSDF1610	NSYPLS30
300	15	NSYS12	NSYS12R	NSYS12X	NSYSDF128	NSYPLS30
300	15	-	-	-	NSYSDF1210	NSYPLS30
300	17	NSYS10	NSYS10R	NSYS10X	NSYSDF108	NSYPLS30
300	17	-	-	-	NSYSDF1010	NSYPLS30

Pneumatic opening stay

- Holds the desk lid in open position at an angle of 75°.

Supply:
delivered with fixings

Characteristics	Nominal load per stay (N)	Max. load on lid (kg)	References
Pneumatic opening stay	244	13	NSYPLS24
Pneumatic opening stay	300	17	NSYPLS30

Shape inserts

Option to replace the standard shape insert:

- 8 mm triangular insert,
- 8 mm male square insert,
- 7 mm male square insert.
- Material: Zamack

Characteristics	References
8 mm triangular insert	NSYTT8CRN
8 mm male square insert	NSYTC8CRN
7 mm male square insert	NSYTC7CRN

Escutcheon with key lock

- Insert breakage torque: 15 daN.
- Material: Polyamide PA 6 material charged with 30% fiberglass
- Color: RAL 7011 grey
- Mechanical protection rating according to IEC 62262: IK10
- Fire resistance: 650 °C

Characteristics	References
405E key	NSYML405SD



Compact control desks

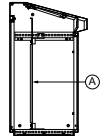

Characteristics	Width (mm)	Surface (dm ²)	References
Mounting plate plain	600	42	NSYPMP8560
Mounting plate plain	800	59	NSYPMP8580
Mounting plate plain	1000	76	NSYPMP85100
Mounting plate plain	1200	93	NSYPMP85120

Control desk with console

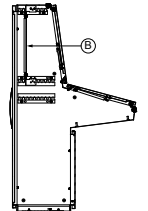

Characteristics	Width (mm)	Surface (dm ²)	References
Mounting plate plain	800	31	NSYPMP4580
Mounting plate plain	1000	40	NSYPMP45100
Mounting plate plain	1200	77	NSYPMP45120
Mounting plate plain	1600	67	NSYPMP45160

Control desk with console

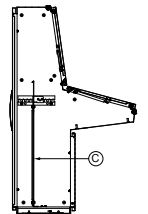

Characteristics	Width (mm)	Surface (dm ²)	References
Mounting plate plain	800	49	NSYPMP8580
Mounting plate plain	1000	63	NSYPMP85100
Mounting plate plain	1200	77	NSYPMP85120
Mounting plate plain	1600	105	NSYPMP85160

Compact control desks



NSYMP148

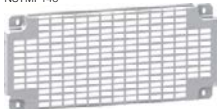

NSYSTMP6080

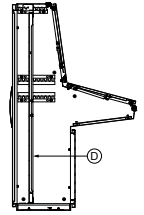

Characteristics	Width (mm)	Surface (dm ²)	References
Mounting plate plain	800	90	NSYMP148
Mounting plate plain	1000	116	NSYMP1410
Mounting plate plain	1200	142	NSYMP1412
Mounting plate Telequick (2 items needed)	800	84	NSYSTMP6080
Mounting plate Telequick (2 items needed)	1000	108	NSYSTMP60100
Mounting plate Telequick (2 items needed)	1200	132	NSYSTMP60120

Compact control desks



NSYSPMP4080

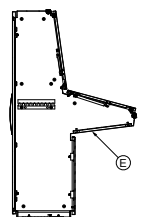

Characteristics	Width (mm)	Surface (dm ²)	References
Mounting plate plain	800	28	NSYSPMP4080
Mounting plate plain	1000	36	NSYSPMP40100
Mounting plate plain	1200	44	NSYSPMP40120
Mounting plate plain	1600	60	NSYSPMP40160

Fixing brackets

- Set of 4 fixing brackets.
- Depth adjustment on 25 mm pitch.
- Included as standard with desk (all versions).
- To be ordered separately when required for installation of two back-to-back mounting plates in control desks with rear access.
- Material: Galvanized steel
- Thickness: 40/10th mm
- Maximum load: 250 kg



NSYMPBSD

Characteristics	For desk width (mm)	References
Fixing brackets	600	NSYMPBSD
Fixing brackets	800	NSYMPBSD
Fixing brackets	1000	NSYMPBSD
Fixing brackets	1200	NSYMPBSD
Fixing brackets	1600	NSYMPBSD

Adjustment rails and fixing brackets

- Set of 4 rails and 4 fixing brackets.
- To install a plain mounting plate or a Telequick mounting plate, either at the top or across the height of the monobloc control desk with console.
- For positioning 2 plates (back-to-back), order fixing brackets ref. **NSYMPBSD**.



NSYMPB4SD

Characteristics	For control desks with console Depth (mm)	References
Adjustment rails and fixing brackets	400	NSYMPB4SD
Adjustment rails and fixing brackets	600	NSYMPB6SD

Technical uprights

- Set of 2 equipment uprights.
- Support for fixing Telequick mounting plates and rails.
- Material: Zinc-coated
- Thickness: 20/10° mm





Characteristics	For control desk height (mm)	Center-to-center distance (mm)	References
Technical uprights	1000	650	NSYTVR8
Technical uprights	1400	1250	NSYTVR14

The **Spacial SF** PC rack is designed to protect and control computer equipment in industrial environments.

This range can be configured according to your needs

4 different services available:

- 

Assemble to order
- 

Mounting of standard accessories
- 

Painting
- 

Machining



Steel PC racks

11

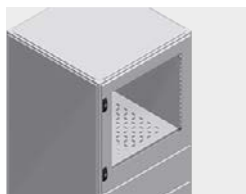

Convenience

- Anti-glare glazed door designed for viewing screens up to 25.5"
- Cable entry made easier by a two-piece cable-land plate.

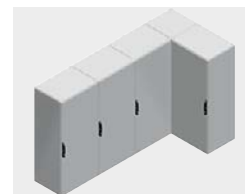

Simplicity

The Spacial SF design allows enclosures to be coupled in any direction, adapting to all installation surfaces.



Ergonomics

- Access to the various functions and working heights, guaranteeing optimal comfort.
- Partial doors delimit the access to each function with a 3-mm double-bar lock.
- Built-in display and CPU support.
- Built-in keyboard and mouse support.



Detail of 5 mm DB lock on rear door.

Locking system

- Locking system with flat escutcheon, made from polyamide 6 with 30% fiberglass, RAL 9005 black, with 5-mm double-bar insert for the plain rear door, and small flat escutcheon with 3 mm double-bar insert for the partial front doors.

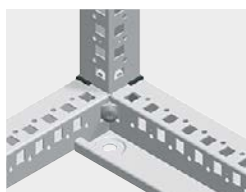

Robust

- Spacial SF structure formed from a single 1.5 mm galvanized steel section, with a high moment of inertia.
- Vertical uprights joined with top and bottom frames, screwed together with connections of sintered steel.
- Panels built into the structure.

See page 546 for details or consult our web site www.se.com

Spacial SF PC rack



NSYSF16660PC

- Partial door for PC display, with Securit® anti-glare glass.
- Plain partial door for CPU (enclosures with height of 1800 mm).
- Hinged plain door for keyboard.
- Plain partial door for optional installation of A4 printer support.
- Partial front doors opening to the right.
- Plain rear door, reversible opening direction (right or left).
- Roof and side panels fixed from the inside.
- Cable gland plate with 1 entry.
- Finish: Structured finish, epoxy polyester powder
- Color: RAL 7035 grey
- Ingress protection rating according to IEC 60529: IP40
- Mechanical protection rating according to IEC 62262: IK10
- Certifications: UL (cULus). Rated 1, 12 according to UL50E

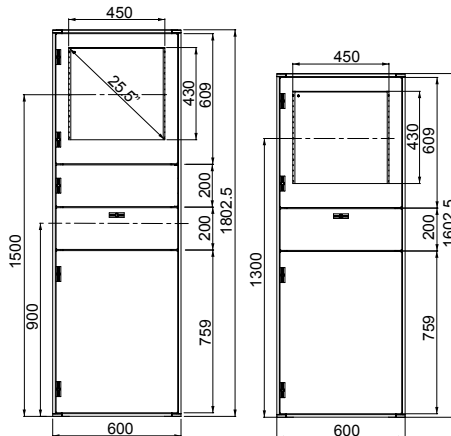

For more details see [page 537](#)

Characteristics	No. of compartments	Height (mm)	Width (mm)	Depth (mm)	References
Spacial SF PC rack	3	1600	600	600	NSYSF16660PC
Spacial SF PC rack	3	1600	600	800	NSYSF16680PC
Spacial SF PC rack	4	1800	600	600	NSYSF18660PC
Spacial SF PC rack	4	1800	600	800	NSYSF18680PC

Front and rear plinths



NSYSPF6100



NSYSPF6200

- The front and rear of the plinth consists of 4 corners with 2 or 4 panels.
- Material: Folded sheet steel, corner with a thickness of 25/10^o mm
- Finish: Structured finish, epoxy polyester powder
- Color: RAL 7022 grey
- Ingress protection rating: IP30 according to IEC 60529
- Mechanical protection rating: IK10 according to IEC 62262

Supply:

Height 100 mm: 4 corners, 2 panels (front and rear), 4 corner covers and fixing elements
 Height 200 mm: 4 corners, 4 panels (2 front and 2 rear), 4 corner covers and fixing elements

Characteristics	Height (mm)	Width (mm)	References
Front plinths for Spacial	100	600	NSYSPF6100
Front plinths for Spacial	200	600	NSYSPF6200

Plinth side panels



NSYSPS6100



NSYSPS6200

- They are fixed to the corner of the plinth by 2 fixing screws.
- Material: Folded sheet steel
- Finish: Structured finish, epoxy polyester powder
- Color: RAL 7022 grey
- Ingress protection rating: IP30 according to IEC 60529
- Mechanical protection rating: IK10 according to IEC 62262

Supply:

Height 100 mm: 2 side panels, 4 corner covers and fixing elements
 Height 200 mm: 4 side panels (height of 100 mm, 2 for each side), 4 corner covers and fixing elements

Characteristics	Height (mm)	Depth (mm)	References
Side plinths for Spacial	100	600	NSYSPS6100
Side plinths for Spacial	100	800	NSYSPS8100
Side plinths for Spacial	200	600	NSYSPS6200
Side plinths for Spacial	200	800	NSYSPS8200

Fixed Trays



NSYFXT6060

- Optional installation of a supplement fixed or telescopic tray directly on structure or on cross-rails.
- Acceptable load: 150 kg for fixed trays and 50 kg for telescopic rails, both evenly distributed.
- Installation: On structure / On cross-rails

For more details and other options on Mounting see [page 279](#).

Characteristics	Width (mm)	Depth (mm)	References
Fixed Tray	600	600	NSYFXT6060

Universal cross-rail 40 mm (1 row)



NSYSUCR4060

Characteristics	Enclosure Depth (mm)	References
Universal cross-rail 40 mm (1 row)	600	NSYSUCR4060
Universal cross-rail 40 mm (1 row)	800	NSYSUCR4080

Telescopic rails



NSYTTG60

Characteristics	Enclosure Depth (mm)	References
Telescopic rails	600	NSYTTG60
Telescopic rails	800	NSYTTG60

Handle for telescopic trays



NSY1TH

- Handle designed for easy extraction of the sliding trays.
- Material: Polyamide 6 (black)

Supply:

2 units and fixing elements

Characteristics	References
Handle for telescopic trays	NSY1TH

Locks for partial doors

Locks to replace the 3-mm double-bar lock supplied with the partial doors.

Models:

- Transformation of lock with shaped inserts, triangular 6.5 mm and square 6 mm.
- Lock with 2233X key for partial doors.
- Lock with 2233X key, exclusive for hinged keyboard door.

Supply:

Lock with shaped inserts, triangular 6.5 mm and square 6 mm: Metal body, shape insert and safety washer.

Lock with 2233X key for partial doors: metal body, insert, screw, safety washer and key.
 Lock with 2233X key, exclusive for hinged keyboard door: Metal body, insert, special screw, safety washer and key.



NSYMLT6

Characteristics	References
With 6.5 mm triangular insert for partial and hinged door	NSYMLT6
With 6 mm square insert for partial and hinged door	NSYMLS6
With 2233X key for partial door	NSYML23
With 2233X key for hinged keyboard door	NSYMLCD23

The stainless-steel monobloc PC racks have been especially designed to protect computer equipment installed in corrosive or specially environments that require washing or exposure to sprays of liquid.

This range can be configured according to your needs

4 different services available:



Assemble to order



Mounting of standard accessories



Painting



Machining



Stainless-steel monobloc PC racks



Convenience

- Anti-glare glazed door designed for viewing 14" and 17" displays by removing part of the silkscreen printing.
- Cable entry made easier by a cable gland plate (at the rear) in 2 pieces.



Ergonomics

- Partial doors delimit the access to each function with a 3-mm double-bar lock.
- Access to the various functions and working heights, guaranteeing optimal comfort.
- Built-in display and CPU support.
- Built-in mouse support.



Sealing

- IP55, even with the keyboard drawer open, thanks to the pivoting Plexiglas shutter.



Hygiene

- The high quality of the standard finish enables very easy maintenance while avoiding contamination.
- The hygienic feet made from 316L stainless-steel, adjustable between 140 mm and 200 mm height, make it easier to clean under the enclosures, ref. NSYPHX200. More information on [page 179](#).



Optional accessories

- Shelf mounted on telescopic rails.



Resistance to corrosion

- High resistance to corrosion. 304L and 316L stainless-steel provide the best solutions for applications in extremely demanding environments.

See [page 546](#) for details or consult our web site www.se.com

304L stainless-steel PC racks



NSYSMX16660PC

Composition

- Top and bottom partial doors on the front side.
- Pivoting panel for the keyboard.
- Plain rear door.

Monitor-display compartment

- The anti-glare glazed door is designed for viewing displays:
- 14" as standard, 17" by removing a part of the silkscreen printing.
- The height of the monitor support can be adjusted.
- The monitor shelf can withstand a maximum weight of 50 kg.

CPU / keyboard compartment

- The keyboard fixed to the inside becomes operational by tilting the central panel.
- The CPU is placed on a height-adjustable shelf, visible and accessible through a pivoting, transparent shutter.

Optional accessories

- Hygienic feet H 200 mm: **NSYPHX200**.
- Shelf installed on a sliding rail, with adjustable height.
- Telescopic tray: **NSYTTG60**.
- Material: Monobloc structure in 304L stainless-steel sheet, micro-beaded finish. Can be made in 316L stainless-steel on request
- Ingress protection rating according to IEC 60529: IP55, even with the keyboard drawer open
- Mechanical protection rating according to IEC 62262: IK10

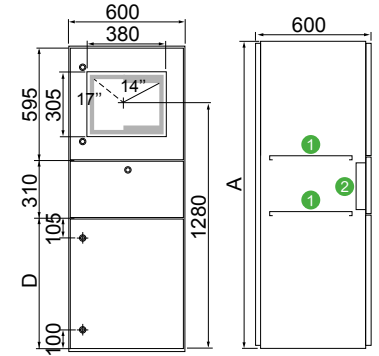

- A: 1600 / 1800
- B: 690 / 890
- ① Screwed shelf, adjustable height.
- ② Sealed case for keyboard.

Characteristics	Height (mm)	Width (mm)	Depth (mm)	References
304L stainless-steel PC racks	1600	600	600	NSYSMX16660PC
304L stainless-steel PC racks	1800	600	600	NSYSMX18660PC

Plinth

- Material: Stainless-steel, AISI 304L
- Finish: Scotch-Brite® brushing to guarantee the durability in applications where contact with the floor increases the risk of corrosion

Front and rear plinths



NSYSPFX6100

Supply:
4 corners, 2 panels (front and rear),
4 corner covers and fixing elements

Characteristics	Height (mm)	Width (mm)	References
Front and rear plinths	100	600	NSYSPFX6100

Side plinths



NSYSPSX6100

Supply:
2 side panels,
4 corner covers and fixing elements

Characteristics	Height (mm)	Depth	References
Side plinths	100	600	NSYSPSX6100

Front and rear plinths



NSYSPFX6200

Supply:
4 corners, 2 panels (front and rear),
4 corner covers and fixing elements

Characteristics	Height (mm)	Width (mm)	References
Front and rear plinths	200	600	NSYSPFX6200

Side plinths



NSYSPSX6200

Supply:
2 side panels,
4 corner covers and fixing elements

Characteristics	Height (mm)	Depth	References
Side plinths	200	600	NSYSPSX6200

HMI encl. Spacial S3CM

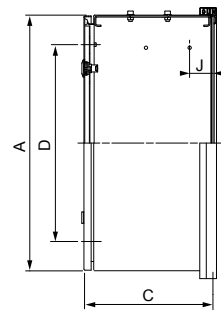
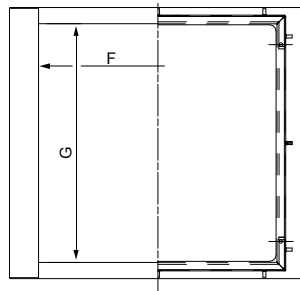

A: Height.
B: Width.
C: Depth.

W600 enclosure + box keyboard installation

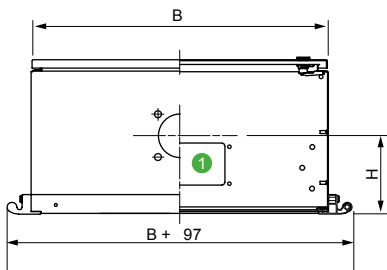

1 Cable gland plate.

Figure 1
Enclosure depth from 200 to 250

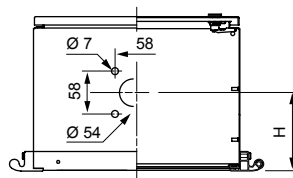
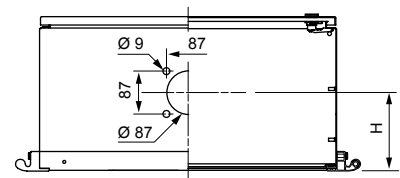

Figure 2
Enclosure depth 300



Enclosure dimensions (mm)								Cable gland plate	Ø Top hole (mm)	Fig.	Enclosure References
Height (mm)	Width (mm)	Depth (mm)	D	F	G	H	J				
300	300	200	162	262	262	100	45	-	54	1	NSYS3CM303020
300	400	200	162	362	262	100	45	-	54	1	NSYS3CM304020
400	400	200	262	362	362	100	45	-	54	1	NSYS3CM404020
400	600	250	262	562	362	125	75	●	54	1	NSYS3CM406025*
500	500	250	362	462	462	125	75	-	54	1	NSYS3CM505025
600	600	200	462	562	562	100	45	●	54	1	NSYS3CM606020*
600	800	300	462	762	562	150	100	-	87	2	NSYS3CM608030
800	600	300	662	562	762	150	100	●	87	2	NSYS3CM806030*

* Enclosure equipped with a cable gland plate.



Perforated rails installed on lateral studs.



Detail of the reinforcement plate.



Rear door with double-bar lock.



Fixing of the trim frame by screws.

Box keyboard for control enclosure

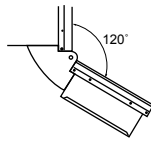
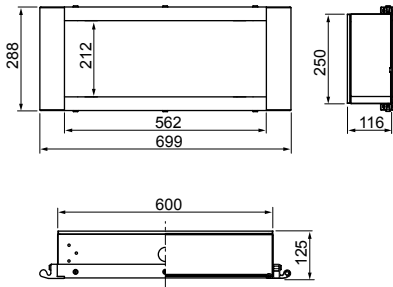

Detail from the installation of the box keyboard on the control enclosure.

Support



Laptop computer

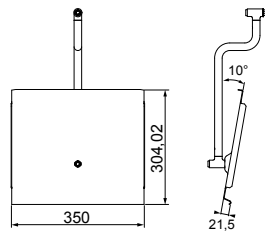

Keyboard

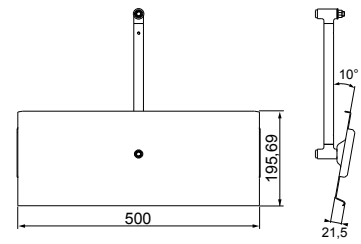

Suspension system

Characteristics	Fixed base	Wall fixing with joint	Rotating straight fitting	Horizontal inter-tube joint				
Support foot for direct horizontal or vertical connection.		Device allowing rotation through 170° of a horizontal tube, with a cross-section of 50 or 80 mm, and its fixing on a vertical surface. Protection by bellows, RAL 7035 grey color. Option of passing cables through the inside of the joint.	Device allowing the fixing and rotation through 295° of tubes, with a cross-section of 50 or 80 mm, in horizontal position. Without locking the chosen position. Fixing by 4 screws, not included.	Device allowing the linking and rotation through 170° of 2 horizontal tubes, with a cross-section of 50 or 80 mm. Protection by bellows, RAL 7035 grey color. Option of passing cables through the inside of the joint.				
Material	Molded steel	Molded steel	Molded steel	Molded steel				
Color	RAL 7040 grey	RAL 7040 grey	RAL 7040 grey	RAL 7040 grey				
Weight (kg)	3.25	7	4.35	9.45	5.4	15.7	4.25	10
Dimensions (mm)								
Ø A	50 mm ²	80 mm ²	50 mm ²	80 mm ²	50 mm ²	80 mm ²	50 mm ²	80 mm ²
B	42	72	92	115	50	74	42	72
C	105	134	118	160	68	98	236	320
D	11	11	42	72	42	72	67	94
E	125	173	85	130	30	45	148	190
F	152	201	11	11	96	144	-	-
G	-	-	148	190	96	141.5	-	-
H	72	111	80	115	134	195.5	-	-
I	97	126	130	175	140	210	-	-
J	-	-	55	90	120	180	-	-
K	-	-	68	103	9	13	-	-
L	110	140	105	150	55	84	-	-
S	15	16	-	-	-	-	-	-
References	NSYCMUMR50	NSYCMUMR80	NSYCMUMA50	NSYCMUMA80	NSYCMUMC50	NSYCMUMC80	NSYCMUIA50	NSYCMUIA80

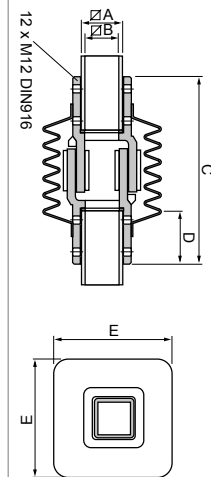
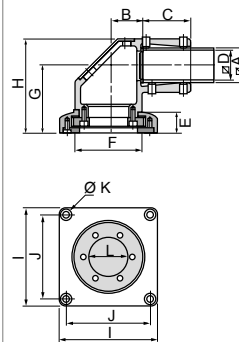
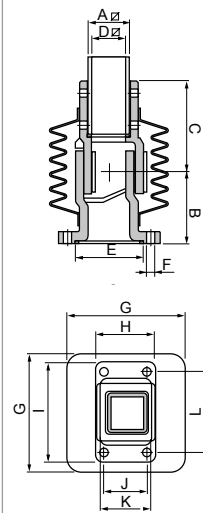
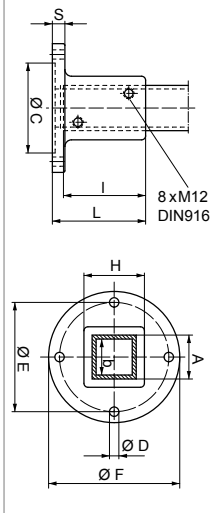

Suspension system



Characteristics	Fixed bracket		Rotating fixing on enclosure		Rotating fixing in bracket on enclosure		Locking mechanism	
Material	Aluminum		Aluminum		Aluminum		-	
Color	RAL 7040 grey		RAL 7040 grey		RAL 7040 grey		-	
Weight (kg)	1.35	2.4	1.25	3.1	2	6.55	2.98	3.10
Dimensions (mm)								
Ø A	50 mm ²	80 mm ²	50 mm ²	80 mm ²	50 mm ²	80 mm ²	50 mm ²	80 mm ²
B	46	56	42	72	46	56	55	55
C	60	83	115	145	60	83	100	100
D	60	83	96	139	147	190	44	44
E	46	56	52.3	85	96	139	121	121
F	42	70	58	87	42	72	182	182
G	144	193	-	-	154	208.5	50	50
H	-	-	-	-	42	70	100	100
I	-	-	-	-	58	87	50	50
M	-	-	M6	M8	M6	M8	-	-
References	NSYCMUTC50	NSYCMUTC80	NSYCMUCR50	NSYCMUCR80	NSYCMUCC50	NSYCMUCC80	NSYCMUCP50	NSYCMUCP80

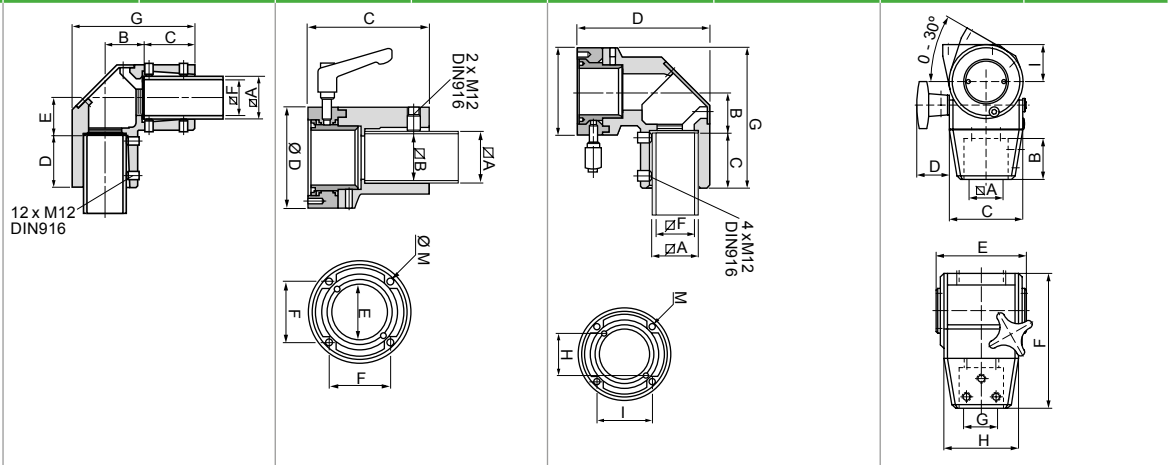

Adapter for signalling beacon

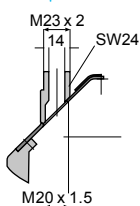

Technical changes reserved. Information provided without guarantee. Images are for illustrative purposes only.

Compact control desk

1 door

2 doors

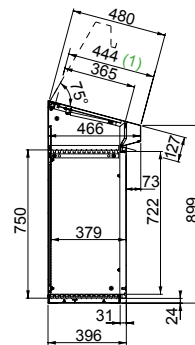
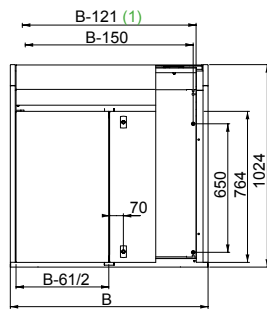
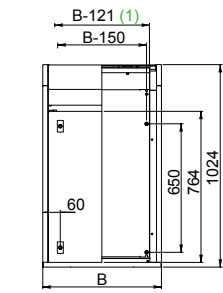

Cable gland plate clearance dimensions (mm)

Width	Maximum opening.
B-280	56

Common side view.
(1) Usable clearance.

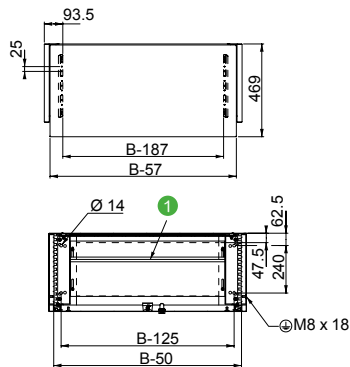
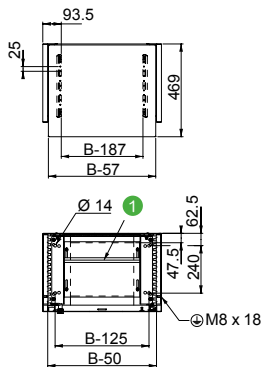

Compact control desks with rear panel

1 door

2 doors

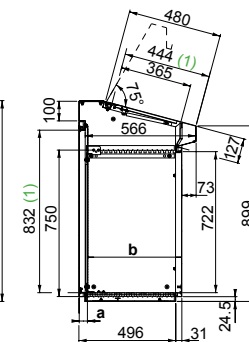
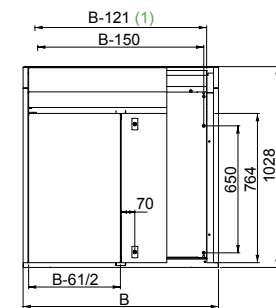
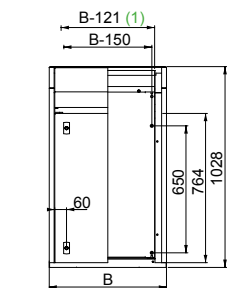

Cable gland plate clearance dimensions (mm)

Width	Maximum opening.
B-280	56

Adjustment of the depth of the mounting plate (mm)

Depth	Min.	Max.
a	42	392
b	129	479

Common side view.
(1) Usable clearance.

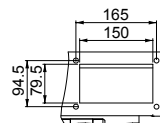
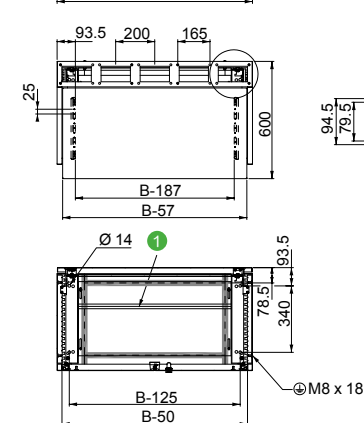
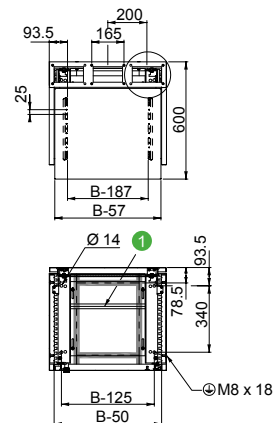

SDX Compact control desks with rear panel

1 door

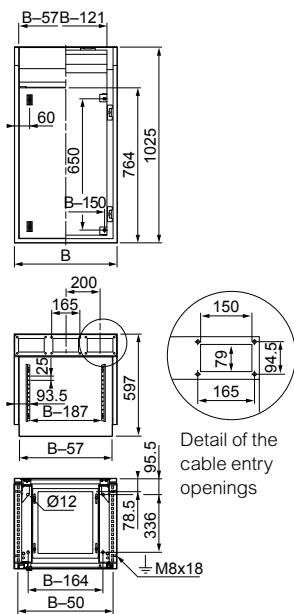

2 doors

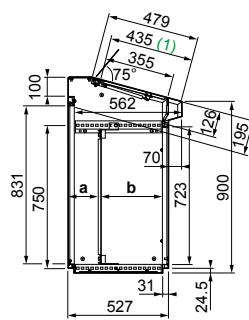
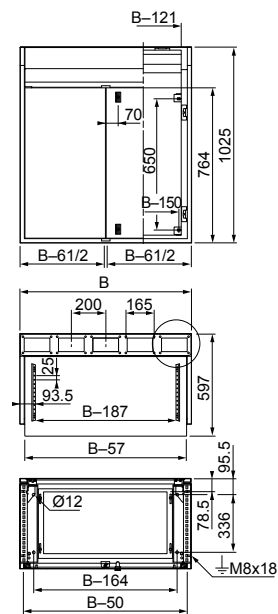

Cable gland plate clearance dimensions (mm)

Width	Maximum opening.
B-280	370

Adjustment of the depth of the mounting plate (mm)

Depth	Min.	Max.
a	45	395
b	126	476

Common side view.
(1) Usable clearance.

SD Control desk with console

1 door

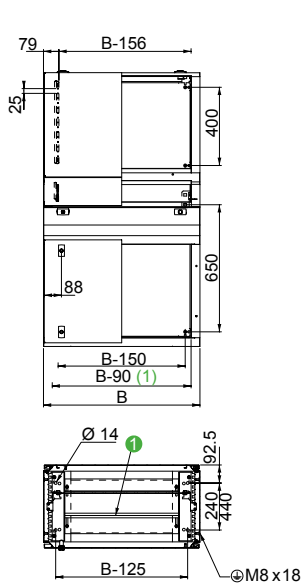

2 doors

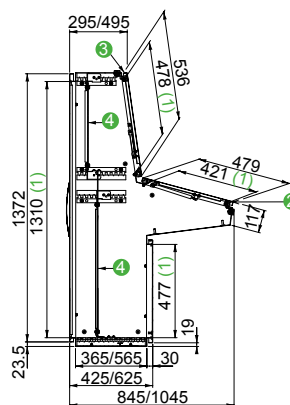
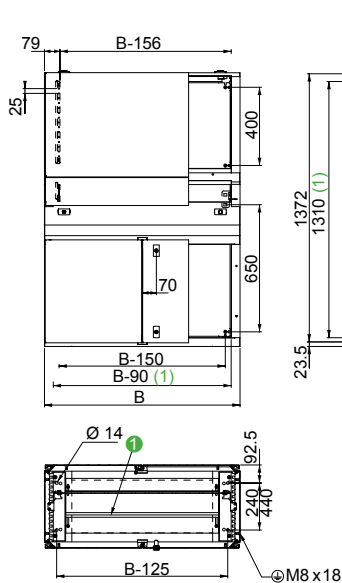

Cable gland plate clearance dimensions (mm)

Width	Maximum opening.
B-280	56

Notes

- 1 entry cable gland plate
- Maximum opening of the hinged desk lid: 75°
- Maximum opening of the hinged console cover: 75°
- Optional mounting plate installation, see page 523

Common side view.
(1) Usable clearance.

SD SDX Modular console

Depth 200 mm

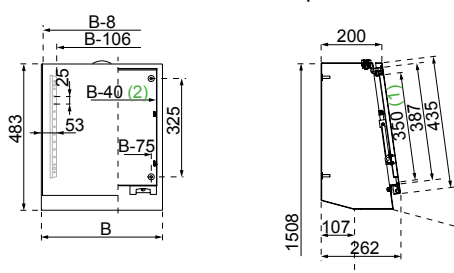

Depth 300 mm

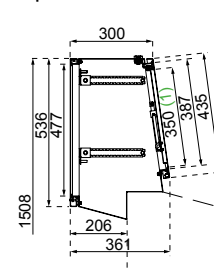

(1) Usable clearance.
(2) Same dimensions for the rear panel.

Spacial SF PC rack

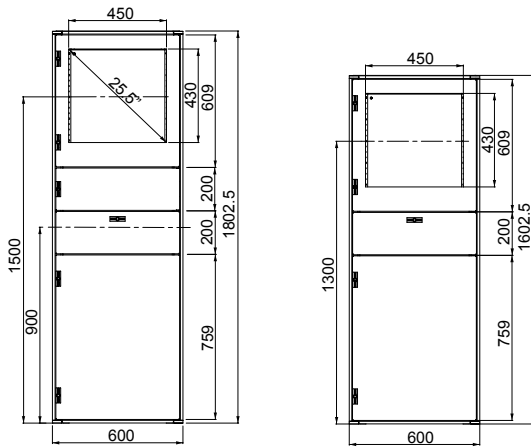

PC rack with a height of 1800 mm.

PC rack with a height of 1600 mm.

304L stainless-steel PC racks

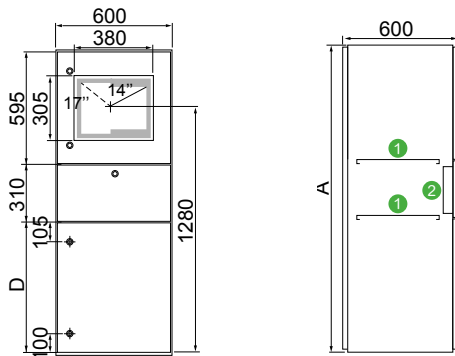

- (1) Screwed shelf, adjustable height.
- (2) Sealed case for keyboard.

A	D
1600	690
1800	890

The variable-speed drives flush-mounting kits have been designed to isolate the power part, which is an important source of heat. They are mounted in the Spacial range of steel enclosures (floor-standing and wall-mounted enclosures) and have been approved for Altivar Process variable-speed drives of the ATV630 and ATV930 ranges (power range: 0.75 to 45 kW at 200/240 V, 0.75 to 90 kW at 380/480 V).

The kits are available in five sizes and offer two methods of mounting variable-speed drives:

- slide-rail mounting for sizes 1, 2 and 3
- bracket mounting for sizes 4 and 5.

The kits can be installed:

- at the back of the enclosure.

This installation provides full thermal insulation.

- inside the enclosure on a mounting plate.

This installation may require additional thermal control.

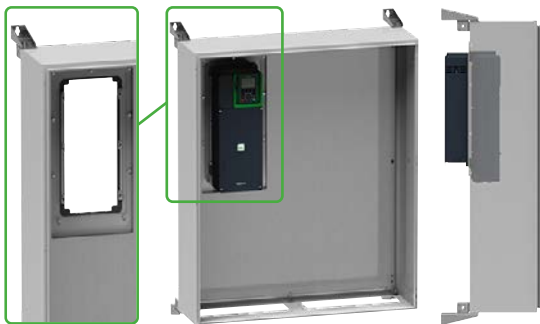

Tightness

- IP55 according to IEC 60529 with polyurethane seal provided.



Services

Option of cut-outs (enclosure and frame) by Schneider Electric: No risk of corrosion and cuts (cut-out made before painting).

11



Ease of installation

- Set of slide-rails allowing the variable-speed drive to be mounted quickly and efficiently.



Strength

- The rigidity of the kit allows it to be installed on Spacial S3D, SF and SM enclosures.

Earth continuity

- Earth continuity is ensured by tightening the M6 nuts combined with pin washers.



Maintenance of the variable-speed drive fan (kit sizes 4 and 5)

- Easy front panel maintenance for fan servicing.



Sizes 1, 2 and 3

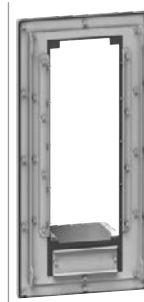

Sizes 4 and 5

Note:
For dimensions see [page 542](#)

Characteristics	Mounting kits
	Variable-speed drive installation kits allowing the hot part to be isolated.
Material	Steel
Finish	Structured finish, epoxy polyester powder
Color	RAL 7035 grey
Ingress protection rating according to IEC 60529	IP55
Certifications	UL (cULus). Rated 1, 3R and 12 according to UL50E

Supply	<p>Sizes 1, 2 and 3:</p> <ul style="list-style-type: none"> • Painted steel plate with cut-out fitted with two slide-rails + adhesive seal + 7 to 9 M6 studs for kit mounting • Protection seal profile supplied for frame cut-out • Enclosure drilling template <p>Sizes 4 and 5:</p> <ul style="list-style-type: none"> • Painted steel plates with cut-out fitted with painted mounting brackets + screws and nuts for fixing the brackets and the kit • Protection seal supplied for frame cut-out
---------------	---

Dimensions (mm)			Sizes	Compatibilities							
				Enclosures	Variable-speed drives	References				Kits	
H	L	P			ATV340 380/480 V	ATV630 200/240 V	380/480 V	ATV930 200/240 V	380/480 V	References	
					References	References	References	References	References	References	
360	235	22	1	S3D, SF, SM	-	ATV630U07M3	ATV630U07N4	ATV930U07M3	ATV930U07N4	NSYPTDS1	
360	235	22	1	S3D, SF, SM	-	ATV630U15M3	ATV630U15N4	ATV930U15M3	ATV930U15N4	-	
360	235	22	1	S3D, SF, SM	-	ATV630U22M3	ATV630U22N4	ATV930U22M3	ATV930U22N4	-	
360	235	22	1	S3D, SF, SM	-	ATV630U30M3	ATV630U30N4	ATV930U30M3	ATV930U30N4	-	
360	235	22	1	S3D, SF, SM	-	ATV630U40M3	ATV630U40N4	ATV930U40M3	ATV930U40N4	-	
360	235	22	1	S3D, SF, SM	-	-	ATV630U55N4	-	ATV930U55N4	-	
420	265	22	2	S3D, SF, SM	-	ATV630U55M3	ATV630U75N4	ATV930U55M3	ATV930U75N4	NSYPTDS2	
420	265	22	2	S3D, SF, SM	-	-	ATV630D11N4	-	ATV930D11N4	-	
555	295	22	3	S3D, SF, SM	-	ATV630U75M3	ATV630D15N4	ATV930U75M3	ATV930D15N4	NSYPTDS3	
555	295	22	3	S3D, SF, SM	-	ATV630D11M3	ATV630D18N4	ATV930D11M3	ATV930D18N4	-	
555	295	22	3	S3D, SF, SM	-	-	ATV630D22N4	-	ATV930D22N4	-	
800	385	151.5	4	SF, SM	ATV340D30N4E	ATV630D15M3	ATV630D30N4	ATV930D15M3	ATV930D30N4	NSYPTDS4	
800	385	151.5	4	SF, SM	ATV340D37N4E	ATV630D18M3	ATV630D37N4	ATV930D18M3	ATV930D37N4	-	
800	385	151.5	4	SF, SM	-	ATV630D22M3	ATV630D45N4	ATV930D22M3	ATV930D45N4	-	
975	427	205.5	5	SF, SM	ATV340D45N4E	ATV630D30M3	ATV630D55N4	ATV930D30M3	ATV930D55N4	NSYPTDS5	
975	427	205.5	5	SF, SM	ATV340D55N4E	ATV630D37M3	ATV630D75N4	ATV930D37M3	ATV930D75N4	-	
975	427	205.5	5	SF, SM	ATV340D75N4E	ATV630D45M3	ATV630D90N4	ATV930D45M3	ATV930D90N4	-	

Variable Speed Drive Flush-Mounting Kits Spacial S3D, SF and SM Dimensions

NSYPTDS1

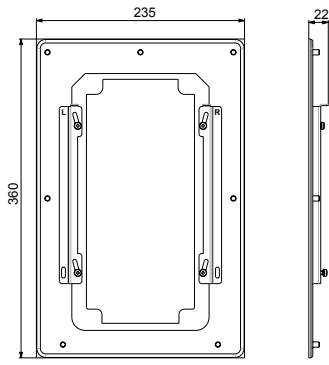

NSYPTDS2

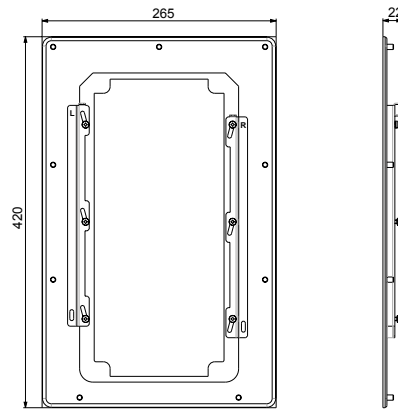

NSYPTDS3

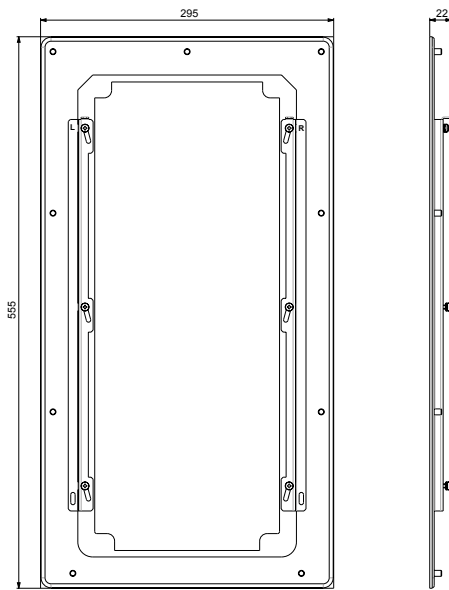

NSYPTDS4

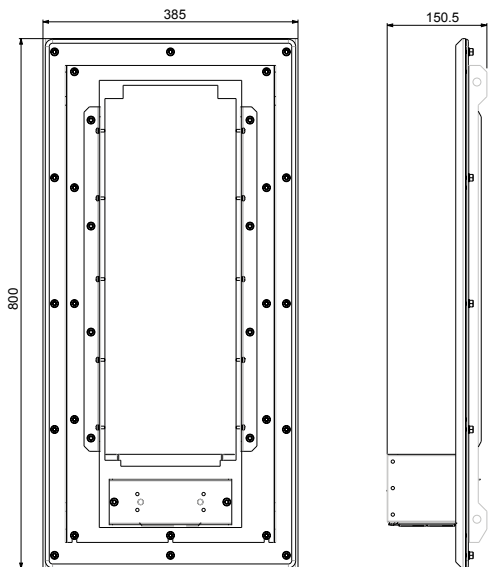

NSYPTDS5

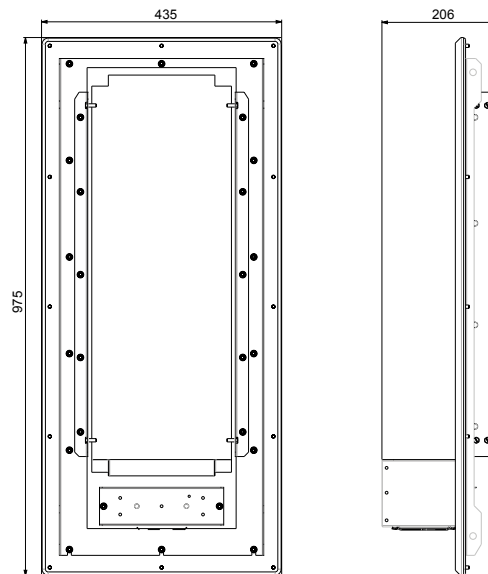

The door of the "incoming" enclosure is interlocked by the control of the main switch or circuit breaker. A built-in interlocking system with runner rods prevents the opening of the "outgoing" enclosure doors. Access is only allowed when the main switch or circuit breaker is in "O" position and the main door is open. Manual activation of the rods unlocks the other doors and allows access.

Designed to be combined with specific circuit breakers or switches:

- Square D (9422 A1).
- Schneider Electric.

The system is limited for configurations up to 4 columns.

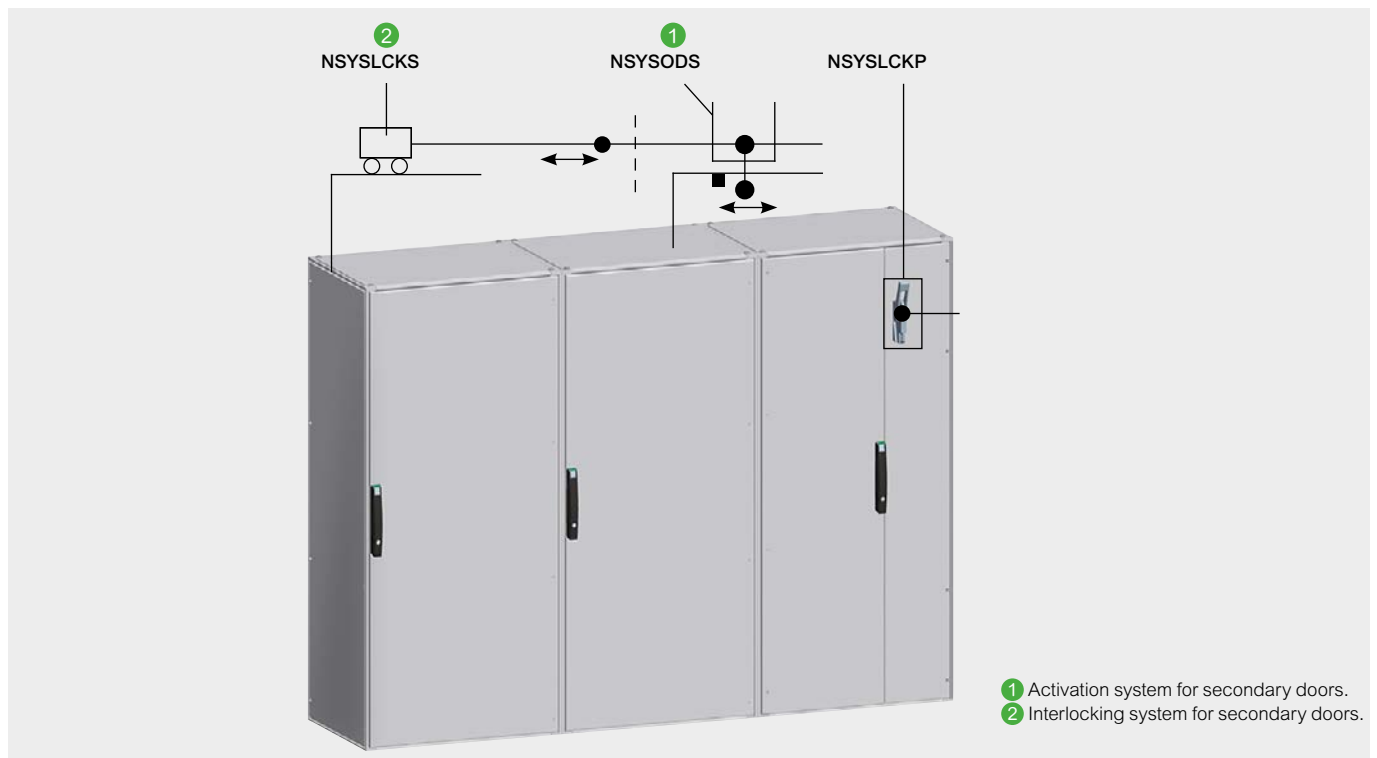

11



Safety

- The built-in safety interlocking system for the door (on demand) of the incoming/outgoing enclosures allows Spacial SF enclosures to be adapted to the requirements of the American automotive industry.

Interlocking system for main door



NSYSLCKP

System for unlocking the main door adapted to the switches:

- Allen Bradley (1494 VH11).
- Square D (9422 A1).
- Siemens (FH0H).
- Schneider Electric.

Unlocks the main door when the switch is in the open position "O".

The main door interlocking system requires ordering both references:

- 1 Activation system for secondary doors.
- 2 Interlocking system for secondary doors.

- Material: Steel
- Finish: Zinc-coated

Note:

The fixed panel in this example must be ordered through our customized service.

Supply:

2 brackets for fixing the configured panel, interlocking elements, switch and fixings. Configured panel and switch not included.

Characteristics	References
Interlocking system for main door	NSYSLCKP

Activation system for secondary doors

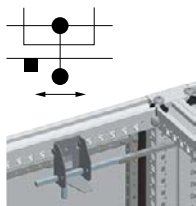

NSYSODS

- System installed in the main enclosure.
- Activated by manual operation, preventing the opening of the secondary enclosures connected to one another by runner rods.
- Safety function consisting of a part that forces the system into the position in which the secondary enclosures are locked in order to lock the main door.
- Material: Mechanism: Zinc-coated steel, Activation handle: Black plastic

Supply:

Elements for activating the main door and fixings.

For the complete function, both activation

- 1 and interlocking systems
- 2 need to be ordered.

Characteristics	References
Activation system for secondary doors	NSYSODS

Interlocking system for secondary doors

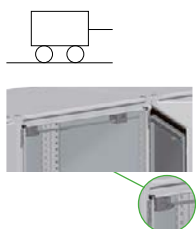

NSYSLCKS6

- System for interlocking the outgoing enclosures connected to one another by runner rods that lock their doors.
- Material: Steel
- Finish: Zinc-coated
- Fixing: Fixing to the structure of the enclosures by screws

Supply:

Elements for interlocking the secondary doors and fixings.

For the complete function, both activation

- 1 and interlocking systems
- 2 need to be ordered according to the enclosure Larg..

Characteristics	Width (mm)	References
Interlocking system for secondary doors	600	NSYSLCKS6
Interlocking system for secondary doors	800	NSYSLCKS8
Interlocking system for secondary doors	1000	NSYSLCKS10

Customized Solutions

Examples of specific solutions



- Custom dimensions
- Cut-outs in the body and the doors



- Cable entry and door adaptation
- Custom door shape



19" SFE for micro-edge data center application

Customized solutions

Introduction of customized offer	548
Benefits of customized offer	549
Segmentation of customized offer	550
How to define your enclosure	552
Configurator Spacial.conf	553

Introduction of Customized Offer



What does Customized Offer mean?

"Customize" means to change the properties of a standard product so that it meets the specific needs of an application. Customization can involve many aspects such as cut-outs, painting, assembly, dimensions, logistic, packaging, etc.

Customization adds value to our products by mounting an accessory or by making cut-outs for the installation of cable glands, grids, a fan or by applying a color to match your application. Our Customized offer yields many benefits that are described in the following.

The Customized offer is split into two categories:



CTO: Configured To Order

The CTO offer is described on [page 550](#).
You can configure your enclosure using our online configurator: spacial.conf



ETO: Engineered To Order

The ETO offer is described on [page 551](#).
To define the requirements of your application, please fill in the checklist on [page 552](#), this will ensure that our reply will match your inquiry in terms of specifications and costs, avoiding time-consuming multiple adjustment cycles.





Time Savings

Delivered with cut-outs & painting: no waste of time



Logistics

- Flexible management of your logistics option (scheduled delivery service for on-going orders)
- Special packaging



Simplified Installation

Enclosures delivered with cut-outs: no special tools required



Ergonomic Design

Customized project dedicated to your personal requirements



Increased Life-Time

- Cut-outs made before painting ensure corrosion protection and reliable sealing
- Painting service for better protection



Improved Quality

- No burrs on edges of cut-outs
- Guaranteed manufacturing tolerances



Aesthetics

- Large choice of colors
- No scratches in external surfaces



Higher Performance

- Adapted thermal management
- Higher-grade stainless-steel





CTO Configured To Order

CTO enclosures are similar to enclosures from the standard offer, and their price can be defined using the online configurator Spacial.conf.

CTO main features

Solution made of standard references applying the following services:

- Cut-outs,
- Stock colors of the Spacial range,
- Selected accessories from stock,
- Option of assembly of selected accessories.

Quantities specifications and lead times are defined and set in this document and in the configurator Spacial.conf.

CTO enclosures do not require a design phase by the P&S team, only a drawing if cut-outs are requested.

Drawings of all enclosures of the offer are available in .dxf format, showing the zones where cut-outs can be made.

Submitting a drawing in electronic form (dwg, dxf,...) will reduce the lead time and avoid queries and clarification loops.

Sales forces are autonomous to quote thanks to the configurator Spacial.conf.

<https://custom-enclosures.se.com/>

TO CONFIGURE YOUR ENCLOSURE



Spacial.conf
configurator

ETO

Engineered To Order

Addressing the project business, the ETO offer cannot be defined in full depth since our proposed solutions are tailored to the type, dimension and application of the individual project.

Our team of P&S experts can offer a variety of solutions to match most applications in the industrial and building segment.



ETO main features

- Cut-outs, special colors, specific dimensions, welding, special adaptation...
- Packaging and delivery according to project requirements
- Case-by-case coordination of technical specifications and quantity limitations as well as lead time with the P&S quotation team
- Quotation response time depends on project complexity. Note that Project above 100 k€ must be submitted to Go/no Go committee.

ETO solutions have no fixed market price as each case is quoted according to the project requirements.

For repetitive business a contract must define all the characteristics and limits of the solution in terms of offer, logistic, certification and quality.

What to take into account

This page will help you define your needs for the enclosure and streamline your design process.

Step 1

Environment in which your enclosure(s) will be installed

- Installation indoor or outdoor?
- installation outdoor under shelter?
- Clean or unclean environment?
- IP required?
- IK required?

Step 2

Application(s) requirements of your enclosure(s)

- Certification needed? UL? ATEX?
- Declaration of conformity?, NEMA?, Marine?, Seismic?, other...

Step 3

Enclosure(s) description

- Wall-mounted or floor standing?
- Type of enclosure's installation?
- Total weight of equipment items in the enclosure?
- Design: Color / painting / finish / dimension?
- Body components' adaptations: Cable entry / mounting plate?
- Thermal management adaptations?
- Other accessories' adaptations?
- Additional information: Labeling / packaging / logistics?

Step 4

Business profile

- Total quantity of enclosures needed and quantity per set?
- Frequency of your order: Single order / repeat order?
- Delivery time and method?
- Stock needs?
- Other comments?

Spacial.conf is the online configurator that allows to configure a CTO enclosure within minutes, using the optional services and choosing the accessories available with a short lead time.

Spacial.conf is an online tool for the convenient, error-free and fast creation of orders.



MAIN FEATURES

- Built-in accessories compatibility matrix
- Up-to-date list prices in every country (where deployed)
- Management of discounts on product range and customer level
- Link to dxf drawing downloads
- Link to data sheets

When the configuration is completed, the tool shows a smart code corresponding to the solution.

This smart code can be copy/pasted for the following uses:

- Create a request in the Work Flow
- Save it for a future use in Spacial.conf
- Send it to another user to share it

Actassi

Enclosures for indoor needs

Wall-mounted



Floor-standing

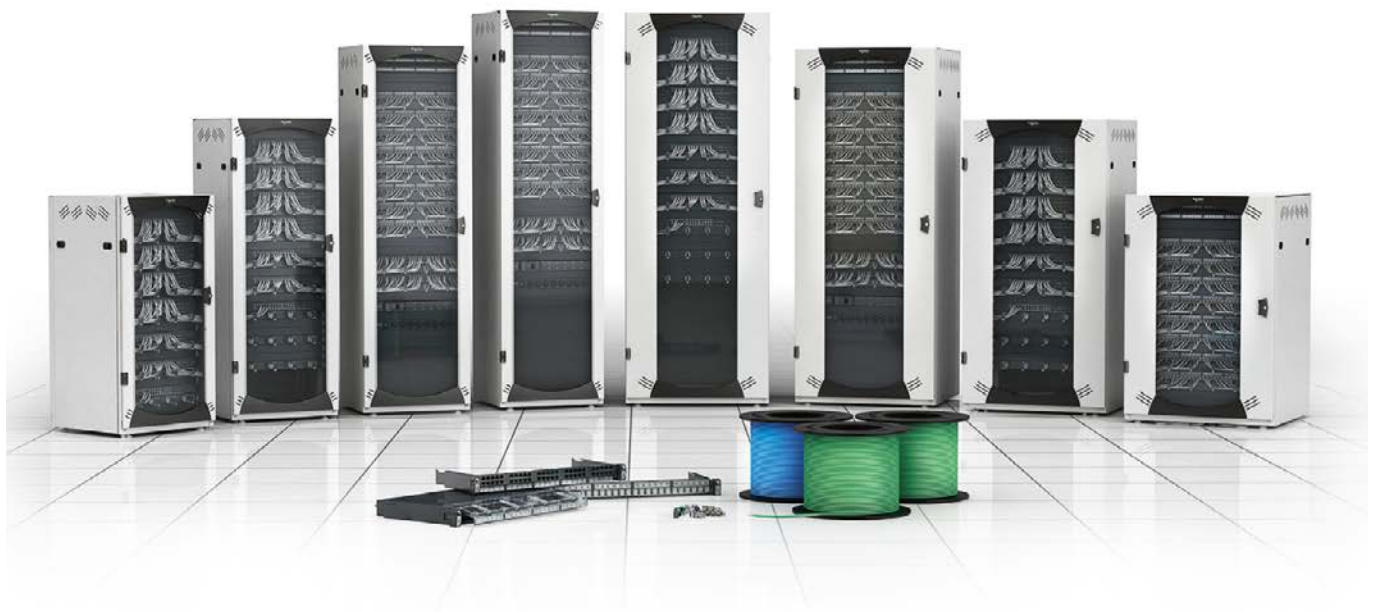

OPB	
19" Wall-Mounted Open Box	559
19" Wall-Mounted Open Box with swing rack	560
19" Wall-Mounted Open Box with fixed rack	561
19" Mobile Open Box	564
Roof accessories	566
Base accessories	567
KDB	
19" Wall Knock-Down Box	571
Thermal management	572
VDA	
Easy to install and to integrate	574
VDA/VDS Racks Overview	576
VDA-B	
Simple and functional	577
VDA-E	
Equipped and ready to use	581
VDA-L	
Prepared for Ruko locking system	585
VDS	
19" server enclosure	588
Patching frame	593
Overhead patching frame	593
VDA/VDS	
EA accessories	595
EA Base accessories	604
Universal accessories	606
Earth connection	607
Fixing components	608
Shelves (compatible only with floor standing enclosures)	609
Equipment support	612
Electrical power distribution rails	613
Power distribution	616
Cable management (compatible only with floor standing)	617
Cable management	619
Plates	620
Thermal-management	620
19-E Universal accessories lighting	
Customized offer	622
VDA/VDS	624
Customization services	624
Technical information	
Technical information	630
Spare parts	
VDA-VDS floor-standing Enclosures	631

Actassi Enclosures

With the Actassi system you can create a seamless end-to-end network connectivity solution for all needs. There are different conditions and demands on the installations in buildings, data centers and small offices. That is why Actassi includes all possible sizes of wall-mounted and floor-standing enclosures, from 6 to 47 units in different widths, depths, colors and compositions. You can always find an Actassi enclosure that gives a perfect result.



Do you want to have other enclosures than standard? No problem. With Actassi enclosures it's possible to customize color, accessories, specific lining etc. according to your personal needs.



The Digital Rule helps you select products

Hard to select the Actassi enclosures, RJ45 connectors, patch panels and cables? Visit se.com and try our Digital Rule. It's an intelligent online e-catalog which will facilitate your choices and helps ensuring an error-free specification.



13

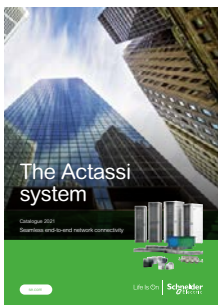

The Actassi system – Network Connectivity

Actassi is Schneider Electric's new global state-of-the-art range for networking and connectivity infrastructure solutions for buildings. It consists of the best performing features from local Schneider Electric brands such as LexCom, Infracplus, Clipsal Datacomms, Sarel and Himel. From RJ45 connectors to network enclosures, the Actassi system offers every installer around the world the best of the best solutions.

Ref: **LSB02659EN**
09/2021



Scan or click

Technical changes reserved. Information provided without guarantee. Images are for illustrative purposes only.

Actassi Wall-Mounted Enclosures

The Actassi wall-mounted OPB OpenBox enclosures allow you to easily integrate patch panels, cables, switches and digital recorders. All the lining can be removed without tools, and with the swing-rack version of OPB, with a quick-locking system, you'll get access to the connections from the back to handle the maintenance in a convenient way. Too hot in the enclosure? No problem, it's easy to integrate a blanking plate with two fans. With Actassi KDB, the new flat-pack knock-down boxes, you save 60% of space in the stock. And it takes only 5 minutes to assemble.



Actassi OPB and KDB



Actassi OPB
Open Box with swing rack



Actassi KDB
Knock-Down Box



Actassi OPB
Mobile Open Box



Actassi wall-mounted

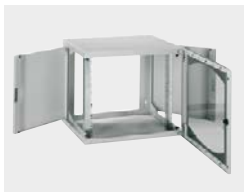

Actassi OPB
Open Box with fixed rack

Maximized Capacity and Swift Maintenance with Actassi OPB

Time for adjustments? Just open the sides and fold out the swing rack. Replace and add whatever parts you need, no tools required. Fold back the rack, close the sides and you are done. To increase the flexibility of the entire installation, use the Actassi OPB as a distributed solution.



The Actassi OPB serves perfectly as a distributed solution. In a hospital for instance, the need for quick, reliable and easily expandable network connectivity can be crucial.

Actassi OPB – open for installation

The Actassi OPB is wide open for a swift and struggle-free installation. Steady as a rock, even with the side panels and the door dismantled.

The swing rack makes all the difference

When making the first installation, as well as continuous upgrades, you will find that the swing rack makes all the difference for you as an installer. Access from all sides, pre-cut cable entries and minimum usage of tools are some of the other features that make the OPB truly open for installation and maintenance.

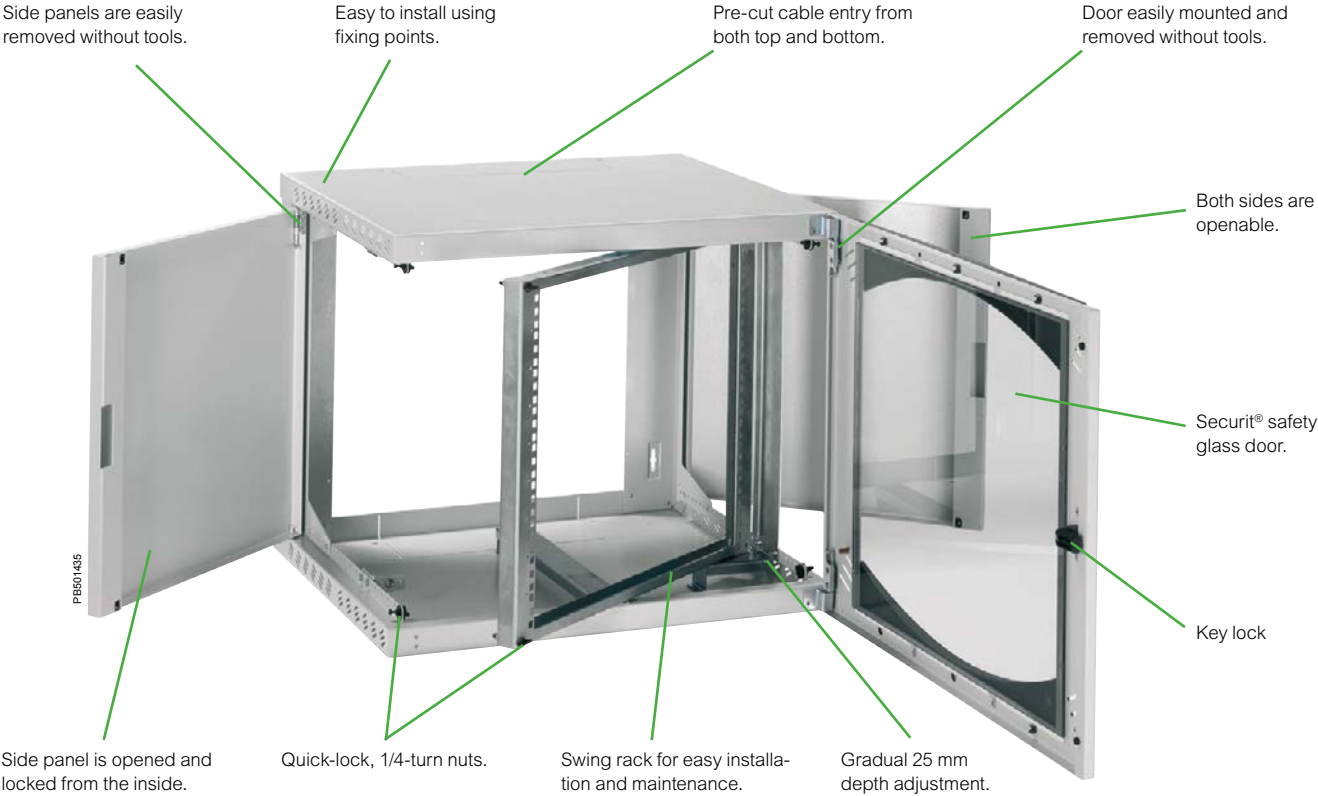

19" Wall-Mounted Open Box Ergonomic and Adaptable



Actassi OPB is assembled at delivery, ready to use



Side panels, swing rack and door can be opened and removed without tools. Quick and easy.



50 kg

The body allows mounting of components up to 50 kg.



Easy to install

The Actassi OPB enclosure can be wall-mounted by a single person using the fixing points intended for the passage of holding screw heads into the wall.



Adaptable

The 19" uprights are designed to be depth-adjustable with a step of 25 mm. Their fixing with screws helps guaranteeing the rigidity of the Actassi OPB enclosure.



Ergonomics

The side panels swing through 120° and can be easily removed without tools. Rear access is easy. Door easily removable without tools.

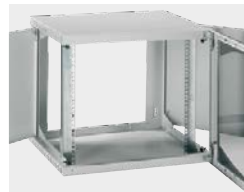

Easy to install and to reverse

Its drilling template on the packaging and its 4 wall-mounted points enable quick and efficient installation while guaranteeing reversibility by simply turning the enclosure around.



Easy to cable

The cable entries, top or bottom, are pre-cut and open into the rear of the Actassi OPB enclosure. The enclosure fits around those cables that are already in place (rear blanking plate optional).



Ergonomics

The side panels are locked from the inside by two 1/4-turn nuts, accessible only when the door is open.

19" Wall-Mounted Open Box with Swing Rack

Actassi, OPB

Open for easy installation and maintenance Introduction and selection guides

- Wall-mounted enclosure made from folded and welded sheet steel, powder paint, leather-grain finish, RAL 7035 light grey epoxy-polyester
- Enclosure made up of a body, 2 hinged and removable side panels, a 19" swing rack and a Securit® glass transparent door with key no. 333
- Protection rating: IP20
 - protection against objects > 12.5 mm
 - no protection against liquids
- Impact Protection: IK08
- Impact energy = 5 joules
- Available enclosures:
 - 5 heights: 6, 9, 12, 15, 18U
 - 3 depths: 400, 500 and 600 mm
- Swing rack: acceptable load of 25 kg (Include 25% of margin load rating according to IEC 62208)
- Certifications: in compliance with directive RoHs, with 19" standard IEC 60297-3-100 and EIA-310-E.

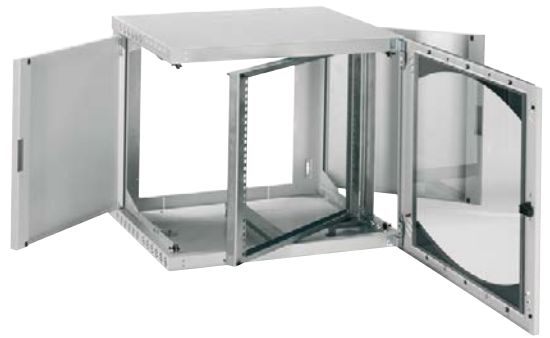

Installed enclosures

Number of U	Dimensions (mm)			Enclosure reference	Blanking plate	Cable-gland plate with brush gasket	Blanking plate with 2 fans, cannot be used directly with UK PDU
	Height	Width	Depth				
6	380	600	400	NSYOPB6U4P	NSYOPB6UTPN	NSYECP300	NSYECVT300
6	380	600	500	NSYOPB6U5P	NSYOPB6UTPN		
9	515	600	400	NSYOPB9U4P	NSYOPB9UTPN		
9	515	600	500	NSYOPB9U5P	NSYOPB9UTPN		
12	650	600	500	NSYOPB12U5P	NSYOPB12UTPN		
12	650	600	600	NSYOPB12U6P	NSYOPB12UTPN		
15	780	600	500	NSYOPB15U5P	NSYOPB15UTPN		
15	780	600	600	NSYOPB15U6P	NSYOPB15UTPN		
18	915	600	500	NSYOPB18U5P	NSYOPB18UTPN		



Total accessibility with the swing rack and the swingable and removable side panels and door.

19" Wall-Mounted Open Box with Fixed Rack

Actassi, OPB

Ergonomic and adaptable Introduction and selection guides

- Wall-mounted enclosure made from folded and welded sheet steel, powder paint, leather-grain finish, RAL 7035 light grey epoxy-polyester
- Enclosure made up of a body, 2 hinged and removable side panels, 19" fixed uprights and a Securit® glass transparent door or plain sheet steel door with key no. 333
- Protection rating: IP20
 - protection against objects > 12.5 mm
 - no protection against liquids
- Impact Protection: IK08 (for glazed door)
 - impact energy = 5 joules
- Impact Protection: IK10 (for plain door)
 - impact energy = 20 joules
- Available enclosures:
 - 6 heights: 6, 9, 12, 15, 18, 21U
 - 3 depths: 400, 500 and 600 mm
- Fixed 19" rack. Acceptable load: 3 kg/U; max. 50 kg per enclosure (Include 25% of margin load rating according to IEC 62208)
- Certifications: in compliance with directive RoHs, with 19" standard IEC 60297-3-100 and EIA-310-E.

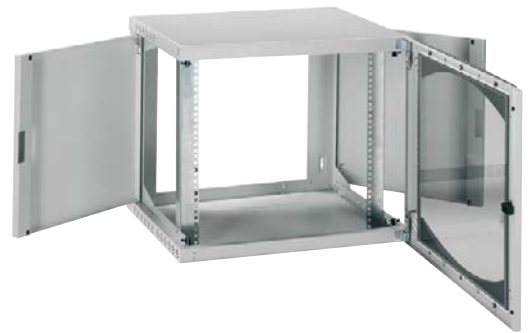

Installed enclosures

Number of U	Dimensions (mm)			Enclosure reference	Blanking plate	Cable-gland plate with brush gasket	Blanking plate with 2 fans, cannot be used directly with UK PDU
	Height	Width	Depth				
6	380	600	400	NSYOPB6U4F	NSYOPB6UTPN	NSYECP300	NSYECVT300
6	380	600	500	NSYOPB6U5F	NSYOPB6UTPN		
9	515	600	400	NSYOPB9U4F	NSYOPB9UTPN		
9	515	600	500	NSYOPB9U5F	NSYOPB9UTPN		
9	515	600	600	NSYOPB9U6F	NSYOPB9UTPN		
12	650	600	400	NSYOPB12U4F	NSYOPB12UTPN		
12	650	600	500	NSYOPB12U5F	NSYOPB12UTPN		
12	650	600	600	NSYOPB12U6F	NSYOPB12UTPN		
15	780	600	400	NSYOPB15U4F	NSYOPB15UTPN		
15	780	600	500	NSYOPB15U5F	NSYOPB15UTPN		
15	780	600	600	NSYOPB15U6F	NSYOPB15UTPN		
18	915	600	400	NSYOPB18U4F	NSYOPB18UTPN		
18	915	600	500	NSYOPB18U5F	NSYOPB18UTPN		
21	1050	600	500	NSYOPB21U5F	NSYOPB21UTPN		
21	1050	600	600	NSYOPB21U6F	NSYOPB21UTPN		

Enclosure with plain door

Number of U	Dimensions (mm)			Enclosure reference	Blanking plate	Blanking plate with 2 fans, cannot be used directly with UK PDU
	Height	Width	Depth			
9	515	600	400	NSYOPB9U4FR	NSYOPB9UTPN	NSYECVT300
12	650	600	400	NSYOPB12U4FR	NSYOPB12UTPN	
15	780	600	500	NSYOPB15U5FR	NSYOPB15UTPN	
18	915	600	500	NSYOPB18U5FR	NSYOPB18UTPN	



2U extra space "for free", 1U in the top and 1U in the bottom. Can be used for example for power rails.

19" Wall-Mounted Open Box with swing rack

- Wall-mounted enclosure made from folded and welded sheet steel, powder paint, leather-grain finish, RAL 7035 light grey epoxy-polyester
- Enclosure made up of a body, 2 hinged and removable side panels, a 19" swing rack and a Securit® glass transparent door with key no. 333
- Protection rating: IP20
 - protection against objects > 12.5 mm
 - no protection against liquids
- Impact Protection: IK08
- Impact energy = 5 joules

Available enclosures:

- 5 heights: 6, 9, 12, 15, 18U
- 3 depths: 400, 500 and 600 mm
- Swing rack: acceptable load of 25 kg (Include 25% of margin load rating according to IEC 62208)
- Certifications: in compliance with directive RoHs, with 19" standard IEC 60297-3-100 and EIA-310-E.

Cable-gland plate with brush gasket, ref. **NSYECVP300**, see [page 566](#)
 Blanking plate with 2 fans, cannot be used directly with UK PDU, ref. **NSYECVT300**, see [page 566](#)



NSYOPB6U4P

Characteristics	Number of U	Height (mm)	Width (mm)	Depth (mm)	References
19" Wall-Mounted Open Box with swing rack, glazed door	6	380	600	400	NSYOPB6U4P
19" Wall-Mounted Open Box with swing rack, glazed door	6	380	600	500	NSYOPB6U5P
19" Wall-Mounted Open Box with swing rack, glazed door	9	515	600	400	NSYOPB9U4P
19" Wall-Mounted Open Box with swing rack, glazed door	9	515	600	500	NSYOPB9U5P
19" Wall-Mounted Open Box with swing rack, glazed door	12	650	600	500	NSYOPB12U5P
19" Wall-Mounted Open Box with swing rack, glazed door	12	650	600	600	NSYOPB12U6P
19" Wall-Mounted Open Box with swing rack, glazed door	15	780	600	500	NSYOPB15U5P
19" Wall-Mounted Open Box with swing rack, glazed door	15	780	600	600	NSYOPB15U6P
19" Wall-Mounted Open Box with swing rack, glazed door	18	915	600	500	NSYOPB18U5P

19" Wall-Mounted Open Box with fixed rack

- Wall-mounted enclosure made from folded and welded sheet steel, powder paint, leather-grain finish, RAL 7035 light grey epoxy-polyester
- Enclosure made up of a body, 2 hinged and removable side panels, 19" fixed uprights and a Securit® glass transparent door or plain sheet steel door with key no. 333
- Protection rating: IP20
 - protection against objects > 12.5 mm
 - no protection against liquids
- Impact Protection: IK08 (for glazed door)
 - impact energy = 5 joules
- Impact Protection: IK10 (for plain door)
 - impact energy = 20 joules

Available enclosures:

- 6 heights: 6, 9, 12, 15, 18, 21U
- 3 depths: 400, 500 and 600 mm
- Fixed 19" rack. Acceptable load: 3 kg/U; max. 50 kg per enclosure (Include 25% of margin load rating according to IEC 62208)
- Certifications: in compliance with directive RoHs, with the 19" standard IEC 60297-3-100 and EIA-310-E.

Cable-gland plate with brush gasket, ref. **NSYECVP300**, see [page 566](#)
 Blanking plate with 2 fans, cannot be used directly with UK PDU, ref. **NSYECVT300**, see [page 566](#)



NSYOPB6U4F

Characteristics	Number of U	Height (mm)	Width (mm)	Depth (mm)	References
19" Wall-Mounted Open Box with fixed rack, glazed door	6	380	600	400	NSYOPB6U4F
19" Wall-Mounted Open Box with fixed rack, glazed door	6	380	600	500	NSYOPB6U5F
19" Wall-Mounted Open Box with fixed rack, glazed door	9	515	600	400	NSYOPB9U4F
19" Wall-Mounted Open Box with fixed rack, glazed door	9	515	600	500	NSYOPB9U5F
19" Wall-Mounted Open Box with fixed rack, glazed door	9	515	600	600	NSYOPB9U6F
19" Wall-Mounted Open Box with fixed rack, glazed door	12	650	600	400	NSYOPB12U4F
19" Wall-Mounted Open Box with fixed rack, glazed door	12	650	600	500	NSYOPB12U5F
19" Wall-Mounted Open Box with fixed rack, glazed door	12	650	600	600	NSYOPB12U6F
19" Wall-Mounted Open Box with fixed rack, glazed door	15	780	600	400	NSYOPB15U4F
19" Wall-Mounted Open Box with fixed rack, glazed door	15	780	600	500	NSYOPB15U5F
19" Wall-Mounted Open Box with fixed rack, glazed door	15	780	600	600	NSYOPB15U6F
19" Wall-Mounted Open Box with fixed rack, glazed door	18	915	600	400	NSYOPB18U4F
19" Wall-Mounted Open Box with fixed rack, glazed door	18	915	600	500	NSYOPB18U5F
19" Wall-Mounted Open Box with fixed rack, glazed door	21	1050	600	500	NSYOPB21U5F
19" Wall-Mounted Open Box with fixed rack, glazed door	21	1050	600	600	NSYOPB21U6F

Enclosure with plain door

Blanking plate with 2 fans, cannot be used directly with UK PDU, ref. **NSYECVT300**, see [page 566](#)



NSYOPB9U4FR

Characteristics	Number of U	Height (mm)	Width (mm)	Depth (mm)	References
19" Wall-Mounted Open Box with fixed rack, plain door	9	515	600	400	NSYOPB9U4FR
19" Wall-Mounted Open Box with fixed rack, plain door	12	650	600	400	NSYOPB12U4FR
19" Wall-Mounted Open Box with fixed rack, plain door	15	780	600	500	NSYOPB15U5FR
19" Wall-Mounted Open Box with fixed rack, plain door	18	915	600	500	NSYOPB18U5FR

Made for audiovisual applications

Technical characteristics

- The body of the enclosure has cut-outs at the top and bottom to allow natural airing
- Cable entry through rear opening and through pre-cut areas on the top and bottom of the enclosure
- 4 cut-outs are provided for wall-mounted
- The 2 side panels can be opened very easily by means of two 1/4-turn nuts. The panels can be removed without tools
- The 19" uprights in zinc-coated steel are depth-adjustable on a 25 mm step
- The Securit® glass door is completely reversible. It is equipped with a handle and a locking system with key no. 333. It is easily removed without tools
- Certifications: in compliance with directive RoHs, with 19" standard IEC 60297-3-100 and EIA-310-E.

Composition

- Actassi OPB with top and bottom cut-outs
- 1 glazed front door with a lock, key no. 333
- 1 rear plate, reference: **NSYOPB6UTPN** to **NSYOPB21UTPN**
- 4 depth-adjustable 19" uprights. Additional uprights available
- 4 wheels, reference **NSYRUFOPB**
- Option of installing a plinth instead of the wheels.



Rear blanking plate



NSYOPB6UTPN

- Blanking plate made from sheet steel, powder paint, leather-grain finish, RAL 7035 light grey epoxy-polyester

Supply:
Delivered with the fixings required for installation

Characteristics	Number of U	References
Rear blanking plate	6	NSYOPB6UTPN
Rear blanking plate	9	NSYOPB9UTPN
Rear blanking plate	12	NSYOPB12UTPN
Rear blanking plate	15	NSYOPB15UTPN
Rear blanking plate	18	NSYOPB18UTPN
Rear blanking plate	21	NSYOPB21UTPN

Additional 19" uprights



NSYOPB6UF

- Material: zinc-coated sheet steel, 20/10 mm thick
- Maximum load: 3 kg/U; max. 50 kg per enclosure
- Unit marking.

Supply:
Set of two 19" uprights delivered with the fixings required for installation

Characteristics	Number of U	References
Additional 19" uprights	6	NSYOPB6UF
Additional 19" uprights	9	NSYOPB9UF
Additional 19" uprights	12	NSYOPB12UF
Additional 19" uprights	15	NSYOPB15UF
Additional 19" uprights	18	NSYOPB18UF
Additional 19" uprights	21	NSYOPB21UF

19" uprights, rear, 2U



NSYSSOPB

- Allows to save 2U on the front and to fix Power Distribution Unit on the back of the enclosure
- It is fixed to the rear of the enclosure
- It allows the installation of products in 19" format
- Height adjustment with a step of 44.45 mm (1U)
- Material: zinc-coated sheet steel.

Supply:
Set made up of 2 partial 2U 19" uprights delivered with the fixings required for installation

Characteristics	Number of U	References
19" uprights, rear, 2U	2	NSYSSOPB

Cable support for enclosure, rear



NSYSPBOPB

- Allows to help securing and guide the cables on the back of the enclosure
- Fixed to the rear of the enclosure to support and fix the cables
- Height adjustable with a step of 44.45 mm (1U)
- Material: zinc-coated steel

Supply:
Delivered with the fixings required for installation.

Characteristics	References
Cable support for enclosure, rear	NSYSPBOPB

Top or bottom blanking plate

- Plain blanking plate
- Material: zinc-coated steel sheet

Supply:
Delivered with the fixings required for installation.



NSYEC300

Characteristics	References
Top or bottom blanking plate	NSYEC300

Blanking plate with brush gasket

- Fixing to the top or bottom openings of the enclosures
- Material: zinc-coated steel sheet

Supply:
Delivered with the fixings required for installation.



NSYEC300

Characteristics	Dimensions (mm)	References
Blanking plate with brush gasket	35 x 300	NSYEC300

Total brush gasket

- It is fixed to the top and bottom cable entries.



NSYECPT300

Characteristics	Dimensions (mm)	References
Total brush gasket	100 x 300	NSYECPT300

Top or bottom blanking plate with airing louvres

- Fixing to the top or bottom openings of the enclosures
- Material: zinc-coated sheet steel

Supply:
Delivered with the fixings required for installation.



NSYECAV300

Characteristics	References
Top or bottom blanking plate with airing louvres	NSYECAV300

Top or bottom blanking plate with 2 fans

- 2 fans installed and wired to on the terminal block, including a protection grille.
- A power supply cable of 2 m in length is supplied connected
- Free flow of 35 m³/h each
- Fixing to the top or bottom openings of the enclosures
- Material: zinc-coated sheet steel
- Delivered with the fixings required for installation
- Sound level: 35 dB (A)
- Cannot be used directly with UK PDU.

Supply:
Delivered with the fixings required for installation.



NSYECVT300

Characteristics	References
Top or bottom blanking plate with 2 fans	NSYECVT300

See also the 19-E Universal accessories



Thermal management [page 620](#)

Levelling feet



- Require drilling of the enclosure at the knock-out point for direct installation
- Set of 4 parts.

Supply:
Delivered with the fixings required for installation.

Characteristics	References
Levelling feet	NSYPNOPB

Wheels



- Require drilling of the enclosure at the knock-out point for direct installation
- Installation possible on the plinth
- Set of 4 parts.

Supply:
Delivered with the fixings required for installation.

Characteristics	References
Wheels	NSYRUFOPB

Plinths



- Material: sheet steel, 15/10 mm thick, powder paint, leather grain finish, RAL 7011 dark grey epoxy-polyester
- Height 100 mm
- Removable surfaces
- Knock-out entries on the side and rear surfaces for cable entry.

Supply:
Delivered with the fixings required for installation.

Characteristics	Width (mm)	Depth (mm)	References
Plinths	600	500	NSYZUN65OPB
Plinths	600	600	NSYZUN66OPB

Brush gasket for the cable entries through the plinth



- It is fixed to the knock-out areas for the cable entries
- Delivery as a unit.

Characteristics	Entry width (mm)	References
Brush gasket for the cable entries through the plinth	75 x 400	NSYJPSVD

Wall-mounted kit for Actassi enclosures

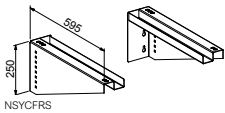

- Allows wall-mounted of enclosures from 6U to 29U, with a depth of 600 mm
- Maximum load inside the enclosure: 50 kg
- The kit includes 2 brackets

Supply:
Delivered with the fixings required for installation.

Characteristics	Depth (mm)	References
Wall-mounted kit for Actassi enclosures	600	NSYCFRS

Partial fixed slides



NSYGF140OPB

- Set of 2 slides for supporting a drawer, a shelf or 19" hardware
- Fixing by attachment on the front 19" uprights
- Material: zinc-coated steel
- Acceptable load: 15 kg.

Characteristics	Width (mm)	References
Partial fixed slides	140	NSYGF140OPB

Fixed slides



NSYGF200OPB

- Set of 2 slides for supporting a drawer, a shelf or 19" hardware
- Fixing by attachment between the front and rear 19" uprights
- Material: zinc-coated steel
- Heel of 0 mm
- Acceptable load: 15 kg.

Characteristics	Center-to-center distance (mm)	References
Fixed slides	200	NSYGF200OPB

Rear cable support on 19" uprights



NSYSRCOPB

- Fixing to the rear of the 19" uprights to support the cables
- Material: zinc-coated steel

Supply:
Delivered with the fixings required for installation.

Characteristics	References
Rear cable support on 19" uprights	NSYSRCOPB

Earthing kit for Actassi OPB



NSYCTOPB

- To earth all the covering components.

Characteristics	References
Earthing kit for Actassi OPB	NSYCTOPB

Actassi KDB Knock-Down Boxes – Ideal For Smaller Businesses

Imagine providing excellent equipment for network, telephone, security and audio/video while saving up to 60% on stock space. Add smart benefits like the flat-package and the exceptional mounting time of 5 minutes, and you have the major advantages of the KDB enclosure in a little box.



The Actassi KDB boxes are available at your wholesaler. Always quick and easy to find an enclosure for your needs.

Actassi KDB knock-down box

A sturdy, robust enclosure made of welded sheet steel, with great opportunities for several kinds of installations, would probably save lots of time and mounting space during installation. Not the Actassi KDB knock-down boxes The keyword is "easy".

Easy to stock, assemble and manage

Let's start with the package. The clever flat-pack will help save up to 60% on storage space. It's easy to stock – just grab a couple of packages from the shelf, load them into the your car and you are ready to go.

On site, the enclosure can be put up, wall-mounted and prepared for the components in just a few minutes. In addition, there are a number of handy features that provide equal easiness: the tool-less door with spring hinges for optimized access to the patch panels, the brush panel for swift cable management and the fan plates for smart airing.



Save 60% on stock space

The KDB enclosure is easy to stock and load. The flat-pack allows you to save up to 60% on space, which means you can make more installations in less time.



5 minutes
1 person
1 tool

Actassi KDB enclosures offer exceptional simplicity in terms of mounting and installation. One person can set up the KDB in less than 5 minutes. And the only tool needed is a regular screw-driver.



19" Wall-Mounted Open Box

Ergonomic and Adaptable



5 minutes

You need only five minutes to mount the Actassi KDB enclosure.



Easy to assemble. You only need one single tool. A drilling template facilitates the fixation on the wall.



40 kg

The body allows mounting of components up to 40 kg.

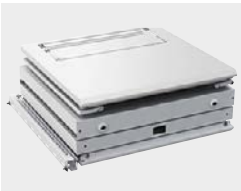

Easy to stock and ship

The flat-pack architecture of KDB enclosure helps saving 60% of space in the stock. It is also very easy to ship and carry.



Easy cable management (option)

Use the 19" brush panel to easily manage the entry of cables supress into the top and bottom.



Easy to assemble

The symmetric construction of the top, bottom and side panels gives easy and helps assembling.



Smart airing (option)

Helps protecting the installed components like switches and PABX. Use the 19" smart fan plates equipped with a thermostat adjustable from 0 °C to 55 °C



Easy to use

Tool-less door with spring hinges facilitates the access to the patch panels.



Easy to adapt

If you need more space at the front of the enclosure, you can easily move the 19" uprights each 25 mm.

19" Wall Knock-Down Box

Simple and Space-Saving

Introduction and selection guides

- Flat-pack wall-mounted enclosure dismantled in 1 package
- Symmetric enclosure made from welded sheet steel, powder-painted, leather-grain finish, RAL 7035 light grey epoxy-polyester.
- Enclosure made up of a body, one pair of 19" fixed uprights and a Securit® glass transparent door with key no. 333.
- Top and bottom 19" knock-down plates for entry cables and fans – 0U
- Protection rating: IP20
 - protection against objects > 12.5 mm
 - no protection against liquids
- Impact Protection: IK08
 - impact energy = 5 joules
- Acceptable load: 3 kg/U; max. 40 kg per enclosure.
- (Include 25% of margin load rating according to IEC 62208)
- Certifications: in compliance with directive RoHs, with 19" standard IEC 60297-3-100 and EIA-310-E
- Brush entry cables NSYCRTM1U1PS (in option)
- Smart fan NSY1FAN230T for temperature control from 0 °C to 55 °C (option).



60%

The flat-pack helps saving up to 60% of space in the stock

Flat-pack enclosures

Number of U	Dimensions (mm)			Enclosure reference	Brush entry cables	Smart fan
	Height	Width	Depth			
6	352	600	400	NSYKDB6U4F	NSYCRTM1U1PS	NSY1FAN230T
9	485	600	400	NSYKDB9U4F		
12	618	600	400	NSYKDB12U6F		
15	752	600	400	NSYKDB15U6F		



Smart fans



- 19" fan plate
 - 0U on top and bottom of the box
 - 3U fixed on the 19" uprights
- Equipped with 1 or 2 fans
 - 90 CFM per fan (155 m3/h)
 - 230 V - AC
 - plugs IEC 14 to power
 - Mains input: socket IEC C14 - for connection with IEC C13 plug power cable
- Equipped with 1 adjustable thermostat 0 °C to 55 °C
- Equipped with 1 led switch On/Off.



NSY1FAN230T



NSY2FAN230T

Supply:
Delivered without cable.

Characteristics	Type	References
Smart fans	1 Fan	NSY1FAN230T
Smart fans	2 Fans	NSY2FAN230T

Basic fans

- 19" fan plate
 - 0U on top and bottom of the box
 - 3U fixed on the 19" uprights
- Equipped with 1 or 2 fans
 - 90 CFM per fan (155 m3/h)
 - 230 V - AC
 - plugs IEC 14 to power
 - Mains input: socket IEC C14 - for connection with IEC C13 plug power cable
- Without thermostat and switch.



NSY1FAN230



NSY2FAN230

Supply:
Delivered without cable.

Characteristics	Type	References
Basic fans	1 Fan	NSY1FAN230
Basic fans	2 Fans	NSY2FAN230

Cables for smart & basic fan plates

- Black power cables of 3 m to power the fan plates.



NSYIEC13SCH



NSYIEC13IEC14

Characteristics	Plug Out	Plug In	References
Cables for smart & basic fan plates	IEC C13	Schuko/FR	NSYIEC13SCH
Cables for smart & basic fan plates	IEC C13	IEC C14	NSYIEC13IEC14

Actassi Floor-Standing Enclosures

Are you looking for an enclosure that is robust and very quick to install? Actassi VDA should be your choice. Smart details and an option to choose pre-installed accessories reduce the installation time. If you need a top-of-the-line server enclosure, Actassi VDS is hard to beat. It can be mounted with up to 750 kg of 19" components, and the micro-perforated door helps ensuring superior air flow (above 80%).



Actassi VDA-B
Cabling enclosure



Actassi VDA-E
Cabling enclosure



Actassi VDA-L
Cabling enclosure.
Prepared for Ruko locking system



Actassi VDS
Server enclosure

VDA Easy To Install and To Integrate 19" Cabling Enclosure

Adaptable

The configured offer allows you to equip the rack according to your needs:

- 2 framework models,
- 13 door models,
- 2 side panel models.

Aesthetics and customization

3 models referenced:

VDA-B, VDA-E, VDA-L (Ruko).

2 color variants:

- 2 colors light grey (RAL7035) or dark grey (RAL9011)



Time saving

All doors can be installed and removed quickly. The cladding can be installed and removed by one person. The feet can be adjusted from the inside.



Rigidity and sturdiness

400 kg of acceptable static load. Option of increasing to 500 kg using a rigidity kit.

VDA Easy To Install and To Integrate 19" Cabling Enclosure



The airing is adjustable and does not take up any units (1 to 9 fans).



Panels and doors can be installed and removed quickly by one person.



Innovation

The side cable entry is the most ergonomic and efficient solution on the market. The top and bottom openings, flush with the structure, allow the cables to be prepared before installing the rack. These openings also allow for easy maintenance and are closed when the side panels are installed.



Safety

Helps securing installed components such as switches. The latches of the panels can be equipped with a key locking system (the key is identical for all the doors).



Accessories

The central openings on the roof and the base support multiple blanking plate combinations (plain, with brush gasket or ventilated). Optional installation of the blanking plates with the roof plate thanks to the roof stand-offs.



Smart

The pivot and guide system allows the panels to be returned to their place quickly, with maximum safety.



Harmonious design

With modern aesthetics: strip, handle, hinge, in rounded shape.



Practical

Marking of the units on the front panel and on the side for quick installation of the equipment. The 19" uprights are easily adjusted in depth on site.



Ergonomics

The routing of the cable glands is easier:

- Knock-out side cable glands at top and bottom.
- Knock-out rear cable glands at top and bottom.
- Large opening on the roof, offset towards the rear and equipped with a removable plate. Allows the integration of live equipment at the top and the entry of cables by the rear.
- Large opening at the bottom.



Adjustable airing

The roof airing is depth-adjustable and does not take up any units. Option of installing 1 to 9 fans according to the size of your enclosure.

VDA/VDS Racks Overview



VDA B/E/L Enclosures



VDS - Server Enclosure

		Colors	19" Uprights		Lining specificities			Acceptable Static Load	Equipments
			Front	Rear	Door	Side Panel	Rear		
VDA-B	Simply and functionally designed for cabling applications with switches and routers	Ral7035 - Light Grey	x2	No	glazed (1-point locking system)	locking by latches	Panel (locking by latches)	400 kg (882 lbs)	Earthing kit (NSYCTVDA) must be ordered separately
VDA-E	Equipped and ready to use for IT and VIDEO applications	Ral7035 - Light Grey	x2	x2	glazed (2-point locking system)		Full plain door (1-point locking system)		Earthing kit is pre-installed + bag of 30 cage nuts M6 and 30 screws&washers
		Ral9011 - Black	x2	x2	glazed (2-point locking system)		Full plain door (1-point locking system)		Earthing kit is pre installed + Bag of 30 cage nuts M6 and 30 screws&washers
VDA-L	Prepared and ready to use for network applications with Ruko Locking System	24U Ral7035 - Light Grey	x2	No	glazed (1-point locking system)		Panel (locking by latches)		Cover (NSYAEDKRUVD) must be ordered separately for Ruko locking system
		42U Ral9011 - Black	x2	x2	glazed or plain (2-point locking system)	Panel (locking by latches)	Adapter (NSYAEDN1DVD) is supplied with the rack for Ruko locking system		
VDS	19" Server enclosure, robust and ventilated for micro data centers	Ral9011 - Black	x2	x2	ventilated (2-point locking system)		Ventilated Door (2-point locking system)	750 kg (1654 lbs)	Earthing kit is pre-installed

13

VDA-B

Simple and Functional

Introduction

VDA-B rack

- Designed for circulation applications with switches and routers
- 6 heights: 24U, 29U, 33U, 38U, 42U and 47U
- 2 widths: 600 and 800 mm
- 3 depths: 600, 800 and 1000 mm
- Acceptable static load: 400 kg
- Dynamic load: 250 kg
- Color: light Grey (RAL 7035) for lining
- Protection rating: IP20
 - protection against objects > 12.5 mm
 - no protection against liquids
- Impact Protection: IK08
 - impact energy = 5 joules
- Certifications: in compliance with directive RoHs, with 19" standard IEC 60297-3-100 and EIA-310D.

Rack composition

- Top and bottom frames, mechanically assembled by Torx screws to the vertical structure uprights, thus forming a rigid framework
- Base without blanking plate
- Cut-out roof, closed with a removable blanking plate
- Glazed reversible front door, 4 mm Securit® glass, opening to 180°, 1-point lock with a key no. 333. Hinges on the right as standard
- Rear panel with quick installation and removal, locking by latches
- Side panels with quick installation and removal, locking by latches
- Top and bottom side cable glands flush with the structure
- Top and bottom side knock-out areas for cable entry, with a width of 800 mm
- Large opening on the bottom and large knock-out area on the rear for cable entry.
- Levelling feet installed
- Two 19" uprights made from treated steel, installed 100 mm back from the front surface and depth-adjustable in steps of 25 mm
- Delivered on a pallet wrapped with film.

Composition of the rack without side panels

- Exactly the same composition as the above rack, but without the side panels
- Coupling kit not supplied
- If coupling is required, use the coupling kit (ref. **NSYCUNVDA**) and the brush gasket (ref. **NSYCUNPL800** or **NSYCUNPL1000**) to close the cable entry left by the 2 side panels.



Selection guide

• VDA-B racks, RAL 7035 Light Grey

Installed enclosures									
Number of U	Dimensions (mm)			Rack with side panels	Rack without side panels	19" uprights	100 mm plinth	Handling wheels	Cable-gland trim
	Height	Width	Depth						
24	1200	600	600	NSYVDA24U66B	-	NSYBR9F24	NSYZUN66VDA	NSYRUFVDA	-
24	1200	600	800	NSYVDA24U68B	-	NSYBR9F24	NSYZUN68VDA	NSYRUFVDA	-
24	1200	600	1000	NSYVDA24U610B	-	NSYBR9F24	NSYZUN610VDA	NSYRUFVDA	-
24	1200	800	600	NSYVDA24U86B	-	NSYBR9F24	NSYZUN86VDA	NSYRUFVDA	NSYPV24
24	1200	800	800	NSYVDA24U88B	-	NSYBR9F24	NSYZUN88VDA	NSYRUFVDA	NSYPV24
24	1200	800	1000	NSYVDA24U810B	-	NSYBR9F24	NSYZUN810VDA	NSYRUFVDA	NSYPV24
29	1400	600	600	NSYVDA29U66B	-	NSYBR9F29	NSYZUN66VDA	NSYRUFVDA	-
29	1400	600	800	NSYVDA29U68B	-	NSYBR9F29	NSYZUN68VDA	NSYRUFVDA	-
29	1400	800	600	NSYVDA29U86B	-	NSYBR9F29	NSYZUN86VDA	NSYRUFVDA	-
29	1400	800	800	NSYVDA29U88B	-	NSYBR9F29	NSYZUN88VDA	NSYRUFVDA	-
33	1600	600	600	NSYVDA33U66B	-	NSYBR9F33	NSYZUN66VDA	NSYRUFVDA	-
33	1600	600	800	NSYVDA33U68B	-	NSYBR9F33	NSYZUN68VDA	NSYRUFVDA	-
33	1600	800	800	NSYVDA33U88B	-	NSYBR9F33	NSYZUN88VDA	NSYRUFVDA	NSYPV33
38	1800	600	600	NSYVDA38U66B	-	NSYBR9F38	NSYZUN66VDA	NSYRUFVDA	-
38	1800	600	800	NSYVDA38U68B	-	NSYBR9F38	NSYZUN68VDA	NSYRUFVDA	-
38	1800	800	600	NSYVDA38U86B	-	NSYBR9F38	NSYZUN86VDA	NSYRUFVDA	-
38	1800	800	800	NSYVDA38U88B	-	NSYBR9F38	NSYZUN88VDA	NSYRUFVDA	-
42	2000	600	600	NSYVDA42U66B ⁽¹⁾	-	NSYBR9F42	NSYZUN66VDA	NSYRUFVDA	-
42	2000	600	800	NSYVDA42U68B	-	NSYBR9F42	NSYZUN68VDA	NSYRUFVDA	-
42	2000	600	1000	NSYVDA42U610B	-	NSYBR9F42	NSYZUN610VDA	NSYRUFVDA	-
42	2000	800	600	NSYVDA42U86B	-	NSYBR9F42	NSYZUN86VDA	NSYRUFVDA	NSYPV42
42	2000	800	800	NSYVDA42U88B ⁽¹⁾	NSYVDAC42U88B	NSYBR9F42	NSYZUN88VDA	NSYRUFVDA	NSYPV42
42	2000	800	1000	NSYVDA42U810B ⁽¹⁾	-	NSYBR9F42	NSYZUN810VDA	NSYRUFVDA	NSYPV42
47	2200	600	600	NSYVDA47U66B	-	NSYBR9F47	NSYZUN66VDA	NSYRUFVDA	-
47	2200	600	800	NSYVDA47U68B	-	NSYBR9F47	NSYZUN68VDA	NSYRUFVDA	-
47	2200	800	600	NSYVDA47U86B	-	NSYBR9F47	NSYZUN86VDA	NSYRUFVDA	-
47	2200	800	800	NSYVDA47U88B	-	NSYBR9F47	NSYZUN88VDA	NSYRUFVDA	-

⁽¹⁾ This size exists in kit version (delivered disassembled)

Only 2 people and 10 mn is needed.
Same Reference but + „K" at the end
> NSYVDA42U66BK
> NSYVDA42U810BK
> NSYVDA42U88BK

Rack with side panels



NSYVDA24U66B

Characteristics	Number of U	Height (mm)	Width (mm)	Depth (mm)	References
Rack with side panels	24	1200	600	600	NSYVDA24U66B
Rack with side panels	24	1200	600	800	NSYVDA24U68B
Rack with side panels	24	1200	600	1000	NSYVDA24U610B
Rack with side panels	24	1200	800	600	NSYVDA24U86B
Rack with side panels	24	1200	800	800	NSYVDA24U88B
Rack with side panels	24	1200	800	1000	NSYVDA24U810B
Rack with side panels	29	1400	600	600	NSYVDA29U66B
Rack with side panels	29	1400	600	800	NSYVDA29U68B
Rack with side panels	29	1400	800	600	NSYVDA29U86B
Rack with side panels	29	1400	800	800	NSYVDA29U88B
Rack with side panels	33	1600	600	600	NSYVDA33U66B
Rack with side panels	33	1600	600	800	NSYVDA33U68B
Rack with side panels	33	1600	800	800	NSYVDA33U88B
Rack with side panels	38	1800	600	600	NSYVDA38U66B
Rack with side panels	38	1800	600	800	NSYVDA38U68B
Rack with side panels	38	1800	800	600	NSYVDA38U86B
Rack with side panels	38	1800	800	800	NSYVDA38U88B
Rack with side panels	42	2000	600	600	NSYVDA42U66B
Rack with side panels, kit version (delivered disassembled)	42	2000	600	600	NSYVDA42U66BK
Rack with side panels	42	2000	600	800	NSYVDA42U68B
Rack with side panels	42	2000	600	1000	NSYVDA42U610B
Rack with side panels	42	2000	800	600	NSYVDA42U86B
Rack with side panels	42	2000	800	800	NSYVDA42U88B
Rack with side panels, kit version (delivered disassembled)	42	2000	800	800	NSYVDA42U88BK
Rack with side panels	42	2000	800	1000	NSYVDA42U810B
Rack with side panels, kit version (delivered disassembled)	42	2000	800	1000	NSYVDA42U810BK
Rack with side panels	47	2200	600	600	NSYVDA47U66B
Rack with side panels	47	2200	600	800	NSYVDA47U68B
Rack with side panels	47	2200	800	600	NSYVDA47U86B
Rack with side panels	47	2200	800	800	NSYVDA47U88B

Rack without side panels



NSYVDAC42U88B

Characteristics	Number of U	Height (mm)	Width (mm)	Depth (mm)	References
Rack without side panels	42	2000	800	800	NSYVDAC42U88B

Additional 19" uprights

- Assembly on the depthwise supports
- Depth adjustable in steps of 25 mm
- Set of 2 uprights and the fixings required for assembly
- For partial assembly use depth-support references **NSYSBRF66** to **NSYSBRF88**
- 9.5 mm square holes in the front panel.



NSYBR9F12

Characteristics	Number of U	References
Additional 19" uprights	24U	NSYBR9F24
Additional 19" uprights	29U	NSYBR9F29
Additional 19" uprights	33U	NSYBR9F33
Additional 19" uprights	38U	NSYBR9F38
Additional 19" uprights	42U	NSYBR9F42
Additional 19" uprights	47U	NSYBR9F47

Plinths (F1)



NSYZUN66VDA

- Plinth made from folded sheet steel, RAL 7011 dark grey, epoxy-polyester, textured, powder paint
- Plinth height: 100 mm
- Allows the assembly of standard levelling feet compatible with handling wheels reference **NSYRUFNPVDA**
- Option of removing the 4 strips
- Side and rear strips equipped with a knock-out area for cable entry
- Front strip equipped with airing louvres.

Characteristics	Width (mm)	Depth (mm)	References
Plinths (F1)	600	600	NSYZUN66VDA
Plinths (F1)	600	800	NSYZUN68VDA
Plinths (F1)	600	1000	NSYZUN610VDA
Plinths (F1)	800	600	NSYZUN86VDA
Plinths (F1)	800	800	NSYZUN88VDA
Plinths (F1)	800	1000	NSYZUN810VDA

Handling wheels (M3)



NSYRUFVDA

- Set of 4 swivel wheels, 2 of which are equipped with a locking system
- Direct fixing under the bottom frame of the rack by M12 screws
- Height of the wheels: 105 mm.

Characteristics	References
Handling wheels (M3)	NSYRUFVDA

Vertical trim strips with cable entries (H2)



NSYPV24

- For enclosures with a width of 800 mm only
- Side cut-outs allowing the entry of cables every 250 mm. Knock-out entries on the front plate every 250 mm
- Assembly on the framework uprights providing aesthetic continuity between the framework and the 19" uprights positioned at least 100 mm away from the door
- RAL 7011 dark grey paint
- Cable-protection strips (not supplied) to be ordered separately
- Dismounting by 1/4-turn screws
- Set of 2 trim strips.

Characteristics	Number of U	References
Vertical trim strips with cable entries (H2)	24U	NSYPV24
Vertical trim strips with cable entries (H2)	33U	NSYPV33
Vertical trim strips with cable entries (H2)	42U	NSYPV42

VDA-E

Equipped and Ready To Use

Introduction

VDA-E rack

- Designed for IT and video applications, among others
- 4 heights: 24U, 38U, 42U and 47U
- 2 widths: 600 and 800 mm
- 3 depths: 600, 800 and 1000 mm.
- Acceptable static load: 400 kg
- Dynamic load: 250 kg
- Color:
 - light Grey (RAL 7035) for lining
 - black (RAL 9011)
- Protection rating: IP20
 - protection against objects > 12.5 mm
 - no protection against liquids
- Impact Protection: IK08
 - impact energy = 5 joules
- Certifications: in compliance with directive RoHs, with 19" standard IEC 60297-3-100 and EIA-310D

Rack composition

- Top and bottom frames, mechanically assembled by Torx screws to the vertical structure uprights, thus forming a rigid framework
- Base without blanking plate
- Cut-out roof, closed with a removable plain sheet
- Glazed reversible front door, 4 mm Securit® glass, opening to 180°, 2-point lock with a key no. 333 and handle. Hinges on the right as standard. Option of adding a third central locking point as an accessory, with reference **NSYAEDN3PVD**
- Reversible full plain rear door, 1-point lock with a key no. 333, opening to 180°
- Side panels with quick installation and removal, locking by latches
- Top and bottom side cable glands flush with the structure
- Top and bottom side knock-out areas for cable entry, with a width of 800 mm
- Large opening on the bottom and large knock-out area on the rear for cable entry
- Levelling feet installed
- Four 19" uprights made from treated steel, installed 100 mm back from the front plate and depth-adjustable in steps of 25 mm
- Delivered on a pallet wrapped with film
- Earthing kit pre-installed
- 1 bag of fixings with 30 M6 screws + washers + caged nuts.

Composition of the rack without side panels

- Exactly the same composition as the above rack
- Coupling kit not supplied
- If coupling is required, use the coupling kit (ref. **NSYCUNVDA**) and the brush gasket (ref. **NSYCUNPL800** or **NSYCUNPL1000**) to close the cable entry left by the 2 side panels.

VDA-E racks, RAL 9011 black cladding

- 1 height: 42U
- 2 widths: 600 and 800 mm
- 3 depths: 600, 800 and 1000 mm
- Rack composition
- Delivered assembled.



Selection guide

- VDA-E racks, RAL 7035 Light Grey

Installed enclosures								
Number of U	Dimensions (mm)			Rack with side panels	Rack without side panels	100 mm plinth	Handling wheels	Cable-gland trim
	Height	Width	Depth					
24	1200	600	600	NSYVDA24U66E	-	NSYZUN66VDA	NSYRUFVDA	-
24	1200	600	800	NSYVDA24U68E	-	NSYZUN68VDA	NSYRUFVDA	-
24	1200	600	1000	NSYVDA24U610E	-	NSYZUN610VDA	NSYRUFVDA	-
24	1200	800	600	NSYVDA24U86E	-	NSYZUN86VDA	NSYRUFVDA	NSYPV24
24	1200	800	800	NSYVDA24U88E	-	NSYZUN88VDA	NSYRUFVDA	NSYPV24
24	1200	800	1000	NSYVDA24U810E	-	NSYZUN810VDA	NSYRUFVDA	NSYPV24
38	1800	600	600	NSYVDA38U66E	-	NSYZUN66VDA	NSYRUFVDA	-
38	1800	600	800	NSYVDA38U68E	-	NSYZUN68VDA	NSYRUFVDA	-
38	1800	800	600	NSYVDA38U86E	-	NSYZUN86VDA	NSYRUFVDA	-
38	1800	800	800	NSYVDA38U88E	-	NSYZUN88VDA	NSYRUFVDA	-
42	2000	600	600	NSYVDA42U66E	-	NSYZUN66VDA	NSYRUFVDA	-
42	2000	600	800	NSYVDA42U68E	-	NSYZUN68VDA	NSYRUFVDA	-
42	2000	600	1000	NSYVDA42U610E	-	NSYZUN610VDA	NSYRUFVDA	-
42	2000	800	600	NSYVDA42U86E	-	NSYZUN86VDA	NSYRUFVDA	NSYPV42
42	2000	800	800	NSYVDA42U88E	NSYVDAC42U88E	NSYZUN88VDA	NSYRUFVDA	NSYPV42
42	2000	800	1000	NSYVDA42U810E	-	NSYZUN810VDA	NSYRUFVDA	NSYPV42
47	2200	600	600	NSYVDA47U66E	-	NSYZUN66VDA	NSYRUFVDA	-
47	2200	600	800	NSYVDA47U68E	-	NSYZUN68VDA	NSYRUFVDA	-
47	2200	800	600	NSYVDA47U86E	-	NSYZUN86VDA	NSYRUFVDA	-
47	2200	800	800	NSYVDA47U88E	-	NSYZUN88VDA	NSYRUFVDA	-

Selection guide

- VDA-E racks, RAL 9011 black

Installed enclosures								
Number of U	Dimensions (mm)			Rack with side panels	Rack without side panels	100 mm plinth	Handling wheels	Cable-gland trim
	Height	Width	Depth					
42	2000	600	600	NSYVDA42U66EN	-	NSYZUN66VDA	NSYRUFVDA	-
42	2000	600	800	NSYVDA42U68EN	-	NSYZUN68VDA	NSYRUFVDA	-
42	2000	600	1000	NSYVDA42U610EN	-	NSYZUN610VDA	NSYRUFVDA	-
42	2000	800	600	NSYVDA42U86EN	-	NSYZUN86VDA	NSYRUFVDA	NSYPV42
42	2000	800	800	NSYVDA42U88EN	-	NSYZUN88VDA	NSYRUFVDA	NSYPV42
42	2000	800	1000	NSYVDA42U810EN	-	NSYZUN810VDA	NSYRUFVDA	NSYPV42

Rack with side panels



NSYVDA24U66E

- VDA-E racks,
- RAL 7035 Light Grey

Characteristics	Number of U	Height (mm)	Width (mm)	Depth (mm)	References
Rack with side panels	24	1200	600	600	NSYVDA24U66E
Rack with side panels	24	1200	600	800	NSYVDA24U68E
Rack with side panels	24	1200	600	1000	NSYVDA24U610E
Rack with side panels	24	1200	800	600	NSYVDA24U86E
Rack with side panels	24	1200	800	800	NSYVDA24U88E
Rack with side panels	24	1200	800	1000	NSYVDA24U810E
Rack with side panels	38	1800	600	600	NSYVDA38U66E
Rack with side panels	38	1800	600	800	NSYVDA38U68E
Rack with side panels	38	1800	800	600	NSYVDA38U86E
Rack with side panels	38	1800	800	800	NSYVDA38U88E
Rack with side panels	42	2000	600	600	NSYVDA42U66E
Rack with side panels	42	2000	600	800	NSYVDA42U68E
Rack with side panels	42	2000	600	1000	NSYVDA42U610E
Rack with side panels	42	2000	800	600	NSYVDA42U86E
Rack with side panels	42	2000	800	800	NSYVDA42U88E
Rack with side panels	42	2000	800	1000	NSYVDA42U810E
Rack with side panels	47	2200	600	600	NSYVDA47U66E
Rack with side panels	47	2200	600	800	NSYVDA47U68E
Rack with side panels	47	2200	800	600	NSYVDA47U86E
Rack with side panels	47	2200	800	800	NSYVDA47U88E

Rack without side panels



NSYVDAC42U88E

- VDA-E racks,
- RAL 7035 Light Grey

Characteristics	Number of U	Height (mm)	Width (mm)	Depth (mm)	References
Rack without side panels	42	2000	800	800	NSYVDAC42U88E

Rack with side panels



NSYVDA42U66EN

- VDA-E racks,
- RAL 9011 black

Characteristics	Number of U	Height (mm)	Width (mm)	Depth (mm)	References
Rack with side panels	42	2000	600	600	NSYVDA42U66EN
Rack with side panels	42	2000	600	800	NSYVDA42U68EN
Rack with side panels	42	2000	600	1000	NSYVDA42U610EN
Rack with side panels	42	2000	800	600	NSYVDA42U86EN
Rack with side panels	42	2000	800	800	NSYVDA42U88EN
Rack with side panels	42	2000	800	1000	NSYVDA42U810EN

Plinths (F1)



NSYZUN66VDA

- Plinth made from folded sheet steel, RAL 7011 dark grey, epoxy-polyester, textured, powder paint
- Plinth height: 100 mm
- Allows the assembly of standard levelling feet compatible with handling wheels reference **NSYRUFNPVDA**
- Option of removing the 4 strips
- Side and rear strips equipped with a knock-out area for cable entry
- Front strip equipped with airing louvres.

Characteristics	Width (mm)	Depth (mm)	References
Plinths (F1)	600	600	NSYZUN66VDA
Plinths (F1)	600	800	NSYZUN68VDA
Plinths (F1)	600	1000	NSYZUN610VDA
Plinths (F1)	800	600	NSYZUN86VDA
Plinths (F1)	800	800	NSYZUN88VDA
Plinths (F1)	800	1000	NSYZUN810VDA

Handling wheels (M3)



NSYRUFVDA

- Set of 4 swivel wheels, 2 of which are equipped with a locking system
- Direct attachment under the bottom frame of the rack by M12 screws
- Height of the wheels: 105 mm.

Characteristics	References
Handling wheels (M3)	NSYRUFVDA

Vertical trim strips with cable entries (H2)



NSYPV24

- For enclosures with a width of 800 mm only
- Side cut-outs allowing the entry of cables every 250 mm. Knock-out entries on the front plate every 250 mm
- Assembly on the framework uprights providing aesthetic continuity between the framework and the 19" uprights positioned at least 100 mm away from the door
- RAL 7011 dark grey paint
- Cable-protection strips (not supplied) to be ordered separately
- Dismounting by 1/4-turn screws
- Set of 2 trim strips.

Characteristics	Number of U	References
Vertical trim strips with cable entries (H2)	24U	NSYPV24
Vertical trim strips with cable entries (H2)	33U	NSYPV33
Vertical trim strips with cable entries (H2)	42U	NSYPV42

VDA-L

Prepared for Ruko Locking System

Introduction

VDA-L rack, RAL 7035 Light Grey

- Designed for IT and video applications among others
- Height: 24U - 42U
- 2 widths: 600 and 800 mm
- 2 depths: 600 and 800
- Acceptable static load: 400 kg
- Dynamic load: 250 kg
- Color:
 - light Grey (RAL 7035) for lining
 - black (RAL 9011)
- Protection rating: IP20
 - protection against objects > 12.5 mm
 - no protection against liquids
- Impact Protection: IK08
 - impact energy = 5 joules
- Certifications: in compliance with directive RoHs, with 19" standard IEC 60297-3-100 and EIA-310D

Rack composition

- Top and bottom frames, mechanically assembled by Torx screws to the vertical structure uprights, thus forming a rigid framework
- Base without blanking plate
- Cut-out roof, closed with a removable plate equipped with a brush gasket
- Glazed or front door, 4 mm Securit® glass, opening to 180°, 2-point lock with a key no. EK333 and handle. Hinges on the right as standard. Option of adding a third central locking point as an accessory, with reference **NSYAEDN3PVD**
- Single rear panel
- Side panels with quick installation and removal, locking by latches
- Top and bottom side cable glands flush with the structure
- Top and bottom side knock-out areas for cable entry, with a width of 800 mm
- Large opening on the bottom and large knock-out area on the rear for cable entry
- Levelling feet
- One pair of 19" uprights made from treated steel, installed 100 mm back from the front plate and depth-adjustable in steps of 25 mm
- Delivered on a pallet wrapped with film.

Composition of the rack without side panels

- Exactly the same composition as the above rack, but without the side panels.
- Coupling kit not supplied
- If coupling is required, use the coupling kit (ref. **NSYCUNVDA**) and the brush gasket (ref. **NSYCUNPL800** or **NSYCUNPL1000**) to close the cable entry left by the 2 side panels.

VDA-L racks, RAL 9011 black

- 1 height: 42U
- 1 width: 600 mm
- 1 depths: 1000 mm

Rack composition

- Same composition to the above rack with glazed door
- Two pairs of 19" uprights made from treated steel, installed 100 mm back from the front plate and depth-adjustable in steps of 25 mm
- Delivered assembled.



Prepared for Ruko Locking System, Overview

Actassi, VDA-L

Selection guide

- VDA-L racks, RAL 7035 Light Grey

Installed enclosures								
Number of U	Dimensions (mm)			Rack with glazed door	Rack with plain door	19" uprights	100 mm plinth	Handling wheels
	Height	Width	Depth					
24	1200	600	800	NSYVDA24U68L	-	NSYBR9F24	NSYZUN68VDA	NSYRUFVDA
42	2000	600	600	NSYVDA42U66L	NSYVDA42U66LR	NSYBR9F42	NSYZUN66VDA	NSYRUFVDA
42	2000	600	800	NSYVDA42U68L	NSYVDA42U68LR	NSYBR9F42	NSYZUN68VDA	NSYRUFVDA
42	2000	800	800	NSYVDA42U88L	NSYVDA42U88LR	NSYBR9F42	NSYZUN88VDA	NSYRUFVDA
42	2000	800	600	NSYVDA42U86L	NSYVDA42U86LR	NSYBR9F42	NSYZUN86VDA	NSYRUFVDA

Selection guide

- VDA-L racks, RAL 9011 black

Installed enclosures						
Number of U	Dimensions (mm)			Rack with glazed door	100 mm plinth	Handling wheels
	Height	Width	Depth			
42	2000	600	1000	NSYVDA42U610LN	NSYZUN610VDA	NSYRUFVDA
42	2000	800	1000	NSYVDA42U810LN	NSYZUN810VDA	NSYRUFVDA

Rack with glazed door



NSYVDA24U68L

- VDA-L racks,
- RAL 7035 Light Grey

Characteristics	Number of U	Height (mm)	Width (mm)	Depth (mm)	References
Rack with glazed door	24	1200	600	800	NSYVDA24U68L
Rack with glazed door	42	2000	600	600	NSYVDA42U66L
Rack with glazed door	42	2000	600	800	NSYVDA42U68L
Rack with glazed door	42	2000	800	800	NSYVDA42U88L
Rack with glazed door	42	2000	800	600	NSYVDA42U86L

Rack with plain door



NSYVDA42U66LR

- VDA-L racks,
- RAL 7035 Light Grey

Characteristics	Number of U	Height (mm)	Width (mm)	Depth (mm)	References
Rack with plain door	42	2000	600	600	NSYVDA42U66LR
Rack with plain door	42	2000	600	800	NSYVDA42U68LR
Rack with plain door	42	2000	800	800	NSYVDA42U88LR
Rack with plain door	42	2000	800	600	NSYVDA42U86LR

Rack with glazed door



NSYVDA42U610LN

- VDA-L racks,
- RAL 9011 black

Characteristics	Number of U	Height (mm)	Width (mm)	Depth (mm)	References
Rack with glazed door	42	2000	600	1000	NSYVDA42U610LN
Rack with glazed door	42	2000	800	1000	NSYVDA42U810LN

Plinths (F1)



NSYZUN66VDA

- Plinth made from folded sheet steel, RAL 7011 dark grey, epoxy-polyester, textured, powder paint
- Plinth height: 100 mm
- Allows the assembly of standard levelling feet compatible with handling wheels reference **NSYRUFNPVDA**
- Option of removing the 4 strips
- Side and rear strips equipped with a knock-out area for cable entry
- Front strip equipped with airing louvres.

Characteristics	Width (mm)	Depth (mm)	References
Plinths (F1)	600	600	NSYZUN66VDA
Plinths (F1)	600	800	NSYZUN68VDA
Plinths (F1)	600	1000	NSYZUN610VDA
Plinths (F1)	800	600	NSYZUN86VDA
Plinths (F1)	800	800	NSYZUN88VDA
Plinths (F1)	800	1000	NSYZUN810VDA

Handling wheels (M3)



NSYRUFVDA

- Set of 4 swivel wheels, 2 of which are equipped with a locking system
- Direct fixing under the bottom frame of the rack by M12 screws
- Height of the wheels: 105 mm.

Characteristics	References
Handling wheels (M3)	NSYRUFVDA

Additional 19" uprights

- Assembly on the depthwise supports
- Depth adjustable in steps of 25 mm
- Set of 2 uprights and the fixings required for assembly
- For partial assembly use depth-support references **NSYSBRF66** to **NSYSBRF88**
- 9.5 mm square holes in the front panel.



NSYBR9F12

Characteristics	Number of U	References
Additional 19" uprights	24U	NSYBR9F24
Additional 19" uprights	42U	NSYBR9F42

VDS 19" Server Enclosure

Robust and Ventilated



Ventilated

The front and rear doors are microperforated across the width of the 19" uprights to guide the air flow through the equipment. They allow above 80% of air through for optimal airing of the live components that equip the 19" rack.



Vertical cable manager (option)

Efficient vertical cable managers can be used to duct, support and hide fiber and copper cables in improving airflow.



Rigidity and robustness

750 kg of acceptable static load.



Adaptation and customization

The configured offer allows you to equip the rack according to your needs:

- 2 framework models.
- 13 door models (microperforated double-door, etc.).
- 2 side panel models.

VDS 19" Server Enclosure

Robust and Ventilated



The airing is adjustable and does not take up any units (1 to 9 fans).



Panels and doors can be installed and removed quickly by a single operator.



Innovating

The side cable entry is the most ergonomic and efficient solution on the market. The top and bottom openings, flush with the structure, allow the strands to be prepared before installing the rack. These openings also allow for easy maintenance and are closed when the side panels are installed.



Safety

The latches of the panels can be equipped with a key locking system (the key is identical for all the doors).



Accessories

The central openings on the roof and the base support allow multiple blanking plate combinations (plain, with brush or ventilated). Option of installing the blanking plates with the roof plate thanks to the roof stand-offs.

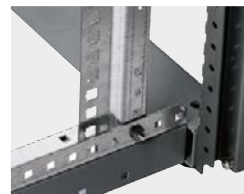

Smart

The pivot and guide system allows the panels to be returned to their place quickly, with maximum safety.



Time saving

All the doors and panels can be installed and removed quickly. The cladding can be installed and removed by a single person. The feet can be adjusted from the inside.

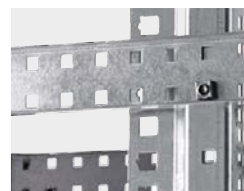

Practical

Marking of the units on the front panel and on the side for quick installation of the equipment. The 19" uprights are easily depth-adjustable on the site.

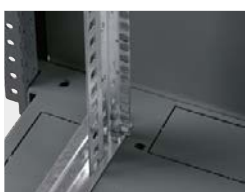

Ergonomic

The routing of the cable entries is easier:

- Side cable entries at top and bottom, pre-cut.
- Rear cable entries at the bottom, pre-cut.
- Large opening on the roof, offset towards the rear and equipped with a blanking plate.
- Allows the integration of live equipment at the top and the entry of cables from the rear.
- Large opening at the bottom.



Adaptable airing

The roof airing is depth adjustable and does not result in the loss of any units. Option of installing 1 to 9 fans according to the size of your enclosure.

VDS 19" Server Enclosure

Robust and Ventilated

Introduction

Technical characteristics

- Folded and welded sheet-steel enclosure, textured, RAL 9011 black epoxy-polyester powder paint
- Earth continuity guaranteed, according to the standard
- Allowed air flow above 80%
- Acceptable static load: 750 kg
- Color: black (RAL 9011)
- Protection rating: IP20
 - protection against objects > 12.5 mm
 - no protection against liquids
- Impact Protection: IK10
 - impact energy = 20 joules
- Certifications: in compliance with directive RoHs, with 19" standard IEC 60297-3-100 and EIA-310D

Rack composition

- Top and bottom frames, mechanically assembled by Torx screws to the vertical structure uprights, thus forming a rigid framework
- Base without blanking plate
- Cut-out roof, closed with a blanking plate with dismountable brush gasket
- Reversible microperforated front and rear door, opening to 180°, 2-point locking system with a handle and a key no. 333. Hinges on the right as standard
- Side panels, with quick installation and removal, closing by latches
- Top and bottom side cable entries flush with the structure
- Top and bottom side knock-out areas for cable entry, with a width of 800 mm
- Large opening on the bottom and large knock-out area on the rear for cable entry
- Levelling feet installed
- Four 19" uprights made from treated steel, installed 100 mm back from the front plate and depth-adjustable in steps of 25 mm
- Earthing kit installed
- Delivered on a pallet wrapped with film
- Composition of the rack without side panels
- Exactly the same composition as the above rack, but without the side panels
- Coupling kit not supplied
- If coupling is required, use coupling kit ref. **NSYCUNVDA** and brush gasket (ref. **NSYCUNPL800** or **NSYCUNPL1000**) to close the cable entry left by the 2 side panels.



19" Server Enclosure Robust and Ventilated, Overview Actassi, VDS,

Selection guide

- Server rack with and without side panels

Installed enclosures							
Number of U	Dimensions (mm)			Rack with side panels	Rack without side panels	100 mm plinth	Stand-off plinth for raised floor
	Height	Width	Depth				
24	1200	800	800		-		
24	1200	800	1000	NSYVDS24U88N	-	NSYZUN88VDA	NSYAEBP2F88
24	1200	800	1000	NSYVDS24U810N	-	NSYZUN810VDA	NSYAEBP2F810
42	2000	600	800	NSYVDS42U68N	-	NSYZUN68VDA	NSYAEBP2F68
42	2000	600	1000	NSYVDS42U610N	-	NSYZUN610VDA	NSYAEBP2F610
42	2000	800	800	NSYVDS42U88N	-	NSYZUN88VDA	NSYAEBP2F88
42	2000	800	1000	NSYVDS42U810N	NSYVDSC42U810N	NSYZUN810VDA	NSYAEBP2F810



Configured

- Configuration service: save time and rather remain focussed on your installation, letting us configure the product, color and accessories and their installation.
- One single order, one single delivery

See [page 623](#)



Specific

- Specific service: tailor-made enclosures; we specify the enclosure dimensions (15U rack, 400 mm depth, etc.), knock-outs, configuration, color and accessories and their installation for you.
- One single order, one single delivery.

See [page 623](#)

Rack with side panels



NSYVDS24U88N

Characteristics	Number of U	Height (mm)	Width (mm)	Depth (mm)	References
Rack with side panels	24	1200	800	800	NSYVDS24U88N
Rack with side panels	24	1200	800	1000	NSYVDS24U810N
Rack with side panels	42	2000	600	800	NSYVDS42U68N
Rack with side panels	42	2000	600	1000	NSYVDS42U610N
Rack with side panels	42	2000	800	800	NSYVDS42U88N
Rack with side panels	42	2000	800	1000	NSYVDS42U810N

Rack without side panels

Characteristics	Number of U	Height (mm)	Width (mm)	Depth (mm)	References
Rack without side panels	42	2000	800	1000	NSYVDS24U88N

Plinths (F1)



NSYZUN66VDA

- Plinth made from folded sheet steel, RAL 7011 dark grey, epoxy-polyester, textured, powder paint
- Plinth height: 100 mm
- Allows the assembly of standard levelling feet compatible with handling wheels reference **NSYRUFNPVDA**
- Option of removing the 4 strips
- Side and rear strips equipped with a knock-out area for cable entry
- Front strip equipped with airing louvres.

Characteristics	Width (mm)	Depth (mm)	References
Plinths (F1)	600	800	NSYZUN68VDA
Plinths (F1)	600	1000	NSYZUN610VDA
Plinths (F1)	800	800	NSYZUN88VDA
Plinths (F1)	800	1000	NSYZUN810VDA

Stand-off plinth for raised floor



NSYAEBP2F68

- Folded and welded sheet-steel frame, RAL 9005 black, epoxy-polyester, textured, powder paint
- Delivered with feet adjustable from 0 to 60 mm with holes for fixing to the floor
- Can support Actassi VDA, Actassi VDS, Spacial SM and Spacial SF enclosures
- Standard adjustment for heights from 200 mm to a maximum of 300 mm in steps of 25 mm
- Acceptable static load: 1000 kg
- To adjust heights from 335 to 435 mm, use feet reference **NSYAEBP2F4F**.

Characteristics	Width (mm)	Depth (mm)	References
Stand-off plinth for raised floor	600	800	NSYAEBP2F68
Stand-off plinth for raised floor	600	1000	NSYAEBP2F610
Stand-off plinth for raised floor	800	800	NSYAEBP2F88
Stand-off plinth for raised floor	800	1000	NSYAEBP2F810

Overhead Patching Frame

The Actassi 19" overhead patching frame allows you to use the empty space above the enclosure. Just mount the frame onto the tray, either vertically or at an angle. For mounting on Defem mesh trays, use the Defem B1 fitting. Install patch panels and make the entire enclosure beneath available for server hosting. The patching frame now works as a consolidation point, enabling flexible cabling layout as well as convenient addition of new enclosures and servers.



Robust cord managers for bending radius protection.



For maximum convenience, the brackets enable vertical or angled mounting of the frame.



Large label for clear visibility from the ground.

Actassi 19" overhead patching frame 4U



- 19" frame
- Designed to be mounted in a mesh tray or cable ladder to provide 4U patching positions and to save space in the enclosure below
- 4U height
- In compliance with directive RoHS and with 19" standards EIA 310-D and IEC 60297-3-100
- Dimensions: 500 x 350 x 160 mm
- Material: steel AN10130 DC01 painted in Raven Black
- Holds up to 15 Kg
- Equipped with two cable managers that helps securing the bending radius of the cables going down to the enclosure.
It includes 4 fastening strips of 30 cm
- Equipped with a large label holder for easy readability from the ground.

Characteristics

Overhead 19" patching frame 4U

References

VDIM33174

Locking system (P1)



NSYSTVDA

- Allows the locking of a side panel and the rear panel.
- Lock with key no. 333 with escutcheon plate
- It is installed on the opening latches of the side and rear panels
- Delivery of 2 locks per panel.

Characteristics	References
Locking system (P1)	NSYSTVDA

Adapter for 2-point locking system handle



NSYAEDN1DVD

- Assembly on the rear of the handle for doors with 2-point locking system as standard on Actassi VDA-E or Actassi VDS
- Adapter supplied without the insert.

Characteristics	Adapter	References
Adapter for 2-point locking system handle	DIN half-cylinder	NSYAEDN1DVD
Adapter for 2-point locking system handle	ASSA	NSYAEDN1AVD
Adapter for 2-point locking system handle	KABA	NSYAEDN1KVD

Key insert for 2-point locking system



NSYAEDNH2124EVD

- Assembly on the handle for doors with 2-point locking system as standard on the Actassi
- VDA-E front door or on Actassi VDS.

Characteristics	Key no.	References
Key insert for 2-point locking system	2124E	NSYAEDNH2124EVD

3rd locking point for handle



NSYAEDN3PVD

- Assembly on the handle for doors with 2-point locking system as standard on the Actassi
- VDA-E front door or on Actassi VDS
- Provides a 3rd locking point (central).

Characteristics	References
3rd locking point for handle	NSYAEDN3PVD

Key insert for 1-point locking system



NSYAEDN2124EVD

- Assembly on the handle for doors with 1-point locking system as standard on the Actassi
- VDA or on Actassi VDA-B or on the Actassi VDA-E rear door.

Characteristics	Key no.	References
Key insert for 1-point locking system	2124E	NSYAEDN2124EVD

Side panels



NSY2PLVDC24U6



NSY2PLVDC42U8N

- Panels made from folded sheet steel with plastic obturators at the ends, epoxy-polyester, textured, powder paint
- Panels with quick assembly and removal by latches
- Unit of 2 panels delivered in cardboard packaging
- Option of installing a lock with key ref. **NSYSTVDA**.

Characteristics	Number of U	Height (mm)	Depth (mm)	References
Side panel, RAL 7035 light grey	24U	1200	600	NSY2PLVDC24U6
Side panel, RAL 7035 light grey	24U	1200	1000	NSY2PLVDC24U10
Side panel, RAL 7035 light grey	33U	1600	600	NSY2PLVDC33U6
Side panel, RAL 7035 light grey	42U	2000	600	NSY2PLVDC42U6
Side panel, RAL 7035 light grey	42U	2000	800	NSY2PLVDC42U8
Side panel, RAL 7035 light grey	42U	2000	1000	NSY2PLVDC42U10
Side panel, RAL 9011 black	42U	2000	800	NSY2PLVDC42U8N
Side panel, RAL 9011 black	42U	2000	1000	NSY2PLVDC42U10N

100 mm rear extension kit (D20)

- Frame made from folded sheet steel, RAL 7035 light grey, epoxy-polyester, textured, powder paint
- Assembly on the rear of the enclosure framework
- Allows the assembly of a door or a panel
- Allows depths of 700, 900 and 1100 mm
- Delivered with assembly instructions
- Please consult us for other sizes.



NSYAEPX42U8

Characteristics	Number of U	Width (mm)	References
100 mm rear extension kit (D20)	42U	800	NSYAEPX42U8

Coupling kit (R1)

- Kit to be used when coupling two racks side by side
- Kit of 4 flanges and the fixings required for assembly.



NSYCUNVDA

Characteristics	References
Coupling kit (R1)	NSYCUNVDA

Blanking brush gasket for the cable entries between coupled racks

- Blanking plate with brush gasket
- Assembly on the top or bottom frame between two coupled racks, on the cable entry left by the 2 side panels

Supply:
Delivered with the fixings required for installation.



NSYCUNPL800

Characteristics	Depth (mm)	References
Blanking brush gasket for the cable entries between coupled racks	800	NSYCUNPL800
Blanking brush gasket for the cable entries between coupled racks	1000	NSYCUNPL1000

Vertical trim strips with cable entries (H2)



NSYPV24

- For enclosures with a width of 800 mm only
- Side cut-outs allowing the entry of cables every 250 mm. Knock-out entries on the front plate every 250 mm
- Assembly on the framework uprights providing aesthetic continuity between the framework and the 19" uprights positioned at least 100 mm away from the door
- RAL 7011 dark grey paint
- Cable-protection strips (not supplied) to be ordered separately
- Dismounting by 1/4-turn screws
- Set of 2 trim strips.

Characteristics	Number of U	References
Vertical trim strips with cable entries (H2)	24U	NSYPV24
Vertical trim strips with cable entries (H2)	33U	NSYPV33
Vertical trim strips with cable entries (H2)	42U	NSYPV42

Structure trim strips (H3)



NSYAEPF42U8

- For enclosures with widths of 600 and 800 mm
- Assembly on the framework guarantees aesthetic continuity between the framework and the 19" uprights
- RAL 7011 dark grey paint
- They do not allow the assembly of a door or a panel
- Set of 2 trim strips
- Please consult us for other sizes.

Note:
(Incompatible with Actassi VDS)

Characteristics	Number of U	Width (mm)	References
Structure trim strips (H3)	42U	800	NSYAEPF42U8

Vertical trim strips with cable entries (Incompatible with Actassi VDS)

- For enclosures with a width of 800 mm only
- Cut-outs on front panel allowing the entry of cables
- Assembly on the 19" uprights by modifying the position of the 19" upright supports
- RAL 7035 light grey paint
- Cable-protection strips (not supplied) to be ordered separately
- Set of 2 trim strips
- Please consult us for other sizes.



NSYTVRN42U

Characteristics	Number of U	References
Vertical trim strips with cable entries	42U	NSYTVRN42U

Fixing kit



NSYCFM

- Allows the rack to be fixed to the floor and/or to the wall

Supply:

Delivered with assembly instructions.

Characteristics	References
Fixing kit	NSYCFM

Wall-mounted kit for Actassi enclosures



NSYCFRS

- Allows wall-mounted of enclosures from 6U to 29U, with a depth of 600 mm
- The kit includes 2 brackets
- Maximum load inside the rack: 100 kg.

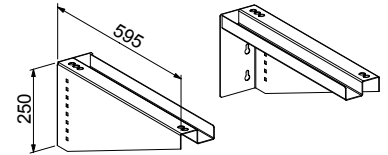

Supply:

Delivered with the fixings required for installation.

Characteristics	Depth (mm)	References
Wall-mounted kit for Actassi enclosures	600	NSYCFRS

Plain roof plate (E1)



NSYTSPC450

- Removable plate made from folded sheet steel, RAL 7035 light grey, epoxy-polyester, textured, powder paint
- Plate delivered assembled on the framework
- Option of installing roof stand-offs (reference **NSYEX206**) and blanking plates.

Characteristics	References
Plain roof plate (E1)	NSYTSPC450

Roof plate with brush gasket (E2)



NSYTSP450

- Removable plate made from folded sheet steel, RAL 7035 light grey, epoxy-polyester, textured, powder paint, equipped with a brush gasket for cable entry
- Plate delivered assembled on the framework
- Option of installing roof stand-offs (reference **NSYEX206**) and blanking plates.

Characteristics	Dimensions (mm)	References
Roof plate with brush gasket (E2)	75 x 400	NSYTSP450

Roof plate elevators for aeration (Q1)



NSYEX206

- Direct fixing between the roof and the roof plate
- Stand-offs to be ordered with a minimum of 100 pieces.

Characteristics	Height (mm)	References
Roof plate elevators for aeration (Q1)	20	NSYEX206

Plain blanking plate (J1) (K1)



NSYEC440

- Fixing on the internal surface of the base or roof
- Can be combined with other types of blanking plates
- Treated sheet steel

Supply:
Delivered with the fixings required for installation.

Characteristics	References
Plain blanking plate (J1) (K1)	NSYEC440

Blanking plate with brush gasket (J2) (K2) (L1)



NSYEC440

- Fixing on the internal surface of the base or roof or on a 6U knock-out panel of the reduced rear door
- Can be combined with other types of blanking plates
- Treated sheet steel

Supply:
Delivered with the fixings required for installation.

Characteristics	Dimensions (mm)	References
Blanking plate with brush gasket (J2) (K2) (L1)	75 x 400	NSYEC440

Blanking plate with airing louvres (J5) (K3) (L4)



NSYECAV440

- Fixing on the internal surface of the base or roof or on a 6U knock-out panel of the reduced rear door
- Can be combined with other types of blanking plates
- Treated sheet steel

Supply:
Delivered with the fixings required for installation.

Characteristics	References
Blanking plate with airing louvres (J5) (K3) (L4)	NSYECAV440

Brush gaskets for cable entry on the side panels

- Set of 2 brush gaskets
- Assembly instead of the plastic obturators, at the top or bottom of the side panels
- Cable-entry width: 35 mm.



NSYECPL600

Characteristics	Depth (mm)	References
Brush gaskets for cable entry on the side panels	600	NSYECPL600
Brush gaskets for cable entry on the side panels	800	NSYECPL800
Brush gaskets for cable entry on the side panels	1000	NSYECPL1000

Brush gasket for a knock-out area

- Assembly on the knock-out areas for cable entry
- Cable-entry width: 75 mm.



NSYJPSVD

Characteristics	References
Brush gasket for a knock-out area	NSYJPSVD

Airing plate for a knock-out area

- Fixing to the knock-out areas for cable entry
- 2 fans installed wired with a terminal block, protection grille and 3-m power cord
- Treated sheet steel
- Noise level: 34 dB (A)
- Flow rate of 35 m³/h for each fan
- Cannot be used directly with UK PDU.



NSYVL400

Supply:
Delivered with the fixings required for installation.

Characteristics	References
Airing plate for a knock-out area	NSYVL400

Blanking plate for a knock-out area

- Treated sheet steel
- Assembly on the knock-out areas for cable entry.



NSYECs400

Characteristics	References
Blanking plate for a knock-out area	NSYECs400

Sheet-edge protection strip

- 10-m roll of rubber protection strip.



NSYTPV

Characteristics	References
Sheet-edge protection strip	NSYTPV

Hoisting accessories, lifting eyes

- Set of 4 lifting eyes
- Fixing to the framework of the rack
- Maximum load: 360 kg for 4 eyes (slinging at 60°)
- Ø M12.



NSYAELM12VD

Characteristics	References
Hoisting accessories	NSYAELM12VD

Blanking plates with or without fans, Ø 120 mm (J3) (J4) (L2) (L3)

- Fixing on the internal surface of the base or roof or on a 6U knock-out panel of the reduced rear door
- Equipped with 2 or 3 fans, free flow of 170 m³/h each, 220 V-50/60 Hz, installed wired with terminal board. A 3-m power cord is supplied, installed
- Can be combined with other types of blanking plates
- Treated sheet steel
- Noise level: 34 dB (A)
- 1U front panel with thermostat
- Cannot be used directly with UK PDU.

Supply:
Delivered with the fixings required for installation.



NSYECVT2440

Characteristics	References
2 positions without fan	NSYECVT2440
2 positions with 2 fans	NSYECVT2V440
3 positions without fan	NSYECVT3440
3 positions with 3 fans	NSYECVT3V440

Filter for ventilated blanking plate

- It is fixed on top of the ventilated plates or the plates with airing louvres.



NSYFECVT440

Characteristics	References
Filter for ventilated blanking plate	NSYFECVT440

Filter for ventilated blanking plate

Top frame - 3 blanking plates					
Width	Depth	Example 1	Example 2	Example 3	Example 4
600 mm 800 mm	600 mm 800 mm 1000 mm				
Cut-out => 400 x 450 mm		400 mm	400 mm	400 mm	400 mm
Bottom frame - 2 Blanking plates					
Width	Depth	Example 1	Example 2	Example 3	Example 4
600 mm 800 mm	600 mm				
Cut-out => 400 x 300 mm		400 mm	400 mm	400 mm	400 mm
Bottom frame - 3 Blanking plates					
Width	Depth	Example 1	Example 2	Example 3	Example 4
600 mm 800 mm	800 mm 1000 mm				
Cut-out => 400 x 450 mm		400 mm	400 mm	400 mm	400 mm

13

Additional 19" uprights

- Assembly on the depthwise supports
- Depth adjustable in steps of 25 mm
- Set of 2 uprights and the fixings required for assembly
- For partial assembly use depth-support references **NSYSBRF66** to **NSYSBRF88**
- 9.5 mm square holes in the front panel.



NSYBR9F12

Characteristics	Number of U	References
Additional 19" uprights	12U	NSYBR9F12
Additional 19" uprights	21U	NSYBR9F21
Additional 19" uprights	24U	NSYBR9F24
Additional 19" uprights	29U	NSYBR9F29
Additional 19" uprights	33U	NSYBR9F33
Additional 19" uprights	38U	NSYBR9F38
Additional 19" uprights	42U	NSYBR9F42
Additional 19" uprights	47U	NSYBR9F47

Adhesive strip for marking the U

- Set of 10 self-adhesive strips
- Attached on the front panel of the 19" upright
- Allows the units to be numbered
- Length: 42U.



NSYENU

Characteristics	References
Adhesive strip for marking the U	NSYENU

Additional 19" upright supports

- Assembly in intermediate position on the framework to reinforce the rigidity of the 19" rack and/or to support the cables
- Set of 2 supports and the fixings required for assembly.



NSYSBRF66



NSYSBRF86

Characteristics	Rack width (mm)	Rack depth (mm)	References
Additional 19" upright supports	600	600	NSYSBRF66
Additional 19" upright supports	600	800	NSYSBRF68
Additional 19" upright supports	600	1000	NSYSBRF610
Additional 19" upright supports	800	600	NSYSBRF86
Additional 19" upright supports	800	800	NSYSBRF88
Additional 19" upright supports	800	1000	NSYSBRF810

Fixed partial 19" uprights

- Height: 2U
- Direct assembly on the framework of the rack, 100 mm back from the front panel
- Treated sheet steel
- Set of 2 uprights and the fixings required for assembly.



NSYBR9F2U6

Characteristics	Number of U	Rack width (mm)	References
Fixed partial 19" uprights	2	600	NSYBR9F2U6
Fixed partial 19" uprights	2	800	NSYBR9F2U8

Metric uprights

- Direct assembly on the framework, with the help of the metric uprights, instead of the 19" uprights
- Set of 2 uprights and the fixings required for assembly
- Depth adjustable in steps of 25 mm.



NSYBMF68

Characteristics	Number of U	Rack height (mm)	References
Metric uprights	68	1800	NSYBMF68

Cable-support cross-rails on framework (N)

- Direct assembly on the framework of the enclosure
- Allow cables to be secured using cable ties
- Treated sheet steel
- Set of 2 cross-rails and the fixings required for assembly.



NSYTVPSL6

Characteristics	Rack width (mm)	Rack depth (mm)	References
Cable-support cross-rails on framework (N)	600	-	NSYTVPSL6
Cable-support cross-rails on framework (N)	800	-	NSYTVPSL8
Cable-support cross-rails on framework (N)	-	600	NSYTVPSP6
Cable-support cross-rails on framework (N)	-	800	NSYTVPSP8
Cable-support cross-rails on framework (N)	-	1000	NSYTVPSP10

Standard levelling feet (M1)



NSYPNVDA

- Set of 4 feet
- Steel feet, height adjustable, from the inside of the rack
- Direct fixing, under the bottom frame or under the plinth of the rack, by M12 screws
- Height: 30 mm.

Characteristics	References
Standard levelling feet (M1)	NSYPNVDA

Anti-vibration levelling feet (M2)



NSYPRVDA

- Set of 4 feet
- Steel feet, height adjustable, with rubber collar for absorbing vibrations
- Direct fixing, under the bottom frame by M12 screws
- Height 80 mm.

Characteristics	References
Anti-vibration levelling feet (M2)	NSYPRVDA

Handling wheels (M3)



NSYRUFVDA

- Set of 4 swivel wheels, 2 of which are equipped with a locking system
- Direct fixing under the bottom frame of the rack by M12 screws
- Height of the wheels: 105 mm.

Characteristics	References
Handling wheels (M3)	NSYRUFVDA

Foot-wheels adaptation kit for plinth (M4)



NSYRUFNPVDA

- Set of 4 adaptation parts, 4 wheels without brakes and fixings
- Allows simultaneous assembly of wheel reference **NSYRUFVDA** and levelling foot reference **NSYRUFNPVDA**
- Direct assembly on the base of an enclosure equipped with a plinth
- Use the levelling feet installed as standard on the rack
- Material: treated sheet steel.

Characteristics	References
Foot-wheels adaptation kit for plinth (M4)	NSYRUFNPVDA

Foot and wheels kit for rack



NSYRUFNPVDA

- Set of 4 wheels without brakes and supports for accommodating the positioning feet
- Allows direct assembly on the base of the rack.
- Allows simultaneous assembly of wheels and levelling feet
- Use the levelling feet installed as standard on the rack
- Height of the wheels: 105 mm.

Characteristics	References
Foot and wheels kit for rack	NSYRUFNPVDA

Plinths (F1)



NSYZUN66VDA

- Plinth made from folded sheet steel, RAL 7011 dark grey, epoxy-polyester, textured, powder paint
- Plinth height: 100 mm
- Allows the assembly of standard levelling feet compatible with handling wheels reference **NSYRUFNPVDA**
- Option of removing the 4 strips
- Side and rear strips equipped with a knock-out area for cable entry
- Front strip equipped with airing louvres.

Characteristics	Width (mm)	Depth (mm)	References
Plinths (F1)	600	600	NSYZUN66VDA
Plinths (F1)	600	800	NSYZUN68VDA
Plinths (F1)	600	1000	NSYZUN610VDA
Plinths (F1)	800	600	NSYZUN86VDA
Plinths (F1)	800	800	NSYZUN88VDA
Plinths (F1)	800	1000	NSYZUN810VDA

Anti-tilt accessory (F2)



NSYZUNA800VDA

- It is fixed to a standard plinth, on the front or rear panel
- Two adjustable anti-tilt feet
- Material: folded sheet, RAL 7011 dark grey, epoxy-polyester, textured, powder paint.

Characteristics	Depth (mm)	References
Anti-tilt accessory (F2)	800	NSYZUNA800VDA
Anti-tilt accessory (F2)	1000	NSYZUNA1000VDA

Brush gasket for the cable entries of the plinth



NSYJPSVD

- It is fixed to the knock-out areas for the cable entries
- Delivery by unit.

Characteristics	Entry width (mm) x L	References
Brush gasket for the cable entries of the plinth	75 x 400	NSYJPSVD

Stand-off plinth for raised floor



NSYAEBP2F68

- Folded and welded sheet-steel frame, RAL 9005 black, epoxy-polyester, textured, powder paint
- Delivered with feet adjustable from 0 to 60 mm with holes for fixing to the floor
- Can support Actassi VDA, Actassi VDS, Spacial SM and Spacial SF enclosures
- Standard adjustment for heights from 200 mm to a maximum of 300 mm in steps of 25 mm
- Acceptable static load: 1000 kg
- To adjust heights from 335 to 435 mm, use feet reference **NSYAEBP2F4F**.

Characteristics	Width (mm)	Depth (mm)	References
Stand-off plinth for raised floor	600	800	NSYAEBP2F68
Stand-off plinth for raised floor	600	1000	NSYAEBP2F610
Stand-off plinth for raised floor	800	800	NSYAEBP2F88
Stand-off plinth for raised floor	800	1000	NSYAEBP2F810

Set of 4 feet for stand-off plinths



NSYAEBP2F4F

- Folded and welded sheet-steel feet, textured, RAL 9005 black epoxy-polyester powder paint
- They are installed on the stand-off plinths for raised floor, reusing the levelling feet delivered with the plinth
- Acceptable static load: 1000 kg on 4 feet.

Characteristics	References
Set of 4 feet for stand-off plinths	NSYAEBP2F4F

Floor-panel support bracket



NSYAEBP2FS6

- Set of 2 brackets made from folded sheet steel painted RAL 9005 black
- They are installed across the width and/or depth on the stand-off plinth to support the panels of the raised floor
- Height adjustment ± 30 mm.

Characteristics	Width (mm)	Depth (mm)	References
Floor-panel support bracket	600	600	NSYAEBP2FS6
Floor-panel support bracket	800	800	NSYAEBP2FS8
Floor-panel support bracket	1000	1000	NSYAEBP2FS10

Mounting components

Equipment support



Fixings for 19" racks

See page 608



Fixed 19" trays

See page 610

Equipment support



Telescopic 19" trays

See page 610

Power-distribution

Current distribution



19" distribution rail with or without protection

See page 613

Modular distribution



19" front plates for modular circuit breakers

See page 616

Cable-management plates

19" cover plate



19" cover plates
Painted steel: 1.5 mm

See page 620



19" cover plates with
airing louvres
Steel 1.5 mm

See page 620

Cable-management

Cable distribution



1U or 2U 19" front panels
with cable-gland openings

See page 619



1U 19" cable-gland
front panels with brush gasket

See page 619

Cable management



1U 19" front panels
with insulated guides

See page 619



1U 19" front panels with metal
guides or with cable ducting

See page 624

Thermal management

19" thermostats



1U front panel
with switch and thermostat

See page 620



1U front panel
with digital thermostat

See page 620

Cable-management plates

Lighting



Lamp to be fixed on 19"

See page 621

Earthing strip (Y)

- Two models available:
 - insulated: 10 x 5 mm brass bar with 40 connection points by screws for lugs (screws not installed)
 - non-insulated: stainless-steel bar ref. **NSYAEEC1UF**, connection by Faston lug 6.5 or by copper bar with caged terminal ref. **NSYAEEC1UN**
- Fixing to the 19" rack or to the framework
- Length: 480 mm
- Delivered with fixings
- Strip reference **NSYAEEC1UN** is equipped with caged terminal blocks.



NSYAEECS

Characteristics	Insulated	References
Earthing strip (Y)	Yes	NSYAEECS
Earthing strip (Y)	No	NSYAEEC1UF
Earthing strip (Y)	No	NSYAEEC1UN

Earthing claws



NSYAEEC100C

- Set of 100 pieces
- Provides earthing continuity of the front panels and blanking plates.

Note:

it is the installer's responsibility to help ensuring earth continuity and connection.

Characteristics	References
Earthing claws	NSYAEEC100C

Earthing kit for Actassi VDA / VDS

- Kit for earthing the cladding pieces of the enclosure
- Assembly on all the doors of the enclosure to comply with standard IEC 62208, Section 9.10 regarding the continuity of the protection circuit
- Brass and copper lugs
- Green-yellow PVC insulated sheath.

Note:

it is the installer's responsibility to help ensuring earth continuity and connection.



NSYCTVDA

Characteristics	References
Earthing kit for Actassi VDA / VDS	NSYCTVDA

For fixing components to the rear of the 19" uprights.

Nuts for 19" uprights



NSYGFR12M65

- Set of 50 M6 caged nuts
- Bag of M6 caged nuts for 12 mm square holes (holes on the rear of the 19" uprights).

Characteristics	Set of	References
Nuts for 19" uprights	50	NSYGFR12M65

Fixings for 19" rack



NSYGFR95M63

- They allow 19" accessories to be mounted
- Caged nut compatible with 8.5 x 8.5 mm and 9.5 x 9.5 mm holes.

Characteristics	Set of	References
M6 screws + washers + nuts	30	NSYGFR95M63
M6 caged nuts	100	NSYCN9M625
M6 screws + washers + nuts	50	NSYGFR95M65
M5 screws + washers + nuts	50	NSYGFR95M55

Compatible only with floor-standing enclosures

Fixed perforated and plain 19" trays, 1U

- Fixing by attachment without tools between the front and rear 19" uprights
- Sheet steel, RAL 7035 or RAL 7016 grey paint
- Acceptable load: 100 kg
- Option of installing a handle reference **NSYASR3U** on the front panel and a guide reference **NSYGCA46** on the rear panel [page 617](#).

Note:
(1) -100 ...+50 mm, adjustable in steps of 25 mm.



Characteristics	Rack depth (mm)	Fixing center-to-center distance (mm)	Color	References
Perforated 19" tray	600-800-1000	258 ⁽¹⁾	RAL 7035	NSYBBF1U40P
Perforated 19" tray	800-1000	458 ⁽¹⁾	RAL 7035	NSYBBF1U60P
Perforated 19" tray	1000	658 ⁽¹⁾	RAL 7035	NSYBBF1U80P
Plain 19" tray	600-800-1000	258 ⁽¹⁾	RAL 7035	NSYBBF1U40
Plain 19" tray	800-1000	458 ⁽¹⁾	RAL 7035	NSYBBF1U60
Plain 19" tray	1000	658 ⁽¹⁾	RAL 7035	NSYBBF1U80
Perforated 19" tray	600-800-1000	258 ⁽¹⁾	RAL 7016	NSYBBF1U40PG
Perforated 19" tray	800-1000	458 ⁽¹⁾	RAL 7016	NSYBBF1U60PG
Perforated 19" tray	1000	658 ⁽¹⁾	RAL 7016	NSYBBF1U80PG

Telescopic perforated and plain 19" trays, 1U

- Fixing by attachment without tools between the front and rear 19" uprights
- Fixing on the telescopic slides supplied
- Sheet steel, RAL 7035 or RAL 7016 grey paint
- Acceptable load: 45 kg
- Option of installing a handle reference **NSYASR3U** on the front panel and a guide reference **NSYGCA46** on the rear panel [page 617](#).

Note:
(1) Slides delivered with the tray.
(2) -100 ...+50 mm, adjustable in steps of 50 mm.



Characteristics	Mounting on slides ⁽¹⁾	Rack depth (mm)	Fixing center-to-center distance (mm)	Color	References
Perforated 19" tray	NSYGT40	600-800-1000	258 ⁽²⁾	RAL 7035	NSYBBT1U40P
Perforated 19" tray	NSYGT60	800-1000	458 ⁽²⁾	RAL 7035	NSYBBT1U60P
Perforated 19" tray	NSYGT80	1000	658 ⁽²⁾	RAL 7035	NSYBBT1U80P
Plain 19" tray	NSYGT40	600-800-1000	258 ⁽²⁾	RAL 7035	NSYBBT1U40
Plain 19" tray	NSYGT60	800-1000	458 ⁽²⁾	RAL 7035	NSYBBT1U60
Plain 19" tray	NSYGT80	1000	658 ⁽²⁾	RAL 7035	NSYBBT1U80
Perforated 19" tray	NSYGT40	600-800-1000	258 ⁽¹⁾	RAL 7016	NSYBBT1U40PG
Perforated 19" tray	NSYGT60	800-1000	458 ⁽¹⁾	RAL 7016	NSYBBT1U60PG
Perforated 19" tray	NSYGT80	1000	658 ⁽¹⁾	RAL 7016	NSYBBT1U80PG

Handle for telescopic 19" tray

- Plastic material, RAL 7011 dark grey

Supply:
Delivered with fixings.



Characteristics	References
Handle for telescopic 19" tray	NSYASR3U

Compatible only with floor standing enclosures

1U and 2U fixed 19" tray

- Fixing to the front or rear uprights of the 19" rack
- Heel of 5 mm
- Sheet steel, RAL 7035 or RAL 7016 grey paint



NSYBF1U25P

Characteristics	Number of U	Depth (mm)	Load (kg)	Color	References
Fixed 19" tray	1U	250	15	RAL 7035	NSYBF1U25P
Fixed 19" tray	2U	250	20	RAL 7035	NSYBF2U25P
Fixed 19" tray	2U	380	20	RAL 7035	NSYBF2U40P
Fixed 19" tray	2U	250	20	RAL 7016	NSYBF2U25PG
Fixed 19" tray	2U	380	20	RAL 7016	NSYBF2U40PG

2U telescopic 19" tray



NSYBT2U25P

- Fixing to the front uprights of the 19" rack
- Sheet steel, RAL 7035 or RAL 7016 grey paint
- Acceptable load: 5 kg
- Heel of 5 mm.

Supply:
Delivered with the telescopic slides assembled

Characteristics	Number of U	Depth (mm)	Load (kg)	Color	References
Telescopic 19" tray	2U	250	5	RAL 7035	NSYBT2U25P
Telescopic 19" tray	2U	250	5	RAL 7016	NSYBT2U25PG

19" screen-support tray

- Fixing by attachment without tools between the front and rear 19" uprights
- Sheet steel, RAL 7035 light grey paint

Supply:
Delivered with all the necessary fixings



NSYBSM80

Characteristics	Rack depth (mm)	Load (kg)	Color	References
19" screen-support tray	800-1000	45	RAL 7035	NSYBSM80
19" screen-support tray	1000	45	RAL 7035	NSYBSM100

19" keyboard-support tray

- Sheet steel, RAL 7035 light grey paint
- Fixing by attachment without tools between the front and rear 19" uprights
- Fixing on the telescopic slides supplied
- Optional installation of handle reference **NSYASR3U**.

Supply:
Delivered with all the necessary fixings



NSYBST80

Characteristics	Rack depth (mm)	Load (kg)	Color	References
19" keyboard-support tray	800-1000	45	RAL 7035	NSYBST80
19" keyboard-support tray	1000	45	RAL 7035	NSYBST100

Compatible only with floor standing enclosures

Fixed 19" slides

- Set of 2 slides for the 19" hardware
- Material: treated steel
- Acceptable load: 60 kg
- Heel 0 mm: fixing by attachment between the front and rear 19" uprights
- Heel ± 5 mm: fixing by screws between the front and rear 19" uprights; supplied with the slides.

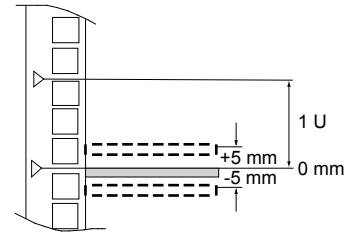

Characteristics	Rack depth (mm)	Distance between the front and rear uprights	Fixing center-to-center distance (mm)	Heel height (mm)	References
Fixed 19" slides	600-800-1000	350	258	0	NSYGF356
Fixed 19" slides	800-1000	450	358	0	NSYGF456
Fixed 19" slides	800-1000	550	458	0	NSYGF556
Fixed 19" slides	1000	650	558	0	NSYGF656
Fixed 19" slides	1000	750	658	0	NSYGF756
Fixed 19" slides	600-800-1000	350	258	± 5	NSYGF356H5
Fixed 19" slides	800-1000	550	458	± 5	NSYGF556H5
Fixed 19" slides	1000	750	658	± 5	NSYGF756H5

1U/2U Partial fixed 19" slides



- Set of 2 slides
- Fixing by attachment on the front or rear 19" uprights
- Material: treated steel
- Acceptable load: 30 kg.

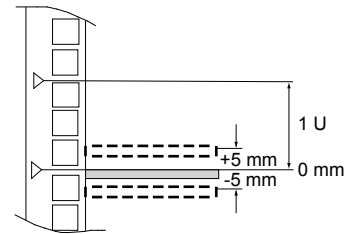

Characteristics	Number of U	Heel height (mm)	References
Partial fixed 19" slides	1U	± 5	NSYGB140H5
Partial fixed 19" slides (length=150 mm)	2U	0	NSYGB140

Full telescopic 19" slides



- Set of 2 slides for the 19" hardware
- Material: treated steel
- Acceptable load: 60 kg
- Heel 0 mm: fixing by attachment between the front and rear 19" uprights
- Heel ± 5 mm: fixing by screws between the front and rear 19" uprights; supplied with the slides.

Characteristics	Rack depth (mm)	Fixing center-to-center distance (mm)	References
Full telescopic 19" slides	600-800-1000	258, -100 ...+50 mm, adjustable in steps of 50 mm	NSYGT40
Full telescopic 19" slides	800-1000	458, -100 ...+50 mm, adjustable in steps of 50 mm	NSYGT60
Full telescopic 19" slides	1000	658, -100...+50mm, adjustable in steps of 50 mm	NSYGT80

Rear cable support



NSYBTSCS

- Fixing of cables through an opening without effort
- Direct fixing to the framework and the rear part of the tray.

Characteristics	References
Rear cable support	NSYBTSCS

Universal fixing plate



NSYEUV

- Fixing to the 19" uprights or to the framework uprights for mounting accessories
- Delivery by unit.

Characteristics	References
Universal fixing plate	NSYEUV

UTE - 16 A/230 V~ with pin-earthed outlets

- Sockets set at 35° with child protection
- Aluminum profile silver - height 1U
- Material: fiberglass polyamide plastic that helps ensuring fire resistance up to 850 °C
- Equipped with power cord (3G 1.5 mm²) type H05 VVF, equipped with a molded right-angle plug with earthing contact system
- According to NF C 61314, IEC 60884 and NBNC61112-1 standards
- Could be used in: France, Belgium, Poland, Monaco, Slovakia, Czech Republic.

Note:

- ⁽¹⁾ A: rail of sockets without protection
- ⁽²⁾ B: rail of sockets with recessed green LED switch
- ⁽³⁾ C: rail of sockets with bi-polar magnetothermal circuit-breaker C16 type C60N 16 A curve C
- ⁽⁴⁾ D: suppression filter for interferences up to 30 MHz, guaranteed frequency 400 Hz, attenuation 20 dB per decade.
- ⁽⁵⁾ E: rail of sockets with interference filter and surge suppressor, 6.5 kA short-circuit protection. Protection level Up 1.5 kV, test voltage Uoc 5 kV Uc 255 V, 50 Hz. Operation indicator light, interfaces 30 MHz. Frequency nominal 400 Hz, attenuation 20 dB per decade.
- ⁽⁶⁾ F: rail of sockets with differential protection 30 mA, 2 poles 25 A type NC



NSYAPU19F9



NSYAPU19F8S



NSYAPU19F6CB



NSYAPU19F7FA



NSYAPU19F6F



NSYAPU19F6FT



NSYAPUF10S



NSYAPUF12CB

Characteristics	Width (mm)	Depth (mm)	Type	References
19" Adapted				
9 sockets outlets	19"	44	A ⁽¹⁾	NSYAPU19F9
8 sockets outlets with recessed green led switch	19"	44	B ⁽²⁾	NSYAPU19F8S
6 sockets outlets with Overvoltage protection 16 A	19"	76	C ⁽³⁾	NSYAPU19F6CB
7 sockets outlets with Overvoltage protection 16 A + frequency filters	19"	44	D ⁽⁴⁾	NSYAPU19F7FA
6 sockets outlets with interference filter and surge suppressor	19"	76	F ⁽⁶⁾	NSYAPU19F6F
6 sockets outlets with overvoltage protection 30mA	19"	44	E ⁽⁵⁾	NSYAPU19F6FT
Vertical – 0U				
10 sockets outlets with recessed green led switch (D. 968 mm)	968	44	B ⁽²⁾	NSYAPUF10S
12 sockets outlets with Overvoltage protection 16 A (D. 1232 mm)	1232	76	C ⁽³⁾	NSYAPUF12CB

VDE - 16 A/230 V~ with pin-earthed outlets

- Sockets set at 35° with child protection
- Aluminum profile silver - height 1U
- Material: fiberglass polyamide plastic that helps ensuring fire resistance up to 850 °C
- Equipped with power cord (3G 1.5 mm²) type H05 VVF, equipped with a molded right-angle plug with earthing contact system
- According to DIN49 440, VDE0620-1, IEC 60884 and UNE20315 standards
- Could be used in: Germany, Austria, Netherlands, Italy (partial), Spain, Portugal, Sweden, Norway, Finland, Slovenia, Romania, Hungary, Afghanistan, Andorra, Vatican City, San Marino, Estonia, South Korea, Indonesia, Iceland, Chile, Bulgaria.

Note:

- ⁽¹⁾ A: rail of sockets without protection
- ⁽²⁾ B: rail of sockets with recessed green LED switch
- ⁽³⁾ C: rail of sockets with bi-polar magnetothermal circuit-breaker C16 type C60N 16 A curve C
- ⁽⁴⁾ D: suppression filter for interferences up to 30 MHz, guaranteed frequency 400 Hz, attenuation 20 dB per decade.
- ⁽⁵⁾ E: rail of sockets with Interference filter and surge suppressor, 6.5 kA short-circuit protection. Protection level Up 1.5 kV, test voltage Uoc 5 kV Uc 255 V, 50 Hz. Operation indicator light, interfaces 30 MHz. Frequency nominal 400 Hz, attenuation 20 dB per decade.
- ⁽⁶⁾ F: rail of sockets with differential protection 30 mA, 2 poles 25 A type NC



NSYAPU10S3



NSYAPU10S3S



NSYAPU19S9



NSYAPU19S8S



NSYAPU19S6CB



NSYAPU19S7FA



NSYAPU19S6F



NSYAPU19S6FT



NSYAPUS10S



NSYAPUS12CB

Characteristics	Width (mm)	Depth (mm)	Type	References
10" Adapted				
3 sockets outlets	10"	44	A ⁽¹⁾	NSYAPU10S3
3 sockets outlets with recessed green led switch	10"	44	B ⁽²⁾	NSYAPU10S3S
19" Adapted				
9 sockets outlets	19"	44	A ⁽¹⁾	NSYAPU19S9
8 sockets outlets with recessed green led switch	19"	44	B ⁽²⁾	NSYAPU19S8S
6 sockets outlets with Overvoltage protection 16 A	19"	76	C ⁽³⁾	NSYAPU19S6CB
7 sockets outlets with Overvoltage protection 16 A + frequency filters	19"	44	D ⁽⁴⁾	NSYAPU19S7FA
6 sockets outlets with overvoltage protection 30mA	19"	76	F ⁽⁶⁾	NSYAPU19S6F
6 sockets outlets with interference filter and surge suppressor	19"	44	E ⁽⁵⁾	NSYAPU19S6FT
Vertical				
10 sockets outlets with recessed green led switch (D. 968 mm)	968	44	B ⁽²⁾	NSYAPUS10S
12 sockets outlets with Overvoltage protection 16 A (D. 1232 mm)	1232	76	C ⁽³⁾	NSYAPUS12CB

Technical changes reserved. Information provided without guarantee. Images are for illustrative purposes only.

UK - 13 A/240 V~ with BS standard outlets

- Sockets set at 90° with child protection
- Aluminum profile silver - height 1U
- Material: fiberglass polyamide plastic that helps ensuring fire resistance up to 850 °C
- Equipped with power cord (3G 1.5 mm²) type H05 VVF, equipped with a molded right-angle plug with earthing contact system.

Note:
⁽¹⁾ A: rail of sockets without protection

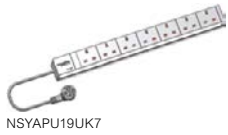

NSYAPU19UK7

Characteristics	Width (mm)	Depth (mm)	Type	References
19" Adapted				
7 sockets outlets	19"	44	A ⁽¹⁾	NSYAPU19UK7

Fixing brackets

- For vertical assembly of distribution rails
- Set of 2 brackets, adaptable to all rails, delivered with fixings
- Material: treated steel, thickness 10/10 mm
- Fixing to the ends of the rail: reference
- Fixing with an orientation of 90°: reference **NSYAPUB**.



NSYAPUBV



NSYAPUB

Characteristics	Fixing	References
Fixing brackets	End of the rail	NSYAPUBV
Fixing brackets	Orientation of 90°	NSYAPUB

19" front plate for modular circuit-breakers

- Front plates for mounting 22 modules
- Fixing to the 19" rack
- Front panel made from sheet steel, 15/10 mm thick, RAL 7035 or RAL 7016 grey paint
- Front panel made from 3 mm anodised aluminum.

Supply:
Delivered with steel DIN rail



NSYCRTM3UD



NSYCRTM3UDG



NSYCRTA4UD



NSYCRTA3UD

Characteristics	Number of U	Color	References
19" front plate for modular circuit-breakers	3U	RAL 7035	NSYCRTM3UD
19" front plate for modular circuit-breakers	3U	RAL 7016	NSYCRTM3UDG
19" front plate for modular circuit-breakers	3U	Aluminum	NSYCRTA4UD
19" front plate for modular circuit-breakers	3U	Aluminum	NSYCRTA3UD

19" DIN rail

- DIN rail for fixing on the front surface of the 19" uprights

Supply:
Delivery by unit.



NSYR19DN

Characteristics	References
19" DIN rail	NSYR19DN

Compatible only with floor standing enclosures

Side cable-support cross-rails on 19" uprights

- For mounting between the front and rear 19" uprights
- Allow cables to be flanged using cable ties
- Set of 2 pieces.



NSYTVP356

Characteristics	Rack depth (mm)	Distance between the front and rear 19" uprights (mm)	Fixing center-to-center distance (mm)	References
Side cable-support cross-rails on 19" uprights	600-800-1000	350	258	NSYTVP356
Side cable-support cross-rails on 19" uprights	600-800	550	458	NSYTVP556
Side cable-support cross-rails on 19" uprights	800-1000	750	658	NSYTVP756

Rear cable-support cross-rails on fixed 19"

- Mounting on the rear of the 19" uprights of the rack
- Allow cables to be fixed and guided at the rear of the circulation panels
- Delivered with the fixings required for installation.



NSYTVAR

Characteristics	References
Rear cable-support cross-rails on fixed 19"	NSYTVAR

Guides (X)



NSYGCA46



NSYGCA410



NSYGCA1010

Mounting on:

- The 19" uprights (laterally)
- All the cable-support cross-rails
- At the rear of the 19" shelves
 - on the framework uprights, with the help of intermediate support reference **NSYADGCA**
- Material: plastic, RAL 7035 light grey
- Guides and supports: set of 10.

Characteristics	Dimensions (mm)	References
Guides (X)	40 x 60	NSYGCA46
Guides (X)	40 x 100	NSYGCA410
Guides (X)	100 x 100	NSYGCA1010

Intermediate support



NSYADGCA

Characteristics	References
Intermediate support	NSYADGCA

Metal guides



NSYGC1010

- Installation on the 19" rack, laterally on the framework uprights inside the rack
- Set of 10 pieces.

Supply:
Delivered with the mounting elements (screw, nut)

Characteristics	Dimensions (mm)	References
Metal guides	100 x 100 guide	NSYGC1010
Metal guides	40 x 100 guide	NSYGC410

Steel wired cable tray

- Mounting on the cable supports.
- Dimensions (2 types):
1845 x 200 x 35 mm.
1845 x 200 x 54 mm.
- Material: Zinc-coated steel wire



NSYBPC3

Supply:
1 vertical steel wired cable tray and fixing elements

Characteristics	Necessary depth (mm)	References
Steel wired cable tray	35	NSYBPC3
Steel wired cable tray	54	NSYBPC5

Compatible only with floor standing enclosures

Wired guides

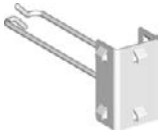

NSYGCH213

- Set of 10 wired guides
- Side-mounted on the 19" uprights
- Material: treated steel.

Characteristics	Dimensions (mm)	References
Wired guides	24 x 130	NSYGCH213

Cable guide



NSYGCP

- Helps to protect and guide the cables on the sheet edges
- Set of 10 plastic guiding flanges
- Fixed by simply clipping onto the sheet edge.

Characteristics	References
Cable guide	NSYGCP

19" vertical cable guides



NSYGC1US19

- Fixing on the 19" uprights
- Material: nickel steel
- Delivery by unit.

Characteristics	Number of U	Depth (mm)	References
19" vertical cable guides	1.5U	120	NSYGC1US19

Self-grip strips



NSYACC2N

- For holding the cables on the supports
- Models available in 3 shapes:
 - cable tie 13 mm wide, 225 mm long; set of 10 pieces
 - strap in a roll 16 mm wide and 5 metres long, black color
 - adhesive cable strap, 50 x 20 mm, black color, in a set of 10 pieces.



NSYACC50N

NSYACCA

Characteristics	Color	References
225 mm strips	Black	NSYACC2N
5 m strips	Black	NSYACC50N
Adhesive strap	Black	NSYACCA

Support for the management of cable surplus



NSYACGCS

- Used for winding cable surplus
- Delivered with the fixings required for installation.

Characteristics	References
Cable management surplus	NSYACGCS

1U 19" front panels with metal guides

- Channels the cables over the front panel of the rack
- Fixing to the 19" rack
- Sheet steel, RAL 7035 or RAL 7016 grey paint.



NSYCRTM1U32B

Characteristics	Number of guides Vert.	Number of guides Horiz.	References
1U 19" front panels with metal guides, RAL 7035	3	2	NSYCRTM1U32B
1U 19" front panels with metal guides, RAL 7035	4	0	NSYCRTM1U40B
1U 19" front panels with metal guides, RAL 7016	4	0	NSYCRTM1U40BG

1U 19" front panel with cable-gland openings

- Fixing on the 19" uprights
- Cable openings protected by a gasket
- Sheet steel, RAL 7035 or RAL 7016 grey paint.



NSYCRTM1U2

Characteristics	References
1U 19" front panel with cable-gland openings, RAL 7035	NSYCRTM1U2
1U 19" front panel with cable-gland openings, RAL 7016	NSYCRTM1U2G

1U 19" front panel with openings and cable support

- Fixing on the 19" uprights
- Cable openings protected by a gasket
- Performs the duty of a cable tray
- Sheet steel, RAL 7035 light grey paint.



NSYCRTM1UA2

Characteristics	References
1U 19" front panel with openings and cable support	NSYCRTM1UA2

1U 19" front panels with cable-gland and brush gasket

- Fixing on the 19" uprights
- Sheet steel, RAL 7035 or RAL 7016 paint
- 150 mm cable support.



NSYCRTM1U1P

Characteristics	References
With cable support at the rear, RAL 7035	NSYCRTM1U1P
With cable support at the rear, RAL 7016	NSYCRTM1U1PG
Without cable support at the rear, RAL 7035	NSYCRTM1U1PS

1U 19" front panel with insulated guides

- Channels the cables over the front panel of the rack
- Fixing on the 19" uprights
- Steel front panel, RAL 7035 light grey paint
- Equipped with 5 guides (reference **NSYGCA46**) in horizontal, vertical and 45° positions.



NSYCRTM1U5GCA

Characteristics	References
1U 19" front panel with insulated guides	NSYCRTM1U5GCA

2U 19" front panel with cable-gland openings

- Fixing to the 19" rack
- Cable openings protected by a gasket
- Sheet steel, RAL 7035 light grey paint.



NSYCRTM2U3

Characteristics	References
2U 19" front panel with cable-gland openings	NSYCRTM2U3

2U depth-adjustable 19" support

- Fixing on the 19" uprights
- Depth-adjustable from 50 to 200 mm; it allows the installation of non-19" devices or the fixing of cables, ducting, etc.
- Sheet steel, RAL 7035 light grey paint

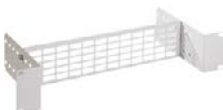

NSYCRTM2US

Characteristics	References
2U depth-adjustable 19" support	NSYCRTM2US

Supply:
Delivered with assembly fixings.

Frontal 19" cable-support cross-rails

- For frontal assembly on the 19" uprights
- Allow cables to be flanged using cable ties
- Set of 2 pieces.



NSYTVA

Characteristics	References
Frontal 19" cable-support cross-rails	NSYTVA

Plain 19" front panel

- Fixing to the 19" rack
- Front panel made from sheet steel, 15/10 mm thick, RAL 7035 or RAL 7016 grey paint
- Front panel made from 3 or 4 mm anodised aluminum
- Fixing by screws reference **NSYGFR95M65**
- Earthing claws reference **NSYAEEC100C**.



NSYCRTM1U

Characteristics	Number of U	RAL 7035 steel References	RAL 7016 steel References	Aluminum 3 mm References	Aluminum 4 mm References
Plain 19" front panel	1U	NSYCRTM1U	NSYCRTM1UG	NSYCRTA1U	NSYCRT4A1U
Plain 19" front panel	2U	NSYCRTM2U	NSYCRTM2UG	NSYCRTA2U	NSYCRT4A2U
Plain 19" front panel	3U	NSYCRTM3U	NSYCRTM3UG	NSYCRTA3U	NSYCRT4A3U
Plain 19" front panel	4U	NSYCRTM4U		NSYCRTA4U	NSYCRT4A4U
Plain 19" front panel	5U	NSYCRTM5U		NSYCRTA5U	NSYCRT4A5U
Plain 19" front panel	6U	NSYCRTM6U		NSYCRTA6U	NSYCRT4A6U
Plain 19" front panel	9U	NSYCRTM9U		NSYCRTA9U	NSYCRT4A9U
Plain 19" front panel	10U	NSYCRTM10U		NSYCRTA10U	
Plain 19" front panel	12U	NSYCRTM12U		NSYCRTA12U	

Plain 19" front panel

- Direct fixing to the 19" rack
- Sheet steel, 15/10 mm thick, RAL 7035 light grey paint
- Allow the entry of air for natural airing of the installations
- Option of installing reference **NSYCRTMR3U** with 3 fans reference: **NSYCVF65M230PF** as accessories
- Fixing by screws reference **NSYGFR95M65**
- Earthing claws reference **NSYAEEC100C**.



NSYCRTMR1U

Characteristics	Number of U	Color	References
Plain 19" front panel	1U	RAL 7035	NSYCRTMR1U
Plain 19" front panel	3U	RAL 7035	NSYCRTMR3U

1U 19" front panel with airing switch and thermostat

- Direct fixing to the 19" rack
- Switch ON/OFF with LED
- Thermostat contact open, operating temperature -20 °C ... +80 °C, temperature setting range 0 ... +60 °C, In 10 A/250 V
- Front panel made from RAL 7035 or RAL 7016 sheet.



NSYCRTM1UVT

Characteristics	Number of U	Color	References
19" front panel with airing switch and thermostat	1U	RAL 7035	NSYCRTM1UVT
19" front panel with airing switch and thermostat	1U	RAL 7016	NSYCRTM1UVTG

1U 19" front panel with digital thermostat

- Direct fixing to the 19" rack
- Thermostat 0 ... +60 °C, In 5 A/250 V
- Front panel made from RAL 7035 sheet
- Delivery with thermal sensor with 2 m of cable.







NSYCRTM1UVTD

Characteristics	Number of U	Color	References
1U 19" front panel with digital thermostat	1U	RAL 7035	NSYCRTM1UVTD



Characteristics	Multi-Fixing LED Lamps	
	This LED lamps are designed to optimize the life time, consumption, space and accessibility inside the enclosure, as well as having three fixing option as standard.	
Color	Black RAL 9005	
Protection rating	IP20 according to IEC60529	
Standards	<ul style="list-style-type: none"> IEC 60598 UL 94: For plastic components UL508A: Control Panel 	<ul style="list-style-type: none"> UL1598: Lamps UL8750: LED for lighting EN55015: EMC
Other characteristics	<ul style="list-style-type: none"> Built-in switch Power consumption: 10 W Frequency: 50/60 Hz Power factor: <ul style="list-style-type: none"> V AC lamps: 0.9 V DC lamps: 1 Luminosity: 640 lm* Light temperature: 4000 K* LED service life: 25000 h* 	<ul style="list-style-type: none"> Casing: Plastic UL94 Degree of insulation: <ul style="list-style-type: none"> Class I - Lamps with socket Class II - Lamps without socket Except NSYLAMLDVDC rated Class III Compliant with RoHS and Reach Ambient temperature: <ul style="list-style-type: none"> Operation: -16 °C to +65 °C (-3 °F to +149 °F) Storage: -10 °C to +60 °C (-14 °F to +140 °F) Max. 2 Apm and 5 lamps in serial connection
Connections	<ul style="list-style-type: none"> 3 m black or orange power cable with quick connector (Not supplied. See reference below) 1.5 m black or orange interconnection cable with quick connectors (Not supplied. See reference below) According to the directive IEC 60204-1: <ul style="list-style-type: none"> Black cables: Power circuits for switch or DC voltage. Orange cables: External voltage that may be present even if the cabinet is turned off. 	
Supply	<ul style="list-style-type: none"> 1 lamp and fixing elements 	

Lamp model	Lamps		Cables			
	Socket	References	Black cables		Orange cables	
			Power (3 m) References	Interconnection (1.5 m) References	Power (3 m) References	Interconnection (1.5 m) References
With socket 120 / 230 V AC	SCHUKO 	NSYLAMLDS	NSYLAM3M	NSYLAM1M	NSYLAM3MN	NSYLAM1MN
With socket 120 / 230 V AC	UTE 	NSYLAMLDF	NSYLAM3M	NSYLAM1M	NSYLAM3MN	NSYLAM1MN
With socket 120 / 230 V AC	British 	NSYLAMLDB	NSYLAM3M	NSYLAM1M	NSYLAM3MN	NSYLAM1MN
With socket 120 V AC	USA 	NSYLAMLDU	NSYLAM3MUL	-	NSYLAM3MULN	NSYLAM1MULN
Without socket 120 / 230 V AC	-	NSYLAML	NSYLAM3M	NSYLAM1M	NSYLAM3MN	NSYLAM1MN
Without socket 120 / 230 V AC	-	-	NSYLAM3MUL	-	NSYLAM3MULN	NSYLAM1MULN
Without socket	-	NSYLAMLDD	NSYLAM3M	NSYLAM1M	NSYLAM3MN	NSYLAM1MN
With presence detection 230 V AC	-	-	NSYLAM3MUL	-	NSYLAM3MULN	NSYLAM1MULN
Without socket	-	-	NSYLAM3MUL	-	NSYLAM3MULN	NSYLAM1MULN
With presence detection 230 V AC	-	-	-	-	-	-
Without socket - DC 24-48 V DC	-	NSYLAMLDVDC	NSYLAM3MDC	-	-	-
Without socket - DC 24-48 V DC	-	-	NSYLAM3MDCUL	-	-	-

Fixing options

Fixing by sliding brackets



Magnetic fixing.



Fixing to DIN rail.

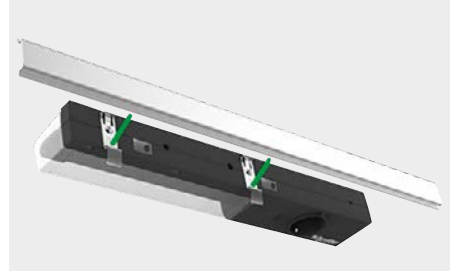

Rack for VDI

- 1 U, 19" rack. For lamp installation in VDI enclosures.



Characteristics

Rack for VDI

Supply:

supplied with fixing elements.

References

NSYLAM1U

Technical changes reserved. Information provided without guarantee. Images are for illustrative purposes only.

The Customized Offer

Do you want to have other enclosures than standard? No problem.

With Actassi enclosures it's possible to customize color, accessories, specific lining, etc. according to your personal needs.

Two levels of customization

At Schneider Electric we have developed two levels of customized services based on more than 50 years of experience in the market:

- Configured offer (standard, modified)
- Specific offer (custom-built enclosures).



We perform machining, mounting of accessories and painting.



We manufacture customized solutions with our industrial tools.
Example: cut-outs made before painting.

Flexibility

Several types of side panels

Functionality

Defined thermal management

Time-saving

Factory-made assemblies



Aesthetics

Color

Mounting

Accessories mounted in our factories

Efficiency & ergonomics

Several types of doors

Examples of Customized Solutions

Configured offer



Configured



Make your own definition based on our standard claddings.

Example: Actassi VDA enclosure in RAL 9011

Equipped with:

- Double front door with two-point locking system. Airflow above 80%
- Double rear door with two-point locking system. Airflow above 80%
- Two side doors with locks
- Roof equipped with 6 fans and 1 cable entry with brush seal

Specific offer



Specific





















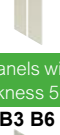





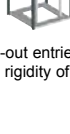

Built exactly according to your needs

Custom-made Actassi VDA-VDS enclosure

- Specify yours needs on VDA-VDS enclosures or spare parts.
- This enclosure is delivered equipped, machined and ready to use.

Definition example

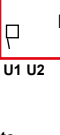
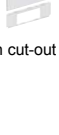
Number of	Size guide		Rack elements									
	Width (mm)	Depth (mm)	Framework	Side panels	Front door							
					Single (1)	Double (2)	Single-door (1)					
24	600	600	 With cut-out entries	 Plastic obturator	 Plain	 Plain	 Plain					
		800						600	800	600	800	
		1000						800	1000	800	1000	
29	600	600	 Without cut-out entries	 With louvres / Without louvres Brush gasket	 Glazed	 Glazed	 Glazed					
		800						600	800	600	800	
		1000						800	1000	800	1000	
33	600	600	 Without cut-out entries	 Lateral panels with louvres, thickness 50 mm	 Microperforated	 Microperforated	 Microperforated					
		800						600	800	600	800	
		1000						800	1000	800	1000	
38	600	600	 With cut-out entries on the top frame, rigidity of 500 kg	 Plastic obturator gasket / Brush	 Panel lock kit	 Rear	 Front	 Partial with plain panel				
		800							600	800	600	800
		1000							800	1000	800	1000
42	600	600	 Without cut-out entries on the top frame, rigidity of 500 kg	 Coupling kit	 Door opening direction	 Partial with cut-out panel						
		800					600	800	600	800		
		1000					800	1000	800	1000		
47	600	600	 Without cut-out entries on the top frame, rigidity of 500 kg	 Coupling kit	 Door opening direction	 Partial with cut-out panel						
		800					600	800	600	800		
		1000					800	1000	800	1000		

(1) In red: doors with 2-point locking system
 (2) In blue: double doors with 3-point locking system

S T		
1	RAL 7035	1
2	RAL 5015	2
3	RAL 3003	3
4	RAL 9001	4
5	RAL 7011	5
6	RAL 1021	6
7	RAL 9011	7
Other colors, consult us		

Simplified order
 Tick here to show whether this is an order or a price request (estimate).

Please specify the reference number of your request.

Order Estimate

Your ref.

Configure your rack

Number of identical racks required

No.	U	Width	Depth	A	B	C	D	E	F	G	H	J	K	L	M	N	P	Q	R	S	T	U	V	W	X	Y	Z	
29	600	800						2			1		1	3	2													

Company Name
 Address Telephone
 Postcode - Town Fax
 Photocopy this form and fax it to your sales office E-mail

Easy
 Please specify the dimensions of the required rack.

Smart
 If your order is only for spare parts, please use the configuration sheet on page XXX.

Please specify the reference of the chosen element.
 Example: E2 is a roof plate with brush gasket.

Choice
 Your choice of colors.
 Example: grey uprights and yellow cladding.



Rack elements

Rear		Rear panel	Roof plate	Plinth	19" upright	Escutcheon	Top blanking plate
Double-door (2)							
D6 Plain D7	D4 Plain	E1 Plain E2 Brush gasket E3 Perforated	F1 F2 Anti-tilt	G1 Front G2 Front and rear G3 Partial 19" uprights G4 12U partial front and rear	H2 Cable gland width 800 mm H3 Of the structure	J2 J1 Plain Brush gasket J3 J4 3 fans 2 fans J5 Airing louvres Bottom blanking plate K2 K1 Brush gasket K3 Airing louvres Rear blanking plate L1 Brush gasket L2 L3 3 fans 2 fans L4 Airing louvres	
D10 Glazed Microperforated	D20 Rear extension kit, 100 mm thick Z3 Panel earthing	Q1 Roof stand-offs	M1 Base accessories Levelling feet M2 Anti-vibration feet M3 Wheels M4 Foot-wheels adaptation kit				

Non-mounted accessories description

Non-mounted accessories description	Ref. No	Amount
1U 19" front plate	NSYCRTM1U32B	2
5U front panel	NSYCRTM5U	1
1U fixed shelf	NSYBBF1U40	2
2U adjustable support	NSYCRTM2US	1
.....
.....

Smart

To order exactly identical racks, please specify the number of racks required.
To order different racks, fill in a separate form for each type of rack.

Please specify the required rack accessories.

Practical

Choose the door opening direction.

Elements of a rack

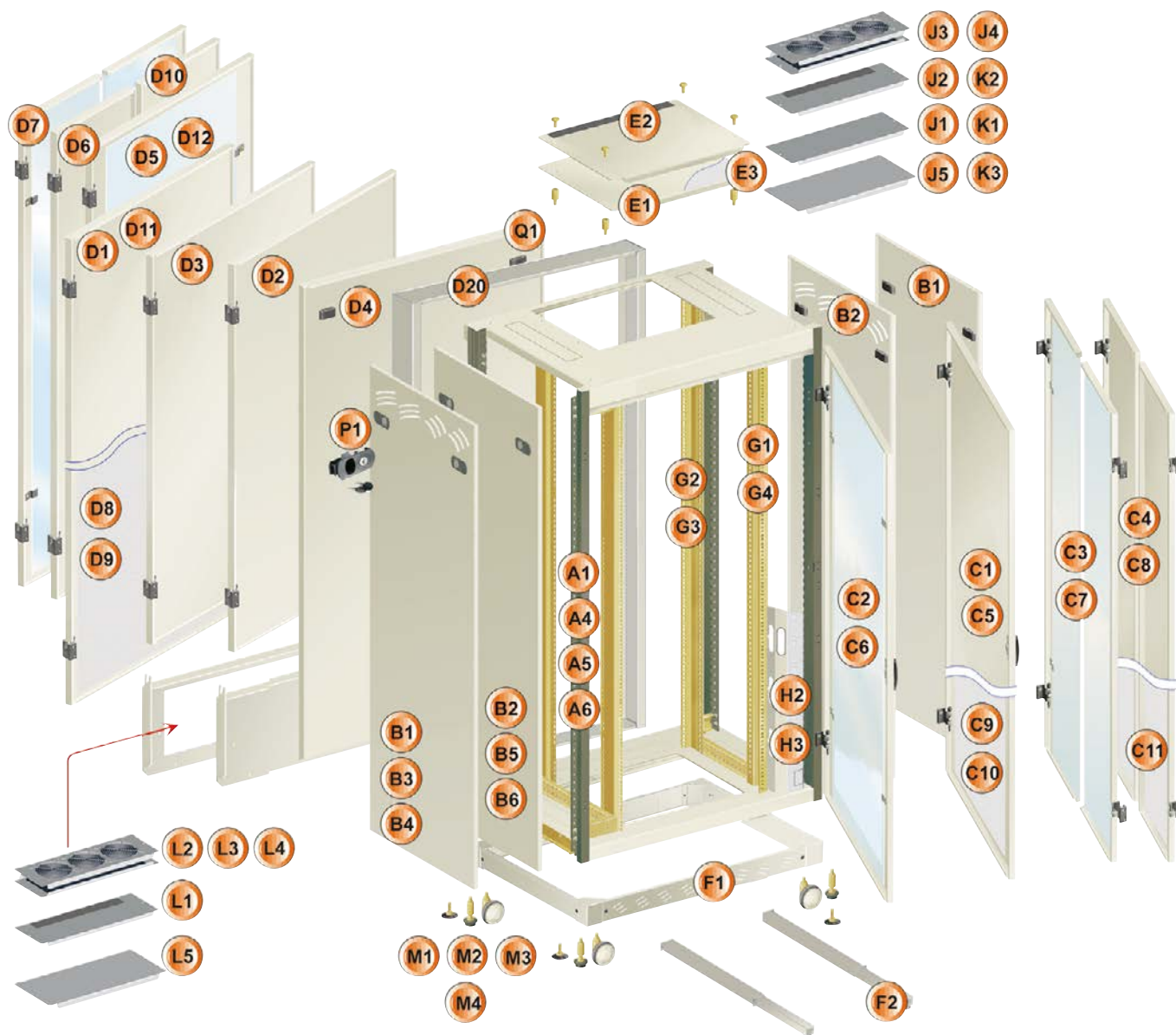

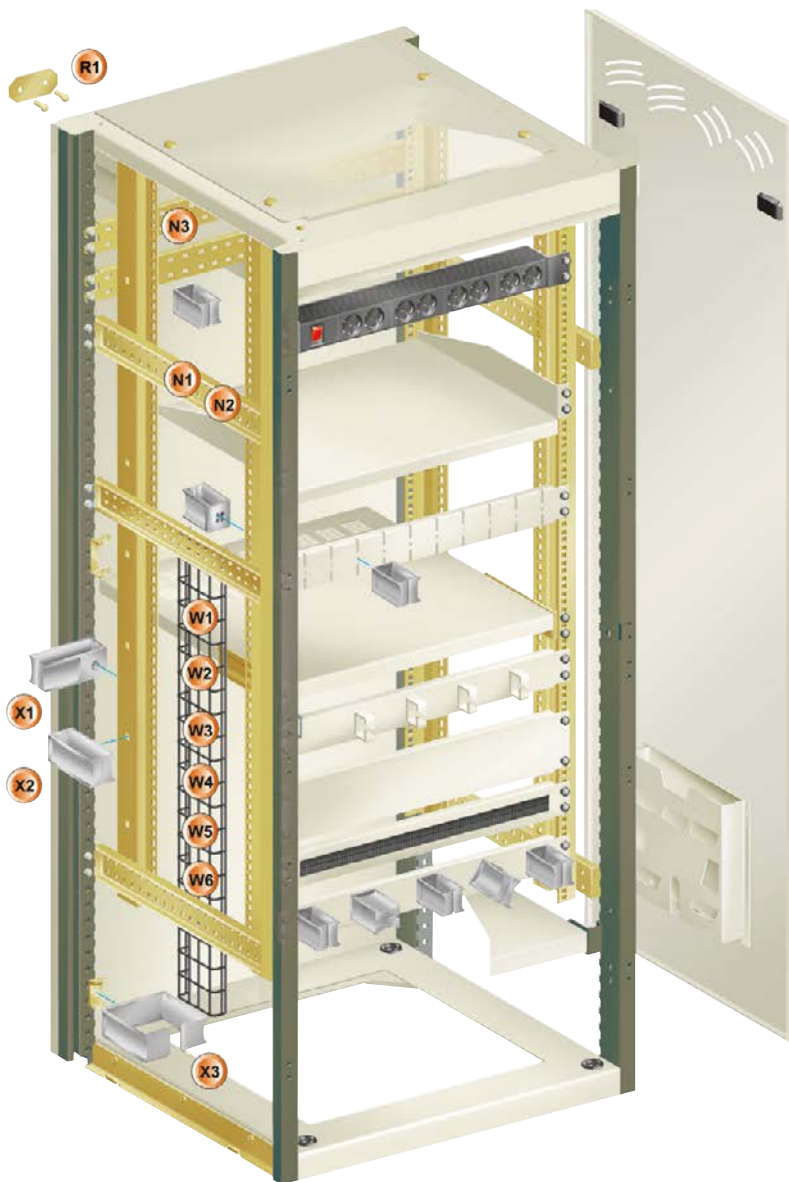

- A Framework
- B Side panels
- C Front doors
- D Rear doors or panels
- E Plain roof plate
- F Plinths
- G 19" uprights
- H Trim strips
- J Blanking plates for the top of the rack
- K Blanking plates for the bottom of the rack ⁽¹⁾
- W Blanking plates for the rear of the rack (1 plate)
- M Standard levelling feet
- N Cable-support cross-rails
- D Lock kit for rear and side panels
- Q Roof stand-offs
- R Coupling kit
- S Color of the paint on the structure uprights
- T Color of the paint on the cladding elements
- W Steel wired cable trays
- X Cable-gland guides
- Y Earthing strips
- Z Door switch, fixings, earthing kit

⁽¹⁾ Number of plates

Rack depth (mm)	Number of plates at the top	Number of plates at the bottom
600	3	2
800	3	3
1000	3	3

Definition example

Rack elements	
A1	Framework with knock-out entries (top frame)
A4	Framework without knock-out entries (top frame)
A5	Framework with knock-out entries (top frame) rigidity 500 kg
A6	Framework without knock-out entries (top frame) rigidity 500 kg

Cladding accessories	
B1	Side panels with airing louvres
B2	Side panels without airing louvres
B3	Side panels, with 50 mm airing louvres
B4	Side panels, with airing louvres and brush gasket
B5	Side panels, without airing louvres and brush gasket
B6	Side panels with 50 mm airing louvres and brush gasket
R1	Coupling kit
P1	Lock kit for rear and side panels
C5	C1 Plain front door (1)
C6	C2 Glazed front door (1)
C7	Front door with double leaf, glazed (2)
C8	Front door with double leaf, plain (2)
C10	C9 Microperforated front door (1)
C11	Front door with double leaf, microperforated (2)
	H3 Structure trim strips (rack without door)
D11	D1 Plain rear door (1)
	D2 Partial rear door with plain 6U panel
	D3 Partial rear door with cut-out 6U panel
	D4 Rear panel
D12	D5 Glazed rear door (1)
D6	Rear door with double leaf, plain (2)
D7	Rear door with double leaf, glazed (2)
D9	D8 Microperforated rear door (1)
D10	Rear door with double leaf, microperforated (2)
	D20 Rear extension kit
	E1 Plain roof plate
	E2 Roof plate with brush gasket
	E3 Perforated roof plate
	Q1 Roof stand-offs
	Z3 Panel earthing kit
	S Color of the structure upright paint
	T Color of the paint of the cladding elements

Base accessories	
F1	Plinth
F2	Anti-tilt plinth
M1	Standard levelling feet
M2	Anti-vibration levelling feet
M3	Handling wheels
M4	Wheel adaptation kit

Blanking plates for the top of the rack (3)	
J1	Plain blanking plate
J2	Blanking plate with brush gasket
J3	Blanking plate with 3 fans
J4	Blanking plate with 2 fans
J5	Blanking plate with airing louvres

Blanking plates for the bottom of the rack (3)	
K1	Plain blanking plate
K2	Blanking plate with brush gasket
K3	Blanking plate with airing louvres

Blanking plates for the rear of the rack (1 plate)	
L1	Blanking plate with brush gasket
L2	Blanking plate with 3 fans
L3	Blanking plate with 2 fans
L4	Blanking plate with airing louvres

Installation accessories	
G1	Front 19" uprights and depth supports
G2	Front/rear 19" uprights and depth supports
G3	12U partial 19" uprights
G4	Front/rear 12U partial 19" uprights installed at the top
Z2	Bag of 19" fixings (30 pieces)

Cable-management accessories	
H2	Trim strips with cable glands (rack width 800 mm)
N1	Cable-support cross-rails on framework, on the left
N2	Cable-support cross-rails on framework, on the right
N3	Cable-support cross-rails on framework, on the rear
W1	Wired cable tray, 35 mm deep, on the left
W2	Wired cable tray, 35 mm deep, on the right
W3	Wired cable tray, 35 mm deep, on the rear
W4	Wired cable tray, 70 mm deep, on the left
W5	Wired cable tray, 70 mm deep, on the right
W6	Wired cable tray, 70 mm deep, on the rear
X1	40 x 60 mm guides mounted on the 19" uprights
X2	40 x 100 mm guides mounted on the 19" uprights
X3	100x 100 mm guides mounted on the 19" uprights

Complementary accessories	
Y1	Insulated earthing strip
Y2	Non-insulated earthing strip
Z1	Door switch (corresponding to NSYAEDWVD)
Z2	Bag of fixings (50 screws + nuts)
Z3	Panel earthing kit

⁽¹⁾ Code in red: doors with 2-point locking system.

⁽²⁾ Code in blue: double-door with 3-point locking system.

⁽³⁾ Top frame: always 3 plates; bottom frame depth 600 mm: 2 plates; depth 800 and 1000 mm: 3 plates.

Example of realisations



Colocation 19" enclosure

Enclosure separated in 4 parts to give different access to each customer. Each hosted customer has his own secured access and cannot make some operation to the other part of the enclosure



Branded 19" enclosure equipped with saloon glazed doors

Enclosure totally customized with the customer requirements. 42U enclosure equipped with double glazed doors permits to open the doors when you don't have space.



Ventilated 19" enclosure with fans mounted on the doors

Enclosure dedicated to extract a lot of heat. Mainly dedicated to server application. This configuration permits to help ensuring the stability of the installation



19" enclosure – depth 400 mm

19" enclosure with a very limited depth (Depth 400 mm) for cabling application. Required by the customer to reduce the size of the installation.



Racks structure merged with a center zone cabling

Totally dedicated for cabling, this structure permits to easily manage the cables and to give the best access to install the components.



Wall-mounted enclosure – depth 1000 mm

Enclosure totally customized with the customer requirements. 12U – Width 600 mm and Depth 1000 mm.

Degree of protection

Standard IEC 60364-5-51 lists and codifies a large number of external influences to which electrical installations can be subjected, including the presence of water, solid objects, shocks, vibrations, corrosive substances, etc.

IP code

Standard IEC 60529 (IP code, February 2001) indicates the degrees of protection provided by an enclosure for electrical devices against access to hazardous parts, against penetration of solid foreign objects and against penetration of water. These standards do not apply for the protection against the risks of explosion or conditions such as humidity, corrosive vapor, fungus or vermin. The IP code is made up of two characteristic numerals and can include an additional letter when the actual protection for persons against access to the hazardous parts is better than that indicated by the first numeral. The first numeral characterises the protection provided against the ingress of solid foreign objects and the protection of persons. The second numeral characterises the protection provided against the ingress of water with harmful effects.

1 st numeral Protection of persons	Protection against ingress of solid objects	2 nd numeral Protection against ingress of water
1 Helps protecting against access with back of hand 	Protection against solid foreign objects larger than 50 mm 	1 Helps protecting against vertically dripping water (condensation)
2 Helps protecting against access with a finger 	Protection against solid foreign objects larger than 12.5 mm 	2 Helps protecting against dripping water up to 15° from vertical
3 Helps protecting against access with a tool 	Protection against solid foreign objects larger than 2.5 mm 	3 Helps protecting against spraying water up to 60° from vertical
4 Helps protecting against access with a wire 	Protection against solid foreign objects larger than 1 mm 	4 Helps protecting against splashing water from all directions
5 Helps protecting against access with a wire 	Helps protecting against dust (dust protected) 	5 Helps protecting against water jets from all directions
6 Helps protecting against access with a wire 	Dust tight 	6 Helps protecting against powerful water jets from all directions
		7 Helps protecting against the effects of temporary immersion in water
		8 Helps protecting against the effects of continuous immersion in water

IK code

Standard IEC 62262 defines an IK code characterising the capacity of products to resist mechanical impacts from all sides.

IK code	Impact energy (joules)
01	0.14
02	0.2
03	0.35
04	0.5
05	0.7
06	1
07	2
08	5
09	10
10	20

IK codes can be selected according to the risks of impacts on a given site.

Risk	Site	Recommended IK
No risk of major impact	Technical premises	07
Significant risk of impact that can damage devices	Hallways	08 (switchboard with door)
Maximum risk of impact that can damage the switchboard	Workshops	10

Technical changes reserved. Information provided without guarantee. Images are for illustrative purposes only.

VDA-VDS Floor standing Enclosures
OPB Wall-mounted Enclosures

Commercialized CR

Description	Complement	References
2 points locking system VDA 42U		NSYVDA42ULS2P
Kit SAV VDA		NSYVDASAVKIT
Glazed door VDA R7035 42U W600		NSYVDA42U6GGD
Glazed door VDA R7035 42U W800		NSYVDA42U8GGD
Ventillated door VDA/VDS R9011 42U W800		NSYVDA42U8BVD
Doble ventillated door VDA/VDS R9011 42U W800		NSYVDA42U8DBVD
Actassi - key - set of 2 - n° 333		NSYLL333

Some spare-parts are part of customized offer: services can answer your needs

Description	Customized offer	For
Rear panel VDA R7035 24U W600	Be ordered by Configured offer (CTO) or Specific offer (ETO)	VDA24U
Rear panel VDA R7035 24U W800	Be ordered by Configured offer (CTO) or Specific offer (ETO)	VDA24U
Rear panel VDA R7035 29U W600	Be ordered by Configured offer (CTO) or Specific offer (ETO)	VDA29U
Rear panel VDA R7035 29U W800	Be ordered by Configured offer (CTO) or Specific offer (ETO)	VDA29U
Rear panel VDA R7035 33U W600	Be ordered by Configured offer (CTO) or Specific offer (ETO)	VDA33U
Rear panel VDA R7035 33U W800	Be ordered by Configured offer (CTO) or Specific offer (ETO)	VDA33U

Commercialized CR

Description	Customized offer	For
Rear panel VDA R7035 38U W600	Be ordered by Configured offer (CTO) or Specific offer (ETO)	VDA38U
Rear panel VDA R7035 38U W800	Be ordered by Configured offer (CTO) or Specific offer (ETO)	VDA38U
Rear panel VDA R7035 42U W600	Be ordered by Configured offer (CTO) or Specific offer (ETO)	VDA42U
Rear panel VDA R7035 42U W800	Be ordered by Configured offer (CTO) or Specific offer (ETO)	VDA42U
Rear panel VDA R7035 47U W600	Be ordered by Configured offer (CTO) or Specific offer (ETO)	VDA47U
Rear panel VDA R7035 47U W800	Be ordered by Configured offer (CTO) or Specific offer (ETO)	VDA47U
Glazed door VDA R7035 24U W600	Be ordered by Configured offer (CTO) or Specific offer (ETO)	VDA24U
Glazed door VDA R7035 24U W800	Be ordered by Configured offer (CTO) or Specific offer (ETO)	VDA24U
Glazed door VDA R7035 47U W600	Be ordered by Configured offer (CTO) or Specific offer (ETO)	VDA47U
Glazed door VDA R7035 47U W800	Be ordered by Configured offer (CTO) or Specific offer (ETO)	VDA47U

Description	Customized offer	For
2 points locking system VDA 24U	Be ordered by Specific offer (ETO)	VDA24UP
2 points locking system VDA 38U	Be ordered by Specific offer (ETO)	VDA38U
2 points locking system VDA 47U	Be ordered by Specific offer (ETO)	VDA47U

ClimaSys Thermal Management System

Thermal management system



Introduction

Presentation	634
ClimaSys Smart Airing Systems	640
ClimaSys CV Airing Systems	652
ClimaSys CA Natural Airing	666
ClimaSys CE Exchangers	668
ClimaSys CU Cooling Units	678
ClimaSys CRS Ultra-thin Resistance Heaters	696
ClimaSys CR Resistance Heaters	698
ClimaSys CC Thermal Control	702
ClimaSys DT Dataloggers	706
How to determine a thermal management solution	708

Thermal problems in enclosures

Evolution of the electrical switchboard

An electrical switchboard is an assembly formed of the following components:

- The enclosure;
- Switchgear and controlgear;
- Electrical conductors; and
- Miscellaneous functions (displays, controls, information processing).

It has evolved in three directions:

- Enclosures increasingly made of insulated materials;
- Switchgear and controlgear incorporating more and more electronics which concentrates a growing number of functions in an increasingly small volume;
- An increasingly high filling rate.



Industrial safety studies, a concept which covers:

- The safety of personnel and equipment;
- The availability of electric power;

These two aspects are the critical point of all industrial and service-sector activities.

Operation must therefore be perfectly under control; and this control must concern not only the operation of the components but also their operating conditions in a given environment.

Temperature and humidity in the enclosure

Analysis of the malfunctions and downtimes of an electrical installation shows that they are mostly of thermal origin: Temperature too high or too low inside the enclosure.

The rise of the average temperature above the limits tolerated by the equipment is often caused by changes to the electrical switchboard:

- Use of insulated materials for the enclosure impairing heat dissipation,
- An increasing number of electronic devices and a higher filling rate increase the temperature.

Such overheating may only occur at certain points of the installation called 'hot spots'.

Excessively low temperatures occur when the electrical switchboard is installed in a very cold environment. This can cause the formation of condensate which is harmful to the equipment.

Consequences

The presence of humidity or excessively high temperatures inside the enclosure can cause numerous malfunctions:

- Nuisance tripping of protective devices;
- Fire inside the enclosure;
- Burns for the users;
- Premature equipment ageing;

These malfunctions lead to an increase in the installation's operating costs:

- Maintenance costs,
- Costs entailed by installation downtimes.

Solution: Thermal management

Objective

The thermal management solution adopted shall:

- Maintain the temperature and humidity level inside the enclosure at values corresponding to normal operation of the equipment.
- Establish a uniform temperature to prevent hot spots.

Choice of solution

The products constituting the thermal management solution are selected to obtain a thermal balance of the installation. This comprises 2 parts:

- Thermal balance inside the enclosure;
- Evaluation of the climatic conditions (temperature, humidity level) or environmental conditions (pollution) of the location of the electrical switchboard.

The Schneider Electric solutions

With the ClimaSys range, Schneider Electric proposes a comprehensive offer meeting all needs:

- Airing
- Cooling
- Heating
- Regulating
- Homogenizing (air circulation)

Schneider Electric also proposes a thermal design software program, ProClima, which produces the thermal balance and proposes one or more thermal management solutions.

Characteristics	Smart Climasys	Climasys
Cooling^	 <p>Smart airing systems</p>	 <p>Forced-airing systems Air-to-air exchangers Air-to-water exchangers Cooling units</p>
Heating		 <p>Resistance heaters</p>
Controlling	 <p>Smart thermal control accessories</p>	 <p>Thermal control accessories</p>
Thermal Data	 <p>Diagnostic tools</p>	 <p>Proclima software</p>

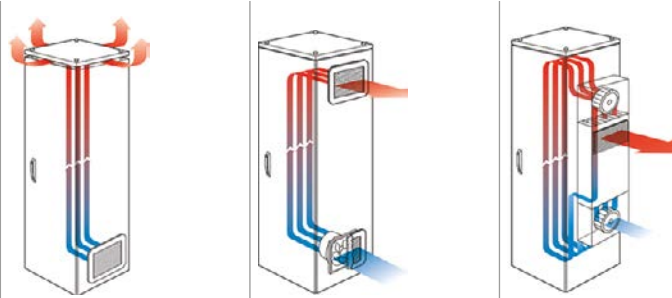

	Homogenize	Cooling	Cooling	Cooling
Solution	Air circulation	Natural airing	Forced-airing	Air-to-air exchanger
Description	Circulation fan inside the enclosure	Air circulation achieved by installing grids (side or roof-mounted) with or without filter, or by elevating the roof.	A fan (with or without filter) feeds fresh external air into the enclosure. This creates a slight overpressure, forcing the warm air out of the enclosure through an outlet grid. The air flow balances the temperature, and the overpressure prevents dust ingress. Side or roof-mounted. Can be combined with a thermostat.	Cooling system comprising an aluminum heat exchanger and separate internal and external air circuits and two centrifugal fans circulating the air, and a thermostat for temperature control. Side or roof-mounted.
Use	To prevent hot spots	Low power to be dissipated. Dusty environment	High heat dissipation performance, suitable for dusty and non-hazardous environments. Prevents hot spots.	Medium heat dissipation performance, suitable for corrosive environments (food processing) and relatively cold environments (approx. 25 °C)
Temperature conditions Ta = ambient temperature (outside the enclosure) Td = desired temperature inside the enclosure	None	$T_d > T_a + 5\text{ °C}$	$T_d > T_a + 5\text{ °C}$ $3\text{ °C} < T_a \leq 35\text{ °C}$	$T_d > T_a + 10\text{ °C}$
Independent internal and external air circuits?	No	No	No	Yes
Advantages	<ul style="list-style-type: none"> Uniform temperature inside the enclosure 	<ul style="list-style-type: none"> Very economical solution No maintenance Easy, fast installation. 	<ul style="list-style-type: none"> Economical solution Easy maintenance Easy, fast installation Uniform temperature inside the enclosure Guaranteed level of protection: IP54 (IP55 with cover) 	<ul style="list-style-type: none"> Easy maintenance (no filter) Far lower maintenance frequency than for fans IP55 guaranteed between the enclosure and the air-to-air exchanger.
Disadvantages		<ul style="list-style-type: none"> Low power dissipated Reduction of IP rating Risk of ingress of particles and dust if no filter. 	<ul style="list-style-type: none"> Internal temperature always higher than external temperature Maintenance required: filter change. 	<ul style="list-style-type: none"> Internal temperature always higher than external temperature.
Illustration				
		Outlet grids	Fans	Air-to-air exchangers



Cooling
Air-to-water exchanger

Cooling system using an exchanger coil supplied with cold water, separated from the internal air circuit, a centrifugal fan for air circulation, and a thermostat to regulate the temperature inside the enclosure. Side-mounting.

Dissipation of large quantities of heat. Suitable for difficult environments (cement plants, production lines, etc.) or humid environments (sewage plants, bottling lines, etc.). Calorific energy is not discharged to the environment.

$T_a > T_d$

Yes

- Internal temperature independent of external temperature
- Protection system against any leaks
- Calorific energy dissipated externally.
- Guaranteed level of protection: IP55.

- Cold-water circuit with stabilized temperature and flow rate required
- Installation of special piping.



Air-to-water exchangers

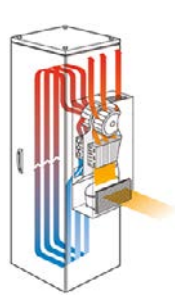

Cooling
Cooling unit

Operates like a heat pump: A condenser dissipates the calorific energy absorbed by an evaporator to the ambient air, thereby cooling and drying the air in the enclosure. Mounted on sides, floor, roof and floor-standing.

Highly polluted environment permitting the use of a filter for external protection of the cooling unit.

$T_a > T_d$ and $T_a \leq 55^\circ\text{C}$

Yes

- Internal temperature independent of external temperature
- Even temperature inside the enclosure.
- Guaranteed level of protection: IP54 for roof and big cooling models, IP55 for side-mounted models and the SLIM range
- Use of an ecological gas
- Drainage system for condensed water from evaporator

- Water condensation evaporation unit integrated in side-mounted models from 0.6 kW to 4 kW
- Maintenance required: filter change.



Cooling units

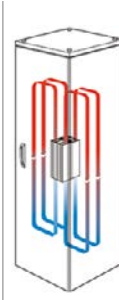

Heating
Resistor heaters

The heating resistors help prevent the formation of condensation and ensure an ideal temperature inside the enclosure.

To heat the inside of the enclosure and prevent condensation.

$T_a < T_d$

-

- Small size (1.6 mm thick for the ultra-thin version)
- Low surface temperature (< 70 °C for insulated version, 75 °C for aluminum version)
- Even temperature inside the enclosure with the version equipped with a fan.



Heating resistors

Large range of fans:
flow rate efficiency, high protection rating, quick installation and easier maintenance to secure all the applications.

Airing systems

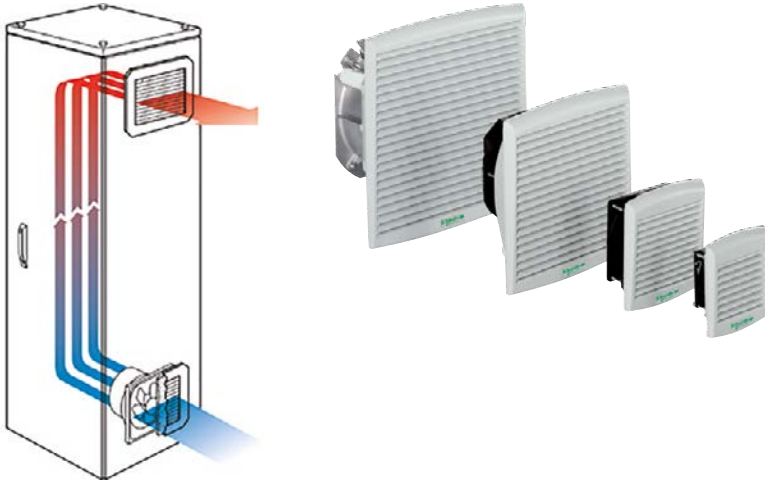

Easy maintenance

Quick filter replacement

- Quick, easy and safe replacement of the filter installed in the fan, even during operation.



Certifications

- UL



Quality of components

Selection of motors

- Improved flow rate and longer service life.
- Large range of input voltages available on all motors delivered as standard, with 50/60-Hz alternating current or direct current

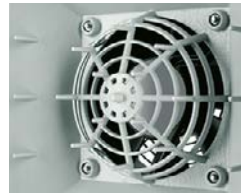

Optimized flow rate: average increase of 50%

- Maximum use of surface.
- Minimal loss of pressure.



Easy installation

Quick installation

- Safe, reliable fixing with the assisted fixing device and the system of multi-thickness fixing-clips.
- Easy to invert.
- To operate as extractors, all the motors can be inverted by simply removing four screws.

Innovation



Smart airing systems

The smartest way to keep critical equipment cool

- Smart filter.
- Adaptable to any new or existing enclosures.

High protection rating: IP54 as standard

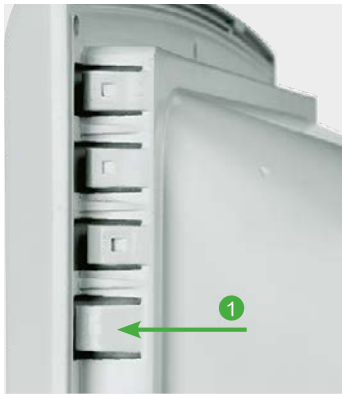
**1 Fixing guide**

- To center the body of the fan on the wall of enclosure.
- To correct machining faults.
- To facilitate the correct operation of the fixing "clips".

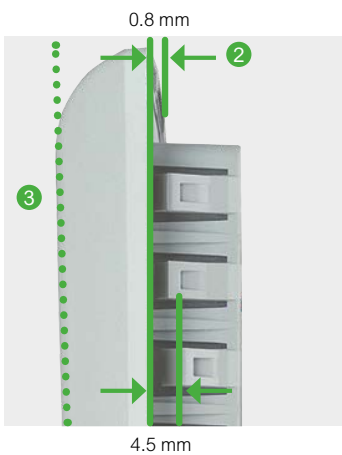
**2 Multi-thickness fixing-clips**

- To help guarantee easy and reliable fixing of the airing system.
- With a thickness of 0.8 to 4.5 mm, with no fixings.

3 Inclined profile of the grille

- To protect the filter against vertical spraying: each slat is protected by the slat above it, with the external dimensions remaining small.

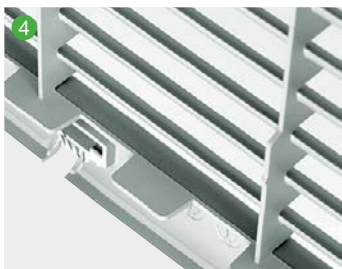

- 4** • IP54 (IP55 with the cover) A patented system allows the evacuation of water absorbed by the filter,
- In particular during high-pressure spraying.

**5 Hot-fitted sealing gasket**

- The polyurethane gasket, hot cast, helps guarantee a long-lasting seal.

**6 Effective filter-retaining system**

- The system for holding the synthetic filter in the cavity of the filter holder ensures a protection rating of IP54, even under the most difficult conditions.

Innovation Problems generated by dirty filters

60% of installations face quality issues caused by dirty filters

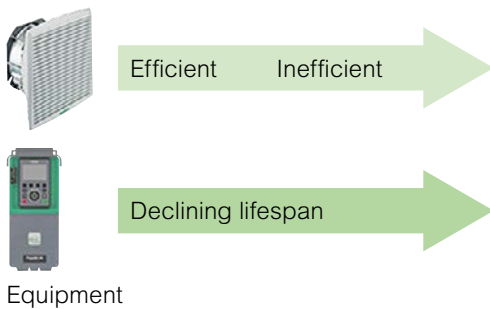
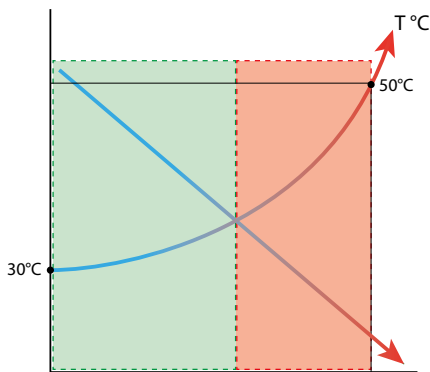

> Product malfunction or breakdown of the panel

- Overheating issues
- Conductivity issues due to dust
- Damage to internal moving parts

> Reduced lifespan of installed equipment

> Low energy efficiency of the panel

- Overconsumption of the fan

> Safety issues

- Risk of fire/burning

All these issues are due to the presence of dust and/or airing malfunction; They can be avoided by using a smart airing system.



HEALTH OF EQUIPMENT = FILTER'S DUST LEVEL

The concept of the ClimaSys Smart Airing System (CSVs)

The ClimaSys Smart Airing System is a smart, closely integrated network that makes your life easier.



> Use corrective and predictive maintenance of the airing system to:

- Improve CAPEX and OPEX of the installation
- Improve maintenance and operation of the installation
- Improve peace of mind

Reduce maintenance cost for new and existing installations.

> Functions of the CSVs systems:

Detect general poor health of the enclosure by monitoring:

- Input/output temperature

Detect fan issues by monitoring:

- Air flow temperature
- Current level, consumed energy
- Blade speed measurement
- Used and remaining (approximate) lifespan

Detect grid filter issues:

- Air flow temperature
- Dust level (0% clean – 100% dirty)
- Number of replacements
- Remaining time to next replacement

14
CV

90% savings on filter maintenance

Innovation The technical solution

2 sensors...



Dust sensor (patented)
NSYCCAFSDUST

Composed of an optical sensor which detects the filter dirt level + temperature sensor



Fan Sensor
NSYCCARPM

Composed of:
RPM sensor to control fan rotation and transported air temperature
Toroidal sensor to measure fan consumption



... connected to a controller relaying information and alarms

Filterstat™ Controller ClimaSys CC DG NSYCCOFST•••V
Information displayed on Filterstat's controller display

- **Detect general poor health of enclosure by monitoring:**
 - Input/output temperature
- **Detect fan issues by monitoring:**
 - Air flow temperature
 - Current level, consumed energy
 - Blade speed measurement
 - Used and remaining (approximate) lifespan
- **Detect grid filter issues:**
 - Air flow temperature
 - Dust level (0% clean – 100% dirty)
 - Number of replacements
 - Remaining time before next replacement

The alarms

The system offers different types of alarms for notification when something is not right:

Alarms

Dust filter alarm: Filter capacity below user-defined level. 0%-60% (LED green), 60%-80% (LED orange), >80% (LED flashing red)

No power supply to fan: Fan is running (there is an rpm reading but the current sensor shows a 0 mA reading).

Fan rpm slow: Fan speed is below a user-predefined level.

Fan flaps blocked: Consumption in a fan is detected but the rpm speed is zero.

Over-temperature alarm on airflow: Fan exceeds a user-defined threshold.

Over-temperature or under-temperature alarm: On inlet or outlet air from grids.

Fan lifespan over: The fan lifetime has almost expired and it should be replaced (front LEDs light up purple).

Δt deviation: Δt deviation is greater than a user-predefined threshold.

Remote sensor not connected/broken: A device in the network is disconnected.

Thermal network architecture



> The Greenfield solution for new installations

We offer a range of digital devices that can be connected together and optionally also to a remote supervisor.

See [page 642](#)

> The Brownfield kit for retrofit installations

Easy upgrading of an existing installation to a digital one.

See [page 643](#)

Innovation Build your Greenfield solution for a new installation

The nucleus of the system is the ClimaSys Filterstat™ controller that collects information from filter and fan sensors across all of your enclosures.



Easy product selection with the Proclima selection tool

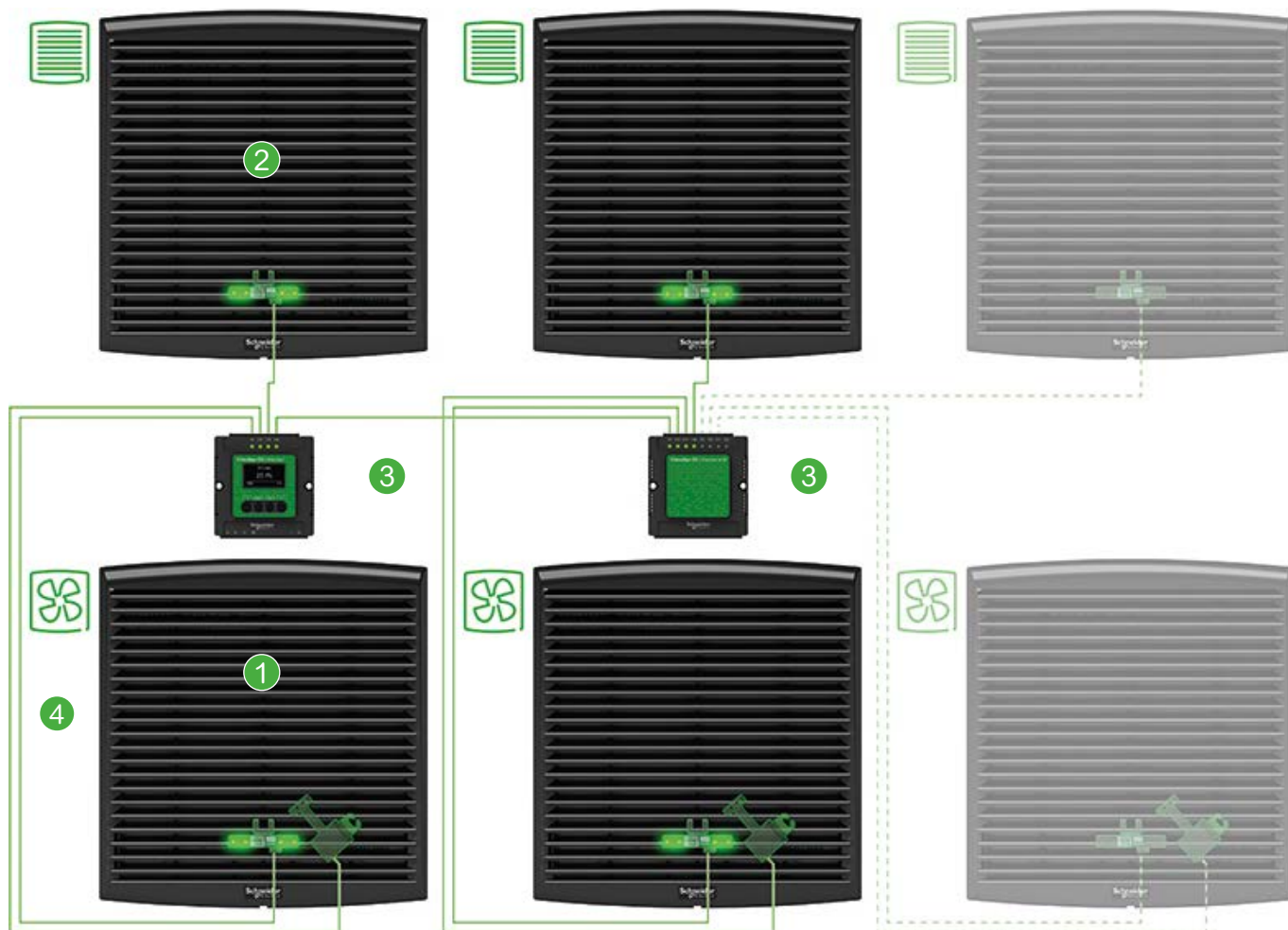

14
CV

Select your Smart Fan



Select your Smart Grid



Select your controller and potential thermal hubs to digitalize more than 1 enclosure



Select your communication cables



New ClimaSys Smart Grid Offer

Complete Smart Grid that includes:

- A dust Sensor
- A smart Filter G2, G3 smart filter to be order separately (see [page 645](#)).

Grid cut-out (mm ²)	References
92x92	NSYCAG92DG
125x125	NSYCAG125DG
223x223	NSYCAG223DG
291x291	NSYCAG291DG

Filterstat Controllers (4 ports) and thermal hubs (8 ports)

- Trim frame IP55 for installing the Filterstat Controller and thermal hub on enclosure doors, side panels etc.

Voltage (V)	References
30 V AC/DC	NSYCCOFST30V
90-250 V AC	NSYCCOFST90250V
30 V AC/DC	NSYCCOFSEM8U1
90-250 V AC	NSYCCOFSEM8U2

Modular frame IP55

Material and color	References
same as controller	NSYCCOFR55

Filterstat communication cable

Black unshielded cable with 2 connectors on each end.
Material: PVC.

Length (mm)	References
500	NSYCCA50MFST
1000	NSYCCA100MFST
1500	NSYCCA150MFST
2000	NSYCCA200MFST
3000	NSYCCA300MFST
4000	NSYCCA400MFST
5000	NSYCCA500MFST



Control devices (thermostat, hygrosat, hygrotherm) must be ordered separately.

Innovation

Select your Brownfield kit for an existing installation

To digitalize an existing installation, order the appropriate Brownfield kit:



Suitable for existing enclosures with fan at the bottom and grid at the top (lateral or door)



Brownfield kits

- 2 units of external covers grey smokey grids
- 2 units of smart filters (2 Filter Mat G2 + 2 dust sensors)
- 1 unit Filterstat Controller (90-250 V, 50 Hz-60 Hz)
- 3 cables
- 1 rpm + toroidal sensor
- Other equipment: 10 stickers and retainer flaps mini-tool kit





Dimensions Grid cut-out size (mm)	Cable size (m)	References
92 x 92	0.5	NSYCCFSBRKIT92
125 x 125	1	NSYCCFSBRKIT125
223 x 223	1.5	NSYCCFSBRKIT223
291 x 291	2	NSYCCFSBRKIT291

... or select Brownfield components separately:

External Smart Grids	External smokey grids	Smart filters
		
External grids equipped with G2 filter and Dust Sensor to be installed in an existing grid support.	External grids to be installed in an existing grid support or used as spare part. Smart filter and Dust sensor to be ordered separately.	Set of 5 Smart filters for replacement on Smart Fans and Smart Grids. See details page 650 .

Dimensions Grid cut-out size (mm)	References	References	Filter type	References
92 x 92	NSYCAG92DGC	NSYCAG92BPC	M1 G2	NSYCAF92DG
125 x 125	NSYCAG125DGC	NSYCAG125BPC	M1 G2	NSYCAF125DG
125 x 125	NSYCAG125DGC	NSYCAG125BPC	M1 G3	NSYCAF125G3DG
223 x 223	NSYCAG223DGC	NSYCAG291BPC	M1 G2	NSYCAF223DG
223 x 223	NSYCAG223DGC	NSYCAG291BPC	M1 G3	NSYCAF223G3DG
291 x 291	NSYCAG291DGC	NSYCAG223BPC	M1 G2	NSYCAF291DG
291 x 291	NSYCAG291DGC	NSYCAG223BPC	M1 G3	NSYCAF291G3DG

Dust Sensor	10 stickers and retainer flaps mini-tool kit	Fan Sensor
		
Individual Dust Sensor ready to be implemented on any existing ClimaSys CV fan or ClimaSys CA grids in the Brownfield installation or used as spare part.	Tool kit for digitalizing fans in Brownfield installations without opening fan motor rear grids.	Individual Fan Sensor ready to be implemented on any existing fan in the Brownfield installation or used as spare part.
References NSYCCAFSDUST	References NSYCCABLK	References NSYCCARPM

- Characteristics: The Smart fans are equipped with an axial motor, a protective housing on the front, rear surfaces, and a Smart filter with Dust sensor and a Fan sensor with infrared technology. The external smokey-colored grid displays the status of the airing functions through the LED colors of the Dust sensor. This Smart filter can be replaced for maintenance during operation without risk of contact with the rotating element.
- Material of external grids: Injected thermoplastic (ASA PC), self-extinguishing according to UL 94 V-0.
- Color of external grids: Smokey black RAL 9005
- Conditions of use: The external temperature must not exceed 30 °C and must be more than 5 °C lower than the temperature required in the enclosure. The Smart filters that equip the Smart fans must be replaced when the alarm is triggered by the Filterstat controller (see more details [page 641](#))
Storage Temperature: -40...+ 70 °C
- Ingress protection rating (according to IEC 60529): IP54
- If the enclosure contains electronics, material sensitive to dust deposits or if it is needed to use several fans and grills in the same enclosure, we highly recommend using PROCLIMA and a solution with better filtering using a G3 filter or a higher IP (cooling option as example). In any case, do not hesitate to contact our sales teams to collaborate on your project.
- Mechanical protection rating (according to IEC 62262): IK08
- Installation: The cut-out template supplied with the device avoids the need for marking and helps protect the surface of the enclosure during handling.
- Options: For maintenance replacement of Smart filters please see spare parts references, [page 645](#)

Free flow rate with standard filter (m³/h)	Flow rate with outlet grille(s) (m³/h)		Voltage range (nominal voltage)	Absorbed power (max. intensity)	Noise level	External dimensions (cut-out)	Weight	Operating temperature	Max. static pressure
	1	2							
34 (50 Hz)	21 (50 Hz)	29 (50 Hz)	150 V...250 V (230 V)	4.5/4.8 W (0.16/0.17 A)	40/41 dB (A)	137 x 117 x 49 (92 x 92)	0.220 kg	-10...+ 70 °C	29 Pa
35 (60 Hz)	22 (60 Hz)								
34 (50 Hz)	23 (50 Hz)	35 (50 Hz)	75 V...125 V (115 V)	3.3/3.5 W (0.16/0.16 A)	40/41 dB (A)	137 x 117 x 49 (92 x 92)	0.220 kg	-10...+ 70 °C	29 Pa
35 (60 Hz)	24 (60 Hz)								
74 (50 Hz)	52 (50 Hz)	60 (50 Hz)	175 V...253 V (230 V)	17/15 W (0.121/0.097 A)	46/49 dB (A)	170 x 150 x 62 (125)	0.780 kg	-20...+60 °C	50 Pa
87 (60 Hz)	61 (60 Hz)								
68 (50 Hz)	54 (50 Hz)	62 (50 Hz)	75 V...126 V (115 V)	16/15 W (0.207/0.179 A)	46/49 dB (A)	170 x 150 x 62 (125)	0.780 kg	-20...+60 °C	50 Pa
81 (60 Hz)	63 (60 Hz)								
142 (50 Hz)	130 (50 Hz)	138 (50 Hz)	175 V...253 V (230 V)	16.3/14.3 W (0.12/0.94 A)	50/51 dB (A)	268 x 248 x 104 (223 x 223)	1.140 kg	-20...+60 °C	50 Pa
170 (60 Hz)	151 (60 Hz)	152 (60 Hz)							
151 (50 Hz)	130 (50 Hz)	138 (50 Hz)	75 V...126 V (115 V)	15.5/14.4 W (0.20/0.18 A)	50/51 dB (A)	268 x 248 x 104 (223 x 223)	1.140 kg	-20...+60 °C	50 Pa
173 (60 Hz)	151 (60 Hz)	156 (60 Hz)							
259 (50 Hz)	209 (50 Hz)	218 (50 Hz)	145 V...253 V (230 V)	36/37 W (0.17/0.16 A)	55/56 dB (A)	268 x 248 x 116 (223 x 223)	1.3 kg	-10...+ 70 °C	158 Pa
307 (60 Hz)	251 (60 Hz)								
259 (50 Hz)	209 (50 Hz)	221 (50 Hz)	75 V...126 V (115 V)	36/36 W (0.35/0.32 A)	55/56 dB (A)	268 x 248 x 116 (223 x 223)	1.3 kg	-10...+70 °C	158 Pa
307 (60 Hz)	251 (60 Hz)								
502 (50 Hz)	412 (50 Hz)	420 (50 Hz)	207 V...244 V (230 V)	68/85 W (0.52/0.370 A)	59/59 dB (A)	336 x 316 x 161 (291 x 291)	3.2 kg	-15...+60 °C	140 Pa
526 (60 Hz)	448 (60 Hz)								
522 (50 Hz)	425 (50 Hz)	434 (50 Hz)	103 V...122 V (115 V)	65/83 W (0.60/0.72 A)	59/59 dB (A)	336 x 316 x 161 (291 x 291)	3.2 kg	-15...+60 °C	140 Pa
526 (60 Hz)	417 (60 Hz)								
638 (50 Hz)	500 (50 Hz)	528 (50 Hz)	207 V...244 V (230 V)	150/195 W (0.65/0.85 A)	76/75 dB (A)	336 x 316 x 162 (291 x 291)	4.1 kg	-15...+60 °C	170 Pa
603 (60 Hz)	462 (60 Hz)								
783 (50 Hz)	643 (50 Hz)	654 (50 Hz)	103 V...122 V (115 V)	145/182 W (1.279/1.6 A)	78/77 dB (A)	336 x 316 x 162 (291 x 291)	4.1 kg	-15...+60 °C	170 Pa
744 (60 Hz)	442 (60 Hz)								
731 (50 Hz)	598 (50 Hz)	609 (50 Hz)	396 V...466 V (400 V)	126/126 W (0.226/0.232 A)	77/75 dB (A)	336 x 316 x 162 (291 x 291)	4.1 kg	-15...+60 °C	170 Pa
603 (60 Hz)	368 (60 Hz)								

How to identify whether your ClimaSys CV fan has been upgraded to install the CSVS solution

Your installation		Installation of CSVS solution	
Greenfield	NSYCV...•••DG		<input checked="" type="checkbox"/> It's possible to install the CSVS solution
Brownfield	NSYCV...•••LPF		<input type="checkbox"/> You need to order NSYCCABLK
	NSYCV...•••LPF		<input checked="" type="checkbox"/> It's possible to install the CSVS solution



Type of connection				
by cable ★ Forced-airing fan 38 m³/h	by faston (1) Forced-airing fan 85 m³/h	by faston (1) Forced-airing fan 165 m³/h	by faston (1) Forced-airing fan 300 m³/h	by terminal block Forced-airing fan 560-850 m³/h
NSYCVF38M230DG	-	-	-	-
NSYCVF38M115DG	-	-	-	-
-	NSYCVF85M230DG	-	-	-
-	NSYCVF85M115DG	-	-	-
-	-	NSYCVF165M230DG	-	-
-	-	NSYCVF165M115DG	-	-
-	-	-	NSYCVF300M230DG	-
-	-	-	NSYCVF300M115DG	-
-	-	-	-	NSYCVF560M230DG
-	-	-	-	NSYCVF560M115DG
-	-	-	-	NSYCVF850M230DG
-	-	-	-	NSYCVF850M115DG
-	-	-	-	NSYCVF850M400DG

(1) Fan models with connection are delivered with the connection cord included (2 metres).



★ Warning: The fan **NSYCVF38M230DG** and **NSYCVF38M115DG** MUST NOT be connected to a power conversion module, an inverter or UPS!

High-visibility LED indicators



Dust filter alarm
0%-60%



Dust filter alarm
60%-80%



Dust filter alarm
>80%



Fan lifespan
exhausted



PING function
Identification of the
sensor on the panel
(flashing blue color)

Filterstat Controllers (4 ports) and thermal hubs (8 ports)

- Trim frame IP55 for installing the Filterstat Controller and thermal hub on enclosure doors, side panels etc.



NSYCCOFST30V

Characteristics	Voltage	References
Filterstat Controllers	30 V AC/DC	NSYCCOFST30V
Filterstat Controllers	90-250 V AC	NSYCCOFST90250V



NSYCCOFSEM8U1

Characteristics	Voltage	References
Thermal Hub	30 V AC/DC	NSYCCOFSEM8U1
Thermal Hub	90-250 V AC	NSYCCOFSEM8U2

Modular frame IP55



NSYCCOFR55

Characteristics	References
Modular frame	NSYCCOFR55

Filterstat communication cable

- Black unshielded cable with 2 connectors on each side.
- Material: PVC.



NSYCCA50MFST

Characteristics	References
Filterstat communication cable	NSYCCA50MFST
Filterstat communication cable	NSYCCA100MFST
Filterstat communication cable	NSYCCA150MFST
Filterstat communication cable	NSYCCA200MFST
Filterstat communication cable	NSYCCA300MFST
Filterstat communication cable	NSYCCA400MFST
Filterstat communication cable	NSYCCA500MFST

Brownfield kits



NSYCCFSBRKIT92

Characteristics	Grid cut-out size (mm)	Cable size (m)	References
Brownfield kit	92 x 92	0.5	NSYCCFSBRKIT92
Brownfield kit	125 x 125	1	NSYCCFSBRKIT125
Brownfield kit	223 x 223	1.5	NSYCCFSBRKIT223
Brownfield kit	291 x 291	2	NSYCCFSBRKIT291

Smart airing systems



NSYCVF38M115DG

Characteristics	References
Smart airing system, 38 m³/h 115 V IP54	NSYCVF38M115DG
Smart airing system, 38 m³/h 230 V IP54	NSYCVF38M230DG
Smart airing system, 85 m³/h 115 V IP54	NSYCVF85M115DG
Smart airing system, 85 m³/h 230 V IP54	NSYCVF85M230DG
Smart airing system, 165 m³/h 115 V IP54	NSYCVF165M115DG
Smart airing system, 165 m³/h 230 V IP54	NSYCVF165M230DG
Smart airing system, 300 m³/h 115 V IP54	NSYCVF300M115DG
Smart airing system, 300 m³/h 230 V IP54	NSYCVF300M230DG
Smart airing system, 560 m³/h 115 V IP54	NSYCVF560M115DG
Smart airing system, 582 m³/h 230 V IP54	NSYCVF560M230DG
Smart airing system, 850 m³/h 115 V IP54	NSYCVF850M115DG
Smart airing system, 850 m³/h 230 V IP54	NSYCVF850M230DG
Smart airing system, 850 m³/h 400 V IP54	NSYCVF850M400DG

Technical changes reserved. Information provided without guarantee. Images are for illustrative purposes only.

ClimaSys (CSVS) general wiring diagram

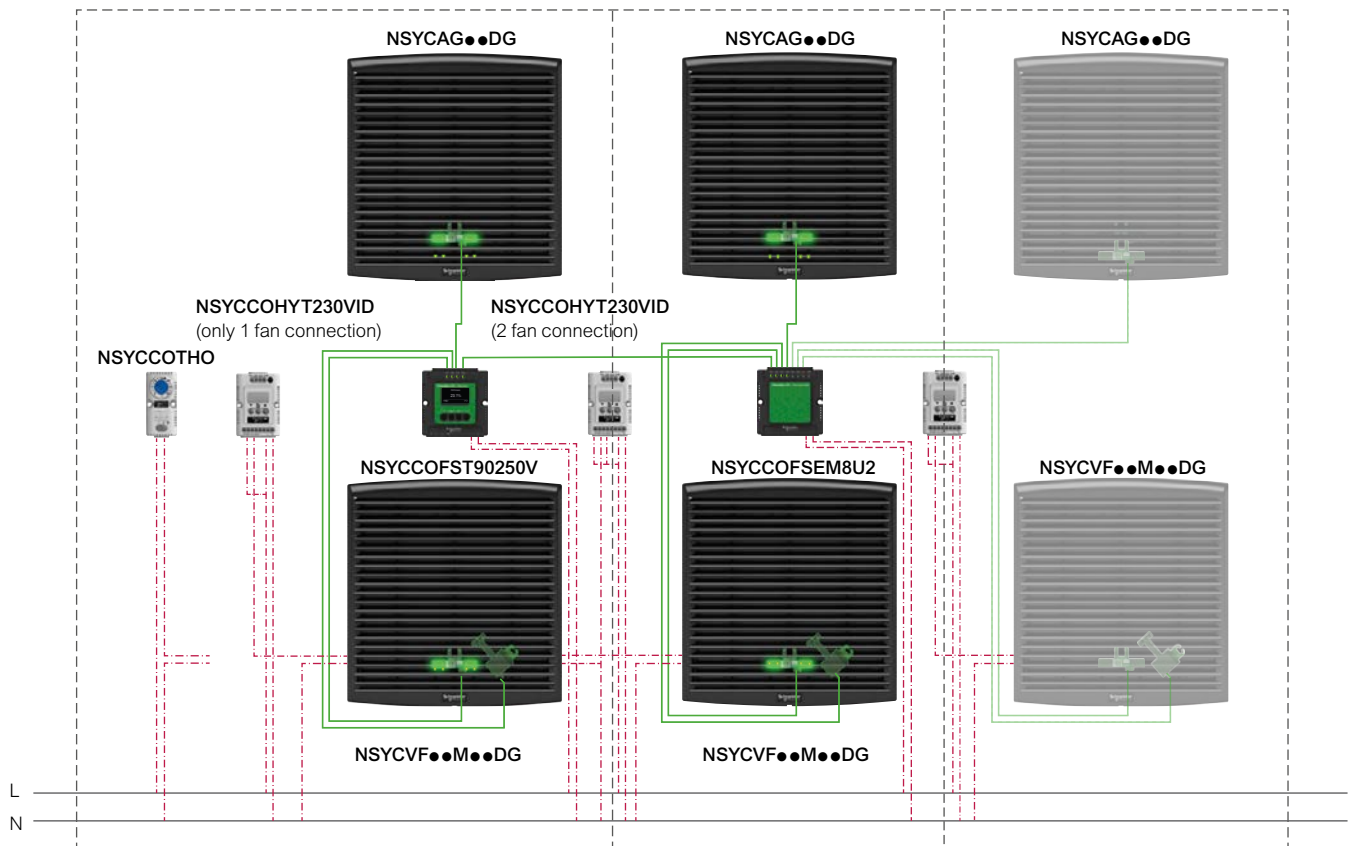

Smart Grid systems

Complete Smart Grids

- A Dust Sensor
- A SmartFilter G2
- Material: Injected thermoplastic (PC), self-extinguishing according to UL 94 V-0
- Color: Smokey black RAL 9005
- Ingress protection rating (according to IEC 60529): IP54



NSYCAG92DG

Characteristics	Height (mm)	Width (mm)	Depth (mm)	Cut-out (mm)	References
Complete Smart Grid	137	117	13	92 x 92	NSYCAG92DG
Complete Smart Grid	170	150	15	125 x 125	NSYCAG125DG
Complete Smart Grid	268	248	18	223 x 223	NSYCAG223DG
Complete Smart Grid	336	316	18	291 x 291	NSYCAG291DG

External Smart Grids (without internal grid systems)

- External grids equipped with G2 Smart filter and Dust Sensor to be installed in an existing grid support.
- Material: Injected thermoplastic (PC), self-extinguishing according to UL 94 V-0
- Color: Smokey black RAL 9005
- Ingress protection rating (according to IEC 60529): IP54



NSYCAG92DGC

Characteristics	Height (mm)	Width (mm)	Depth (mm)	Cut-out (mm)	References
External Smart Grid	137	117	13	92 x 92	NSYCAG92DGC
External Smart Grid	170	150	15	125 x 125	NSYCAG125DGC
External Smart Grid	268	248	18	223 x 223	NSYCAG223DGC
External Smart Grid	336	316	18	291 x 291	NSYCAG291DGC

External smokey grids (external cover only)

- External grids to be installed in an existing grid support or used as spare part.
- Smart filter and Dust sensor to be ordered separately.
- Material: Injected thermoplastic (PC), self-extinguishing according to UL 94 V-0
- Color: Smokey black RAL 9005
- Ingress protection rating (according to IEC 60529): IP54



NSYCAG92BPC

Characteristics	Height (mm)	Width (mm)	Depth (mm)	Cut-out (mm)	References
External Smart Grid	137	117	13	92 x 92	NSYCAG92BPC
External Smart Grid	170	150	15	125 x 125	NSYCAG125BPC
External Smart Grid	336	316	18	291 x 291	NSYCAG223BPC
External Smart Grid	268	248	18	223 x 223	NSYCAG291BPC

Smart filters

- Set of 5 Smart filters for replacement on Smart Fans and Smart Grids. For fans and grilles.
- Material: Polyester.
- Filters according to ISO 16890.
- Color: White with green lettering



NSYCAF92DG

Characteristics	Height (mm)	Width (mm)	Depth (mm)	Cut-out (mm)	References
External Smart Grid, G2 M1 filters	137	117		92 x 92	NSYCAF92DG
External Smart Grid, G2 M1 filters	170	150		125 x 125	NSYCAF125DG
External Smart Grid, G2 M1 filters	268	248		223 x 223	NSYCAF223DG
External Smart Grid, G2 M1 filters	336	316		291 x 291	NSYCAF291DG
External Smart Grid, G3 M1 filters	170	150		125 x 125	NSYCAF125G3DG
External Smart Grid, G3 M1 filters	268	248		223 x 223	NSYCAF223G3DG
External Smart Grid, G3 M1 filters	336	316		291 x 291	NSYCAF291G3DG

Dust Sensor

- Individual Dust Sensor ready to be implemented on any existing ClimaSys CV fan or ClimaSys CA grids in the Brownfield installation or used as spare part.



NSYCCAFSDUST

Characteristics	References
Dust Sensor	NSYCCAFSDUST

Fan Sensor

- Individual Fan Sensor ready to be implemented on any existing fan in the Brownfield installation or used as spare part.



NSYCCARPM

Characteristics	References
Fan Sensor	NSYCCARPM

10 stickers and retainer flaps mini-tool kit

- Tool kit for digitalizing fans in Brownfield installations without opening fan motor rear grids.



NSYCCABLK

Characteristics	References
10 stickers and retainer flaps mini-tool kit	NSYCCABLK

Anti-vandalism kit



NSYCAAPV

- Prevents the grid from being opened from the outside.
- The unlocking thumbwheel is accessed from the inside of the enclosure.
- Color: RAL 7011

Characteristics	References
Anti-vandalism kit	NSYCAAPV

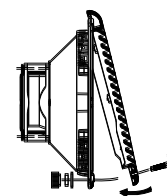

Supply:
Minor packaging 2

Filter Pocket

- Fixed by adhesive tape
- Material: Polystyrene (PS)
- Color: RAL 7035 grey (**NSYDPA4**: RAL 9001)
- ⁽¹⁾ Not compatible with 19" chassis or modular distribution installation.



NSYDPA5

Characteristics	Smart filter references	Dimensions			References
		A (mm)	B (mm)	C (mm)	
Pocket A5	NSYCAF92•DG and NSYCAF125•DG	137	117	13	NSYDPA5
Pocket A4	NSYCAF223•DG	170	150	15	NSYDPA4
Pocket A4 ⁽¹⁾	NSYCAF223•DG	268	248	18	NSYDPA44
Pocket A3	NSYCAF291•DG	336	316	18	NSYDPA3

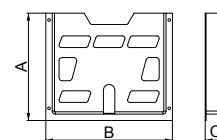

Supply:
1 plastic document pocket

- Characteristics: The fans comprise an axial motor, a protective housing on the front and rear surfaces and a filter designed to retain dust particles. This filter can be replaced during operation without risk of contact with the rotating element.
- Material of external grids: Injected thermoplastic (ASA PC). self-extinguishing according to UL 94 V-0
- Color external grids: RAL 7035 grey as standard
- Conditions of use: The external temperature must not exceed 30 °C and must be more than 5 °C lower than the temperature wanted in the enclosure. The filters that equip the fans must be cleaned and replaced regularly. The ambient air must be relatively clean and overfrequent filter replacement should be avoided. Bear in mind the pressure losses caused by the outlet element (grille with filter, airing louvre or simple opening) when determining the fan flow rate
- Storage Temperature: -40...+ 70 °C
- Ingress protection rating (according to IEC 60529): IP54
- If the enclosure contains electronics, material sensitive to dust deposits or if it is needed to use several fans and grills in the same enclosure, we highly recommend using PROCLIMA and a solution with better filtering using a G3 filter or a higher IP (cooling option as example). In any case, do not hesitate to contact our sales teams to collaborate on your project.
- Mechanical protection rating (according to IEC 62262): IK08
- UL recognized (cURus). Rated Type 12 according to UL50E.
- Installation: The cut-out template supplied with the device avoids the need for marking and helps protect the surface of the enclosure during handling
- All fan references with free air flow rate above 38m³/h (NSYCVF85MxxxPF, NSYCVF165MxxxPF, NSYCVF300MxxxPF, NSYCVF560MxxxPF, NSYCVF850MxxxPF) are also delivered with one anti-insect filter
- Options: The device can be equipped with a filter that provides even more efficient protection for your sensitive facilities against dust particles

Free flow rate with standard filter (m³/h)	Flow rate with outlet grille(s) (m³/h)		Voltage range (nominal voltage)	Absorbed power (max. intensity)	Noise level	External dimensions (cut-out)	Weight	Operating temperature	Max. static pressure
	1	2							
38 (50 Hz)	25 (50 Hz)	33 (50 Hz)	150 V...250 V (230 V)	4.5/4.8 W (0.16/0.17 A)	40/41 dB (A)	137 x 117 x 49 (92 x 92)	0.220 kg	-10...+ 70 °C	29 Pa
39 (60 Hz)	26 (60 Hz)								
38 (50 Hz)	27 (50 Hz)	35 (50 Hz)	75 V...125 V (115 V)	3.3/3.5 W (0.16/0.16 A)	40/41 dB (A)	137 x 117 x 49 (92 x 92)	0.220 kg	-10...+ 70 °C	29 Pa
39 (60 Hz)	28 (60 Hz)								
58	39	47	10 V...27.6 V (24 V DC)	3.6 W (0.18 A)	40/41 dB (A)	137 x 117 x 49 (92 x 92)	0.230 kg	-10...+ 70 °C	29 Pa
44	34	41	36 V...56 V (48 V DC)	3.6 W (70 mA)	40/41 dB (A)	137 x 117 x 49 (92 x 92)	0.230 kg	-10...+ 70 °C	29 Pa
85 (50 Hz)	63 (50 Hz)	71 (50 Hz)	175 V...253 V (230 V)	17/15 W (0.121/0.097 A)	46/49 dB (A)	170 x 150 x 62 (125)	0.780 kg	-20...+60 °C	50 Pa
98 (60 Hz)	72 (60 Hz)								
79 (50 Hz)	65 (50 Hz)	73 (50 Hz)	75 V...126 V (115 V)	16/15 W (0.207/0.179 A)	46/49 dB (A)	170 x 150 x 62 (125)	0.780 kg	-20...+60 °C	50 Pa
92 (60 Hz)	74 (60 Hz)								
80	57	77	10 V...27.6 V (24 V DC)	7.6 W (0.30 A)	46/49 dB (A)	170 x 150 x 62 (125)	0.480 kg	-10...+ 70 °C	50 Pa
79	59	68	25 V...55.2 V (48 V DC)	8 W (0.173 A)	46/49 dB (A)	170 x 150 x 62 (125)	0.480 kg	-10...+ 70 °C	50 Pa
165 (50 Hz)	153 (50 Hz)	161 (50 Hz)	175 V...253 V (230 V)	16.3/14.3 W (0.12/0.94 A)	50/51 dB (A)	268 x 248 x 104 (223 x 223)	1.140 kg	-20...+60 °C	50 Pa
193 (60 Hz)	171 (60 Hz)	175 (60 Hz)							
164 (50 Hz)	153 (50 Hz)	161 (50 Hz)	75 V...126 V (115 V)	15.5/14.4 W (0.20/0.18 A)	50/51 dB (A)	268 x 248 x 104 (223 x 223)	1.140 kg	-20...+60 °C	50 Pa
193 (60 Hz)	171 (60 Hz)	179 (60 Hz)							
188	171	179	10 V...27.6 V (24 V DC)	8 W (0.3 A)	50/51 dB (A)	268 x 248 x 104 (223 x 223)	0.810 kg	-10...+ 70 °C	50 Pa
193	171	179	25 V...55.2 V (48 V DC)	8.7 W (0.18 A)	50/51 dB (A)	268 x 248 x 104 (223 x 223)	0.810 kg	-10...+ 70 °C	50 Pa
302 (50 Hz)	260 (50 Hz)	268 (50 Hz)	145 V...253 V (230 V)	36/37 W (0.17/0.16 A)	55/56 dB (A)	268 x 248 x 116 (223 x 223)	1.3 kg	-10...+ 70 °C	158 Pa
350 (60 Hz)	307 (60 Hz)								
302 (50 Hz)	263 (50 Hz)	271 (50 Hz)	75 V...126 V (115 V)	36/36 W (0.35/0.32 A)	55/56 dB (A)	268 x 248 x 116 (223 x 223)	1.3 kg	-10...+70 °C	158 Pa
350 (60 Hz)	307 (60 Hz)								
262	221	229	12 V...30 V (24 V DC)	13 W (0.53 A)	55/56 dB (A)	268 x 248 x 103.4 (223 x 223)	1.1 kg	-10...+ 70 °C	158 Pa
247	210	218	25 V...60 V (48 V DC)	11 W (0.24 A)	55/56 dB (A)	268 x 248 x 103.4 (223 x 223)	1.1 kg	-10...+70 °C	158 Pa
562 (50 Hz)	473 (50 Hz)	481 (50 Hz)	207 V...244 V (230 V)	68/85 W (0.52/0.370 A)	59/59 dB (A)	336 x 316 x 161 (291 x 291)	3.2 kg	-15...+60 °C	140 Pa
586 (60 Hz)	477 (60 Hz)								
582 (50 Hz)	485 (50 Hz)	494 (50 Hz)	103 V...122 V (115 V)	65/83 W (0.60/0.72 A)	59/59 dB (A)	336 x 316 x 161 (291 x 291)	3.2 kg	-15...+60 °C	140 Pa
586 (60 Hz)	477 (60 Hz)								
838 (50 Hz)	718 (50 Hz)	728 (50 Hz)	207 V...244 V (230 V)	150/195 W (0.65/0.85 A)	76/75 dB (A)	336 x 316 x 162 (291 x 291)	4.1 kg	-15...+60 °C	170 Pa
803 (60 Hz)	568 (60 Hz)								
983 (50 Hz)	843 (50 Hz)	854 (50 Hz)	103 V...122 V (115 V)	145/182 W (1.279/1.6 A)	78/77 dB (A)	336 x 316 x 162 (291 x 291)	4.1 kg	-15...+60 °C	170 Pa
944 (60 Hz)	642 (60 Hz)								
931 (50 Hz)	798 (50 Hz)	809 (50 Hz)	396 V...466 V (400 V)	126/126 W (0.226/0.232 A)	77/75 dB (A)	336 x 316 x 162 (291 x 291)	4.1 kg	-15...+60 °C	170 Pa
803 (60 Hz)	568 (60 Hz)								



Type of connection				
by cable Forced-airing fan 38 m³/h	by faston ⁽¹⁾ Forced-airing fan 85 m³/h	by faston ⁽¹⁾ Forced-airing fan 165 m³/h	by faston ⁽¹⁾ Forced-airing fan 300 m³/h	by terminal block Forced-airing fan 560-850 m³/h
NSYCVF38M230PF *	-	-	-	-
NSYCVF38M115PF *	-	-	-	-
NSYCVF38M24DPF	-	-	-	-
NSYCVF38M48DPF	-	-	-	-
-	NSYCVF85M230PF	-	-	-
-	NSYCVF85M115PF	-	-	-
-	NSYCVF85M24DPF	-	-	-
-	NSYCVF85M48DPF	-	-	-
-	-	NSYCVF165M230PF	-	-
-	-	NSYCVF165M115PF	-	-
-	-	NSYCVF165M24DPF	-	-
-	-	NSYCVF165M48DPF	-	-
-	-	-	NSYCVF300M230PF	-
-	-	-	NSYCVF300M115PF	-
-	-	-	NSYCVF300M24DPF	-
-	-	-	NSYCVF300M48DPF	-
-	-	-	-	NSYCVF560M230PF
-	-	-	-	NSYCVF560M115PF
-	-	-	-	NSYCVF850M230PF
-	-	-	-	NSYCVF850M115PF
-	-	-	-	NSYCVF850M400PF

⁽¹⁾ Fan models with connection are delivered with the connection cord included (2 metres).

 **★ Warning:** The fan **NSYCVF38M230PF** and **NSYCVF38M115PF** MUST NOT be connected to a power conversion module, an inverter or UPS!

Airing Systems, IP54 outlet grilles

- Delivered G2 M1 synthetic standard filter according to ISO 16890 and **NSYCAG125LPF**, **NSYCAG223LPF**, **NSYCAG291LPF** are also delivered with anti-insect filter.
- Material: Injected thermoplastic polycarbonate.
- Color: RAL 7035 grey
- Ingress protection rating (according to IEC 60529): IP54
- UL recognized (cURus), rated Type 12 according to UL50E



NSYCAG92LPF

Characteristics	Height (mm)	Width (mm)	Depth (mm)	Cut-out (mm)	References
IP54 outlet grilles	137	117	13	92 x 92	NSYCAG92LPF
IP54 outlet grilles	170	150	15	125 x 125	NSYCAG125LPF
IP54 outlet grilles	268	248	18	223 x 223	NSYCAG223LPF
IP54 outlet grilles	336	316	18	291 x 291	NSYCAG291LPF

Filters

- For fans and grilles.
- Filters according to ISO 16890.

Supply:

- G2 M1 synthetic standard filters, Filters for greasy environments G2 M1, G3 M1 synthetic fine filters: 5 units
- Stainless-steel anti-insect filters: 1 unit



NSYCAF223T

Characteristics	Height (mm)	Width (mm)	Cut-out (mm)	References
G2 M1 synthetic standard filters	137	117	92 x 92	NSYCAF92
G2 M1 synthetic standard filters	170	150	125 x 125	NSYCAF125
G2 M1 synthetic standard filters	268	248	223 x 223	NSYCAF223
G2 M1 synthetic standard filters	336	316	291 x 291	NSYCAF291
Filters for greasy environments G2 M1	170	150	125 x 125	NSYCAF125O
Filters for greasy environments G2 M1	268	248	223 x 223	NSYCAF223O
Filters for greasy environments G2 M1	336	316	291 x 291	NSYCAF291O
G3 M1 synthetic fine filters	170	150	125 x 125	NSYCAF125T
G3 M1 synthetic fine filters	268	248	223 x 223	NSYCAF223T
G3 M1 synthetic fine filters	336	316	291 x 291	NSYCAF291T
Stainless-steel anti-insect filters	137	117	92 x 92	NSYCAF92M
Stainless-steel anti-insect filters	170	150	125 x 125	NSYCAF125M
Stainless-steel anti-insect filters	268	248	223 x 223	NSYCAF223M
Stainless-steel anti-insect filters	336	316	291 x 291	NSYCAF291M

Anti-vandalism kit



NSYCAAPV

- Prevents the grid from being opened from the outside.
- The unlocking thumbwheel is accessed from the inside of the enclosure.
- Color: RAL 7011

Characteristics	References
Anti-vandalism kit	NSYCAAPV

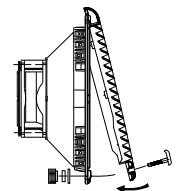

Supply:

2 items per kit

Covers IP55

- This solution protects the fan or grille from any direct spray.
- The cover is the preferred solution to ensure the following:
 - an efficient air flow for cooling,
 - IP55 rating.
- Material: 2 materials available:
 - steel painted with epoxy polyester powder (RAL 7035 grey) for outdoor applications
 - stainless-steel 304L for food and beverage applications
- Ingress protection rating (according to IEC 60529): IP55
- Mechanical protection rating (according to IEC 62262): IK10
- Certifications: UL Recognized (cURus). Rated 12 and 3R according to UL 50E
- Installation: Double insulation maintained if installed in an insulated enclosure. The cover is placed over the fan or the grille with a filter located at the bottom of the cover to prevent the entry of particles. Easy access to the filter: Only two screws needed. When mounting: Remove the external part of the fan or the grille as well as the filter.

⁽¹⁾ Values given for a fan powered at 230 V. For other voltages, the values are similar

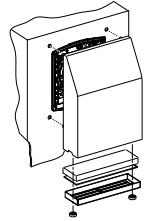

Supply:
It is necessary to order 1 fan + 1 grille + 2 covers to have a complete system



NSYCAP125LZF

Characteristics	Flow rate (m³/h) with cover ⁽¹⁾		Dimensions		References
	Free	With 1 outlet grille	External (mm)	Cut-out (mm)	
Steel painted RAL 7035 grey	74	53	240 x 180 x 60	125 x 125	NSYCAP125LZF
Steel painted RAL 7035 grey	110	82	350 x 305 x 80	223 x 223	NSYCAP223LZF
Steel painted RAL 7035 grey	165	123	350 x 305 x 80	223 x 223	NSYCAP223LZF
Steel painted RAL 7035 grey	316	265	430 x 373 x 105	291 x 291	NSYCAP291LZF
Steel painted RAL 7035 grey	502	430	430 x 373 x 105	291 x 291	NSYCAP291LZF
Stainless-steel 304L	74	53	240 x 180 x 60	125 x 125	NSYCAP125LXF
Stainless-steel 304L	110	82	350 x 305 x 80	223 x 223	NSYCAP223LXF
Stainless-steel 304L	165	123	350 x 305 x 80	223 x 223	NSYCAP223LXF
Stainless-steel 304L	316	265	430 x 373 x 105	291 x 291	NSYCAP291LXF
Stainless-steel 304L	502	430	430 x 373 x 105	291 x 291	NSYCAP291LXF

Spare filter for cover

Supply:
5 items per kit



NSYCAF125L55

Characteristics	Flow rate (m³/h) with cover ⁽¹⁾		Dimensions		References
	Free	With 1 outlet grille	External (mm)	Cut-out (mm)	
Spare filter for cover	74	53	240 x 180 x 60	125 x 125	NSYCAF125L55
Spare filter for cover	110	82	350 x 305 x 80	223 x 223	NSYCAF223L55
Spare filter for cover	165	123	350 x 305 x 80	223 x 223	NSYCAF223L55
Spare filter for cover	316	265	430 x 373 x 105	291 x 291	NSYCAF291L55
Spare filter for cover	502	430	430 x 373 x 105	291 x 291	NSYCAF291L55

Characteristics				Fan	Grille
Flow rate (m³/h) with cover ⁽¹⁾		Dimensions (mm)		RAL 7035 grey	RAL 7035 grey
Free	With 1 outlet grille	External	Cut-out	References	References
74	53	240 x 180 x 60	125 x 125	NSYCVF85M230PF	NSYCAG125LPF
110	82	350 x 305 x 80	223 x 223	NSYCVF165M230PF	NSYCAG223LPF
165	123	350 x 305 x 80	223 x 223	NSYCVF300M230PF	NSYCAG223LPF
316	265	430 x 373 x 105	291 x 291	NSYCVF560M230PF	NSYCAG291LPF
502	430	430 x 373 x 105	291 x 291	NSYCVF850M230PF	NSYCAG291LPF

Airing system, heavy-duty

Fanbox



NSYCVF550M24FB

- Free flow rate: 550 m³/h (50/60 Hz).
- UL Recognized (cURus). Rated Type 12
- Minimal depth inside the enclosure (90 mm).
- Allows multiple cooling architectures (see page 658 and 659).
- Material: polyamide
- Color: RAL 7016 dark grey

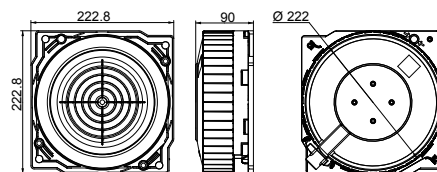

Supply:
1 (grille not included)

Characteristics	Voltage	References
Fanbox	24 V DC	NSYCVF550M24FB
Fanbox	115 V AC	NSYCVF550M115FB
Fanbox	230 V AC	NSYCVF550M230FB

IP55 HD Metal Grille



NSYCAAG223LFHD

- Slim grille (35 mm external depth).
- UL Recognized (cURus). Rated Type 12 according UL 50e
- Includes a G3 M1
- Material: Steel with anti-corrosive painting + plastic PA6 / GF25 for fixing frame
- Finish: Structured finish, 100% polyester powder
- Color: RAL 7035 grey
- Ingress protection rating: IP55 according to IEC 60529
- Mechanical protection rating: IK10 according to IEC 62262

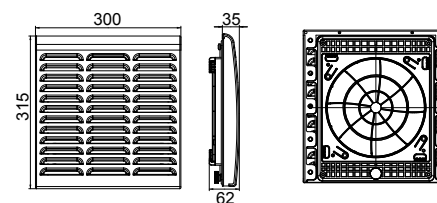

Supply:
1 grille delivered with G3 M1 type synthetic filter (215 x 215 mm) and fixings

Characteristics	References
IP55 HD Metal Grille	NSYCAAG223LFHD

Roof filter for fanbox (extraction mode)



NSYCAF190

- Roof G2 round synthetic filter designed to cover the fanbox. Covers completely the fanbox to protect it from dust and humidity. Mandatory for fanbox installation in the roof airing module for IP55 configurations.
- Material: 100% polyester fibers
- Color: White

Supply:
1

Characteristics	References
Roof filter for fanbox	NSYCAF190

Filter



NSYCAF223T

- Replacement G3 M1-type synthetic filter for HD metal grille.
- Dimensions: 215 x 215 mm.
- Material: 100% polyester fibers
- Color: White

Supply:
5

Characteristics	Height (mm)	Width (mm)	Depth (mm)	Cut-out (mm)	References
G3 M1 synthetic fine filters	268	248	18	223 x 223	NSYCAF223T

Anti-vandalism kit for HD metal grille



NSYCAAPVHD

- Fixings that help to prevent to open the grille from the outside with standard tools (EN 1627-1630:2011 Class 2).
- Quick installation without tools.
- Material: Steel with anticorrosive painting + plastic for fixing screws

Comment:
Not compatible with NSYSPLA150

Supply:
4 grip knob
4 clip nuts

Characteristics	References
Anti-vandalism kit for HD metal grille	NSYCAAPVHD



Download ProClima free software



e-brochure



Get maximum control panel performance and reliability
Thermal management solutions for critical electrical and electronic enclosures **UE16MK06EN**

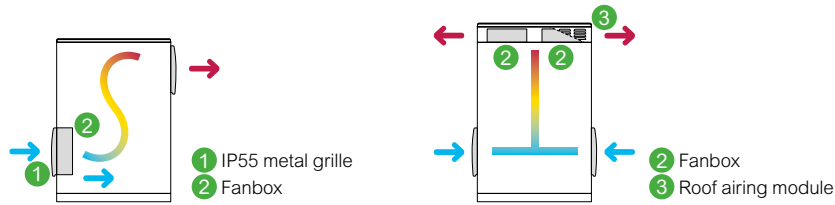

	S-Line				T-Line				
Architecture benefits	<ul style="list-style-type: none"> • Most common and competitive architecture • Maximum heat dissipation to extract 800 W-1000 W • ΔT° of 5 $^\circ\text{C}$ • Easy access to mount-dismount fanbox • Air flow in horizontal axis 				<ul style="list-style-type: none"> • High thermal extraction capacity up to 1500 W • Noise level with 1 fan: 55 dB when installed inside the upper airing module • ΔT° of 5 $^\circ\text{C}$ • Air flow in vertical axis 				
	IP55 metal grille		Fanbox		IP55 metal grille		Fanbox (1 filter NSYCAF190 for each Fanbox)		Roof airing module Rated Type 12 according to UL 50 E
	Door	Side	Door	Side	Door	Side			

Polyester outdoor HD enclosure									
References	Quantity to be installed				Quantity to be installed				References
NSYPHDT553	-	-	-	-	-	-	-	-	-
NSYPHDT553P	-	-	-	-	-	-	-	-	-
NSYPHDT753	-	-	-	-	-	-	-	-	-
NSYPHDT753P	1 to 2	-	1 to 2	-	1 to 2	-	-	-	-
NSYPHDT774	-	1 to 2	-	1 to 2	-	1 to 2	1 to 2	1	NSYPCVR74HD
NSYPHDT774P	1 to 2	1 to 2	1 to 2	1 to 2	1 to 2	1 to 2	1 to 2	1	NSYPCVR74HD
NSYPHDT776	-	1 to 2	-	1 to 2	-	1 to 2	1 to 2	1	NSYPCVR76HD
NSYPHDT776P	1 to 2	1 to 2	1 to 2	1 to 2	1 to 2	1 to 2	1 to 2	1	NSYPCVR76HD
NSYPHDT1054	-	1	-	1	-	1	1	1	NSYPCVR54HD
NSYPHDT1054P	1 to 2	1	1 to 2	1	1 to 2	1	1	1	NSYPCVR54HD
NSYPHDT1074	-	1 to 2	-	1 to 2	-	1 to 2	1 to 2	1	NSYPCVR74HD
NSYPHDT1074P	1 to 4	1 to 2	1 to 4	1 to 2	1 to 4	1 to 2	1 to 2	1	NSYPCVR74HD
NSYPHDT12124	-	1 to 3	-	1 to 3	-	1 to 3	1 to 3	1	NSYPCVR124HD
NSYPHDT12124P	1 to 4	1 to 3	1 to 4	1 to 3	1 to 4	1 to 3	1 to 3	1	NSYPCVR124HD
NSYPHDT12126	-	1 to 3	-	1 to 3	-	1 to 3	1 to 3	1	NSYPCVR126HD
NSYPHDT12126P	1 to 4	1 to 3	1 to 4	1 to 3	1 to 4	1 to 3	1 to 3	1	NSYPCVR126HD
NSYPHDT1254	-	1	-	1	-	1	1	1	NSYPCVR54HD
NSYPHDT1254P	1 to 3	1	1 to 3	1	1 to 3	1	1	1	NSYPCVR54HD
NSYPHDT1274	-	1 to 2	-	1 to 2	-	1 to 2	1 to 2	1	NSYPCVR74HD
NSYPHDT1274P	1 to 4	1 to 2	1 to 4	1 to 2	1 to 4	1 to 2	1 to 2	1	NSYPCVR74HD
NSYPHDT1276	-	1 to 2	-	1 to 2	-	1 to 2	1 to 2	1	NSYPCVR76HD
NSYPHDT1276P	1 to 4	1 to 2	1 to 4	1 to 2	1 to 4	1 to 2	1 to 2	1	NSYPCVR76HD
NSYPHDT15124	-	1 to 3	-	1 to 3	-	1 to 3	1 to 3	1	NSYPCVR124HD
NSYPHDT15124P	1 to 4	1 to 3	1 to 4	1 to 3	1 to 4	1 to 3	1 to 3	1	NSYPCVR124HD
NSYPHDT15126	-	1 to 3	-	1 to 3	-	1 to 3	1 to 3	1	NSYPCVR126HD
NSYPHDT15126P	1 to 4	1 to 3	1 to 4	1 to 3	1 to 4	1 to 3	1 to 3	1	NSYPCVR126HD
NSYPHDT1574	-	1 to 2	-	1 to 2	-	1 to 2	1 to 2	1	NSYPCVR74HD
NSYPHDT1574P	1 to 4	1 to 2	1 to 4	1 to 2	1 to 4	1 to 2	1 to 2	1	NSYPCVR74HD
NSYPHDT1576	-	1 to 2	-	1 to 2	-	1 to 2	1 to 2	1	NSYPCVR76HD
NSYPHDT1576P	1 to 4	1 to 2	1 to 4	1 to 2	1 to 4	1 to 2	1 to 2	1	NSYPCVR76HD
NSYPHDT2074	-	1 to 2	-	1 to 2	-	1 to 2	1 to 2	1	NSYPCVR74HD
NSYPHDT2074P	1 to 4	1 to 2	1 to 4	1 to 2	1 to 4	1 to 2	1 to 2	1	NSYPCVR74HD

Steel outdoor HD enclosure									
NSYS3HD8630	1 to 2	-	1 to 2	-	1 to 2	-	-	-	-
NSYS3HD8840	1 to 2	1 to 2	1 to 2	1 to 2	1 to 2	1 to 2	1 to 2	1	NSYS3CVR84HD
NSYS3HD10640	1 to 2	1 to 2	1 to 2	1 to 2	1 to 2	1 to 2	1	1	NSYS3CVR64HD
NSYS3HD10840	1 to 4	1 to 2	1 to 4	1 to 2	1 to 4	1 to 2	1 to 2	1	NSYS3CVR84HD
NSYSFHD12640	1 to 3	1 to 3	1 to 3	1 to 3	1 to 3	1 to 3	1	1	NSYSFCVR64HD
NSYSFHD12660	1 to 3	1 to 3	1 to 3	1 to 3	1 to 3	1 to 3	1	1	NSYSFCVR66HD
NSYSFHD12840	1 to 4	1 to 3	1 to 4	1 to 3	1 to 4	1 to 3	1 to 2	1	NSYSFCVR84HD
NSYSFHD12860	1 to 4	1 to 3	1 to 4	1 to 3	1 to 4	1 to 3	1 to 2	1	NSYSFECA66HD
NSYSFHD16660	1 to 4	1 to 4	1 to 4	1 to 4	1 to 4	1 to 4	1	1	NSYSFCVR66HD
NSYSFHD16840	1 to 4	1 to 4	1 to 4	1 to 3	1 to 4	1 to 3	1 to 2	1	NSYSFCVR84HD
NSYSFHD16860	1 to 4	1 to 4	1 to 4	1 to 4	1 to 4	1 to 4	1 to 2	1	NSYSFECA66HD
NSYSFHD20840	1 to 4	1 to 4	1 to 4	1 to 4	1 to 4	1 to 4	1 to 2	1	NSYSFCVR84HD
NSYSFHD1212402D	1 to 4	1 to 3	1 to 4	1 to 2	1 to 4	1 to 2	1 to 3	1	NSYSFCVR124HD
NSYSFHD1212602D	1 to 4	1 to 3	1 to 4	1 to 3	1 to 4	1 to 2	1 to 3	1	NSYSFCVR126HD
NSYSFHD1612402D	1 to 4	1 to 4	1 to 4	1 to 3	1 to 4	1 to 3	1 to 3	1	NSYSFCVR124HD
NSYSFHD1612602D	1 to 4	1 to 4	1 to 4	1 to 3	1 to 4	1 to 3	1 to 3	1	NSYSFCVR126HD

Technical changes reserved. Information provided without guarantee. Images are for illustrative purposes only.

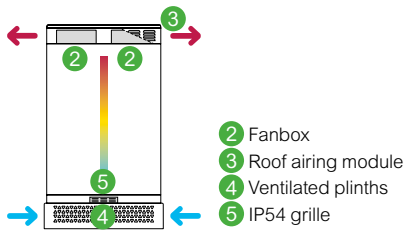

This table helps to configure thermal architectures, but it is highly recommended to use the ProClima Software to ensure the right thermal solution according to the selected architecture.

I-Line
<ul style="list-style-type: none"> • Integrated architecture particularly suitable for public areas • High thermal extraction of calorific energy up to 1500 W • Noise level with 1 fan: 55 dB when installed inside the upper airing module • High flow rate and extraction performance • Air flow in vertical axis

IP54 outlet grille (NSYCAG223LPF + G3 filter NSYCAF223T)	Ventilated plinths	Fanbox (1 filter NSYCAF190 for each Fanbox)	Roof airing module
--	--------------------	---	--------------------

Quantity to be installed		References		Quantity to be installed		References	
-	-	-	-	-	-	-	-
-	-	-	-	-	-	-	-
-	-	-	-	-	-	-	-
-	-	-	-	-	-	-	-
1 to 2	1	NSYZZ274VHD	-	1 to 2	1	NSYPCVR74HD	-
1 to 2	1	NSYZZ274VHD	-	1 to 2	1	NSYPCVR74HD	-
1 to 2	1	NSYZZ276VHD	-	1 to 2	1	NSYPCVR76HD	-
1 to 2	1	NSYZZ276VHD	-	1 to 2	1	NSYPCVR76HD	-
1	1	NSYZZ254VHD	-	1	1	NSYPCVR54HD	-
1	1	NSYZZ254VHD	-	1	1	NSYPCVR54HD	-
1 to 2	1	NSYZZ274VHD	-	1 to 2	1	NSYPCVR74HD	-
1 to 2	1	NSYZZ274VHD	-	1 to 2	1	NSYPCVR74HD	-
1 to 3	1	NSYZZ2124VHD	-	1 to 3	1	NSYPCVR124HD	-
1 to 3	1	NSYZZ2124VHD	-	1 to 3	1	NSYPCVR124HD	-
1 to 3	1	NSYZZ2126VHD	-	1 to 3	1	NSYPCVR126HD	-
1 to 3	1	NSYZZ2126VHD	-	1 to 3	1	NSYPCVR126HD	-
1	1	NSYZZ254VHD	-	1	1	NSYPCVR54HD	-
1	1	NSYZZ254VHD	-	1	1	NSYPCVR54HD	-
1 to 2	1	NSYZZ274VHD	-	1 to 2	1	NSYPCVR74HD	-
1 to 2	1	NSYZZ274VHD	-	1 to 2	1	NSYPCVR74HD	-
1 to 2	1	NSYZZ276VHD	-	1 to 2	1	NSYPCVR76HD	-
1 to 2	1	NSYZZ276VHD	-	1 to 2	1	NSYPCVR76HD	-
1 to 3	1	NSYZZ2124VHD	-	1 to 3	1	NSYPCVR124HD	-
1 to 3	1	NSYZZ2124VHD	-	1 to 3	1	NSYPCVR124HD	-
1 to 3	1	NSYZZ2126VHD	-	1 to 3	1	NSYPCVR126HD	-
1 to 3	1	NSYZZ2126VHD	-	1 to 3	1	NSYPCVR126HD	-
1 to 2	1	NSYZZ274VHD	-	1 to 2	1	NSYPCVR74HD	-
1 to 2	1	NSYZZ274VHD	-	1 to 2	1	NSYPCVR74HD	-
1 to 2	1	NSYZZ276VHD	-	1 to 2	1	NSYPCVR76HD	-
1 to 2	1	NSYZZ276VHD	-	1 to 2	1	NSYPCVR76HD	-
1 to 2	1	NSYZZ274VHD	-	1 to 2	1	NSYPCVR74HD	-
1 to 2	1	NSYZZ274VHD	-	1 to 2	1	NSYPCVR74HD	-

1	1	NSYSPFVX6200	NSYSPSX3200	-	-	-	-
1 to 2	1	NSYSPFVX8200	NSYSPLVX4200	1 to 2	1	NSYS3CVR84HD	-
1	1	NSYSPFVX6200	NSYSPLVX4200	1	1	NSYS3CVR64HD	-
1	1	NSYSPFVX8200	NSYSPLVX4200	1 to 2	1	NSYS3CVR84HD	-
1	1	NSYSPFVX6200	NSYSPLVX4200	1	1	NSYSFCVR64HD	-
1	1	NSYSPFVX6200	NSYSPLVX6200	1	1	NSYSFCVR66HD	-
1 to 2	1	NSYSPFVX8200	NSYSPLVX4200	1 to 2	1	NSYSFCVR84HD	-
1 to 2	1	NSYSPFVX8200	NSYSPLVX6200	1 to 2	1	NSYSFECA66HD	-
1	1	NSYSPFVX6200	NSYSPLVX6200	1	1	NSYSFCVR66HD	-
1 to 2	1	NSYSPFVX8200	NSYSPLVX4200	1 to 2	1	NSYSFCVR84HD	-
1 to 2	1	NSYSPFVX8200	NSYSPLVX6200	1 to 2	1	NSYSFECA66HD	-
1 to 2	1	NSYSPFVX8200	NSYSPLVX4200	1 to 2	1	NSYSFCVR84HD	-
1 to 2	1	NSYSPFVX8200	NSYSPLVX6200	1 to 2	1	NSYSFECA66HD	-
1 to 2	1	NSYSPFVX8200	NSYSPLVX4200	1 to 2	1	NSYSFCVR84HD	-
1 to 3	1	NSYSPFVX12200	NSYSPLVX4200	1 to 3	1	NSYSFCVR124HD	-
1 to 3	1	NSYSPFVX12200	NSYSPLVX6200	1 to 3	1	NSYSFCVR126HD	-
1 to 3	1	NSYSPFVX12200	NSYSPLVX4200	1 to 3	1	NSYSFCVR124HD	-
1 to 3	1	NSYSPFVX12200	NSYSPLVX6200	1 to 3	1	NSYSFCVR126HD	-

Technical changes reserved. Information provided without guarantee. Images are for illustrative purposes only.

EMC airing systems

EMC IP54 fan

- To effectively protect the equipment against electromagnetic interference, the EMC fan is equipped with:
 - a steel frame covering the plastic elements (self-extinguishing ABS according to standard UL94 V0),
 - a metal grille attached to the frame,
 - a beryllium gasket to ensure conductivity between the perimeter of the fan unit and the enclosure
- Ingress protection rating (according to IEC 60529): IP54

For more details see [page 664](#)



NSY17990

Characteristics	Flow rate (m³/h)		Voltage (V)	Dimensions External (mm)		References
	Free	With 1 outlet grille		External (mm)	Cut-out (mm)	
EMC IP54 fan	61	82	230	145 x 145 x 70	126 x 126	NSY17990
EMC IP54 fan	156	123	230	252 x 252 x 97	224 x 224	NSY17991
EMC IP54 fan	480	265	230	320 x 320 x 150	292 x 292	NSY17992

EMC IP54 fan

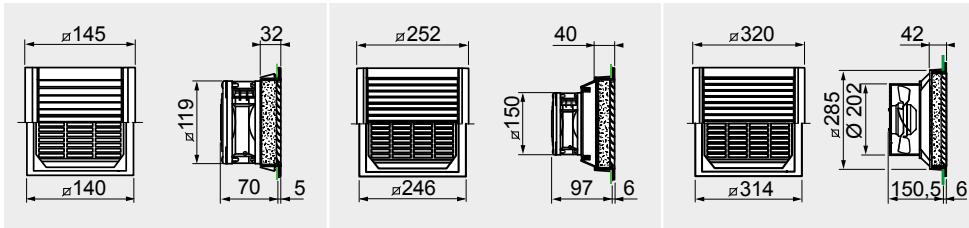

EMC IP54 outlet grille

- Grille equipped with:
 - a steel frame covering the plastic elements (self-extinguishing ABS according to standard UL 94 V-0),
 - a metal grille attached to the frame,
 - a beryllium gasket to ensure conductivity between the perimeter of the fan unit and the enclosure
- Ingress protection rating (according to IEC 60529): IP54



NSY17996

Characteristics	Dimensions External (mm)		References
	External (mm)	Cut-out (mm)	
EMC IP54 outlet grille	145 x 145 x 70	126 x 126	NSY17996
EMC IP54 outlet grille	252 x 252 x 97	224 x 224	NSY17997
EMC IP54 outlet grille	320 x 320 x 150	292 x 292	NSY17998

EMC IP55 cover

- This solution provides protection against electromagnetic interference and ensures IP55 ingress protection.
- The EMC cover is installed on the fans or standard IP54 outlet grilles.
- The cover is made of painted steel for outdoor use and completely covers the fan or outlet grille.
- Conductivity is obtained by means of:
 - a conductive painting (2 Ω),
 - a conductive copper braid.
- Color: RAL 7035 grey
- Ingress protection rating (according to IEC 60529): IP55
- Mechanical protection rating (according to IEC 62262): IK10

⁽¹⁾ Values given for a fan powered at 230 V. For other voltages, the values are similar

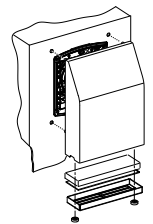

NSYCAP223LE

Characteristics	Flow rate (m³/h) with cover ⁽¹⁾		Dimensions External (mm)		References
	Free	With 1 outlet grille	External (mm)	Cut-out (mm)	
Sheet steel painted for outdoor applications, RAL 7035 grey	110	82	350 x 305 x 80	223 x 223	NSYCAP223LE
Sheet steel painted for outdoor applications, RAL 7035 grey	165	123	350 x 305 x 80	223 x 223	NSYCAP223LE
Sheet steel painted for outdoor applications, RAL 7035 grey	316	265	430 x 373 x 105	291 x 291	NSYCAP291LE
Sheet steel painted for outdoor applications, RAL 7035 grey	502	430	430 x 373 x 105	291 x 291	NSYCAP291LE

Dimensions of IP54 and EMC covers

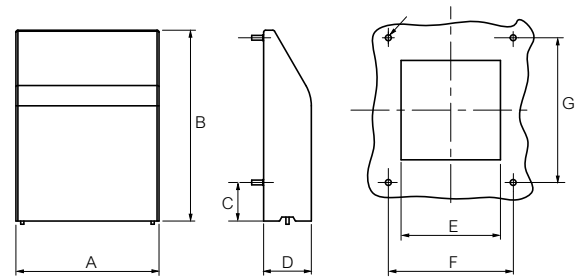

Dimensions (mm)							Cover references			
A	B	C	D	E	F	G	No. of fixing points	IP55	EMC	
180	240	49	49	49	157	182	4	NSYCAP125LZF	NSYCAP125LXF	NSYCAP125LE
305	350	61	61	61	283	280	8	NSYCAP223LZF	NSYCAP223LXF	NSYCAP223LE
373	430	73	73	73	351	348	8	NSYCAP291LZF	NSYCAP291LXF	NSYCAP291LE

Spare filter for cover

⁽¹⁾ Values given for a fan powered at 230 V.
For other voltages, the values are similar

Supply:
5 items per kit



NSYCAF125L55

Characteristics	Flow rate (m ³ /h) with cover ⁽¹⁾		Dimensions		References
	Free	With 1 outlet grille	External (mm)	Cut-out (mm)	
Spare filter for cover	74	53	240 x 180 x 60	125 x 125	NSYCAF125L55
Spare filter for cover	110	82	350 x 305 x 80	223 x 223	NSYCAF223L55
Spare filter for cover	165	123	350 x 305 x 80	223 x 223	NSYCAF223L55
Spare filter for cover	316	265	430 x 373 x 105	291 x 291	NSYCAF291L55
Spare filter for cover	502	430	430 x 373 x 105	291 x 291	NSYCAF291L55

Fan

⁽¹⁾ Values given for a fan powered at 230 V.
For other voltages, the values are similar

- Color: RAL 7035 grey



NSYCVF85M230PF

Characteristics	Flow rate (m ³ /h) with cover ⁽¹⁾		Dimensions		References
	Free	With 1 outlet grille	External (mm)	Cut-out (mm)	
Fan	74	53	240 x 180 x 60	125 x 125	NSYCVF85M230PF
Fan	110	82	350 x 305 x 80	223 x 223	NSYCVF165M230PF
Fan	165	123	350 x 305 x 80	223 x 223	NSYCVF300M230PF
Fan	316	265	430 x 373 x 105	291 x 291	NSYCVF560M230PF
Fan	502	430	430 x 373 x 105	291 x 291	NSYCVF850M230PF

Grille

⁽¹⁾ Values given for a fan powered at 230 V.
For other voltages, the values are similar

- Color: RAL 7035 grey



NSYCAG125L55

Characteristics	Flow rate (m ³ /h) with cover ⁽¹⁾		Dimensions		References
	Free	With 1 outlet grille	External (mm)	Cut-out (mm)	
Grille	74	53	240 x 180 x 60	125 x 125	NSYCAG125L55
Grille	110	82	350 x 305 x 80	223 x 223	NSYCAG223L55
Grille	165	123	350 x 305 x 80	223 x 223	NSYCAG223L55
Grille	316	265	430 x 373 x 105	291 x 291	NSYCAG291L55
Grille	502	430	430 x 373 x 105	291 x 291	NSYCAG291L55

Fans by components

Fans

- Free flow without filter or grille: 170 m³/h.
- Two models according to the input voltage: 230 and 115 V, 50-60 Hz.
- Ingress protection rating: IP20 according to IEC 60529.
- Options: IP20 outlet grille (ABS, black) and filter (black polyurethane foam).
- UL (cURus). Rated 12 according to UL50E

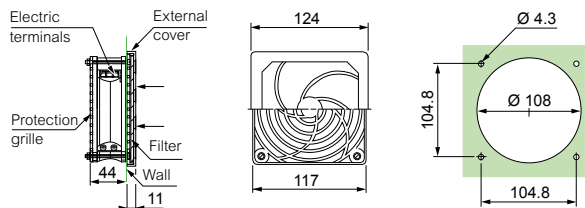

NSYCVF65M115PF

Characteristics	Flow rate (m ³ /h)	Voltage (V)	References
Fan	65	115	NSYCVF65M115PF
Fan	65	230	NSYCVF65M230PF

Fan accessories



NSYCAF108

Characteristics	Dimensions External (mm)	References
Outlet grille	124 x 124 x 11	NSYCAF108LP
Filter	-	NSYCAF108

Airing kit

- Ingress protection rating: IP33 according to IEC 60529.
- Mechanical protection rating: IK10 according to IEC 62262.
- Overall flow rate: 54 m³/h.

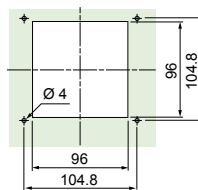

Supply:

- One 120 x 120 x 38 mm fan, 230 V - 50/60 Hz, free flow rate 170 m³/h,
- Two 120 x 120 mm metal grilles, RAL 7035 grey,
- Two 115 x 98 mm anti-insect filters, stainless-steel 304L cable Ø 0.32 mm braided,
- 1.07 mm meshes,
- 1 power cord,
- The fixings required for installation.



NSYCVF54M230MM2

Characteristics	Flow rate (m ³ /h)	Voltage (V)	References
Airing kit	54	230	NSYCVF54M230MM2

Top hood with fan and cover

- Ingress protection rating: IP54 according to IEC 60529.
- Certification: UL (cURus)
- Installation: Installation and removal from the outside.
- Electric power: 85 W.
- Noise level: 64 dB (A).

Comment:

Flow rate measured without counter-pressure

Supply:

Delivered with fixings and connection terminal block.



NSYCVF570M115MF

Characteristics	Weight (kg)	Flow rate (m ³ /h)	Voltage (V)	References
Top hood with fan and cover	5.8	570	115	NSYCVF570M115MF
Top hood with fan and cover	5.8	575	230	NSYCVF575M230MF

Fan motor



NSYCVF156M230



NSYCVF156M115

- Turbine-type fan motor for airing/extraction.

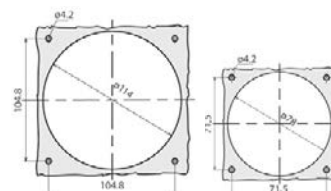

Characteristics	Flow rate (m ³ /h)	Voltage (V/Hz)	Absorbed power (W)	Noise level (dB)	External dimensions (mm)	References
Fan motor	156	230/50-60	17/15	42	120 x 120 x 38	NSYCVF156M230
Fan motor	156	115/50-60	17/15	42	120 x 120 x 38	NSYCVF156M115
Fan motor	35	230/50-60	16/14	32	80 x 80 x 25	NSYCVF35M230
Fan motor	35	115/50-60	16/14	32	80 x 80 x 25	NSYCVF35M115

Fan accessories

Outlet grille

- Outlet filter kit for enclosure airing.
- For coupling to fans use **NSYCVF156M●●●** and **NSYCVF35M●●●**.



NSYCAG114LPF

Characteristics	External dimensions (mm)	References
Outlet grille	120 x 120 x 38	NSYCAG114LPF
Outlet grille	80 x 80 x 25	NSYCAG78LPF

Rear protective grille

- Protective grille for enclosure fan motor
- For coupling to fans use **NSYCVF156M●●●** and **NSYCVF35M●●●**.



NSYCVA114M



NSYCVA78M

Characteristics	External dimensions (mm)	References
Rear protective grille	120 x 120 x 38	NSYCVA114M
Rear protective grille	80 x 80 x 25	NSYCVA78M

Fan connection cable

- For coupling to the connection terminal of the fan motors.



NSYCVAC100

Characteristics	References
Fan connection cable, length = 1 m	NSYCVAC100

Air circulation for internal forced convection

Circulation fan

User protection according to DIN 31001.

Dimensions:

- Fan: 119 x 119 x 38 mm.
- Collar: Length: 140 mm; Fixing center-to-center distance: 130 mm.
- Motor mounted on ball bearing

Comment:

⁽¹⁾ Free flow.



NSYCVF170M115

Characteristics	Flow rate (m³/h) ⁽¹⁾	Voltage (V)	Weight (kg)	P (W)	dB (A)	References
Circulation fan	170	115	0.82	17	41	NSYCVF170M115
Circulation fan	170	230	0.82	17	41	NSYCVF170M230

Tangential fan, 19" 2 U

- Air is sucked in from the front, filtered and forced vertically through the equipment.

Comment:

⁽¹⁾ Flow rate measured without counter-pressure.

Supply:

Delivered with fixings and connection terminal block.



NSYAVG2U300

Characteristics	Flow rate (m³/h) ⁽¹⁾	Voltage (V)	P (W)	References
Tangential fan, 19" 2 U	300	230 (50-60 Hz)	37	NSYAVG2U300

Comment:

Flow rate measured without counter-pressure.

⁽¹⁾ Direct current.

Supply:

Delivered without connection cord



NSYAVD1U480



NSYAVD1U970

Characteristics	Flow rate (m³/h)	Voltage (V)	No.	Weight (kg)	P (W)	I (mA)	dB (A)	Depth (mm)	References
Circulation fan, 19" 1 U D210	486	230	3	3.3	45	300	43	208	NSYAVD1U480
Circulation fan, 19" 1 U D330	972	230	6	5.5	90	600	44	330	NSYAVD1U970
Circulation fan, 19" 1 U D452	1458	230	9	7.8	135	900	45	452	NSYAVD1U1450
Circulation fan, 19" 1 U D210 ⁽¹⁾	552 ⁽²⁾	48 (DC)	3	3.3	21.3	330	43	208	NSYAVD1U550M48

Technical changes reserved. Information provided without guarantee. Images are for illustrative purposes only.

Smart airing systems

Fan 38 m³/h

Comment: Adding the Dust Sensor will decrease the flow rate by nearly 10%.



★ Warning: The fan NSYCVF38M230DG and NSYCVF38M115DG and NSYCVF38M230PF MUST NOT be connected to a power conversion module, an inverter or UPS!

Flow curves

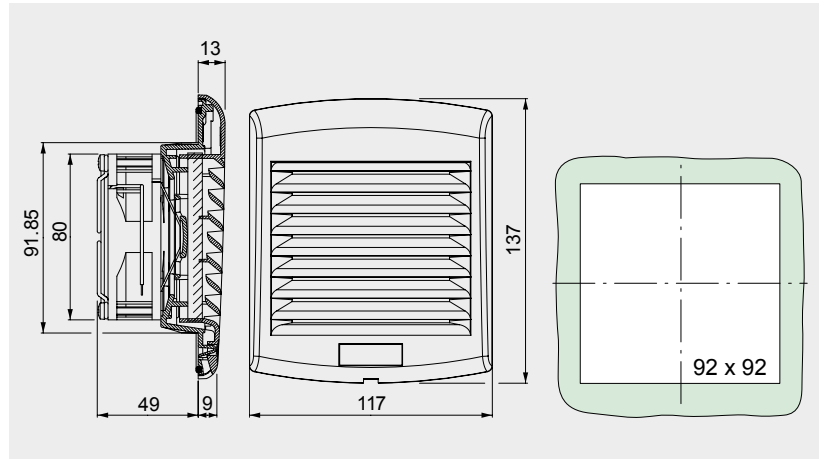
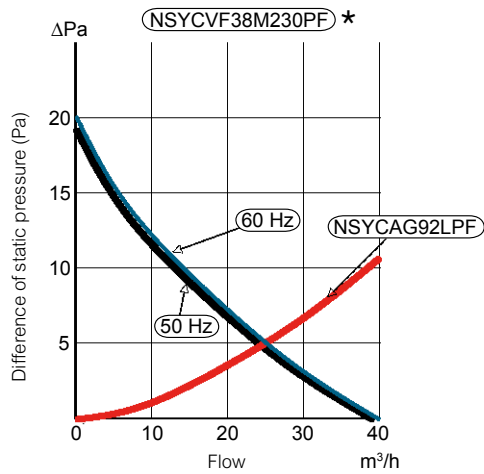

Fan 85 m³/h

Comment: Adding the Dust Sensor will decrease the flow rate by nearly 5%.

Flow curves

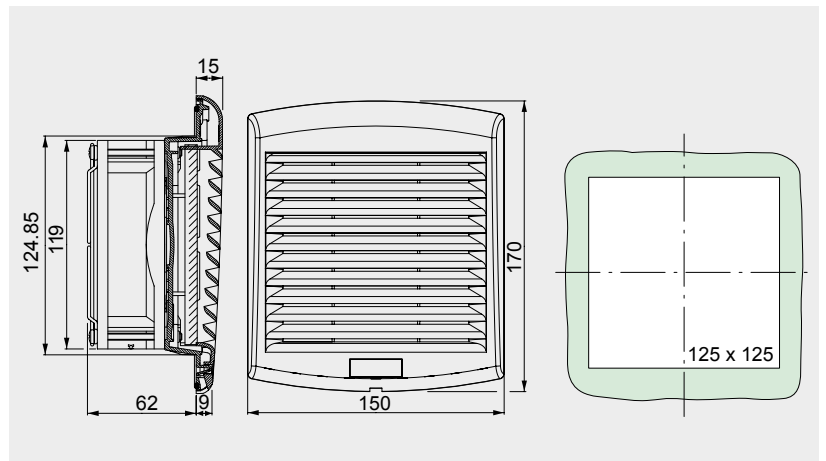
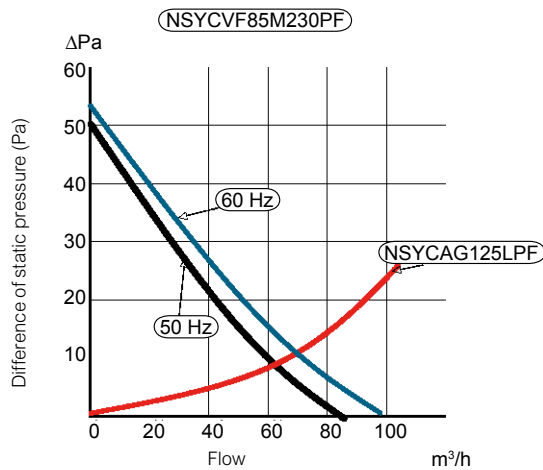

Fan 165 m³/h

Comment: Adding the Dust Sensor will decrease the flow rate by nearly 5%.

Flow curves

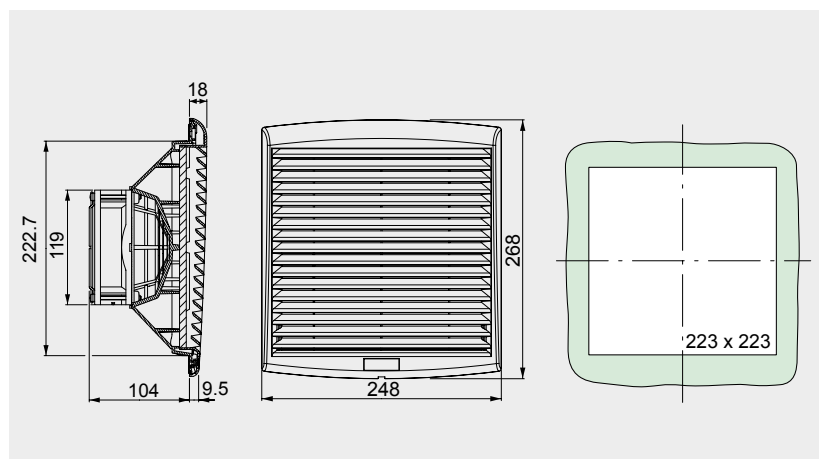
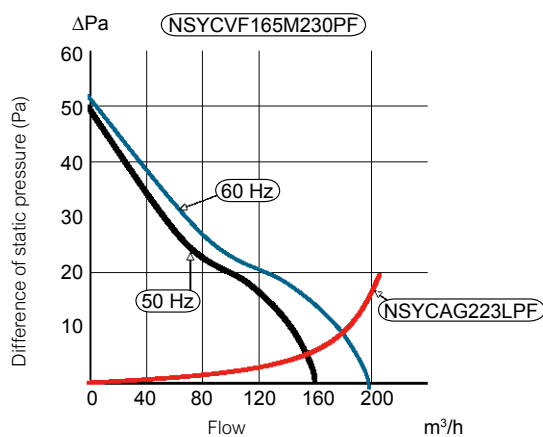

Smart airing systems

Fan 300 m³/h

Comment: Adding the Dust Sensor will decrease the flow rate by nearly 5%.

Flow curves

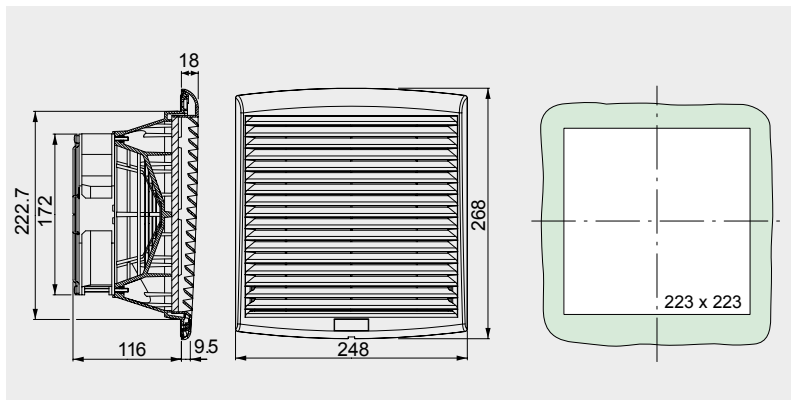
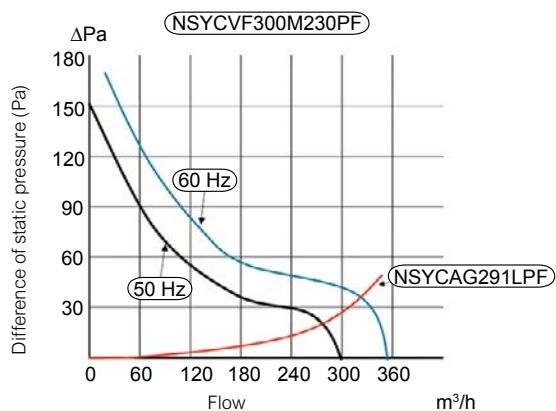

Fan 560-850 m³/h

Comment: Adding the Dust Sensor will decrease the flow rate by nearly 5%.

Flow curves

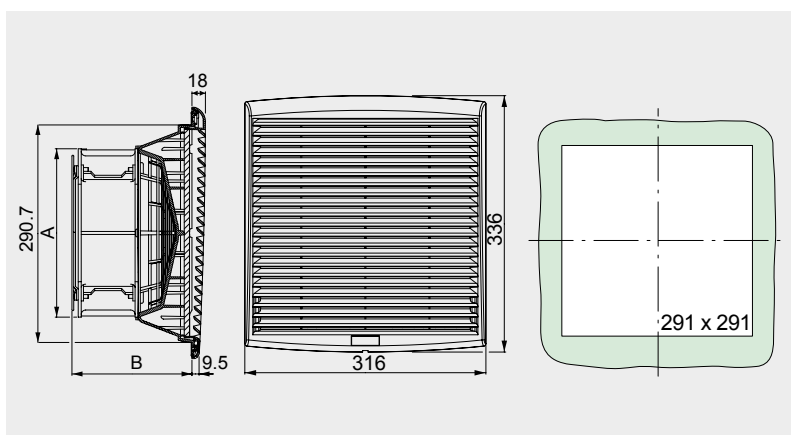
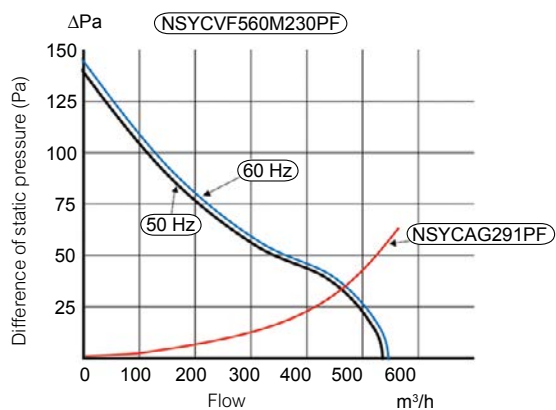

Flow curves

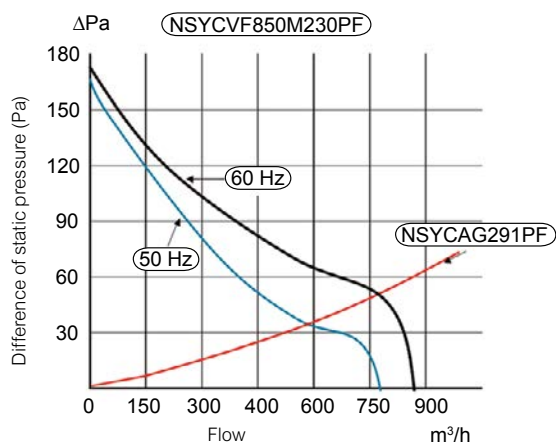

References	A	B
NSYCVF560M230PF	225	160.5
NSYCVF560M115PF	225	160.5
NSYCVF850M230PF	280	162
NSYCVF850M115PF	280	162

Metal louvre plate, rectangular

- Material: Steel
- Structured finish, epoxy polyester painting, RAL 7035 grey
- Ingress protection rating (according to IEC 60529): IP20
- Installation: On the sides of the enclosure. Fixing by screws.

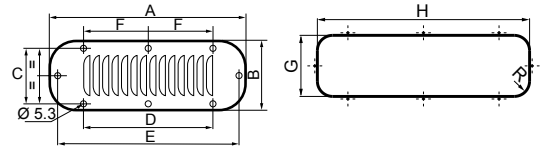

Supply:
One metal louvre and fixing elements



NSYCAG110X46M

Characteristics	A (mm)	B (mm)	C (mm)	D (mm)	E (mm)	F (mm)	G (mm)	H (mm)	R (mm)	References
Metal louvre plate, rectangular	144	62	36	110	-	-	110	46	10	NSYCAG110X46M
Metal louvre plate, rectangular	208	90	72	94	190	-	180	62	18	NSYCAG180X62M
Metal louvre plate, rectangular	244	90	72	130	226	-	216	62	18	NSYCAG216X62M
Metal louvre plate, rectangular	345	118	100	231	327	115.5	317	90.5	30	NSYCAG317X91M
Metal louvre plate, rectangular	345	148	130	231	327	115.5	317	120	30	NSYCAG317X120M
Metal louvre plate, rectangular	445	148	130	267	427	148.5	417	120	30	NSYCAG417X120M

Metal louvre plate, square

- Ingress protection rating (according to IEC 60529): IP23

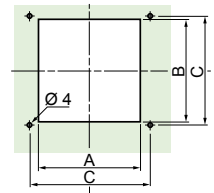

Supply:
One metal louvre



NSYCAF104X95LM

Characteristics	Dimensions (mm)	A (mm)	B (mm)	C (mm)	Slot width (mm)	No. of slots	References
Metal louvre plate, square	120 x 120	95	90	104.8	90	5	NSYCAG104X95LM
Metal louvre plate, square	160 x 160	110	130	140	100	5	NSYCAG130X110LM
Metal louvre plate, square	220 x 220	190	170	200	180	5	NSYCAG170X190LM

Anti-insect filters for metal louvre plate, square

- Material: Stainless-steel 304L Ø 0.32 mm wire mesh, 1.07 mm, thickness 0.6 mm
- Ingress protection rating (according to IEC 60529): IP33
- Installation: Between the enclosure and the metal louvre

Supply:
One anti-insect filter



NSYCAF104X95X

Characteristics	External dimensions (mm)	Weight	References
Anti-insect filters for metal louvre plate, square	98 x 115	0.8 kg/m ²	NSYCAF104X95X
Anti-insect filters for metal louvre plate, square	133 x 158	0.8 kg/m ²	NSYCAF130X110X
Anti-insect filters for metal louvre plate, square	197 x 215	0.8 kg/m ²	NSYCAF170X190X

Roof elevators

Allow the roof to be raised, providing natural airing.

- Material: Zinc-coated steel
- They are screwed onto the structure of SF enclosures at the roof fixing points

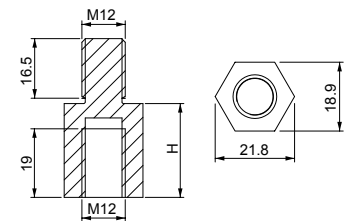

Supply:
4 elevators



NSYRE26

Characteristics	Top elevation (mm)	References
Roof elevators	26	NSYRE26
Roof elevators	60	NSYRE60

Hood for natural airing



NSYCAC228RMF

Natural airing device for coupling to the top of metal floor-standing enclosures. Solution for combination with the airing slots.

- Material: Steel
- Finish: Structured finish, epoxy polyester painting, RAL 7035 grey
- Ingress protection rating (according to IEC 60529): IP54
- Installation: Fixing to the top by means of caged nuts and special screws

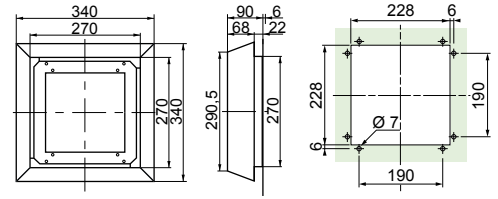

Supply:

1 hood for natural airing and fixing elements

Characteristics	Weight	References
Hood for natural airing	4.6 (kg)	NSYCAC228RMF
Spare filter	-	NSYCAF228R

Plastic airing louvres

Four models available according to IP rating, in vertical position.



NSYCAG45LP

NSYCAG35LP

NSYCAG38LP

NSYCAG33LP

NSYCAG19LP

Characteristics	Ingress protection rating	Cut-out Ø (mm)	References
Plastic airing louvres	IP22	45.5	NSYCAG45LP
Plastic airing louvres	IP30/44	35	NSYCAG35LP
Plastic airing louvres	IP45	38	NSYCAG38LP
Plastic airing louvres	IP44	33	NSYCAG33LP
	IP45	19	NSYCAG19LP

Supply:

References by unit. Order by multiples of 2 units (2, 4, 6, etc)

Sealed anti-condensation valve

Controls the pressure to avoid condensation following internal temperature increase.

- Material: PA6-V2, acrylic co-polymer membrane, water- and oil-repelling
- Ingress protection rating: IP68
- Temperature of use: -40... +105 °C



NSYCAG12LPH2

Characteristics	Cut-out Ø (mm)	Permeability	Pressure difference	Minor pack.	References
Sealed anti-condensation valve	M12	16 litres/h	$\Delta P < 1 \text{ bar}$	10	NSYCAG12LPH1
Sealed anti-condensation valve	M12	120 litres/h	$\Delta P < 0.1 \text{ bar}$	10	NSYCAG12LPH2

Choose air-to-air exchangers to take advantage of cooler ambient temperatures, such as in food and beverage plants, to evacuate large amounts of heat while retaining the independence of the internal and external air circuits.



Air-to-air exchangers: A new range energy efficient



Higher efficiency through improved design

- With an updated external grill design, and by positioning cooling closer to critical equipment, such as speed drives, ClimaSys now provides better flow, better cooling, and higher energy efficiency.



Protection

- All side-mounted models are IP55 internally according to EN 60529.



Faster installation

- A number of design improvements reduce installation time. Mounting requires single cut-outs and a minimum of screws. Wiring is accomplished with smart interconnects.



New certifications and declarations

- CE
- EAC



Simplicity saves you time

- Our free ProClima thermal calculation software makes specification simple and fast. A new thermal solutions module integrates calculation for cooling and control devices, helping you maximize the energy efficiency of your systems.

Air-to-air exchangers, side-mounted models



Side-mounted models				
Characteristics	<ul style="list-style-type: none"> The air-to-air exchanger can be used in heavily polluted environments provided that the ambient temperature is at least 10 °C lower than the internal temperature wanted. Main components: Thermostat adjustment system, exchanger cassette, fans for internal and external circuits of the enclosure. 			
Material	Painted zinc-coated steel			
Color	RAL 7035 grey			
Ingress protection rating (according to IEC 60529)	IP55			
Certifications and declarations	CE, EAC			
Installation	Indoor. For outdoor applications or other surface finishes please consult us.			
Cooling characteristics				
Specific power	22 W/K	36 W/K	50 W/K	80 W/K
Air flow of the internal circuit (enclosure)	280 m³/h	570 m³/h	600 m³/h	1050 m³/h
Air flow of the external circuit (ambient)	280 m³/h	570 m³/h	600 m³/h	1050 m³/h
Thermostat type	-	Mechanical	Mechanical	Mechanical
Temperature setting range	-	+5 ... +60 °C	+5 ... +60 °C	+5 ... +60 °C
Temperature range of external circuit (ambient)	-5 ... +55 °C	-5 ... +55 °C	-5 ... +55 °C	-5 ... +55 °C
Type of fluid	Air	Air	Air	Air
Electric characteristics				
Input voltage	1 x 230 V / 50-60 Hz	1 x 230 V / 50-60 Hz	1 x 230 V / 50-60 Hz	1 x 230 V / 50-60 Hz
Rated current	0.5 A	0.7 A	0.7 A	1.1 A
Power consumption	72 W	160 W	160 W	240 W
Thermal protection recommended (fuse)	T1 A	T1 A	T1 A	T2 A
Physical characteristics				
External dimensions (H x W x D)	413 x 189 x 149 mm	771 x 316 x 103 mm	771 x 316 x 103 mm	1260 x 317 x 148 mm
Protection degree IP internal /external (according to IEC 60529)	IP55 / IP22	IP55 / IP22	IP55 / IP22	IP55 / IP22
Noise level	59 dB	62 dB	62 dB	64 dB
Weight of unit	7 kg	10 kg	10 kg	17 kg
References				
	NSYCEA22E	NSYCEA36	NSYCEA50	NSYCEA80

Choose air-to-water exchangers for especially difficult environments where there is no external air circuit available but a stable cold-water circuit can be supplied.



Air-to-water exchangers: For highly polluted environments



Many mounting options give you the right fit

- Air-to-water exchangers offer roof and side-mounted options.



Certifications and declarations

- CE
- EAC



Extended ratings to meet any challenge

- Provide options for up to 15 kW of cooling power, among the world's highest power ratings for air-to-water exchangers.



Protection

- All side-mounted models are IP55-protected internally and externally according EN 60529. Top-mounted models are IP54.



New material options adapt to any application

- Air-to-water exchangers can be provided in the same material as electrical enclosures (for example stainless-steel) for a homogeneous appearance and thermal performance.

Air-to-water exchangers, side-mounted models



Characteristics		Side-mounted models				
		<ul style="list-style-type: none"> Main components: Thermostat adjustment system, Exchange cassette, fans for internal circuits of the enclosure, protection device against possible leaks. Eyebolts included in all models. 				
Material	RAL 7035 grey painted zinc-coated steel or stainless-steel					
Ingress protection rating (according to IEC 60529)	IP55					
Certifications and declarations	<ul style="list-style-type: none"> CE declaration UL (only references ending with UL) EAC 					
Installation	Indoor. For outdoor applications or other surface finishes please consult us.					
Cooling characteristics						
Cooling power W10A35	1000 W	1750 W	2500 W	3500 W	4500 W	
Hydraulic circuit maximum pressure	5 bar	5 bar	5 bar	5 bar	5 bar	
Internal airflow	330 m³/h	570 m³/h	860 m³/h	1050 m³/h	1450 m³/h	
Thermostat type	Mechanical	Mechanical	Mechanical	Mechanical	Mechanical	
Temperature setting range	+20 ... +46 °C	+20 ... +46 °C	+20 ... +46 °C	+20 ... +46 °C	+20 ... +46 °C	
Temperature range of external circuit (ambient)	+1 ... +70 °C	+1 ... +70 °C	+1 ... +70 °C	+1 ... +70 °C	+1 ... +70 °C	
Type of fluid	Filtered water or glycolised water	Filtered water or glycolised water	Filtered water or glycolised water	Filtered water or glycolised water	Filtered water or glycolised water	
Water flow	150 l/h	150 l/h	500 l/h	500 l/h	500 l/h	
Pressure drop	0.1 bar	0.1 bar	0.3 bar	0.2 bar	0.2 bar	
Hydraulic connection	3/8" G	1/2" G	1/2" G	1/2" G	1/2" G	
Electric characteristics						
Input voltage	1 x 230 V / 50-60 Hz*	1 x 230 V / 50-60 Hz*	1 x 230 V / 50-60 Hz*	1 x 230 V / 50-60 Hz*	1 x 230 V / 50-60 Hz*	
Rated Intensity	0.17 A	0.36 A	0.33 A	0.55 A	0.71 A	
Power consumption absorbed W10A35	29 W	75 W	80 W	130 W	160 W	
Thermal protection recommended (fuse)	T2 A	T2 A	T2 A	T2 A	T2 A	
Physical characteristics						
External dimensions (H x W x D)	450 x 310 x 115 mm	901 x 398 x 137 mm	901 x 398 x 137 mm	1148 x 398 x 163 mm	1148 x 398 x 163 mm	
Protection degree IP internal / external (according to IEC 60529)	IP55 / IP55	IP55 / IP55	IP55 / IP55	IP55 / IP55	IP55 / IP55	
Noise level	55 dB (A)	58 dB (A)	58 dB (A)	64 dB (A)	69 dB (A)	
Weight of unit	12 kg	18 kg	19 kg	29 kg	30 kg	
References						
Steel	NSYCEW1K	NSYCEW1K8	NSYCEW2K5	NSYCEW3K5	NSYCEW4K5	
Stainless-steel	NSYCEWX1K	NSYCEWX1K8	NSYCEWX2K5	-	-	

Side-mounting model



Top Mounting model

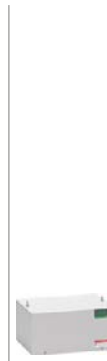

Characteristics	Side-mounted models		Top Mounting model
	<ul style="list-style-type: none"> Main components: Thermostat adjustment system, Exchange cassette, fans for internal circuits of the enclosure, protection device against possible leaks. Eyebolts included in all models. 		
Material	RAL 7035 grey painted zinc-coated steel or stainless-steel		
Ingress protection rating (according to IEC 60529)	IP55		IP54
Certifications and declarations	<ul style="list-style-type: none"> CE declaration UL (only references ending with UL) EAC 		
Installation	Indoor. For outdoor applications or other surface finishes please consult us.		
Cooling characteristics			
Cooling power W10A35	6000 W	6000 W	2500 W
Hydraulic circuit maximum pressure	5 bar	8 bar	5 bar
Internal airflow	1450 m³/h	1450 m³/h	750 m³/h
Thermostat type	Mechanical	Mechanical	Mechanical
Temperature setting range	+20 ... +46 °C	+20 ... +46 °C	+20 ... +46 °C
Temperature range of external circuit (ambient)	+1 ... +70 °C	+1 ... +70 °C	+1 ... +70 °C
Type of fluid	Filtered water or glycolised water	Filtered water or glycolised water	Filtered water or glycolised water
Water flow	800 l/h	800 l/h	500 l/h
Pressure drop	0.5 bar	0.5 bar	0.3 bar
Hydraulic connection	1/2" G	1/2" G	1/2" G
Electric characteristics			
Input voltage	1 x 230 V / 50-60 Hz*	2 x 400-440 V / 50-60 Hz	1 x 230 V / 50-60 Hz
Rated Intensity	0.71 A	0.4 A	0.30 A
Power consumption absorbed W10A35	160 W	170 W	65 W
Thermal protection recommended (fuse)	T2 A	T1 A	T2 A
Physical characteristics			
External dimensions (H x W x D)	1500 x 450 x 163 mm	1500 x 450 x 163 mm	270 x 400 x 542 mm
Protection degree IP internal / external (according to IEC 60529)	IP55 / IP55	IP55 / IP55	IP54 / IP55
Noise level	69 dB (A)	69 dB (A)	58 dB (A)
Weight of unit	40 kg	42 kg	19 kg
References			
Steel	NSYCEW6K	NSYCEW6K2P4	NSYCEW2K5R

Accessories

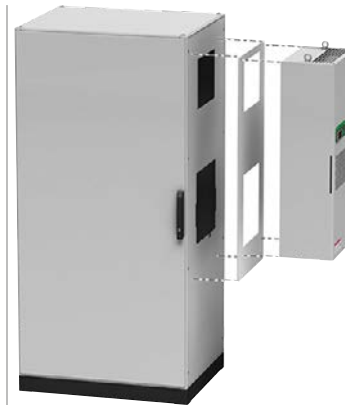

Characteristics	Air-to-air and air-to-water exchangers CE		Retrofit panel
	Steel	Stainless-steel	
Material			Panel that enable to mount a new ClimaSys CE units by replacement of old Schneider Electric cooling systems.
Color			Metal painted
Supply			RAL 7035 grey
References			1 unit
Air- air exchangers			Old Schneider Electric cooling system
Side-mounted models	NSYCEA36	-	NSYCEA35W230VL NSYCEA35W230VLE
	NSYCEA50	-	-
	NSYCEA80	-	NSYCEA70W230VL
Air-to-water exchangers			
Side-mounted models	NSYCEW1K	NSYCEWX1K	-
	NSYCEW1K8	NSYCEWX1K8	-
	NSYCEW2K5	NSYCEWX2K5	NSYCEW2100W230VL
	NSYCEW3K5	-	NSYCEW3150W230VL
	NSYCEW4K5	-	-
	NSYCEW6K	-	-
	NSYCEW6K2P4	-	-
Top-mounted model	NSYCEW2K5R	-	-

Air-to-air exchangers, side-mounted models

NSYCEA22E

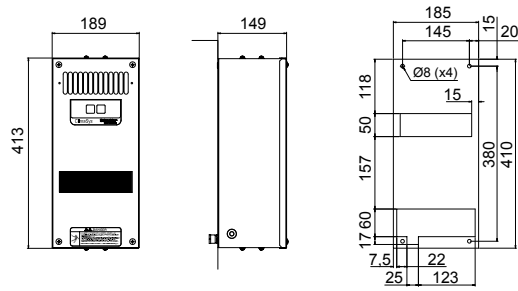

NSYCEA36 / NSYCEA50

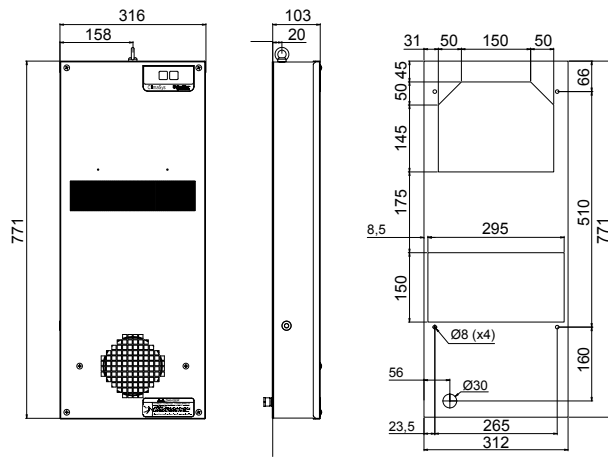

NSYCEA80

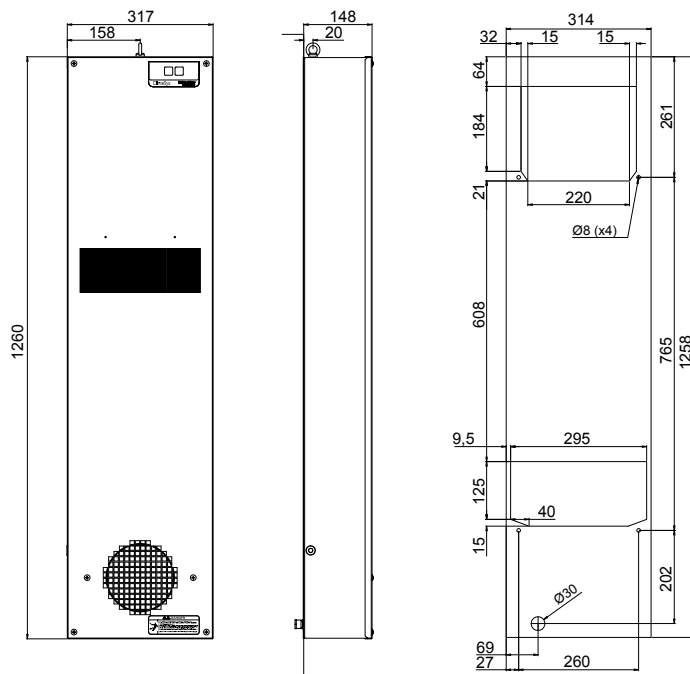

Air-to-water exchangers, side-mounted models

Performance curves

NSYCEW●●1K●●

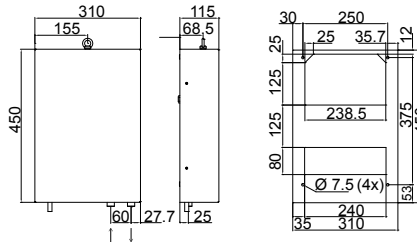
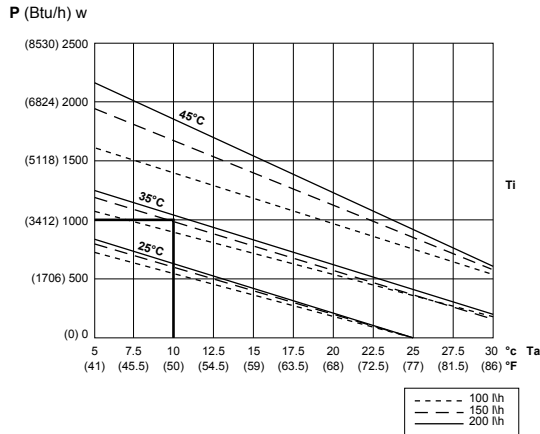

Performance curves

NSYCEW●●1K8●● – NSYCEW●●2K5●●

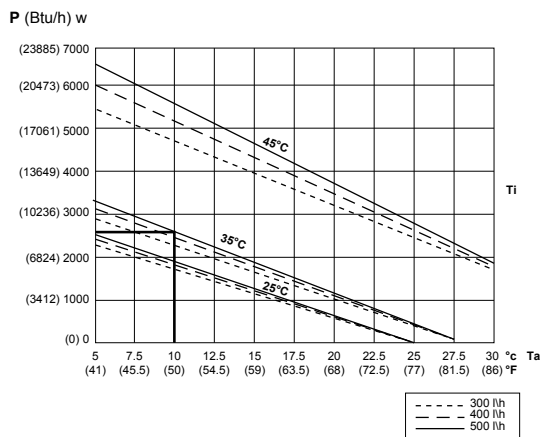
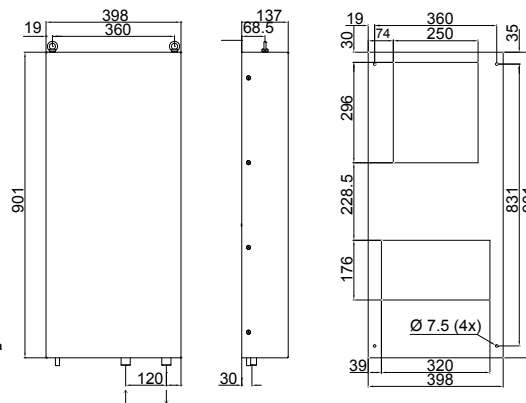
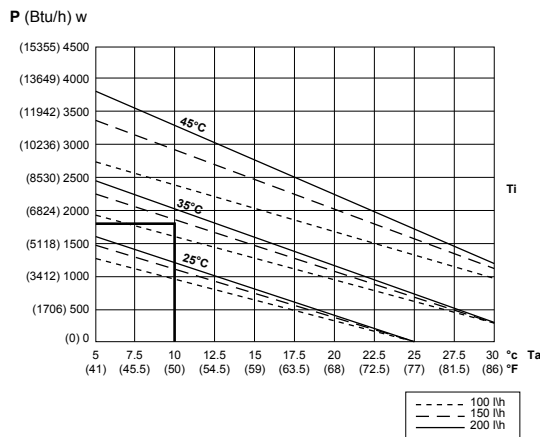

P = Cooling power
 Ta = Inlet water temperature
 Ti = Target internal temperature of the enclosure

Technical changes reserved. Information provided without guarantee. Images are for illustrative purposes only.

Air-to-water exchangers, side-mounted models

Performance curves

NSYCEW●●3K5●● - NSYCEW●●4K5●●

P (Btu/h) w

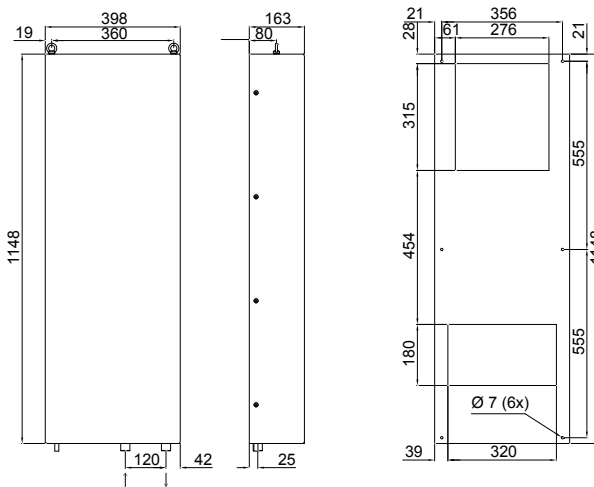
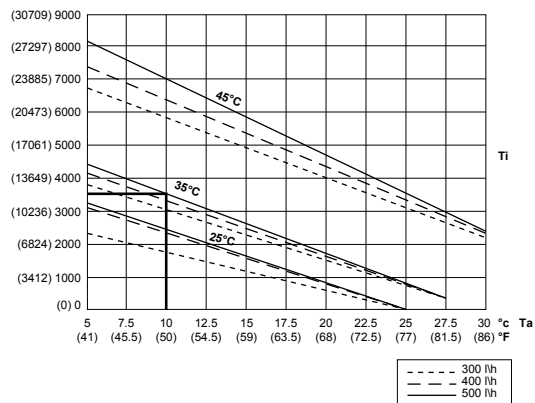

P (Btu/h) w

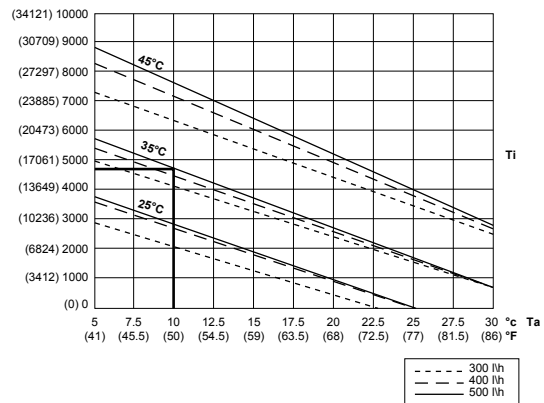

NSYCEW●●6K●●

P (Btu/h) w

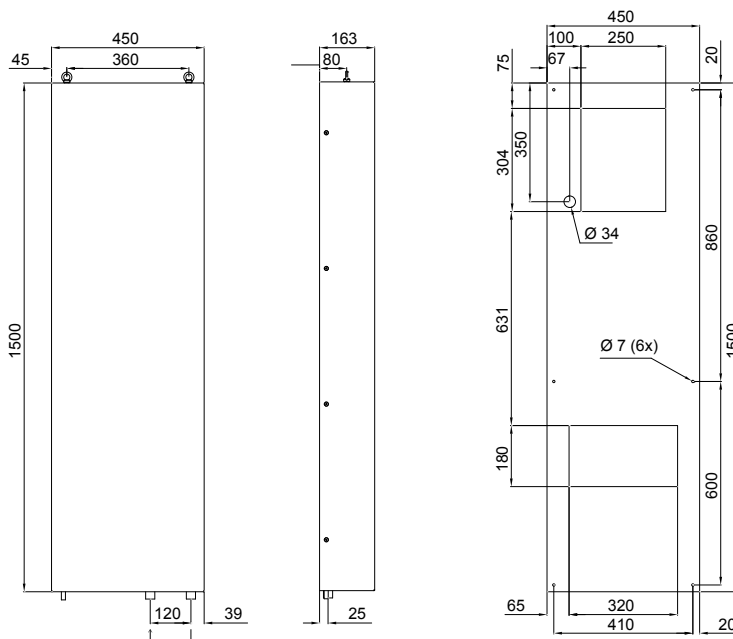
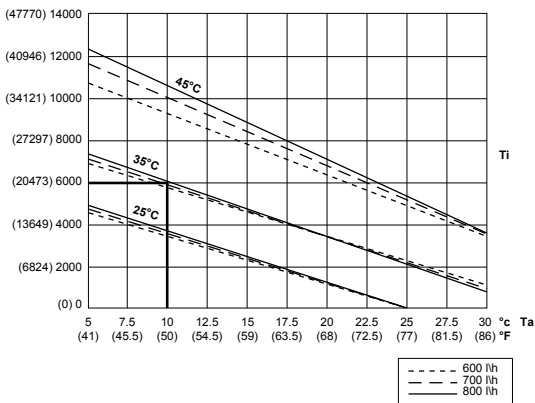

P = Cooling power
 Ta = Inlet water temperature
 Ti = Desired internal temperature of the enclosure

Technical changes reserved. Information provided without guarantee. Images are for illustrative purposes only.

Air-to-water exchangers, side-mounted models

Performance curves

NSYCEW●●3K5●● - NSYCEW●●4K5●●

P (Btu/h) w

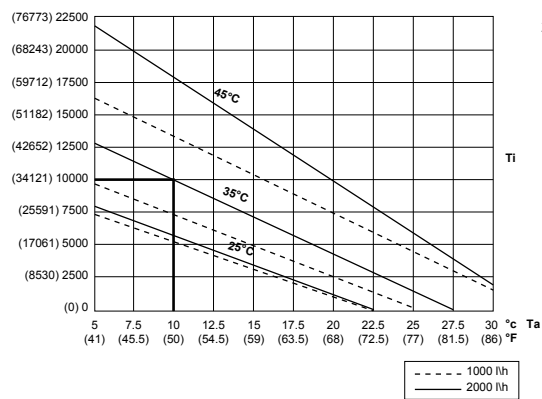

P (Btu/h) w

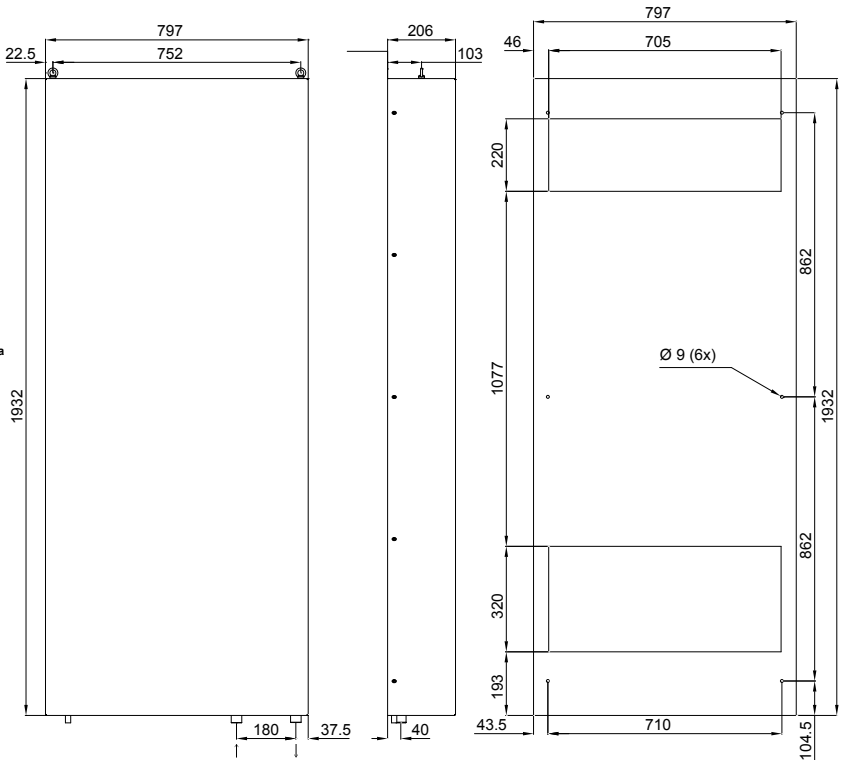
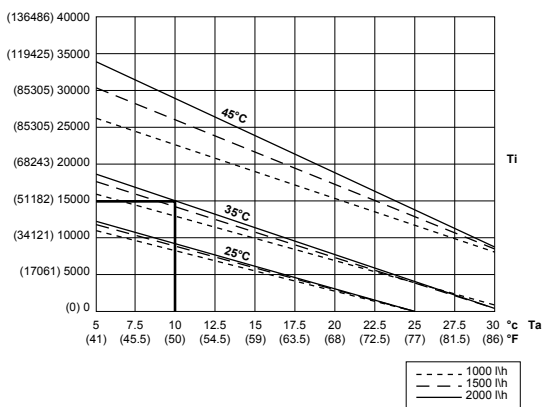

Performance curves

NSYCEW●●6K●●

P (Btu/h) w

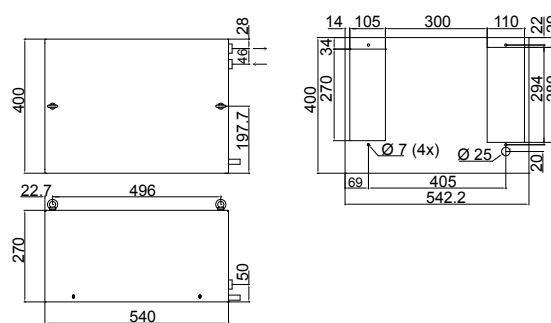
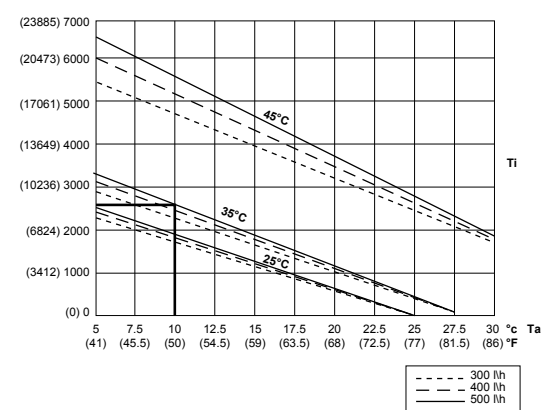

P = Cooling power
Ta = Inlet water temperature
Ti = Desired internal temperature of the enclosure

Technical changes reserved. Information provided without guarantee. Images are for illustrative purposes only.



Choose cooling units for harsh environments where ambient temperatures can reach up to 55 °C. The unit's integrated alarm system will alert you in the event of any operational anomaly.



Cooling units: For high ambient temperatures



Several mounting solutions

- Three models: Roof model, floor model, side model. An additional SLIM model with space-saving dimensions allows a perfect integration into control panel doors.



Large range of power levels

- Provide options for up to 15 kW of cooling power.

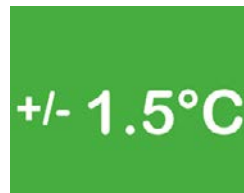

Precision of temperature control

- All ClimaSys cooling units are provided with a precise electronic control system using a thermostat to achieve a high cooling precision (+/- 1.5 °C).



Enhanced protection

- An internal grid of a new design helps protect the components and personnel during operation of the equipment while at the same time facilitating cleaning and maintenance.



Broad temperature range for outdoor enclosures

- The outdoor version can withstand extreme environments and provide an operating temperature range of -20 °C to +55 °C.



Speed of access to information

- The new display offers fast access to the configuration parameters and information from the sensors located in the enclosure (does not apply to heavy-duty outdoor enclosures)



Certifications and declarations

- UL,
- CE,
- EAC



New materials

- Stainless-steel and painted galvanized steel for the outside dedicated to clean, hygienic environments such as food and beverage production plants.



Simplicity

- No tools needed to replace the filter. It just takes a few seconds.

Cooling units



Characteristics		Side-mounted models			
		<ul style="list-style-type: none"> • Environmentally friendly gas R134a (HFC). • Electronic thermostats in all models. • Alarm signal for door contact included in all models. • Eyebolts included. • The external filter, not included as standard, is strongly recommended for harsh environments. • Digital display.. • Evaporation-condensation water unit integrated from 800 W to 15 kW. 			
Material		RAL 7035 grey painted zinc-coated steel or stainless-steel			
Certifications and declarations		<ul style="list-style-type: none"> • CE declaration • UL (only references ending with UL) • EAC 			
Installation		Indoor			
Cooling characteristics					
Cooling power L35-L35 according to EN 14511		300 W (1024 Btu/h)	380 W (1297 Btu/h)	640 W (2184 Btu/h)	820 W (2798 Btu/h)
Cooling power L35-L50 according to EN 14511		150 W (512 Btu/h)	240 W (819 Btu/h)	470 W (1604 Btu/h)	680 W (2320 Btu/h)
Air flow of the internal circuit (enclosure)		280 m ³ /h	280 m ³ /h	330 m ³ /h	330 m ³ /h
Air flow of the external circuit (ambient)		280 m ³ /h	280 m ³ /h	570 m ³ /h	570 m ³ /h
Thermostat type		Electronic	Electronic	Electronic	Electronic
Temperature range of circuit (enclosure)		+20 ... +46 °C	+20 ... +46 °C	+20 ... +46 °C	+20 ... +46 °C
Maximum outside temperature		+55 °C	+55 °C (+50 °C)*	+55 °C (+50 °C)*	+55 °C (+50 °C)*
Temperature range of external circuit (ambient)		+5 ... +55 °C*	+5 ... +55 °C* (+5 ... +50 °C)*	+5 ... +55 °C* (+5 ... +50 °C)*	+5 ... +55 °C* (+5 ... +50 °C)*
Type of cooling gas		R134a	R134a	R134a	R134a
Cooling gas weight		0.13 kg	0.16 kg	0.23 kg	0.23 kg
Maximum pressure of cooling circuit		25 bar	26 bar (28 bar)**	25 bar (28 bar)**	25 bar (28 bar)**
External filter		Optional, see page 691	Optional, see page 691	Optional, see page 691	Optional, see page 691
Electric characteristics					
Input voltage		1 x 230 V / 50-60 Hz	1 x 230 V / 50-60 Hz**	1 x 230 V / 50-60 Hz**	1 x 230 V / 50-60 Hz**
Starting/rated current		4.2 A / 1.5 A	6.0 A / 1.6 A	8.1 A / 2.1 A	10.8 A / 2.6 A
Power consumption L35-L35 according to EN 14511		270 W	280 W	400 W	440 W
Power consumption L35-L50 according to EN 14511		310 W	330 W	470 W	490 W
Energy efficiency ratio (EER) L35-L35		1.1	1.4	1.6	1.9
Thermal protection recommended (fuse)		T4 A	T4 A	T6 A	T6 A
Physical characteristics					
External dimensions (H x W x D)		340 x 525 x 135 mm	460 x 285 x 180 mm	606 x 316 x 212 mm	783 x 348 x 215 mm
Protection degree IP internal /external according to IEC 60529		IP55 / IP34	IP55 / IP34	IP55 / IP34	IP55 / IP34
Noise level		61 dB	60 dB	65 dB	65 dB
Weight of unit		17 kg	17 kg	21 kg	27 kg
References					
Steel		NSYCU300H	NSYCU400	NSYCU600	NSYCU800
Stainless-steel		-	NSYCUX400	NSYCUX600	NSYCUX800
Steel UL		-	NSYCU400UL	NSYCU600UL	NSYCU800UL
Stainless-steel UL		-	-	NSYCUX600UL	NSYCUX800UL

* 50 °C at 60 Hz.

** Certification UL only 60 Hz.

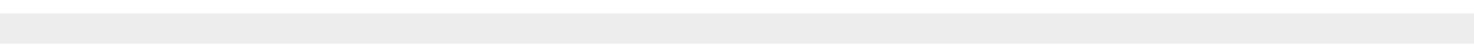
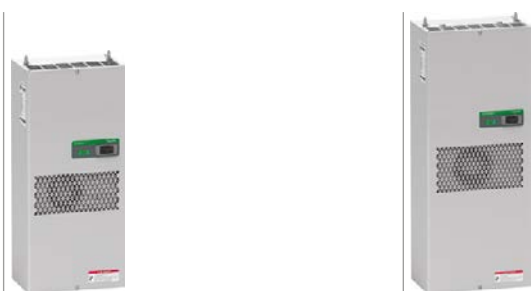

1000 W (3412 Btu/h)	1000 W (3412 Btu/h)	1250 W (4265 Btu/h)	1250 W (4265 Btu/h)	1600 W (5459 Btu/h)	1600 W (5459 Btu/h)	2000 W (6824 Btu/h)
790 W (2696 Btu/h)	790 W (2696 Btu/h)	910 W (3105 Btu/h)	910 W (3105 Btu/h)	1230 W (4197 Btu/h)	1230 W (4197 Btu/h)	1510 W (5152 Btu/h)
330 m³/h	330 m³/h	570 m³/h	570 m³/h	570 m³/h	570 m³/h	860 m³/h
570 m³/h	570 m³/h	860 m³/h	860 m³/h	1050 m³/h	1050 m³/h	1050 m³/h
Electronic	Electronic	Electronic	Electronic	Electronic	Electronic	Electronic
+20 ... +46 °C	+20 ... +46 °C	+20 ... +46 °C	+20 ... +46 °C	+20 ... +46 °C	+20 ... +46 °C	+20 ... +46 °C
+55 °C (+50 °C)*	+55 °C (+50 °C)*	+55 °C (+50 °C)*	+55 °C	+55 °C (+50 °C)*	+50 °C*	+55 °C (+50 °C)*
+5 ... +55 °C* (+5 ... +50 °C)*	+5 ... +50 °C (+5 ... +50 °C)*	+5 ... +55 °C* (+5 ... +50 °C)*	+5 ... +50 °C	+5 ... +55 °C* (+5 ... +50 °C)*	+5 ... +50 °C	+5 ... +55 °C* (+5 ... +50 °C)*
R134a	R134a	R134a	R134a	R134a	R134a	R134a
0.23 kg	0.23 kg	0.38 kg	0.38 kg	0.45 kg	0.45 kg	0.54 kg
25 bar (28 bar)**	25 bar (28 bar)**	25 bar (28 bar)**	25 bar	25 bar (28 bar)**	25 bar (28 bar)**	25 bar (28 bar)**
Optional, see page 691	Optional, see page 691	Optional, see page 691	Optional, see page 691	Optional, see page 691	Optional, see page 691	Optional, see page 691
1 x 230 V / 50-60 Hz**	2 x 400-440 V / 50- 60 Hz 2 x 400-460 V / 50- 60 Hz**	1 x 230 V / 50-60 Hz**	2 x 400-440 V / 50-60 Hz	1 x 230 V / 50-60 Hz**	2 x 400-440 V / 50- 60 Hz 2 x 460 V / 60 Hz**	1 x 230 V / 50-60 Hz**
10.5 A / 3 A	8 A / 2 A	11 A / 3.8 A	8.5 A / 2.8 A	18 A / 5.4 A	11 A / 2.9 A	24 A / 6.5 A
570 W	590 W	650 W	650 W	850 W	840 W	1080 W
650 W	670 W	760 W	770 W	970 W	960 W	1290 W
1.8	1.7	1.9	1.9	1.9	1.9	1.9
T6 A	T4 A	T6 A	T4 A	T10 A	T6 A	T10 A
783 x 348 x 215 mm	783 x 348 x 215 (+58) mm	999 x 405 x 237 mm	999 x 405 x 237 mm	999 x 405 x 237 mm	999 x 405 x 237 mm	999 x 405 x 237 mm
IP55 / IP34	IP55 / IP34	IP55 / IP34	IP55 / IP34	IP55 / IP34	IP55 / IP34	IP55 / IP34
65 dB	65 dB	65 dB	65 dB	65 dB	65 dB	65 dB
28 kg	29 kg	38 kg	40 kg	40 kg	42 kg	52 kg
NSYCU1K	NSYCU1K2P4	NSYCU1K2	NSYCU1K22P4	NSYCU1K6	NSYCU1K62P4	NSYCU2K
NSYCU1KUL	NSYCU1K2P4UL	NSYCU1K2UL	NSYCU1K22P4UL	NSYCU1K6UL	NSYCU1K62P4UL	NSYCU2KUL
NSYCU1KUL	NSYCU1K2P4UL	NSYCU1K2UL	-	NSYCU1K6UL	NSYCU1K62P4UL	NSYCU2KUL
NSYCU1KUL	NSYCU1K2P4UL	NSYCU1K2UL	-	NSYCU1K6UL	NSYCU1K62P4UL	NSYCU2KUL

Cooling units



Characteristics	Side-mounted models
	Alarm signal for door contact included in all models. Eyebolts included. The external filter, not included as standard, is strongly recommended for harsh environments.
Material	RAL 7035 grey painted zinc-coated steel or stainless-steel
Certifications and declarations	CE declaration UL (only references ending with UL) EAC
Installation	Indoor
Cooling characteristics	
Cooling power L35-L35 according to EN 14511	2000 W (6824 Btu/h)
Cooling power L35-L50 according to EN 14511	1510 W (5152 Btu/h)
Air flow of the internal circuit (enclosure)	860 m³/h
Air flow of the external circuit (ambient)	1050 m³/h
Thermostat type	Electronic
Temperature range of circuit (enclosure)	+20 ... +46 °C (+45 °C)*
Maximum outside temperature	+50 °C (+45 °C)
Temperature range of external circuit (ambient)	+5 ... +50 °C (+5 ... +45 °C)*
Type of cooling gas	R134a
Cooling gas weight	0.59 kg
Maximum pressure of cooling circuit	25 bar (28 bar)*
External filter	Optional, see page 691
Electric characteristics	
Input voltage	3 x 400 V / 50-60 Hz 3 x 460 V / 60 Hz*
Starting/rated current	10 A / 2.5 A
Power consumption L35-L35 according to EN 14511	970 W
Power consumption L35-L50 according to EN 14511	1150 W
Energy efficiency ratio (EER) L35-L35	2.1
Thermal protection recommended (fuse)	T6 A
Physical characteristics	
External dimensions (H x W x D)	999 x 405 x 237 mm
Protection degree IP internal /external according to IEC 60529	IP55 / IP34
Noise level	65 dB
Weight of unit	54 kg
References	
Steel	NSYCU2K3P4
Stainless-steel	NSYCUX2K3P4
Steel UL	NSYCU2K3P4UL
Stainless-steel UL	NSYCUX2K3P4UL

* Certification UL only 60 Hz..



Floor-standing models

2900 W (9895 Btu/h)	3850 W (13137 Btu/h)	5800 W (19790 Btu/h)
2250 W (7677 Btu/h)	2870 W (9793 Btu/h)	4350 W (14843 Btu/h)
1450 m ³ /h	1450 m ³ /h	1450 m ³ /h
1450 m ³ /h	1450 m ³ /h	2900 m ³ /h
Electronic	Electronic	Electronic
+20 ... +46 °C (+45 °C)*	+20 ... +46 °C (+45 °C)*	+20 ... +46 °C
+50 °C (+45 °C)	+50 °C (+45 °C)	+50 °C
+5 ... +50 °C (+5 ... +45 °C)*	+5 ... +50 °C (+5 ... +45 °C)*	+10 ... +50 °C
R134a	R134a	R407c
0.84 kg	1.14 kg	1.8 kg
25 bar (28 bar)*	25 bar (28 bar)*	27 bar
Optional, see page 691	Optional, see page 691	Polyurethane filter standard
3 x 400 V / 50-60 Hz 3 x 460 V / 60 Hz*	3 x 400 V / 50-60 Hz 3 x 460 V / 60 Hz*	3 x 400 V / 50 Hz
14 A / 2.6 A	18 A / 3.6 A	21.7 A / 5.9 A
1220 W	1780 W	2340 W
1440 W	2050 W	3880 W
2.4	2.2	2.5
T6 A	T8 A	T8 A
1270 x 500 x 336 mm	1270 x 500 x 336 mm	2000 x 600 x 380 mm
IP55 / IP34	IP55 / IP34	IP54 / IP34
70 dB	70 dB	72 dB
84 kg	85 kg	150 kg
NSYCU3K3P4	NSYCU4K3P4	NSYCU6K3P4
NSYCU3K3P4	NSYCU4K3P4	-
NSYCU3K3P4UL	NSYCU4K3P4UL	-
NSYCU3K3P4UL	NSYCU4K3P4UL	-

Cooling units



Characteristics		Roof-mounted models		
		<ul style="list-style-type: none"> • Environmentally friendly gas R134a (HFC). • Integrated water condensation exit system. • Alarm signal for door contact included in all models. • Eyebolts included. • The external filter, not included as standard, is strongly recommended for harsh environments. 		
Material		RAL 7035 grey painted zinc-coated steel or stainless-steel.		
Certifications and declarations		<ul style="list-style-type: none"> • CE declaration • UL (only references ending with UL) • EAC 		
Installation		Indoor		
Cooling characteristics				
Cooling power L35-L35 according to EN 14511		410 W (1399 Btu/h)	820 W (2798 Btu/h)	1150 W (3924 Btu/h)
Cooling power L35-L50 according to EN 14511		240 W (819 Btu/h)	680 W (2320 Btu/h)	900 W (3071 Btu/h)
Air flow of the internal circuit (enclosure)		235 m³/h	570 m³/h	570 m³/h
Air flow of the external circuit (ambient)		330 m³/h	860 m³/h	1010 m³/h
Thermostat type		Electronic	Electronic	Electronic
Temperature range of circuit (enclosure)		+20 ... +46 °C	+20 ... +46 °C	+20 ... +46 °C
Maximum outside temperature		+55 °C (+50 °C)*	+55 °C (+50 °C)*	+55 °C (+50 °C)*
Temperature range of external circuit (ambient)		+5 ... +55 °C* (+5 ... +50 °C)*	+5 ... +55 °C* (+5 ... +50 °C)*	+5 ... +55 °C* (+5 ... +50 °C)*
Type of cooling gas		R134a	R134a	R134a
Cooling gas weight		0.17 kg	0.31 kg	0.63 kg
Maximum pressure of cooling circuit		28 bar	25 bar (28 bar)**	25 bar (28 bar)**
External filter		Optional, see page 691	Optional, see page 691	Optional, see page 691
Electric characteristics				
Input voltage		1 x 230 V / 50-60 Hz**	1 x 230 V / 50-60 Hz**	1 x 230 V / 50-60 Hz**
Starting/rated current		4 A / 1.5 A	12 A / 2.9 A	11 A / 3.2 A
Power consumption L35-L35 according to EN 14511		230 W	510 W	550 W
Power consumption L35-L50 according to EN 14511		290 W	560 W	660 W
Energy efficiency ratio (EER) L35-L35		1.8	1.6	2.1
Thermal protection recommended (fuse)		T4 A	T6 A	T6 A
Physical characteristics				
External dimensions (H x W x D)		264 x 486 x 259 mm	340 x 600 x 340 mm	415 x 567 x 401 mm
Protection degree IP internal /external according to IEC 60529		IP54 / IP34	IP54 / IP34	IP54 / IP34
Noise level		65 dB	65 dB	65 dB
Weight of unit		18 kg	23 kg	40 kg
References				
Steel		NSYCU400R	NSYCU800R	NSYCU1K2R
Stainless-steel		NSYCUX400R	NSYCUX800R	NSYCUX1K2R
Steel UL		NSYCU400RUL	NSYCU800RUL	NSYCU1K2RUL

* 50 °C at 60 Hz.

** Certification UL only 60 Hz.

*** For cooling units greater than 65 kg we recommend to place universal cross-rails **NSYSUCR4060** or **NSYSUCR4080**.

Evaporation device for condensation water (external installation)

- Device allowing the evacuation of condensation water from the internal battery (evaporator).
- Supplied with stainless-steel support.
- Power supply:

Operating voltage ±10%

Voltage	Starting current	Thermal protection recommended	Evaporation capacity	Resistance type
230 V~	2.9 A	T 3 A	200 cl/h	PTC
115 V~	5.8 A	T 6 A	200 cl/h	PTC

Heat sink

NSYCUAD

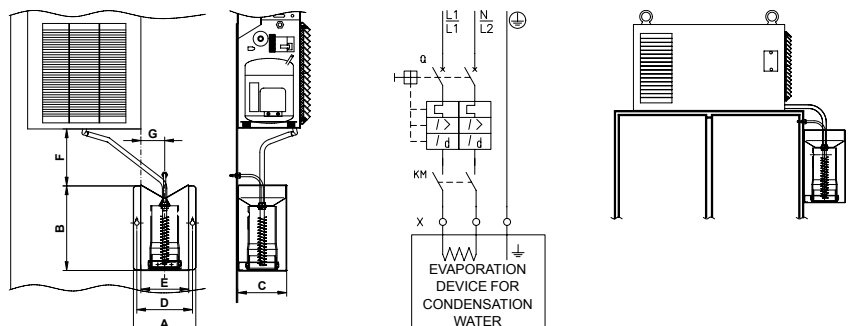

Technical changes reserved. Information provided without guarantee. Images are for illustrative purposes only.



1550 W (5289 Btu/h)	2050 W (6995 Btu/h)	2050 W (6995 Btu/h)	2900 W (9895 Btu/h)	3850 W (13137 Btu/h)
1200 W (4095 Btu/h)	1560 W (5323 Btu/h)	1560 W (5323 Btu/h)	2250 W (7677 Btu/h)	2870 W (9793 Btu/h)
860 m³/h	1050 m³/h	1050 m³/h	860 m³/h	1450 m³/h
1820 m³/h	1820 m³/h	1820 m³/h	3410 m³/h	3410 m³/h
Electronic	Electronic	Electronic	Electronic	Electronic
+20 ... +46 °C	+20 ... +46 °C	+20 ... +46 °C	+20 ... +46 °C	+20 ... +46 °C
+55 °C	+55 °C (+50 °C)**	+50 °C (+45 °C)**	+50 °C (+45 °C)**	+50 °C (+45 °C)**
+5 ... +55 °C* (+5 ... +50 °C)*	+5 ... +55 °C*	+5 ... +50 °C (+5 ... +45 °C)**	+5 ... +50 °C (+5 ... +45 °C)**	+5 ... +50 °C (+5 ... +45 °C)**
R134a	R134a	R134a	R134a	R134a
0.54 kg	0.55 kg	0.55 kg	1.20 kg	1.60 kg
25 bar (28 bar)**	25 bar	25 bar (28 bar)**	25 bar (28 bar)**	25 bar (28 bar)**
Optional, see page 691	Optional, see page 691	Optional, see page 691	Optional, see page 691	Optional, see page 691
1 x 230 V / 50-60 Hz**	1 x 230 V / 50-60 Hz	3 x 400 V / 50-60 Hz 3 x 460 V / 60 Hz*	3 x 400 V / 50-60 Hz 3 x 460 V / 60 Hz*	3 x 400 V / 50-60 Hz 3 x 460 V / 60 Hz*
18 A / 4.5 A	24 A / 6 A	10 A / 1.9 A	15.7 A / 2.5 A	17 A / 3.6 A
810 W	1150 W	990 W	1210 W	1790 W
930 W	1250 W	1190 W	1450 W	2010 W
1.9	1.8	2.1	2.4	2.2
T10 A	T10 A	T6 A	T6 A	T6 A
415 x 567 x 401 mm	415 x 567 x 401 mm	415 x 567 x 401 mm	496 x 797 x 492 mm	496 x 797 x 492 mm
IP54 / IP34	IP54 / IP34	IP54 / IP34	IP54 / IP34	IP54 / IP34
65 dB	65 dB	65 dB	75 dB	75 dB
44 kg	50 kg	52 kg	83 kg***	86 kg***
NSYCU1K5R	NSYCU2KR	NSYCU2K3P4R	NSYCU3K3P4R	NSYCU4K3P4R
NSYCUX1K5R	NSYCUX2KR	NSYCUX2K3P4R	NSYCUX3K3P4R	NSYCUX4K3P4R
NSYCU1K5RUL	-	NSYCU2K3P4RUL	NSYCU3K3P4RUL	NSYCU4K3P4RUL

Outdoor Heavy-Duty cooling units



Characteristics		Side-mounted models		
		<ul style="list-style-type: none"> • Environmentally friendly gas R134a (HFC). • Mechanical thermostats in all models. • Eyebolts included. • The external filter is not included as standard. The metal filter is strongly recommended. • Metal canopy as standard. • Anti-corrosive protection (class C3H). • Internal components, including the condenser, painted with anti-corrosive protection. 		
Material		RAL 7035 grey painted zinc-coated steel		
Certifications and declarations		<ul style="list-style-type: none"> • CE declaration • EAC 		
Installation		Indoor or outdoor		
Cooling characteristics				
Cooling power L35-L35 according to EN 14511		380 W (1297 Btu/h)	640 W (2184 Btu/h)	820 W (2798 Btu/h)
Cooling power L35-L50 according to EN 14511		240 W (819 Btu/h)	470 W (1604 Btu/h)	680 W (2320 Btu/h)
Air flow of the internal circuit (enclosure)		280 m³/h	330 m³/h	330 m³/h
Air flow of the external circuit (ambient)		280 m³/h	570 m³/h	570 m³/h
Thermostat type		Mechanic	Mechanic	Mechanic
Temperature range of circuit (enclosure)		+20 ... +50 °C	+20 ... +50 °C	+20 ... +50 °C
Maximum outside temperature		+55 °C	+55 °C	+55 °C
Temperature range of external circuit (ambient)		-20 ... +55 °C	-20 ... +55 °C	-20 ... +55 °C
Type of cooling gas		R134a	R134a	R134a
Cooling gas weight		0.16 kg	0.26 kg	0.28 kg
Maximum pressure of cooling circuit		26 bar	25 bar	25 bar
External filter		Optional, see metallic filter on page 691	Optional, see metallic filter on page 691	Optional, see metallic filter on page 691
Electric characteristics				
Input voltage		1 x 230 V / 50-60 Hz	1 x 230 V / 50-60 Hz	1 x 230 V / 50-60 Hz
Starting/rated current		6.0 A / 1.6 A	8.1 A / 2.1 A	10.8 A / 2.6 A
Power consumption L35-L35 according to EN 14511		280 W	400 W	440 W
Power consumption L35-L50 according to EN 14511		330 W	470 W	490 W
Energy efficiency ratio (EER) L35-L35		1.4	1.6	1.9
Thermal protection recommended (fuse)		T4 A	T6 A	T6 A
Physical characteristics				
External dimensions (H x W x D)		573 x 300 x 205 mm	718 x 331 x 235 mm	875 x 363 x 239 mm
Protection degree IP internal /external according to IEC 60529		IP55 / IP34	IP55 / IP34	IP55 / IP34
Noise level		60 dB	65 dB	65 dB
Weight of unit		17 kg	21 kg	27 kg
References		NSYCUHD400	NSYCUHD600	NSYCUHD800



1000 W (3412 Btu/h)	1000 W (3412 Btu/h)	1600 W (5459 Btu/h)	1600 W (5459 Btu/h)	2000 W (6824 Btu/h)	2900 W (9895 Btu/h)	3850 W (13137 Btu/h)
790 W (2696 Btu/h)	790 W (2696 Btu/h)	1230 W (4197 Btu/h)	1230 W (4197 Btu/h)	1510 W (5152 Btu/h)	2250 W (7677 Btu/h)	2870 W (9793 Btu/h)
330 m³/h	330 m³/h	570 m³/h	570 m³/h	860 m³/h	1450 m³/h	1450 m³/h
570 m³/h	570 m³/h	1050 m³/h	1050 m³/h	1050 m³/h	1450 m³/h	1450 m³/h
Mechanic	Mechanic	Mechanic	Mechanic	Mechanic	Mechanic	Mechanic
+20 ... +50 °C	+20 ... +50 °C	+20 ... +50 °C	+20 ... +50 °C	+20 ... +50 °C	+20 ... +50 °C	+20 ... +50 °C
+55 °C	+55 °C	+55 °C	+55 °C	+55 °C	+55 °C	+55 °C
-20 ... +55 °C	-20 ... +50 °C	-20 ... +55 °C	-20 ... +50 °C	-20 ... +55 °C	-20 ... +50 °C	-20 ... +50 °C
R134a	R134a	R134a	R134a	R134a	R134a	R134a
0.27 kg	0.27 kg	0.46 kg	0.46 kg	0.65 kg	0.84 kg	1.14 kg
25 bar	25 bar	25 bar	25 bar	25 bar	25 bar	25 bar
Optional, see metallic filter on page 691	Optional, see metallic filter on page 691	Optional, see metallic filter on page 691	Optional, see metallic filter on page 691	Optional, see metallic filter on page 691	Optional, see metallic filter on page 691	Optional, see metallic filter on page 691
1 x 230 V / 50-60 Hz	2 x 400-440 V / 50-60 Hz	1 x 230 V / 50-60 Hz	2 x 400-440 V / 50-60 Hz	3 x 400 V / 50-60 Hz	3 x 400 V / 50-60 Hz	3 x 400 V / 50-60 Hz
10.5 A / 3 A	8 A / 2 A	18 A / 5.3 A	11 A / 2.9 A	10 A / 2.5 A	14 A / 2.6 A	18 A / 3.6 A
570 W	590 W	820 W	840 W	970 W	1220 W	1780 W
650 W	670 W	940 W	960 W	1150 W	1440 W	2050 W
1.8	1.7	2.0	1.9	2.1	2.4	2.2
T6 A	T4 A	T10 A	T6 A	T6 A	T6 A	T8 A
895 x 363 x 239 mm	895 x 363 x 239 (+58) mm	1009 x 415 x 261 mm	1009 x 415 x 261 mm	1009 x 415 x 261 mm	1416 x 512 x 365 mm	1416 x 512 x 365 mm
IP55 / IP34	IP55 / IP34	IP55 / IP34	IP55 / IP34	IP55 / IP34	IP55 / IP34	IP55 / IP34
65 dB	65 dB	65 dB	65 dB	65 dB	70 dB	70 dB
28 kg	29 kg	40 kg	42 kg	54 kg	84 kg	85 kg
NSYCUHD1K	NSYCUHD1K2P4	NSYCUHD1K6	NSYCUHD1K62P4	NSYCUHD2K3P4	NSYCUHD3K3P4	NSYCUHD4K3P4

Slim cooling units



Characteristics		Side-mounted models			
		<ul style="list-style-type: none"> • Environmentally friendly gas R134a (HFC). • Electronical thermostat included. • 3 mounting positions (surface, half-flush and flush). • Alarm signal for door contact. • Eyebolts included. 			
Material		RAL 7035 grey painted zinc-coated steel or stainless-steel			
Certifications and declarations		<ul style="list-style-type: none"> • CE declaration • UL • EAC 			
Installation		<ul style="list-style-type: none"> • Indoor • There is one unique cut-out for all mounting positions and all slim models 			
Cooling characteristics					
Cooling power L35-L35 according to EN 14511	1100 W (3753 Btu/h)	1100 W (3753 Btu/h)	1500 W (5118 Btu/h)	1500 W (5118 Btu/h)	
Cooling power L35-L50 according to EN 14511	860 W (2934 Btu/h)	860 W (2934 Btu/h)	1150 W (3924 Btu/h)	1150 W (3924 Btu/h)	
Air flow of the internal circuit (enclosure)	860 m³/h	860 m³/h	860 m³/h	860 m³/h	
Air flow of the external circuit (ambient)	860 m³/h	860 m³/h	860 m³/h	860 m³/h	
Thermostat type	Electronic	Electronic	Electronic	Electronic	
Temperature range of circuit (enclosure)	+20 ... +46 °C	+20 ... +46 °C	+20 ... +46 °C	+20 ... +46 °C	
Maximum outside temperature	+50 °C	+50 °C	+50 °C	+50 °C	
Temperature range of external circuit (ambient)	+5 ... +50 °C	+5 ... +50 °C	+5 ... +50 °C	+5 ... +50 °C	
Type of cooling gas	R134a	R134a	R134a	R134a	
Cooling gas weight	0.5 kg	0.5 kg	0.46 kg	0.46 kg	
Maximum pressure of cooling circuit	28 bar	28 bar	28 bar	28 bar	
External circuit filter	Optional, see page 691	Optional, see page 691	Optional, see page 691	Optional, see page 691	
Electric characteristics					
Input voltage	1 x 230 V / 50-60 Hz*	2 x 400-460 V / 50-60 Hz*	1 x 230 V / 50-60 Hz*	2 x 400-460 V / 50-60 Hz*	
Starting/rated current	11 A / 4.8 A	8.5 A / 2.7 A	18 A / 5.7 A	11 A / 3.2 A	
Power consumption L35-L35 according to EN 14511	660 W	660 W	840 W	840 W	
Power consumption L35-L50 according to EN 14511	790 W	790 W	970 W	970 W	
Energy efficiency ratio (EER) L35-L35	1.7	1.7	1.8	1.8	
Thermal protection recommended (fuse)	T6 A	T4 A	T10 A	T6 A	
Physical characteristics					
External dimensions (H x W x D)	1696 x 495 x 195 mm	1696 x 495 x 195 mm	1696 x 495 x 195 mm	1696 x 495 x 195 mm	
Protection degree IP internal /external according to IEC 60529	IP55 / IP34	IP55 / IP34	IP55 / IP34	IP55 / IP34	
Noise level	64 dB	64 dB	66 dB	66 dB	
Weight of unit	50 kg	52 kg	55 kg	57 kg	
References					
Steel UL	NSYCUS1K1UL	NSYCUS1K12P4UL	NSYCUS1K5UL	NSYCUS1K52P4UL	
Stainless-steel UL	NSYCUSX1K1UL	NSYCUSX1K12P4UL	NSYCUSX1K5UL	NSYCUSX1K52P4UL	





* Certification UL only 60 Hz.



	2000 W (6824 Btu/h)	2000 W (6824 Btu/h)	2500 W (8530 Btu/h)	2500 W (8530 Btu/h)	3200 W (10919 Btu/h)	3200 W (10919 Btu/h)
	1550 W (5289 Btu/h)	1550 W (5289 Btu/h)	1850 W (6312 Btu/h)	1850 W (6312 Btu/h)	2500 W (8530 Btu/h)	2500 W (8530 Btu/h)
	860 m³/h	860 m³/h	1450 m³/h	1450 m³/h	1450 m³/h	1450 m³/h
	1050 m³/h	1050 m³/h	1450 m³/h	1450 m³/h	1450 m³/h	1450 m³/h
	Electronic	Electronic	Electronic	Electronic	Electronic	Electronic
	+20 ... +46 °C	+20 ... +46 °C	+20 ... +46 °C	+20 ... +46 °C	+20 ... +46 °C	+20 ... +46 °C
	+50 °C	+50 °C	+50 °C	+50 °C	+50 °C	+50 °C
	+5 ... +50 °C	+5 ... +50 °C	+5 ... +50 °C	+5 ... +50 °C	+5 ... +50 °C	+5 ... +50 °C
	R134a	R134a	R134a	R134a	R134a	R134a
	0.51 kg	0.59 kg	1.2 kg	1.2 kg	0.85 kg	1.25 kg
	28 bar	28 bar	28 bar	28 bar	28 bar	28 bar
	Optional, see page 691	Optional, see page 691	Optional, see page 691	Optional, see page 691	Optional, see page 691	Optional, see page 691
	1 x 230 V / 60 Hz	3 x 400 V / 50-60 Hz (3 x 460 V / 60 Hz)*	1 x 230 V / 60 Hz	3 x 400 V / 50-60 Hz (3 x 460 V / 60 Hz)*	1 x 230 V / 60 Hz	3 x 400 V / 50-60 Hz (3 x 460 V / 60 Hz)*
	24 A / 6.5 A	10 A / 2.1 A	35 A / 10.5 A	14 A / 2.9 A	37 A / 10.5 A	18 A / 3.1 A
	1020 W	1060 W	1340 W	1270 W	1720 W	1650 W
	1160 W	1270 W	1580 W	1510 W	2000 W	1980 W
	2.0	1.9	1.9	2.0	1.9	1.9
	T10 A	T6 A	T16 A	T6 A	T16 A	T6 A
	1696 x 495 x 195 mm	1696 x 495 x 195 mm	1696 x 495 x 235 mm	1696 x 495 x 235 mm	1696 x 495 x 235 mm	1696 x 495 x 235 mm
	IP55 / IP34	IP55 / IP34	IP55 / IP34	IP55 / IP34	IP55 / IP34	IP55 / IP34
	67 dB	67 dB	69 dB	69 dB	69 dB	69 dB
	63 kg	65 kg	80 kg	82 kg	81 kg	83 kg
	NSYCUS2KUL	NSYCUS2K3P4UL	NSYCUS2K5UL	NSYCUS2K53P4UL	NSYCUS3K2UL	NSYCUS3K23P4UL

Accessories

Characteristics	Cooling units IEC			Cooling units UL	
	Steel	Stainless-steel	Outdoor	Steel	Stainless-steel
Material					
Color					
Installation					
Supply					
References					
Cooling units					
Side-mounted models	NSYCU300H	-	-	-	-
	NSYCU400	NSYCUX400	NSYCUHD400	NSYCU400UL	-
	NSYCU600	NSYCUX600	NSYCUHD600	NSYCU600UL	NSYCUX600UL
	NSYCU800	NSYCUX800	NSYCUHD800	NSYCU800UL	NSYCUX800UL
	NSYCU1K	NSYCUX1K	NSYCUHD1K	NSYCU1KUL	NSYCUX1KUL
	NSYCU1K2P4	NSYCUX1K2P4	NSYCUHD1K2P4	NSYCU1K2P4UL	NSYCUX1K2P4UL
	NSYCU1K2	NSYCUX1K2	-	NSYCU1K2UL	NSYCUX1K2UL
	NSYCU1K22P4	NSYCUX1K22P4	-	-	-
	NSYCU1K6	NSYCUX1K6	NSYCUHD1K6	NSYCU1K6UL	NSYCUX1K6UL
	NSYCU1K62P4	NSYCUX1K62P4	NSYCUHD1K62P4	NSYCU1K62P4UL	NSYCUX1K62P4UL
	NSYCU2K	NSYCUX2K	-	NSYCU2KUL	NSYCUX2KUL
	NSYCU2K3P4	NSYCUX2K3P4	NSYCUHD2K3P4	NSYCU2K3P4UL	NSYCUX2K3P4UL
	NSYCU3K3P4	NSYCUX3K3P4	NSYCUHD3K3P4	NSYCU3K3P4UL	NSYCUX3K3P4UL
	NSYCU4K3P4	NSYCUX4K3P4	NSYCUHD4K3P4	NSYCU4K3P4UL	NSYCUX4K3P4UL
Floor-standing models	NSYCU6K3P4	-	-	-	-
Roof-mounted models	NSYCU400R	NSYCUX400R	-	NSYCU400RUL	-
	NSYCU800R	NSYCUX800R	-	NSYCU800RUL	-
	NSYCU1K2R	NSYCUX1K2R	-	NSYCU1K2RUL	-
	NSYCU1K5R	NSYCUX1K5R	-	NSYCU1K5RUL	-
	NSYCU2K3P4R	NSYCUX2K3P4R	-	NSYCU2K3P4RUL	-
	NSYCU2KR	NSYCUX2KR	-	-	-
	NSYCU3K3P4R	NSYCUX3K3P4R	-	NSYCU3K3P4RUL	-
	NSYCU4K3P4R	NSYCUX4K3P4R	-	NSYCU4K3P4RUL	-
Slim model	-	-	-	NSYCUS1K1UL	NSYCUSX1K1UL
	-	-	-	NSYCUS1K12P4UL	NSYCUSX1K12P4UL
	-	-	-	NSYCUS1K5UL	NSYCUSX1K5UL
	-	-	-	NSYCUS1K52P4UL	NSYCUSX1K52P4UL
	-	-	-	NSYCUS2KUL	NSYCUSX2KUL
	-	-	-	NSYCUS2K3P4UL	NSYCUSX2K3P4UL
	-	-	-	NSYCUS2K5UL	NSYCUSX2K5UL
	-	-	-	NSYCUS2K53P4UL	NSYCUSX2K53P4UL
	-	-	-	NSYCUS3K2UL	NSYCUSX3K2UL
	-	-	-	NSYCUS3K23P4UL	NSYCUSX3K23P4UL

							
Filters		Internal deflector		Retrofit panel			
Plastic filter not recommended for outdoor models.		Metalic filter recommended for outdoor models.		Deflects the air inside the enclosure.		Panel used to fit new ClimaSys CU units when replacing old Schneider Electric cooling systems.	
Polyurethane		Micro-stretched aluminum		Zinc-coated		Metal painted	
Black		-		RAL 7035 grey		RAL 7035 grey	
Indoor		Indoor or outdoor		Indoor or outdoor		Indoor	
5 units		1 unit		1 unit with fixing elements		1 unit	
						Old Schneider Electric cooling system	
-	-	-	-	-	-	-	
NSYCUF400	NSYCUFX400	NSYCUDA400	NSYCU240W230VL	NSYCU370W230VL			
NSYCUF600	NSYCUFX600	NSYCUDA600	-				
NSYCUF800T1K	NSYCUFX800T1K	NSYCUDA800T1K	NSYCU760W230VL				
NSYCUF800T1K	NSYCUFX800T1K	NSYCUDA800T1K	NSYCUE1100W230L				
NSYCUF800T1K	NSYCUFX800T1K	NSYCUDA1K2T2K	NSYCU1K				
NSYCUF1K2T2K	NSYCUFX1K2T2K	NSYCUDA1K2T2K	-				
NSYCUF1K2T2K	NSYCUFX1K2T2K	NSYCUDA1K2T2K	-				
NSYCUF1K2T2K	NSYCUFX1K2T2K	NSYCUDA1K2T2K	NSYCUE1400W230L				
NSYCUF1K2T2K	NSYCUFX1K2T2K	NSYCUDA1K2T2K	NSYCU1650W230VL				
NSYCUF1K2T2K	NSYCUFX1K2T2K	NSYCUDA1K2T2K	NSYCUE1400W400L				
NSYCUF1K2T2K	NSYCUFX1K2T2K	NSYCUDA1K2T2K	-				
NSYCUF1K2T2K	NSYCUFX1K2T2K	NSYCUDA1K2T2K	NSYCU1800W400VL				
NSYCUF3KT4K	NSYCUFX3KT4K	NSYCUDA3KT4K	NSYCUE1800W400L				
NSYCUF3KT4K	NSYCUFX3KT4K	NSYCUDA3KT4K	NSYCU2500W400VL				
NSYCUF6K	NSYCUFX6K	-	NSYCU4000W400VL				
NSYCUF400R	NSYCUFX400R	-	-				
NSYCUF800R	NSYCUFX800R	-	NSYCU760W230VR				
NSYCUF1K2T2KR	NSYCUFX1K2T2KR	-	NSYCU1050W230VR				
NSYCUF1K2T2KR	NSYCUFX1K2T2KR	-	NSYCUE1400W230R				
NSYCUF1K2T2KR	NSYCUFX1K2T2KR	-	NSYCU1460W230VR				
NSYCUF1K2T2KR	NSYCUFX1K2T2KR	-	NSYCU1650W230VR				
NSYCUF1K2T2KR	NSYCUFX1K2T2KR	-	NSYCUE1800W400R				
NSYCUF1K2T2KR	NSYCUFX1K2T2KR	-	NSYCU2000W400VR				
NSYCUF3KT4KR	NSYCUFX3KT4KR	-	NSYCU2450W400VR				
NSYCUF1K1T2KS	NSYCUFX1K1T2KS	-	NSYCU3100W400VR				
NSYCUF1K1T2KS	NSYCUFX1K1T2KS	NSYCUDA1K1T1K5	-				
NSYCUF1K1T2KS	NSYCUFX1K1T2KS	NSYCUDA1K1T1K5	NSYCUB1100W230S				
NSYCUF1K1T2KS	NSYCUFX1K1T2KS	NSYCUDA1K1T1K5	NSYCUB1100W400S				
NSYCUF1K1T2KS	NSYCUFX1K1T2KS	NSYCUDA1K1T1K5	NSYCUB1500W230S				
NSYCUF1K1T2KS	NSYCUFX1K1T2KS	NSYCUDA1K1T1K5	NSYCUB1500W400S				
NSYCUF1K1T2KS	NSYCUFX1K1T2KS	NSYCUDA1K1T1K5	NSYCUB2200W230S				
NSYCUF1K1T2KS	NSYCUFX1K1T2KS	NSYCUDA1K1T1K5	NSYCUB2200W400S				
NSYCUF1K1T2KS	NSYCUFX1K1T2KS	NSYCUDA1K1T1K5	NSYCUB2700W230S				
NSYCUF1K1T2KS	NSYCUFX1K1T2KS	NSYCUDA1K1T1K5	NSYCUB2700W400S				
NSYCUF1K1T2KS	NSYCUFX1K1T2KS	NSYCUDA1K1T1K5	NSYCUB2700W230S				
NSYCUF1K1T2KS	NSYCUFX1K1T2KS	NSYCUDA1K1T1K5	NSYCUB2700W400S				

Side-mounted models: Dimensions and cut-outs

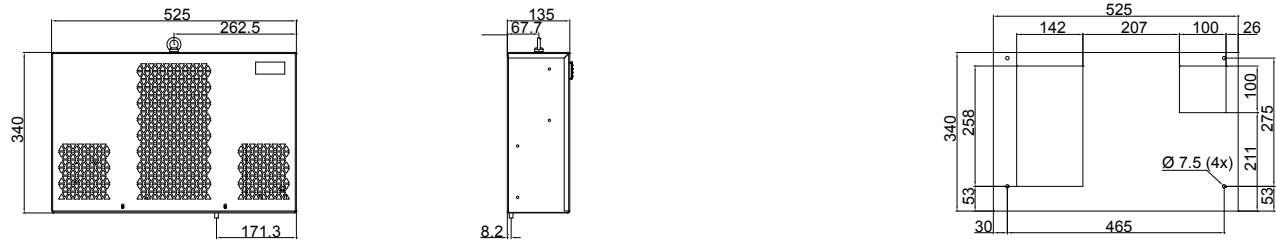

NSYCU300H

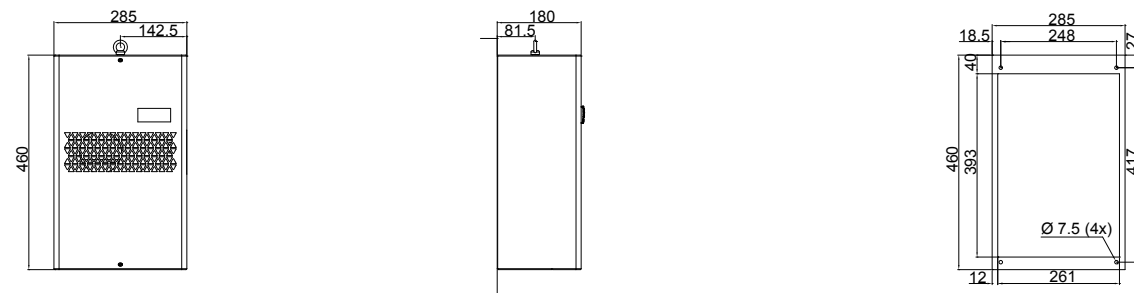

NSYCU●●400●●

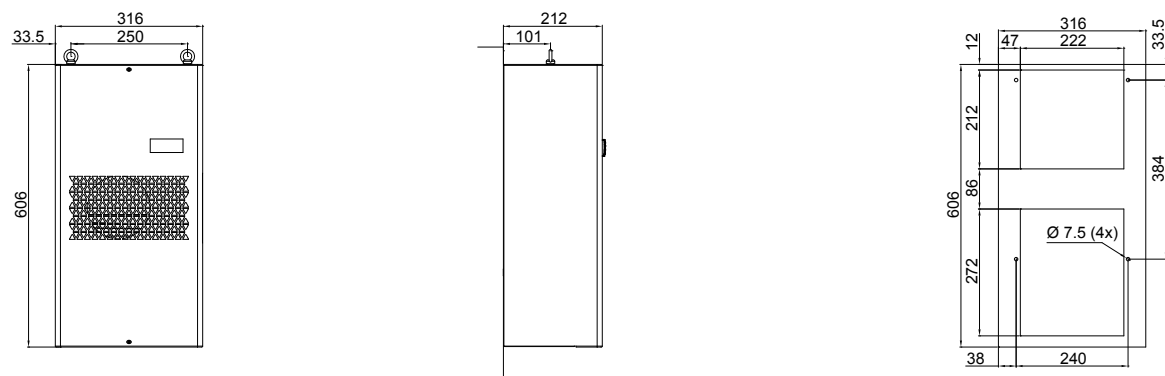

NSYCU●●600●●

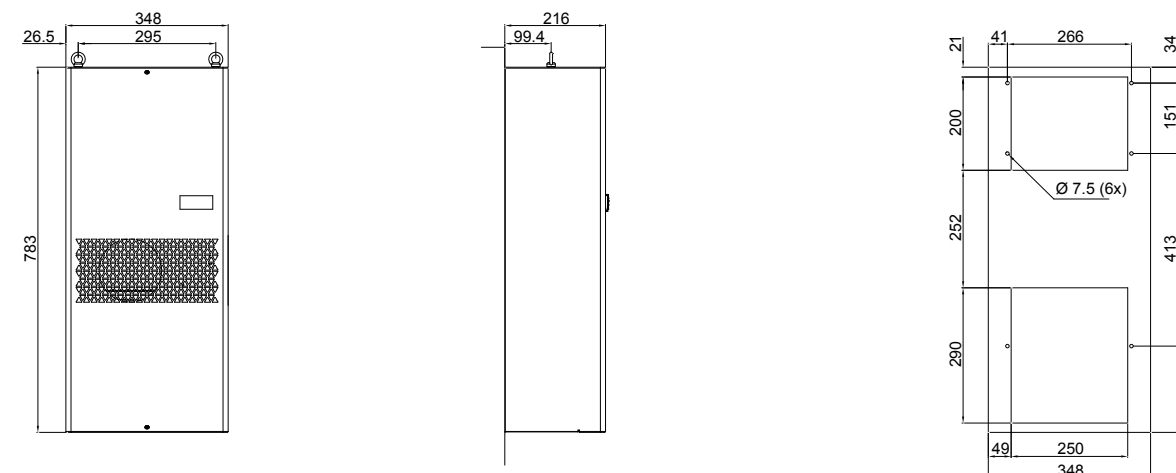

NSYCU●●800●● - NSYCU●●1K●●

Units of measurement are mm

Technical changes reserved. Information provided without guarantee. Images are for illustrative purposes only.

Side-mounted models: Dimensions and cut-outs

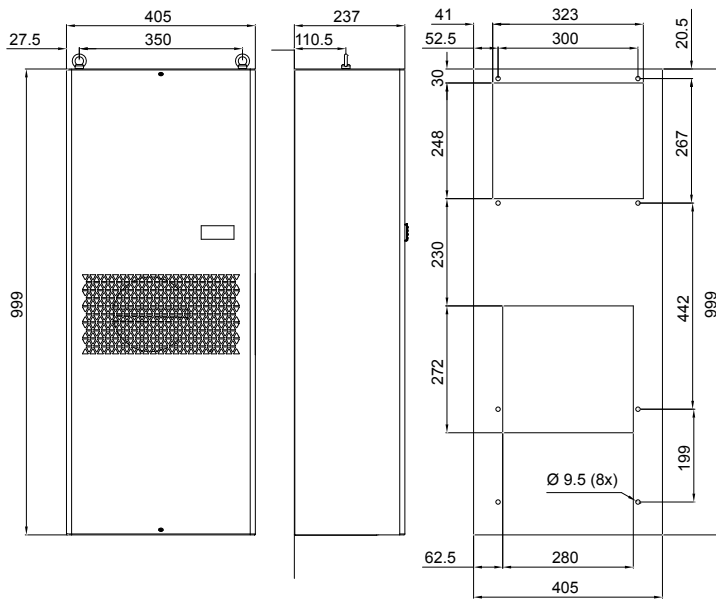

NSYCU●●1K2●● - NSYCU●●1K6●● - NSYCU●●2K●●

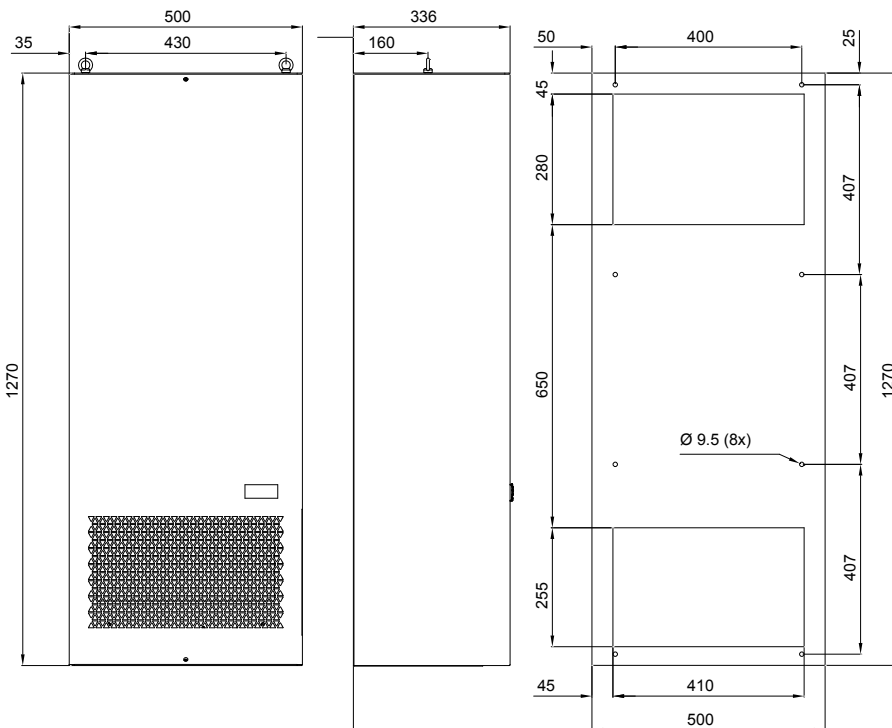

NSYCU●●3K3P4●● - NSYCU●●4K3P4●●

Units of measurement are mm

Top-mounted models: Dimensions and cut-outs

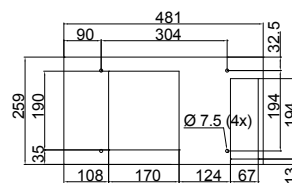
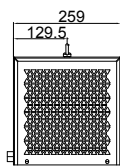
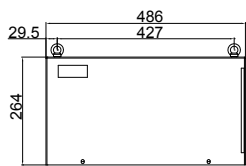

NSYCU400R

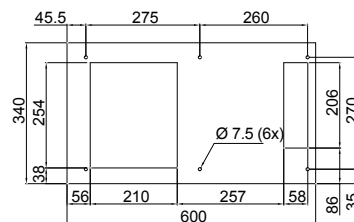
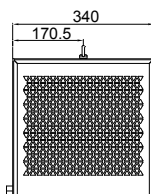
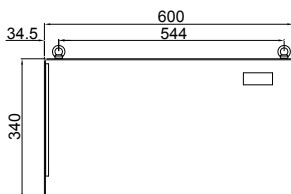

NSYCU800R

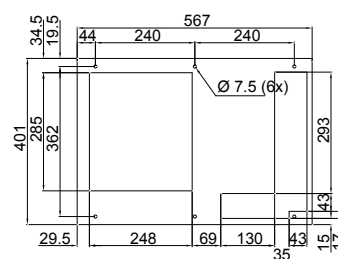
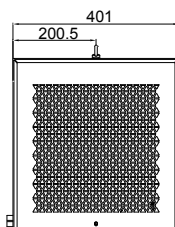
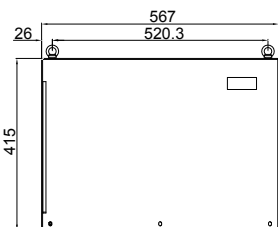

NSYCU1K2R - NSYCU1K5R - NSYCU2K

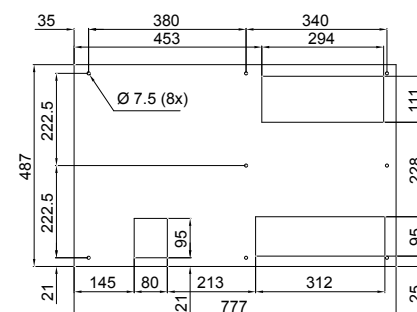
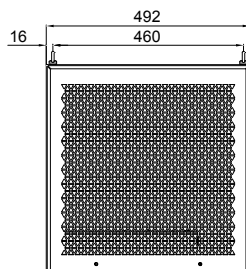
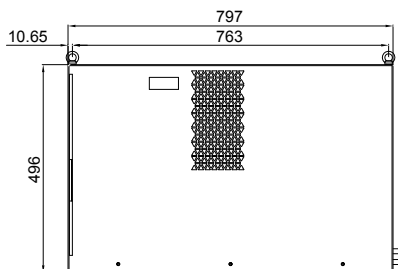

NSYCU3K3P4R - NSYCU4K3P4R

Units of measurement are mm

Top-mounted models: Dimensions and cut-outs

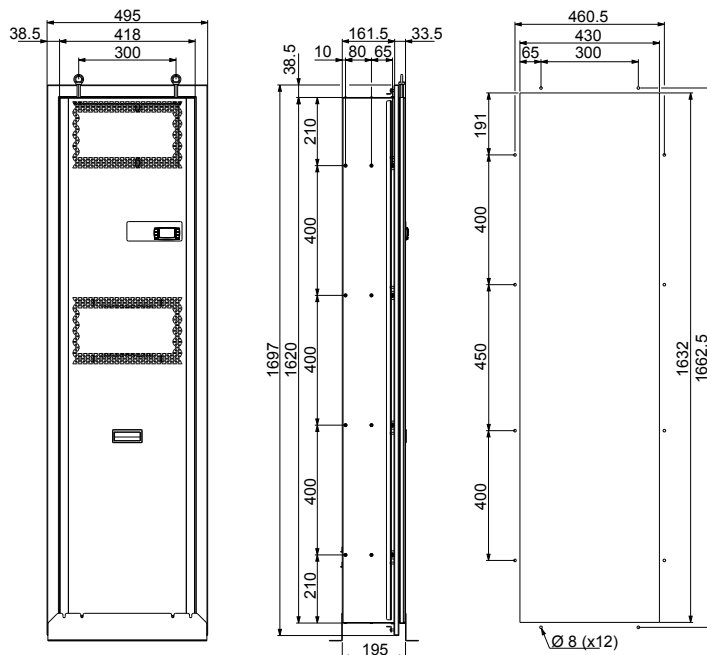

NSYCUS●1K1● - NSYCUS●1K5● - NSYCUS●2K●

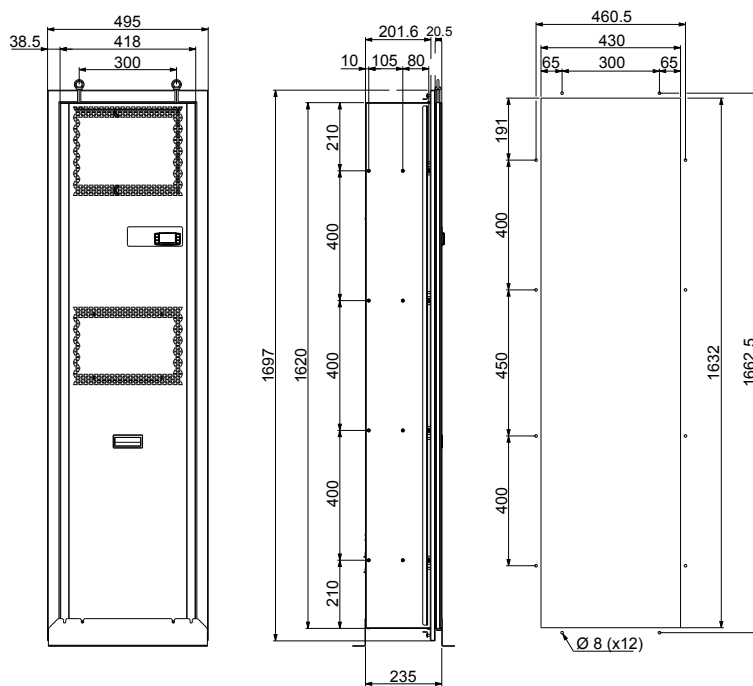

NSYCUS2K5UL

Units of measurement are mm

Ultra-thin resistance heaters have been designed to resolve condensation problems in the most complex installations.

Is your enclosure short of space?

Does your mounting plate make it impossible to install a conventional heater?

Do you not want to take out the equipment?

Discover the benefits of this new offer and its numerous mounting solutions.

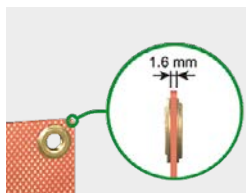

Small size (thickness = 1.6 mm)

- The space saving available for the equipment compared with a conventional resistor can be up to 30%.



Numerous positions for installation

- These heaters are so slim and flexible they can be installed in a variety of positions:
- Vertically on side panels
- On the mounting plate.



Heat and safety

- The heat is distributed over the whole surface and does not exceed 70 °C. This temperature allows devices next to the heater to be handled safely.



Energy efficiency

- Ultra-thin resistance heaters have a low starting current.



Multiple options for fixing

- Innovative quick-fixing system using Velcro pads (no need for a tool!) or with basic fixing accessories (screw + spacer). These systems make it easy to move the heater if necessary.



No electromagnetic emissions

- These resistors can be installed near electronic equipment to ensure an optimal temperature.

Other characteristics - Electrical circuit diagram

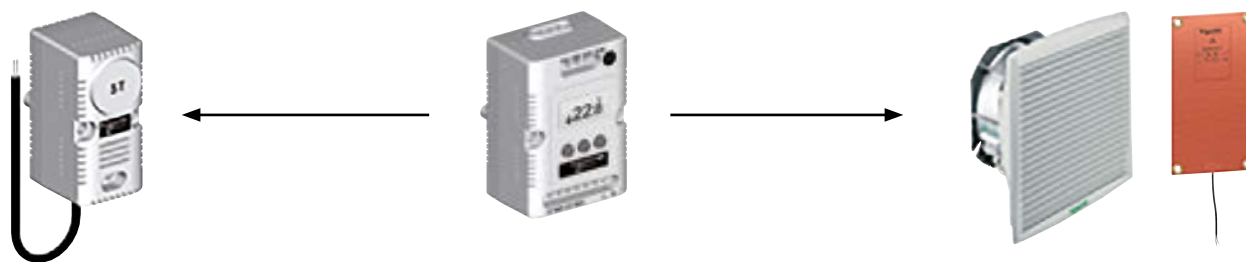

5 mounting solutions:	On a Telequick mounting plate	On plain or micro-perforated mounting plate with fixing hardware	On DIN rail	On plain mounting plate with self-adhesive Velcro pads	On wall with self-adhesive Velcro pads
	<p>A Telequick mounting plate, ref. NSYMR●●●● B Telequick nuts, ref. AF1EA●, supplied with the mounting kit</p>	<p>A Mounting plate, ref. NSYMM●●●● B Fixing hardware included in the mounting kit</p>	<p>A Mounting plate, ref. NSYMM●●●● B Symmetrical DIN rail, ref. NSYSDR●●●● C Clip-on nuts, ref. AF1CG●, supplied with the mounting kit</p>	<p>A Mounting plate, ref. NSYMM●●●● B Self-adhesive Velcro pad and plastic fixings supplied with the mounting kit</p>	<p>A Self-adhesive Velcro pads and plastic fixings supplied in the mounting kit</p>
Characteristics	Flexible, ultra-thin resistance heaters to be installed inside the enclosure				
Material	Silicon reinforced with fiberglass				
Color	Red (heaters), black (cables)				
Certification	UL				
Supply	<ul style="list-style-type: none"> • 6 self-adhesive Velcro pads • 6 plastic fixings • 4 Telequick nuts • 4 clip-on nuts • Fixing hardware 				

Ultra-thin resistance heaters

Flexible, ultra-thin resistance heaters to be installed inside the enclosure

- Material: Silicon reinforced with fiberglass
- Color: Red (heaters), black (cables)
- Certification: UL (cURus)

Comment:

Ultra-thin resistance heaters can be manufactured with other dimensions and power ratings than those indicated above. Please contact us.



NSYCRS10W240V

Characteristics	Power (W)	Voltage (V)	Inrush current (A)	Height (mm)	Width (mm)	Depth (mm)	References
Ultra-thin resistance heaters	10	240	0.04	110	140	1.6	NSYCRS10W240V
Ultra-thin resistance heaters	25	240	0.10	110	230	1.6	NSYCRS25W240V
Ultra-thin resistance heaters	50	240	0.21	200	320	1.6	NSYCRS50W240V
Ultra-thin resistance heaters	100	240	0.42	260	440	1.6	NSYCRS100W240V
Ultra-thin resistance heaters	200	240	0.83	380	650	1.6	NSYCRS200W240V

Resistance heaters prevent the formation of condensation and help guarantee the correct temperature for the correct operation of the electronic components in the enclosure.

Insulated PTC heaters

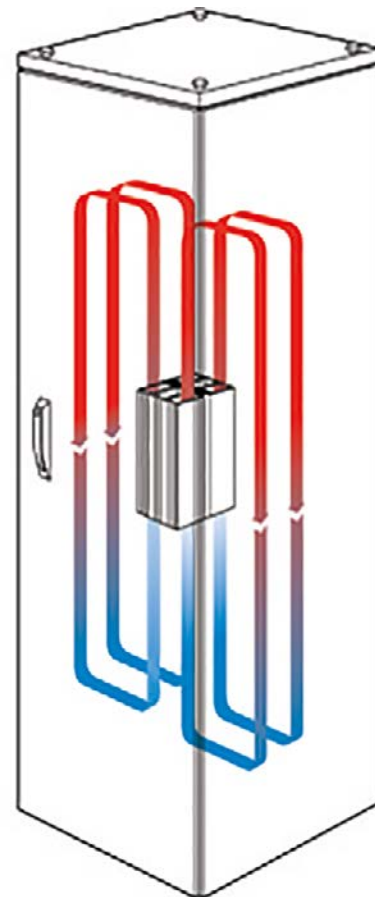

Large range of power levels

- 2 versions: By natural convection or by fan.
- AC or DC power supply.
- 7 power levels from 10 W to 550 W.



Easy installation and connection

- Reduced dimensions.
- Quick electric connection by terminal board.
- No maintenance required.
- Direct clipping onto a 35-mm DIN rail.



Innovating design



Safety

- The protection prevents direct contact with the aluminum radiator.
- Electric protection device with terminal block cover.
- Equipped with a PTC-type heater.
- Surface temperature lower than 70 °C.



Models with fan

- The heaters equipped with a fan helps to ensure circulation of the air and a uniform temperature inside the enclosure.
- High-flow, silent fan.

High thermal efficiency

- The configuration of the aluminum profile produces a "chimney" effect: high natural convection.
- Low power consumption thanks to self-control of the PTC-type heater.



Certifications

- CE marking.
- Range compliant with UL and VDE, UL (*only the marked references)

Aluminum PTC heaters

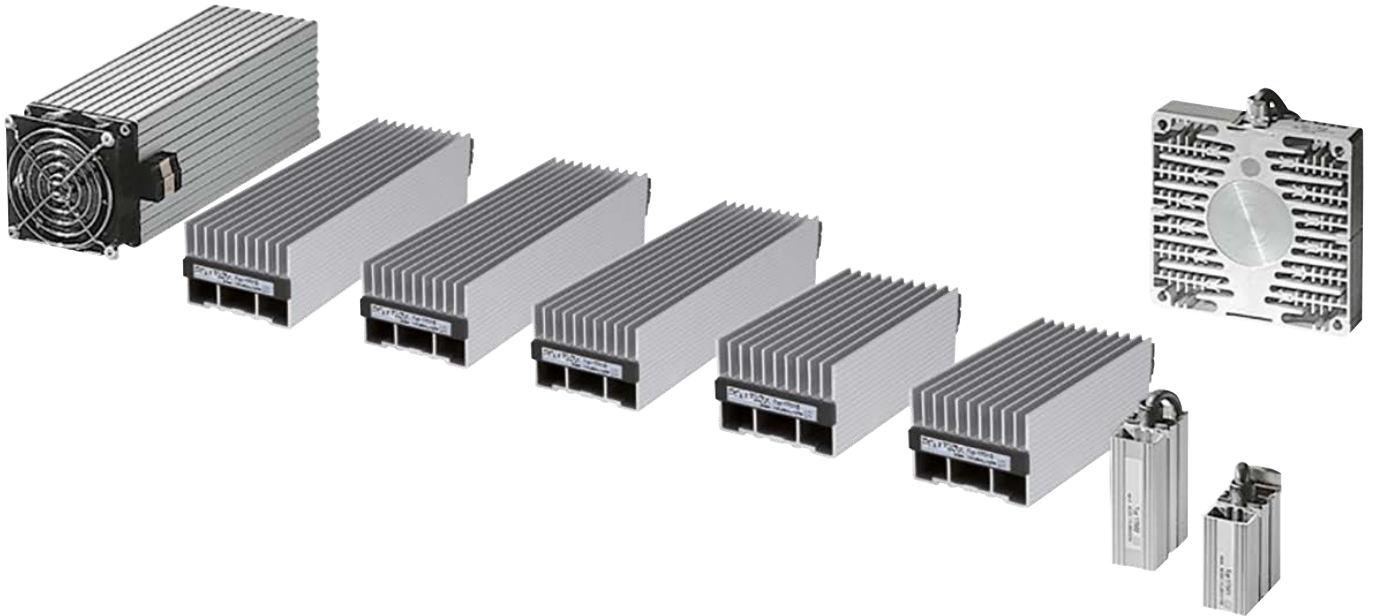

Models with fan

- Models of 250 to 400 W with fan.



Connection cables

- The 10 and 20-W heaters are equipped with a 2 x 0.75 x 300 mm power cord.

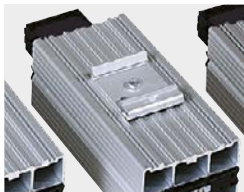

Quick-fixing

- The resistance heaters are fixed by means of fixing clips to a 35-mm DIN rail.



Connection terminal boards

- Heaters with a power of more than 20 W are equipped with a connection terminal board.

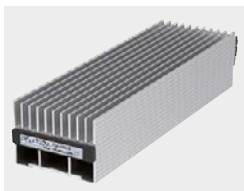

Resistance heaters equipped with a PTC-type sensor

The resistance heaters for electrical and electronic enclosures are equipped with PTC-type heating devices (Positive Temperature Coefficient). Thanks to these heaters:

- The surface temperature stabilises at 75 °C when the ambient temperature is -5 °C.
- Power consumption is reduced.

Improved convection

- The design of the profile of the resistance heaters produces a "chimney" effect, leading to increased natural convection and maintaining an even temperature inside the enclosure.

Large range of power levels

- 8 power levels from 10 W to 400 W.

Insulated PTC resistance heaters



NSYCR10WU2C



NSYCR50WU2C

- Compact resistance heater preventing the formation of condensation or frost.
- Designed to ensure natural convection and high thermal efficiency.
- Material: Extruded aluminum body
- Conditions of use: The heaters must be installed with a thermal controller (see selection table on [page 702](#) and [703](#)) to control the temperature or the humidity inside the enclosure
- The enclosure must be sealed to prevent the entry of air from the outside
- An electrical protection device must be installed on the supply side of the unit
- Operating position: Vertical
- Operating temperature: -40...+70 °C; -10...+158 °F
- Surface temperature: <70 °C, except for the top protection grille
- Ingress protection rating: IP20
- Certifications: UL (cURus) only the reference marked with (*), Class II (double insulated)
- Mounting: By clip on a 35-mm DIN rail

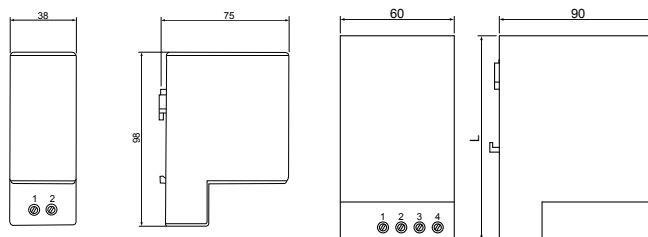

Characteristics	Heating power at 0 °C (W)	Voltage (V)	Electric connection	References
Insulated PTC resistance heater	10	12-24 DC	2 screw terminals, 2.5 mm ²	NSYCR10WU1C *
Insulated PTC resistance heater	10	110-250 AC	2 screw terminals, 2.5 mm ²	NSYCR10WU2C
Insulated PTC resistance heater	20	12-24 DC	2 screw terminals, 2.5 mm ²	NSYCR20WU1C
Insulated PTC resistance heater	20	110-250 AC	2 screw terminals, 2.5 mm ²	NSYCR20WU2C *
Insulated PTC resistance heater	55	12-24 DC	4 screw terminals, 2.5 mm ²	NSYCR50WU1C
Insulated PTC resistance heater	55	110-250 AC	4 screw terminals, 2.5 mm ²	NSYCR50WU2C *
Insulated PTC resistance heater	55	270-420 AC	4 screw terminals, 2.5 mm ²	NSYCR50WU3C
Insulated PTC resistance heater	100	12-24 DC	4 screw terminals, 2.5 mm ²	NSYCR100WU1C
Insulated PTC resistance heater	100	110-250 AC	4 screw terminals, 2.5 mm ²	NSYCR100WU2C *
Insulated PTC resistance heater	100	270-420 AC	4 screw terminals, 2.5 mm ²	NSYCR100WU3C
Insulated PTC resistance heater	147	12-24 DC	4 screw terminals, 2.5 mm ²	NSYCR150WU1C
Insulated PTC resistance heater	147	110-250 AC	4 screw terminals, 2.5 mm ²	NSYCR150WU2C *

Insulated ventilated PTC heaters

- Compact resistance heater preventing the formation of condensation or frost.
- Designed to ensure good natural convection and high thermal efficiency.
- Material: Extruded aluminum body
- Conditions of use: The heaters must be installed with a thermal controller (see selection table on [page 702](#) and [703](#)) to control the temperature or the humidity inside the enclosure
- The enclosure must be sealed to prevent the entry of air from the outside
- An electrical protection device must be installed on the supply side of the unit
- Operating position: Vertical
- Operating temperature: -40...+70 °C; -10...+158 °F
- Surface temperature: Max. 50 °C in the enclosure, 100 °C on the top protection grille, (for an ambient temperature of 20 °C / 68 °F)
- Ingress protection rating: IP20
- Certifications: VDE and UL, Cover: UL 94 V-0 plastic, Class II (double insulated)
- Mounting: By clip on a 35-mm DIN rail

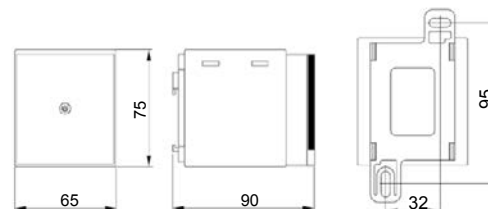

Characteristics	Heating power at 0 °C (W)	Voltage (V)	Electric connection	References
Insulated ventilated PTC heater	177	230 AC / 50-60 HZ	2 poles, 2.5 mm ²	NSYCR170W230VVC



NSYCR170W230VVC

Aluminum PTC heaters

- Extruded aluminum body.
- Surface temperature limited to 75 °C when the ambient temperature is -5 °C.
- Heaters equipped with a power cable with a length of 500 mm with silicon insulation, or with a connection terminal block.

Conditions of use:

- The heaters must be installed with a thermal controller to control the temperature or the humidity inside the enclosure
- The enclosure must be sealed to prevent the entry of air from the outside
- An electrical protection device must be installed on the supply side of the unit



NSYCR10WU1



NSYCR250W115VV

Characteristics	Power (W)	Voltage (V)	References
Aluminum PTC heater	10	12-24 DC	NSYCR10WU1
Aluminum PTC heater	10	110-250 AC	NSYCR10WU2
Aluminum PTC heater	20	12-24 DC	NSYCR20WU1
Aluminum PTC heater	20	110-250 AC	NSYCR20WU2
Aluminum PTC heater	20	270-420 AC	NSYCR20WU3
Aluminum PTC heater	55	12-24 DC	NSYCR55WU1
Aluminum PTC heater	55	110-250 AC	NSYCR55WU2
Aluminum PTC heater	55	270-420 AC	NSYCR55WU3
Aluminum PTC heater	90	12-24 DC	NSYCR100WU1
Aluminum PTC heater	90	110-250 AC	NSYCR100WU2
Aluminum PTC heater	90	270-420 AC	NSYCR100WU3
Aluminum PTC heater	150	12-24 DC	NSYCR150WU1
Aluminum PTC heater	150	110-250 AC	NSYCR150WU2
Aluminum PTC heater	150	270-420 AC	NSYCR150WU3
Aluminum PTC heater with fan	250	115 AC	NSYCR250W115VV
Aluminum PTC heater with fan	250	230 AC	NSYCR250W230VV
Aluminum PTC heater with fan	400	115 AC	NSYCR400W115VV
Aluminum PTC heater with fan	400	230 AC	NSYCR400W230VV
Resistive heater	200	230 AC	NSYCRS200W230V

Thermofan



NSYCRP1W120VTVC

Combination of a resistance heater and an axial fan to ensure uniform heating of the enclosure.

- Fixing by clip on a DIN rail.
- Thermostat adjustable from 0...+60 °C.
- Visual operation indicator.

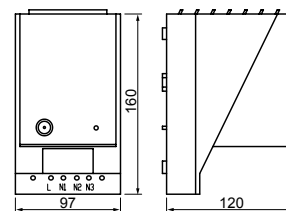

Characteristics	Power (W)	Voltage (V)	References
Thermofan	350/550	120 AC	NSYCRP1W120VTVC
Thermofan	350/550	230 AC	NSYCRP1W230VTVC

Mechanical thermostats

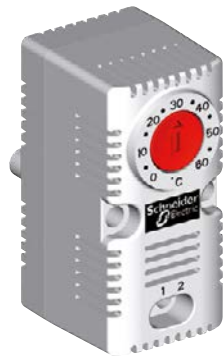

Thermostat with NC contact



Thermostat with NO contact



Thermostat with NO/NC contact



Double Thermostat

Characteristics	NSYCCOTHC (NSYCCOTHCF)	NSYCCOTH0 (NSYCCOTH0F)	NSYCCOTH1	NSYCCOTH D (NSYCCOTHDF)
	Thermostat with NC Contact: <ul style="list-style-type: none"> To control the stopping of a resistance heater when the temperature exceeds the displayed value. Thermostat with NO Contact: <ul style="list-style-type: none"> To control the starting of a fan when the temperature exceeds the displayed maximum value, To control the temperature inside the enclosure by only starting the fan when necessary, thus increasing the service life of the fan and reducing the clogging of the filter. 			
Button color	Red	Blue	Black	Red and blue
Ingress protection rating	IP20	IP20	IP20	IP20
Sensor element	Bimetal	Bimetal	Bimetal	Bimetal
Contact	NC, forced rupture	NC, forced rupture	Inverse, forced rupture	NO/NC, forced rupture
Contact resistance	< 10 mΩ	< 10 mΩ	< 10 mΩ	< 10 mΩ
Service life	> 100,000 cycles	> 100,000 cycles	> 100,000 cycles	> 100,000 cycles
Switching capacity	<ul style="list-style-type: none"> 250 V AC; 10 A (resistive load) 120 V AC; 15 A (resistive load) 250 V AC/120 V AC 2 A (inductive load cos φ = 0.6) 30 W DC 	<ul style="list-style-type: none"> 250 V AC; 10 A (resistive load) 120 V AC; 15 A (resistive load) 250 V AC/120 V AC 2 A (inductive load cos φ = 0.6) 30 W DC 	<ul style="list-style-type: none"> 250 V AC; 10 A (resistive load) 	<ul style="list-style-type: none"> 250 V AC; 10 A (resistive load) 120 V AC; 15 A (resistive load) 250 V AC/120 V AC 2 A (inductive load cos φ = 0.6) 30 W DC
Max interrupting capacity with direct current	NC	NO	250 V AC 4 A (inductive load cos φ = 0.6) 30 W DC	NA
Connection	Two 2.5-mm ² terminals	Two 2.5-mm ² terminals	Four 2.5-mm ² terminals	Six 2.5-mm ² terminals
Mounting	By clip on 35-mm DIN rail	By clip on 35-mm DIN rail	By clip on 35-mm DIN rail	By clip on 35-mm DIN rail
Enclosure	UL 94 V-0 plastic, light grey	UL 94 V-0 plastic, light grey	UL 94 V-0 plastic, light grey	UL 94 V-0 plastic, light grey
Dimensions	60 x 33 x 43 mm	60 x 33 x 43 mm	67 x 50 x 44 mm	60 x 33 x 43 mm
Weight	40 g	40 g	100 g	40 g
Mounting position	Indifferent	Indifferent	Indifferent	Indifferent
Operating temperature	-20...+80 °C (-4...+176 °F)	-20...+80 °C (-4...+176 °F)	-20...+80 °C (-4...+176 °F)	-20...+80 °C (-4...+176 °F)
Hysteresis	7 K	7 K	7 K	7 K
Temperature setting range	0...+60 °C	0...+60 °C	+5...+60 °C	0...+60 °C
Display	°C (°F)	°C (°F)	°C (°F)	°C (°F)
Max. command intensity	10 A 250 V	10 A 250 V	(NO) 5 A (NC) 10 A	(NO) 5 A (NC) 10 A

Thermal control



Mechanical and electronic thermostats

- Large range of temperature control.
- Small dimensions.
- Easily accessible terminals.



Operational temperature range

- For mechanical thermostats: 0 °C ... +60 °C
- For electronic thermostats: -40 °C ... +80 °C



LED display

- Display visible even in the dark.

Technical changes reserved. Information provided without guarantee. Images are for illustrative purposes only.

Electronic thermostats with LED display



Electronic thermostat With LED display



Electronic hygrothermostat With LED display



Electronic hygrometer With LED display

Characteristics	NSYCCOTH30VID NSYCCOTH120VID NSYCCOTH230VID	NSYCCOHYT30VID NSYCCOHYT120VID NSYCCOHYT230VID	- - NSYCCOHY230VID
	Electronic temperature controller	Electronic temperature and humidity controller	Electronic humidity controller
Ingress protection rating	IP20	IP20	IP20
Certification	UL / UR	UL / UR	UL / UR
Internal sensor element	Temperature sensor	Temperature sensor and humidity sensor	Humidity sensor
Contact	Free with zero potential	Free with zero potential	Free with zero potential
Connection	2 x 2.5 mm ² (input voltage) + 2 relays (2 x 2.5 mm ² + 2 x 2.5 mm ²)	2 x 2.5 mm ² (input voltage) + 2 relays (2 x 2.5 mm ² + 2 x 2.5 mm ²)	2 x 2.5 mm ² (input voltage) + 1 relay (2 x 2.5 mm ²)
Mounting	4 different methods: By DIN rail, Spacial SF profile, on VDI cross-rail or on mounting plate		
Enclosure	UL 94 V-0 plastic, light grey		
Operating temperature	-40 °C...+70 °C		
Hysteresis	Programmed 2 K	Programmed 2 K and 3%	3%
Temperature setting range	-40 °C...+80 °C		
Humidity setting range	-	20%...80%	20%...80%
Display	°C or °F	°C or °F or % RH	% RH
Max. command current	8 (5) A 230 V AC / 5 A 30 V DC		

The new quick-fixing systems



- On 35-mm DIN rail.



Certifications and declarations

- UL
- CE



- On Spacial upright.

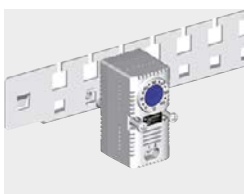

- On cross-rail.



- On mounting plate.

Mechanical thermostats

- Ingress protection rating according to IEC 60529: IP20
- Sensor element: Bimetal
- Contact resistance: < 10 mΩ
- Service life: > 100,000 cycles
- Mounting: By clip on 35-mm DIN rail
- Enclosure: UL 94 V-0 plastic, light grey
- Mounting position: Indifferent
- Operating temperature: -20...+80 °C (-4...+176 °F)
- Hysteresis: 7 K

Thermostat with NC contact



NSYCCOTHC

- Button color: Red
- Contact: NC, forced rupture
- Switching capacity: 250 V AC; 10 A (resistive load)
120 V AC; 15 A (resistive load)
250 V AC/120 V AC 2 A (inductive load cos = 0.6)
30 W DC
- Max interrupting capacity with direct current: NC
- Connection: Two 2.5-mm² terminals
- Weight: 40 g
- Temperature setting range: 0...+60 °C

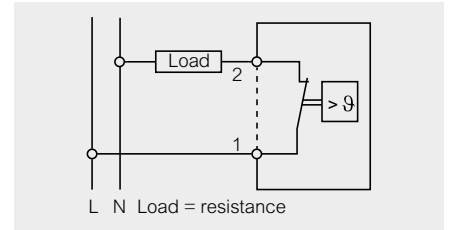

Characteristics	Display	Max. command intensity	Dimensions (H x W x D)	References
Thermostat with NC contact	°C	10 A 250 V	60 x 33 x 43 mm	NSYCCOTHC
Thermostat with NC contact	°F	10 A 250 V	60 x 33 x 43 mm	NSYCCOTHCF

Thermostat with NO contact



NSYCCOTH0

- Button color: Blue
- Contact: NO, forced rupture
- Switching capacity: 250 V AC; 10 A (resistive load)
120 V AC; 15 A (resistive load)
250 V AC/120 V AC 2 A (inductive load cos = 0.6)
30 W DC
- Max interrupting capacity with direct current: NO
- Connection: Two 2.5-mm² terminals
- Weight: 40 g
- Temperature setting range: 0...+60 °C

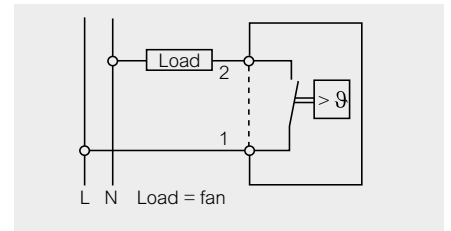

Characteristics	Display	Max. command intensity	Dimensions (H x W x D)	References
Thermostat with NO contact	°C	10 A 250 V	60 x 33 x 43 mm	NSYCCOTH0
Thermostat with NO contact	°F	10 A 250 V	60 x 33 x 43 mm	NSYCCOTH0F

Thermostat with NO/NC contact



NSYCCOTHI

- Button color: Black
- Contact: Inverse, forced rupture
- Switching capacity: 250 V AC; 10 A (resistive load)
- Max interrupting capacity with direct current: 250 V AC 4 A (inductive load cos = 0.6) 30 W DC
- Connection: Four 2.5-mm² terminals
- Weight: 100 g
- Temperature setting range: +5...+60 °C

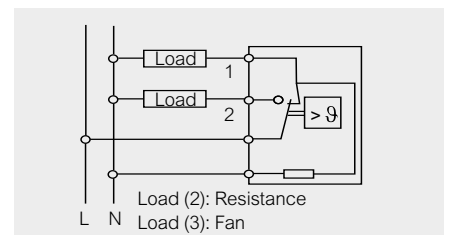

Characteristics	Display	Max. command intensity	Dimensions (H x W x D)	References
Thermostat with NO/NC contact	°C	(NO) 5 A (NC) 10 A	67 x 50 x 44 mm	NSYCCOTHI

Double Thermostat



NSYCCOTH0D

- Button color: Red and blue
- Contact: NO / NC, forced rupture
- Switching capacity: 250 V AC; 10 A (resistive load)
120 V AC; 15 A (resistive load)
250 V AC/120 V AC 2 A (inductive load cos = 0.6)
30 W DC
- Max interrupting capacity with direct current: NA
- Connection: Six 2.5-mm² terminals
- Weight: 40 g
- Temperature setting range: 0...+60 °C

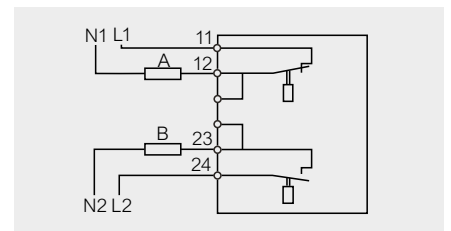

Characteristics	Display	Max. command intensity	Dimensions (H x W x D)	References
Double Thermostat	°C	(NO) 5 A (NC) 10 A	60 x 33 x 43 mm	NSYCCOTH0D
Double Thermostat	°F	(NO) 5 A (NC) 10 A	60 x 33 x 43 mm	NSYCCOTH0DF

Electronic thermostats

- Ingress protection rating according to IEC 60529: IP20
- Certification: UL / UR
- Contact resistance: Free with zero potential
- Mounting: 4 methods: By DIN rail, Spacial SF profile, on VDI cross-rail or on mounting plate
- Enclosure: UL 94 V-0 plastic, light grey
- Operating temperature: -40 °C...+70 °C
- Hysteresis: 7 K
- Max. command intensity: Motor: 4 / 13.1 A, FLA / LRA, 250 Vac
Resistive load: 4 A, 250 Vdc

Electronic thermostats with LED display



NSYCCOTH30VID

- Internal sensor element: Temperature sensor
- Connection: 2 x 2.5 mm² (input voltage) + 2 relays (2 x 2.5 mm² + 2 x 2.5 mm²)
- Hysteresis: Programmed 2 K
- Temperature setting range: -40 °C...+80 °C

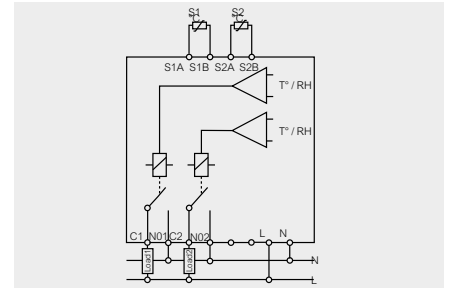

Characteristics	Display	Voltage (type of current)	References
Electronic thermostats, with LED display	°C or °F	9-30 V (AC/DC)	NSYCCOTH30VID
Electronic thermostats, with LED display	°C or °F	90-140 V (AC)	NSYCCOTH120VID
Electronic thermostats, with LED display	°C or °F	200-240 V (AC)	NSYCCOTH230VID

Electronic hygrotherm



NSYCCOHYT30VID

- Internal sensor element: Temperature sensor and humidity sensor
- Connection: 2 x 2.5 mm² (input voltage) + 2 relays (2 x 2.5 mm² + 2 x 2.5 mm²)
- Hysteresis: Programmed 2 K and 3%
- Temperature setting range: -40 °C...+80 °C
- Humidity setting range: 20%...80%

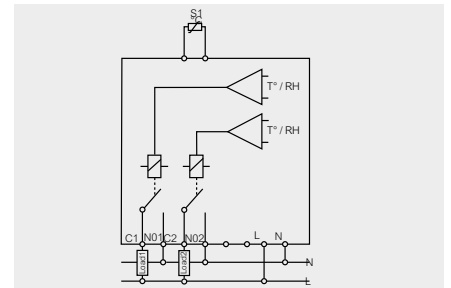

Characteristics	Display	Voltage (type of current)	References
Electronic hygrotherm	°C or °F or % RH	9-30 V (AC/DC)	NSYCCOHYT30VID
Electronic hygrotherm	°C or °F or % RH	90-140 V (AC)	NSYCCOHYT120VID
Electronic hygrotherm	°C or °F or % RH	200-240 V (AC)	NSYCCOHYT230VID

Electronic hygrostat



NSYCCOHY230VID

- Internal sensor element: Humidity sensor
- Connection: 2 x 2.5 mm² (input voltage) + 1 relay (2 x 2.5 mm²)
- Hysteresis: 3%
- Humidity setting range: 20%...80%

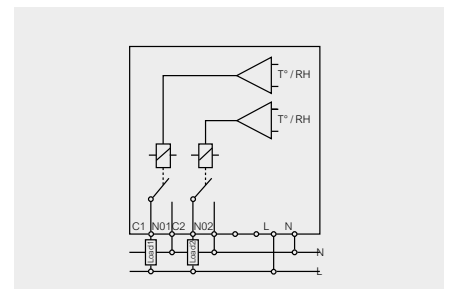

Characteristics	Display	Voltage (type of current)	References
Electronic hygrostat	% RH	200-240 V (AC)	NSYCCOHY230VID

External temperature sensor (double insulation)

Sensor operation or reading range: -40 °C...+150 °C. Thermostat installation tips: The thermostat should be installed at the top of the enclosure (the hottest place). See the various operating modes of each thermostat to choose the one that best meets your needs. Hygrostat installation tips: The hygrostat should be installed at the bottom of the enclosure. 60% RH is the optimal value in the enclosure.

- Ingress protection rating: IP67
- Fixing: On DIN rail, on Spacial SF profile, on VDI cross-rail, on mounting plate



NSYCCASTE

Characteristics	Length of cable supplied	References
External temperature sensor	3 m	NSYCCASTE

Thermal conditions: A hot topic for enclosures

Temperature, humidity, and dew point all affect the performance of your electrical and electronic enclosures. Problem is, unless these environments are sized properly, thermal conditions will compromise reliability, safety, and efficiency, as well as the lifetime of your panels.

The precise knowledge of the thermal conditions is therefore indispensable to choose the most appropriate thermal management solution.

Threats to performance arise when:



Real environmental conditions are not known



Specifications are oversized



Excessive loads over-consume energy

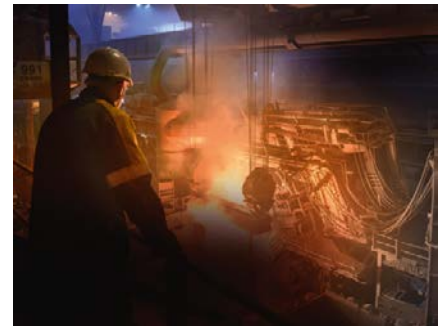

How to use ClimaSys DT

Installation type	Need	What do you want to do?
Greenfield		New Project Determine enclosure sizing needs and the correct thermal solution
Brownfield		Power Dissipation verification Measure the dissipation power of the installation in watts (enclosure without thermal solution installed)
Brownfield		Electronics Health Test Verify that there are no hot/cold spots
Brownfield		Thermal Solution Test Measure the efficiency of the existing thermal solution in a certain period of time
Brownfield		Humidity/Condensation Test Measure the risk of high humidity or condensation inside the enclosure

ClimaSys DT (Diagnostic Tools) dataloggers are an easy-to-use solution that enables users to:

- Access accurate and reliable thermal measurement data in design, commissioning, and exploitation phases
- Track fast or slow measurements
- Maintain continuity of service
- Optimize installations
- Detect hot and cold spots, and avoid condensation problems
- Determine if airing/cooling is required.



ClimaSys DTT

- ClimaSys DT model records the temperature.

Advantages



ClimaSys DTT

- Time stamp/start/stop with magnet key
- Low power consumption for extended two-year battery life
- Easy data download to PC via USB connection
- USB firmware update
- QR code on dataloggers for easy online access to data sheets, videos, and other technical information

Download ProClima free software



e-brochure



Get maximum control panel performance and reliability
Thermal management solutions for critical electrical and electronic enclosures **UE16MK06EN**

Dataloggers

- Color: Translucid
- Display Type: LCD display
- Operating temperature: -40 °C...80 °C
- Standard: EN 12830
- Declaration: CE
- Fixing mode: Clip-on support
- Connector type: USB
- Data recording: 32 K
- Temperature Setting (Accuracy): -40 °C...80 °C (±0.3 °C)
- Battery Type (Lifespan): Lithium CR2032 3 V (Maximum 2 years)
- Composition: 1

Temperature recorder, DT

- Ingress protection rating according to IEC 60529: IP67



NSYDTEF32T

Characteristics	Temperature Resolution	Dimensions (H x W x D)	References
Temperature recorder	0.03 °C	111 x 32 x 26	NSYDTEF32T

IMPORTANT NOTICE:

In 2022, the ClimaSys datalogger offer and data upload to Proclima will evolve and will be simplified for a better user experience.

Method to determine a thermal management solution

Here is a simple method to help you choose a thermal solution.
This method does not take into account the humidity level outside the enclosure.

Thermal balance

1 - Characteristics of the enclosure

Position of the enclosure according to IEC 890 ratio		Formula for calculating S (m ²)	Example Spatial reference NSYSF20840
	Accessible from every side	$S = 1.8 \times H \times (W + D) + 1.4 \times W \times D$	Height = 2000 Width = 800 Depth = 400 Installation method: Suitable enclosure placed against a wall. S = 4.128 m²
	Placed against a wall	$S = 1.4 \times W \times (H + D) + 1.8 \times D \times H$	
	On the end when suited	$S = 1.4 \times D \times (H + W) + 1.8 \times W \times H$	
	On the end when suited, placed against a wall	$S = 1.4 \times H \times (W + D) + 1.4 \times W \times D$	
	In the middle when suited	$S = 1.8 \times W \times H + 1.4 \times W \times D + D \times H$	
	In the middle when suited, placed against a wall	$S = 1.4 \times W \times (H + D) + D \times H$	
	In the middle when suited, placed against a wall with the top covered	$S = 1.4 \times W \times H + 0.7 \times W \times D + D \times H$	
		S = m²	

2 - Thermal power dissipated by the operational components

Calculated as the sum of the power dissipated by each of the installed components. If these are not known, use the ProClima software.	Pd = W	Assume that the switchgear dissipates 800 W. Pd = 800 W
--	---------------	---

3 - Temperatures outside the enclosure

		The temperature conditions are as follows:
Maximum ambient temperature.	Te_{max} = °C	Te_{max} = 35 °C
Minimum ambient temperature.	Te_{min} = °C	Te_{min} = 15 °C

4 - Average target internal temperatures

They are defined by the nature of the components and the parameters of the ambient air		
Maximum internal temperature	Tid_{max} = °C	Tid_{max} = 40 °C
Minimum internal temperature (maximum value between dew point temperature and minimum operating temperature of the devices)	Tid_{min} = °C	Tid_{min} = 29 °C

5 - Temperature inside the enclosure without thermal management system

Max. internal temperature: $Tfi_{max} = \frac{Pd}{K \times S} \times Te_{max}$	Tfi_{max} = °C	Tfi_{max} = 70 °C
Min. internal temperature: $Tfi_{min} = \frac{Pd}{K \times S} \times Te_{min}$	Tfi_{min} = °C	Tfi_{min} = 50 °C
or K = 5.5 W/m ² /°C for an enclosure made of painted sheet steel K = 3.5 W/m ² /°C for a polyester enclosure K = 3.7 W/m ² /°C for a stainless-steel enclosure		

Calculation of thermal management power (Psyst)

a. Cooling systems:

$$Psyst = Pd - K \times S (Tid_{max} - Te_{max}) = 686 \text{ w}$$

b. Resistances:

$$Psyst = K \times S (Tid_{min} - Te_{min}) - Pd$$

$$Psyst = K \times S (Tid_{min} - Te_{min})$$

Technical changes reserved. Information provided without guarantee. Images are for illustrative purposes only.

Method to determine a thermal management solution

Choice of solution

1 - Cooling Condition: Calculated temperature + 5 °C > target temperature

Conditions Cooling	Solution	Advantages	Constraints
Target temperature in the enclosure at least 5 °C higher than the ambient temperature $Tid_{max} \geq T_{emin} + 5\text{ °C}$	Enlarge the enclosure.	Economical. No maintenance. Easy to implement. IP of the installation maintained.	Relatively small savings. Larger overall dimensions.
	Natural airing (installation of airing air inlets).	Very economical. No maintenance. Easy, fast installation.	Quantity of heat removed small and dependent on the layout of the components. Degradation of the IP (ingress of dust).
	Forced-airing.	Economical. Easy to implement. Large quantity of heat removed. Temperature control possible.	Regular maintenance of filters IP slightly degraded. Ambient temperature $\leq 35\text{ °C}$.
	Air-to-air exchanger.	Easy to implement. Easy to maintain. IP of the installation maintained. Regulated temperature.	Regular filter maintenance.
Target temperature Tid_{max} in the enclosure 5 °C less than the ambient temperature Te_{max} . $Tid_{max} - 5\text{ °C} \geq Te_{max}$	Cooling unit.	Easy to implement. Large quantity of heat removed irrespective of the ambient temperature. IP of the installation maintained. Regulated temperature.	Regular filter maintenance Ambient temperature $\leq 55\text{ °C}$. Installation of a system for removal of condensation water from the evaporator.
	Air-to-water exchanger.	Easy to implement. Large quantity of heat removed irrespective of the ambient temperature. IP of the installation maintained. Regulated temperature. No filter to be maintained.	Need for a water circuit. Consumption if supplied with town water.

$$\text{Flow rate (m}^3/\text{h)} = \varnothing = \frac{Psyst}{(Tid_{max} - Te_{max})} \times 3.1 \text{ (m}^3/\text{h)}$$

$$\text{Flow rate (W/K)} = \varnothing = \frac{Psyst}{(Tid_{max} - Te_{max})} \text{ (W/K)}$$

2 - Heating

If the calculated temperature is less than the target temperature, the inside of the enclosure must be heated. The solution is to use heating resistors.

They can maintain the temperature above the dew point and thus help prevent any risk of condensation.

To maintain a uniform temperature inside the enclosure and thus help prevent hot spots, Schneider Electric proposes a heating resistor equipped with a fan.

3 - Homogenize

Objective: Prevent hot spots.

Solution: Circulation fan.

Technical Guides and Spare Parts

Introduction

Enclosures and thermal management systems certifications	712
International enclosure standard	713
Selection of enclosures	715
Degrees of protection provided by enclosures	716
Classification of electrical equipment enclosures according to NEMA and UL	717
Polyester base-painting properties	719
Properties of the plastic materials	721
Description of the marking label affixed to ATEX certified wall-mounted enclosures	723
Spare parts - Selection table	724
Spare parts ClimaSys	734

Enclosures and Thermal Management Systems Certifications

Range	Empty assemblies					Equipped assemblies
	Empty assemblies for low-voltage switchgear	Standards for industrial equipment and UL classification	Marine environment classification or approval for protection and resistance to vibrations	Enclosures installed in a potentially explosive atmosphere	Outdoor heavy-duty enclosures	Low-voltage switchgear and controlgear assemblies
	Standard/Directive					
	IEC 62208	UL508A and CAN CSA C22-2 no. 14	Compliance with requirements of certified bodies	European directive no. 2014/34/UE EN60079-0 / EN60079-7 EN60079-3 / EN60529	IEC 61439-5 ISO 12944-6 IEC 61969-3	IEC61439-1&2
Spacial						
SBM	●	●	● ●			
S3D	● ● ⁽⁶⁾	●	● ● ●			
CRN	● ● ⁽⁶⁾	●	● ●			
CRNG	● ● ⁽⁶⁾	●	● ●			
S3DEX		●		●		
S3HF		●				
S3HD	● ● ⁽⁶⁾	●			●	
S3CM		●				
SM	● ● ● ⁽⁶⁾	●	● ●			
SF	● ● ● ⁽⁶⁾	●	● ● ●			●
SFHD	● ● ● ⁽⁶⁾	●			●	●
PrismaSeT HD	● ● ⁽⁶⁾					●
SFM		●				●
SBX	● ●	●	● ●			
S3X	● ●	●	● ●			
SMX	● ●	●	● ● ● ⁽³⁾			
SFX	● ● ⁽³⁾	●	● ● ● ⁽³⁾			
Thalassa						
TBS/TBP	●	● ● ⁽¹⁾				
PLS	● ●	●				
PLM	● ● ● ⁽⁶⁾	●	● ●			
PLA	● ● ● ⁽⁶⁾	●	● ●			
PLAT	● ● ● ⁽⁶⁾					
PLAZ	● ● ● ⁽⁶⁾					
PLAZT	● ● ● ⁽⁶⁾					
PLD						
PHD	● ● ⁽⁶⁾				● ● ⁽²⁾	
ClimaSys⁽⁴⁾						
CV		●				
CU		●				
CE		●				
CR		● ● ⁽⁵⁾				
CC		●				

⁽¹⁾ Only TBP.

⁽²⁾ ISO 12944-6 only applies to the Spacial enclosures.

⁽³⁾ Only for single-door versions

⁽⁴⁾ EAC-compliant

⁽⁵⁾ The insulated and aluminum resistance heaters of 12-24 V DC and 270-420 V AC are not certified

⁽⁶⁾ Certificate by DEKRA

For other certifications and declarations of conformity please consult us.

Official certification body

Bureau Veritas	LCIE (Bureau Veritas)	Bureau Veritas Marine Division	TUV Rheinland Group	Underwriters Laboratories	Laboratorio Oficial J.M. Madariaga	DNV-GL	Lloyd's Register	Dekra	Asefa
●	●	●	●	●	●	●	●	●	●

Technical changes reserved. Information provided without guarantee. Images are for illustrative purposes only.

The main 10 functions of standard IEC 61439

For each of the following 10 functions, the standard IEC 61439 requires design verifications from the system manufacturer - mainly through type-tests defined in IEC 62208 - and routine verifications on each panel from the panel builder to achieve 3 basic goals: Safety, continuity of service and compliance with end-user requirements.



Safety

Voltage stresses withstand capability

- To withstand long term voltages, and transient and temporary overvoltages according to the insulation coordination principles and requirements.

Current-carrying capability

To help protect against fire and to withstand temperature rise:

- When any circuit is continuously loaded, alone, to the specified current
- When the assembly is loaded to the specified current according to the specified load pattern (between circuits and/or as a function of the time).

Short-circuit withstand capability

- To withstand the stresses resulting from the prospective short-circuit current and from the associated data (high forces between conductors, temp. rise in a very short time, air ionization, overpressure).

Protection against electric shock

- Hazardous live parts not to be accessible (basic protection).
- Accessible conductive parts not to become hazardous-live (fault protection).

Protection against risk of fire or explosion

- Resistance to internal glowing elements.

Comment: Protection of persons, and optional protection of the assembly, against arcing due to internal fault can be specified through a "special test" according to IEC 61641.



Continuity of service

Maintenance and modification capability

Capability to preserve continuity of supply without impairing safety during assembly, maintenance or modification.

- Electrical condition of the assembly or various circuits.
- Speed of exchange of the functional units.
- Test facilities...

Electro-Magnetic Compatibility

To properly function (immunity) and not to generate EM interference (emission) in specified environmental conditions:

- Industrial networks or locations (Environment A).
- Domestic, commercial, and light industrial locations (Environment B).



Compliance with end-user requirements

Capability to operate the electrical installation

To properly function, according to:

- The electrical diagram of the overall system and related information (voltages, coordination...),
- The specified operating facilities (e.g. free or restricted access to man-machine interfaces, isolation of the outgoing circuits...).

Capability to be installed on site

- To withstand handling, transport, storage and installation constraints.
- Capability to be set up and connected (type of enclosure, type, material and cross-sectional areas of external conductors).

Protection of the assembly against mechanical and atmospheric ambient conditions

- Presence of water or solid foreign bodies (IP according to IEC 60529).
- External mechanical impacts (optional IK according to IEC 62262).
- Indoor or outdoor installation (humidity, UV).

Both the point of arrival of energy and a device for distribution to the site applications, the LV switchboard is the intelligence of the system, central to the electrical installation.

It plays an essential role in the availability of electric power, while meeting the needs of personal and property safety. Its definition, design and installation are based on precise rules; There is no space for improvisation. The IEC 61439 standard aims to better define "low-voltage switchgear and controlgear assemblies", helping ensure that the specified performances are reached. It specifies in particular:

- The responsibilities of each player, distinguishing those of the original equipment manufacturer; the organization that performed the original design and associated verification of an assembly in accordance with the standard, and of the assembly manufacturer - the organization taking responsibility for the finished assembly
- The design and verification rules, constituting a benchmark for product certification All the component parts of the electrical switchboard are concerned by the IEC 61439 standard. Equipment produced in accordance with the requirements of this switchboard standard helps ensure the safety and reliability of the installation.



Empty enclosures for low-voltage switchgear and controlgear assemblies. General rules.

Application

For empty enclosures before adding the user's switchgear, in the condition as supplied by the manufacturer.

Field of application

Demands for testing the enclosures to be used as part of the switchgear assemblies for voltages of less than 1000 V alternating current and 1500 V direct current in accordance with IEC 61439.

Information supplied by the manufacturer

- Commercial trademark of the manufacturer: Schneider Electric.
- Mechanical characteristics, materials, conditions for use.
- Conditions for use: Ambient air temperature for outdoor installations: -25 to +40 °C.
- Atmospheric conditions for outdoor installations: The humidity may temporarily reach 100% at a temperature of 25 °C.
- Transport and storage conditions: From -25 to +55 °C; For limited periods not exceeding 24 h: Up to +70 °C.

Comment:

European standard EN 62208 is identical to IEC 62208. European countries publish this standard according to the body in each country (for example BS EN 62208 in the UK).



Standard tests of standard IEC 62208

- Static loads: Test 1.25 x maximum admissible load during 1 hour.
- Lifting: Applicable to enclosures with lifting accessories.
- Axial loads of metal inserts: 500 N for 10 seconds for M8 inserts.
- IK code: Test according to standard IEC 62262 with pendulum impact tester. The enclosure must maintain its IP rating after the test.
- IP rating: Test according to standard IEC 60529. Degree of protection against access to dangerous parts and the penetration of solid bodies and against the penetration of water.
- Thermal stability at a temperature of 70 °C: 7 days.
- Resistance to heat: Ball test at 70 °C.
Information required for enclosures made from insulated material.
- Resistance to abnormal heat and to fire: Glow wire test according to IEC 60695-2-10 and IEC 60695-2-11.
Information required for enclosures made from insulated material.
- Dielectric strength: 5000 V
Information required for enclosures made from insulated material.
- Protection circuit continuity for metal enclosures: Resistance not to exceed 0.1 ohm.
- Weather resistance: Duration 500 h (cycle: Rain 5 minutes + UV lamp 25 minutes).

Corrosion resistance:

For indoor enclosures:

- 6 cycles of 24 hours of the damp heat test at 40 °C and relative humidity of 95%.
- 2 cycles of 24 hours of the salt mist test at 35 °C.

For outdoor enclosures:

2 identical 12 day periods. Each one with:

- 5 cycles of 24 hours of the damp heat test at 40 °C and relative humidity of 95%.
- 7 cycles of 24 hours of the salt mist test at 35 °C.

Our empty enclosures are CE-marked according to the Low-Voltage Directive (LVD). It is the responsibility of the final equipment manufacturer to respect regulations in force.

Selection according to the IP protection degrees

The degrees of protection, explained on the next page, is an important element when selecting the enclosures. The following table shows the protection degrees of the enclosures.

Name	Range	IP43	IP44	IP54	IP55	IP65 ⁽⁷⁾	IP66
Metal industrial boxes	Spacial SBM						●
Metal derivation boxes	Spacial SDB				●		
Stainless-steel boxes	Spacial SBX						●
Steel wall-mounted enclosures	Spacial S3D				● ⁽¹⁾		●
Steel modular distribution wall-mounted enclosures	Spacial S3DM						●
Terminal wall-mounted enclosures	Spacial S3DB						●
Steel wall-mounted enclosures	Spacial S3HF				●		
Steel wall-mounted enclosures	Spacial CRN						●
Steel wall-mounted enclosures	Spacial CRNG				● ⁽¹⁾		●
EMC steel floor-standing enclosures	Spacial SFHF				●		
HMI control enclosures	Spacial S3CM			●			
ATEX steel wall-mounted enclosures	Spacial S3DEX						●
Steel outdoor wall-mounted enclosures	Spacial S3HD						●
Stainless-steel wall-mounted enclosures	Spacial S3X				● ⁽¹⁾		●
Seismic and nuclear enclosures	Spacial S3D6G / Spacial S3D6GK3					●	
Terminal enclosures with FL21 cut-out	Spacial S3DBFL					● ⁽⁶⁾	
Steel floor-standing enclosures	Spacial SM				●		
Steel suitable enclosures	Spacial SF				●		
Steel outdoor floor-standing enclosures	Spacial SFHD				●		
Stainless-steel floor-standing enclosures	Spacial SMX						● ⁽⁷⁾
Stainless-steel suitable enclosures	Spacial SFX						● ⁽⁷⁾
Functional steel floor-standing enclosures	PrismaSeT HD				●		
Steel control desks	Spacial SD				●		
Stainless-steel control desks	Spacial SDX				●		
Thermoplastic industrial boxes	Thalassa TBS-TBP				● ⁽⁴⁾		● ⁽⁵⁾
Polyester modular boxes	Thalassa PLS						●
Polyester wall-mounted enclosures	Thalassa PLM						●
Polyester outdoor wall-mounted enclosures	Thalassa PHD					●	
Polyester floor-standing enclosures	Thalassa PLA ⁽²⁾		●	●		●	
Polyester floor-standing enclosures	Thalassa PLD	●		● ⁽³⁾			
Polyester outdoor floor-standing enclosures	Thalassa PHD				●		

⁽¹⁾ Double-door.

⁽²⁾ Different IP depending on the version. See introduction in Thalassa section: PLA: IP65, PLAT / PLA2T: IP44, PLAZ / PLAT / PLA2T with grille: IP54.

⁽³⁾ With gasket.

⁽⁴⁾ Button boxes.

⁽⁵⁾ Universal boxes.

⁽⁶⁾ With membrane mounted.

⁽⁷⁾ Single-door enclosure.

The universal offer

> **3** Material options

Steel

Stainless-steel

Plastic and Polyester

Selection according to ambient conditions

The location of the enclosures and the physical, chemical and climatic conditions to which they are exposed will determine the model to be used.

- Steel enclosures are particularly well suited to indoor use in industrial environments.
- Stainless-steel enclosures are particularly well suited to corrosive environments or areas where specific hygiene demands are applicable.
- Polyester enclosures are particularly well suited to severe corrosive atmospheres, indoors or outdoors.

Enclosures made from insulated materials ensure total insulation, reducing electric hazards for persons.

























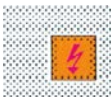

The main characteristics of the plastic materials of our enclosures and their chemical strength are given on [page 721](#).

Further help for making the selection is given by the NEMA or UL classification of the enclosure, see [page 718](#).

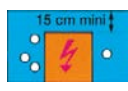
- The degrees of protection provided by the enclosures are defined by standards IEC 60529 (IP) and IEC 62262 (IK).
- Degrees of protection are indicated by the letters IP followed by two characteristic numerals. The numerals show the degree of protection offered by the enclosure against access to hazardous parts, the penetration by solid bodies (1st numeral), and against the penetration of liquids (2nd numeral).
- The protection against external mechanical impact is indicated by the letters IK followed by a characteristic group numeral.

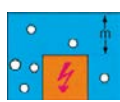
Comment:

Many EN European standards are harmonized with international IEC standards. This is the case with enclosure protection standards:
 - EN 60529 = IEC 60529.
 - EN 62262 = IEC 62262.

	IP	IK
First numeral Protection against solid bodies	Second numeral Protection against liquids	Mechanical protection
<p>0 </p> <p>No protection</p>	<p>0 </p> <p>No protection</p>	<p>0 </p> <p>No protection</p>
<p>1 </p> <p>Protected against solid bodies larger than 50 mm (e.g.: Incidental contact with the hand)</p>	<p>1 </p> <p>Protected against vertically falling water droplets (condensation)</p>	<p>1 </p> <p>Impact energy: 0.150 Joules</p>
<p>2 </p> <p>Protected against solid bodies larger than 12 mm (e.g.: Finger contact)</p>	<p>2 </p> <p>Protected against water droplets deflected at up to 15° from vertical</p>	<p>2 </p> <p>Impact energy: 0.200 Joules</p>
<p>3 </p> <p>Protected against solid bodies larger than 2.5 mm (tools, cables)</p>	<p>3 </p> <p>Protected against rainwater at up to 60° from vertical</p>	<p>3 </p> <p>Impact energy: 0.350 Joules</p>
<p>4 </p> <p>Protected against solid bodies larger than 1 mm (fine tools, small cables)</p>	<p>4 </p> <p>△ Protection against water spray from all directions</p>	<p>4 </p> <p>Impact energy: 0.500 Joules</p>
<p>5 </p> <p>◆ Protected against dust (no harmful deposits)</p>	<p>5 </p> <p>△△ Protected against low-pressure water jets from all directions</p>	<p>5 </p> <p>Impact energy: 0.700 Joules</p>
<p>6 </p> <p>◆ Totally dust tight</p>	<p>6 </p> <p>Protected against powerful water jets from all directions</p>	<p>6 </p> <p>Impact energy: 1.00 Joules</p>
	<p>7 </p> <p>■ Protected against the effects of immersion</p>	<p>7 </p> <p>Impact energy: 2.00 Joules</p>
	<p>8 </p> <p>■...■ Protected against prolonged effects of immersion under pressure</p>	<p>8 </p> <p>Impact energy: 5.00 Joules</p>
		<p>9 </p> <p>Impact energy: 10.00 Joules</p>
		<p>10 </p> <p>Impact energy: 20.00 Joules</p>

Classification of electrical equipment enclosures according to NEMA and UL

NEMA and UL are standardisation bodies, commonly recognized in North America, which have issued classifications of enclosures according to the protection offered in various environments.

These classifications are similar.

The 1st table below summarises these classifications which do not include potentially explosive areas.

The detailed recommendations of these classifications are given on the next page.

The 2nd table indicates the classification of our enclosures.

These classifications appear in our UL certifications (see Certification technical annex on [page 718](#)).

Certification according to the UL classification helps guarantee the corresponding NEMA classification by equivalence.

Environment and protection	Classification												
	1	2	3	3R	3S	4	4X	5	6	6P	12	13	
Indoor use	●	●	●	●	●	●	●	●	●	●	●	●	●
Outdoor use			●	●	●	●	●		●				
Incidental contact with the equipment	●	●	●	●	●	●	●	●	●	●	●	●	●
Dirt	●	●	●	●	●	●	●	●	●	●	●	●	●
Drips and gentle splashes of non-corrosive liquids		●	●	●	●	●	●	●	●	●	●	●	●
Rain, frost* and snow			●	●	●	●	●		●	●			
Frost**					●								
Dust, fibers and particles in suspension			●		●	●	●		●	●	●	●	●
Accumulated dust, fibers and particles in suspension			●		●	●	●	●	●	●	●	●	●
Clouds of dust			●		●	●	●		●	●			
Splashes and spray of water						●	●		●	●			
Gentle splashes and leaks of oil or non-corrosive coolants											●	●	
Drips, splashing and spraying of oil or non-corrosive coolants												●	
Corrosive agents								●		●			
Occasional temporary immersion									●	●			
Occasional prolonged immersion										●			

* The operation of the external mechanisms is not required when the enclosure is covered with frost.

** The operation of the external mechanisms is required when the enclosure is covered with frost.

Enclosures		Type of protection ⁽¹⁾													
Name	Range	1	2	3	3R	3S	3X	3RX	3SX	4	4X	5	6	12	13
Metal industrial boxes	SBM									●	●				
Stainless-steel industrial boxes	SBX									●	●				●
HMI control enclosures	S3CM	●	●		●									●	●
Steel wall-mounted enclosures	S3D ⁽¹⁾	●	● ⁽²⁾	● ⁽²⁾	● ⁽²⁾					● ⁽²⁾	● ⁽²⁾	●		●	●
Steel wall-mounted enclosures	S3HF	●	●	●	●									●	●
Steel outdoor wall-mounted enclosures	S3HD	●	●	●	●					●	●	●		●	●
Steel wall-mounted enclosures	CRN	●	●	●	●					●		●		●	●
Steel wall-mounted enclosures	CRNG	●	● ⁽²⁾	● ⁽²⁾	● ⁽²⁾					● ⁽²⁾	● ⁽²⁾	● ⁽²⁾		●	●
Stainless-steel wall-mounted enclosures	S3X	●	● ⁽²⁾	● ⁽²⁾	● ⁽²⁾					● ⁽²⁾	● ⁽²⁾	● ⁽²⁾		●	● ⁽²⁾
Steel floor-standing enclosures	SM	●	● ⁽²⁾	● ⁽²⁾	●					● ⁽²⁾		● ⁽²⁾		●	●
Polyester outdoor wall-mounted enclosures	PHD	●	●	●	●					● ⁽²⁾	● ⁽²⁾	●		●	●
Steel suitable enclosures	SF	●			●									●	
Steel outdoor floor-standing enclosures	SFHD	●			●									●	
Stainless-steel floor-standing enclosures	SMX	●	● ⁽²⁾	● ⁽²⁾	● ⁽²⁾					● ⁽²⁾	● ⁽²⁾	● ⁽²⁾		●	●
Stainless-steel floor-standing enclosures	SFX	● ⁽²⁾	● ⁽²⁾	● ⁽²⁾	● ⁽²⁾					● ⁽²⁾	● ⁽²⁾	● ⁽²⁾			● ⁽²⁾
Thermoplastic boxes	TBP	●		●		●				●	●				
Polyester modular boxes	PLS	●	●	●	●	●				●	●			●	●
Polyester wall-mounted enclosures	PLM	●	●	●	●	●				●	●	●		●	●
Polyester floor-standing enclosures	PLA	●	●	● ⁽²⁾	● ⁽²⁾	● ⁽²⁾	● ⁽²⁾	● ⁽²⁾	● ⁽²⁾			● ⁽²⁾		●	●

⁽¹⁾ Also S3DM, S3DEX and S3DC.

⁽²⁾ 1 door.

Components		Type of protection ⁽⁵⁾													
Name	Range	1	2	3	3R	3S	4	4X	5	6	6P	12	13		
Airing system	CV											●			
Thermal control system	CC	●													

⁽⁵⁾ In some ranges the classification depends on the model and version. The detailed protection types are indicated in the UL certifications.

Classification of electrical equipment enclosures according to NEMA and UL



The enclosures must protect the equipment against environmental conditions and help protect persons against the risk of incidental contact with the equipment. The following classifications (Type) are applied according to the required uses and prescriptions:

Type	Use	Prescription
1	Indoor use	The enclosure provides protection for persons against incidental contact with the internal equipment and protects said equipment against dirt.
2	Indoor use	It provides protection for persons against incidental contact with the internal equipment and protects said equipment against dirt, drips and gentle splashes of non-corrosive liquids.
3	Indoor and outdoor use	The enclosure provides protection for persons against incidental contact with the internal equipment and protects said equipment against dirt, rain, sleet, snow, windblown and resists the formation of ice on the outside.
3R	Indoor and outdoor use	The enclosure provides protection for persons against incidental contact with the internal equipment and protects said equipment against dirt, rain, sleet, snow and resists the formation of ice on the outside.
3S	Indoor and outdoor use	The enclosure provides protection for persons against incidental contact with the internal equipment and protects said equipment against dirt, rain, sleet, snow and windblown dust. The external mechanism must continue to work even when layers of ice are formed.
3X	Indoor and outdoor use	The enclosure provides a degree of protection to personnel against access to hazardous parts; To provide a degree of protection of the equipment inside the enclosure against ingress of solid foreign objects (falling dirt and windblown dust); To provide a degree of protection with respect to harmful effects on the equipment due to the ingress of water (rain, sleet, snow); To provide an additional level of protection against corrosion and that will be undamaged by the external formation of ice on the enclosure.
3RX	Indoor and outdoor use	The enclosure provides a degree of protection to personnel against access to hazardous parts; To provide a degree of protection of the equipment inside the enclosure against ingress of solid foreign objects (falling dirt); To provide a degree of protection with respect to harmful effects on the equipment due to the ingress of water (rain, sleet, snow); To prevent damage by the external formation of ice on the enclosure and to provide an additional level of protection against corrosion.
3SX	Indoor and outdoor use	The enclosure provides a degree of protection to personnel against access to hazardous parts; To provide a degree of protection of the equipment inside the enclosure against ingress of solid foreign objects (falling dirt and windblown dust); To provide a degree of protection with respect to harmful effects on the equipment due to the ingress of water (rain, sleet, snow); To provide an additional level of protection against corrosion; To ensure that external mechanism(s) remain operable when ice laden.
4	Indoor and outdoor use	The enclosure provides protection for persons against incidental contact with the internal equipment and protects said equipment against dirt, rain, sleet, snow, windblown dust, splashes and hose-directed water and resists the formation of frost on the outside.
4x	Indoor and outdoor use	The enclosure provides protection for persons against incidental contact with the internal equipment and protects said equipment against dirt, rain, sleet, snow, windblown dust, splashes, hose-directed water and resists corrosion and the formation of ice on the outside.
5	Indoor use	The enclosure provides protection for persons against incidental contact with the internal equipment and protects said equipment against dirt, settling airborne dust, lint, fibers, flyings, drips and gentle splashes of non-corrosive liquids.
6	Indoor and outdoor use	The enclosure provides protection for persons against incidental contact with the internal equipment and protects said equipment against dirt, rain, sleet, snow, hose-directed water, the entry of water during occasional temporary submersion to a limited depth and resists the formation of ice on the outside.
6P	Indoor and outdoor use	The enclosure provides protection for persons against incidental contact with the internal equipment and protects said equipment against dirt, rain, sleet, snow, hose-directed water, the entry of water during prolonged submersion to a limited depth and resists corrosion and the formation of ice on the outside.
12	Indoor use (without knock-outs)	The enclosure provides protection for persons against incidental contact with the internal equipment and protects said equipment against dirt, dust, fluff, fibers, particles in suspension, drips and gentle splashes of non-corrosive liquids as well as gentle splashes or leaks of oil and non-corrosive coolants.
13	Indoor use	The enclosure provides protection for persons against incidental contact with the internal equipment and protects said equipment against dirt, dust, lint, fibers flyings and the spraying, splashing, and seepage leaks of water, oil or non-corrosive coolants.

Note:
The above recommendations aim to explain the NEMA and UL classifications, but are not the official texts of NEMA or UL. The exact definitions provided by the Organisations are those of standards NEMA 250 and UL 50E.

Polyester base-painting properties



Product type

Thermosetting polyester resins based powder painting modified by epoxy resins and designed for decoration and to help prevent corrosion. The performance of this painting is superior to conventional epoxy powders in terms of color stability, temperature resistance and weather resistance. RAL 7035 grey; Surface finish: Structured.

Mechanical properties

Testing conditions: Steel samples with a thickness of 10/10^e mm. Degreasing using biodegradable surface-active agents. Film thickness: 60 microns.

Test	Standard	Result
Bonding (scratching and adhesive tape)	ISO 2409	≥ to Class 1
Ericksen stamping	ISO 1520	≥ 7 mm
Direct impact resistance	ISO 6272	> 1 kg/70 cm
Indirect impact resistance	ISO 6272	> 1 kg/20 cm
Bending around conical mandrel	ISO 6860 - ASTM D 522-88	Maximum cracking of 70 mm, without the paint coming loose

Chemical properties

Tests conducted at ambient temperature on phosphated samples covered with a 70 to 100 micron film:

- Film intact.
- Film attacked (blistering, yellowing, loss of gloss).

Number of months		2	4	6	8	10	12
Acid	Acetic (20%)	[Intact]					
	Sulphuric (30%)	[Intact]					
	Nitric (30%)	[Intact]		[Attacked]			
	Phosphoric (30%)	[Intact]					
	Hydrochloric (30%)	[Intact]				[Attacked]	
	Lactic (10%)	[Intact]					
	Citric (10%)	[Intact]				[Attacked]	
Base	Soda (10%)	[Intact]		[Attacked]			
	Ammonia (10%)	[Intact]		[Attacked]			
Water	Distilled water	[Intact]				[Attacked]	
	Sea water	[Intact]					
	Tap water	[Intact]					
	Diluted chloride bleach	[Intact]		[Attacked]			
Solvents	Petrol	[Intact]		[Attacked]			
	Higher-grade alcohols	[Intact]				[Attacked]	
	Aliphatics	[Intact]		[Attacked]			
	Aromatics	[Intact]		[Attacked]			
	Ketone-ester	[Attacked]					
Tri-perchlorethylene	[Attacked]						

Physical properties

Temperature resistance: -40 °C and 100 hours at +150 °C (color: White). Gloss retention: Good.

Resistance to corrosion

Compliance with standard IEC 62208 for outdoor installations: 288 h of humid heat and 336 h of salt mist.

Polyester base-painting properties

Nuclear decontamination

Applicable to colors RAL 7035 grey and AFNOR A550.

Standard NFT 30901. Percentage of decontamination for contamination by fission products. Please consult us for further details.

Accelerated aging

Standard IEC 62208: 500 h UV according to ISO 4892 (method A)

(adherence of the painting with minimum retention of 50% on the grid according to ISO 2409).

Fire behaviour

Class M1 (self-extinguishing material).

Class M0 (for painting on a metal base).

Manufacturing process



Properties of plastic materials - Mechanical, electrical, physical and fire-resistance properties

Plastic materials generally used to manufacture our products:

- ABS.
- Polycarbonate.
- PVC (polyvinyl chloride).
- Bayblend® = PC + ABS.
- Polyester reinforced with fiberglass.
- Altuglas.
- Polypropylene.
- Polystyrene.
- Polyamide 6 and 12.
- SBS.

Comment:

For other chemical agents, please contact us.

All information provided here is taken from the best sources and provided for information purposes only, with no commitment on our behalf.

Specifications	Standards	Units	ABS	Polycarbonate	PVC	Bayblend®	Polyester	SBS
Mechanical properties								
Tensile strength	ISO 257	MPa	44	> 65	45	35	85	5
Tensile strain	ISO 527	%	12	> 110	120 bis 150	40	0	600
Impact resistance	ISO 179	kJ/m ²	125	No breakage	25	No breakage	60	No breakage
Notching resistance	ISO 179	kJ/m ²	19	25	20	25	50	-
Electrical properties								
Stress point	IEC 60112	-	-	250-300	> 600	> 550	> 600	-
Surface strength	IEC 60093	Ω	1015	> 1015	> 1013	> 1014	≥1012	> 1013
Dielectric strength	IEC 60243	kV/mm	16.5	> 30	30	24	18-20	20
Specific resistivity	IEC 60093	Ω ² cm	1015	> 1016	≥ 1015	1016	≥ 1012	> 1016
Physical properties								
Softening temperature (Vicat B)	ISO 306	°C	95	145-150	79-80	115	⁽¹⁾	80
Temperature resistance	-	°C	-40...+90	-50...+125	-20...+65	-35...+90	-50...+150	-40...+120
Water absorption	ISO 62	%	0.2 - 0.45	0.15	< 0.1	0.2	0.2	-
Specific weight	ISO 1183	kg/dm ³	1.04	1.21	1.4	1.12	1.85	0.3 in 24 h
Fire resistance								
Oxygen index	ISO 4589	%	19	26	45-50	22	24.4	18
Glow wire resistance, 2 mm	IEC 60695-2-10	°C	650	960	960	750	960	750° (1.5 mm)
Glow wire resistance, 3 mm	IEC 60695-2-10	°C	650	960	960	750	960	NA

⁽¹⁾No softening of the polyester.

Specifications	Standards	Units	Altuglas	Polypropylene	Polystyrene	Polyamide 6	Polyamide 12
Mechanical properties							
Tensile strength	ISO 257	MPa	30	35	24	40	30
Tensile strain	ISO 527	%	5	400	36	200	300
Impact resistance	ISO 179	kJ/m ²	20	20	63	No breakage	No breakage
Notching resistance	ISO 179	kJ/m ²	3	5	50	31.2	15
Electrical properties							
Stress point	IEC 60112	-	-	-	KB175	KB175	KB180
Surface strength	IEC 60093	Ω	≥ 1014	-	> 1013	1012	5 x 1010
Dielectric strength	IEC 60243	kV/mm	13-15	20	≤ 40	23	55
Specific resistivity	IEC 60093	Ω ² cm	> 1015	> 1016	> 1015	1011	3 x 1011
Physical properties							
Softening temperature (Vicat B)	ISO 306	°C	120-122	75 (vicat A)	79	230	140
Temperature resistance	-	°C	-20...+80	-10...+80	-15...+60	-20...+100	-50...+125
Water absorption	ISO 62	%	< 0.5	0.1 in 24 h	0.1 in 24 h	1.6	1.5
Density	ISO 1183	kg/dm ³	1.18	0.91	1.06	1.14	1.03
Fire resistance							
Oxygen index	ISO 4589	%	18.5	18	18	24	22
Glow wire resistance, 2 mm	IEC 60695-2-10	°C	-	650	650	750	650
Glow wire resistance, 3 mm	IEC 60695-2-10	°C	960	650	650	850	650

Properties of plastic materials - Resistance to chemical agents

Plastic materials generally used to manufacture our products:

- ABS.
- Polycarbonate.
- PVC (polyvinyl chloride).
- Bayblend® = PC + ABS.
- Polyester.
- Altuglas.
- Polypropylene.
- Polystyrene.
- Polyamide 6 and 12.
- SBS.

The table shows:

The concentration of the chemical agent in %;

- Sat = saturation.

The resistance of the material:

- +: Resistant.
- O: Limited resistance.
- -: Not resistant.

Resistance to	ABS	Polycarbonate	PVC	Bayblend®	Polyester	Altuglas	Polypropylene	Polystyrene	Polyamide 6	Polyamide 12	SBS											
Acetone	-	-	-	-	-	O	100	+	-	100	+											
Hydrochloric acid	15	+	10	+	30	+	20	+	30	+	sat	+	10	+	O	10	-	10	+	10	+	
Citric acid			10	+	sat	+	10	+	100	+	sat	+	+	10	O			+	+	10	+	
Lactic acid	80	+	10	+	90	+	10	-	100	+	20	+	90	+	O	50	O		+	+	sat	+
			100	-											90	-			+			
Nitric acid	30	+	10	+	50	+	10	+	20	+	10	+	25/		O	2	O		-		50	+
			100	-									50	-	10	-						
Phosphoric acid	85	+	100	+	sat	+		+	100	+	10	+	sat	+	O	2	O	50	+			+
											95	-			10	-						
Sulphuric acid	50	+	50	+	96	+	30	+	70	+	30	+	96	+	O	3	-	10	+		96	+
			100	-																		
Alcohol	O	96	+	96	+		-	50	O	50	O	96	+		+	96	O	96	+			+
Pure aniline	O		-	100	-		-		O		-	100	+			100	O	100	O			
Benzene	+	100	-		-		+		-		O	100	O			100	+		+			-
Liquid bromine		100	-		-		-					100	-					100	-			-
Liquid chlorine			-	100	-			sat	+		-	100	-			100	O		-	50	+	
Sea water	+	100	+	100	+		+	100	+	100	+			100	+			100	+	sat		+
Petrol	+	100	+	100	O		-	100	+	100	O		-		-	100	+		+			-
Ether	-	100	O	100	-		-	100	O		+					100	+	100	+			-
Hexane	O		+		O		O	-				100	+			100	+	100	+			-
Oil and greases	+	100	+	100	+		O	100	+	100	O	100	+		-		+	100	+			-
Aromatic hydrocarbon	O		-		-		-		-		+	-			-		-		+			-
Fuel oil	O	100	O	100	+		-	100	+	100	-	100	+			100	+	100	+			-
Naphthalene				100	O		-	100	+	100	-	100	+			100	+	100	+			-
Nitrobenzene	-		-	100	-		-				-	100	O			-			O			-
Phenol	-		-	sat	O		-	20	O		-	sat	+			-		-		10	O	
Mineral salts			+		+		+		+		+		+									+
Iodine solution			O		-		+				-											+
Toluene	-		-	100	-		-		+		O	100	O		-	100	+	100	+			-
Trichloroethylene	-		-	100	-		-		-		-	100	O		-	100	-	100	O			-
Urea			sat	+	sat	+		+				sat	+					10	+	sat	+	sat

Comment:

For other chemical agents please contact us.

All information provided here is taken from the best sources and provided for information purposes only, with no commitment on our behalf.

Description of marking labels on ATEX-certified wall-mounted enclosures

Spacial S3DEX

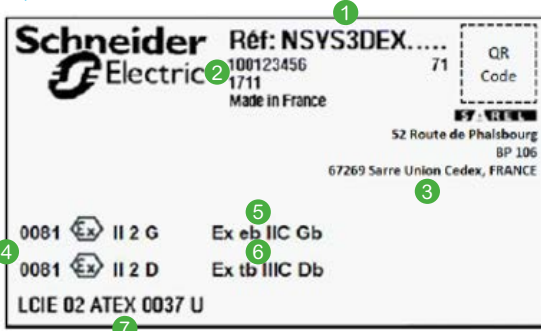

- 1
 - Range of the product with its dimensions
- 2
 - 100123456 71: exemple of the serial number
 - 1711: exemple of the year and the month of the manufacturing
- 3
 - Address of manufacturer
- 4
 - 0081: identification number of the notified body for the application of the ATEX directive
 - : distinctive mark indicating that the product is authorized in an explosive atmosphere
 - II: Industry group (II = surface industries)
 - 2: device category (2 = occasional presence, Zone 1 or 21)
 - G: atmosphere type (G = gases and vapors)
 - D: atmosphere type (D = dust)
- 5
 - Ex: symbol that indicates the product complies with one or several protection modes
 - eb: protection level of type of protection "e" for increased safety (EN 60079-7)
 - II C: group of gaz (hydrogen/acetylene)
 - Gb: type of protection for non-electric material (control of power supply) G = gaz
- 6
 - Ex: symbol indicating that the product complies with one or several protection types
 - tb: protection level of type of protection "t" per enclosure (EN 60079-31)
 - III C: type of dust (conductive dust)
 - Db: type of protection for non-electric material (control of power supply) D = dust
- 7
 - Number of the EC type examination certificate (Included the name of the certification body)



Download our ATEX certificates from our site.

Steel industrial boxes SBM



NSYSBMABS4

Accessories	References
Bag of acces. SBM boxes 4 screws	NSYSBMABS4
Bag of acces. SBM boxes 6 screws	NSYSBMABS6

Steel wall-mounted enclosures S3D



NSYDS3D32

Doors	References	Door accessories	References
Plain door 300 x 200	NSYDS3D32	Gasket double-door encl.	NSYGDD
Plain door 300 x 250	NSYDS3D325	Set of 5 taps and latches	NSYS3DTL
Plain door 300 x 300	NSYDS3D33	Hinge 120°	NSYAEDH120S3D
Plain door 300 x 400	NSYDS3D34	Hinge 180°	NSYAEDH180S3D
Plain door 400 x 300	NSYDS3D43	Earthing accessories	References
Plain door 400 x 400	NSYDS3D44	Set of 500 earthing labels	NSYSWMEL
Plain door 400 x 600	NSYDS3D46	Fixing hardware cable gland plate	References
Plain door 500 x 300	NSYDS3D53	100 screws	NSYS3DCGSB
Plain door 500 x 400	NSYDS3D54	Standard screw bag	NSYS3DCGPSTDSB
Plain door 500 x 500	NSYDS3D55	Locking accessories	References
Plain door 600 x 400	NSYDS3D64	Set of 10 linkage guides	NSYS3DLG
Plain door 600 x 500	NSYDS3D65	Standard key DB3	NSYAEDLS3DKDB3
Plain door 600 x 600	NSYDS3D66	Lock + standard key DB3 neutral	NSYAEDLS3DRLN
Plain door 600 x 800	NSYDS3D68	3 point lock linkage H 600 mm	NSYBTAS3D60
Plain door 700 x 500	NSYDS3D75	3 point lock linkage H 700 mm	NSYBTAS3D70
Plain door 800 x 600	NSYDS3D86	3 point lock linkage H 800 mm	NSYBTAS3D80
Plain door 800 x 800	NSYDS3D88	3 point lock linkage H 1000 mm	NSYBTAS3D100
Plain door 800 x 1000	NSYDS3D810	3 point lock linkage H 1200 mm	NSYBTAS3D120
Plain door 800 x 500 right	NSYDS3D85R	3 point lock linkage H 1400 mm	NSYBTAS3D140
Plain door 800 x 500 left	NSYDS3D85L	Lock with key type 3131A	NSYAEDL3131AS3D
Plain door 800 x 600 right	NSYDS3D86R	3 point lock linkage (H = 650 mm)	NSYBTAS3D65
Plain door 800 x 600 left	NSYDS3D86L	3 point lock linkage (H = 900 mm)	NSYBTAS3D90
Plain door 1000 x 600	NSYDS3D106	Panels	References
Plain door 1000 x 800	NSYDS3D108	50 caps for holes of hinges WM	NSYSWMCH
Plain door 1000 x 1000	NSYDS3D1010	Set of 50 back plugs WM	NSYSWMBP
Plain door 1200 x 1000	NSYDS3D1210		
Plain door 1000 x 500 right	NSYDS3D105R		
Plain door 1000 x 500 left	NSYDS3D105L		
Plain door 1000 x 600 right	NSYDS3D106R		
Plain door 1000 x 600 left	NSYDS3D106L		
Plain door 1200 x 600	NSYDS3D126		
Plain door 1200 x 800	NSYDS3D128		
Plain door 1200 x 500 right	NSYDS3D125R		
Plain door 1200 x 500 left	NSYDS3D125L		
Plain door 1200 x 600 right	NSYDS3D126R		
Plain door 1200 x 600 left	NSYDS3D126L		
Plain door 1400 x 500 right	NSYDS3D145R		
Plain door 1400 x 500 left	NSYDS3D145L		

Steel wall-mounted enclosures S3DM



NSYS3DCGSB

Fixing hardware	References
100 screws for cable gland plate	NSYS3DCGSB
Standard screw bag cable gland plate	NSYS3DCGPSTDSB
Earthing accessories	References
Set of 500 earthing labels	NSYSWMEL
Locking accessories	References
Set of 10 linkage guides	NSYS3DLG
Standard key DB3	NSYAEDLS3DKDB3
3 point lock linkage H 600 mm	NSYBTAS3D60
3 point lock linkage H 700 mm	NSYBTAS3D70
3 point lock linkage H 800 mm	NSYBTAS3D80
3 point lock linkage H 1000 mm	NSYBTAS3D100
Panels WM	References
50 caps for holes of hinges	NSYSWMCH
Set of 50 back plugs	NSYSWMBP

Steel wall-mounted enclosures S3DC



NSYSWMEL

Earthing accessories	References
Set of 500 earthing labels	NSYSWMEL
Locking accessories	References
Set of 10 linkage guides	NSYS3DLG
Standard lock enclosures	NSYAEDLS3DC
3 point lock linkage H 600 mm	NSYBTAS3D60
3 point lock linkage H 700 mm	NSYBTAS3D70
3 point lock linkage H 800 mm	NSYBTAS3D80
3 point lock linkage H 1000 mm	NSYBTAS3D100
3 point lock linkage H 1200 mm	NSYBTAS3D120
Panels WM	References
50 caps for holes of hinges	NSYSWMCH
Set of 50 back plugs	NSYSWMBP

Steel wall-mounted enclosures S3DB



NSYSWMEL

Earthing accessories	References
Set of 500 earthing labels	NSYSWMEL
Locking accessories	References
Standard key DB3	NSYAEDLS3DKDB3
Panels	References
50 caps for holes of hinges WM	NSYSWMCH
Set of 50 back plugs WM	NSYSWMBP

Steel wall-mounted enclosures CRN



NSYDCRN22

Doors	References	Door accessories	References
Plain door H 200 x W 200	NSYDCRN22	Standard Spacial hinge	NSYBICRN
Plain door H 200 x W 300	NSYDCRN23	Earthing accessories	References
Plain door H 250 x W 200	NSYDCRN2520	Set of 500 earthing labels	NSYSWMEL
Plain door H 300 x W 250	NSYDCRN3025	Locking accessories	References
Plain door H 300 x W 300	NSYDCRN33	TCRE1 Lock	NSYTCRE1
Plain door H 300 x W 400	NSYDCRN34	TCRE12 Lock	NSYTCRE12
Plain door H 300 x W 450	NSYDCRN3045	Platten	References
Plain door H 400 x W 300	NSYDCRN43	Set of 50 back plugs WM	NSYSWMBP
Plain door H 400 x W 400	NSYDCRN44	Fixing hardware	References
Plain door H 400 x W 600	NSYDCRN46	Screw bag for CRN cable gland plate	NSYCRNCGPSTDSB
Plain door H 500 x W 400	NSYDCRN54	Sealing	References
Plain door H 500 x W 500	NSYDCRN55	Adhesive sealing gasket 18 x 10 2M	NSYADG2M
Plain door H 600 x W 400	NSYDCRN64	Adhesive sealing gasket 18 x 10 3M	NSYADG3M
Plain door H 600 x W 500	NSYDCRN65	Adhesive sealing gasket 18 x 10 5M	NSYADG5M
Plain door H 600 x W 600	NSYDCRN66	Adhesive sealing gasket 18 x 10 20M	NSYADG20M
Plain door H 600 x W 800	NSYDCRN68		
Plain door H 700 x W 500	NSYDCRN75		
Plain door H 800 x W 600	NSYDCRN86		
Plain door H 800 x W 800	NSYDCRN88		
Plain door H 1000 x W 600	NSYDCRN106		
Plain door H 1000 x W 800	NSYDCRN108		

Steel wall-mounted enclosures CRNG



NSYDCRNG86

Doors	References	Door accessories	References
Plain door H 800 x W 600	NSYDCRNG86	Hinge 120°	NSYAEDH120S3D
Plain door left H 800 x W 500	NSYDCRNG85L	Hinge 180°	NSYAEDH180S3D
Plain door right H 800 x W 500	NSYDCRNG85R	Locking accessories	References
Plain door left H 800 x W 600	NSYDCRNG86L	3 point lock linkage for Spacial CRNG (H = 800 mm)	NSYBTACRNG80
Plain door right H 800 x W 600	NSYDCRNG86R	3 point lock linkage for Spacial CRNG (H = 1000 mm)	NSYBTACRNG100
Plain door H 1000 x W 600	NSYDCRNG106	3 point lock linkage for Spacial CRNG (H = 1200 mm)	NSYBTACRNG120
Plain door H 1000 x W 800	NSYDCRNG108	3 point lock linkage for Spacial CRNG (H = 1400 mm)	NSYBTACRNG140
Plain door left H 1000 x W 500	NSYDCRNG105L	Earthing accessories	References
Plain door right H 1000 x W 500	NSYDCRNG105R	Set of 500 earthing labels	NSYSWMEL
Plain door right H 1000 x W 600	NSYDCRNG106R	Fixing hardware cable gland plate	References
Plain door left H 1000 x W 600	NSYDCRNG106L	100 screws	NSYS3DCGSB
Plain door right H 1000 x W 600	NSYDCRNG106R	Standard screw bag	NSYS3DCGPSTDSB
Plain door left H 1000 x W 600	NSYDCRNG106L	Panels	References
Plain door H 1200 x W 600	NSYDCRNG126	50 caps for holes of hinges WM	NSYSWMCH
Plain door H 1200 x W 600	NSYDCRNG126	Set of 50 back plugs WM	NSYSWMBP
Plain door H 1200 x W 800	NSYDCRNG128	Others accessories	References
Plain door H 1200 x W 800	NSYDCRNG128	Screw bag for CRN cable gland plate	NSYCRNCGPSTDSB
Plain door right H 1200 x W 500	NSYDCRNG125R		
Plain door left H 1200 x W 500	NSYDCRNG125L		
Plain door right H 1200 x W 500	NSYDCRNG125R		
Plain door left H 1200 x W 500	NSYDCRNG125L		
Plain door H 1200 x W 600	NSYDCRNG126R		
Plain door left H 1200 x W 600	NSYDCRNG126L		
Plain door H 1200 x W 600	NSYDCRNG126R		
Plain door left H 1200 x W 600	NSYDCRNG126L		
Plain door right H 1400 x W 500	NSYDCRNG145R		
Plain door left H 1400 x W 500	NSYDCRNG145L		

Steel floor-standing enclosures SF



NSYDFD207

Door accessories	References	Fixing hardware	References
Set of 4 Hinges and fixing elements	NSYDHSF	Captive screws for panels external fixing	NSYCSSF
Double-door stoppers (2 pieces)	NSYDSSF2D	Plinth accessories	
Locking accessories		References	
Locking system for enclosures, single-door version 1200H (right side door for double-door version)	NSYLCK12SF	H 100 mm Plastic covers for plinth corners	NSYPC100
Locking system for enclosures, single-door version 1600H (right side door for double-door version)	NSYLCK14SF	H 200 mm Plastic covers for plinth corners	NSYPC200
Locking system for enclosures, single-door version 1800H (right side door for double-door version)	NSYLCK16SF	Installation accessories	
Locking system for enclosures, single-door version 1800H (right side door for double-door version)	NSYLCK18SF	Set of 2 quick cross-rails 120 x 400 mm	NSYSQCR12040
Locking system for enclosures, single-door version 2000H (right side door for double-door version)	NSYLCK20SF	Set of 2 quick cross-rails 120 x 500 mm	NSYSQCR12050
Locking system for enclosures, single-door version 2200H (right side door for double-door version)	NSYLCK22SF	Set of 2 quick cross-rails 120 x 600 mm	NSYSQCR12060
Door locking system toothed washer	NSYLCKWSF	Set of 2 quick cross-rails 120 x 800 mm	NSYSQCR12080
Handle neutral trim	NSYSFHNTTRIM	Panels	
Handle SF	NSYSFHS1	PrismaSeT back panel H 2000 x W 700 mm	NSYBP207



NSYRSF35



NSYRSF35L

Roof	New roof (expanded)	Old roof (integrated)	"New roof" accessory	References
Roof W 300 x D 500 mm	NSYRSF35L	NSYRSF35	Fixed roof off-center bracket for PrismaSeT	NSYRSFBLR
Roof W 300 x D 600 mm	NSYRSF36L	NSYRSF36	Fixing elements SF enlarged roof	NSYRSFLFIX
Roof W 300 x D 800 mm	NSYRSF38L	NSYRSF38		
Roof W 400 x D 400 mm	NSYRSF44L	NSYRSF44		
Roof W 400 x D 500 mm	NSYRSF45L	NSYRSF45		
Roof W 600 x D 400 mm	NSYRSF64L	NSYRSF64		
Roof W 600 x D 500 mm	NSYRSF65L	NSYRSF65		
Roof W 600 x D 600 mm	NSYRSF66L	NSYRSF66		
Roof W 800 x D 400 mm	NSYRSF84L	NSYRSF84		
Roof W 800 x D 500 mm	NSYRSF85L	NSYRSF85		
Roof W 800 x D 600 mm	NSYRSF86L	NSYRSF86		
Roof W 800 x D 800 mm	NSYRSF88L	NSYRSF88		
Roof W 1000 x D 400 mm	NSYRSF104L	NSYRSF104		
Roof W 1000 x D 500 mm	NSYRSF105L	NSYRSF105		
Roof W 1000 x D 600 mm	NSYRSF106L	NSYRSF106		
Roof W 1000 x D 800 mm	NSYRSF108L	NSYRSF108		
Roof W 1200 x D 400 mm	NSYRSF124L	NSYRSF124		
Roof W 1200 x D 500 mm	NSYRSF125L	NSYRSF125		
Roof W 1200 x D 600 mm	NSYRSF126L	NSYRSF126		
Roof W 1200 x D 800 mm	NSYRSF128L	NSYRSF128		
Roof W 1600 x D 400 mm	NSYRSF164L	NSYRSF164		
Roof W 1600 x D 500 mm	NSYRSF165L	NSYRSF165		
Roof W 1600 x D 600 mm	NSYRSF166L	NSYRSF166		

Steel floor-standing enclosures SM



NSYSMEC1041

Cable gland plates	References	Door accessories	References
1 entry W 1000 x D 400 mm	NSYSMEC1041	Set of 4 hinges and fixing elements	NSYDHSF
1 entry W 1000 x D 300 mm	NSYSMEC1031	Spacial SM hinges and 2D door stop	NSYDHSM2D
1 entry W 1000 x D 500 mm	NSYSMEC1051	Double-door stoppers (2 pieces)	NSYTDSSF2D
1 entry W 600 x D 300 mm	NSYSMEC631	Locking accessories	References
1 entry W 600 x D 400 mm	NSYSMEC641	Locking system for enclosures, single-door version 1200H (right side door for double-door version)	NSYLCK12SF
1 entry W 600 x D 500 mm	NSYSMEC651	Locking system for enclosures, single-door version 1600H (right side door for double-door version)	NSYLCK16SF
1 entry W 600 x D 600 mm	NSYSMEC661	Locking system for enclosures, single-door version 1800H (right side door for double-door version)	NSYLCK18SF
1 entry W 800 x D 300 mm	NSYSMEC831	Locking system for enclosures, single-door version 2000H (right side door for double-door version)	NSYLCK20SF
1 entry W 800 x D 400 mm	NSYSMEC841	Locking system for enclosures, single-door version 2200H (right side door for double-door version)	NSYLCK22SF
1 entry W 800 x D 500 mm	NSYSMEC851	Locking system for enclosures, 1 single-door version 1400H	NSYLCK14SF
1 entry W 800 x D 600 mm	NSYSMEC861	Door locking system toothed washer	NSYLCKWSF
Doors	Old roof integrated)	Handle neutral trim	NSYSFHNTTRIM
Double plain door H 1200 x W 1000 mm	NSYSMD12102D	Plinth accessories	References
Double plain door H 1200 x W 1200 mm	NSYSMD12122D	H 100 mm Plastic covers for plinth corners	NSYPC100
Double plain door H 1400 x W 1000 mm	NSYSMD14102D	H 200 mm Plastic covers for plinth corners	NSYPC200
Double plain door H 1400 x W 1200 mm	NSYSMD14122D		
Double plain door H 1600 x W 1000 mm	NSYSMD16102D		
Double plain door H 1600 x W 1200 mm	NSYSMD16122D		
Double plain door H 1800 x W 1600 mm	NSYSMD18162D		

Spare Parts Selection Table

Stainless-steel enclosuresS3X (wall-mounted)



NSYDS3X1010L

Doors	References
Left door 304L for enclosure H1000 x W1000 mm	NSYDS3X1010L
Left door 316L for enclosure H1000 x W1000 mm	NSYDS3X1010LH
Right door 304L for enclosure H1000 x W1000 mm	NSYDS3X1010R
Right door 316L for enclosure H1000 x W1000 mm	NSYDS3X1010RH
Plain door 304L for enclosure H1000 x W800 mm	NSYDS3X108
Plain door 316L for enclosure H1000 x W800 mm	NSYDS3X108H
Left door 304L for enclosure H1200 x W1000 mm	NSYDS3X1210L
Left door 316L for enclosure H1200 x W1000 mm	NSYDS3X1210LH
Right door 304L for enclosure H1200 x W1000 mm	NSYDS3X1210R
Right door 316L for enclosure H1200 x W1000 mm	NSYDS3X1210RH
Plain door 304L for enclosure H1200 x W800 mm	NSYDS3X128
Plain door 316L for enclosure H1200 x W800 mm	NSYDS3X128H
Plain door 304L for enclosure H300 x W200 mm	NSYDS3X32
Plain door 304L for enclosure H300 x W250 mm	NSYDS3X325
Plain door 316L for enclosure H300 x 250 mm	NSYDS3X325H
Plain door 316L for enclosure H300 x W200 mm	NSYDS3X32H
Plain door 304L for enclosure H300 x W300 mm	NSYDS3X33
Plain door 316L for enclosure H300 x W300 mm	NSYDS3X33H
Plain door 304L for enclosure H400 x W300 mm	NSYDS3X43
Plain door 316L for enclosure H400 x W300 mm	NSYDS3X43H
Plain door 304L for enclosure H400 x W400 mm	NSYDS3X44
Plain door 316L for enclosure H400 x W400 mm	NSYDS3X44H
Plain door 304L for enclosure H400 x W600 mm	NSYDS3X46

Doors	References
Plain door 316L 400 x 600 mm	NSYDS3X46H
Plain door 304L 500 x 400 mm	NSYDS3X54
Plain door 316L 500 x 400 mm	NSYDS3X54H
Plain door 304L 600 x 400 mm	NSYDS3X64
Plain door 316L 600 x 400 mm	NSYDS3X64H
Plain door 304L 600 x 600 mm	NSYDS3X66
Plain door 316L 600 x 600 mm	NSYDS3X66H
Plain door 304L 700 x 500 mm	NSYDS3X75
Plain door 316L 700 x 500 mm	NSYDS3X75H
Plain door 304L 800 x 600 mm	NSYDS3X86
Plain door 316L 800 x 600 mm	NSYDS3X86H
Plain door 304L 800 x 800 mm	NSYDS3X88
Plain door 316L 800 x 800 mm	NSYDS3X88H
Transp. door 304L 1000 x 800 mm	NSYDS3X108T
Transp. door 304L 400 x 300 mm	NSYDS3X43T
Transp. door 304L 500 x 400 mm	NSYDS3X54T
Transp. door 304L 600 x 400 mm	NSYDS3X64T
Transp. door 304L 700 x 500 mm	NSYDS3X75T
Transp. door 304L 800 x 600 mm	NSYDS3X86T
Door accessories	References
Set of 2 hinges	NSYHS3X
Locking accessories	References
Locking system 1000 mm	NSYLSS3X10
Locking system 1200 mm	NSYLSS3X12

Stainless-steel enclosuresSMX ((floor-standing)



NSYDSFX1410L

Doors	References
Left door 304L for enclosure H1400 x W1000 mm	NSYDSFX1410L
Right door 304L for enclosure H1400 x W1000 mm	NSYDSFX1410R
Door 304L for enclosure H1600 x W800 mm	NSYDSFX168
Door 304L for enclosure H1800 x W600 mm	NSYDSFX186
Left door for enclosure H1800 x W1200 mm	NSYDSFX1812L
Left door 316L for enclosure H1800 x W1200 mm	NSYDSFX1812LH
Right door for enclosure H1800 x W1200 mm	NSYDSFX1812R
Right door 316L for enclosure H1800 x W1200 mm	NSYDSFX1812RH
Door 304L for enclosure H1800 x W800 mm	NSYDSFX188
Door 316L for enclosure H1800 x W800 mm	NSYDSFX188H
Left door 304L for enclosure H1800 x W1600 mm	NSYDSFX1816L
Left door 316L for enclosure H1800 x W1600 mm	NSYDSFX1816LH
Right door 304L for enclosure H1800 x W1600 mm	NSYDSFX1816R
Right door 316L for enclosure H1800 x W1600 mm	NSYDSFX1816RH
Left door for enclosure H2000 x W1000 mm	NSYDSFX2010L
Left door 316L for enclosure H2000 x W1000 mm	NSYDSFX2010LH
Right door for enclosure H2000 x W1000 mm	NSYDSFX2010R
Right door 316L for enclosure H2000 x W1000 mm	NSYDSFX2010RH
Door for enclosure H1800 x W800 mm	NSYDSFX206
Left door for enclosure H2000 x W1200 mm	NSYDSFX2012L
Left door 316L for enclosure H2000 x W1200 mm	NSYDSFX2012LH
Right door for enclosure H2000 x W1200 mm	NSYDSFX2012R
Right door 316L for enclosure H2000 x W1200 mm	NSYDSFX2012RH
Door for enclosure H2000 x W800 mm	NSYDSFX208
Left for enclosure door H2000 x W1600 mm	NSYDSFX2016L
Left door 316L for enclosure H2000 x W1600 mm	NSYDSFX2016LH
Right door for enclosure H2000 x W1600 mm SMX	NSYDSFX2016R
Right door 316L for enclosure H2000 x W1600 mm	NSYDSFX2016RH

Locking system	References
Locking system H = 1400 mm	NSYLSSF14
Locking system H = 1600 mm	NSYLSSF16
Locking system H = 1800 mm	NSYLSSF18
Locking system H = 2000 mm	NSYLSSF20
Door accessories	References
Double-door stoppers (2 pieces)	NSYTDSSF2D

Stainless-steel enclosures SFX (floor-standing)



NSYDSFX186

Doors	References
Door 304L for enclosure H1800 x W600 mm	NSYDSFX186
Left door for enclosure H1800 x W1200 mm	NSYDSFX1812L
Right door for enclosure H1800 x W1200 mm	NSYDSFX1812R
Door 304L for enclosure H1800 x W800 mm	NSYDSFX188
Left door for enclosure H2000 x W1000 mm	NSYDSFX2010L
Right door for enclosure H2000 x W1000 mm	NSYDSFX2010R
Door for enclosure H1800 x W800 mm	NSYDSFX206
Left door for enclosure H2000 x W1200 mm	NSYDSFX2012L
Right door for enclosure H2000 x W1200 mm	NSYDSFX2012R
Door for enclosure H2000 x W800 mm	NSYDSFX208
Left door for enclosure H2000 x W1600 mm	NSYDSFX2016L
Right door for enclosure H2000 x W1600 mm	NSYDSFX2016R

Door accessories	References
Set of 3 hinges	NSYHSMX
Double-door stoppers (2 pieces)	NSYTDSSF2D
Locking accessories	References
Locking system H = 1400 mm	NSYLSSF14
Locking system H = 1600 mm	NSYLSSF16
Locking system H = 1800 mm	NSYLSSF18
Locking system H = 2000 mm	NSYLSSF20

Insulated materials PLA (floor-standing)



NSYDPLA55G

- For RAL 7035

Doors	References
Door 500 x 500 Lock handle type. Door opening 120°	NSYDPLA55G
Door 500 x 750 Lock handle type. Door opening 120°	NSYDPLA57G
Door 750 x 500 Lock handle type. Door opening 120°	NSYDPLA75G
Door 750 x 750 Lock handle type. Door opening 120°	NSYDPLA77G
Door 1000 x 500 Lock handle type. Door opening 120°	NSYDPLA105G
Door 1000 x 750 Lock handle type. Door opening 120°	NSYDPLA107G
Door 1250 x 500 Lock handle type. Door opening 120°	NSYDPLA125G
Door 1250 x 750 Lock handle type. Door opening 120°	NSYDPLA127G
Door 1500 x 500 Lock handle type. Door opening 120°	NSYDPLA155G
Door 1500 x 750 Lock handle type. Door opening 120°	NSYDPLA157G
Door 500 x 500 Lock handle type. Door opening 180° + Accessory bag 120° hinge	NSYDPLA55HG
Door 500 x 750 Lock handle type. Door opening 180° + Accessory bag 120° hinge	NSYDPLA57HG
Door 750 x 500 Lock handle type. Door opening 180° + Accessory bag 120° hinge	NSYDPLA75HG
Door 750 x 750 Lock handle type. Door opening 180° + Accessory bag 120° hinge	NSYDPLA77HG
Door 1000 x 500 Lock handle type. Door opening 180° + Accessory bag 120° hinge	NSYDPLA105HG
Door 1000 x 750 Lock handle type. Door opening 180° + Accessory bag 120° hinge	NSYDPLA107HG
Door 1250 x 500 Lock handle type. Door opening 180° + Accessory bag 120° hinge	NSYDPLA125HG
Door 1250 x 750 Lock handle type. Door opening 180° + Accessory bag 120° hinge	NSYDPLA127HG

- For RAL 7035

Doors	References
Door 1500 x 500 Lock handle type. Door opening 180° + Accessory bag 120° hinge	NSYDPLA155HG
Door 1500 x 750 Lock handle type. Door opening 180° + Accessory bag 120° hinge	NSYDPLA157HG
Door accessories	References
One hinge + axe for PLA (120° opening)	NSYAEDPLA004
Kit of axes of door PLAZT (180° opening)	NSYAEDPLA005
Rod guide inside the door PLA (set of 2)	NSYAEDPLA001
Rod guide on 1 door PLA (set of 2)	NSYAEDPLA002G
Rod guide on 2 doors PLA (set of 2)	NSYAEDPLA003G
Fixing hardware	References
Acc. bag for 1 door H = 500-1000 mm	NSYASPLA001
Acc. bag for 2 door H = 1250-1500 mm	NSYASPLA002
Acc. bag for 2 door	NSYASPLA003
Locking accessories	References
Handle locking and rods H = 500 mm	NSYVPLA5MG
Handle locking and rods H = 750 mm	NSYVPLA7MG
Handle locking and rods H = 1000 mm	NSYVPLA10MG
Handle locking and rods H = 1250 mm	NSYVPLA12MG
Handle locking and rods H = 1500 mm	NSYVPLA15MG

Insulated materials PLM (wall-mounted)

- For RAL 7035



NSYDPLM32G

Complete door (door + lock system)	References	Door accessories	References
Door with locking for PLM32	NSYDPLM32G	Door hinge for NSYPLM32	NSYAEDHPLM32
Door with locking for 2 locks PLM3025	NSYDPLM3025G	Door hinge for NSYPLM3025 for 2 locks door	NSYAEDHPLM3025
Door with locking for PLM43	NSYDPLM43G	Door hinge for NSYPLM43 to 86	NSYAEDHPLM
Door with locking for PLM54	NSYDPLM54G	Door hinge for NSYPLM108	NSYAEDHPLM108
Door with locking for PLM64	NSYDPLM64G	Rod guides (4 pieces) for PLM108	NSYAEDHPLM108
Door with locking for PLM75	NSYDPLM75G	Fixing hardware	References
Door with locking for PLM86	NSYDPLM86G	Acc. bag NSYPLM32	NSYASPLM32
Door with locking for PLM108	NSYDPLM108G	Acc. bag NSYPLM43 to 86	NSYASPLM
Transp. door with locking for PLM32T	NSYDPLM32TG	Locking accessories	References
Glazed door with locking for PLM3025T	NSYDPLM3025TG	Locking and rods for NSYPLM108	NSYVPLM108
Glazed door with locking for PLM43T	NSYDPLM43TG	Double-bar lock for PLM enclosures from 430 to 847 mm high	NSYCDBPLM
Glazed door with locking for PLM54T	NSYDPLM54TG		
Glazed door with locking for PLM64T	NSYDPLM64TG		
Glazed door with locking for PLM75T	NSYDPLM75TG		
Glazed door with locking for PLM86T	NSYDPLM86TG		
Glazed door with locking for PLM108T	NSYDPLM108TG		

Applicative and customized solutions: HMI SD



NSYCCSDF8

Doors	References	Door accessories	References
Desk lid W 600 mm	NSYDLSDF6	Hinges compact control desk	NSYHSD
Desk lid W 800 mm	NSYDLSDF8	Hinges control desk w/console	NSYHSDF
Desk lid W 1000 mm	NSYDLSDF10	Locking accessories	References
Desk lid W 1200 mm	NSYDLSDF12	Standard handle in RAL 7011 (previous version)	NSYSDH
Desk lid for w/console W 800 mm	NSYDLSDF8	Handle rear door (new version)	NSYBTACRNG140
Desk lid for w/console W 1000 mm	NSYDLSDF10	Lock w/DB 3 mm for frontal doors	NSYFDLSD
Desk lid for w/console W 1200 mm	NSYDLSDF12	Lock w/DB 3 mm desk lids and covers	NSYDLSDF
Desk lid for w/console W 1600 mm	NSYDLSDF16	Flat escutcheon with DB 5 mm	NSYSDFLOCKDB5
Folding console cover W 800 mm	NSYCCSDF8		
Folding console cover W 1000 mm	NSYCCSDF10		
Folding console cover W 1200 mm	NSYCCSDF12		
Folding console cover W 1600 mm	NSYCCSDF16		

Applicative and customized solutions: HMI

Door accessories	References
Locking system	NSYLSSDX

Applicative and customized solutions: S3CM

Doors	References	Door accessories	References
Plain door H 200 x W 200	NSYDCRN22	Standard Spacial hinge	NSYBICRN
Plain door H 200 x W 300	NSYDCRN23	Earthing accessories	References
Plain door H 250 x W 200	NSYDCRN2520	Set of 500 earthing labels	NSYSWMEL
Plain door H 300 x W 250	NSYDCRN3025		
Plain door H 300 x W 300	NSYDCRN33		
Plain door H 300 x W 400	NSYDCRN34		
Plain door H 300 x W 450	NSYDCRN3045		
Plain door H 400 x W 300	NSYDCRN43		
Plain door H 400 x W 400	NSYDCRN44		
Plain door H 400 x W 600	NSYDCRN46		
Plain door H 500 x W 500	NSYDCRN55		
Plain door H 600 x W 600	NSYDCRN66		
Plain door H 600 x W 800	NSYDCRN68		
Plain door H 800 x W 600	NSYDCRN86		

Applicative and customized solutions: EMC, S3HF



NSYSWMEL

Earthing accessories	References
Set of 500 earthing labels	NSYSWMEL
Locking accessories	References
Standard Locking system	NSYAEDLS3HFDB3

Applicative and customized solutions: ATEX S3DEX



NSYDS3D32

Doors	References
Plain door 300 x 200	NSYDS3D32
Plain door 300 x 300	NSYDS3D33
Plain door 400 x 300	NSYDS3D43
Plain door 400 x 400	NSYDS3D44
Plain door 500 x 400	NSYDS3D54
Plain door 600 x 400	NSYDS3D64
Plain door 600 x 600	NSYDS3D66
Plain door 700 x 500	NSYDS3D75
Plain door 800 x 600	NSYDS3D86
Plain door 1000 x 800	NSYDS3D108
Earthing accessories	References
Set of 500 earthing labels	NSYSWMEL

Locking accessories	References
Set of 10 linkage guides	NSYS3DLG
Standard key DB3	NSYAEDLS3DKDB3
3 point lock linkage H 600 mm	NSYBTAS3D60
3 point lock linkage H 700 mm	NSYBTAS3D70
3 point lock linkage H 800 mm	NSYBTAS3D80
3 point lock linkage H 1000 mm	NSYBTAS3D100
Panels	References
50 caps for holes of hinges WM	NSYSWMCH
Set of 50 back plugs WM	NSYSWMBP

Outdoor heavy-duty enclosures Thalassa PHD



NSYPPC74HD

Plain doors (door + lock + hinges + door retainer)	Unic door or right door References	Left door References
H 538 x W 500	NSYDPHD55P	-
H 788 x W 500	NSYDPHD75P	-
H 843 x W 750	NSYDPHD77P	-
H 1093 x W 500	NSYDPHD105P	-
H 1093 x W 750	NSYDPHD107P	-
H 1343 x W 500	NSYDPHD125P	-
H 1343 x W 750	NSYDPHD127P	-
H 1343 x W 1250	NSYDPHD127P	NSYDPHD125LP
H 1593 x W 750	NSYDPHD157P	-
H 1593 x W 1250	NSYDPHD157P	NSYDPHD155LP
H 2093 x W 750	2 x NSYDPHD107P	-
Ribbed doors (door + lock + hinges + door retainer)	References	References
H 538 x W 500	NSYDPHD55R	-
H 788 x W 500	NSYDPHD75R	-
H 843 x W 750	NSYDPHD77R	-
H 1093 x W 500	NSYDPHD105R	-
H 1093 x W 750	NSYDPHD107R	-
H 1343 x W 500	NSYDPHD125R	-
H 1343 x W 750	NSYDPHD127R	-
H 1343 x W 1250	NSYDPHD127R	NSYDPHD125LR
H 1593 x W 750	NSYDPHD157R	-
H 1593 x W 1250	NSYDPHD157R	NSYDPHD155LR
H 2093 x W 750	2 x NSYDPHD107R	-

Aluminum cable gland plate	References
For enclosure W 750 x D 420	NSYPPC74HD
For enclosure W 750 x D 620	NSYPPC76HD
For enclosure W 500 x D 420	NSYPPC54HD
For enclosure W 1250 x D 420	NSYPPC54HD + NSYPPC74HD
For enclosure W 1250 x D 620	NSYPPC56HD + NSYPPC76HD
Screws and nuts for PHD gland plate (10 units)	NSYPPCPHDSN

Door accessories	References
Set of 4 complete hinges for PHD	NSYAEDPHD

Locking accessories	References
Complete lock system for PHD H 500	NSYVPHD5
Complete lock system for PHD H 750	NSYVPHD7
Complete lock system for PHD H 1000	NSYVPHD10
Complete lock system for PHD H 1250	NSYVPHD12
Complete lock system for PHD H 1500	NSYVPHD15
Complete lock system for PHD H 2000	2 x NSYVPHD10

Outdoor heavy-duty enclosures Spacial S3HD

Heavy-Duty cable gland plate for enclosure	References	Hinge	References
H 343 x W 200 x D 180	NSYTLAUHD	S3HD hinge	NSYAEHD120S3HD
H 448 x W 300 x D 230	NSYTLCUHD	Canopy	References
H 548 x W 400 x D 230	NSYTLDUHD	Canopy for S3HD 200 (W) x 150 (P)	NSYTJ2015HD
H 653 x W 400 x D 280	NSYTLDUHD	Canopy for S3HD 300 (W) x 200 (P)	NSYTJ3020HD
H 658 x W 600 x D 330	NSYTLGUHD	Canopy for S3HD 400 (W) x 200 (P)	NSYTJ4020HD
H 753 x W 500 x D 280	NSYTLGUHD	Canopy for S3HD 400 (W) x 250 (P)	NSYTJ4025HD
e H 858 x W 600 x D 330	NSYTLGUHD	Canopy for S3HD 600 (W) x 300 (P)	NSYTJ6030HD
H 862 x W 800 x D 430	2 x NSYTLDUHD	Canopy for S3HD 500 (W) x 250 (P)	NSYTJ5025HD
H 1062 x W 600 x D 430	NSYTLGUHD	Canopy for S3HD 800 (W) x 400 (P)	NSYTJ8040HD
H 1062 x W 800 x D 430	2 x NSYTLDUHD	Canopy for S3HD 600 (W) x 400 (P)	NSYTJ6040HD
Door	References	Lock	References
Door 300 x 200 S3HD, without handle	NSYDS3HD32	Lock S3HD DB 3 mm (Escutcheon+cam+washer)	NSYAECLS3HDRL
Door 400 x 300 S3HD, without handle	NSYDS3HD43		
Door 500 x 400 S3HD, without handle	NSYDS3HD54		
Door 600 x 400 S3HD + linkage locking syst	NSYDS3HD64		
Door 600 x 600 S3HD + linkage locking syst	NSYDS3HD66		
Door 700 x 500 S3HD + linkage locking syst	NSYDS3HD75		
Door 800 x 600 S3HD + linkage locking syst	NSYDS3HD86		
Door 800 x 800 S3HD + linkage locking syst	NSYDS3HD88		
Door 1000 x 600 S3HD + linkage locking syst	NSYDS3HD106		
Door 1000 x 800 S3HD + linkage locking syst	NSYDS3HD108		







Outdoor heavy-duty enclosures Spacial SFHD





Heavy-Duty cable gland plate for enclosure	References	Back Panel	References
H 1262 x W 600 x D 430	NSYSFECA64HD	SFHD 1200 x 600 mm	NSYBPHD126
H 1262 x W 800 x D 430	NSYSFECA64HD	SFHD 1200 x 800 mm	NSYBPHD128
H 1262 x W 1200 x D 430	2 x NSYSFECA64HD	SFHD 1200 x 1200 mm	NSYBPHD12122D
H 1281 x W 600 x D 630	NSYSFECA66HD	SFHD 1600 x 600 mm	NSYBPHD166
H 1281 x W 800 x D 630	NSYSFECA66HD	SFHD 1600 x 800 mm	NSYBPHD168
H 1281 x W 1200 x D 630	2 x NSYSFECA66HD	SFHD 1600 x 1200 mm	NSYBPHD1612
H 1662 x W 800 x D 430	NSYSFECA64HD	SFHD 2000 x 800 mm	NSYBPHD208
H 1662 x W 1200 x D 430	2 x NSYSFECA64HD	Canopy	References
H 1681 x W 600 x D 630	NSYSFECA66HD	SFHD 600 x 400 mm	NSYSC64HD
H 1681 x W 800 x D 630	NSYSFECA66HD	SFHD 600 x 600 mm	NSYSC66HD
H 1681 x W 1200 x D 630	2 x NSYSFECA66HD	SFHD 800 x 400 mm	NSYSC84HD
H 2062 x W 800 x D 430	NSYSFECA64HD	SFHD 800 x 600 mm	NSYSC86HD
Door	References	SFHD 1200 x 400 mm	NSYSC124HD
Plain door SFHD 1200 x 600 mm	NSYSFDHD126	SFHD 1200 x 600 mm	NSYSC126HD
Plain door SFHD 1200 x 800 mm	NSYSFDHD128	Handle with 1242E cylindrical barrel	References
Plain door SFHD 1200 x 1200 mm	NSYSFDHD12122D	Handle SFHD 1242E	NSYSFHS1HD
Plain door SFHD 1600 x 600 mm	NSYSFDHD166	Captive screws	References
Plain door SFHD 1600 x 800 mm	NSYSFDHD168	Captive screws for Spacial SFHD panels	NSYCSSFHD
Plain door doble SFHD 1600 x 1200 mm	NSYSFDHD16122D		
Plain door SFHD 2000 x 800 mm	NSYSFDHD208		

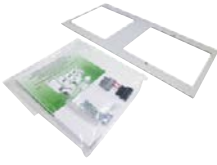

Air-AIR exchangers

				
Exchanger Battery	Fan (Fan + Capacitor)	Frontal Cover RAL 7035 grey	Thermostat	Mounting Kit (instruction + full seal + screws)
References	References	References	References	References
NSYCEA14E	NSYCUSP0030	NSYCUSP0042	NSYCUSP0076	-
NSYCEA22E	NSYCUSP0177	NSYCUSP0042	NSYCUSP0181	-
NSYCEA36	NSYCUSP0031	NSYCUSP0044	NSYCUSP0077	NSYCUSP0100
NSYCEA50	NSYCUSP0032	NSYCUSP0044	NSYCUSP0077	NSYCUSP0100
NSYCEA80	NSYCUSP0033	NSYCUSP0138	NSYCUSP0078	NSYCUSP0100
				NSYCUSP0111
				NSYCUSP0184
				NSYCUSP0112
				NSYCUSP0112
				NSYCUSP0113

Air-WATER exchangers

			
Exchanger Battery	Fan (Fan + Capacitor)	Frontal Cover RAL 7035 grey	Frontal Cover Stainless-steel
References	References	References	References
NSYCEW1K	NSYCUSP0034	NSYCUSP0043	NSYCUSP0079
NSYCEWX1K	NSYCUSP0034	NSYCUSP0043	-
NSYCEW1K8	NSYCUSP0035	NSYCUSP0044	NSYCUSP0080
NSYCEWX1K8	NSYCUSP0035	NSYCUSP0044	-
NSYCEW2K5	NSYCUSP0036	NSYCUSP0136	NSYCUSP0080
NSYCEWX2K5	NSYCUSP0036	NSYCUSP0136	-
NSYCEW3K5	NSYCUSP0037	NSYCUSP0138	NSYCUSP0081
NSYCEW4K5	NSYCUSP0037	NSYCUSP0137	NSYCUSP0081
NSYCEW6K	NSYCUSP0038	NSYCUSP0137	NSYCUSP0082
NSYCEW6K2P4	NSYCUSP0038	NSYCUSP0137	NSYCUSP0082
NSYCEW2K5R	NSYCUSP0041	NSYCUSP0053	NSYCUSP0084
			-
			NSYCUSP0094
			-
			NSYCUSP0095
			-
			NSYCUSP0095
			-
			-
			-
			-

Air-WATER exchangers



Thermostat

Transformer



Solenoid Valve



Mounting Kit
(instruction + full seal + screws)

References	References	References	References	References
NSYCEW1K	NSYCUSP0100	-	NSYCUSP0108	NSYCUSP0114
NSYCEWX1K	NSYCUSP0100	-	NSYCUSP0108	NSYCUSP0114
NSYCEW1K8	NSYCUSP0100	-	NSYCUSP0109	NSYCUSP0124
NSYCEWX1K8	NSYCUSP0100	-	NSYCUSP0109	NSYCUSP0124
NSYCEW2K5	NSYCUSP0100	-	NSYCUSP0109	NSYCUSP0124
NSYCEWX2K5	NSYCUSP0100	-	NSYCUSP0109	NSYCUSP0124
NSYCEW3K5	NSYCUSP0100	-	NSYCUSP0109	NSYCUSP0115
NSYCEW4K5	NSYCUSP0100	-	NSYCUSP0109	NSYCUSP0115
NSYCEW6K	NSYCUSP0100	-	NSYCUSP0109	NSYCUSP0125
NSYCEW6K2P4	NSYCUSP0100	NSYCUSP0107	NSYCUSP0109	NSYCUSP0125
NSYCEW2K5R	NSYCUSP0100	-	NSYCUSP0109	NSYCUSP0117

Cooling units: Side-mounted models

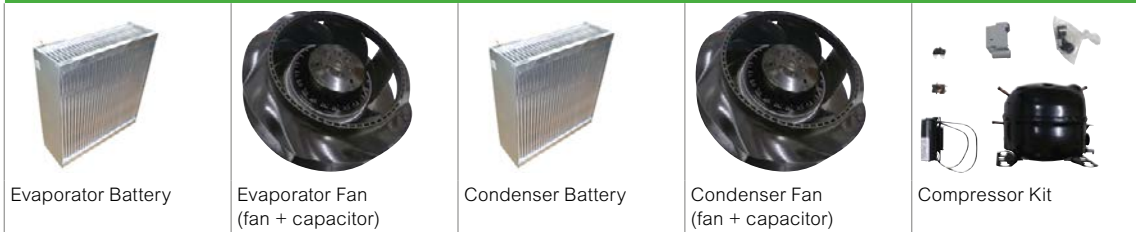

References	References	References	References	References	References
NSYCU300H	NSYCUSP0001	NSYCUSP0042	NSYCUSP0013	NSYCUSP0042	NSYCUSP0054
NSYCU400	NSYCUSP0002	NSYCUSP0042	NSYCUSP0014	NSYCUSP0042	NSYCUSP0055
NSYCU400UL	NSYCUSP0002	NSYCUSP0042	NSYCUSP0014	NSYCUSP0042	NSYCUSP0055
NSYCU400	NSYCUSP0002	NSYCUSP0042	NSYCUSP0014	NSYCUSP0042	NSYCUSP0055
NSYCU600	NSYCUSP0003	NSYCUSP0043	NSYCUSP0015	NSYCUSP0044	NSYCUSP0056
NSYCU600	NSYCUSP0003	NSYCUSP0043	NSYCUSP0015	NSYCUSP0044	NSYCUSP0056
NSYCU600UL	NSYCUSP0003	NSYCUSP0043	NSYCUSP0015	NSYCUSP0044	NSYCUSP0056
NSYCU800	NSYCUSP0004	NSYCUSP0043	NSYCUSP0016	NSYCUSP0044	NSYCUSP0057
NSYCU800	NSYCUSP0004	NSYCUSP0043	NSYCUSP0016	NSYCUSP0044	NSYCUSP0057
NSYCU800UL	NSYCUSP0004	NSYCUSP0043	NSYCUSP0016	NSYCUSP0044	NSYCUSP0057
NSYCU800UL	NSYCUSP0004	NSYCUSP0043	NSYCUSP0016	NSYCUSP0044	NSYCUSP0057
NSYCU1K	NSYCUSP0004	NSYCUSP0043	NSYCUSP0017	NSYCUSP0044	NSYCUSP0057
NSYCU1K	NSYCUSP0004	NSYCUSP0043	NSYCUSP0017	NSYCUSP0044	NSYCUSP0057
NSYCU1KUL	NSYCUSP0004	NSYCUSP0043	NSYCUSP0017	NSYCUSP0044	NSYCUSP0057
NSYCU1KUL	NSYCUSP0004	NSYCUSP0043	NSYCUSP0017	NSYCUSP0044	NSYCUSP0057
NSYCU1K2P4	NSYCUSP0004	NSYCUSP0043	NSYCUSP0017	NSYCUSP0044	NSYCUSP0057
NSYCU1K2P4	NSYCUSP0004	NSYCUSP0043	NSYCUSP0017	NSYCUSP0044	NSYCUSP0057
NSYCU1K2P4UL	NSYCUSP0004	NSYCUSP0043	NSYCUSP0017	NSYCUSP0044	NSYCUSP0057
NSYCU1K2P4UL	NSYCUSP0004	NSYCUSP0043	NSYCUSP0017	NSYCUSP0044	NSYCUSP0057
NSYCU1K2	NSYCUSP0005	NSYCUSP0044	NSYCUSP0018	NSYCUSP0136	NSYCUSP0058
NSYCU1K2	NSYCUSP0005	NSYCUSP0044	NSYCUSP0018	NSYCUSP0136	NSYCUSP0058
NSYCU1K2UL	NSYCUSP0005	NSYCUSP0044	NSYCUSP0018	NSYCUSP0136	NSYCUSP0058
NSYCU1K2UL	NSYCUSP0005	NSYCUSP0044	NSYCUSP0018	NSYCUSP0136	NSYCUSP0058
NSYCU1K22P4	NSYCUSP0005	NSYCUSP0044	NSYCUSP0018	NSYCUSP0136	NSYCUSP0058
NSYCU1K22P4	NSYCUSP0005	NSYCUSP0044	NSYCUSP0018	NSYCUSP0136	NSYCUSP0058
NSYCU1K6	NSYCUSP0006	NSYCUSP0044	NSYCUSP0019	NSYCUSP0138	NSYCUSP0059
NSYCU1K6	NSYCUSP0006	NSYCUSP0044	NSYCUSP0019	NSYCUSP0138	NSYCUSP0059
NSYCU1K6UL	NSYCUSP0006	NSYCUSP0044	NSYCUSP0019	NSYCUSP0138	NSYCUSP0059
NSYCU1K6UL	NSYCUSP0006	NSYCUSP0044	NSYCUSP0019	NSYCUSP0138	NSYCUSP0059
NSYCU1K62P4	NSYCUSP0006	NSYCUSP0044	NSYCUSP0019	NSYCUSP0138	NSYCUSP0059
NSYCU1K62P4	NSYCUSP0006	NSYCUSP0044	NSYCUSP0019	NSYCUSP0138	NSYCUSP0059
NSYCU1K62P4UL	NSYCUSP0006	NSYCUSP0044	NSYCUSP0019	NSYCUSP0138	NSYCUSP0059
NSYCU1K62P4UL	NSYCUSP0006	NSYCUSP0044	NSYCUSP0019	NSYCUSP0138	NSYCUSP0059

Cooling units: Side-mounted models

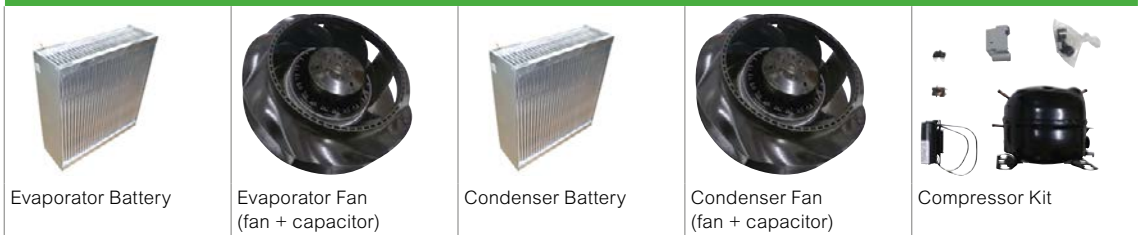

Evaporator Battery

Evaporator Fan
(fan + capacitor)

Condenser Battery

Condenser Fan
(fan + capacitor)

Compressor Kit

References	References	References	References	References	References
NSYCU2K	NSYCUSP0006	NSYCUSP0136	NSYCUSP0020	NSYCUSP0138	NSYCUSP0060
NSYCUX2K	NSYCUSP0006	NSYCUSP0136	NSYCUSP0020	NSYCUSP0138	NSYCUSP0060
NSYCU2KUL	NSYCUSP0006	NSYCUSP0136	NSYCUSP0020	NSYCUSP0138	NSYCUSP0139
NSYCUX2KUL	NSYCUSP0006	NSYCUSP0136	NSYCUSP0020	NSYCUSP0138	NSYCUSP0139
NSYCU2K3P4	NSYCUSP0006	NSYCUSP0136	NSYCUSP0020	NSYCUSP0138	NSYCUSP0061
NSYCUX2K3P4	NSYCUSP0006	NSYCUSP0136	NSYCUSP0020	NSYCUSP0138	NSYCUSP0061
NSYCU2K3P4UL	NSYCUSP0006	NSYCUSP0136	NSYCUSP0020	NSYCUSP0138	NSYCUSP0062
NSYCUX2K3P4UL	NSYCUSP0006	NSYCUSP0136	NSYCUSP0020	NSYCUSP0138	NSYCUSP0062
NSYCU3K3P4	NSYCUSP0007	NSYCUSP0137	NSYCUSP0021	NSYCUSP0137	NSYCUSP0062
NSYCUX3K3P4	NSYCUSP0007	NSYCUSP0137	NSYCUSP0021	NSYCUSP0137	NSYCUSP0062
NSYCU3K3P4UL	NSYCUSP0007	NSYCUSP0137	NSYCUSP0021	NSYCUSP0137	NSYCUSP0062
NSYCUX3K3P4UL	NSYCUSP0007	NSYCUSP0137	NSYCUSP0021	NSYCUSP0137	NSYCUSP0062
NSYCU4K3P4	NSYCUSP0007	NSYCUSP0137	NSYCUSP0022	NSYCUSP0137	NSYCUSP0063
NSYCUX4K3P4	NSYCUSP0007	NSYCUSP0137	NSYCUSP0022	NSYCUSP0137	NSYCUSP0063
NSYCU4K3P4UL	NSYCUSP0007	NSYCUSP0137	NSYCUSP0022	NSYCUSP0137	NSYCUSP0063
NSYCUX4K3P4UL	NSYCUSP0007	NSYCUSP0137	NSYCUSP0022	NSYCUSP0137	NSYCUSP0063
NSYCU6K3P4	-	-	-	-	-

Cooling units and side-mounted models



References	References	References	References	References	References
NSYCU300H	NSYCUSP0066	-	NSYCUSP0099	-	NSYCUSP0118
NSYCU400	NSYCUSP0067	-	NSYCUSP0099	-	NSYCUSP0126
NSYCU400UL	NSYCUSP0067	-	NSYCUSP0144	-	NSYCUSP0126
NSYCUX400	-	NSYCUSP0085	NSYCUSP0099	-	NSYCUSP0126
NSYCU600	NSYCUSP0068	-	NSYCUSP0099	-	NSYCUSP0127
NSYCUX600	-	NSYCUSP0086	NSYCUSP0099	-	NSYCUSP0127
NSYCU600UL	NSYCUSP0068	-	NSYCUSP0144	-	NSYCUSP0127
NSYCUX600UL	-	NSYCUSP0086	NSYCUSP0144	-	NSYCUSP0127
NSYCU800	NSYCUSP0069	-	NSYCUSP0099	-	NSYCUSP0119
NSYCUX800	-	NSYCUSP0087	NSYCUSP0099	-	NSYCUSP0119
NSYCU800UL	NSYCUSP0069	-	NSYCUSP0144	-	NSYCUSP0119
NSYCUX800UL	-	NSYCUSP0087	NSYCUSP0144	-	NSYCUSP0119
NSYCU1K	NSYCUSP0069	-	NSYCUSP0099	-	NSYCUSP0119
NSYCUX1K	-	NSYCUSP0087	NSYCUSP0099	-	NSYCUSP0119
NSYCU1KUL	NSYCUSP0069	-	NSYCUSP0144	-	NSYCUSP0119
NSYCUX1KUL	-	NSYCUSP0087	NSYCUSP0144	-	NSYCUSP0119
NSYCU1K2P4	NSYCUSP0069	-	NSYCUSP0099	NSYCUSP0101	NSYCUSP0119
NSYCUX1K2P4	-	NSYCUSP0087	NSYCUSP0099	NSYCUSP0101	NSYCUSP0119
NSYCU1K2P4UL	NSYCUSP0069	-	NSYCUSP0144	NSYCUSP0173	NSYCUSP0119
NSYCUX1K2P4UL	-	NSYCUSP0087	NSYCUSP0144	NSYCUSP0173	NSYCUSP0119
NSYCU1K2	NSYCUSP0070	-	NSYCUSP0099	-	NSYCUSP0120
NSYCUX1K2	-	NSYCUSP0088	NSYCUSP0099	-	NSYCUSP0120
NSYCU1K2UL	NSYCUSP0070	-	NSYCUSP0144	-	NSYCUSP0120
NSYCUX1K2UL	-	NSYCUSP0088	NSYCUSP0144	-	NSYCUSP0120
NSYCU1K22P4	NSYCUSP0070	-	NSYCUSP0099	NSYCUSP0102	NSYCUSP0120
NSYCUX1K22P4	-	NSYCUSP0088	NSYCUSP0099	NSYCUSP0102	NSYCUSP0120
NSYCU1K6	NSYCUSP0070	-	NSYCUSP0099	-	NSYCUSP0120
NSYCUX1K6	-	NSYCUSP0088	NSYCUSP0099	-	NSYCUSP0120
NSYCU1K6UL	NSYCUSP0070	-	NSYCUSP0144	-	NSYCUSP0120
NSYCUX1K6UL	-	NSYCUSP0088	NSYCUSP0144	-	NSYCUSP0120
NSYCU1K62P4	NSYCUSP0070	-	NSYCUSP0099	NSYCUSP0103	NSYCUSP0120
NSYCUX1K62P4	-	NSYCUSP0088	NSYCUSP0099	NSYCUSP0103	NSYCUSP0120
NSYCU1K62P4UL	NSYCUSP0070	-	NSYCUSP0144	NSYCUSP0174	NSYCUSP0120
NSYCUX1K62P4UL	-	NSYCUSP0088	NSYCUSP0144	NSYCUSP0174	NSYCUSP0120

Cooling units and side-mounted models



References	References	References	References	References	References
NSYCU2K	NSYCUSP0070	-	NSYCUSP0099	-	NSYCUSP0120
NSYCUX2K	-	NSYCUSP0088	NSYCUSP0099	-	NSYCUSP0120
NSYCU2KUL	NSYCUSP0070	-	NSYCUSP0144	-	NSYCUSP0120
NSYCUX2KUL	-	NSYCUSP0088	NSYCUSP0144	-	NSYCUSP0120
NSYCU2K3P4	NSYCUSP0070	-	NSYCUSP0099	NSYCUSP0104	NSYCUSP0120
NSYCUX2K3P4	-	NSYCUSP0088	NSYCUSP0099	NSYCUSP0104	NSYCUSP0120
NSYCU2K3P4UL	NSYCUSP0070	-	NSYCUSP0144	NSYCUSP0147	NSYCUSP0120
NSYCUX2K3P4UL	-	NSYCUSP0088	NSYCUSP0144	NSYCUSP0147	NSYCUSP0120
NSYCU3K3P4	NSYCUSP0071	-	NSYCUSP0099	NSYCUSP0105	NSYCUSP0128
NSYCUX3K3P4	-	NSYCUSP0089	NSYCUSP0099	NSYCUSP0105	NSYCUSP0128
NSYCU3K3P4UL	NSYCUSP0071	-	NSYCUSP0144	NSYCUSP0148	NSYCUSP0128
NSYCUX3K3P4UL	-	NSYCUSP0089	NSYCUSP0144	NSYCUSP0148	NSYCUSP0128
NSYCU4K3P4	NSYCUSP0071	-	NSYCUSP0099	NSYCUSP0105	NSYCUSP0128
NSYCUX4K3P4	-	NSYCUSP0089	NSYCUSP0099	NSYCUSP0105	NSYCUSP0128
NSYCU4K3P4UL	NSYCUSP0071	-	NSYCUSP0144	NSYCUSP0148	NSYCUSP0128
NSYCUX4K3P4UL	-	NSYCUSP0089	NSYCUSP0144	NSYCUSP0148	NSYCUSP0128
NSYCU6K3P4	-	-	NSYCUSP0099	-	-

Cooling units: Roof mount



Evaporator battery

Evaporator fan
(fan + capacitor)

Condenser battery

Condenser fan
(fan + capacitor)

Compressor kit

References	References	References	References	References	References
NSYCU400R	NSYCUSP0008	NSYCUSP0047	NSYCUSP0023	NSYCUSP0043	NSYCUSP0064
NSYCUX400R	NSYCUSP0008	NSYCUSP0047	NSYCUSP0023	NSYCUSP0043	NSYCUSP0064
NSYCU400RUL	NSYCUSP0008	NSYCUSP0047	NSYCUSP0023	NSYCUSP0043	NSYCUSP0172
NSYCU800R	NSYCUSP0009	NSYCUSP0044	NSYCUSP0024	NSYCUSP0136	NSYCUSP0065
NSYCUX800R	NSYCUSP0009	NSYCUSP0044	NSYCUSP0024	NSYCUSP0136	NSYCUSP0065
NSYCU800RUL	NSYCUSP0009	NSYCUSP0044	NSYCUSP0024	NSYCUSP0136	NSYCUSP0065
NSYCU1K2R	NSYCUSP0010	NSYCUSP0044	NSYCUSP0025	NSYCUSP0049	NSYCUSP0065
NSYCUX1K2R	NSYCUSP0010	NSYCUSP0044	NSYCUSP0025	NSYCUSP0049	NSYCUSP0065
NSYCU1K2RUL	NSYCUSP0010	NSYCUSP0044	NSYCUSP0025	NSYCUSP0049	NSYCUSP0065
NSYCU1K5R	NSYCUSP0010	NSYCUSP0136	NSYCUSP0026	NSYCUSP0049	NSYCUSP0059
NSYCUX1K5R	NSYCUSP0010	NSYCUSP0136	NSYCUSP0026	NSYCUSP0049	NSYCUSP0059
NSYCU1K5RUL	NSYCUSP0010	NSYCUSP0136	NSYCUSP0026	NSYCUSP0049	NSYCUSP0059
NSYCU2K3P4R	NSYCUSP0011	NSYCUSP0136	NSYCUSP0027	NSYCUSP0049	NSYCUSP0061
NSYCUX2K3P4R	NSYCUSP0011	NSYCUSP0136	NSYCUSP0027	NSYCUSP0049	NSYCUSP0061
NSYCU2K3P4RUL	NSYCUSP0011	NSYCUSP0136	NSYCUSP0027	NSYCUSP0049	NSYCUSP0062
NSYCU2KR	NSYCUSP0011	NSYCUSP0136	NSYCUSP0027	NSYCUSP0049	NSYCUSP0060
NSYCUX2KR	NSYCUSP0011	NSYCUSP0136	NSYCUSP0027	NSYCUSP0049	NSYCUSP0060
NSYCU3K3P4R	NSYCUSP0012	NSYCUSP0136	NSYCUSP0028	NSYCUSP0051	NSYCUSP0062
NSYCUX3K3P4R	NSYCUSP0012	NSYCUSP0136	NSYCUSP0028	NSYCUSP0051	NSYCUSP0062
NSYCU3K3P4RUL	NSYCUSP0012	NSYCUSP0136	NSYCUSP0028	NSYCUSP0051	NSYCUSP0062
NSYCU4K3P4R	NSYCUSP0012	NSYCUSP0137	NSYCUSP0029	NSYCUSP0051	NSYCUSP0063
NSYCUX4K3P4R	NSYCUSP0012	NSYCUSP0137	NSYCUSP0029	NSYCUSP0051	NSYCUSP0063
NSYCU4K3P4RUL	NSYCUSP0012	NSYCUSP0137	NSYCUSP0029	NSYCUSP0051	NSYCUSP0063

Cooling units: Roof mount





References	References	References	References	References	References
NSYCU400R	NSYCUSP0072	-	NSYCUSP0099	-	NSYCUSP0121
NSYCUX400R	-	NSYCUSP0090	NSYCUSP0099	-	NSYCUSP0121
NSYCU400RUL	NSYCUSP0072	-	NSYCUSP0144	-	NSYCUSP0121
NSYCU800R	NSYCUSP0073	-	NSYCUSP0099	-	NSYCUSP0122
NSYCUX800R	-	NSYCUSP0091	NSYCUSP0099	-	NSYCUSP0122
NSYCU800RUL	NSYCUSP0073	-	NSYCUSP0144	-	NSYCUSP0122
NSYCU1K2R	NSYCUSP0074	-	NSYCUSP0099	-	NSYCUSP0129
NSYCUX1K2R	-	NSYCUSP0092	NSYCUSP0099	-	NSYCUSP0129
NSYCU1K2RUL	NSYCUSP0074	-	NSYCUSP0144	-	NSYCUSP0129
NSYCU1K5R	NSYCUSP0074	-	NSYCUSP0099	-	NSYCUSP0129
NSYCUX1K5R	-	NSYCUSP0092	NSYCUSP0099	-	NSYCUSP0129
NSYCU1K5RUL	NSYCUSP0074	-	NSYCUSP0144	-	NSYCUSP0129
NSYCU2K3P4R	NSYCUSP0074	-	NSYCUSP0099	NSYCUSP0104	NSYCUSP0129
NSYCUX2K3P4R	-	NSYCUSP0092	NSYCUSP0099	NSYCUSP0104	NSYCUSP0129
NSYCU2K3P4RUL	NSYCUSP0074	-	NSYCUSP0144	NSYCUSP0147	NSYCUSP0129
NSYCU2KR	NSYCUSP0074	-	NSYCUSP0099	-	NSYCUSP0129
NSYCUX2KR	-	NSYCUSP0092	NSYCUSP0099	-	NSYCUSP0129
NSYCU3K3P4R	NSYCUSP0075	-	NSYCUSP0099	NSYCUSP0106	NSYCUSP0123
NSYCUX3K3P4R	-	NSYCUSP0093	NSYCUSP0099	NSYCUSP0106	NSYCUSP0123
NSYCU3K3P4RUL	NSYCUSP0075	-	NSYCUSP0144	NSYCUSP0148	NSYCUSP0123
NSYCU4K3P4R	NSYCUSP0075	-	NSYCUSP0099	NSYCUSP0105	NSYCUSP0123
NSYCUX4K3P4R	-	NSYCUSP0093	NSYCUSP0099	NSYCUSP0105	NSYCUSP0123
NSYCU4K3P4RUL	NSYCUSP0075	-	NSYCUSP0144	NSYCUSP0148	NSYCUSP0123

Cooling units: Heavy-Duty

					
Evaporator battery	Evaporator fan (fan + capacitor)	Condenser battery	Condenser fan (fan + capacitor)	Compressor kit	
References	References	References	References	References	References
NSYCUHD400	NSYCUSP0002	NSYCUSP0042	NSYCUSP0158	NSYCUSP0042	NSYCUSP0055
NSYCUHD600	NSYCUSP0003	NSYCUSP0043	NSYCUSP0159	NSYCUSP0044	NSYCUSP0056
NSYCUHD800	NSYCUSP0004	NSYCUSP0043	NSYCUSP0160	NSYCUSP0044	NSYCUSP0057
NSYCUHD1K	NSYCUSP0004	NSYCUSP0043	NSYCUSP0161	NSYCUSP0044	NSYCUSP0057
NSYCUHD1K2P4	NSYCUSP0004	NSYCUSP0043	NSYCUSP0161	NSYCUSP0044	NSYCUSP0057
NSYCUHD1K6	NSYCUSP0006	NSYCUSP0044	NSYCUSP0162	NSYCUSP0138	NSYCUSP0059
NSYCUHD1K62P4	NSYCUSP0006	NSYCUSP0044	NSYCUSP0162	NSYCUSP0138	NSYCUSP0059
NSYCUHD2K3P4	NSYCUSP0006	NSYCUSP0136	NSYCUSP0163	NSYCUSP0138	NSYCUSP0061
NSYCUHD3K3P4	NSYCUSP0007	NSYCUSP0137	NSYCUSP0164	NSYCUSP0137	NSYCUSP0062
NSYCUHD4K3P4	NSYCUSP0007	NSYCUSP0137	NSYCUSP0165	NSYCUSP0137	NSYCUSP0063

Cooling units: Heavy-Duty

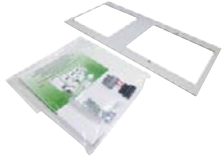
				
Frontal cover RAL 7035 grey	Thermostat		Transformer	Mounting Kit (instruction + full seal + screws)
References	References	References	References	References
NSYCUHD400	NSYCUSP0167	NSYCUSP0100	-	NSYCUSP0153
NSYCUHD600	NSYCUSP0168	NSYCUSP0100	-	NSYCUSP0154
NSYCUHD800	NSYCUSP0169	NSYCUSP0100	-	NSYCUSP0155
NSYCUHD1K	NSYCUSP0169	NSYCUSP0100	-	NSYCUSP0155
NSYCUHD1K2P4	NSYCUSP0169	NSYCUSP0100	NSYCUSP0101	NSYCUSP0155
NSYCUHD1K6	NSYCUSP0170	NSYCUSP0100	-	NSYCUSP0156
NSYCUHD1K62P4	NSYCUSP0170	NSYCUSP0100	NSYCUSP0103	NSYCUSP0156
NSYCUHD2K3P4	NSYCUSP0170	NSYCUSP0100	NSYCUSP0104	NSYCUSP0156
NSYCUHD3K3P4	NSYCUSP0171	NSYCUSP0100	NSYCUSP0105	NSYCUSP0157
NSYCUHD4K3P4	NSYCUSP0171	NSYCUSP0100	NSYCUSP0105	NSYCUSP0157

Cooling units: Slim

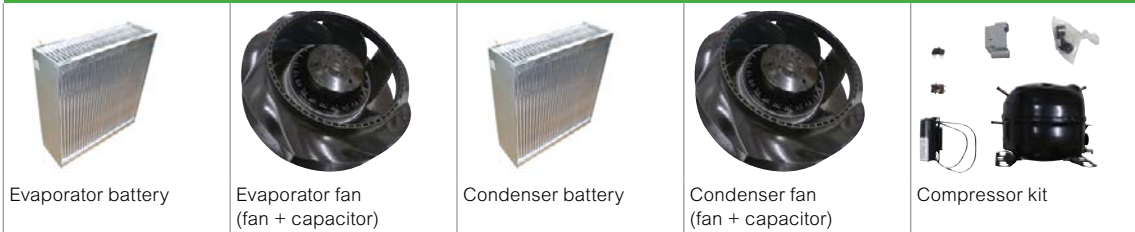

References	References	References	References	References	References
NSYCUS1K1UL	NSYCUSP0130	NSYCUSP0136	NSYCUSP0133	NSYCUSP0136	NSYCUSP0059
NSYCUSX1K1UL	NSYCUSP0130	NSYCUSP0136	NSYCUSP0133	NSYCUSP0136	NSYCUSP0059
NSYCUS1K12P4UL	NSYCUSP0130	NSYCUSP0136	NSYCUSP0133	NSYCUSP0136	NSYCUSP0059
NSYCUSX1K12P4UL	NSYCUSP0130	NSYCUSP0136	NSYCUSP0133	NSYCUSP0136	NSYCUSP0059
NSYCUS1K5UL	NSYCUSP0131	NSYCUSP0136	NSYCUSP0133	NSYCUSP0138	NSYCUSP0059
NSYCUSX1K5UL	NSYCUSP0131	NSYCUSP0136	NSYCUSP0133	NSYCUSP0138	NSYCUSP0059
NSYCUS1K52P4UL	NSYCUSP0131	NSYCUSP0136	NSYCUSP0133	NSYCUSP0138	NSYCUSP0059
NSYCUSX1K52P4UL	NSYCUSP0131	NSYCUSP0136	NSYCUSP0133	NSYCUSP0138	NSYCUSP0059
NSYCUS2KUL	NSYCUSP0131	NSYCUSP0136	NSYCUSP0134	NSYCUSP0138	NSYCUSP0139
NSYCUSX2KUL	NSYCUSP0131	NSYCUSP0136	NSYCUSP0134	NSYCUSP0138	NSYCUSP0139
NSYCUS2K3P4UL	NSYCUSP0131	NSYCUSP0136	NSYCUSP0134	NSYCUSP0138	NSYCUSP0062
NSYCUSX2K3P4UL	NSYCUSP0131	NSYCUSP0136	NSYCUSP0134	NSYCUSP0138	NSYCUSP0062
NSYCUS2K5UL	NSYCUSP0132	NSYCUSP0137	NSYCUSP0135	NSYCUSP0137	NSYCUSP0140
NSYCUSX2K5UL	NSYCUSP0132	NSYCUSP0137	NSYCUSP0135	NSYCUSP0137	NSYCUSP0140
NSYCUS2K53P4UL	NSYCUSP0132	NSYCUSP0137	NSYCUSP0135	NSYCUSP0137	NSYCUSP0062
NSYCUSX2K53P4UL	NSYCUSP0132	NSYCUSP0137	NSYCUSP0135	NSYCUSP0137	NSYCUSP0062
NSYCUS3K2UL	NSYCUSP0132	NSYCUSP0137	NSYCUSP0135	NSYCUSP0137	NSYCUSP0141
NSYCUSX3K2UL	NSYCUSP0132	NSYCUSP0137	NSYCUSP0135	NSYCUSP0137	NSYCUSP0141
NSYCUS3K23P4UL	NSYCUSP0132	NSYCUSP0137	NSYCUSP0135	NSYCUSP0137	NSYCUSP0063
NSYCUSX3K23P4UL	NSYCUSP0132	NSYCUSP0137	NSYCUSP0135	NSYCUSP0137	NSYCUSP0063

Cooling units: Slim

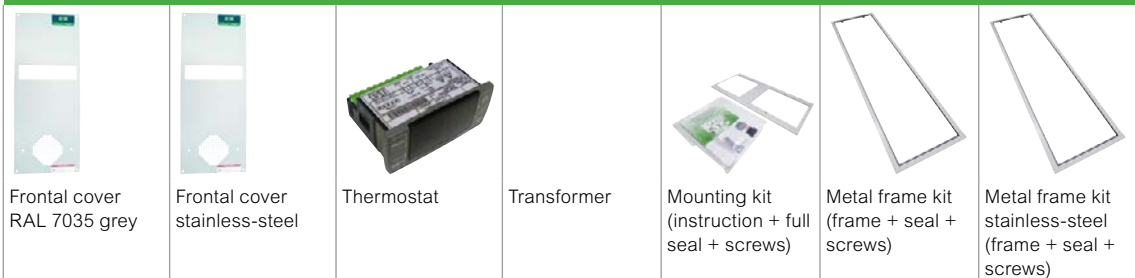

References	References	References	References	References	References	References	References
NSYCUS1K1UL	NSYCUSP0142	-	NSYCUSP0144	-	NSYCUSP0149	NSYCUSP0152	NSYCUSP0166
NSYCUSX1K1UL	-	NSYCUSP0150	NSYCUSP0144	-	NSYCUSP0149	NSYCUSP0152	NSYCUSP0166
NSYCUS1K12P4UL	NSYCUSP0142	-	NSYCUSP0144	NSYCUSP0145	NSYCUSP0149	NSYCUSP0152	NSYCUSP0166
NSYCUSX1K12P4UL	-	NSYCUSP0150	NSYCUSP0144	NSYCUSP0145	NSYCUSP0149	NSYCUSP0152	NSYCUSP0166
NSYCUS1K5UL	NSYCUSP0142	-	NSYCUSP0144	-	NSYCUSP0149	NSYCUSP0152	NSYCUSP0166
NSYCUSX1K5UL	-	NSYCUSP0150	NSYCUSP0144	-	NSYCUSP0149	NSYCUSP0152	NSYCUSP0166
NSYCUS1K52P4UL	NSYCUSP0142	-	NSYCUSP0144	NSYCUSP0146	NSYCUSP0149	NSYCUSP0152	NSYCUSP0166
NSYCUSX1K52P4UL	-	NSYCUSP0150	NSYCUSP0144	NSYCUSP0146	NSYCUSP0149	NSYCUSP0152	NSYCUSP0166
NSYCUS2KUL	NSYCUSP0142	-	NSYCUSP0144	-	NSYCUSP0149	NSYCUSP0152	NSYCUSP0166
NSYCUSX2KUL	-	NSYCUSP0150	NSYCUSP0144	-	NSYCUSP0149	NSYCUSP0152	NSYCUSP0166
NSYCUS2K3P4UL	NSYCUSP0142	-	NSYCUSP0144	NSYCUSP0147	NSYCUSP0149	NSYCUSP0152	NSYCUSP0166
NSYCUSX2K3P4UL	-	NSYCUSP0150	NSYCUSP0144	NSYCUSP0147	NSYCUSP0149	NSYCUSP0152	NSYCUSP0166
NSYCUS2K5UL	NSYCUSP0143	-	NSYCUSP0144	-	NSYCUSP0149	NSYCUSP0152	NSYCUSP0166
NSYCUSX2K5UL	-	NSYCUSP0151	NSYCUSP0144	-	NSYCUSP0149	NSYCUSP0152	NSYCUSP0166
NSYCUS2K53P4UL	NSYCUSP0143	-	NSYCUSP0144	NSYCUSP0148	NSYCUSP0149	NSYCUSP0152	NSYCUSP0166
NSYCUSX2K53P4UL	-	NSYCUSP0151	NSYCUSP0144	NSYCUSP0148	NSYCUSP0149	NSYCUSP0152	NSYCUSP0166
NSYCUS3K2UL	NSYCUSP0143	-	NSYCUSP0144	-	NSYCUSP0149	NSYCUSP0152	NSYCUSP0166
NSYCUSX3K2UL	-	NSYCUSP0151	NSYCUSP0144	-	NSYCUSP0149	NSYCUSP0152	NSYCUSP0166
NSYCUS3K23P4UL	NSYCUSP0143	-	NSYCUSP0144	NSYCUSP0148	NSYCUSP0149	NSYCUSP0152	NSYCUSP0166
NSYCUSX3K23P4UL	-	NSYCUSP0151	NSYCUSP0144	NSYCUSP0148	NSYCUSP0149	NSYCUSP0152	NSYCUSP0166

Index of references

I	Page	I	Page	L	Page
IMT36166	295	ISM71501	91, 98, 156, 192, 194, 306	LVS04538	374, 387, 426
IMT36167	295	ISM71502	91, 98, 156, 192, 194, 306	LVS04545	374, 387, 426
IMT36168	295	ISM71503	91, 98, 156, 192, 194, 306	LVS04546	374, 387, 426
IMT36169	295	ISM71504	91, 98, 156, 192, 194, 306	LVS04548	374, 387, 426
IMT36170	295	ISM71505	91, 98, 156, 192, 194, 306	LVS04550	374, 377, 387, 390
IMT36171	295	ISM71506	91, 98, 156, 192, 194, 306	LVS04552	374, 387
IMT36172	91, 96, 192, 305			LVS04560	373, 376, 386, 389, 424
IMT36173	91, 96, 192, 305			LVS04561	373, 376, 386, 389, 424
IMT36179	91, 97, 192, 193, 306	L	Page	LVS04562	373, 376, 386, 389, 424
IMT36180	91, 97, 192, 193, 306	LGY112510	368	LVS04563	373, 376, 386, 389, 424
IMT36181	91, 97, 192, 193, 306	LGY116013	368	LVS04564	373, 376, 386, 389, 424
IMT36182	91, 97, 192, 193, 306	LGY125014	368	LVS04565	373, 376, 386, 389, 424
IMT36183	91, 97, 192, 193, 306	LGY410028	368	LVS04566	373, 376, 386, 389, 424
IMT36184	91, 97, 192, 193, 306	LGY412548	368	LVS04567	373, 376, 386
IMT36185	91, 97, 192, 193, 306	LGY412560	368	LVS04568	373, 376, 386
IMT46026	310	LGY416048	368	LVS04602	375, 378, 388, 391, 423
IMT46033	310	LVS01130	393, 427	LVS04603	375, 388, 423
IMT46035	310	LVS01215	428	LVS04604	376, 389
IMT46036	310	LVS03583	396	LVS04605	376, 389
IMT46064	310	LVS04000	369	LVS04607	376, 389
IMT46071	310	LVS04008	369	LVS04620	373, 386, 424
IMT46073	310	LVS04012	369	LVS04621	373, 386, 424
IMT46074	310	LVS04013	369	LVS04623	373, 386
IMT46101	310	LVS04014	369	LVS04624	386
IMT46118	310	LVS04018	369	LVS04634	375, 388, 423
IMT46149	310	LVS04021	369	LVS04635	375, 388, 391, 392, 423
IMT46156	310	LVS04024	369	LVS04636	375, 377, 378, 388, 390, 391, 392, 423, 425
IMT46157	310	LVS04026	369	LVS04637	377, 390, 425
IMT46158	310	LVS04029	369	LVS04638	375, 377, 388, 390
IMT46221	310	LVS04030	369	LVS04640	374, 387, 426
IMT46222	310	LVS04031	368	LVS04641	374, 387, 426
IMT46223	310	LVS04040	368	LVS04642	375, 377, 388, 390, 391, 392, 425
IMT46224	310	LVS04041	368	LVS04643	374, 387
IMT46231	310	LVS04045	368	LVS04645	377, 390, 425
IMT46232	310	LVS04046	368	LVS04646	373, 374, 376, 386
IMT46233	310	LVS04047	368	LVS04651	375, 388, 423
IMT46234	310	LVS04052	368	LVS04652	391
IMT46248	310	LVS04053	368	LVS04653	392
IMT46286	310	LVS04054	368	LVS04656	378
IMT46293	310	LVS04150	369	LVS04658	376, 389
IMT46918	310	LVS04192	361	LVS04659	376, 389
IMT46919	310	LVS04197	361	LVS04664	386, 387
IMT46921	310	LVS04229	393, 427	LVS04669	392
IMT46922	310	LVS04407	370	LVS04671	386, 387, 389, 390
IMT46923	310	LVS04408	370	LVS04672	378
IMT46924	310	LVS04502	375, 378, 388, 391, 422, 423	LVS04678	367, 389, 390
IMT46926	310	LVS04503	375, 378, 388, 391, 422, 423	LVS04742	379
IMT46927	310	LVS04504	375, 388, 391, 422, 423	LVS04743	369, 379
IMT46968	310	LVS04505	375, 378, 388, 391, 422, 423	LVS04746	379
IMT46969	310	LVS04506	375, 388, 391, 422, 423	LVS04751	379
IMT46970	310	LVS04509	389	LVS04753	379
IMT47000	310	LVS04510	389	LVS04759	393, 427
IMT47001	310	LVS04512	378	LVS04766	378, 393, 427
IMT47002	310	LVS04515	378	LVS04767	393, 427
IMT47004	310	LVS04516	377, 390, 392, 425	LVS04768	393, 427
ISM71071	91, 96, 192, 305	LVS04518	377, 390, 392, 425	LVS04769	393, 427
ISM71072	91, 96, 192, 305	LVS04525	377, 390, 392, 425	LVS04772	393, 427
ISM71073	91, 96, 192, 305	LVS04526	377, 390, 392, 425	LVS04773	393, 427
ISM71074	91, 96, 192, 305	LVS04528	377, 390, 392, 425		
		LVS04536	374, 387, 426		

Index of references

L	Page	N	Page	N	Page
LVS04774	393, 427	NSY2PLVDC24U6	596	NSY2SPX206	25, 178
LVS04775	393, 427	NSY2PLVDC33U6	596	NSY6G2SP206	453
LVS04782	393, 427	NSY2PLVDC42U10	596	NSY6G2SP208	453
LVS04783	393, 427	NSY2PLVDC42U10N	596	NSYAC1080	239
LVS04784	393, 427	NSY2PLVDC42U6	596	NSYAC1120	241
LVS04785	393, 427	NSY2PLVDC42U8	596	NSYAC280	217
LVS04786	393, 427	NSY2PLVDC42U8N	596	NSYAC320	239
LVS04787	393, 427	NSY2SP124	20, 22, 116, 118, 121	NSYAC360	217, 241
LVS04788	393, 427	NSY2SP125	22, 118, 121	NSYAC560	239
LVS04794	393, 427	NSY2SP126	20, 22, 116, 118, 121	NSYAC600	217, 241
LVS04809	370	NSY2SP128	22, 118, 121	NSYAC840	239, 241
LVS04901	396	NSY2SP144	20, 22, 116, 118, 121	NSYACC2N	618
LVS04924	395	NSY2SP145	22, 118, 121	NSYACC50N	618
LVS04943	396	NSY2SP146	22, 118, 121	NSYACCA	618
LVS04946	397	NSY2SP148	22, 118, 121	NSYACGCS	618
LVS04951	397	NSY2SP164	22, 118, 121	NSYADC16	353, 356
LVS04952	397	NSY2SP165	22, 118, 121	NSYADC18	356
LVS04955	396	NSY2SP166	20, 22, 116, 118, 121	NSYADG20M	726
LVS04956	396	NSY2SP168	20, 22, 116, 118, 121	NSYADG2M	726
LVS06461	399	NSY2SP184	20, 22, 116, 118, 121, 359	NSYADG3M	726
LVS06540	395, 428	NSY2SP185	20, 22, 116, 118, 121, 359	NSYADG5M	726
LVS06541	395	NSY2SP186	20, 22, 116, 118, 121, 359	NSYADGCA	617
LVS06543	395	NSY2SP188	20, 22, 116, 118, 121	NSYADR200	284
LVS06545	395	NSY2SP204	20, 23, 116, 119, 121, 359	NSYADR200D	284
LVS06555	395	NSY2SP205	20, 23, 116, 119, 121, 359, 398	NSYAEBFZ	217, 239
LVS06560	395	NSY2SP205ED	398	NSYAEBP2F4F	605
LVS06561	395, 428	NSY2SP206	20, 23, 116, 119, 121, 359, 398, 431	NSYAEBP2F610	591, 592, 605
LVS06563	395, 428	NSY2SP206ED	398	NSYAEBP2F68	591, 592, 605
LVS06567	395	NSY2SP208	20, 23, 116, 119, 121, 359, 398, 431	NSYAEBP2F810	591, 592, 605
LVS06568	395	NSY2SP208ED	398	NSYAEBP2F88	591, 592, 605
LVS06570	395	NSY2SP224	23, 119, 121	NSYAEBP2FS10	605
LVS06600	397	NSY2SP225	23, 119, 121	NSYAEBP2FS6	605
LVS06601	397	NSY2SP226	20, 23, 116, 119, 121, 359	NSYAEBP2FS8	605
LVS06604	397	NSY2SP228	20, 23, 116, 119, 121	NSYAECPF1A10	91, 92, 300
LVS06605	397	NSY2SPHD124	440	NSYAECPF1A25	91, 92, 300
LVS06606	397	NSY2SPHD126	440	NSYAECPF1A33	91, 92, 300
LVS06607	397	NSY2SPHD164	440	NSYAECPF1A7	91, 92, 300
LVS08566	398	NSY2SPHD166	440	NSYAECPF1ACA14	304
LVS08881	91, 94, 304	NSY2SPHD204	440	NSYAECPF1ACA18	304
LVS08892	91, 94, 304	NSY2SPI126	121	NSYAECPF1ACA20	304
LVS08895	91, 94, 304	NSY2SPI185	121	NSYAECPF1ACA30	304
LVS08897	91, 94, 304	NSY2SPI186	121	NSYAECPF1BP	91, 93, 137, 301
LVS08898	91, 94, 304	NSY2SPI188	121	NSYAECPF1T25	91, 93, 137, 301
LVS08899	91, 94, 304	NSY2SPI204	121	NSYAECPF1T35	91, 93, 137, 301
LVS08911	399	NSY2SPI205	121	NSYAECPF1T7	91, 93, 137, 301
		NSY2SPI206	121	NSYAECPK10	91, 94, 301
		NSY2SPI208	121	NSYAECPK11	91, 94, 301
		NSY2SPI226	121	NSYAECPK17A	91, 94, 301
		NSY2SPI228	121	NSYAEDDINS3D	86
		NSY2SPIHD124	440	NSYAEDH120S3D	67, 88, 724, 726
		NSY2SPIHD126	440	NSYAEDH120S3HD	733
		NSY2SPIHD164	440	NSYAEDH180S3D	67, 88, 724, 726
		NSY2SPIHD166	440	NSYAEDH20TB	190
		NSY2SPIHD204	440	NSYAEDH40TB	190
		NSY2SPX184	25, 178	NSYAEDHPLM	731
		NSY2SPX204	25, 178	NSYAEDHPLM108	731
		NSY2SPX205	25, 178	NSYAEDHPLM3025	731
				NSYAEDHPLM32	731
				NSYAEDHSB	39, 42

Index of references

N	Page	N	Page	N	Page
NSYAEDKRUKVD	576	NSYAEDLS3HDRL	733	NSYAEPZM	217
NSYAEDKTB	188	NSYAEDLS3HFDB3	731	NSYAEUBU41SC	61, 83
NSYAEDL1242K31	459, 463	NSYAEDLS6S3D	86	NSYAEUBU61SC	61, 83
NSYAEDL1242K33	454, 459, 463	NSYAEDLS7S3D	86	NSYAEUBUSC	61, 83
NSYAEDL1242S3D	85	NSYAEDLS8S3D	86	NSYAMCSF	264, 291
NSYAEDL1332S3D	85	NSYAEDLS9S3D	63	NSYAMFSB	39, 42, 155
NSYAEDL1344S3D	85	NSYAEDLS9S3D	86	NSYAMFSTB	185, 191
NSYAEDL2124S3D	85	NSYAEDLT6S3D	86	NSYAMPA1916TB	186, 190
NSYAEDL2131S3D	85	NSYAEDLT8S3D	86	NSYAMPA2419TB	186, 190
NSYAEDL2132S3D	85	NSYAEDLN1AVD	595	NSYAMPA2924TB	186, 190
NSYAEDL2133S3D	85	NSYAEDLN1DVD	576, 595	NSYAMPA3429TB	186, 190
NSYAEDL2241S3D	85	NSYAEDLN1KVD	595	NSYAMP1916TB	186, 190
NSYAEDL2244S3D	85	NSYAEDLN2124EVD	595	NSYAMP2419TB	186, 190
NSYAEDL2314S3D	85	NSYAEDLN3PVD	595	NSYAMP2924TB	186, 190
NSYAEDL2322S3D	85	NSYAEDLNH2124EVD	595	NSYAMP3429TB	186, 190
NSYAEDL2331S3D	85	NSYAEDPHD	732	NSYAMRD11155TB	191
NSYAEDL2432S3D	85	NSYAEDPLA001	730	NSYAMRD11357TB	191
NSYAEDL2433S3D	85	NSYAEDPLA002G	730	NSYAMRD15357SB	38, 41, 154
NSYAEDL3113S3D	85	NSYAEDPLA003G	730	NSYAMRD16155TB	191
NSYAEDL3123S3D	85	NSYAEDPLA004	730	NSYAMRD16357TB	191
NSYAEDL3131AS3D	85, 724	NSYAEDPLA005	730	NSYAMRD19155TB	191
NSYAEDL3132S3D	85	NSYAEDPLM108	731	NSYAMRD19357TB	191
NSYAEDL3432S3D	85	NSYAEDRS3DPA6	88, 320	NSYAMRD2030	17
NSYAEDL3524S3D	85	NSYAEDRS3DPA6	88, 169, 320	NSYAMRD20357SB	38, 41, 154
NSYAEDL405K31	459, 463	NSYAEDRS3DPA6	88, 169, 320	NSYAMRD24155TB	191
NSYAEDL405K33	454, 459, 463	NSYAEDRS3DPA6	88, 169, 320	NSYAMRD243515TB	191
NSYAEDL405S3D	85	NSYAEDRS3DPA6	88, 169, 320	NSYAMRD24357TB	191
NSYAEDL421S3D	85	NSYAEDRS3DPA6	88, 169, 320	NSYAMRD2530	17
NSYAEDL4322S3D	85	NSYAEDRS3DPA6	88, 169, 320	NSYAMRD2540	17
NSYAEDL4324S3D	85	NSYAEDRS3DPA6	88, 169, 320	NSYAMRD2550	17
NSYAEDL455K31	459, 463	NSYAEDRS3DPA6	88, 169, 320	NSYAMRD29155TB	191
NSYAEDL455K33	454, 459, 463	NSYAEDRS3DPA6	88, 169, 320	NSYAMRD293515TB	191
NSYAEDL455S3D	85	NSYAEDRS3DPA6	88, 169, 320	NSYAMRD29357TB	191
NSYAEDL5124S3D	85	NSYAEDRS3DPA6	88, 169, 320	NSYAMRD3030	17
NSYAEDL520S3D	85	NSYAEDRS3DPA6	88, 169, 320	NSYAMRD30357SB	38, 41, 154
NSYAEDL601S3D	85	NSYAEDRS3DPA6	88, 169, 320	NSYAMRD3040	17
NSYAEDL610S3D	85	NSYAEDRS3DPA6	88, 169, 320	NSYAMRD3050	17
NSYAEDL705S3D	85	NSYAEDRS3DPA6	88, 169, 320	NSYAMRD34155TB	191
NSYAEDLB3MS3D	86	NSYAEDRS3DPA6	88, 169, 320	NSYAMRD343515TB	191
NSYAEDLB3S3D	86	NSYAEDRS3DPA6	88, 169, 320	NSYAMRD34357TB	191
NSYAEDLB5S3D	86	NSYAEDRS3DPA6	88, 169, 320	NSYAMRD36	17
NSYAEDLEDF13K31	459, 463	NSYAEDRS3DPA6	88, 169, 320	NSYAMRD40357SB	38, 41, 154
NSYAEDLEDF13K33	454, 459, 463	NSYAEDRS3DPA6	88, 169, 320	NSYAMRD43	17
NSYAEDLEDF13S3D	87	NSYAEDRS3DPA6	88, 169, 320	NSYAMRD48	17
NSYAEDLEDF14K31	459, 463	NSYAEDRS3DPA6	88, 169, 320	NSYAMRD50357SB	38, 41
NSYAEDLEDF14K33	454, 459, 463	NSYAEDRS3DPA6	88, 169, 320	NSYAMRD54	17
NSYAEDLEDF14S3D	87	NSYAEDRS3DPA6	88, 169, 320	NSYAMRD60357SB	38, 41
NSYAEDLEDF9K31	459, 463	NSYAEDRS3DPA6	88, 169, 320	NSYAMRD64	17
NSYAEDLEDF9K33	454, 459, 463	NSYAEDRS3DPA6	88, 169, 320	NSYAMRD80357SB	38, 41
NSYAEDLEDF9S3D	87	NSYAEDRS3DPA6	88, 169, 320	NSYAPU10S3	614
NSYAEDLMETS3D	86	NSYAEDRS3DPA6	88, 169, 320	NSYAPU10S3S	614
NSYAEDLPADS3D	87	NSYAEDRS3DPA6	88, 169, 320	NSYAPU19F6CB	613
NSYAEDLPADS-3DHD	440	NSYAEDRS3DPA6	88, 169, 320	NSYAPU19F6F	613
NSYAEDLPADS3DK3	459, 463	NSYAEDRS3DPA6	88, 169, 320	NSYAPU19F6FT	613
NSYAEDLPSS3D	87	NSYAEDRS3DPA6	88, 169, 320	NSYAPU19F7FA	613
NSYAEDLS3DC	725	NSYAEDRS3DPA6	88, 169, 320	NSYAPU19F8S	613
NSYAEDLS3DKDB3	85, 724, 725, 732	NSYAEDRS3DPA6	88, 169, 320	NSYAPU19F9	613
NSYAEDLS3DRLN	724	NSYAEDRS3DPA6	88, 169, 320	NSYAPU19S6CB	614
		NSYAEDRS3DPA6	88, 169, 320	NSYAPU19S6F	614

Index of references

N	Page	N	Page	N	Page
NSYAPU19S6FT	614	NSYBBT1U40P	609	NSYBN606	283, 290
NSYAPU19S7FA	614	NSYBBT1U40PG	609	NSYBN608	283, 290
NSYAPU19S8S	614	NSYBBT1U60	609	NSYBN610	283, 290
NSYAPU19S9	614	NSYBBT1U60P	609	NSYBP126	22, 118
NSYAPU19UK7	615	NSYBBT1U60PG	609	NSYBP128	22, 118
NSYAPUB	615	NSYBBT1U80	609	NSYBP146	22, 118
NSYAPUBV	615	NSYBBT1U80P	609	NSYBP148	22, 118
NSYAPUF10S	613	NSYBBT1U80PG	609	NSYBP166	22, 118
NSYAPUF12CB	613	NSYBCE10	133	NSYBP168	22, 118
NSYAPUS10S	614	NSYBCE12	133	NSYBP1810	22, 118
NSYAPUS12CB	614	NSYBCE16	133	NSYBP1812	22, 118
NSYAS400	362	NSYBCE4	133	NSYBP184	22, 118
NSYAS500	362, 389, 390	NSYBCE6	133	NSYBP186	22, 118
NSYAS600	362, 389, 390, 425	NSYBCE8	133	NSYBP188	22, 118
NSYAS800	362, 389, 390, 425	NSYBCME	64, 177, 223	NSYBP2010	23, 119
NSYAS800L	389, 390	NSYBCPL	64, 223	NSYBP2012	23, 119
NSYASPLA001	730	NSYBE27G	205	NSYBP2016	23, 119
NSYASPLA002	730	NSYBF1U25P	610	NSYBP203	23, 119, 432
NSYASPLA003	730	NSYBF2U25P	610	NSYBP204	23, 119, 432
NSYASPLM	731	NSYBF2U25PG	610	NSYBP206	23, 119, 431
NSYASPLM32	731	NSYBF2U40P	610	NSYBP207	727
NSYASR3U	609	NSYBF2U40PG	610	NSYBP208	23, 119, 431
NSYATM27	202	NSYBF4B3M	430	NSYBP2210	23, 119
NSYATP24DTM	350	NSYBF4B4M	430	NSYBP2212	23, 119
NSYATP6DTM	350	NSYBF4B5M	430	NSYBP224	23, 119
NSYATP72M	50, 54, 350	NSYBF4B6M	430	NSYBP226	23, 119
NSYATPUND	350	NSYBF4B8M	430	NSYBP228	23, 119
NSYAUPG1G	225, 237, 324	NSYBF4B9M	430	NSYBPA7032	324
NSYAUPGS	225, 237, 324	NSYBGN1054HD	247, 438	NSYBPA7035	324
NSYAVD1U1450	663	NSYBGN1074HD	247, 438	NSYBPC3	311, 617
NSYAVD1U480	663	NSYBGN12124HD	247, 438	NSYBPC5	311, 617
NSYAVD1U550M48	663	NSYBGN12126HD	247, 438	NSYBPCH1016	371
NSYAVD1U970	663	NSYBGN1254HD	247, 438	NSYBPCH1050	371
NSYAVG2U300	663	NSYBGN1274HD	247, 438	NSYBPCH5120	371
NSYAZ3PLA	239	NSYBGN1276HD	247, 438	NSYBPCH516	371
NSYAZ4PLA	239	NSYBGN15124HD	247, 438	NSYBPCH550	371
NSYB204	283, 290	NSYBGN15126HD	247, 438	NSYBPHD12122D	733
NSYB404	283, 290	NSYBGN1574HD	247, 438	NSYBPHD126	733
NSYB406	283, 290	NSYBGN1576HD	247, 438	NSYBPHD128	733
NSYBANPLA53	251	NSYBGN2074HD	247, 438	NSYBPHD1612	733
NSYBANPLA54	251	NSYBGN774HD	247, 438	NSYBPHD166	733
NSYBANPLA56	251	NSYBGN776HD	247, 438	NSYBPHD168	733
NSYBANPLA73	251	NSYBHNT500	367	NSYBPHD208	733
NSYBANPLA74	251	NSYBHNT600	367	NSYBPI1810	122
NSYBANPLA76	251	NSYBHNT800	367	NSYBPI2010	122
NSYBBF1U40	609	NSYBHNW600	367	NSYBPI206	122
NSYBBF1U40P	609	NSYBHNW800	367	NSYBPI208	122
NSYBBF1U40PG	609	NSYBHS500	363, 387	NSYBPI2210	122
NSYBBF1U60	609	NSYBHS600	363, 387, 424, 426	NSYBPI228	122
NSYBBF1U60P	609	NSYBHS800	363, 387, 424, 426	NSYBR9F12	603
NSYBBF1U60PG	609	NSYBICRN	726, 731	NSYBR9F21	603
NSYBBF1U80	609	NSYBL27	205	NSYBR9F24	578, 579, 586, 587, 603
NSYBBF1U80P	609	NSYBLKH123	143	NSYBR9F29	578, 579, 603
NSYBBF1U80PG	609	NSYBMF68	603	NSYBR9F2U6	603
NSYBBH29	371	NSYBN204	283, 290	NSYBR9F2U8	603
NSYBBH30	371	NSYBN206	283, 290	NSYBR9F33	578, 579, 603
NSYBBH31	371	NSYBN404	283, 290	NSYBR9F38	578, 579, 603
NSYBBH32	371	NSYBN406	283, 290	NSYBR9F42	578, 579, 586, 587, 603
NSYBBT1U40	609	NSYBN408	283, 290	NSYBR9F47	578, 579, 603

Index of references

N	Page	N	Page	N	Page
NSYBRF12PLAG	31, 245	NSYCAF223T	443, 445, 654, 656	NSYCBXHCRN	169
NSYBRF17PLAG	31, 245	NSYCAF228R	667	NSYCCA100MFST	643, 648
NSYBRF21PLAG	31, 245	NSYCAF291	654	NSYCCA150MFST	643, 648
NSYBRF26PLAG	31, 245	NSYCAF291DG	645, 650	NSYCCA200MFST	643, 648
NSYBRF8PLAG	31, 245	NSYCAF291G3DG	645, 650	NSYCCA300MFST	643, 648
NSYBS400	360	NSYCAF291L55	655, 661	NSYCCA400MFST	643, 648
NSYBS500	360	NSYCAF291M	654	NSYCCA500MFST	643, 648
NSYBS600	360	NSYCAF291O	654	NSYCCA50MFST	643, 648
NSYBS800	360	NSYCAF291T	654	NSYCCABLK	645, 646, 651
NSYBSA	363, 373, 374, 376, 377, 386, 387, 389, 390, 392, 424, 425, 426	NSYCAF92	654	NSYCCAFSDUST	645, 651
NSYBSA70	367	NSYCAF92DG	645, 650	NSYCCARPM	645, 651
NSYBSC630	360	NSYCAF92M	654	NSYCCASTE	705
NSYBSM100	610	NSYCAG104X95LM	666	NSYCCFSBRKIT125	644, 648
NSYBSM80	610	NSYCAG108LP	662	NSYCCFSBRKIT223	644, 648
NSYBST100	610	NSYCAG110X46M	666	NSYCCFSBRKIT291	644, 648
NSYBST80	610	NSYCAG114LPP	663	NSYCCFSBRKIT92	644, 648
NSYBT2U25P	610	NSYCAG125BPC	645, 650	NSYCCOFR55	643, 648
NSYBT2U25PG	610	NSYCAG125DG	643, 650	NSYCCOFSEM8U1	643, 648
NSYBTACRNG100	726	NSYCAG125DGC	645, 650	NSYCCOFSEM8U2	643, 648
NSYBTACRNG120	726	NSYCAG125LPP	233, 654, 655, 661	NSYCCOFST30V	643, 648
NSYBTACRNG140	726, 731	NSYCAG12LPH1	188, 667	NSYCCOFST90250V	643, 648
NSYBTACRNG80	726	NSYCAG12LPH2	188, 667	NSYCCOHY230VID	705
NSYBTAS3D100	724, 725, 732	NSYCAG130X110LM	666	NSYCCOHYT120VID	705
NSYBTAS3D120	724, 725	NSYCAG170X190LM	666	NSYCCOHYT230VID	705
NSYBTAS3D140	724	NSYCAG180X62M	666	NSYCCOHYT30VID	705
NSYBTAS3D60	724, 725, 732	NSYCAG19LP	667	NSYCCOTH120VID	705
NSYBTAS3D65	724	NSYCAG216X62M	666	NSYCCOTH230VID	705
NSYBTAS3D70	724, 725, 732	NSYCAG223BPC	645, 650	NSYCCOTH30VID	705
NSYBTAS3D80	724, 725, 732	NSYCAG223DG	643, 650	NSYCCOTHCF	704
NSYBTAS3D90	724	NSYCAG223DGC	645, 650	NSYCCOTHDF	704
NSYBTSCS	612	NSYCAG223LFHD	443, 656	NSYCCOTHI	704
NSYBVS400	362	NSYCAG223LPP	445, 654, 655, 661	NSYCCOTHOF	704
NSYBVS500	362, 389, 390	NSYCAG291BPC	645, 650	NSYCCSDF10	731
NSYBVS600	362, 389, 390, 425	NSYCAG291DG	643, 650	NSYCCSDF12	731
NSYBVS800	362, 389, 390, 425	NSYCAG291DGC	645, 650	NSYCCSDF16	731
NSYBVS800L	389, 390	NSYCAG291LPP	654, 655, 661	NSYCCSDF8	731
NSYCAAPV	651, 654	NSYCAG317X120M	666	NSYCCBPLM	215, 731
NSYCAAPVHD	443, 656	NSYCAG317X91M	666	NSYCDL	313
NSYCAC228RMF	667	NSYCAG33LP	667	NSYCDP36	141
NSYCAEFPP	57, 79	NSYCAG35LP	225, 667	NSYCDP38	141
NSYCAF104X95X	666	NSYCAG38LP	667	NSYCCDS	313
NSYCAF108	662	NSYCAG417X120M	666	NSYCEA14E	734
NSYCAF125	654	NSYCAG45LP	667	NSYCEA22E	669, 734
NSYCAF125DG	645, 650	NSYCAG78LPP	663	NSYCEA35W230VL	673
NSYCAF125G3DG	645, 650	NSYCAG92BPC	645, 650	NSYCEA35W230VLE	673
NSYCAF125L55	655, 661	NSYCAG92DG	643, 650	NSYCEA36	669, 673, 734
NSYCAF125M	654	NSYCAG92DGC	645, 650	NSYCEA50	669, 673, 734
NSYCAF125O	654	NSYCAG92LPP	654	NSYCEA70W230VL	673
NSYCAF125T	654	NSYCAP125LE	661	NSYCEA80	669, 673, 734
NSYCAF130X110X	666	NSYCAP125LXF	655, 661	NSYCEFILS	476
NSYCAF170X190X	666	NSYCAP125LZF	655, 661	NSYCEJ	133
NSYCAF190	443, 444, 445, 656	NSYCAP223LE	660, 661	NSYCEJD	302
NSYCAF223	654	NSYCAP223LXF	655, 661	NSYCEJD11	302
NSYCAF223DG	645, 650	NSYCAP223LZF	655, 661	NSYCEJD13	302
NSYCAF223G3DG	645, 650	NSYCAP291LE	660, 661	NSYCEJD16	302
NSYCAF223L55	655, 661	NSYCAP291LXF	655, 661	NSYCEJD18	302
NSYCAF223M	654	NSYCAP291LZF	655, 661		
NSYCAF223O	654	NSYCBCCRN	63		
		NSYCBMPLAG	244		

Index of references

N	Page	N	Page	N	Page
NSYCEJD20	302	NSYCF596	308	NSYCMUMA80	508, 511
NSYCEJD22	302	NSYCF598	308	NSYCMUMC50	508, 511
NSYCEJD24	302	NSYCGHF12	494	NSYCMUMC80	508, 511
NSYCEJD26	302	NSYCGHF16	494	NSYCMUMR50	508, 511
NSYCEJD28	302	NSYCGHF20	494	NSYCMUMR80	508, 511
NSYCEJD3	302	NSYCGHF25	494	NSYCMUTC50	508, 512
NSYCEJD30	302	NSYCGHF32	494	NSYCMUTC80	508, 512
NSYCEJD5	302	NSYCGHF40	494	NSYCN20	283, 331
NSYCEJD7	302	NSYCGSP16	91, 98, 156, 192, 195, 307	NSYCN40	283, 331
NSYCEJD9	302	NSYCGSP20	91, 98, 156, 192, 195, 307	NSYCN9M625	129, 289, 484, 608
NSYCEJDL0	303	NSYCGSP25	91, 98, 156, 192, 195, 307	NSYCNFM6	290
NSYCEJDL12	303	NSYCGSP32	91, 98, 156, 192, 195, 307	NSYCNFM8	290
NSYCEJDL13	303	NSYCGSP40	91, 98, 156, 192, 195, 307	NSYCNM6	271, 290
NSYCEJDL14	303	NSYCGX12	91, 99, 157, 307	NSYCNM8	271, 290
NSYCEJDL15	303	NSYCGX12H	91, 99, 157, 307	NSYCNH123	143
NSYCEJDL16	303	NSYCGX16	91, 99, 157, 307	NSYCNT20	283, 331
NSYCEJDL17	303	NSYCGX16H	91, 99, 157, 307	NSYCNT40	283, 331
NSYCEJDL18	303	NSYCGX20	91, 99, 157, 307	NSYCOCN80	52, 59, 78, 81
NSYCEJDL19	303	NSYCGX20H	91, 99, 157, 307	NSYCOCN1400	52, 59, 78, 81, 168, 219, 492
NSYCEJDL20	303	NSYCGX25	91, 99, 157, 307	NSYCOCN1800	59, 81, 168, 219, 492
NSYCEJDL21	303	NSYCGX25H	91, 99, 157, 307	NSYCP17	311
NSYCEJDS0	303	NSYCGX32	91, 99, 157, 307	NSYCP29	311
NSYCEJDS10	303	NSYCGX32H	91, 99, 157, 307	NSYCP37	311
NSYCEJDS11	303	NSYCGX40	91, 99, 157, 307	NSYCP50	311
NSYCEJDS2	303	NSYCGX40H	91, 99, 157, 307	NSYCP17S17	311
NSYCEJDS3	303	NSYCHCOA	52, 59	NSYCP17S29	311
NSYCEJDS4	303	NSYCHCOB	52, 59	NSYCP17S37	311
NSYCEJDS5	303	NSYCHCOC	52, 59	NSYCP17S50	311
NSYCEJDS6	303	NSYCHCOD	52, 59	NSYCR100WU1	701
NSYCEJDS7	303	NSYCL1242ECSX	169	NSYCR100WU1C	700
NSYCEJDS8	303	NSYCL220CRN	63	NSYCR100WU2	701
NSYCEJDS9	303	NSYCL27L405	199, 204	NSYCR100WU2C	700
NSYCEK	133	NSYCL27M	199, 204	NSYCR100WU3	701
NSYCEP	323	NSYCL405CRN	63	NSYCR100WU3C	700
NSYCEPLMAG	27, 218	NSYCL405CSX	169	NSYCR10WU1	701
NSYCEPLMBG	27, 218	NSYCL610CSX	169	NSYCR10WU1C	700
NSYCEPLMCG	27, 218	NSYCLL405CRN	63	NSYCR10WU2	701
NSYCEW1K	671, 673, 734, 735	NSYCMACS50	512	NSYCR10WU2C	700
NSYCEW1K8	671, 673, 734, 735	NSYCMACS80	512	NSYCR150WU1	701
NSYCEW-2100W230VL	673	NSYCMCBPT	510	NSYCR150WU1C	700
NSYCEW2K5	671, 673, 734, 735	NSYCMCT2560110	510	NSYCR150WU2	701
NSYCEW2K5R	672, 673, 734, 735	NSYCMCT5005	508, 511	NSYCR150WU2C	700
NSYCEW-3150W230VL	673	NSYCMCT5010	508, 511	NSYCR150WU3	701
NSYCEW3K5	671, 673, 734, 735	NSYCMCT5015	508, 511	NSYCR170W230VVC	700
NSYCEW4K5	671, 673, 734, 735	NSYCMCT5020	508, 511	NSYCR20WU1	701
NSYCEW6K	672, 673, 734, 735	NSYCMCT8005	508, 511	NSYCR20WU1C	700
NSYCEW6K2P4	672, 673, 734, 735	NSYCMCT8010	508, 511	NSYCR20WU2	701
NSYCEWX1K	671, 673, 734, 735	NSYCMCT8015	508, 511	NSYCR20WU2C	700
NSYCEWX1K8	671, 673, 734, 735	NSYCMCT8020	508, 511	NSYCR20WU3	701
NSYCEWX2K5	671, 673, 734, 735	NSYCMUCC50	508, 512	NSYCR250W115VV	701
NSYCFM	599	NSYCMUCC80	508, 512	NSYCR250W230VV	701
NSYCFP100	308	NSYCMUCP50	508, 512	NSYCR400W115VV	701
NSYCFP60	308	NSYCMUCP80	508, 512	NSYCR400W230VV	701
NSYCFP80	308	NSYCMUCPAD87	512	NSYCR50WU1C	700
NSYCFRS	567, 599	NSYCMUCR50	508, 512	NSYCR50WU2C	700
NSYCF5126	308	NSYCMUCR80	508, 512	NSYCR50WU3C	700
NSYCF5128	308	NSYCMUIA50	508, 511	NSYCR55WU1	701
		NSYCMUIA80	508, 511	NSYCR55WU2	701
		NSYCMUMA50	508, 511	NSYCR55WU3	701

Index of references

N	Page	N	Page	N	Page
NSYCRN106250	12, 48	NSYCRN64150T	12, 48	NSYCRNG1212300D	53
NSYCRN106250P	12, 48	NSYCRN64200	12, 48	NSYCRNG1212400D	53
NSYCRN106250T	12, 48	NSYCRN64200P	12, 48	NSYCRNG126300	53
NSYCRN106300	12, 48	NSYCRN64200T	12, 48	NSYCRNG126300T	53
NSYCRN106300P	12, 48	NSYCRN64250	12, 48	NSYCRNG126400	53
NSYCRN106300T	12, 48	NSYCRN64250P	12, 48	NSYCRNG126400T	53
NSYCRN108250	12, 48	NSYCRN64250T	12, 48	NSYCRNG128300	53
NSYCRN108250P	12, 48	NSYCRN65150	12, 48	NSYCRNG128300T	53
NSYCRN108250T	12, 48	NSYCRN65150P	12, 48	NSYCRNG128400	53
NSYCRN108300	12, 48	NSYCRN65150T	12, 48	NSYCRNG128400T	53
NSYCRN108300P	12, 48	NSYCRN65200	12, 48	NSYCRNG1410300D	53
NSYCRN108300T	12, 48	NSYCRN65200P	12, 48	NSYCRNG810300D	53
NSYCRN22150	12, 48	NSYCRN65200T	12, 48	NSYCRNG812300D	53
NSYCRN23150	12, 48	NSYCRN65250	12, 48	NSYCRNG86400	53
NSYCRN252150	12, 48	NSYCRN65250P	12, 48	NSYCRNG86400T	53
NSYCRN252150P	12, 48	NSYCRN65250T	12, 48	NSYCRNGSDR	263
NSYCRN325150	12, 48	NSYCRN66200	12, 48	NSYCRP1W120VTV	701
NSYCRN325150P	12, 48	NSYCRN66200P	12, 48	NSYCRP1W230VTV	701
NSYCRN325150T	12, 48	NSYCRN66200T	12, 48	NSYCRS100W240V	697
NSYCRN325200	12, 48	NSYCRN66250	12, 48	NSYCRS10W240V	697
NSYCRN325200P	12, 48	NSYCRN66250P	12, 48	NSYCRS200W230V	701
NSYCRN325200T	12, 48	NSYCRN66250T	12, 48	NSYCRS200W240V	697
NSYCRN33150	12, 48	NSYCRN66300	12, 48	NSYCRS25W240V	697
NSYCRN33150P	12, 48	NSYCRN66300P	12, 48	NSYCRS50W240V	697
NSYCRN33150T	12, 48	NSYCRN66300T	12, 48	NSYCRT4A1U	620
NSYCRN33200	12, 48	NSYCRN68300	12, 48	NSYCRT4A2U	620
NSYCRN33200P	12, 48	NSYCRN68300T	12, 48	NSYCRT4A3U	620
NSYCRN33200T	12, 48	NSYCRN75200	12, 48	NSYCRT4A4U	620
NSYCRN34200	12, 48	NSYCRN75200P	12, 48	NSYCRT4A5U	620
NSYCRN34200T	12, 48	NSYCRN75200T	12, 48	NSYCRT4A6U	620
NSYCRN345150	12, 48	NSYCRN75250	12, 48	NSYCRT4A9U	620
NSYCRN43150	12, 48	NSYCRN75250P	12, 48	NSYCRTA10U	620
NSYCRN43150P	12, 48	NSYCRN75250T	12, 48	NSYCRTA12U	620
NSYCRN43150T	12, 48	NSYCRN86200	12, 48	NSYCRTA1U	620
NSYCRN43200	12, 48	NSYCRN86200P	12, 48	NSYCRTA2U	620
NSYCRN43200P	12, 48	NSYCRN86200T	12, 48	NSYCRTA3U	620
NSYCRN43200T	12, 48	NSYCRN86250	12, 48	NSYCRTA3UD	616
NSYCRN44200	12, 48	NSYCRN86250P	12, 48	NSYCRTA4U	620
NSYCRN44200P	12, 48	NSYCRN86250T	12, 48	NSYCRTA4UD	616
NSYCRN44200T	12, 48	NSYCRN86300	12, 48	NSYCRTA5U	620
NSYCRN46250	12, 48	NSYCRN86300P	12, 48	NSYCRTA6U	620
NSYCRN46250P	12, 48	NSYCRN86300T	12, 48	NSYCRTA9U	620
NSYCRN46250T	12, 48	NSYCRN88200	12, 48	NSYCRTM10U	620
NSYCRN46300	12, 48	NSYCRN88200P	12, 48	NSYCRTM12U	620
NSYCRN46300T	12, 48	NSYCRN88200T	12, 48	NSYCRTM1U	620
NSYCRN54150	12, 48	NSYCRN88300	12, 48	NSYCRTM1U1P	619
NSYCRN54150P	12, 48	NSYCRN88300P	12, 48	NSYCRTM1U1PG	619
NSYCRN54150T	12, 48	NSYCRN88300T	12, 48	NSYCRTM1U1PS	571, 619
NSYCRN54200	12, 48	NSYCRNCGPSTDSB	726	NSYCRTM1U2	619
NSYCRN54200P	12, 48	NSYCRNG1010300D	53	NSYCRTM1U2G	619
NSYCRN54200T	12, 48	NSYCRNG1010300T	53	NSYCRTM1U32B	619
NSYCRN54250	12, 48	NSYCRNG1012300D	53	NSYCRTM1U40B	619
NSYCRN54250P	12, 48	NSYCRNG1012400D	53	NSYCRTM1U40BG	619
NSYCRN54250T	12, 48	NSYCRNG106400	53	NSYCRTM1U5GCA	619
NSYCRN55250	12, 48	NSYCRNG106400T	53	NSYCRTM1UA2	619
NSYCRN55250P	12, 48	NSYCRNG108400	53	NSYCRTM1UG	620
NSYCRN55250T	12, 48	NSYCRNG108400T	53	NSYCRTM1UVT	620
NSYCRN64150	12, 48	NSYCRNG1210300D	53	NSYCRTM1UVTD	620
NSYCRN64150P	12, 48	NSYCRNG1210400D	53	NSYCRTM1UVTG	620

Index of references

N	Page	N	Page	N	Page
NSYCR2M2U	620	NSYCU1800W400VL	691	NSYCUB2700W230S	691
NSYCR2M2U3	619	NSYCU1K	681, 690, 691, 736, 738	NSYCUB2700W400S	691
NSYCR2M2UG	620	NSYCU1K2	681, 690, 736, 738	NSYCU1K1T1K5	691
NSYCR2M2US	619	NSYCU1K22P4	681, 690, 736, 738	NSYCU1K2T2K	691
NSYCR2M3U	620	NSYCU1K2P4	681, 690, 736, 738	NSYCU3KT4K	691
NSYCR2M3UD	616	NSYCU1K2P4UL	681, 690, 736, 738	NSYCU400	691
NSYCR2M3UDG	616	NSYCU1K2R	684, 690, 740, 741	NSYCU600	691
NSYCR2M3UG	620	NSYCU1K2RUL	684, 690, 740, 741	NSYCU800T1K	691
NSYCR2M4U	620	NSYCU1K2UL	681, 690, 736, 738	NSYCUE1100W230L	691
NSYCR2M5U	620	NSYCU1K5R	685, 690, 740, 741	NSYCUE1400W230L	691
NSYCR2M6U	620	NSYCU1K5RUL	685, 690, 740, 741	NSYCUE1400W230R	691
NSYCR2M9U	620	NSYCU1K6	681, 690, 736, 738	NSYCUE1400W400L	691
NSYCR2MR1U	620	NSYCU1K62P4	681, 690, 736, 738	NSYCUE1800W400L	691
NSYCR2MR3U	620	NSYCU1K62P4UL	681, 690, 736, 738	NSYCUE1800W400R	691
NSYCS200PLM	27, 215, 224	NSYCU1K6UL	681, 690, 736, 738	NSYCUF1K1T2KS	691
NSYCS300PLM	27, 224	NSYCU1KUL	681, 690, 736, 738	NSYCUF1K2T2KR	691
NSYCS400PLM	27, 224	NSYCU2000W400VR	691	NSYCUF1KT2K	691
NSYCS500PLM	27, 224	NSYCU240W230VL	691	NSYCUF3KT4K	691
NSYCS600PLM	27, 224	NSYCU2450W400VR	691	NSYCUF3KT4KR	691
NSYCS800PLM	27, 224	NSYCU2500W400VL	691	NSYCUF400	691
NSYCSA57	449	NSYCU2K	681, 690, 737, 739	NSYCUF400R	691
NSYCSA68	449	NSYCU2K3P4	682, 690, 737, 739	NSYCUF600	691
NSYCSA810	449	NSYCU2K3P4R	685, 690, 740, 741	NSYCUF6K	691
NSYCSH126	352	NSYCU2K3P4RUL	685, 690, 740, 741	NSYCUF800R	691
NSYCSH128	352	NSYCU2K3P4UL	682, 690, 737, 739	NSYCUF800T1K	691
NSYCSH146	352	NSYCU2KR	685, 690, 740, 741	NSYCUFX1K1T2KS	691
NSYCSH148	352	NSYCU2KUL	681, 690, 737, 739	NSYCUFX1K2T2K	691
NSYCSH166	352	NSYCU300H	680, 690, 736, 738	NSYCUFX1K2T2KR	691
NSYCSH168	352	NSYCU3100W400VR	691	NSYCUFX3KT4K	691
NSYCSH186	352, 353	NSYCU370W230VL	691	NSYCUFX3KT4KR	691
NSYCSH188	352	NSYCU3K3P4	683, 690, 737, 739	NSYCUFX400	691
NSYCSH206	352	NSYCU3K3P4R	685, 690, 740, 741	NSYCUFX400R	691
NSYCSH208	352	NSYCU3K3P4RUL	685, 690, 740, 741	NSYCUFX600	691
NSYCSHB2010	352	NSYCU3K3P4UL	683, 690, 737, 739	NSYCUFX6K	691
NSYCSHB2012	352	NSYCU400	680, 690, 736, 738	NSYCUFX800R	691
NSYCSF	122	NSYCU4000W400VL	691	NSYCUFX800T1K	691
NSYCSF6G	454	NSYCU400R	684, 690, 740, 741	NSYCUHD1K	687, 690, 742
NSYCSSF	727	NSYCU400RUL	684, 690, 740, 741	NSYCUHD1K2P4	687, 690, 742
NSYCSSFHD	733	NSYCU400UL	680, 690, 736, 738	NSYCUHD1K6	687, 690, 742
NSYCTL300DLAG	227	NSYCU4K3P4	683, 690, 737, 739	NSYCUHD1K62P4	687, 690, 742
NSYCTL300DLM	50, 349	NSYCU4K3P4R	685, 690, 740, 741	NSYCUHD2K3P4	687, 690, 742
NSYCTL400DLAG	227	NSYCU4K3P4RUL	685, 690, 740, 741	NSYCUHD3K3P4	687, 690, 742
NSYCTL400DLM	50, 349	NSYCU4K3P4UL	683, 690, 737, 739	NSYCUHD400	686, 690, 742
NSYCTL500DLAG	227	NSYCU600	680, 690, 736, 738	NSYCUHD4K3P4	687, 690, 742
NSYCTL500DLM	50, 349	NSYCU600UL	680, 690, 736, 738	NSYCUHD600	686, 690, 742
NSYCTL500DLP2	250, 256	NSYCU6K3P4	683, 690, 737, 739	NSYCUHD800	686, 690, 742
NSYCTL500DLPG	250, 256	NSYCU760W230VL	691	NSYCUNPL1000	597
NSYCTL600DLAG	227	NSYCU760W230VR	691	NSYCUNPL800	597
NSYCTL600DLM	50, 54, 349	NSYCU800	680, 690, 736, 738	NSYCUNVDA	597
NSYCTL750DLP2	250, 256	NSYCU800R	684, 690, 740, 741	NSYCUS1K12P4UL	688, 690, 743
NSYCTL750DLPG	250, 256	NSYCU800RUL	684, 690, 740, 741	NSYCUS1K1UL	688, 690, 743
NSYCTL800DLAG	227	NSYCU800UL	680, 690, 736, 738	NSYCUS1K52P4UL	688, 690, 743
NSYCTL800DLM	50, 54, 349	NSYCUAD	684	NSYCUS1K5UL	688, 690, 743
NSYCTOPB	568	NSYCUB1100W230S	691	NSYCUS2K3P4UL	689, 690, 743
NSYCTVDA	576, 607	NSYCUB1100W400S	691	NSYCUS2K53P4UL	689, 690, 743
NSYCU1050W230VR	691	NSYCUB1500W230S	691	NSYCUS2K5UL	689, 690, 743
NSYCU1460W230VR	691	NSYCUB1500W400S	691	NSYCUS2KUL	689, 690, 743
NSYCU1650W230VL	691	NSYCUB2200W230S	691	NSYCUS3K23P4UL	689, 690, 743
NSYCU1650W230VR	691	NSYCUB2200W400S	691	NSYCUS3K2UL	689, 690, 743

Index of references

N	Page	N	Page	N	Page
NSYCUSP0001	736	NSYCUSP0067	738	NSYCUSP0132	743
NSYCUSP0002	736, 742	NSYCUSP0068	738	NSYCUSP0133	743
NSYCUSP0003	736, 742	NSYCUSP0069	738	NSYCUSP0134	743
NSYCUSP0004	736, 742	NSYCUSP0070	738, 739	NSYCUSP0135	743
NSYCUSP0005	736	NSYCUSP0071	739	NSYCUSP0136	734, 736, 737, 740, 742, 743
NSYCUSP0006	736, 737, 742	NSYCUSP0072	741	NSYCUSP0137	734, 737, 740, 742, 743
NSYCUSP0007	737, 742	NSYCUSP0073	741	NSYCUSP0138	734, 736, 737, 742, 743
NSYCUSP0008	740	NSYCUSP0074	741	NSYCUSP0139	737, 743
NSYCUSP0009	740	NSYCUSP0075	741	NSYCUSP0140	743
NSYCUSP0010	740	NSYCUSP0076	734	NSYCUSP0141	743
NSYCUSP0011	740	NSYCUSP0077	734	NSYCUSP0142	743
NSYCUSP0012	740	NSYCUSP0078	734	NSYCUSP0143	743
NSYCUSP0013	736	NSYCUSP0079	734	NSYCUSP0144	738, 739, 741, 743
NSYCUSP0014	736	NSYCUSP0080	734	NSYCUSP0145	743
NSYCUSP0015	736	NSYCUSP0081	734	NSYCUSP0146	743
NSYCUSP0016	736	NSYCUSP0082	734	NSYCUSP0147	739, 741, 743
NSYCUSP0017	736	NSYCUSP0084	734	NSYCUSP0148	739, 741, 743
NSYCUSP0018	736	NSYCUSP0085	738	NSYCUSP0149	743
NSYCUSP0019	736	NSYCUSP0086	738	NSYCUSP0150	743
NSYCUSP0020	737	NSYCUSP0087	738	NSYCUSP0151	743
NSYCUSP0021	737	NSYCUSP0088	738, 739	NSYCUSP0152	743
NSYCUSP0022	737	NSYCUSP0089	739	NSYCUSP0153	742
NSYCUSP0023	740	NSYCUSP0090	741	NSYCUSP0154	742
NSYCUSP0024	740	NSYCUSP0091	741	NSYCUSP0155	742
NSYCUSP0025	740	NSYCUSP0092	741	NSYCUSP0156	742
NSYCUSP0026	740	NSYCUSP0093	741	NSYCUSP0157	742
NSYCUSP0027	740	NSYCUSP0094	734	NSYCUSP0158	742
NSYCUSP0028	740	NSYCUSP0095	734	NSYCUSP0159	742
NSYCUSP0029	740	NSYCUSP0099	738, 739, 741	NSYCUSP0160	742
NSYCUSP0030	734	NSYCUSP0100	734, 735, 742	NSYCUSP0161	742
NSYCUSP0031	734	NSYCUSP0101	738, 742	NSYCUSP0162	742
NSYCUSP0032	734	NSYCUSP0102	738	NSYCUSP0163	742
NSYCUSP0033	734	NSYCUSP0103	738, 742	NSYCUSP0164	742
NSYCUSP0034	734	NSYCUSP0104	739, 741, 742	NSYCUSP0165	742
NSYCUSP0035	734	NSYCUSP0105	739, 741, 742	NSYCUSP0166	743
NSYCUSP0036	734	NSYCUSP0106	741	NSYCUSP0167	742
NSYCUSP0037	734	NSYCUSP0107	735	NSYCUSP0168	742
NSYCUSP0038	734	NSYCUSP0108	735	NSYCUSP0169	742
NSYCUSP0041	734	NSYCUSP0109	735	NSYCUSP0170	742
NSYCUSP0042	734, 736, 742	NSYCUSP0111	734	NSYCUSP0171	742
NSYCUSP0043	734, 736, 740, 742	NSYCUSP0112	734	NSYCUSP0172	740
NSYCUSP0044	734, 736, 740, 742	NSYCUSP0113	734	NSYCUSP0173	738
NSYCUSP0047	740	NSYCUSP0114	735	NSYCUSP0174	738
NSYCUSP0049	740	NSYCUSP0115	735	NSYCUSP0177	734
NSYCUSP0051	740	NSYCUSP0117	735	NSYCUSP0181	734
NSYCUSP0053	734	NSYCUSP0118	738	NSYCUSP0184	734
NSYCUSP0054	736	NSYCUSP0119	738	NSYCUSX1K12P4UL	688, 690, 743
NSYCUSP0055	736, 742	NSYCUSP0120	738, 739	NSYCUSX1K1IUL	688, 690, 743
NSYCUSP0056	736, 742	NSYCUSP0121	741	NSYCUSX1K52P4UL	688, 690, 743
NSYCUSP0057	736, 742	NSYCUSP0122	741	NSYCUSX1K5IUL	688, 690, 743
NSYCUSP0058	736	NSYCUSP0123	741	NSYCUSX2K3P4UL	690, 743
NSYCUSP0059	736, 740, 742, 743	NSYCUSP0124	735	NSYCUSX2K53P4UL	690, 743
NSYCUSP0060	737, 740	NSYCUSP0125	735	NSYCUSX2K5IUL	690, 743
NSYCUSP0061	737, 740, 742	NSYCUSP0126	738	NSYCUSX2KUL	690, 743
NSYCUSP0062	737, 740, 742, 743	NSYCUSP0127	738	NSYCUSX3K23P4UL	690, 743
NSYCUSP0063	737, 740, 742, 743	NSYCUSP0128	739	NSYCUSX3K2IUL	690, 743
NSYCUSP0064	740	NSYCUSP0129	741	NSYCUX1K	681, 690, 736, 738
NSYCUSP0065	740	NSYCUSP0130	743	NSYCUX1K2	681, 690, 736, 738
NSYCUSP0066	738	NSYCUSP0131	743	NSYCUX1K22P4	681, 690, 736, 738

Index of references

N	Page	N	Page	N	Page
NSYCUX1K2P4	681, 690, 736, 738	NSYCVF550M24FB	443, 656	NSYDCRN3045	726, 731
NSYCUX1K2P4UL	681, 690, 736, 738	NSYCVF560M115DG	647, 648	NSYDCRN33	726, 731
NSYCUX1K2R	684, 690, 740, 741	NSYCVF560M115PF	653, 665	NSYDCRN34	726, 731
NSYCUX1K2UL	681, 690, 736, 738	NSYCVF560M230DG	647, 648	NSYDCRN43	726, 731
NSYCUX1K5R	685, 690, 740, 741	NSYCVF560M230PF	653, 655, 661, 665	NSYDCRN44	726, 731
NSYCUX1K6	681, 690, 736, 738	NSYCVF570M115MF	662	NSYDCRN46	726, 731
NSYCUX1K62P4	681, 690, 736, 738	NSYCVF575M230MF	662	NSYDCRN54	726
NSYCUX1K62P4UL	681, 690, 736, 738	NSYCVF65M115PF	662	NSYDCRN55	726, 731
NSYCUX1K6UL	681, 690, 736, 738	NSYCVF65M230PF	662	NSYDCRN64	726
NSYCUX1KUL	681, 690, 736, 738	NSYCVF850M115DG	647, 648	NSYDCRN65	726
NSYCUX2K	681, 690, 737, 739	NSYCVF850M115PF	653, 665	NSYDCRN66	726, 731
NSYCUX2K3P4	682, 690, 737, 739	NSYCVF850M230DG	647, 648	NSYDCRN68	726, 731
NSYCUX2K3P4R	685, 690, 740, 741	NSYCVF850M230PF	653, 655, 661, 665	NSYDCRN75	726
NSYCUX2K3P4UL	682, 690, 737, 739	NSYCVF850M400DG	647, 648	NSYDCRN86	726, 731
NSYCUX2KR	685, 690, 740, 741	NSYCVF850M400PF	653	NSYDCRN88	726
NSYCUX2KUL	681, 690, 737, 739	NSYCVF85M115DG	647, 648	NSYDCRNG105L	726
NSYCUX3K3P4	683, 690, 737, 739	NSYCVF85M115PF	653	NSYDCRNG105R	726
NSYCUX3K3P4R	685, 690, 740, 741	NSYCVF85M230DG	647, 648	NSYDCRNG106	726
NSYCUX3K3P4UL	683, 690, 737, 739	NSYCVF85M230PF	653, 655, 661	NSYDCRNG106L	726
NSYCUX400	680, 690, 736, 738	NSYCVF85M24DPF	653	NSYDCRNG106R	726
NSYCUX400R	684, 690, 740, 741	NSYCVF85M48DPF	653	NSYDCRNG108	726
NSYCUX4K3P4	683, 690, 737, 739	NSYCW33	322	NSYDCRNG125L	726
NSYCUX4K3P4R	685, 690, 740, 741	NSYCW44	322	NSYDCRNG125R	726
NSYCUX4K3P4UL	683, 690, 737, 739	NSYCW45	322	NSYDCRNG126	726
NSYCUX600	680, 690, 736, 738	NSYCW46	322	NSYDCRNG126L	726
NSYCUX600UL	680, 690, 736, 738	NSYCW54	322	NSYDCRNG126R	726
NSYCUX800	680, 690, 736, 738	NSYCW55	322	NSYDCRNG128	726
NSYCUX800R	684, 690, 740, 741	NSYCW56	322	NSYDCRNG145L	726
NSYCUX800UL	680, 690, 736, 738	NSYCW65	322	NSYDCRNG145R	726
NSYCV114M	663	NSYCW66	322	NSYDCRNG85L	726
NSYCV178M	663	NSYCW86	322	NSYDCRNG85R	726
NSYCVAC100	663	NSYDB1010M	10, 34	NSYDCRNG86	726
NSYCVF156M115	662	NSYDB1510M	10, 34	NSYDCRNG86L	726
NSYCVF156M230	662	NSYDB2015M	10, 34	NSYDCRNG86R	726
NSYCVF165M115DG	647, 648	NSYDB88M	10, 34	NSYDCSH1412	352
NSYCVF165M115PF	653	NSYDBN1010	10, 34	NSYDCSH1612	352
NSYCVF165M230DG	647, 648	NSYDBN1510	10, 34	NSYDCSH1812	352
NSYCVF165M230PF	653, 655, 661	NSYDBN2015	10, 34	NSYDCSH1816	352
NSYCVF165M24DPF	653	NSYDBN2520	10, 34	NSYDCSH2012	352, 353
NSYCVF165M48DPF	653	NSYDBN3025	10, 34	NSYDCSH2016	352, 353
NSYCVF170M115	663	NSYDBN88	10, 34	NSYDHLT6060	280
NSYCVF170M230	663	NSYDCD2412	91, 93, 302	NSYDHLT6080	280
NSYCVF300M115DG	647, 648	NSYDCD244	91, 93, 302	NSYDHLT8060	280
NSYCVF300M115PF	653	NSYDCD248	91, 93, 302	NSYDHLT8080	280
NSYCVF300M230DG	647, 648	NSYDCD249	91, 93, 302	NSYDHSF	727, 728
NSYCVF300M230PF	653, 655, 661	NSYDCE10	133	NSYDHSM2D	728
NSYCVF300M24DPF	653	NSYDCE12	133	NSYDLA112G	15, 27, 50, 54, 75, 226
NSYCVF300M48DPF	653	NSYDCE168	91, 95, 302	NSYDLA234G	15, 27, 50, 54, 75, 226
NSYCVF35M115	662	NSYDCE2410	91, 95, 302	NSYDLA24G	15, 27, 50, 75, 226
NSYCVF35M230	662	NSYDCE244	91, 95, 302	NSYDLA48G	15, 27, 50, 75, 226
NSYCVF38M115DG	647, 648	NSYDCE6	133	NSYDLA48PG	15, 27, 50, 75, 226
NSYCVF38M115PF	653	NSYDCE8	133	NSYDLA66G	15, 27, 50, 75, 226
NSYCVF38M230DG	647, 648	NSYDCM20	142, 318	NSYDLA84G	15, 27, 50, 54, 75, 226
NSYCVF38M230PF	653	NSYDCRN106	726	NSYDLA88G	27, 50, 226
NSYCVF38M24DPF	653	NSYDCRN108	726	NSYDLCR110	50, 350
NSYCVF38M48DPF	653	NSYDCRN22	726, 731	NSYDLCR135	50, 350
NSYCVF54M230MM2	662	NSYDCRN23	726, 731	NSYDLCR18	50, 350
NSYCVF550M115FB	443, 656	NSYDCRN2520	726, 731	NSYDLCR24	50, 350
NSYCVF550M230FB	443, 656	NSYDCRN3025	726, 731	NSYDLCR36	50, 350

Index of references

N	Page	N	Page	N	Page
NSYDLCR48	50, 350	NSYDPHD127P	732	NSYDPR200T	284
NSYDLCR64	50, 350	NSYDPHD127R	732	NSYDPR25	283
NSYDLCR88	50, 350	NSYDPHD155LP	732	NSYDPR35	283
NSYDLSDF	731	NSYDPHD155LR	732	NSYDPR45	283
NSYDLM112	15, 17, 24, 50, 54, 62, 75, 166, 349	NSYDPHD157P	732	NSYDPR55	283
NSYDLM168	15, 17, 50, 54, 62, 75, 349	NSYDPHD157R	732	NSYDPR60	283
NSYDLM24	15, 17, 24, 50, 62, 75, 166, 349	NSYDPHD55P	732	NSYDPR65	283
NSYDLM240	15, 17, 24, 50, 54, 62, 75, 166, 349	NSYDPHD55R	732	NSYDPR75	283
NSYDLM48	15, 17, 24, 50, 62, 75, 166, 349	NSYDPHD75P	732	NSYDPR80	283
NSYDLM48P	15, 17, 24, 50, 62, 75, 166, 349	NSYDPHD75R	732	NSYS3D1010	724
NSYDLM66	15, 17, 24, 50, 62, 75, 166, 349	NSYDPHD77P	732	NSYS3D105L	724
NSYDLM84	15, 17, 24, 50, 54, 62, 75, 166, 349	NSYDPHD77R	732	NSYS3D105R	724
NSYDLM84P	15, 17, 24, 50, 62, 75, 166, 349	NSYDPLA105G	730	NSYS3D106	724
NSYDLM88	17, 24, 50, 62, 166, 349	NSYDPLA105HG	730	NSYS3D106L	724
NSYDLP114G	30, 248	NSYDPLA107G	730	NSYS3D106R	724
NSYDLP114PG	30, 248	NSYDPLA107HG	730	NSYS3D108	724, 732
NSYDLP132G	30, 248	NSYDPLA125G	730	NSYS3D1210	724
NSYDLP133G	30, 248	NSYDPLA125HG	730	NSYS3D125L	724
NSYDLP152G	30, 248	NSYDPLA127G	730	NSYS3D125R	724
NSYDLP165G	30, 248	NSYDPLA127HG	730	NSYS3D126	724
NSYDLP171G	30, 248	NSYDPLA155G	730	NSYS3D126L	724
NSYDLP198G	30, 248	NSYDPLA155HG	730	NSYS3D126R	724
NSYDLP198PG	30, 248	NSYDPLA157G	730	NSYS3D128	724
NSYDLP231G	30, 248	NSYDPLA157HG	730	NSYS3D145L	724
NSYDLP264G	30, 248	NSYDPLA3	250	NSYS3D145R	724
NSYDLP297G	30, 248	NSYDPLA4	250	NSYS3D32	724, 732
NSYDLP57G	30, 248	NSYDPLA55G	730	NSYS3D325	724
NSYDLP76G	30, 248	NSYDPLA55HG	730	NSYS3D33	724, 732
NSYDLP95G	30, 248	NSYDPLA57G	730	NSYS3D34	724
NSYDLP99G	30, 248	NSYDPLA57HG	730	NSYS3D43	724, 732
NSYDPLM18G	27, 227	NSYDPLA6	250	NSYS3D44	724, 732
NSYDLS12	201	NSYDPLA75G	730	NSYS3D46	724
NSYDLS24	201	NSYDPLA75HG	730	NSYS3D53	724
NSYDLS242	201	NSYDPLA77G	730	NSYS3D54	724, 732
NSYDLS36	201	NSYDPLA77HG	730	NSYS3D55	724
NSYDLS48	201	NSYDPLM108G	731	NSYS3D64	724, 732
NSYDLSD10	731	NSYDPLM108TG	731	NSYS3D65	724
NSYDLSD12	731	NSYDPLM200	27, 224	NSYS3D66	724, 732
NSYDLSD6	731	NSYDPLM250	27, 224	NSYS3D68	724
NSYDLSD8	731	NSYDPLM300	27, 224	NSYS3D75	724, 732
NSYDLSDF10	731	NSYDPLM3025G	731	NSYS3D810	724
NSYDLSDF12	731	NSYDPLM3025TG	731	NSYS3D85L	724
NSYDLSDF16	731	NSYDPLM32G	731	NSYS3D85R	724
NSYDLSDF8	731	NSYDPLM32TG	731	NSYS3D86	724, 732
NSYDPA3	141, 318, 651	NSYDPLM350	27, 224	NSYS3D86L	724
NSYDPA4	141, 318, 651	NSYDPLM43G	731	NSYS3D86R	724
NSYDPA44	141, 318, 651	NSYDPLM43TG	731	NSYS3D88	724
NSYDPA5	141, 318, 651	NSYDPLM54G	731	NSYS3HD106	733
NSYDPHD105P	732	NSYDPLM54TG	731	NSYS3HD108	733
NSYDPHD105R	732	NSYDPLM64G	731	NSYS3HD32	733
NSYDPHD107P	732	NSYDPLM64TG	731	NSYS3HD43	733
NSYDPHD107R	732	NSYDPLM75G	731	NSYS3HD54	733
NSYDPHD125LP	732	NSYDPLM75TG	731	NSYS3HD64	733
NSYDPHD125LR	732	NSYDPLM86G	731	NSYS3HD66	733
NSYDPHD125P	732	NSYDPLM86TG	731	NSYS3HD75	733
NSYDPHD125R	732	NSYDPR100	283	NSYS3HD86	733
		NSYDPR120	283	NSYS3HD88	733
		NSYDPR200	284	NSYS3X1010L	729
		NSYDPR200D	284	NSYS3X1010LH	729

Index of references

N	Page	N	Page	N	Page
NSYDS3X1010R	729	NSYDSFX2012LH	729	NSYEC441	20, 116, 132
NSYDS3X1010RH	729	NSYDSFX2012R	729, 730	NSYEC45	20, 116, 131
NSYDS3X108	729	NSYDSFX2012RH	729	NSYEC451	20, 116, 132
NSYDS3X108H	729	NSYDSFX2016L	729, 730	NSYEC461	20, 116, 132, 433
NSYDS3X108T	729	NSYDSFX2016LH	729	NSYEC462	20, 116, 132
NSYDS3X1210L	729	NSYDSFX2016R	729, 730	NSYEC481	20, 116, 132, 433
NSYDS3X1210LH	729	NSYDSFX2016RH	729	NSYEC482	20, 116, 132
NSYDS3X1210R	729	NSYDSFX206	729, 730	NSYEC610	474
NSYDS3X1210RH	729	NSYDSFX208	729, 730	NSYEC6101	474
NSYDS3X128	729	NSYDT16	99, 195, 307	NSYEC6102	475
NSYDS3X128H	729	NSYDT20	99, 195, 307	NSYEC64	20, 116, 131, 433
NSYDS3X32	729	NSYDT25	99, 195, 307	NSYEC641	20, 116, 132
NSYDS3X325	729	NSYDT32	99, 195, 307	NSYEC65	20, 116, 131
NSYDS3X325H	729	NSYDT40	99, 195, 307	NSYEC651	20, 116, 132
NSYDS3X32H	729	NSYDTEF32T	707	NSYEC66	20, 116, 131, 433, 474
NSYDS3X33	729	NSYE1025	288	NSYEC661	20, 116, 132, 433, 474
NSYDS3X33H	729	NSYE1525	288	NSYEC662	20, 116, 132, 433, 475
NSYDS3X43	729	NSYE2025	288	NSYEC68	20, 116, 131, 433, 474
NSYDS3X43H	729	NSYEB1510D6	157, 323, 494	NSYEC681	20, 116, 132, 433, 474
NSYDS3X43T	729	NSYEB1516D8	323, 433, 494	NSYEC682	20, 116, 132, 433, 475
NSYDS3X44	729	NSYEB156D6	157, 323, 494	NSYEC7	91, 97, 192, 194, 306
NSYDS3X44H	729	NSYEB2025D8	323, 433, 494	NSYEC751	398
NSYDS3X46	729	NSYEB2050D8	323, 433, 494	NSYEC761	398
NSYDS3X46H	729	NSYEBMPLAG	244	NSYEC781	398
NSYDS3X54	729	NSYEC104	20, 116, 131	NSYEC810	474
NSYDS3X54H	729	NSYEC1041	20, 116, 132	NSYEC8101	474
NSYDS3X54T	729	NSYEC105	20, 116, 131	NSYEC8102	475
NSYDS3X64	729	NSYEC1051	20, 116, 132	NSYEC84	20, 116, 131, 433
NSYDS3X64H	729	NSYEC106	20, 116, 131	NSYEC841	20, 116, 132
NSYDS3X64T	729	NSYEC1061	20, 116, 132	NSYEC85	20, 116, 131
NSYDS3X66	729	NSYEC1062	20, 116, 132	NSYEC851	20, 116, 132
NSYDS3X66H	729	NSYEC108	20, 116, 131	NSYEC86	20, 116, 131, 433, 474
NSYDS3X75	729	NSYEC1081	20, 116, 132	NSYEC861	20, 116, 132, 433, 474
NSYDS3X75H	729	NSYEC1082	20, 116, 132	NSYEC862	20, 116, 132, 433, 475
NSYDS3X75T	729	NSYEC124	20, 116, 131	NSYEC88	20, 116, 131, 433, 474
NSYDS3X86	729	NSYEC1241	20, 116, 132	NSYEC881	20, 116, 132, 433, 474
NSYDS3X86H	729	NSYEC125	20, 116, 131	NSYEC882	20, 116, 132, 433, 475
NSYDS3X86T	729	NSYEC1251	20, 116, 132	NSYECA22	287, 333
NSYDS3X88	729	NSYEC126	20, 116, 131	NSYECA42	287, 333
NSYDS3X88H	729	NSYEC1261	20, 116, 132	NSYECA44	287, 333
NSYDSFX1410L	729	NSYEC1262	20, 116, 132	NSYECAV300	566
NSYDSFX1410R	729	NSYEC128	20, 116, 131	NSYECAV440	477, 600
NSYDSFX168	729	NSYEC1281	20, 116, 132	NSYECB1M153	157, 323
NSYDSFX1812L	729, 730	NSYEC1282	20, 116, 132	NSYECPC300	560, 561, 566
NSYDSFX1812LH	729	NSYEC164	20, 116, 131	NSYECPC440	477, 600
NSYDSFX1812R	729, 730	NSYEC1641	20, 116, 132	NSYECPC15	91, 96, 192, 193, 305
NSYDSFX1812RH	729	NSYEC165	20, 116, 131	NSYECPC3	91, 96, 192, 193, 305
NSYDSFX1816L	729	NSYEC1651	20, 116, 132	NSYECPC5	91, 96, 192, 193, 305
NSYDSFX1816LH	729	NSYEC166	20, 116, 131	NSYECPC6	91, 96, 192, 193, 305
NSYDSFX1816R	729	NSYEC1661	20, 116, 132	NSYECPC9	91, 96, 192, 193, 305
NSYDSFX1816RH	729	NSYEC1662	20, 116, 132	NSYECPL1000	601
NSYDSFX186	729, 730	NSYEC300	566	NSYECPL600	601
NSYDSFX188	729, 730	NSYEC35	20, 116, 131	NSYECPL800	601
NSYDSFX188H	729	NSYEC351	20, 116, 132, 398	NSYECPLAZ103G	31, 237
NSYDSFX2010L	729, 730	NSYEC36	20, 116, 131, 433	NSYECPLAZ104G	31, 237
NSYDSFX2010LH	729	NSYEC361	20, 116, 132, 398, 433	NSYECPLAZ123G	31, 237
NSYDSFX2010R	729, 730	NSYEC381	20, 116, 398, 433	NSYECPLAZ124G	31, 237
NSYDSFX2010RH	729	NSYEC44	20, 116, 131	NSYECPLAZ126G	31, 237
NSYDSFX2012L	729, 730	NSYEC440	477, 600	NSYECPLAZ53G	31, 237

Index of references

N	Page	N	Page	N	Page
NSYECPLAZ54G	31, 237	NSYFCG160	308	NSYGT40	611
NSYECPLAZ73G	31, 237	NSYFCG60	308	NSYGT60	611
NSYECPLAZ74G	31, 237	NSYFCG80	308	NSYGT80	611
NSYECPLAZ76G	31, 237	NSYFCMX	179	NSYHLCR40	277, 281, 454
NSYECPT300	566	NSYFDLSD	731	NSYHLCR50	277, 281
NSYECS400	601	NSYFECVT440	476, 602	NSYHLCR60	277, 281, 454
NSYECVT2440	477, 602	NSYFMPHD	437	NSYHLCR70	277, 281
NSYECVT2V440	477, 602	NSYFMPLA	237	NSYHLCR80	277, 281, 454
NSYECVT300	560, 561, 566	NSYFNM6	271, 291	NSYHPF2B3M4	428
NSYECVT3440	477, 602	NSYFNM8	271, 291	NSYHPF2B3M64	428
NSYECVT3V440	477, 602	NSYFPLS1827G	200	NSYHPF2B3M65	428
NSYEDCO	272	NSYFPLS2727G	200	NSYHPF2B3M84	428
NSYEDCOC	272	NSYFPLS2736G	200	NSYHPF2B3M85	428
NSYEDCOS	323	NSYFPLS2754G	200	NSYHS3X	729
NSYEDPLA	250	NSYFPLS3636G	200	NSYHSD	731
NSYEL136D6	157, 323	NSYFPLS3654G	200	NSYHSDF	731
NSYEL166D6	157, 323	NSYFPLS3672G	200	NSYHSMX	730
NSYEL166D8	157, 323, 399, 433	NSYFPLS5454G	200	NSYID166	19, 115, 139
NSYEL1710D6	157, 323	NSYFPLS5472G	200	NSYID168	19, 115, 139
NSYEL2225D8	157, 323, 433	NSYFSPLAZ	241	NSYID1810	19, 115, 139
NSYEL226D13	157, 323, 520, 521	NSYFXMNT60F	366	NSYID186	19, 115, 139
NSYEL226D6	157, 323	NSYFXMNT80F	366	NSYID188	19, 115, 139
NSYEL2510D6	157, 323	NSYFXMNT80W	366	NSYID2010	19, 115, 139
NSYEL3525D8	157, 323, 399, 433	NSYFXMNW80F	366	NSYID206	19, 115, 139
NSYEMA20	286, 332	NSYFXMNW80W	366	NSYID208	19, 115, 139
NSYEMA40	286, 332	NSYFXMNWT60FW	366	NSYID226	139
NSYEN20	287	NSYFXT6040	279	NSYID228	139
NSYEN40	287	NSYFXT6050	279	NSYIEC13IEC14	572
NSYEN60	287	NSYFXT6060	279, 528	NSYIEC13SCH	572
NSYENU	603	NSYFXT8040	279	NSYIN1242E1	144, 243
NSYETF	272	NSYFXT8050	279	NSYIN1242E2	145, 243
NSYETU118	288, 334	NSYFXT8060	279	NSYIN1332E1	144, 243
NSYETU48	288, 334	NSYFXT8080	279	NSYIN2124E1	144, 243
NSYETU58	288, 334	NSYGB140	483, 611	NSYIN2131A1	144, 243
NSYETU79	288, 334	NSYGB140H5	611	NSYIN2132A1	144, 243
NSYEUVD	612	NSYGC1010	617	NSYIN2331A1	144, 243
NSYEVA20	286, 332	NSYGC1US19	618	NSYIN2433A1	144, 243
NSYEVA40	286, 332	NSYGC410	617	NSYIN2452E1	144, 243
NSYEX1006	288	NSYGA1010	617	NSYIN3113A1	144, 243
NSYEX1008	288	NSYGA410	617	NSYIN3122E1	144, 243
NSYEX106	288	NSYGA46	617	NSYIN3123A1	144, 243
NSYEX126	288	NSYGCH213	618	NSYIN3131A1	144, 243
NSYEX146	288	NSYGCP	618	NSYIN3133A1	144, 243
NSYEX158	288	NSYGDD	724	NSYIN3422E1	144, 243
NSYEX166	288	NSYGF140OPB	568	NSYIN3432E1	144, 243
NSYEX186	288	NSYGF200OPB	568	NSYIN405E1	144, 243
NSYEX206	288, 476, 600	NSYGF356	611	NSYIN421E1	144, 243
NSYEX208	288	NSYGF356H5	611	NSYIN4551	144, 243
NSYEX306	288	NSYGF456	611	NSYIN6101	144, 243
NSYEX308	288	NSYGF556	611	NSYINASSA2	145
NSYEX406	288	NSYGF556H5	611	NSYINDB31	144
NSYEX408	288	NSYGF656	611	NSYINDB51	144, 243
NSYEX506	288	NSYGF756	611	NSYINDIN2	145, 243
NSYEX508	288	NSYGF756H5	611	NSYINE11	144
NSYEX608	288	NSYGFR12M65	289, 608	NSYINF1301	144
NSYFB	264	NSYGFR166P	289, 484	NSYINF1401	144
NSYFB45	272, 430	NSYGFR95M55	289, 484, 608	NSYINICHEL8131	144
NSYFCG100	308	NSYGFR95M63	289, 484, 608	NSYINICHEL8371	144
NSYFCG120	308	NSYGFR95M65	289, 484, 608	NSYINKBA2	145

Index of references

N	Page	N	Page	N	Page
NSYINKFAC2	145, 243	NSYLL333	631	NSYMF32	12, 14, 24, 48, 74, 166, 260
NSYINKJIS2	145, 243	NSYLSS3X10	729	NSYMF33	12, 14, 24, 48, 74, 166, 260, 501
NSYINKR2	145, 243	NSYLSS3X12	729	NSYMF43	12, 14, 24, 27, 48, 74, 166, 220, 260, 501
NSYINLCRN	88, 318, 461, 464	NSYLSDDX	731	NSYMF44	12, 14, 24, 48, 74, 166, 260, 501, 518
NSYINPULS1	143	NSYLSSF14	729, 730	NSYMF53	14, 74, 260
NSYINS61	144, 243	NSYLSSF16	729, 730	NSYMF54	12, 14, 24, 27, 48, 74, 166, 220, 260, 501
NSYINS71	144, 243	NSYLSSF18	729, 730	NSYMF55	12, 14, 48, 74, 260
NSYINS81	144, 243	NSYLSSF20	729, 730	NSYMF64	12, 14, 24, 27, 48, 74, 166, 220, 260, 501, 518
NSYINS8G1	144	NSYLSUP	277	NSYMF65	12, 14, 48, 74, 260
NSYINT101	144	NSYLT27	204	NSYMF66	12, 14, 24, 48, 74, 166, 260, 501
NSYINT61	144, 243	NSYLT8	63, 64, 244, 433	NSYMF75	12, 14, 24, 27, 48, 74, 166, 220, 260, 501
NSYINT71	144	NSYMB106	13, 15, 49, 53, 75, 261	NSYMF86	12, 14, 24, 27, 48, 53, 74, 166, 220, 260, 501
NSYINT81	144, 243	NSYMB108	13, 15, 27, 49, 53, 75, 221, 261	NSYMF88	12, 14, 24, 48, 74, 166, 260
NSYINT91	144	NSYMB1210	15, 53, 75, 261	NSYMF8	271, 290
NSYJPSVD	567, 601, 605	NSYMB3025	13, 15, 27, 49, 75, 221, 261	NSYMF2M6	140, 431
NSYKDB12U6F	571	NSYMB32	13, 15, 27, 49, 75, 221, 261	NSYMF2M8	140, 431
NSYKDB15U6F	571	NSYMB33	13, 15, 49, 75, 261	NSYMF5M6	140, 431
NSYKDB6U4F	571	NSYMB43	13, 15, 27, 49, 75, 221, 261	NSYMF5M8	140, 431
NSYKDB9U4F	571	NSYMB54	13, 15, 27, 49, 75, 221, 261	NSYMFPLAZ103	31, 241
NSYKPLM	63, 223	NSYMB64	13, 15, 27, 49, 75, 221, 261	NSYMFPLAZ104	31, 241
NSYLADP	145	NSYMB65	13, 15, 49, 75, 261	NSYMFPLAZ123	31, 241
NSYLAM1M	314, 621	NSYMB75	13, 15, 27, 49, 75, 221, 261	NSYMFPLAZ124	31, 241
NSYLAM1MN	314, 621	NSYMB86	13, 15, 27, 49, 53, 75, 221, 261	NSYMFPLAZ126	31, 241
NSYLAM1MULN	314, 621	NSYMBBC206	428	NSYMFPLAZ53	31, 241
NSYLAM1U	314, 621	NSYMBBC208	428	NSYMFPLAZ54	31, 241
NSYLAM3M	314, 621	NSYMBHS4	424, 426	NSYMFPLAZ73	31, 241
NSYLAM3MDC	314, 621	NSYMBHS5	424, 426	NSYMFPLAZ74	31, 241
NSYLAM3MDCUL	314, 621	NSYMBR19	480	NSYMFPLAZ76	31, 241
NSYLAM3MN	314, 621	NSYMCDFIX	357	NSYMF51	357
NSYLAM3MUL	314, 621	NSYMCOD264	141	NSYMF51D	357
NSYLAM3MULN	314, 621	NSYMCOD284	141	NSYMF5C60	356
NSYLAMACF	315	NSYMD108	13, 15, 49, 53, 75, 261, 502	NSYMF5C60D	356
NSYLAMACM	315	NSYMD128	15, 53, 75, 261	NSYMF5C80	356
NSYLAMDCE	315	NSYMD33	13, 15, 49, 75, 261, 502	NSYMF5C80D	356
NSYLAMDCM	315	NSYMD43	13, 15, 49, 75, 261, 502	NSYMIC6	141, 429
NSYLAML	314, 621	NSYMD54	13, 15, 49, 75, 261, 502	NSYMIC8	141, 429
NSYLAMLDB	314, 621	NSYMD64	13, 15, 49, 75, 261, 502	NSYML23	529
NSYLAMLDD	314, 621	NSYMD66	13, 15, 49, 75, 261, 502	NSYML405SD	522
NSYLAMLDF	314, 621	NSYMD75	13, 15, 49, 75, 261, 502	NSYMLCD23	529
NSYLAMLDS	314, 621	NSYMD86	13, 15, 49, 53, 75, 261, 502	NSYMLS6	529
NSYLAMLDU	314, 621	NSYMDCM20	142, 318	NSYMLT6	529
NSYLAMLVD	314, 621	NSYMDV10	13, 15, 17, 49, 53, 75, 264	NSYMM1010	14, 24, 53, 74, 166, 260
NSYLAMPORLTD	316	NSYMDV12	15, 53, 75, 264	NSYMM106	12, 14, 17, 24, 48, 53, 74, 166, 260, 442
NSYLAMT5LD1	316	NSYMDV3	13, 15, 17, 49, 75, 264	NSYMM108	12, 14, 17, 24, 27, 48, 53, 74, 166, 220, 260, 442, 449, 501
NSYLAMT5LD1VDC	316	NSYMDV3M	264	NSYMM11SB	38, 40, 154
NSYLAMT5LD2	316	NSYMDV4	13, 15, 17, 49, 75, 264	NSYMM1210	14, 24, 53, 74, 166, 260
NSYLC7	63, 64, 244, 433	NSYMDV5	13, 15, 17, 49, 75, 264	NSYMM1212	14, 53, 74, 260
NSYLC8	63, 64, 244, 433	NSYMDV6	13, 15, 17, 49, 75, 264	NSYMM126	14, 24, 53, 74, 166, 260
NSYLCK12SF	727, 728	NSYMDV7	13, 15, 17, 49, 75, 264	NSYMM128	14, 24, 53, 74, 166, 260
NSYLCK14SF	727, 728	NSYMDV8	13, 15, 17, 49, 53, 75, 264	NSYMM12SB	38, 40
NSYLCK16SF	727, 728	NSYMF1010	14, 24, 53, 74, 166, 260	NSYMM13SB	38, 40, 154
NSYLCK18SF	727, 728	NSYMF106	12, 14, 24, 48, 53, 74, 166, 260, 501		
NSYLCK20SF	727, 728	NSYMF108	12, 14, 24, 27, 48, 53, 74, 166, 220, 260, 501		
NSYLCK22SF	727, 728	NSYMF1210	14, 24, 53, 74, 166, 260		
NSYLCKWSF	727, 728	NSYMF126	14, 24, 53, 74, 166, 260		
NSYLKR40	277	NSYMF128	14, 24, 53, 74, 166, 260		
NSYLKR50	277	NSYMF2PLAZ4	435, 437		
NSYLKR60	277	NSYMF2PLAZ6	435, 437		
NSYLD5	63, 64, 244, 433				

Index of references

N	Page	N	Page	N	Page
NSYMM1410	14, 53, 74, 260	NSYMP146	19, 21, 22, 115, 117, 118, 265	NSYMPC208	354
NSYMM14SB	38, 40	NSYMP148	19, 21, 22, 115, 117, 118, 265, 524	NSYMPC306	354
NSYMM22	12, 48, 260	NSYMP1610	19, 115, 265	NSYMPC308	354
NSYMM22SB	38, 40, 154	NSYMP1612	19, 115, 265, 442	NSYMPC406	354
NSYMM23	260	NSYMP166	19, 21, 22, 115, 117, 118, 265, 442	NSYMPC408	354
NSYMM23SB	38, 40, 154	NSYMP168	19, 21, 22, 25, 115, 117, 118, 178, 265, 442	NSYMPC456	354
NSYMM24SB	38, 40, 154	NSYMP16M6	410, 413, 414, 416	NSYMPC458	354
NSYMM2520	12, 48, 260	NSYMP16M8	410, 413, 414, 416	NSYMPC606	354
NSYMM2540	17, 260	NSYMP1810	19, 21, 22, 115, 117, 118, 265	NSYMPC608	354
NSYMM2550	17, 260	NSYMP1812	19, 21, 22, 25, 115, 117, 118, 178, 265	NSYMPCCH156	354
NSYMM25SB	38, 40	NSYMP1816	19, 25, 115, 178, 265	NSYMPCCH158	354
NSYMM26SB	38, 40	NSYMP184	21, 22, 117, 118, 265	NSYMPCCH206	354
NSYMM28SB	38, 40	NSYMP186	19, 21, 22, 25, 115, 117, 118, 178, 265	NSYMPCCH208	354
NSYMM3025	12, 14, 17, 24, 27, 48, 74, 166, 220, 260, 501	NSYMP188	19, 21, 22, 25, 115, 117, 118, 178, 265	NSYMPCCH306	354
NSYMM3045	12, 48, 260	NSYMP18M6	410	NSYMPCCH308	354
NSYMM32	12, 14, 17, 24, 27, 48, 74, 166, 220, 260, 442, 501	NSYMP18M8	410	NSYMPCCH406	354
NSYMM33	12, 14, 17, 24, 48, 74, 166, 260, 501	NSYMP2010	19, 21, 23, 25, 115, 117, 119, 178, 265	NSYMPCCH408	354
NSYMM33SB	38, 40, 154	NSYMP2012	19, 21, 23, 25, 115, 117, 119, 178, 265	NSYMPCCH456	354
NSYMM34SB	38, 40	NSYMP2016	19, 21, 23, 25, 115, 117, 119, 178, 265	NSYMPCCH458	354
NSYMM35SB	38, 40	NSYMP204	21, 23, 117, 119, 265	NSYMPCCH606	354
NSYMM36	17, 260	NSYMP206	19, 21, 23, 25, 115, 117, 119, 178, 265, 453	NSYMPCCH608	354
NSYMM36SB	38, 40	NSYMP208	19, 21, 23, 25, 115, 117, 119, 178, 265, 442, 453	NSYMPD106T	140
NSYMM38SB	38, 40	NSYMP20M6	410, 416	NSYMPD108T	140
NSYMM43	12, 14, 17, 24, 27, 48, 74, 166, 220, 260, 501	NSYMP20M8	410, 416	NSYMPD12M6	140, 431
NSYMM44	12, 14, 24, 48, 74, 166, 260, 501, 518	NSYMP2210	21, 23, 117, 119, 265	NSYMPD12M8	140, 431
NSYMM44SB	38, 40	NSYMP2212	21, 23, 117, 119, 265	NSYMPD16M6	140, 431
NSYMM45SB	38, 40	NSYMP224	21, 23, 117, 119, 265	NSYMPD16M8	140, 431
NSYMM46SB	38, 40	NSYMP226	21, 23, 117, 119, 265	NSYMPD18M6	140, 431
NSYMM48	17, 260	NSYMP228	21, 23, 117, 119, 265	NSYMPD18M8	140, 431
NSYMM48SB	38, 40	NSYMP24M6	410, 416	NSYMPD20M6	140, 431
NSYMM53	14, 17, 74, 260	NSYMP24M8	410, 416	NSYMPD20M8	140, 431
NSYMM54	12, 14, 17, 24, 27, 48, 74, 166, 220, 260, 442, 501	NSYMP3M6	410, 411, 412, 413, 414	NSYMPD24M6	140, 431
NSYMM55	12, 14, 48, 74, 260	NSYMP3M8	410, 411, 412, 413, 414	NSYMPD24M8	140, 431
NSYMM64	12, 14, 17, 24, 27, 48, 74, 166, 220, 260, 442, 501, 518	NSYMP4M6	410, 411, 412, 414, 415	NSYMPD26T	140
NSYMM65	12, 14, 17, 48, 74, 260	NSYMP4M8	410, 411, 412, 414, 415	NSYMPD28T	140
NSYMM66	12, 14, 17, 24, 48, 74, 166, 260, 442, 501	NSYMP5M6	410, 414, 415	NSYMPD3M6	140, 431
NSYMM75	12, 14, 17, 24, 27, 48, 74, 166, 220, 260, 442, 449, 501	NSYMP5M8	410, 414, 415	NSYMPD3M8	140, 431
NSYMM76	17, 260	NSYMP6M6	410, 411, 413	NSYMPD46T	140
NSYMM86	12, 14, 17, 24, 27, 48, 53, 74, 166, 220, 260, 442, 449, 501	NSYMP6M8	410, 411, 413	NSYMPD48T	140
NSYMM88	12, 14, 24, 48, 74, 166, 260, 442	NSYMP8M6	410	NSYMPD4M6	140, 431
NSYMP1210	19, 115, 265	NSYMP8M8	410	NSYMPD4M8	140, 431
NSYMP1212	19, 115, 265, 442	NSYMP9M6	410, 411, 413, 414, 416	NSYMPD5M6	140, 431
NSYMP126	21, 22, 117, 118, 265, 442	NSYMP9M8	410, 411, 413, 414, 416	NSYMPD5M8	140, 431
NSYMP128	19, 21, 22, 115, 117, 118, 265, 442	NSYMPB4SD	524	NSYMPD66T	140
NSYMP12M6	410, 411, 413, 414, 416	NSYMPB6SD	524	NSYMPD68T	140
NSYMP12M8	410, 411, 413, 414, 416	NSYMPBSD	524	NSYMPD6M6	140, 431
NSYMP1410	19, 25, 115, 178, 265, 524	NSYMPC156	354	NSYMPD6M8	140, 431
NSYMP1412	19, 115, 265, 524	NSYMPC158	354	NSYMPD86T	140
		NSYMPC206	354	NSYMPD88T	140
				NSYMPD8M6	140, 431
				NSYMPD8M8	140, 431
				NSYMPD9M6	140, 431
				NSYMPD9M8	140, 431
				NSYMPFIX	410, 411, 412, 413, 414, 415, 416
				NSYMP108	27, 221, 261, 449
				NSYMP3025	27, 221, 261
				NSYMP32	27, 221, 261
				NSYMP34	27, 221, 261
				NSYMP54	27, 221, 261

Index of references

N	Page	N	Page	N	Page
NSYMPP64	27, 221, 261	NSYMS66	12, 14, 24, 48, 74, 166, 260, 501	NSYMUPLA74G	236
NSYMPP75	27, 221, 261, 449	NSYMS75	12, 14, 24, 27, 48, 74, 166, 220, 260, 501	NSYMUPLA74W	236
NSYMPP86	27, 221, 261, 449	NSYMS86	12, 14, 24, 27, 48, 53, 74, 166, 220, 260, 501	NSYMUPLA76G	236
NSYMPRK10	267	NSYMSC202	428	NSYMUPLA76W	236
NSYMPRK12	267	NSYMSC206	428	NSYMW10M	321
NSYMPRK16	267	NSYMTR64	429	NSYMW10MK	321
NSYMPRK8	267	NSYMTR65	429	NSYMW10MR	321
NSYMPS30	357	NSYMTR84	429	NSYNM4	264, 291
NSYMPS40	357	NSYMTR85	429	NSYNM5	264, 291
NSYMPS50	357	NSYUMUC156	355	NSYNM6	264, 291
NSYMPS60	357	NSYUMUC158	355	NSYOL6GF	128
NSYMPS80	357	NSYUMUC206	355	NSYOPB12U4F	561, 563
NSYMR1010	24, 53, 166, 260	NSYUMUC208	355	NSYOPB12U4FR	561, 563
NSYMR1012	15, 53, 75, 260	NSYUMUC306	353, 355	NSYOPB12U5F	561, 563
NSYMR106	12, 15, 17, 24, 48, 53, 75, 166, 260	NSYUMUC308	353, 355	NSYOPB12U5P	560, 562
NSYMR108	12, 15, 17, 24, 27, 48, 53, 75, 166, 221, 260, 501	NSYUMUC406	355	NSYOPB12U6F	561, 563
NSYMR1210	15, 24, 53, 75, 166, 260	NSYUMUC408	355	NSYOPB12U6P	560, 562
NSYMR126	15, 53, 75, 260	NSYUMUC456	355	NSYOPB12UF	565
NSYMR128	15, 24, 53, 75, 166, 260	NSYUMUC458	355	NSYOPB12UTPN	560, 561, 565
NSYMR1410	15, 53, 75, 260	NSYUMUC606	355	NSYOPB15U4F	561, 563
NSYMR3025	12, 15, 24, 27, 48, 75, 166, 221, 260, 501	NSYUMUC608	355	NSYOPB15U5F	561, 563
NSYMR32	15, 24, 27, 75, 166, 221, 260, 501	NSYUMUCH156	355	NSYOPB15U5FR	561, 563
NSYMR33	12, 15, 17, 24, 48, 75, 166, 260, 501	NSYUMUCH158	355	NSYOPB15U5P	560, 562
NSYMR34	12, 15, 17, 48, 75, 260	NSYUMUCH206	355	NSYOPB15U6F	561, 563
NSYMR43	12, 15, 17, 24, 27, 48, 75, 166, 221, 260, 501	NSYUMUCH208	355	NSYOPB15U6P	560, 562
NSYMR44	12, 15, 24, 48, 75, 166, 260, 518	NSYUMUCH306	355	NSYOPB15UF	565
NSYMR46	12, 15, 17, 24, 48, 75, 166, 260	NSYUMUCH308	355	NSYOPB15UTPN	560, 561, 565
NSYMR53	15, 75, 260	NSYMUCH406	355	NSYOPB18U4F	561, 563
NSYMR54	12, 15, 17, 24, 27, 48, 75, 166, 221, 260, 501	NSYMUCH408	355	NSYOPB18U5F	561, 563
NSYMR55	12, 15, 48, 75, 260	NSYMUCH456	355	NSYOPB18U5FR	561, 563
NSYMR64	12, 15, 17, 24, 27, 48, 75, 166, 221, 260, 501, 518	NSYMUCH458	355	NSYOPB18U5P	560, 562
NSYMR65	12, 15, 48, 75, 260	NSYMUCH606	355	NSYOPB18UF	565
NSYMR66	12, 15, 17, 24, 48, 75, 166, 260, 501	NSYMUCH608	355	NSYOPB18UTPN	560, 561, 565
NSYMR68	12, 15, 48, 75, 260	NSYMUPLA103G	236	NSYOPB21U5F	561, 563
NSYMR75	12, 15, 17, 24, 27, 48, 75, 166, 221, 260, 501	NSYMUPLA103W	236	NSYOPB21U6F	561, 563
NSYMR76	17, 260	NSYMUPLA104G	236	NSYOPB21UF	565
NSYMR810	15, 53, 75, 260	NSYMUPLA104W	236	NSYOPB21UTPN	561, 565
NSYMR86	12, 15, 17, 24, 27, 48, 53, 75, 166, 221, 260, 501	NSYMUPLA123G	236	NSYOPB6U4F	561, 563
NSYMR864	75	NSYMUPLA123W	236	NSYOPB6U4P	560, 562
NSYMR88	12, 15, 24, 48, 75, 166, 260	NSYMUPLA124G	236	NSYOPB6U5F	561, 563
NSYMS43	12, 14, 24, 27, 48, 74, 166, 220, 260, 501	NSYMUPLA124W	236	NSYOPB6U5P	560, 562
NSYMS44	12, 14, 24, 48, 74, 166, 260, 501	NSYMUPLA126G	236	NSYOPB6UF	565
NSYMS53	14, 74, 260	NSYMUPLA126W	236	NSYOPB6UTPN	560, 561, 565
NSYMS54	12, 14, 24, 27, 48, 74, 166, 220, 260, 501	NSYMUPLA126G	236	NSYOPB9U4F	561, 563
NSYMS55	12, 14, 48, 74, 260	NSYMUPLA126W	236	NSYOPB9U4FR	561, 563
NSYMS64	12, 14, 24, 27, 48, 74, 166, 220, 260, 501	NSYMUPLA153G	236	NSYOPB9U4P	560, 562
		NSYMUPLA153W	236	NSYOPB9U5F	561, 563
		NSYMUPLA154G	236	NSYOPB9U5P	560, 562
		NSYMUPLA154W	236	NSYOPB9U6F	561, 563
		NSYMUPLA156G	236	NSYOPB9UF	565
		NSYMUPLA156W	236	NSYOPB9UTPN	560, 561, 565
		NSYMUPLA204G	236	NSYPA3025PLMG	27, 219
		NSYMUPLA204W	236	NSYPAP108G	27, 219
		NSYMUPLA53G	236	NSYPAP43G	27, 219
		NSYMUPLA53W	236	NSYPAP54G	27, 219
		NSYMUPLA54G	236	NSYPAP64G	27, 219
		NSYMUPLA54W	236	NSYPAP75G	27, 219
		NSYMUPLA73G	236	NSYPAP86G	27, 219
		NSYMUPLA73W	236	NSYPAPLA105G	30, 242

Index of references

N	Page	N	Page	N	Page
NSYPAPLA107G	30, 242	NSYPHDZT2074	436, 444, 658	NSYPLA15104G	28, 234
NSYPAPLA125G	30, 242	NSYPHDZT2074P	436, 444, 658	NSYPLA15104TG	28, 234
NSYPAPLA127G	30, 242	NSYPHDZT774	436, 444, 658	NSYPLA15123G	28, 234
NSYPAPLA155G	30, 242	NSYPHDZT774P	436, 444, 658	NSYPLA15123TG	28, 234
NSYPAPLA157G	30, 242	NSYPHDZT776	436, 444, 658	NSYPLA15124G	28, 234
NSYPAPLA55G	30, 242	NSYPHDZT776P	436, 444, 658	NSYPLA15124TG	28, 234
NSYPAPLA57G	30, 242	NSYPHLT6040	281	NSYPLA15126G	28, 234
NSYPAPLA75G	30, 242	NSYPHLT6060	281	NSYPLA15126TG	28, 234
NSYPAPLA77G	30, 242	NSYPHLT6080	281	NSYPLA1553G	28, 234
NSYPC100	727, 728	NSYPHLT8040	281	NSYPLA1553TG	28, 234
NSYPC200	727, 728	NSYPHLT8080	281	NSYPLA1554G	28, 234
NSYPCVD126	472	NSYPHX200	179, 317	NSYPLA1554TG	28, 234
NSYPCVD128	472	NSYPIN106	51, 55, 67, 77, 88	NSYPLA1573G	28, 234
NSYPCVD148	472	NSYPIN108	51, 55, 67, 77, 88, 170	NSYPLA1573TG	28, 234
NSYPCVD168	472	NSYPIN126	55, 67, 77, 88	NSYPLA1574G	28, 234
NSYPCVD188	472	NSYPIN128	55, 67, 77, 88, 170	NSYPLA1574TG	28, 234
NSYPCVD206	472	NSYPIN43	51, 67, 77, 88, 170	NSYPLA1576G	28, 234
NSYPCVD208	472	NSYPIN54	51, 67, 77, 88, 170	NSYPLA1576TG	28, 234
NSYPCVD226	472	NSYPIN64	51, 67, 77, 88, 170	NSYPLA2074G	28, 234
NSYPCVD228	472	NSYPIN75	51, 67, 77, 88, 170	NSYPLA2074TG	28, 234
NSYPCVR124HD	438, 444, 445, 658, 659	NSYPIN86	51, 55, 67, 77, 88, 170	NSYPLA5103G	28, 234
NSYPCVR126HD	438, 444, 445, 658, 659	NSYPLA10103G	28, 234	NSYPLA5103TG	28, 234
NSYPCVR54HD	438, 444, 445, 658, 659	NSYPLA10103TG	28, 234	NSYPLA5104G	28, 234
NSYPCVR74HD	438, 444, 445, 658, 659	NSYPLA10104G	28, 234	NSYPLA5104TG	28, 234
NSYPCVR76HD	438, 444, 445, 658, 659	NSYPLA10104TG	28, 234	NSYPLA5123G	28, 234
NSYPF27N	202	NSYPLA10123G	28, 234	NSYPLA5123TG	28, 234
NSYPF27X	202	NSYPLA10123TG	28, 234	NSYPLA5124G	28, 234
NSYRFC2X	57, 168	NSYPLA10124G	28, 234	NSYPLA5124TG	28, 234
NSYRFCR	51, 57	NSYPLA10124TG	28, 234	NSYPLA553G	28, 234
NSYRFCX	57, 168	NSYPLA1053G	28, 234	NSYPLA553TG	28, 234
NSYFPPLM32G	27, 218	NSYPLA1053TG	28, 234	NSYPLA554G	28, 234
NSYFPPLMG	27, 218, 449	NSYPLA1054G	28, 234	NSYPLA554TG	28, 234
NSYFPXPLM	218, 449	NSYPLA1054TG	28, 234	NSYPLA573G	28, 234
NSYPHDT553	436, 444, 658	NSYPLA1073G	28, 234	NSYPLA573TG	28, 234
NSYPHDT553P	436, 444, 658	NSYPLA1073TG	28, 234	NSYPLA574G	28, 234
NSYPHDT753	436, 444, 658	NSYPLA1074G	28, 234	NSYPLA574TG	28, 234
NSYPHDT753P	436, 444, 658	NSYPLA1074TG	28, 234	NSYPLA7103G	28, 234
NSYPHDZT1054	436, 444, 658	NSYPLA12103G	28, 234	NSYPLA7103TG	28, 234
NSYPHDZT1054P	436, 444, 658	NSYPLA12103TG	28, 234	NSYPLA7104G	28, 234
NSYPHDZT1074	436, 444, 658	NSYPLA12104G	28, 234	NSYPLA7104TG	28, 234
NSYPHDZT1074P	436, 444, 658	NSYPLA12104TG	28, 234	NSYPLA7123G	28, 234
NSYPHDZT12124	436, 444, 658	NSYPLA12123G	28, 234	NSYPLA7123TG	28, 234
NSYPHDZT12124P	436, 444, 658	NSYPLA12123TG	28, 234	NSYPLA7124G	28, 234
NSYPHDZT12126	436, 444, 658	NSYPLA12124G	28, 234	NSYPLA7124TG	28, 234
NSYPHDZT12126P	436, 444, 658	NSYPLA12124TG	28, 234	NSYPLA753G	28, 234
NSYPHDZT1254	436, 444, 658	NSYPLA12126G	28, 234	NSYPLA753TG	28, 234
NSYPHDZT1254P	436, 444, 658	NSYPLA12126TG	28, 234	NSYPLA754G	28, 234
NSYPHDZT1274	436, 444, 658	NSYPLA1253G	28, 234	NSYPLA754TG	28, 234
NSYPHDZT1274P	436, 444, 658	NSYPLA1253TG	28, 234	NSYPLA773G	28, 234
NSYPHDZT1276	436, 444, 658	NSYPLA1254G	28, 234	NSYPLA773TG	28, 234
NSYPHDZT1276P	436, 444, 658	NSYPLA1254TG	28, 234	NSYPLA774G	28, 234
NSYPHDZT15124	436, 444, 658	NSYPLA1273G	28, 234	NSYPLA774TG	28, 234
NSYPHDZT15124P	436, 444, 658	NSYPLA1273TG	28, 234	NSYPLA776G	28, 234
NSYPHDZT15126	436, 444, 658	NSYPLA1274G	28, 234	NSYPLA776TG	28, 234
NSYPHDZT15126P	436, 444, 658	NSYPLA1274TG	28, 234	NSYPLAT10103G	29, 235
NSYPHDZT1574	436, 444, 658	NSYPLA1276G	28, 234	NSYPLAT10104G	29, 235
NSYPHDZT1574P	436, 444, 658	NSYPLA1276TG	28, 234	NSYPLAT10123G	29, 235
NSYPHDZT1576	436, 444, 658	NSYPLA15103G	28, 234	NSYPLAT10124G	29, 235
NSYPHDZT1576P	436, 444, 658	NSYPLA15103TG	28, 234	NSYPLAT1053G	29, 235

Index of references

N	Page	N	Page	N	Page
NSYPLAT1054G	29, 235	NSYPLAZ15103G	28, 234	NSYPLAZT5123G	29, 235
NSYPLAT1073G	29, 235	NSYPLAZ15104G	28, 234	NSYPLAZT5124G	29, 235
NSYPLAT1074G	29, 235	NSYPLAZ15123G	28, 234	NSYPLAZT553G	29, 235
NSYPLAT12103G	29, 235	NSYPLAZ15124G	28, 234	NSYPLAZT554G	29, 235
NSYPLAT12104G	29, 235	NSYPLAZ15126G	28, 234	NSYPLAZT573G	29, 235
NSYPLAT12123G	29, 235	NSYPLAZ1553G	28, 234	NSYPLAZT574G	29, 235
NSYPLAT12124G	29, 235	NSYPLAZ1554G	28, 234	NSYPLAZT7103G	29, 235
NSYPLAT12126G	29, 235	NSYPLAZ1573G	28, 234	NSYPLAZT7104G	29, 235
NSYPLAT1253G	29, 235	NSYPLAZ1574G	28, 234	NSYPLAZT7123G	29, 235
NSYPLAT1254G	29, 235	NSYPLAZ1576G	28, 234	NSYPLAZT7124G	29, 235
NSYPLAT1273G	29, 235	NSYPLAZ2074G	28, 234	NSYPLAZT753G	29, 235
NSYPLAT1274G	29, 235	NSYPLAZ5103G	28, 234	NSYPLAZT754G	29, 235
NSYPLAT1276G	29, 235	NSYPLAZ5104G	28, 234	NSYPLAZT773G	29, 235
NSYPLAT15103G	29, 235	NSYPLAZ5123G	28, 234	NSYPLAZT774G	29, 235
NSYPLAT15104G	29, 235	NSYPLAZ5124G	28, 234	NSYPLAZT776G	29, 235
NSYPLAT15123G	29, 235	NSYPLAZ553G	28, 234	NSYPLHD	437
NSYPLAT15124G	29, 235	NSYPLAZ554G	28, 234	NSYPLM108	220
NSYPLAT15126G	29, 235	NSYPLAZ573G	28, 234	NSYPLM108BG	216
NSYPLAT1553G	29, 235	NSYPLAZ574G	28, 234	NSYPLM108G	26, 215, 216, 217, 229
NSYPLAT1554G	29, 235	NSYPLAZ7103G	28, 234	NSYPLM108TG	26, 215, 216, 229
NSYPLAT1573G	29, 235	NSYPLAZ7104G	28, 234	NSYPLM3025	220
NSYPLAT1574G	29, 235	NSYPLAZ7123G	28, 234	NSYPLM3025BG	216
NSYPLAT1576G	29, 235	NSYPLAZ7124G	28, 234	NSYPLM3025G	26, 215, 216
NSYPLAT2074G	29, 235	NSYPLAZ753G	28, 234	NSYPLM3025PG	216
NSYPLAT5103G	29, 235	NSYPLAZ754G	28, 234	NSYPLM3025TG	26, 215, 216
NSYPLAT5104G	29, 235	NSYPLAZ773G	28, 234	NSYPLM32	220
NSYPLAT5123G	29, 235	NSYPLAZ774G	28, 234	NSYPLM32BG	216
NSYPLAT5124G	29, 235	NSYPLAZ776G	28, 234	NSYPLM32G	26, 215, 216
NSYPLAT553G	29, 235	NSYPLAZT10103G	29, 235	NSYPLM32PG	216
NSYPLAT554G	29, 235	NSYPLAZT10104G	29, 235	NSYPLM32TG	26, 215, 216
NSYPLAT573G	29, 235	NSYPLAZT10123G	29, 235	NSYPLM43	220
NSYPLAT574G	29, 235	NSYPLAZT10124G	29, 235	NSYPLM43BG	216
NSYPLAT7103G	29, 235	NSYPLAZT1053G	29, 235	NSYPLM43G	26, 215, 216, 229
NSYPLAT7104G	29, 235	NSYPLAZT1054G	29, 235	NSYPLM43PG	216
NSYPLAT7123G	29, 235	NSYPLAZT1073G	29, 235	NSYPLM43TG	26, 215, 216, 229
NSYPLAT7124G	29, 235	NSYPLAZT1074G	29, 235	NSYPLM43TVG	26, 215, 216, 229
NSYPLAT753G	29, 235	NSYPLAZT12103G	29, 235	NSYPLM43VG	26, 215, 216
NSYPLAT754G	29, 235	NSYPLAZT12104G	29, 235	NSYPLM54	220
NSYPLAT773G	29, 235	NSYPLAZT12123G	29, 235	NSYPLM54BG	216
NSYPLAT774G	29, 235	NSYPLAZT12124G	29, 235	NSYPLM54G	26, 215, 216, 229
NSYPLAT776G	29, 235	NSYPLAZT12126G	29, 235	NSYPLM54PG	216
NSYPLAZ10103G	28, 234	NSYPLAZT1253G	29, 235	NSYPLM54TG	26, 215, 216, 229
NSYPLAZ10104G	28, 234	NSYPLAZT1254G	29, 235	NSYPLM54TVG	26, 215, 216, 229
NSYPLAZ10123G	28, 234	NSYPLAZT1273G	29, 235	NSYPLM54VG	26, 215, 216
NSYPLAZ10124G	28, 234	NSYPLAZT1274G	29, 235	NSYPLM57G	449
NSYPLAZ1053G	28, 234	NSYPLAZT1276G	29, 235	NSYPLM64	220
NSYPLAZ1054G	28, 234	NSYPLAZT15103G	29, 235	NSYPLM64BG	216
NSYPLAZ1073G	28, 234	NSYPLAZT15104G	29, 235	NSYPLM64G	26, 215, 216, 229
NSYPLAZ1074G	28, 234	NSYPLAZT15123G	29, 235	NSYPLM64PG	216
NSYPLAZ12103G	28, 234	NSYPLAZT15124G	29, 235	NSYPLM64TG	26, 215, 216, 229
NSYPLAZ12104G	28, 234	NSYPLAZT15126G	29, 235	NSYPLM64TVG	26, 215, 216, 229
NSYPLAZ12123G	28, 234	NSYPLAZT1553G	29, 235	NSYPLM64VG	26, 215, 216
NSYPLAZ12124G	28, 234	NSYPLAZT1554G	29, 235	NSYPLM68G	449
NSYPLAZ12126G	28, 234	NSYPLAZT1573G	29, 235	NSYPLM75	220
NSYPLAZ1253G	28, 234	NSYPLAZT1574G	29, 235	NSYPLM75BG	216
NSYPLAZ1254G	28, 234	NSYPLAZT1576G	29, 235	NSYPLM75G	26, 215, 216, 217, 229
NSYPLAZ1273G	28, 234	NSYPLAZT2074G	29, 235	NSYPLM75PG	216
NSYPLAZ1274G	28, 234	NSYPLAZT5103G	29, 235	NSYPLM75TG	26, 215, 216, 229
NSYPLAZ1276G	28, 234	NSYPLAZT5104G	29, 235	NSYPLM75TVG	26, 215, 216, 229

Index of references

N	Page	N	Page	N	Page
NSYPLM75VG	26, 215, 216	NSYPMA1827G	201	NSYPMM2736	201
NSYPLM810G	449	NSYPMA2727G	201	NSYPMM2754	201
NSYPLM86	220	NSYPMA2736G	201	NSYPMM3636	201
NSYPLM86BG	216	NSYPMA2754G	201	NSYPMM3654	201
NSYPLM86G	26, 215, 216, 217, 229	NSYPMA3636G	201	NSYPMM3672	201
NSYPLM86PG	216	NSYPMA3654G	201	NSYPMM510	30, 246
NSYPLM86TG	26, 215, 216, 229	NSYPMA3672G	201	NSYPMM5454	201
NSYPLM86TVG	26, 215, 216, 229	NSYPMA510	30, 246	NSYPMM5472	201
NSYPLM86VG	26, 215, 216	NSYPMA5454G	201	NSYPMM55	30, 246, 438
NSYPLS1827DLS12	201	NSYPMA5472G	201	NSYPMM710	30, 246
NSYPLS1827G	11, 200	NSYPMA55	30, 246	NSYPMM712	30, 246
NSYPLS24	522	NSYPMA710	30, 246	NSYPMM75	30, 246, 438
NSYPLS2727AG	11, 200	NSYPMA712	30, 246	NSYPMM77	30, 246, 438
NSYPLS2727DLS24	201	NSYPMA75	30, 246	NSYPMP300DLM	50, 349
NSYPLS2727G	11, 200	NSYPMA77	30, 246	NSYPMP400DLA	227
NSYPLS2736AG	11, 200	NSYPMB1010	30, 246	NSYPMP400DLM	50, 349
NSYPLS2736G	11, 200	NSYPMB1012	30, 246	NSYPMP45100	523
NSYPLS2754AG	11, 200	NSYPMB105	30, 246	NSYPMP45120	523
NSYPLS2754G	11, 200	NSYPMB107	30, 246	NSYPMP45160	523
NSYPLS30	522	NSYPMB1210	30, 246	NSYPMP4580	523
NSYPLS3627DLS24	201	NSYPMB1212	30, 246	NSYPMP5002DLP	250, 256
NSYPLS3627DLS36	201	NSYPMB125	30, 246	NSYPMP500DLA	227
NSYPLS3636G	11, 200	NSYPMB127	30, 246	NSYPMP500DLM	50, 349
NSYPLS3654AG	11, 200	NSYPMB1510	30, 246	NSYPMP500DLP	250, 256
NSYPLS3654G	11, 200	NSYPMB1512	30, 246	NSYPMP600DLA	227
NSYPLS3672AG	11, 200	NSYPMB155	30, 246	NSYPMP600DLM	50, 54, 349
NSYPLS5427DLS48	201	NSYPMB157	30, 246	NSYPMP7502DLP	250, 256
NSYPLS5454AG	11, 200	NSYPMB1827	201	NSYPMP750DLP	250, 256
NSYPLS5454G	11, 200	NSYPMB2727	201	NSYPMP800DLA	227
NSYPLS5472AG	11, 200	NSYPMB2736	201	NSYPMP800DLM	50, 54, 349
NSYPLSC1827G	11, 200	NSYPMB2754	201	NSYPMP85100	25, 523
NSYPLSC2727AG	11, 200	NSYPMB3636	201	NSYPMP85120	25, 523
NSYPLSC2727G	11, 200	NSYPMB3654	201	NSYPMP85160	523
NSYPLSC2736AG	11, 200	NSYPMB510	30, 246	NSYPMP8560	25, 523
NSYPLSC2736G	11, 200	NSYPMB5472	201	NSYPMP8580	25, 523
NSYPLSC2754AG	11, 200	NSYPMB55	30, 246	NSYPMR105	30, 246
NSYPLSC2754G	11, 200	NSYPMB710	30, 246	NSYPMR107	30, 246
NSYPLSC3636G	11, 200	NSYPMB712	30, 246	NSYPMR125	30, 246
NSYPLSC3654AG	11, 200	NSYPMB75	30, 246	NSYPMR127	30, 246
NSYPLSC3654G	11, 200	NSYPMB77	30, 246	NSYPMR155	30, 246
NSYPLSC3672AG	11, 200	NSYPMD1510	10, 35	NSYPMR157	30, 246
NSYPLSC5454AG	11, 200	NSYPMD2015	10, 35	NSYPMR1827	201
NSYPLSC5454G	11, 200	NSYPMD2520	10, 35	NSYPMR2727	201
NSYPLSC5472AG	11, 200	NSYPMD3025	10, 35	NSYPMR2736	201
NSYPLSP1827G	11, 200	NSYPMM1010	30, 246	NSYPMR2754	201
NSYPLSP2727G	11, 200	NSYPMM1012	30, 246	NSYPMR3654	201
NSYPLSP2736G	11, 200	NSYPMM105	30, 246, 438	NSYPMR3672	201
NSYPLSP2754G	11, 200	NSYPMM107	30, 246, 438	NSYPMR5454	201
NSYPLSP3636G	11, 200	NSYPMM1210	30, 246	NSYPMR5472	201
NSYPLSP3654G	11, 200	NSYPMM1212	30, 246, 438	NSYPMR55	30, 246
NSYPLSP5454G	11, 200	NSYPMM125	30, 246, 438	NSYPMR57	30, 246
NSYPMA1010	30, 246	NSYPMM127	30, 246, 438	NSYPMR75	30, 246
NSYPMA1012	30, 246	NSYPMM1510	30, 246	NSYPMR77	30, 246
NSYPMA105	30, 246	NSYPMM1512	30, 246, 438	NSYPNOPB	567
NSYPMA107	30, 246	NSYPMM155	30, 246	NSYPNVDA	604
NSYPMA1210	30, 246	NSYPMM157	30, 246, 438	NSYPPC54HD	732
NSYPMA1212	30, 246	NSYPMM1827	201	NSYPPC56HD	732
NSYPMA125	30, 246	NSYPMM207	30, 246, 438	NSYPPC74HD	732
NSYPMA127	30, 246	NSYPMM2727	201	NSYPPC76HD	732

Index of references

N	Page	N	Page	N	Page
NSYPPCPHDSN	732	NSYRCK42	454, 478	NSYRSF85	727
NSYPPHLT6040	280	NSYRCK47	478	NSYRSF85L	727
NSYPPHLT8040	280	NSYRCKP12	478	NSYRSF86	727
NSYPPS166	122	NSYRCKP17	478	NSYRSF86L	727
NSYPPS168	122	NSYRCKP21	478	NSYRSF88	727
NSYPPS184	122	NSYRCKP26	478	NSYRSF88L	727
NSYPPS185	122	NSYRCKP4	478	NSYRSFBLR	727
NSYPPS186	122	NSYRCKP8	478	NSYRSFLFIX	727
NSYPPS204	122	NSYRCKS10	479	NSYRSW27	19, 115, 481
NSYPPS205	122	NSYRCKS6	479	NSYRSW31	19, 115, 481
NSYPPS206	122	NSYRCKS8	479	NSYRSW36	19, 115, 481
NSYPPS208	122	NSYRCSUP15	483	NSYRSW40	19, 115, 481
NSYPPS226	122	NSYRCSUP25	483	NSYRSW45	481
NSYPPS228	122	NSYRE26	136, 666	NSYRSW627	481
NSYPPSB	39, 42, 154, 155	NSYRE60	136, 666	NSYRSW631	481
NSYPRVDA	604	NSYRETPLA	242	NSYRSW636	481
NSYPS2C27	203	NSYRETPLAU	242	NSYRSW640	481
NSYPS4C27	203	NSYRP2	517, 519	NSYRSW645	481
NSYPTDS1	541	NSYRPX2	517, 519	NSYRSWC27	19, 115, 482
NSYPTDS2	541	NSYRSF104	727	NSYRSWC31	19, 115, 482
NSYPTDS3	541	NSYRSF104L	727	NSYRSWC36	19, 115, 482
NSYPTDS4	541	NSYRSF105	727	NSYRSWC40	19, 115, 482
NSYPTDS5	541	NSYRSF105L	727	NSYRSWC45	482
NSYPTZ3	250	NSYRSF106	727	NSYRSWH180	482
NSYPTZ32P	250	NSYRSF106L	727	NSYRSWP12	480
NSYPTZ4	31, 245, 250	NSYRSF108	727	NSYRSWP15	480
NSYPTZ42P	250	NSYRSF108L	727	NSYRSWP18	480
NSYPTZ6	250	NSYRSF124	727	NSYRSWP21	480
NSYPTZ62P	250	NSYRSF124L	727	NSYRSWP6	480
NSYPUNX	179	NSYRSF125	727	NSYRSWP9	480
NSYPV24	578, 580, 582, 584, 598	NSYRSF125L	727	NSYRSWSP6	480
NSYPV33	578, 580, 584, 598	NSYRSF126	727	NSYRSWSP8	480
NSYPV42	578, 580, 582, 584, 598	NSYRSF126L	727	NSYRUFOPB	567
NSYR19DN	616	NSYRSF128	727	NSYRUFNPVDA	604
NSYRBL216146M	372	NSYRSF128L	727	NSYRUFNPVDA	604
NSYRBL216296M	372	NSYRSF164	727	NSYRUFVDA	578, 580, 582, 584, 586, 587, 604
NSYRBL21656M	372	NSYRSF164L	727	NSYS04	371
NSYRBL21686M	372	NSYRSF165	727	NSYS06	371
NSYRBLZ216146	372	NSYRSF165L	727	NSYS10	371
NSYRBLZ216296	372	NSYRSF166	727	NSYS13M5HS	167, 291
NSYRBLZ21656	372	NSYRSF166L	727	NSYS16	371
NSYRBLZ21686	372	NSYRSF35	727	NSYS16M5HS	167, 267, 291
NSYRC12	479	NSYRSF35L	727	NSYS16M6HS	167, 291
NSYRC14	479	NSYRSF36	727	NSYS2535	371
NSYRC16	479	NSYRSF36L	727	NSYS3CM303020	508, 510, 532
NSYRC18	479	NSYRSF38	727	NSYS3CM304020	508, 510, 532
NSYRC1U	483	NSYRSF38L	727	NSYS3CM404020	508, 510, 532
NSYRC20	479	NSYRSF44	727	NSYS3CM406025	508, 510, 532
NSYRC22	479	NSYRSF44L	727	NSYS3CM505025	508, 510, 532
NSYRCDFIX	483	NSYRSF45	727	NSYS3CM606020	508, 510, 532
NSYRCDR12	484	NSYRSF45L	727	NSYS3CM608030	508, 510, 532
NSYRCDR18	484	NSYRSF64	727	NSYS3CM806030	508, 510, 532
NSYRCINT	484	NSYRSF64L	727	NSYS3CVR64HD	442, 444, 445, 658, 659
NSYRCK19KIT	479	NSYRSF65	727	NSYS3CVR84HD	442, 444, 445, 658, 659
NSYRCK19KIT6G	454	NSYRSF65L	727	NSYS3D101030	14, 74
NSYRCK24	478	NSYRSF66	727	NSYS3D101030D	14, 74, 103
NSYRCK29	478	NSYRSF66L	727	NSYS3D101030DP	14, 74
NSYRCK33	478	NSYRSF84	727	NSYS3D101030DT	14, 74
NSYRCK38	478	NSYRSF84L	727		

Index of references

N	Page	N	Page	N	Page
NSYS3D101030P	14, 74	NSYS3D3315T	14, 74	NSYS3D6630T	14, 74, 470
NSYS3D101030T	14, 74	NSYS3D3320	14, 74	NSYS3D6640	14, 74, 470
NSYS3D101230D	14, 74	NSYS3D3320P	14, 74	NSYS3D6640P	14, 74
NSYS3D101230DP	14, 74	NSYS3D3320T	14, 74	NSYS3D6640T	14, 74, 470
NSYS3D101240D	14, 74	NSYS3D3415	14, 74	NSYS3D6830	14, 74
NSYS3D101240DP	14, 74	NSYS3D3415P	14, 74	NSYS3D6830P	14, 74
NSYS3D10625	14, 74, 103, 470	NSYS3D3415T	14, 74	NSYS3D6830T	14, 74
NSYS3D10625P	14, 74	NSYS3D3420	14, 74	NSYS3D6G12840P	459
NSYS3D10625T	14, 74, 470	NSYS3D3420P	14, 74	NSYS3D6G32515P	459
NSYS3D10630	14, 74, 470	NSYS3D3420T	14, 74	NSYS3D6G4320P	459
NSYS3D10630P	14, 74	NSYS3D4315	14, 74	NSYS3D6G6525P	459
NSYS3D10630T	14, 74, 470	NSYS3D4315P	14, 74	NSYS3D6G7525P	459
NSYS3D10640	14, 74, 470	NSYS3D4315T	14, 74	NSYS3D6G8630P	459
NSYS3D10640P	14, 74	NSYS3D4320	14, 74	NSYS3D7525	14, 74
NSYS3D10640T	14, 74, 470	NSYS3D4320P	14, 74	NSYS3D7525P	14, 74
NSYS3D10825	14, 74, 470	NSYS3D4320PK3	463	NSYS3D7525PK3	463
NSYS3D10825P	14, 74	NSYS3D4320T	14, 74	NSYS3D7525T	14, 74
NSYS3D10825T	14, 74, 470	NSYS3D4420	14, 74	NSYS3D81030	14, 74
NSYS3D10830	14, 74, 103, 470	NSYS3D4420P	14, 74	NSYS3D81030D	14, 74
NSYS3D10830P	14, 74	NSYS3D4420T	14, 74	NSYS3D81030DP	14, 74
NSYS3D10830T	14, 74, 470	NSYS3D4620	14, 74, 470	NSYS3D81030P	14, 74
NSYS3D10840	14, 74, 470	NSYS3D4620P	14, 74	NSYS3D81230D	14, 74
NSYS3D10840P	14, 74	NSYS3D4620T	14, 74, 470	NSYS3D81230DP	14, 74
NSYS3D10840T	14, 74, 470	NSYS3D4625	14, 74, 470	NSYS3D8620	14, 74, 470
NSYS3D121030	14, 74	NSYS3D4625P	14, 74	NSYS3D8620P	14, 74
NSYS3D121030D	14, 74	NSYS3D4625T	14, 74, 470	NSYS3D8620T	14, 74, 470
NSYS3D121030DP	14, 74	NSYS3D5320	14, 74, 103	NSYS3D8625	14, 74, 470
NSYS3D121030DT	14, 74	NSYS3D5320P	14, 74	NSYS3D8625P	14, 74
NSYS3D121030P	14, 74	NSYS3D5320T	14, 74	NSYS3D8625T	14, 74, 470
NSYS3D121030T	14, 74	NSYS3D5420	14, 74, 103	NSYS3D8630	14, 74, 103, 470
NSYS3D121040D	14, 74	NSYS3D5420P	14, 74	NSYS3D8630P	14, 74
NSYS3D121040DP	14, 74	NSYS3D5420T	14, 74	NSYS3D8630PK3	463
NSYS3D121230D	14, 74	NSYS3D5425	14, 74	NSYS3D8630T	14, 74, 470
NSYS3D121230DP	14, 74	NSYS3D5425P	14, 74	NSYS3D8640	14, 74, 470
NSYS3D121240D	14, 74	NSYS3D5425T	14, 74	NSYS3D8640P	14, 74
NSYS3D121240DP	14, 74	NSYS3D5520	14, 74	NSYS3D8640T	14, 74, 470
NSYS3D12630	14, 74	NSYS3D5520P	14, 74	NSYS3D8825	14, 74
NSYS3D12630P	14, 74	NSYS3D5520T	14, 74	NSYS3D8825P	14, 74
NSYS3D12630T	14, 74	NSYS3D5525	14, 74	NSYS3D8825T	14, 74
NSYS3D12640	14, 74	NSYS3D5525P	14, 74	NSYS3D8830	14, 74
NSYS3D12640P	14, 74	NSYS3D5525T	14, 74	NSYS3D8830P	14, 74
NSYS3D12640T	14, 74	NSYS3D6420	14, 74	NSYS3D8830T	14, 74
NSYS3D12830	14, 74, 470	NSYS3D6420P	14, 74	NSYS3DB25315	16, 345
NSYS3D12830P	14, 74	NSYS3D6420T	14, 74	NSYS3DB25415	16, 345
NSYS3D12830T	14, 74, 470	NSYS3D6425	14, 74, 103	NSYS3DB25515	16, 345
NSYS3D12840	14, 74, 470	NSYS3D6425P	14, 74	NSYS3DB3315	16, 345
NSYS3D12840P	14, 74	NSYS3D6425T	14, 74	NSYS3DB3415	16, 345
NSYS3D12840PK3	463	NSYS3D6525	14, 74	NSYS3DB3515	16, 345
NSYS3D12840T	14, 74, 470	NSYS3D6525P	14, 74	NSYS3DB3615	16, 345
NSYS3D141030D	14, 74, 103	NSYS3D6525PK3	463	NSYS3DB4315	16, 345
NSYS3D141030DP	14, 74	NSYS3D6525T	14, 74	NSYS3DB4815	16, 345
NSYS3D3215	14, 74, 103	NSYS3D6620	14, 74, 103, 470	NSYS3DB5415	16, 345
NSYS3D3215P	14, 74	NSYS3D6620P	14, 74	NSYS3DB6415	16, 345
NSYS3D321515	14, 74	NSYS3D6620T	14, 74, 470	NSYS3DCGPSTDSB	724, 725, 726
NSYS3D321515P	14, 74	NSYS3D6625	14, 74, 470	NSYS3DCGSB	724, 725, 726
NSYS3D321515PK3	463	NSYS3D6625P	14, 74	NSYS3DEX10830	500
NSYS3D321515T	14, 74	NSYS3D6625T	14, 74, 470	NSYS3DEX3215	500
NSYS3D3315	14, 74	NSYS3D6630	14, 74, 470	NSYS3DEX3320	500
NSYS3D3315P	14, 74	NSYS3D6630P	14, 74	NSYS3DEX4320	500

Index of references

N	Page	N	Page	N	Page
NSYS3DEX4420	500	NSYS3X601230	24, 166	NSYSBRF810	603
NSYS3DEX5420	500	NSYS3X6420	24, 166	NSYSBRF86	603
NSYS3DEX6425	500	NSYS3X6420H	24, 166	NSYSBRF88	603
NSYS3DEX6625	500	NSYS3X6420T	24, 166	NSYSBTB	268
NSYS3DEX7525	500	NSYS3X6625	24, 166	NSYSBX15158	10, 154
NSYS3DEX8630	500	NSYS3X6625H	24, 166	NSYSBX15308	10, 154
NSYS3DLG	724, 725, 732	NSYS3X7525	24, 166	NSYSBX20208	10, 154
NSYS3DM10615T	16, 348	NSYS3X7525H	24, 166	NSYSBX20308	10, 154
NSYS3DM10815T	16, 348	NSYS3X7525T	24, 166	NSYSBX204012	10, 154
NSYS3DM4315T	16, 348	NSYS3X801030	24, 166	NSYSBX303012	10, 154
NSYS3DM5415T	16, 348	NSYS3X801230	24, 166	NSYSC1030	135
NSYS3DM6415T	16, 348	NSYS3X8625	24, 166	NSYSC1040	135
NSYS3DM6615T	16, 348	NSYS3X8625H	24, 166	NSYSC1050	135
NSYS3DM7515T	16, 348	NSYS3X8625T	24, 166	NSYSC1060	135
NSYS3DM8615T	16, 348	NSYS3X8830	24, 166	NSYSC1230	135
NSYS3DTL	724	NSYS3X8830H	24, 166	NSYSC1240	135
NSYS3HD10640	439, 444, 658	NSYS50	371	NSYSC124HD	733
NSYS3HD10840	439, 444, 658	NSYS5GPC35	400	NSYSC1250	135
NSYS3HD3215	439	NSYS5GPC38	400	NSYSC1260	135
NSYS3HD4320	439	NSYS5GPC75	400	NSYSC126HD	733
NSYS3HD5420	439	NSYS5GPC78	400	NSYSC1640	135
NSYS3HD6425	439	NSYS70	371	NSYSC1650	135
NSYS3HD6630	439	NSYS95100	371	NSYSC1660	135
NSYS3HD7525	439	NSYSB130	264	NSYSC1850	135
NSYS3HD8630	439, 444, 658	NSYSB90	264	NSYSC1860	135
NSYS3HD8840	439, 444, 658	NSYSBM151512	10, 38, 40	NSYSC2050	135
NSYS3HF10830P	492	NSYSBM15158	10, 38, 40	NSYSC2060	135
NSYS3HF4320P	492	NSYSBM152012	10, 38, 40	NSYSC2450	135
NSYS3HF6420P	492	NSYSBM15208	10, 38, 40	NSYSC2460	135
NSYS3HF6625P	492	NSYSBM153012	10, 38, 40	NSYSC630	135
NSYS3HF8630P	492	NSYSBM15308	10, 38, 40	NSYSC640	135
NSYS3X101030	24, 166	NSYSBM154012	10, 38, 40	NSYSC64HD	733
NSYS3X101030H	24, 166	NSYSBM15408	10, 38, 40	NSYSC650	135
NSYS3X10830	24, 166	NSYSBM202012	10, 38, 40	NSYSC660	135
NSYS3X10830H	24, 166	NSYSBM20208	10, 38, 40	NSYSC66HD	733
NSYS3X10830T	24, 166	NSYSBM203012	10, 38, 40	NSYSC830	135
NSYS3X121030	24, 166	NSYSBM20308	10, 38, 40	NSYSC840	135
NSYS3X121030H	24, 166	NSYSBM204012	10, 38, 40	NSYSC84HD	733
NSYS3X12830	24, 166	NSYSBM20408	10, 38, 40	NSYSC850	135
NSYS3X12830H	24, 166	NSYSBM205012	10, 38, 40	NSYSC860	135
NSYS3X302515	24, 166	NSYSBM20508	10, 38, 40	NSYSC86HD	733
NSYS3X302515H	24, 166	NSYSBM206012	10, 38, 40	NSYSCCDINLG140	309
NSYS3X3215	24, 166	NSYSBM20608	10, 38, 40	NSYSCCDINLG75	309
NSYS3X3215H	24, 166	NSYSBM208012	10, 38, 40	NSYSCMX10030	177
NSYS3X3315	24, 166	NSYSBM303012	10, 38, 40	NSYSCMX10040	177
NSYS3X3315H	24, 166	NSYSBM304012	10, 38, 40	NSYSCMX12040	177
NSYS3X4315	24, 166	NSYSBM305012	10, 38, 40	NSYSCMX12050	177
NSYS3X4315H	24, 166	NSYSBM306012	10, 38, 40	NSYSCMX16040	177
NSYS3X4320	24, 166	NSYSBM308012	10, 38, 40	NSYSCMX16060	177
NSYS3X4320H	24, 166	NSYSBM404012	10, 38, 40	NSYSCMX6040	177
NSYS3X4320T	24, 166	NSYSBM405012	10, 38, 40	NSYSCMX8040	177
NSYS3X4420	24, 166	NSYSBM406012	10, 38, 40	NSYSCMX8050	177
NSYS3X4420H	24, 166	NSYSBM408012	10, 38, 40	NSYSCX10060	177
NSYS3X4620	24, 166	NSYSBMABS4	724	NSYSCX12040	177
NSYS3X4620H	24, 166	NSYSBMABS6	724	NSYSCX12050	177
NSYS3X5420	24, 166	NSYSBPLA	251	NSYSCX12060	177
NSYS3X5420H	24, 166	NSYSBRF610	603	NSYSCX16040	177
NSYS3X5420T	24, 166	NSYSBRF66	603	NSYSCX16060	177
NSYS3X601030	24, 166	NSYSBRF68	603	NSYSCX6040	177

Index of references

N	Page	N	Page	N	Page
NSYSCX6050	177	NSYSDT5	142, 319	NSYSF18660P	20, 116
NSYSCX8040	177	NSYSDT6	142, 319	NSYSF18660PC	527
NSYSCX8060	177	NSYSDT8	142, 319	NSYSF18680PC	527
NSYSD10	515, 520	NSYSDX10	25, 516, 519, 520	NSYSF18680T	20, 116
NSYSD10R	516, 519, 520	NSYSDX12	25, 516, 519, 520	NSYSF18840	20, 116
NSYSD12	515, 520	NSYSDX6	25, 516, 519, 520	NSYSF18840P	20, 116
NSYSD12R	516, 519, 520	NSYSDX8	25, 516, 519, 520	NSYSF18840T	20, 116
NSYSD6	515, 520	NSYSF12640	20, 116	NSYSF18850	20, 116
NSYSD6R	516, 519, 520	NSYSF12640P	20, 116	NSYSF18850P	20, 116
NSYSD8	515, 520	NSYSF12660	20, 116	NSYSF18850T	20, 116
NSYSD8R	516, 519, 520	NSYSF12660E	472	NSYSF18860	20, 116
NSYSDC42	517, 519	NSYSF12660P	20, 116	NSYSF188602D	20, 116
NSYSDC43	517, 519	NSYSF12680E	472	NSYSF188602DP	20, 116
NSYSDC62	517, 519	NSYSF12840	20, 116	NSYSF18860P	20, 116
NSYSDC63	517, 519	NSYSF12840P	20, 116	NSYSF18860T	20, 116
NSYSDCR10	319	NSYSF12860	20, 116	NSYSF201040	20, 116
NSYSDCR200	24, 51, 77, 166, 263, 502	NSYSF12860E	472	NSYSF2010402D	20, 116
NSYSDCR250	24, 51, 77, 166, 263, 502	NSYSF12860P	20, 116	NSYSF2010402DP	20, 116
NSYSDCR300	24, 51, 55, 77, 166, 502	NSYSF12880E	472	NSYSF201040P	20, 116
NSYSDCR4	319	NSYSF14640	20, 116	NSYSF201040T	20, 116
NSYSDCR400	55, 77	NSYSF14640P	20, 116	NSYSF201050	20, 116
NSYSDCR5	319	NSYSF14840	20, 116	NSYSF2010502D	20, 116
NSYSDCR6	319	NSYSF14840P	20, 116	NSYSF2010502DP	20, 116
NSYSDCR8	319	NSYSF16660	20, 116	NSYSF201050P	20, 116
NSYSDCX42	517, 519	NSYSF16660P	20, 116	NSYSF201050T	20, 116
NSYSDCX43	517, 519	NSYSF16660PC	527	NSYSF201060	20, 116
NSYSDCX62	517, 519	NSYSF16680	20, 116	NSYSF2010602D	20, 116
NSYSDCX63	517, 519	NSYSF16680P	20, 116	NSYSF2010602DP	20, 116
NSYSDF1010	515, 520	NSYSF16680PC	527	NSYSF201060P	20, 116
NSYSDF108	515, 520	NSYSF16860	20, 116	NSYSF201060T	20, 116
NSYSDF1210	515, 520	NSYSF16860P	20, 116	NSYSF201080	20, 116
NSYSDF128	515, 520	NSYSF16880	20, 116	NSYSF201080P	20, 116
NSYSDF1610	515, 520	NSYSF16880P	20, 116	NSYSF2012402D	20, 116
NSYSDF168	515, 520	NSYSF181040	20, 116	NSYSF2012402DP	20, 116
NSYSDF810	515, 520	NSYSF1810402D	20, 116	NSYSF2012502D	20, 116
NSYSDF88	515, 520	NSYSF1810402DP	20, 116	NSYSF2012502DP	20, 116
NSYSDFLOCKDB5	731	NSYSF181040P	20, 116	NSYSF2012602D	20, 116
NSYSDGCR10	309	NSYSF181050	20, 116	NSYSF2012602DP	20, 116
NSYSDGCR5	309	NSYSF181050P	20, 116	NSYSF2012802D	20, 116
NSYSDGCR6	309	NSYSF181060	20, 116	NSYSF2012802DP	20, 116
NSYSDGCR8	309	NSYSF1810602D	20, 116	NSYSF2016402D	20, 116
NSYSDH	731	NSYSF1810602DP	20, 116	NSYSF2016402DP	20, 116
NSYSDP6M	141, 318	NSYSF181060P	20, 116	NSYSF2016502D	20, 116
NSYSDP8M	141, 318	NSYSF1812402D	20, 116	NSYSF2016502DP	20, 116
NSYSDR100	282	NSYSF1812402DP	20, 116	NSYSF2016602D	20, 116
NSYSDR100A	282	NSYSF1812502D	20, 116	NSYSF2016602DP	20, 116
NSYSDR120	282	NSYSF1812502DP	20, 116	NSYSF20350	20, 116, 359, 398
NSYSDR200	284	NSYSF1812602D	20, 116	NSYSF20350ED	398
NSYSDR200B	284	NSYSF1812602DP	20, 116	NSYSF20360	20, 116, 359, 398, 432
NSYSDR200BD	284	NSYSF18440	20, 116, 359	NSYSF20380	20, 116, 359, 398, 432
NSYSDR200D	284	NSYSF18450	20, 116, 359	NSYSF20380ED	398
NSYSDR30B	282	NSYSF18460	20, 116, 359	NSYSF20440	20, 116, 359
NSYSDR40B	282	NSYSF18640	20, 116	NSYSF20450	20, 116, 359
NSYSDR50A	282	NSYSF18640P	20, 116	NSYSF20460	20, 116, 359, 432
NSYSDR60	282	NSYSF18640T	20, 116	NSYSF20480	20, 116, 359, 432
NSYSDR60A	282	NSYSF18650	20, 116	NSYSF20640	20, 116
NSYSDR80	282	NSYSF18650P	20, 116	NSYSF20640P	20, 116
NSYSDR80A	282	NSYSF18650T	20, 116	NSYSF20640T	20, 116
NSYSDRC	142	NSYSF18660	20, 116	NSYSF20650	20, 116

Index of references

N	Page	N	Page	N	Page
NSYSF20650P	20, 116	NSYSFBKSH	123	NSYSFD188T	22, 118
NSYSF20650T	20, 116	NSYSFC104	22, 23, 118, 119	NSYSFD2010	23, 119
NSYSF20660	20, 116	NSYSFC105	22, 23, 118, 119	NSYSFD20102D	23, 119
NSYSF20660E	472	NSYSFC106	22, 23, 118, 119	NSYSFD2010T	23, 119
NSYSF20660M	431	NSYSFC108	22, 23, 118, 119	NSYSFD20122D	23, 119
NSYSF20660P	20, 116	NSYSFC124	22, 23, 118, 119	NSYSFD20122DT	23, 119
NSYSF20680	20, 116	NSYSFC125	22, 23, 118, 119	NSYSFD20162D	23, 119
NSYSF20680E	472	NSYSFC126	22, 23, 118, 119	NSYSFD203	23, 119, 139, 432
NSYSF20680M	431	NSYSFC128	22, 23, 118, 119	NSYSFD204	23, 119, 120, 139, 432
NSYSF20680P	20, 116	NSYSFC164	23, 119	NSYSFD205	120, 139
NSYSF208100E	472	NSYSFC165	23, 119	NSYSFD206	23, 119, 120, 139
NSYSF20840	20, 116	NSYSFC166	23, 119	NSYSFD206T	23, 119
NSYSF20840P	20, 116	NSYSFC35	23, 119, 398	NSYSFD207	139
NSYSF20840T	20, 116	NSYSFC35ED	398	NSYSFD208	23, 119, 120, 139
NSYSF20850	20, 116	NSYSFC36	23, 119, 432	NSYSFD2082D	23, 119
NSYSF20850P	20, 116	NSYSFC38	23, 119, 432	NSYSFD208T	23, 119
NSYSF20850T	20, 116	NSYSFC44	22, 23, 118, 119	NSYSFD2210	23, 119
NSYSF20860	20, 116	NSYSFC45	22, 23, 118, 119	NSYSFD2210T	23, 119
NSYSF208602D	20, 116	NSYSFC46	22, 23, 118, 119, 432	NSYSFD22122D	23, 119
NSYSF208602DP	20, 116	NSYSFC48	22, 23, 118, 119, 432	NSYSFD22122DT	23, 119
NSYSF20860E	472	NSYSFC64	22, 23, 118, 119	NSYSFD224	23, 119, 120, 139
NSYSF20860M	431	NSYSFC65	22, 23, 118, 119	NSYSFD225	120, 139
NSYSF20860P	20, 116	NSYSFC66	22, 23, 118, 119, 431	NSYSFD226	23, 119, 120, 139
NSYSF20860T	20, 116	NSYSFC68	22, 23, 118, 119, 431	NSYSFD226T	23, 119
NSYSF20880	20, 116	NSYSFC75	398	NSYSFD228	23, 119, 120, 139
NSYSF20880E	472	NSYSFC75ED	398	NSYSFD228T	23, 119
NSYSF20880M	431	NSYSFC84	22, 23, 118, 119	NSYSFDHD12122D	733
NSYSF20880P	20, 116	NSYSFC85	22, 23, 118, 119	NSYSFDHD126	733
NSYSF20880T	20, 116	NSYSFC86	22, 23, 118, 119, 431	NSYSFDHD128	733
NSYSF221060	20, 116	NSYSFC88	22, 23, 118, 119, 431	NSYSFDHD16122D	733
NSYSF221060P	20, 116	NSYSFCVR124HD	442, 444, 445, 658, 659	NSYSFDHD166	733
NSYSF2212602D	20, 116	NSYSFCVR126HD	442, 444, 445, 658, 659	NSYSFDHD168	733
NSYSF2212602DP	20, 116	NSYSFCVR64HD	442, 444, 445, 658, 659	NSYSFDHD208	733
NSYSF2212802D	20, 116	NSYSFCVR66HD	442, 444, 445, 658, 659	NSYSFEB	134, 399, 433
NSYSF2212802DP	20, 116	NSYSFCVR84HD	442, 444, 445, 658, 659	NSYSFECA64HD	733
NSYSF22460	20, 116, 359	NSYSFCVR86HD	442	NSYSFECA66HD	444, 445, 658, 659, 733
NSYSF226100E	472	NSYSFD126	22, 118, 120, 139	NSYSFELB	134, 399, 433
NSYSF22660	20, 116	NSYSFD126T	22, 118	NSYSFHD1212402D	439, 444, 658
NSYSF22660E	472	NSYSFD128	22, 118, 120, 139	NSYSFHD1212602D	439, 444, 658
NSYSF22660P	20, 116	NSYSFD128T	22, 118	NSYSFHD12640	439, 444, 658
NSYSF22680	20, 116	NSYSFD146	22, 118, 120, 139	NSYSFHD12660	439, 444, 658
NSYSF22680E	472	NSYSFD146T	22, 118	NSYSFHD12840	439, 444, 658
NSYSF22680P	20, 116	NSYSFD148	22, 118, 120, 139	NSYSFHD12860	439, 444, 658
NSYSF228100E	472	NSYSFD148T	22, 118	NSYSFHD1612402D	439, 444, 658
NSYSF22860	20, 116	NSYSFD166	22, 118, 120, 139	NSYSFHD1612602D	439, 444, 658
NSYSF22860E	472	NSYSFD166T	22, 118	NSYSFHD16660	439, 444, 658
NSYSF22860P	20, 116	NSYSFD168	22, 118, 120, 139	NSYSFHD16840	439, 444, 658
NSYSF22880	20, 116	NSYSFD168T	22, 118	NSYSFHD16860	439, 444, 658
NSYSF22880E	472	NSYSFD1810	22, 118	NSYSFHD2	145
NSYSF22880P	20, 116	NSYSFD18102D	22, 118	NSYSFHD20840	439, 444, 658
NSYSF22880T	20, 116	NSYSFD1810T	22, 118	NSYSFHD3	145
NSYSF6G20680	453	NSYSFD18122D	22, 118	NSYSFHFBK184	494
NSYSF6G20860	453	NSYSFD18122DT	22, 118	NSYSFHFBK186	494
NSYSF6G20880	453	NSYSFD184	22, 118, 120, 139	NSYSFHFBK2010	494
NSYSFBK	123	NSYSFD185	120, 139	NSYSFHFBK204	494
NSYSFBK19	25, 123, 179, 399, 433	NSYSFD186	22, 118, 120, 139	NSYSFHFBK206	494
NSYSFBKE	123	NSYSFD186T	22, 118	NSYSFHFBK208	494
NSYSFBKF	123	NSYSFD188	22, 118, 120, 139	NSYSFHFBK226	494
NSYSFBKR	123	NSYSFD1882D	22, 118	NSYSFHFBK228	494

Index of references

N	Page	N	Page	N	Page
NSYSFHNRTRIM	727, 728	NSYSFX18640	25, 175	NSYSM1410402D	18, 114
NSYSFHBP	143	NSYSFX18840	25, 175	NSYSM1410402DP	18, 114
NSYSFHS1	143, 727	NSYSFX201060	25, 175	NSYSM1412402D	18, 114
NSYSFHS1HD	733	NSYSFX201260	25, 175	NSYSM1412402DP	18, 114
NSYSFLOCK24	144	NSYSFX20650	25, 175	NSYSM14630	18, 114
NSYSFLOCKDB5	144	NSYSFX20840	25, 175	NSYSM14630P	18, 114
NSYSFLOCKS6	144	NSYSFX20860	25, 175	NSYSM14640	18, 114
NSYSFLOCKS7	144	NSYSFXJG	25, 179	NSYSM14640P	18, 114
NSYSFLOCKS8	144	NSYSGF	128	NSYSM14830	18, 114
NSYSFLOCKSG8	144	NSYSH180NC	142	NSYSM14830P	18, 114
NSYSFLOCKT6	144	NSYSHLT6040	280	NSYSM14840	18, 114
NSYSFLOCKT7	144	NSYSHLT6060	280	NSYSM14840P	18, 114
NSYSFLOCKT8	144	NSYSHLT6080	280	NSYSM14840T	18, 114
NSYSFMDR	319	NSYSHLT8040	280	NSYSM1610302D	18, 114
NSYSFNDR	319	NSYSHLT8060	280	NSYSM1610302DP	18, 114
NSYSFP20750ED	398	NSYSHLT8080	280	NSYSM1610402D	18, 114
NSYSFP20750G	398	NSYSIBTB	268	NSYSM1610402DP	18, 114
NSYSFP20750TED	398	NSYSICR40100	276	NSYSM1612302D	18, 114
NSYSFP20750TG	398	NSYSICR40120	276	NSYSM1612302DP	18, 114
NSYSFP20760G	398	NSYSICR4030	276	NSYSM1612402D	18, 114
NSYSFP20760TG	398	NSYSICR4040	276	NSYSM1612402DP	18, 114
NSYSFP20780ED	398	NSYSICR4050	276	NSYSM16630	18, 114
NSYSFP20780G	398	NSYSICR4060	276	NSYSM16630P	18, 114
NSYSFP20780TED	398	NSYSICR4080	276	NSYSM16640	18, 114
NSYSFP20780TG	398	NSYSICR65100	276	NSYSM16640P	18, 114
NSYSFP300	27, 218	NSYSICR65120	276	NSYSM16640T	18, 114
NSYSFP400	27, 218	NSYSICR6530	276	NSYSM16830	18, 114
NSYSFP500	27, 218	NSYSICR6540	276	NSYSM16830P	18, 114
NSYSFP600	27, 218	NSYSICR6550	276	NSYSM16830T	18, 114
NSYSFPA	375, 388, 423	NSYSICR6560	276	NSYSM16840	18, 114
NSYSFPAED	398	NSYSICR6580	276	NSYSM16840P	18, 114
NSYSFPB	268	NSYSICR90100	276	NSYSM16840T	18, 114
NSYSFPB6G	454	NSYSICR90120	276	NSYSM181040	18, 114
NSYSFPSC15	38, 41	NSYSICR9030	276	NSYSM1810402D	18, 114
NSYSFPSC20	38, 41	NSYSICR9040	276	NSYSM1810402DP	18, 114
NSYSFPSC30	38, 41, 52, 58, 77, 80	NSYSICR9050	276	NSYSM181040P	18, 114
NSYSFPSC40	38, 41, 52, 58, 77, 80	NSYSICR9060	276	NSYSM1810502D	18, 114
NSYSFPSC50	38, 41, 52, 58, 77, 80	NSYSICR9080	276	NSYSM1810502DP	18, 114
NSYSFPSC60	38, 41, 52, 56, 58, 77, 80	NSYSIMP12	21, 117, 267	NSYSM1812402D	18, 114
NSYSFPSC80	38, 41, 52, 58, 77, 80	NSYSIMP14	21, 117, 267	NSYSM1812402DP	18, 114
NSYSFRSEDC1268E	487	NSYSIMP16	21, 117, 267	NSYSM1812502D	18, 114
NSYSFRSEDC261E	487	NSYSIMP18	21, 117, 267	NSYSM1812502DP	18, 114
NSYSFRSEDC268E	487	NSYSIMP20	21, 117, 267	NSYSM1816402D	18, 114
NSYSFRSEDC2812E	487	NSYSIMP22	21, 117, 267	NSYSM1816402DP	18, 114
NSYSFRSEDC281E	487	NSYSLCKP	545	NSYSM1816502D	18, 114
NSYSFSPLMG	27, 218	NSYSLCKS10	545	NSYSM1816502DP	18, 114
NSYSFTB16	134	NSYSLCKS6	545	NSYSM18630	18, 114
NSYSFTB18	134	NSYSLCKS8	545	NSYSM18630P	18, 114
NSYSFTB24	134	NSYSLCR40	276	NSYSM18640	18, 114
NSYSFTB32	134	NSYSLCR50	276	NSYSM18640P	18, 114
NSYSFV12	22, 118	NSYSLCR60	276	NSYSM18640T	18, 114
NSYSFV14	22, 118	NSYSLCR80	276	NSYSM18650	18, 114
NSYSFV16	22, 118	NSYSM10M5HP	313	NSYSM18650P	18, 114
NSYSFV18	22, 118	NSYSM1210302D	18, 114	NSYSM18830	18, 114
NSYSFV20	23, 119, 398, 431, 432	NSYSM1210302DP	18, 114	NSYSM18830P	18, 114
NSYSFV20ED	398	NSYSM1212402D	18, 114	NSYSM18830T	18, 114
NSYSFV22	23, 119	NSYSM1212402DP	18, 114	NSYSM18840	18, 114
NSYSFWFIX	138	NSYSM12830	18, 114	NSYSM18840P	18, 114
NSYSFX181240	25, 175	NSYSM12830P	18, 114	NSYSM18840T	18, 114

Index of references

N	Page	N	Page	N	Page
NSYSM18850	18, 114	NSYSMEC63	130	NSYSMX201660	25, 175
NSYSM18850P	18, 114	NSYSMEC631	728	NSYSMX201660H	25, 175
NSYSM18850T	18, 114	NSYSMEC64	130	NSYSMX20850	25, 175
NSYSM18860	18, 114	NSYSMEC641	728	NSYSMXEB	179
NSYSM18860P	18, 114	NSYSMEC65	130	NSYSNLPLA	242
NSYSM2010402D	18, 114	NSYSMEC651	728	NSYSNM6	271, 285, 290
NSYSM2010402DP	18, 114	NSYSMEC66	130	NSYSNM8	271, 285, 290
NSYSM2010502D	18, 114	NSYSMEC661	728	NSYSNSM6	271, 285, 290
NSYSM2010502DP	18, 114	NSYSMEC83	130	NSYSNSM8	271, 285, 290
NSYSM2012402D	18, 114	NSYSMEC831	728	NSYSODS	545
NSYSM2012402DP	18, 114	NSYSMEC84	130	NSYSPB6100	127
NSYSM2012502D	18, 114	NSYSMEC841	728	NSYSPB8100	127
NSYSM2012502DP	18, 114	NSYSMEC85	130	NSYSPBC35	358
NSYSM2012602D	18, 114	NSYSMEC851	728	NSYSPBC36	358
NSYSM2012602DP	18, 114	NSYSMEC86	130	NSYSPBC38	358
NSYSM2016402D	18, 114	NSYSMEC861	728	NSYSPBOPB	565
NSYSM2016402DP	18, 114	NSYSMHR10	278	NSYSPC	313
NSYSM2016502D	18, 114	NSYSMHR12	278	NSYSPCD	313
NSYSM2016502DP	18, 114	NSYSMHR16	278	NSYSPCP	313
NSYSM2016602D	18, 114	NSYSMHR6	278	NSYSPCR	128
NSYSM2016602DP	18, 114	NSYSMHR8	278	NSYSPP10100	18, 21, 55, 60, 77, 82, 114, 117, 126, 520
NSYSM20630	18, 114	NSYSMNR	319	NSYSPP10200	19, 21, 55, 60, 77, 82, 115, 117, 126, 473, 520
NSYSM20630P	18, 114	NSYSMP2D4	270	NSYSPP12100	18, 21, 55, 60, 77, 82, 114, 117, 126, 520
NSYSM20640	18, 114	NSYSMP2D5	270, 353	NSYSPP12200	19, 21, 55, 60, 77, 82, 115, 117, 126, 520
NSYSM20640P	18, 114	NSYSMP2D6	270	NSYSPP16100	18, 21, 114, 117, 126, 520
NSYSM20640T	18, 114	NSYSMP2D8	270	NSYSPP16200	19, 21, 115, 117, 126, 520
NSYSM20650	18, 114	NSYSMPB	268	NSYSPP3100	21, 117, 126, 398, 433
NSYSM20650P	18, 114	NSYSMPFA	267	NSYSPP3200	21, 117, 126, 398, 433
NSYSM20830	18, 114	NSYSMPFB	267	NSYSPP4100	21, 117, 126, 433
NSYSM20830P	18, 114	NSYSMPFS4	268	NSYSPP4200	21, 117, 126, 433
NSYSM20830T	18, 114	NSYSMPFS5	268	NSYSPP6100	18, 21, 51, 55, 60, 77, 82, 114, 117, 126, 433, 473, 520, 528
NSYSM20840	18, 114	NSYSMPFS6	268	NSYSPP6200	19, 21, 51, 55, 60, 77, 82, 115, 117, 126, 433, 473, 520, 528
NSYSM20840P	18, 114	NSYSMPFS8	268	NSYSPP7100	398
NSYSM20840T	18, 114	NSYSMPFSB	268	NSYSPP7200	398
NSYSM20850	18, 114	NSYSMPSE10	269	NSYSPP8100	18, 21, 51, 55, 60, 77, 82, 114, 117, 126, 433, 473, 520
NSYSM20850P	18, 114	NSYSMPSE12	269	NSYSPP8200	19, 21, 51, 55, 60, 77, 82, 115, 117, 126, 433, 473, 520
NSYSM20850T	18, 114	NSYSMPSE6	269	NSYSPPV6100	127, 474
NSYSM20860	18, 114	NSYSMPSE8	269	NSYSPPV8100	127, 474
NSYSM20860P	18, 114	NSYSMVR12	278	NSYSPPVX12200	441, 445, 659
NSYSM20860T	18, 114	NSYSMVR14	278	NSYSPPVX6200	441, 445, 659
NSYSMBCE10	133	NSYSMVR16	278	NSYSPPVX8200	441, 445, 659
NSYSMBCE6	133	NSYSMVR18	278	NSYSPPX10100	25, 60, 167, 176, 520
NSYSMBCE8	133	NSYSMVR20	278	NSYSPPX10100H	60, 167, 176
NSYSMBK	123	NSYSMWWFIX	138	NSYSPPX10200	25, 60, 167, 176, 520
NSYSMD12102D	728	NSYSMX141030	25, 175	NSYSPPX10200H	60, 167, 176
NSYSMD12122D	728	NSYSMX16660PC	531	NSYSPPX12100	25, 176, 520
NSYSMD14102D	728	NSYSMX16840	25, 175	NSYSPPX12100H	176
NSYSMD14122D	728	NSYSMX181240	25, 175	NSYSPPX12200	25, 176, 441, 520
NSYSMD16102D	728	NSYSMX181240H	25, 175	NSYSPPX12200H	176
NSYSMD16122D	728	NSYSMX181640	25, 175	NSYSPPX16100	25, 176
NSYSMD18162D	728	NSYSMX181640H	25, 175	NSYSPPX16100H	176
NSYSMDR	319	NSYSMX18640	25, 175	NSYSPPX201040	25, 175
NSYSMEB	134	NSYSMX18660PC	531	NSYSMX201040H	25, 175
NSYSMEC103	130	NSYSMX18840	25, 175	NSYSMX201250	25, 175
NSYSMEC1031	728	NSYSMX18840H	25, 175	NSYSMX201250H	25, 175
NSYSMEC104	130	NSYSMX201040	25, 175		
NSYSMEC1041	728	NSYSMX201040H	25, 175		
NSYSMEC105	130	NSYSMX201250	25, 175		
NSYSMEC1051	728	NSYSMX201250H	25, 175		

Index of references

N	Page	N	Page	N	Page
NSYSPFX16200	25, 176	NSYSPSX3100H	60, 167, 176	NSYSTMP22120	266
NSYSPFX16200H	176	NSYSPSX3200	25, 60, 167, 176, 441, 445, 659	NSYSTMP2260	266
NSYSPFX6100	25, 176, 520, 531	NSYSPSX3200H	60, 167, 176	NSYSTMP2280	266
NSYSPFX6100H	176	NSYSPSX4100	25, 176	NSYSTMP45100	266
NSYSPFX6200	25, 176, 441, 520, 531	NSYSPSX4100H	176	NSYSTMP45120	266
NSYSPFX6200H	176	NSYSPSX4200SF	25, 176	NSYSTMP4560	266
NSYSPFX8100	25, 60, 167, 176, 520	NSYSPSX4200	25, 176, 441	NSYSTMP4580	266
NSYSPFX8100H	60, 167, 176	NSYSPSX4200H	176	NSYSTMP60100	266, 524
NSYSPFX8200	25, 60, 167, 176, 441, 520	NSYSPSX4200SF	25, 176, 441	NSYSTMP60120	266, 524
NSYSPFX8200H	60, 167, 176	NSYSPSX5100	25, 176, 521	NSYSTMP6060	266
NSYSPLA100	31, 245, 251	NSYSPSX5100H	176	NSYSTMP6080	266, 524
NSYSPLA125	31, 245, 251	NSYSPSX5100SF	25, 176	NSYSTMP82100	266
NSYSPLA150	31, 245, 251	NSYSPSX5200	25, 176, 521	NSYSTMP82120	266
NSYSPLA75	31, 245, 251	NSYSPSX5200H	176	NSYSTMP8260	266
NSYSPLK	129	NSYSPSX5200SF	25, 176	NSYSTMP8280	266
NSYSPLVX3200	441	NSYSPSX6100	25, 176, 531	NSYSTVDA	595
NSYSPLVX4200	441, 445, 659	NSYSPSX6100H	176	NSYSTW	317
NSYSPLVX4200SF	441	NSYSPSX6100SF	25, 176	NSYSUCR200WM	67, 84
NSYSPLVX6200	445, 659	NSYSPSX6200	25, 176, 531	NSYSUCR250WM	67, 84
NSYSPLVX6200SF	441	NSYSPSX6200H	176	NSYSUCR300WM	67, 84
NSYSPM6	129	NSYSPSX6200SF	25, 176, 441	NSYSUCR400WM	67, 84
NSYSPMP25100	247, 266	NSYSPV6100	127, 474	NSYSUCR40100	274
NSYSPMP25120	266	NSYSPV8100	127, 474	NSYSUCR40110	129, 274
NSYSPMP2560	266	NSYSQCR12040	275, 727	NSYSUCR40120	274
NSYSPMP2575	247, 266	NSYSQCR12050	275, 727	NSYSUCR40140	274
NSYSPMP2580	266	NSYSQCR12060	275, 727	NSYSUCR40160	274
NSYSPMP40100	247, 266, 524	NSYSQCR12080	275, 727	NSYSUCR40180	274
NSYSPMP40120	266, 524	NSYSQCR40100	275	NSYSUCR40200	274, 398, 423, 428
NSYSPMP40160	266, 524	NSYSQCR40120	275	NSYSUCR40220	274
NSYSPMP4060	266	NSYSQCR4040	275, 279	NSYSUCR4030	129, 274
NSYSPMP4080	266, 524	NSYSQCR4050	275, 279	NSYSUCR4040	129, 274, 279
NSYSPMP60100	266	NSYSQCR4060	275, 279	NSYSUCR4050	129, 274, 279
NSYSPMP60120	266	NSYSQCR4080	275, 279	NSYSUCR4060	274, 279, 528
NSYSPMP6060	266	NSYSQCR65100	275	NSYSUCR4070	129, 274
NSYSPMP6080	266	NSYSQCR65120	275	NSYSUCR4080	274, 279, 528
NSYSPRJ	317	NSYSQCR6540	275	NSYSUCR4090	129, 274
NSYSPS10100	473	NSYSQCR6550	275	NSYSUCR65100	274
NSYSPS3100	18, 114, 126	NSYSQCR6560	275	NSYSUCR65120	274
NSYSPS3100SD	51, 55, 60, 77, 82	NSYSQCR6580	275	NSYSUCR65140	274
NSYSPS3200	19, 115, 126	NSYSQCR90100	275	NSYSUCR65160	274
NSYSPS3200SD	51, 55, 60, 77, 82	NSYSQCR90120	275	NSYSUCR65180	274
NSYSPS4100	18, 21, 114, 117, 126	NSYSQCR9040	275	NSYSUCR65200	274
NSYSPS4100SD	55, 60, 77, 82, 521	NSYSQCR9050	275	NSYSUCR65220	274
NSYSPS4200	19, 21, 115, 117, 126	NSYSQCR9060	275	NSYSUCR6530	274
NSYSPS4200SD	55, 60, 77, 82, 521	NSYSQCR9080	275	NSYSUCR6540	274
NSYSPS5100	18, 21, 114, 117, 126, 398	NSYSRCOPB	568	NSYSUCR6550	274
NSYSPS5100SD	521	NSYSSOPB	565	NSYSUCR6560	274
NSYSPS5200	19, 21, 115, 117, 126, 398	NSYST30M6	291	NSYSUCR6580	274
NSYSPS5200SD	521	NSYST30M6S	291	NSYSUCR90100	274
NSYSPS6100	18, 21, 114, 117, 126, 398, 433, 473, 528	NSYST40M8	291	NSYSUCR90110	129, 274
NSYSPS6100SD	521	NSYSTBR3	270	NSYSUCR90120	274
NSYSPS6200	19, 21, 115, 117, 126, 398, 433, 473, 528	NSYSTBR4	270	NSYSUCR90140	274
NSYSPS6200SD	521	NSYSTBR5	270	NSYSUCR90160	274
NSYSPS8100	21, 117, 126, 398, 433, 473, 528	NSYSTBR6	270	NSYSUCR90180	274
NSYSPS8200	21, 117, 126, 398, 433, 473, 528	NSYSTDCSX	169	NSYSUCR90200	274
NSYSPSJ	317	NSYSTDCX2H	169	NSYSUCR90220	274
NSYSPSX3100	25, 60, 167, 176	NSYSTDCXH	169	NSYSUCR9030	129, 274
		NSYSTDNCSX	169	NSYSUCR9040	129, 274
		NSYSTMP22100	266	NSYSUCR9050	129, 274

Index of references

N	Page	N	Page	N	Page
NSYSUCR9060	274	NSYTBP292412T	11, 186	NSYTC8ML	64
NSYSUCR9070	129, 274	NSYTBP292416H	11, 186	NSYTC274	204
NSYSUCR9080	274	NSYTBP292416HT	11, 186	NSYTC276	204
NSYSUCR9090	129, 274	NSYTBP29248	11, 186	NSYTC278	204
NSYSUPLA3G	236	NSYTBP29248T	11, 186	NSYTCL405ME	177, 222
NSYSUPLA3TG	236	NSYTBP342912	11, 186	NSYTCL610ME	177
NSYSUPLA4G	236	NSYTBP342912T	11, 186	NSYTCM274	204
NSYSUPLA4TG	236	NSYTBP342916H	11, 186	NSYTCRE1	726
NSYSVR606	136, 478	NSYTBP342916HT	11, 186	NSYTCRE12	726
NSYSVR608	136, 478	NSYTBP775	11, 186	NSYTC6SM6PLM	224
NSYSVR806	136, 478	NSYTBP885	11, 186	NSYTC6SPLM	215, 224
NSYSVR808	136, 478	NSYTBS111113H	11, 186	NSYTC274	204
NSYSW	317	NSYTBS11116	11, 186	NSYTD5ME	177, 222
NSYSWMBP	724, 725, 726, 732	NSYTBS1176	11, 186	NSYTD5PL	223
NSYSWMCH	724, 725, 726, 732	NSYTBS1179H	11, 186	NSYTD6CRN	63, 433
NSYSWMEL	724, 725, 726, 731, 732	NSYTBS1397	11, 186	NSYTD6SF2D	727, 728, 729, 730
NSYTBC3105	358	NSYTBS1397T	11, 186	NSYTEC6PL	223
NSYTBC3106	358	NSYTBS16128	11, 186	NSYTEC7PL	223
NSYTBC3108	358	NSYTBS16128T	11, 186	NSYTEC8ML	64
NSYTBC3125	358	NSYTBS191210H	11, 186	NSYTEDB5ML	64
NSYTBC3126	358	NSYTBS191210HT	11, 186	NSYTEDB5PL	223
NSYTBC3128	358	NSYTBS19128	11, 186	NSYTEL1242EPL	223
NSYTBC335	358	NSYTBS19128T	11, 186	NSYTEL405ML	64
NSYTBC336	358	NSYTBS191610H	11, 186	NSYTEL405PL	223
NSYTBC338	358	NSYTBS191610HT	11, 186	NSYTEL6ACPL	223
NSYTBC345	358	NSYTBS19168	11, 186	NSYTELJISPL	223
NSYTBC346	358	NSYTBS19168T	11, 186	NSYTERML	223
NSYTBC348	358	NSYTBS241910	11, 186	NSYTERPL	64
NSYTBC365	358	NSYTBS241910H	11, 186	NSYTERPL	223
NSYTBC366	358	NSYTBS241910HT	11, 186	NSYTER6PL	223
NSYTBC368	358	NSYTBS241910T	11, 186	NSYTER7ML	64
NSYTBC385	358	NSYTBS241912H	11, 186	NSYTER8ML	64
NSYTBC386	358	NSYTBS241912HT	11, 186	NSYTER8PL	223
NSYTBC388	358	NSYTBS24198	11, 186	NSYTEX5	225
NSYTBP11116	11, 186	NSYTBS24198T	11, 186	NSYTEX6	225
NSYTBP1176	11, 186	NSYTBS292412	11, 186	NSYTEX8	246, 251
NSYTBP1397	11, 186	NSYTBS292412H	11, 186	NSYTEX8PLM	225
NSYTBP1397T	11, 186	NSYTBS292412HT	11, 186	NSYTFPCR10	15, 75, 90, 309
NSYTBP16128	11, 186	NSYTBS292412T	11, 186	NSYTFPCR4	15, 75, 90, 309
NSYTBP16128T	11, 186	NSYTBS292416H	11, 186	NSYTFPCR5	15, 75, 90, 309
NSYTBP191210H	11, 186	NSYTBS292416HT	11, 186	NSYTFPCR6	15, 75, 90, 309
NSYTBP191210HT	11, 186	NSYTBS29248	11, 186	NSYTFPCR8	15, 75, 90, 309
NSYTBP19128	11, 186	NSYTBS29248T	11, 186	NSYTHL1242EPLM	222
NSYTBP19128T	11, 186	NSYTBS342912	11, 186	NSYTHL2331APLM	222
NSYTBP191610H	11, 186	NSYTBS342912T	11, 186	NSYTHL2433APLM	222
NSYTBP191610HT	11, 186	NSYTBS342916H	11, 186	NSYTHL3113APLM	222
NSYTBP19168	11, 186	NSYTBS342916HT	11, 186	NSYTHL3131APLM	222
NSYTBP19168T	11, 186	NSYTBS775	11, 186	NSYTHL405PLM	222
NSYTBP241910	11, 186	NSYTBS885	11, 186	NSYTHL421PLM	222
NSYTBP241910H	11, 186	NSYTC12100	311	NSYTHL455PLM	222
NSYTBP241910HT	11, 186	NSYTC6CRN	63, 222, 433	NSYTHPLM	222
NSYTBP241910T	11, 186	NSYTC6CSX	169	NSYTJ10030	56, 62, 77, 84
NSYTBP241912H	11, 186	NSYTC6ME	177, 222	NSYTJ10040	56, 62, 77, 84
NSYTBP241912HT	11, 186	NSYTC6ML	64	NSYTJ12030	56, 62, 77, 84
NSYTBP24198	11, 186	NSYTC7CRN	63, 222, 433, 522	NSYTJ12040	56, 62, 77, 84
NSYTBP24198T	11, 186	NSYTC7CSX	169	NSYTJ2015	52, 62, 77, 84
NSYTBP292412	11, 186	NSYTC7ML	64	NSYTJ2015HD	733
NSYTBP292412H	11, 186	NSYTC8CRN	63, 222, 433, 522	NSYTJ2515	52, 62, 77, 84
NSYTBP292412HT	11, 186	NSYTC8ME	177, 222	NSYTJ2520	52, 62, 84

Index of references

N	Page	N	Page	N	Page
NSYTJ3015	52, 62, 77, 84	NSYTLDME	53, 66, 76, 90, 300	NSYTPLSP2754G	200
NSYTJ3020	52, 62, 77, 84	NSYTLDU	76, 89, 107	NSYTPLSP3636G	200
NSYTJ3020HD	733	NSYTLDUHD	733	NSYTPLSP3654G	200
NSYTJ4015	52, 62, 77, 84	NSYTLF	53, 66, 76, 89, 100, 107	NSYTPLSP5454G	200
NSYTJ4020	52, 62, 77, 84	NSYTLF2FL	53, 66, 76, 89, 107, 305	NSYTPV	601
NSYTJ4020HD	733	NSYTLFME	53, 66, 76, 90, 300	NSYTS2414SE	91, 92, 301
NSYTJ4025	52, 62, 77, 84	NSYTLFLEFL	53, 66, 76, 89, 107, 305	NSYTS2417SE	91, 92, 301
NSYTJ4025HD	733	NSYTLFLEME	53, 66, 76, 90, 300	NSYTS2422SE	91, 92, 301
NSYTJ5015	52, 62, 84	NSYTLFLEU	76, 89, 107	NSYTS2423SE	91, 92, 301
NSYTJ5020	52, 62, 77, 84	NSYTLFLEUHD	733	NSYTS2429SE	91, 92, 301
NSYTJ5025	52, 62, 77, 84	NSYTLF	76, 89, 100, 107	NSYTSACRNA	13, 49, 65
NSYTJ5025HD	733	NSYTLF2FL	89, 107, 305	NSYTSACRNB	13, 49, 65
NSYTJ6020	52, 62, 77, 84	NSYTLFFL	76, 89, 107, 305	NSYTSACRNC	13, 49, 65
NSYTJ6025	52, 62, 77, 84	NSYTLFME	76, 90, 300	NSYTSACRND	13, 49, 65
NSYTJ6030	52, 56, 62, 77, 84	NSYTLFU	76, 89, 107	NSYTSAKFL	91, 95, 301
NSYTJ6030HD	733	NSYTLG	53, 66, 76, 89, 100, 107	NSYTSAM504SE	91, 92, 300
NSYTJ6040	56, 62, 77, 84	NSYTLG2FL	53, 66, 76, 89, 107, 305	NSYTSAM508SE	91, 92, 300
NSYTJ6040HD	733	NSYTLG4FL	89, 107, 297, 305	NSYTSAM6313SE	91, 92, 300
NSYTJ8020	52, 62, 84	NSYTLGFL	89, 107, 305	NSYTSAM638SE	91, 92, 300
NSYTJ8025	52, 62, 77, 84	NSYTLGME	53, 66, 76, 90, 300	NSYTSML	64, 169
NSYTJ8030	52, 56, 62, 77, 84	NSYTLGU	76, 89, 107	NSYTSP450	476, 600
NSYTJ8040	56, 62, 77, 84	NSYTLGUHD	733	NSYTSPC450	476, 600
NSYTJ8040HD	733	NSYTLJISME	177, 222	NSYTSPLA	243
NSYTJIS	222	NSYTLK2414	91, 95, 303	NSYTSPV450	476
NSYTJPLA103G	31, 237	NSYTLK2422	91, 95, 303	NSYTT6CRN	63, 222, 433
NSYTJPLA104G	31, 237	NSYTLK2428	91, 95, 303	NSYTT6ME	177, 222
NSYTJPLA123G	31, 237	NSYTLK2446	91, 95, 303	NSYTT7CRN	63, 433
NSYTJPLA124G	31, 237	NSYTLK24M	91, 95, 303	NSYTT7ML	64
NSYTJPLA126G	31, 237	NSYTLRME	177, 222	NSYTT8CRN	63, 222, 433, 522
NSYTJPLA53G	31, 237	NSYTMME	177, 222	NSYTT8CSX	169
NSYTJPLA54G	31, 237	NSYTPLS1827	200	NSYTT8ME	177, 222
NSYTJPLA73G	31, 237	NSYTPLS2727	200	NSYTT8ML	64
NSYTJPLA74G	31, 237	NSYTPLS2727A	201	NSYTTG40	279
NSYTJPLA76G	31, 237	NSYTPLS2736	200	NSYTTG50	279
NSYTL1242EME	177	NSYTPLS2736A	201	NSYTTG60	279, 528
NSYTL220PLM	222	NSYTPLS2754	200	NSYTUP7032	324
NSYTL27270G	199, 203	NSYTPLS2754A	201	NSYTUP7035	324
NSYTL27360G	203	NSYTPLS3636	200	NSYTVA	619
NSYTL405PLM	222	NSYTPLS3654	200	NSYTVAR	617
NSYTL405SML	64	NSYTPLS3654A	201	NSYTVP356	617
NSYTLA	76, 89, 100, 107	NSYTPLS3672A	201	NSYTVP556	617
NSYTLAFL	89, 107	NSYTPLS4544	200	NSYTVP756	617
NSYTLAU	76, 89, 107	NSYTPLS5454A	201	NSYTVPSL6	603
NSYTLAUHD	733	NSYTPLS5472A	201	NSYTVPSL8	603
NSYTLB	76, 89, 100, 107	NSYTPLSC1827G	200	NSYTVPSP10	603
NSYTLBFL	76, 89, 107, 305	NSYTPLSC2727AG	201	NSYTVPSP6	603
NSYTLBU	76, 89, 107	NSYTPLSC2727G	200	NSYTVPSP8	603
NSYTLCL	76, 89, 100, 107, 137	NSYTPLSC2736AG	201	NSYTVR10	247, 271
NSYTLCLFL	76, 89, 107, 137, 305	NSYTPLSC2736G	200	NSYTVR12	19, 21, 115, 117, 271
NSYTLCLME	76, 90, 137, 300	NSYTPLSC2754AG	201	NSYTVR125	247, 271
NSYTLCRNA	13, 49, 65	NSYTPLSC2754G	200	NSYTVR14	19, 21, 115, 117, 179, 271, 525
NSYTLCRNB	13, 49, 65	NSYTPLSC3636G	200	NSYTVR15	247, 271
NSYTLCRNC	13, 49, 65	NSYTPLSC3654AG	201	NSYTVR16	19, 21, 115, 117, 179, 271
NSYTLCRND	13, 49, 65	NSYTPLSC3654G	200	NSYTVR18	19, 21, 115, 117, 179, 271
NSYTLCRNO	13, 49, 65	NSYTPLSC3672AG	201	NSYTVR20	19, 21, 115, 117, 179, 271
NSYTLCLU	76, 89, 107, 137	NSYTPLSC5454AG	201	NSYTVR22	21, 117, 271
NSYTLCLUHD	733	NSYTPLSC5454G	200	NSYTVR7	247, 271
NSYTLCLD	53, 66, 76, 89, 100, 107	NSYTPLSC5472AG	201	NSYTVR8	271, 525
NSYTLCLDFL	53, 66, 76, 89, 107, 305	NSYTPLSP1827G	200	NSYTVRN42U	598
		NSYTPLSP2727G	200		
		NSYTPLSP2736G	200		

Index of references

N	Page	N	Page	N	Page
NSYTX10030	24, 168	NSYVDA24U810B	578, 579	NSYVDA47U68B	578, 579
NSYTX12030	24, 168	NSYVDA24U810E	582, 583	NSYVDA47U68E	582, 583
NSYTX2015	24, 168	NSYVDA24U86B	578, 579	NSYVDA47U86B	578, 579
NSYTX2515	24, 168	NSYVDA24U86E	582, 583	NSYVDA47U86E	582, 583
NSYTX3015	24, 168	NSYVDA24U88B	578, 579	NSYVDA47U88B	578, 579
NSYTX3020	24, 168	NSYVDA24U88E	582, 583	NSYVDA47U88E	582, 583
NSYTX4020	24, 168	NSYVDA29U66B	578, 579	NSYVDAC42U88B	578, 579
NSYTX5025	24, 168	NSYVDA29U68B	578, 579	NSYVDAC42U88E	582, 583
NSYTX6020	24, 168	NSYVDA29U86B	578, 579	NSYVDASAVKIT	631
NSYTX6025	24, 168	NSYVDA29U88B	578, 579	NSYVDM10U4F	16, 469
NSYTX8030	24, 168	NSYVDA33U66B	578, 579	NSYVDM11UUP	51, 76, 289, 471
NSYUCA22	286, 333	NSYVDA33U68B	578, 579	NSYVDM12UUF	51, 76, 289, 471
NSYUCA44	286, 333	NSYVDA33U88B	578, 579	NSYVDM13U4P	16, 469
NSYUCC270	203	NSYVDA38U66B	578, 579	NSYVDM14U4F	16, 469
NSYUCC360	203	NSYVDA38U66E	582, 583	NSYVDM16U4P	16, 469
NSYUM27180	203	NSYVDA38U68B	578, 579	NSYVDM16UUP	51, 55, 76, 289, 471
NSYUM27270	203	NSYVDA38U68E	582, 583	NSYVDM17U4F	16, 469
NSYUM27360	203	NSYVDA38U86B	578, 579	NSYVDM17UUF	51, 55, 76, 289, 471
NSYUR20	287, 333	NSYVDA38U86E	582, 583	NSYVDM20U8P	51, 55, 76, 289, 471
NSYUR40	287, 333	NSYVDA38U88B	578, 579	NSYVDM20UUP	51, 55, 76, 289, 471
NSYUR60	287, 333	NSYVDA38U88E	582, 583	NSYVDM21UUF	51, 55, 76, 289, 471
NSYUT20	287, 333	NSYVDA42U610B	578, 579	NSYVDM25U8P	55, 76, 289, 471
NSYUT40	287, 333	NSYVDA42U610E	582, 583	NSYVDM4U4P	16, 469
NSYUT60	287, 333	NSYVDA42U610EN	582, 583	NSYVDM5U4F	16, 469
NSYUTA22	286, 333	NSYVDA42U610LN	586, 587	NSYVDM7U4P	16, 469
NSYUTA42	286, 333	NSYVDA42U66B	578, 579	NSYVDM7UUP	51, 76, 289, 471
NSYUTA44	286, 333	NSYVDA42U66BK	579	NSYVDM8U4F	16, 469
NSYUVPLA	236	NSYVDA42U66E	582, 583	NSYVDM8UUF	51, 76, 289, 471
NSYVA2710M	321	NSYVDA42U66EN	582, 583	NSYVDM9U4P	16, 469
NSYVA2710MA	321	NSYVDA42U66L	586, 587	NSYVDS24U810N	591, 592
NSYVA2712M	321	NSYVDA42U66LR	586, 587	NSYVDS24U88N	591, 592
NSYVA2712MA	321	NSYVDA42U68B	578, 579	NSYVDS42U610N	591, 592
NSYVA2716M	321	NSYVDA42U68E	582, 583	NSYVDS42U68N	591, 592
NSYVA2724M	321	NSYVDA42U68EN	582, 583	NSYVDS42U810N	591, 592
NSYVA272M	321	NSYVDA42U68L	586, 587	NSYVDS42U88N	591, 592
NSYVA272MA	321	NSYVDA42U68LR	586, 587	NSYVDSC42U810N	591
NSYVA274M	321	NSYVDA42U6GGD	631	NSYVEA9	225
NSYVA274MA	321	NSYVDA42U810B	578, 579	NSYVL400	601
NSYVA276M	321	NSYVDA42U810BK	579	NSYVPHD10	428
NSYVA276MA	321	NSYVDA42U810E	582, 583	NSYVPHD12	732
NSYVA278M	321	NSYVDA42U810EN	582, 583	NSYVPHD15	732
NSYVA278MA	321	NSYVDA42U810LN	586, 587	NSYVPHD5	732
NSYVD2M10U4	16, 469, 485	NSYVDA42U86B	578, 579	NSYVPHD7	732
NSYVD2M10U5	16, 469, 485	NSYVDA42U86E	582, 583	NSYVPLA10MG	730
NSYVD2M14U4	16, 469, 485	NSYVDA42U86EN	582, 583	NSYVPLA12MG	730
NSYVD2M14U5	16, 469, 485	NSYVDA42U86L	586, 587	NSYVPLA15MG	730
NSYVD2M17U4	16, 469, 485	NSYVDA42U86LR	586, 587	NSYVPLA5MG	730
NSYVD2M17U5	16, 469, 485	NSYVDA42U88B	578, 579	NSYVPLM108	215, 731
NSYVD2M5U4	16, 469, 485	NSYVDA42U88BK	579	NSYVR18	19, 21, 115, 117, 179, 271
NSYVD2M5U5	16, 469, 485	NSYVDA42U88E	582, 583	NSYVR20	19, 21, 115, 117, 179, 271
NSYVD2M8U4	16, 469, 485	NSYVDA42U88EN	582, 583	NSYVR22	21, 117, 271
NSYVD2M8U5	16, 469, 485	NSYVDA42U88L	586, 587	NSYWMMK33	56, 59, 78, 81
NSYVDA24U610B	578, 579	NSYVDA42U88LR	586, 587	NSYWMMK34	56, 59, 78, 81
NSYVDA24U610E	582, 583	NSYVDA42U88BVD	631	NSYWMMK43	56, 59, 78, 81
NSYVDA24U66B	578, 579	NSYVDA42U8DBVD	631	NSYWMMK44	56, 59, 78, 81
NSYVDA24U66E	582, 583	NSYVDA42U8GGD	631	NSYZA2103G	31, 238
NSYVDA24U68B	578, 579	NSYVDA42U8S2P	631	NSYZA2104G	31, 238
NSYVDA24U68E	582, 583	NSYVDA47U66B	578, 579		
NSYVDA24U68L	586, 587	NSYVDA47U66E	582, 583		

Index of references

N	Page
NSYZA2123G	31, 238
NSYZA2124G	31, 238
NSYZA2126G	31, 238
NSYZA253G	31, 238
NSYZA254G	31, 238
NSYZA273G	31, 238
NSYZA274G	31, 238
NSYZA276G	31, 238
NSYZHPLA103G	31, 241
NSYZHPLA104G	31, 241
NSYZHPLA123G	31, 241
NSYZHPLA124G	31, 241
NSYZHPLA53G	31, 241
NSYZHPLA54G	31, 241
NSYZHPLA73G	31, 241
NSYZHPLA74G	31, 241
NSYZM253G	27, 217
NSYZM263G	27, 217
NSYZM283G	27, 217
NSYZNPLA103G	31, 239
NSYZNPLA104G	31, 239
NSYZNPLA123G	31, 239
NSYZNPLA124G	31, 239
NSYZNPLA53G	31, 239
NSYZNPLA54G	31, 239
NSYZNPLA73G	31, 239
NSYZNPLA74G	31, 239
NSYZUN610VDA	578, 580, 582, 584, 586, 587, 591, 592, 605
NSYZUN65OPB	567
NSYZUN66OPB	567
NSYZUN66VDA	578, 580, 582, 584, 586, 587, 605
NSYZUN68VDA	578, 580, 582, 584, 586, 587, 591, 592, 605
NSYZUN810VDA	578, 580, 582, 584, 586, 587, 591, 592, 605
NSYZUN86VDA	578, 580, 582, 584, 586, 587, 605
NSYZUN88VDA	578, 580, 582, 584, 586, 587, 591, 592, 605
NSYZUNA1000VDA	605
NSYZUNA800VDA	605
NSYZZ2103G	31, 240
NSYZZ2104G	31, 240
NSYZZ2123G	31, 240
NSYZZ2124G	31, 240, 437
NSYZZ2124VHD	437, 445, 659
NSYZZ2126G	31, 240, 437
NSYZZ2126VHD	437, 445, 659
NSYZZ253G	31, 240
NSYZZ254G	31, 240, 437
NSYZZ254VHD	437, 445, 659
NSYZZ273G	31, 240
NSYZZ274G	31, 240, 437
NSYZZ274VHD	437, 445, 659
NSYZZ276G	31, 240, 437
NSYZZ276VHD	437, 445, 659
NSYZZ5103G	31, 240

N	Page
NSYZZ5104G	31, 240
NSYZZ5123G	31, 240
NSYZZ5124G	31, 240
NSYZZ553G	31, 240
NSYZZ554G	31, 240
NSYZZ573G	31, 240
NSYZZ574G	31, 240

V	Page
VDIM33174	594

X	Page
XALE2	187
XALE2141	187
XALE3	187
XALE3255	187
XALEK170	187
XALEK1702	187

Life Is On

Schneider
Electric

Schneider Electric Industries SAS
35, rue Joseph Monier
CS 30323
92506 Rueil Malmaison Cedex
France

RCS Nanterre 954 503 439
Capital social 896 313 776
se.com