

Protective covers - HC-HPR-B24-BCLWH-E-BK - 1418446

Please be informed that the data shown in this PDF Document is generated from our Online Catalog. Please find the complete data in the user's documentation. Our General Terms of Use for Downloads are valid (<http://phoenixcontact.com/download>)



Protective cover B24, with screw locking, material: Aluminum die-cast, protective cover material: Al, height: 32 mm, for increased environmental and EMC requirements

Your advantages

- Vibration and shock: IEC 61373/EN 50155, category 1, class 1B



Key Commercial Data

Packing unit	1 pc
GTIN	
GTIN	4055626140254

Technical data

Dimensions

Height	32 mm
Width	58 mm
Length	193 mm

Ambient conditions

Degree of protection of housing (IP)	IP66
	IP68
	IP69K (ISO 20653:2013-02)
Ambient temperature (operation)	-40 °C ... 125 °C

General

Note	Protective cover for supporting base elements
Size	B24
Housing type	Protective cover
Color	black
Locking type	with screw locking

Protective covers - HC-HPR-B24-BCLWH-E-BK - 1418446

Technical data

General

Housing material	Aluminum die-cast
Housing surface material	Powder-coated, black
Material of locking screw	Stainless steel
Material, protective cover	Al

Environmental Product Compliance

China RoHS	Environmentally friendly use period: unlimited = EFUP-e
	No hazardous substances above threshold values

Drawings

Dimensional drawing

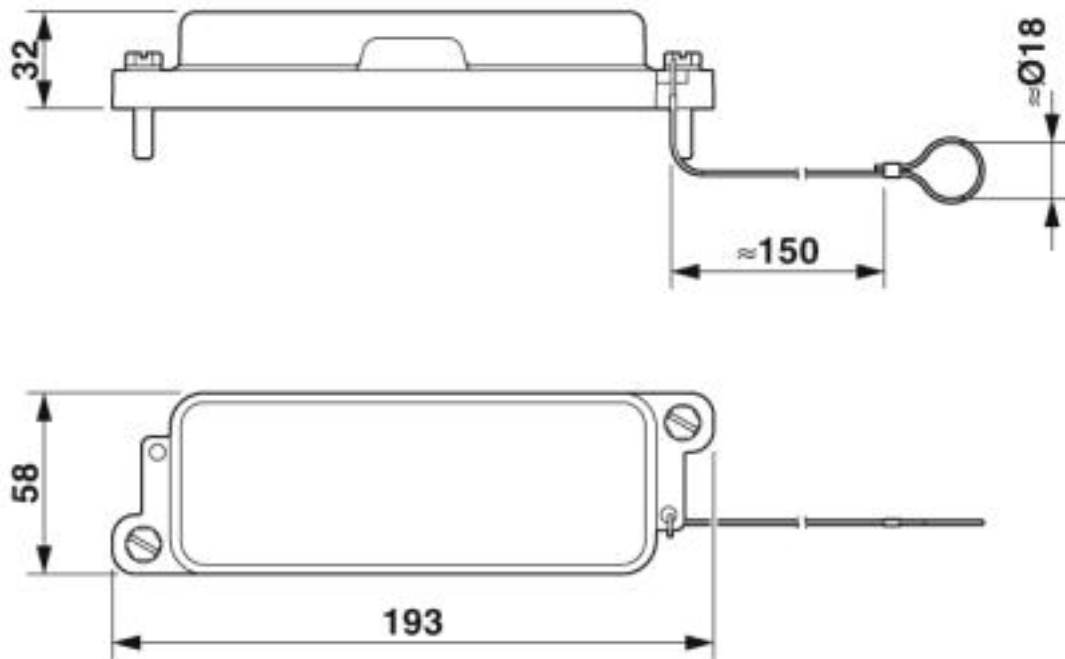

Dimensional drawing

Approvals

Approvals

Approvals

EAC

Ex Approvals

Protective covers - HC-HPR-B24-BCLWH-E-BK - 1418446

Approvals

Approval details

EAC		RU C- DE.AI30.B.01102
-----	---	--------------------------

Phoenix Contact 2019 © - all rights reserved
<http://www.phoenixcontact.com>

PHOENIX CONTACT GmbH & Co. KG
Flachsmarktstr. 8
32825 Blomberg
Germany
Tel. +49 5235 300
Fax +49 5235 3 41200
<http://www.phoenixcontact.com>