

PCB VIEWING HOLES  
 DETAIL A  
 SCALE 5:1

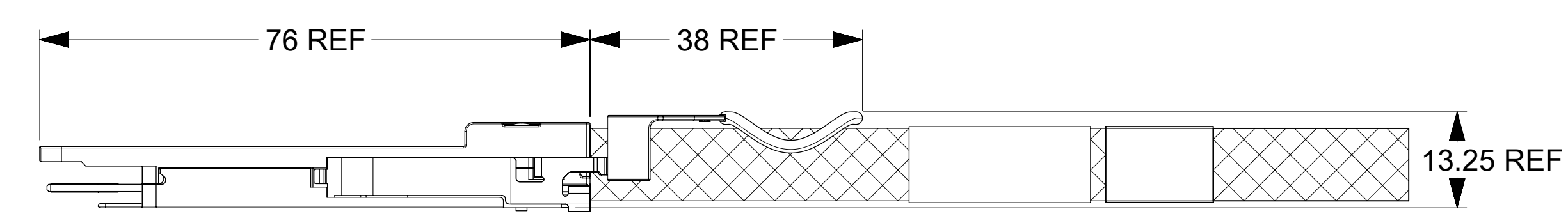
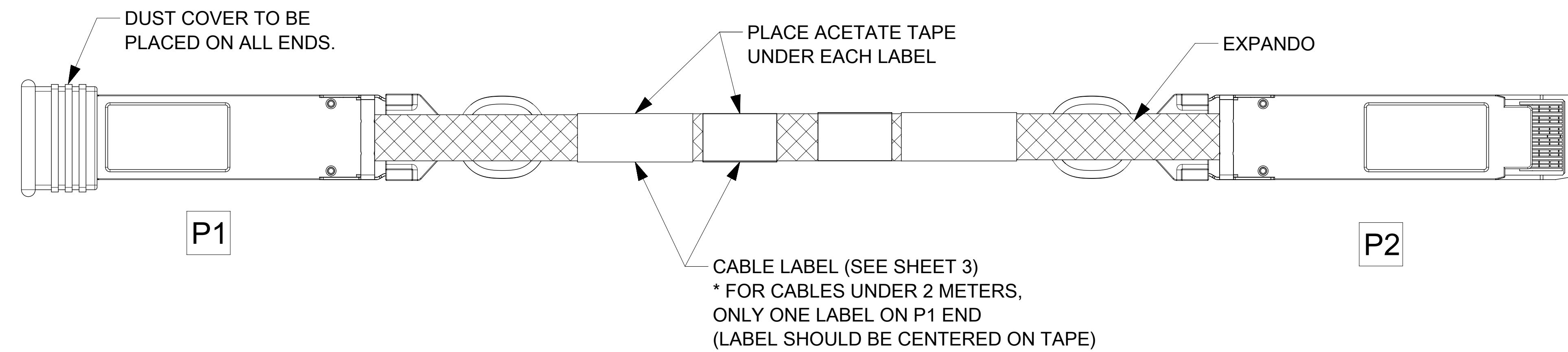

- NOTES:**
- CABLE LENGTH DEPENDS ON WIRE GAUGE, DATA RATE, AND HOST BOARD DRIVER CAPABILITIES
  - MATERIALS:**
    - BACKSHELLS - ZINC DIE CAST WITH BRIGHT NICKEL PLATING
    - DELATCH - STAINLESS STEEL WITH OVERMOLDED NYLON
    - RIVETS - STAINLESS STEEL
  - IMPEDANCE - 100 OHMS DIFFERENTIAL
  - BUNDLED CABLE RATED UL VW-1 FLAME PER UL STYLE 21479
  - EEPROM MAP AVAILABLE UPON REQUEST
  - RoHS COMPLIANT, NO EXEMPTIONS

FUNCTIONAL SYMBOLS $F_A = 0$ $F_C = 0$ $F_P = 0$ DIVISIONAL SYMBOLS	THIS DRAWING CONTAINS INFORMATION THAT IS PROPRIETARY TO MOLEX ELECTRONIC TECHNOLOGIES, LLC AND SHOULD NOT BE USED WITHOUT WRITTEN PERMISSION		CURRENT REV DESC: SHEET4 : ADDED LENGTH 2M 30AWG IN P/N TABLE					
	DIMENSION UNITS <b>mm</b>	SCALE <b>2:1</b>	GENERAL TOLERANCES (UNLESS SPECIFIED)					
	ANGULAR TOL $\pm 5.0^\circ$		EC NO: 677116 DRWN: ADITHK 2021/05/24 CHK'D: VITTAD 2021/09/09 APPR: MGARRISON 2021/09/10					
	4 PLACES $\pm$ 3 PLACES $\pm$ 2 PLACES $\pm 0.13$ 1 PLACE $\pm 0.25$ 0 PLACES $\pm$		INITIAL REVISION: DRWN: TPRATT 2016/11/08 APPR: CHIRSCHY 2016/11/10					
DRAFT WHERE APPLICABLE MUST REMAIN WITHIN DIMENSIONS		THIRD ANGLE PROJECTION	DRAWING <b>D-SIZE</b>	SERIES <b>201591</b>	DOCUMENT NUMBER <b>2015911005</b>	DOC TYPE <b>PSD</b>	DOC PART <b>000</b>	REVISION <b>U</b>
PRODUCT CUSTOMER DRAWING		MATERIAL NUMBER <b>SEE P/N TABLE</b>		CUSTOMER <b>GENERAL MARKET</b>		SHEET NUMBER <b>1 OF 4</b>		

DOCUMENT STATUS	P1	RELEASE DATE	2021/09/10	01:01:00
-----------------	----	--------------	------------	----------

# CABLE BEND RADIUS

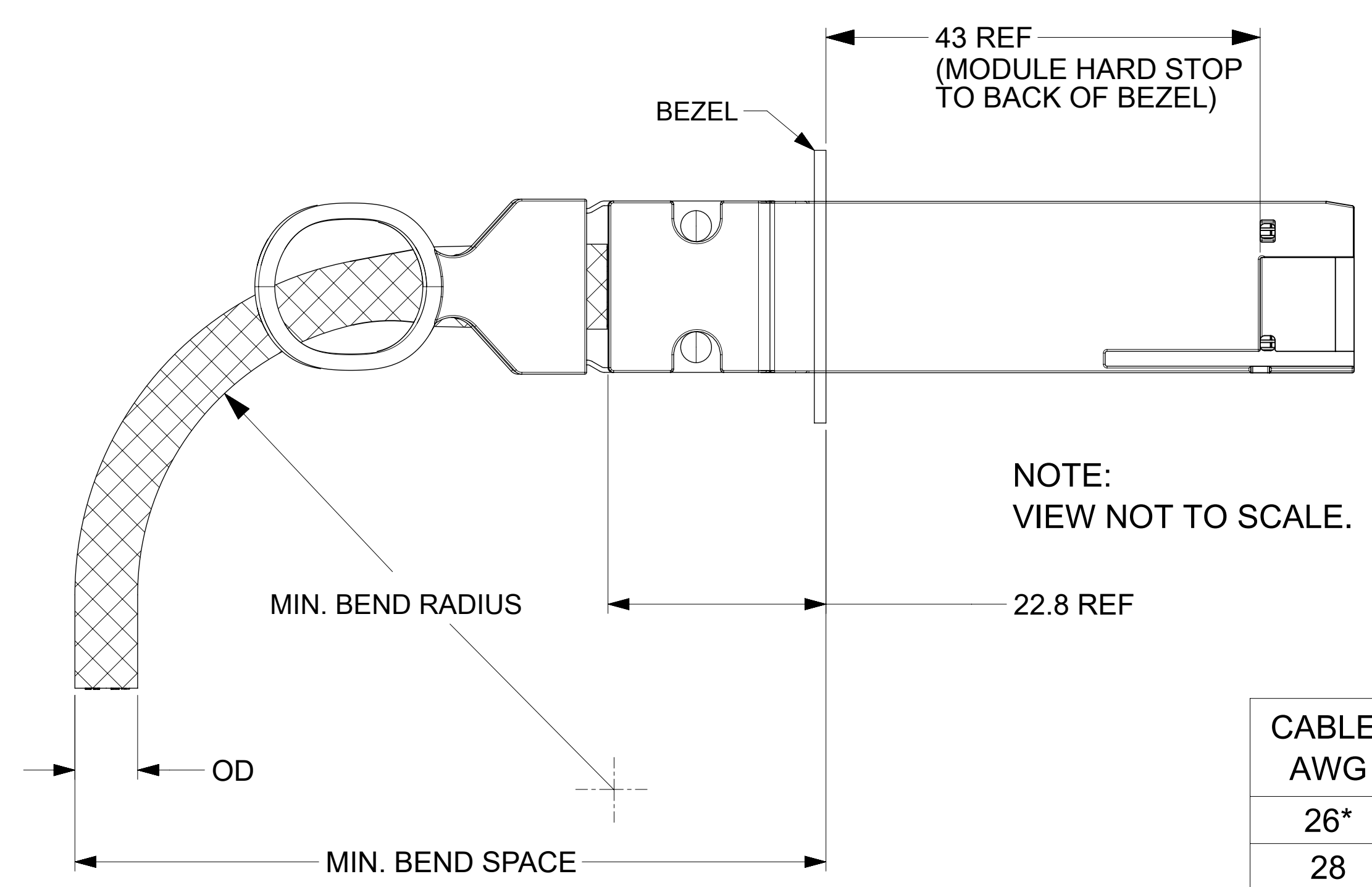

NOTE:  
VIEW NOT TO SCALE.

CABLE AWG	OD (mm)	MIN BEND RADIUS (mm)	MIN BEND SPACE (mm)
26*	(13)	(65)	(101)
28	(11)	(55)	(89)
30	(9.4)	(45)	(77)

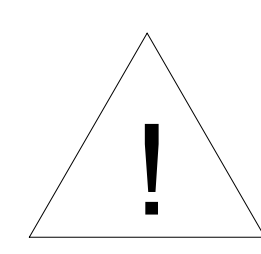

\*MINIMUM BEND RADIUS PENDING QUALIFICATION. NUMBERS ABOVE ARE ESTIMATES AND SUBJECT TO CHANGE.

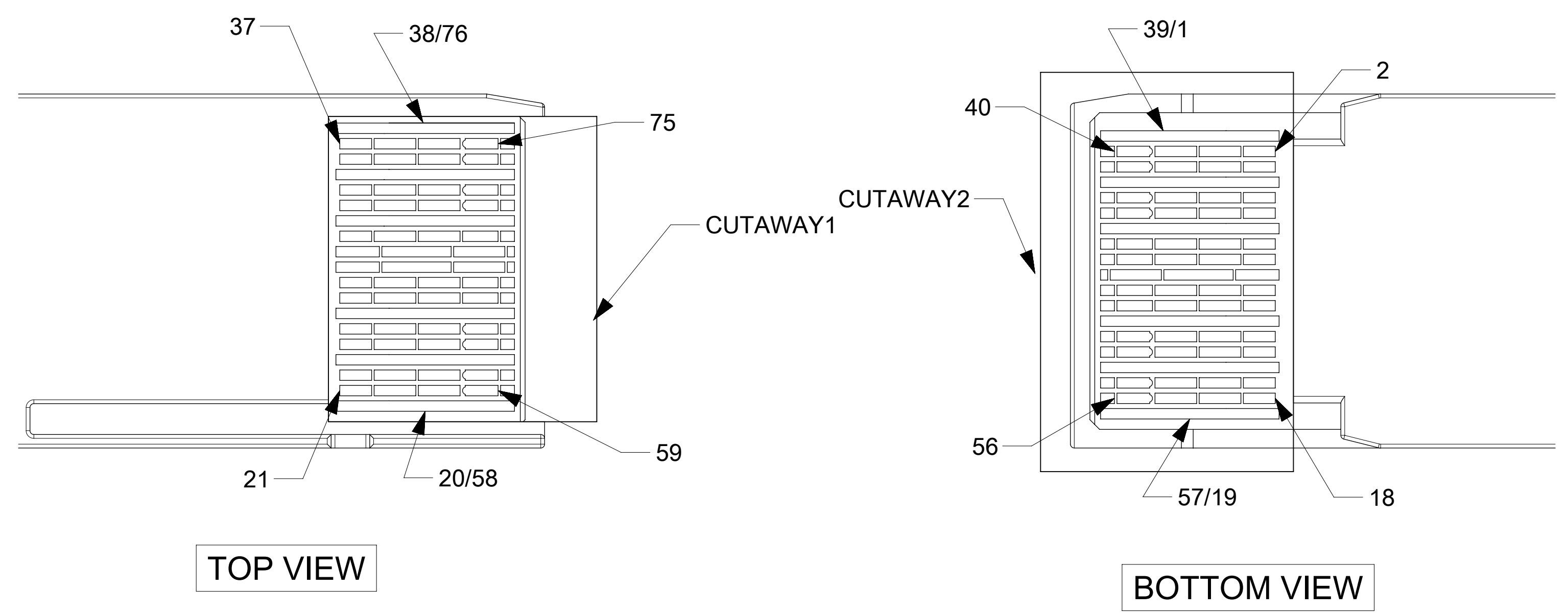

- NOTES:
- DC BLOCKING CAPS ON RECEIVE SIDE ONLY
  - CABLE COILED AND PACKAGED IN BEST FIT ESD BAG AND SEALED WITH ESD LABEL FOR SHIPPING

<b>FUNCTIONAL SYMBOLS</b> $F_A = 0$ $F_C = 0$ $F_P = 0$	DIMENSION UNITS: <b>mm</b> SCALE: <b>20:1</b>		CURRENT REV DESC: SHEET4 : ADDED LENGTH 2M 30AWG IN P/N TABLE				
	GENERAL TOLERANCES (UNLESS SPECIFIED)		EC NO: 677116 DRWN: ADITHK 2021/05/24 CHK'D: VITTAD 2021/09/09 APPR: MGARRISON 2021/09/10			PRODUCT CUSTOMER DRAWING	
	ANGULAR TOL $\pm 5.0^\circ$		INITIAL REVISION: DRWN: TPRATT 2016/11/08 APPR: CHIRSCHY 2016/11/10				DOCUMENT NUMBER: <b>2015911005</b>
	DRAFT WHERE APPLICABLE MUST REMAIN WITHIN DIMENSIONS		THIRD ANGLE PROJECTION	DRAWING: <b>D-SIZE</b>		SERIES: <b>201591</b>	MATERIAL NUMBER: <b>SEE P/N TABLE</b>

# WIRING DIAGRAM

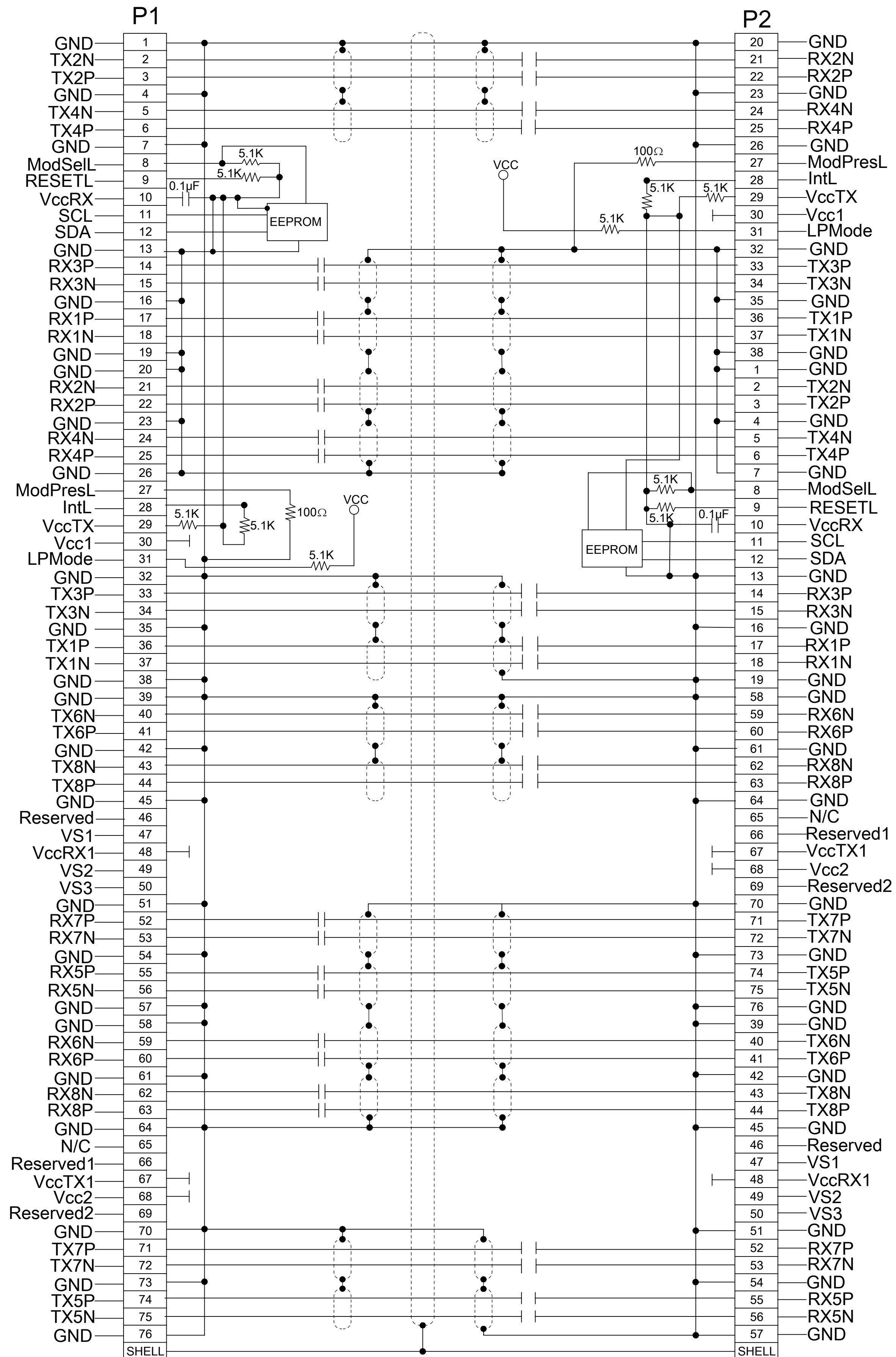

FUNCTIONAL SYMBOLS $\nabla_A = 0$ $\nabla_C = 0$ $\nabla_P = 0$	DIMENSION UNITS <b>mm</b>	SCALE <b>1:1</b>	THIS DRAWING CONTAINS INFORMATION THAT IS PROPRIETARY TO MOLEX ELECTRONIC TECHNOLOGIES, LLC AND SHOULD NOT BE USED WITHOUT WRITTEN PERMISSION			
	GENERAL TOLERANCES (UNLESS SPECIFIED) ANGULAR TOL $\pm 5.0^\circ$			CURRENT REV DESC: SHEET4 : ADDED LENGTH 2M 30AWG IN P/N TABLE		
DIVISIONAL SYMBOLS 4 PLACES $\pm$ 3 PLACES $\pm$ 2 PLACES $\pm 0.13$ 1 PLACE $\pm 0.25$ 0 PLACES $\pm$	DRAFT WHERE APPLICABLE MUST REMAIN WITHIN DIMENSIONS		THIRD ANGLE PROJECTION 	DRAWING <b>D-SIZE</b>	SERIES <b>201591</b>	EC NO: 677116 DRWN: ADITHK 2021/05/24 CHK'D: VITTAD 2021/09/09 APPR: MGARRISON 2021/09/10 INITIAL REVISION: DRWN: TPRATT 2016/11/08 APPR: CHIRSCHY 2016/11/10
	DOCUMENT NUMBER <b>2015911005</b>			DOC TYPE <b>PSD</b>	DOC PART <b>000</b>	REVISION <b>U</b>
	PRODUCT CUSTOMER DRAWING			MATERIAL NUMBER <b>2015911005</b>		
	SEE P/N TABLE			CUSTOMER GENERAL MARKET		
SHEET NUMBER <b>3 OF 4</b>						

**LABEL DETAILS**

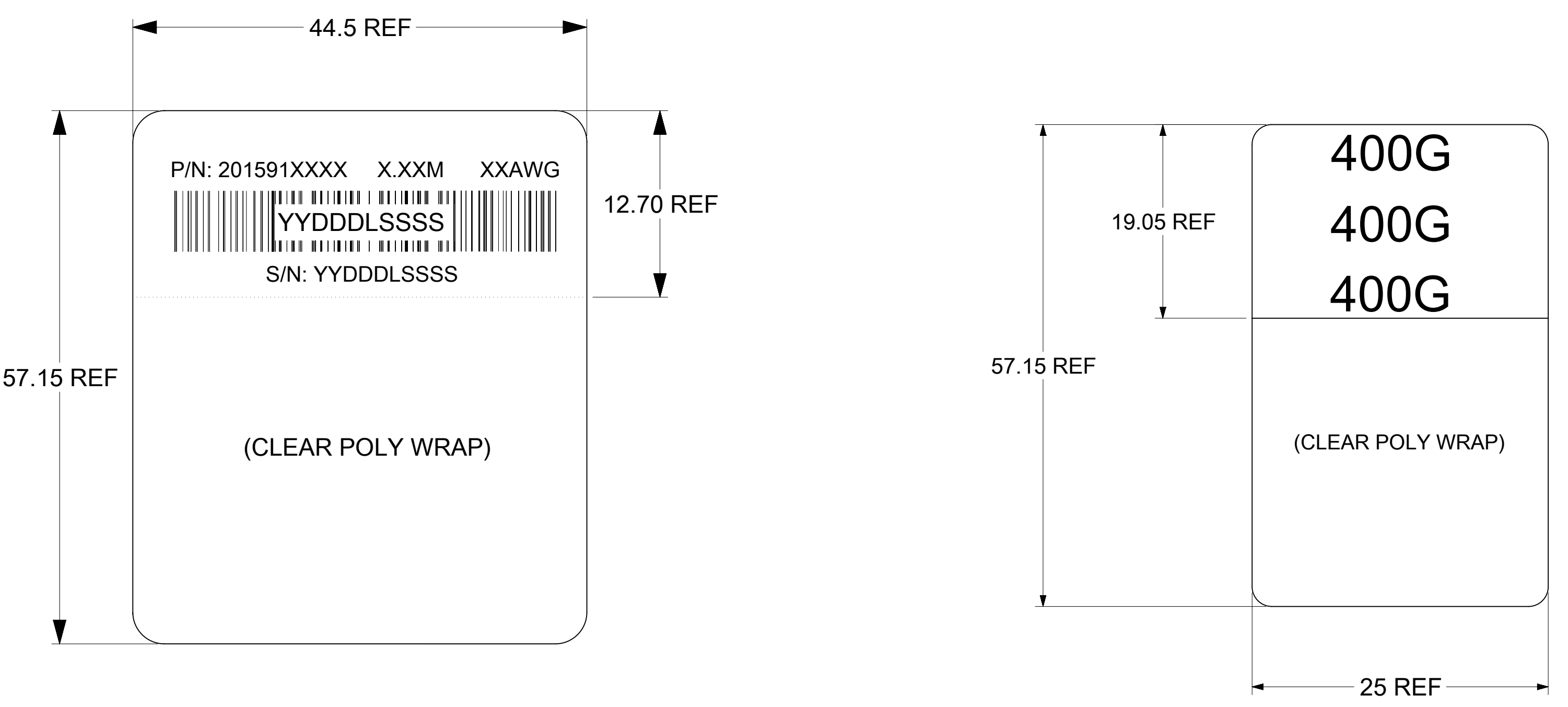

P/N: 201591XXXX - MOLEX PART NUMBER (SEE P/N TABLE)

X.XXM - CABLE LENGTH IN METERS (EXAMPLES - 0.5M, 1.0M, 1.5M)  
SEE P/N TABLE FOR THE NUMBER OF DIGITS

XXAWG - CABLE SIZE IN AWG

S/N: YYDDLSSSS - SERIAL NUMBER  
 YY = YEAR, THE LAST 2 DIGITS OF YEAR  
 DDD = DAY OF THE YEAR  
 L = LOCATION  
 1 - USA  
 2 - MEXICO  
 3 - CHINA  
 4 - PHILIPPINES  
 SSSS = SERIAL NUMBER (0001-9999)

MOLEX P/N	LENGTH (M)	AWG
2015911005*	0.5M +/- 0.05M	30
2015911007	0.75M +/- 0.05M	30
2015911010	1.0M +/- 0.05M	30
2015911012	1.25M +/- 0.05M	30
2015911015	1.5M +/- 0.08M	30
2015911020	2.0M +/- 0.08M	30
2015913005*	0.5M +/- 0.05M	28
2015913010	1.0M +/- 0.05M	28
2015913012	1.25M +/- 0.05M	28
2015913015	1.5M +/- 0.08M	28
2015913017	1.75M +/- 0.08M	28
2015913020	2.0M +/- 0.08M	28
2015913025	2.5M +/- 0.08M	28
2015913252	2.5M +/- 0.08M	26
2015913027	2.75M +/- 0.08M	26
2015913030	3.0M +/- 0.08M	26

\*CABLES MAY NOT MEET ALL IEEE 802.3cd 56G PAM4 PARAMETERS

FUNCTIONAL SYMBOLS $\nabla_A = 0$ $\nabla_C = 0$ $\nabla_P = 0$ DIVISIONAL SYMBOLS	THIS DRAWING CONTAINS INFORMATION THAT IS PROPRIETARY TO MOLEX ELECTRONIC TECHNOLOGIES, LLC AND SHOULD NOT BE USED WITHOUT WRITTEN PERMISSION		CURRENT REV DESC: SHEET4 : ADDED LENGTH 2M 30AWG IN P/N TABLE		
	DIMENSION UNITS	SCALE	GENERAL TOLERANCES (UNLESS SPECIFIED)		
	mm	1:1	ANGULAR TOL $\pm 5.0^\circ$		
	DRAFT WHERE APPLICABLE MUST REMAIN WITHIN DIMENSIONS		THIRD ANGLE PROJECTION		
EC NO: 677116		DRWN: ADITHK 2021/05/24		PRODUCT CUSTOMER DRAWING	
4 PLACES $\pm$		3 PLACES $\pm$		2021/09/09	
3 PLACES $\pm$		2 PLACES $\pm 0.13$		2021/09/10	
2 PLACES $\pm 0.25$		1 PLACE $\pm$		0 PLACES $\pm$	
APPR: MGARRISON		INITIAL REVISION:		DOCUMENT NUMBER	
DRWN: TPRATT 2016/11/08		APPR: CHIRSCHY 2016/11/10		2015911005	
DOWNSHIFT		DRAWING		DOC TYPE	
D-SIZE		SERIES		DOC PART	
SEE P/N TABLE		201591		000	
GENERAL MARKET		MATERIAL NUMBER		REVISION	
4 OF 4		CUSTOMER		U	