

## Dimensions: [mm]

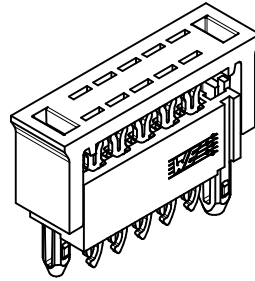

## Recommended PCB Layout [mm]:

Permanent Application:

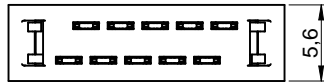
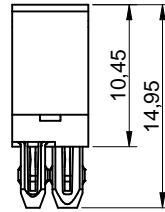
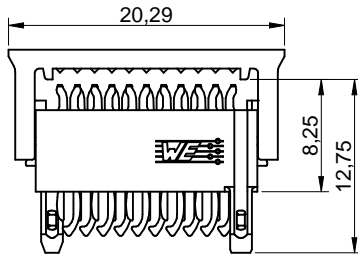
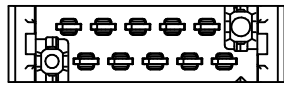
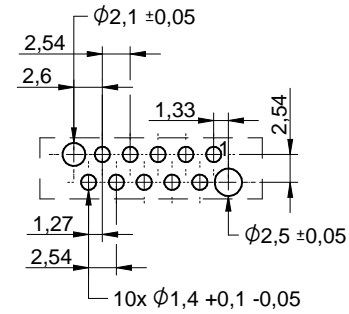

Debugging Application:

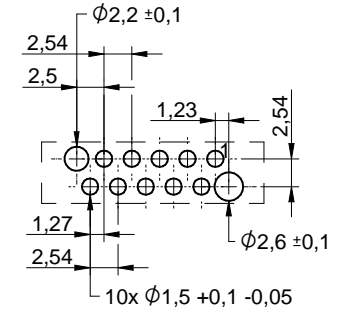

Scale - 1,45:1

## Drillhole specification for PCB:

Permanent Application:

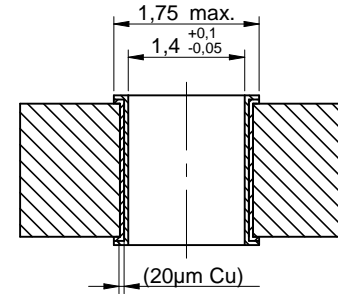

Debugging Application:

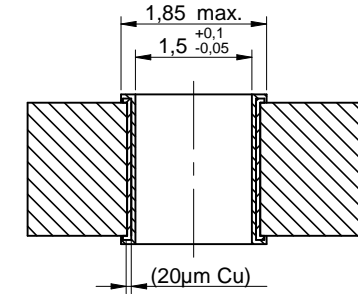

Drill hole specification for chemical surfaces (Ni/Au)

Scale - 1:1

## Article Properties:

Pins	10
------	----



Würth Elektronik eiSos GmbH & Co. KG  
EMC & Inductive Solutions  
Max-Eyth-Str. 1  
74638 Waldenburg  
Germany  
Tel. +49 (0) 79 42 945 - 0  
www.we-online.com  
eiSos@we-online.com

CHECKED MJak	REVISION 002.003	DATE (YYYY-MM-DD) 2021-03-10	GENERAL TOLERANCE DIN ISO 2768-1m	PROJECTION METHOD 
DESCRIPTION <b>WR-WST REDFIT IDC</b>			ORDER CODE <b>490107671012</b>	
SIZE/TYPE SKEDD Connector	BUSINESS UNIT eiCan	STATUS Valid	PAGE 1/6	

## Kind Properties:

Properties		Value	Unit
Pitch	P	2.54	mm
Cable	AWG 28/1.27 mm ribbon cable UL style 2651		
PCB Thickness		1.6	mm

## Material Properties:

Insulator Material	LCP
Insulator Flammability Rating	UL94 V-0
Insulator Color	Black
Contact Material	CuNiSi
Contact Plating	Au (SKEDD), Sn (IDC)

## General Information:

Operating Temperature	-25 up to +105 °C
-----------------------	-------------------

## Electrical Properties:

Properties		Test conditions	Value	Unit	Tol.
Rated Current	I <sub>R</sub>	@ 20 °C	1	A	
Working Voltage <sup>1)</sup>		@ 20 °C	100	V (AC)	
Contact Resistance <sup>2)</sup>	R	@ 20 °C	10	mΩ	max.
Working Voltage <sup>3)</sup>		@ 20 °C	48	V (AC)	
Contact Resistance <sup>4)</sup>	R	@ 20 °C	20	mΩ	max.
Insulation Resistance	R <sub>ISO</sub>	@ 20 °C	1000	MΩ	min.
Withstanding Voltage		1 min. @ 20 °C	500	V (AC)	

<sup>1)</sup> Permanent application

<sup>2)</sup> Permanent application

<sup>3)</sup> Application: debugging, programming

<sup>4)</sup> Application: debugging, programming

## Mechanical Properties:

Properties	Value	Tol.
Micro-cuts during vibration (sinusoidal) <sup>1)</sup>	Discontinuity ≤ 1us Test conditions: 10g, 2h 30min/axis, 10 to 150 Hz, 1 octave/min; peak – peak max. 1,5mm; according to IEC 600068-2-6	
Mating Cycle <sup>2)</sup>	10	min.
Mating Cycle <sup>3)</sup>	50	min.



<sup>1)</sup> Permanent application

<sup>2)</sup> Permanent application

<sup>3)</sup> Application: debugging, programming

## Certification:

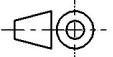
RoHS Approval	Compliant [2011/65/EU&2015/863]
REACH Approval	Conform or declared [(EC)1907/2006]
Halogen Free	Conform [IEC 61249-2-21]
Halogen Free	Conform [JEDEC JS709B]
UL Approval	E323964

	CHECKED MJak	REVISION 002.003	DATE (YYYY-MM-DD) 2021-03-10	GENERAL TOLERANCE DIN ISO 2768-1m	PROJECTION METHOD 
	DESCRIPTION <b>WR-WST REDFIT IDC</b>				ORDER CODE <b>490107671012</b>
	Würth Elektronik eiSos GmbH & Co. KG EMC & Inductive Solutions Max-Eyth-Str. 1 74638 Waldenburg Germany Tel. +49 (0) 79 42 945 - 0 www.we-online.com eiSos@we-online.com			BUSINESS UNIT eiCan	STATUS Valid
	SIZE/TYPE SKEDD Connector			PAGE 2/6	

# Packaging Specification - Tube: [mm]

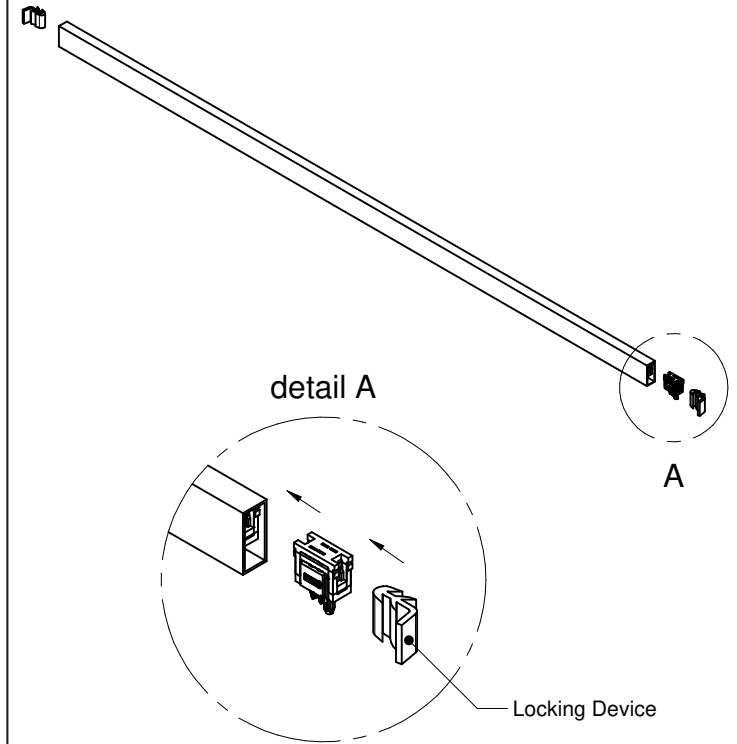
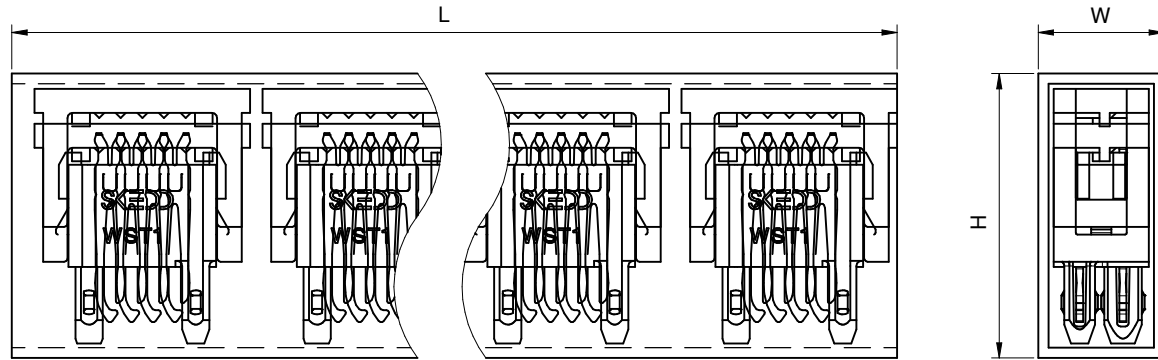

L (mm)	W (mm)	H (mm)	No. of Locking Device (pcs.)	Qty. (pcs.)	Material
typ.	typ.	typ.			
550,00	7,40	16,70	2	25	PVC



Würth Elektronik eiSos GmbH & Co. KG  
 EMC & Inductive Solutions  
 Max-Eyth-Str. 1  
 74638 Waldenburg  
 Germany  
 Tel. +49 (0) 79 42 945 - 0  
 www.we-online.com  
 eiSos@we-online.com

CHECKED	REVISION	DATE (YYYY-MM-DD)	GENERAL TOLERANCE	PROJECTION METHOD
MJak	002.003	2021-03-10	DIN ISO 2768-1m	
DESCRIPTION				ORDER CODE
<b>WR-WST REDFIT IDC</b>				<b>490107671012</b>
SIZE/TYPE	BUSINESS UNIT	STATUS	PAGE	
SKEDD Connector	eiCan	Valid	3/6	

## Packaging Specification - Tube and Carton: [mm]

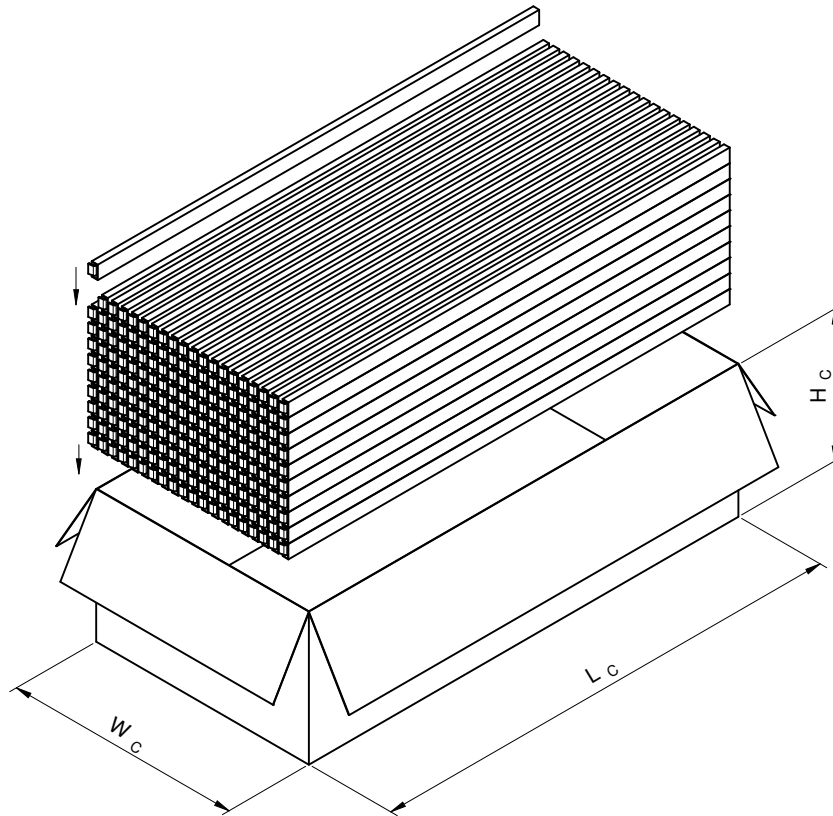

L <sub>c</sub> (mm)	W <sub>c</sub> (mm)	H <sub>c</sub> (mm)	No. of Tube (pcs.)	Qty. (pcs.)	Material
typ.	typ.	typ.			
580,00	235,00	165,00	200	5000	Paper

	CHECKED MJak	REVISION 002.003	DATE (YYYY-MM-DD) 2021-03-10	GENERAL TOLERANCE DIN ISO 2768-1m	PROJECTION METHOD 
	DESCRIPTION <b>WR-WST REDFIT IDC</b>				ORDER CODE <b>490107671012</b>
	SIZE/TYPE SKEDD Connector	BUSINESS UNIT eiCan	STATUS Valid	PAGE 4/6	



Würth Elektronik eiSos GmbH & Co. KG  
 EMC & Inductive Solutions  
 Max-Eyth-Str. 1  
 74638 Waldenburg  
 Germany  
 Tel. +49 (0) 79 42 945 - 0  
 www.we-online.com  
 eiSos@we-online.com

## Cautions and warnings for REDFIT IDC SKEDD Connectors:

The following conditions apply to all REDFIT IDC SKEDD Connectors (hereinafter referred as to “electronic component”, “component” or “connector”) of Würth Elektronik eiSos GmbH & Co. KG.

### General:

- This electronic component is designed and manufactured for use in general electronic equipment.
- Würth Elektronik must be asked for written approval (following the PPAP procedure) before incorporating the components into any equipment in fields such as military, aerospace, aviation, nuclear control, submarine, transportation (automotive control, train control, ship control), transportation signal, disaster prevention, medical, public information network, etc. where higher safety and reliability are especially required and/or if there is the possibility of direct damage or human injury.
- Mechanical components that will be used in safety-critical or high-reliability applications, should be pre-evaluated by the customer.
- The component is designed and manufactured to be used within the datasheet specified values. If the usage and operation conditions specified in the datasheet are not met, the component may be damaged or dissolved.
- Do not drop or impact the components, the component may be damaged.
- Prevent any damage or scratches on the connector, especially on the actuator.
- Direct mechanical impact to the product shall be prevented (e.g overlapping of the PCB's).
- Würth Elektronik products are qualified according to international standards, which are listed in each product reliability report. Würth Elektronik does not warrant any customer qualified product characteristics beyond Würth Elektronik's specifications, for its validity and sustainability over time.
- The responsibility for the applicability of the customer specific products and use in a particular customer design is always within the authority of the customer. All technical specifications for standard products do also apply to customer specific products.
- REFFIT IDC SKEDD Connectors are designed to be used along with Würth Elektronik counterparts and tools. Würth Elektronik cannot ensure the reliability of these components while being used with other products.

### Cleaning and Washing:

- Washing agents used during the production to clean the customer application might damage or change the characteristics of the component. Washing agents may have a negative effect on the long-term functionality of the product.
- Using a brush during the cleaning process may damage the component. Therefore, we do not recommend using a brush during the PCB cleaning process.

### Storage Conditions:

- A storage of Würth Elektronik products for longer than 12 months is not recommended. Therefore, all products shall be used within the period of 12 months based on the day of shipment.
- Do not expose the components to direct sunlight.

- The storage conditions in the original packaging are defined according to DIN EN 61760-2.
- The storage conditions stated in the original packaging apply to the storage time and not to the transportation time of the components.



### Packaging:

- The packaging specifications apply only to purchase orders comprising whole packaging units. If the ordered quantity exceeds or is lower than the specified packaging unit, packaging in accordance with the packaging specifications cannot be ensured.

### Handling and Processing:

- Do not repeatedly operate the connector with excessive force. It may damage or deform the contact dome which results in malfunction.
- In case a connector requires particular handling precautions, in addition to the general recommendations mentioned here before, these will appear on the product datasheet.
- The connector is designed for the specified mating cycles. All mating cycles above the specified mating cycles are at the customer's own risk.
- It is necessary that the connector is plugged and unplugged at a 90° angle to the PCB, otherwise, the mating cycles may be reduced and/or the connector may be damaged.
- Do not solder this connector! The soldering process damages the SKEDD functionality.
- The component is only designed for direct plug-in into the PCB.
- Firstly, the cable should be pressed to the IDC side. After that, it can be plugged into the PCB.
- It must be ensured that the connector is fully plugged into the PCB, otherwise, the retention force might be reduced and the signal/power connection might be interrupted or lost.
- We recommend using the Würth Elektronik Tool 600600282800 with the insert 4900002 to press the connector, or the hand plier IDC press tool 4900005.
- It is recommended to secure the Flat Ribbon Cable on the PCB or externally.
- We recommend to lead the cable straight ahead from the connector. If bending is necessary, make sure to bend the cable at least 20 mm away from the edge of the connector. Do not bend directly at the connector's edge. Before and after bending, make sure that the connector is fixed in its place without pressure on it.
- The contacts have a play in the housing, this is necessary for the functionality of the SKEDD contacts.
- The temperature rise of the component must be taken into consideration. The operating temperature is comprised of ambient temperature and temperature rise of the component. The operating temperature of the component shall not exceed the maximum temperature specified.

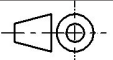
These cautions and warnings comply with the state of the scientific and technical knowledge and are believed to be accurate and reliable. However, no responsibility is assumed for inaccuracies or incompleteness.

	CHECKED	REVISION	DATE (YYYY-MM-DD)	GENERAL TOLERANCE	PROJECTION METHOD	
	MJak	002.003	2021-03-10	DIN ISO 2768-1m		
	DESCRIPTION				ORDER CODE	
	WR-WST REDFIT IDC				490107671012	
Würth Elektronik eiSos GmbH & Co. KG EMC & Inductive Solutions Max-Eyth-Str. 1 74638 Waldenburg Germany Tel. +49 (0) 79 42 945 - 0 www.we-online.com eiSos@we-online.com			SIZE/TYPE	BUSINESS UNIT	STATUS	PAGE
			SKEDD Connector	eiCan	Valid	5/6

## Important Notes

### The following conditions apply to all goods within the product range of Würth Elektronik eiSos GmbH & Co. KG:

#### 1. General Customer Responsibility

Some goods within the product range of Würth Elektronik eiSos GmbH & Co. KG contain statements regarding general suitability for certain application areas. These statements about suitability are based on our knowledge and experience of typical requirements concerning the areas, serve as general guidance and cannot be estimated as binding statements about the suitability for a customer application. The responsibility for the applicability and use in a particular customer design is always solely within the authority of the customer. Due to this fact it is up to the customer to evaluate, where appropriate to investigate and decide whether the device with the specific product characteristics described in the product specification is valid and suitable for the respective customer application or not.

#### 2. Customer Responsibility related to Specific, in particular Safety-Relevant Applications

It has to be clearly pointed out that the possibility of a malfunction of electronic components or failure before the end of the usual lifetime cannot be completely eliminated in the current state of the art, even if the products are operated within the range of the specifications. In certain customer applications requiring a very high level of safety and especially in customer applications in which the malfunction or failure of an electronic component could endanger human life or health it must be ensured by most advanced technological aid of suitable design of the customer application that no injury or damage is caused to third parties in the event of malfunction or failure of an electronic component. Therefore, customer is cautioned to verify that data sheets are current before placing orders. The current data sheets can be downloaded at [www.we-online.com](http://www.we-online.com).

#### 3. Best Care and Attention

Any product-specific notes, cautions and warnings must be strictly observed. Any disregard will result in the loss of warranty.

#### 4. Customer Support for Product Specifications

Some products within the product range may contain substances which are subject to restrictions in certain jurisdictions in order to serve specific technical requirements. Necessary information is available on request. In this case the field sales engineer or the internal sales person in charge should be contacted who will be happy to support in this matter.

#### 5. Product R&D

Due to constant product improvement product specifications may change from time to time. As a standard reporting procedure of the Product Change Notification (PCN) according to the JEDEC-Standard inform about minor and major changes. In case of further queries regarding the PCN, the field sales engineer or the internal sales person in charge should be contacted. The basic responsibility of the customer as per Section 1 and 2 remains unaffected.

#### 6. Product Life Cycle



Due to technical progress and economical evaluation we also reserve the right to discontinue production and delivery of products. As a standard reporting procedure of the Product Termination Notification (PTN) according to the JEDEC-Standard we will inform at an early stage about inevitable product discontinuance. According to this we cannot guarantee that all products within our product range will always be available. Therefore it needs to be verified with the field sales engineer or the internal sales person in charge about the current product availability expectancy before or when the product for application design-in disposal is considered. The approach named above does not apply in the case of individual agreements deviating from the foregoing for customer-specific products.

#### 7. Property Rights

All the rights for contractual products produced by Würth Elektronik eiSos GmbH & Co. KG on the basis of ideas, development contracts as well as models or templates that are subject to copyright, patent or commercial protection supplied to the customer will remain with Würth Elektronik eiSos GmbH & Co. KG. Würth Elektronik eiSos GmbH & Co. KG does not warrant or represent that any license, either expressed or implied, is granted under any patent right, copyright, mask work right, or other intellectual property right relating to any combination, application, or process in which Würth Elektronik eiSos GmbH & Co. KG components or services are used.

#### 8. General Terms and Conditions

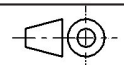
Unless otherwise agreed in individual contracts, all orders are subject to the current version of the "General Terms and Conditions of Würth Elektronik eiSos Group", last version available at [www.we-online.com](http://www.we-online.com).

	CHECKED MJak	REVISION 002.003	DATE (YYYY-MM-DD) 2021-03-10	GENERAL TOLERANCE DIN ISO 2768-1m	PROJECTION METHOD 
	DESCRIPTION <b>WR-WST REDFIT IDC</b>				ORDER CODE <b>490107671012</b>
	SIZE/TYPE SKEDD Connector	BUSINESS UNIT eiCan	STATUS Valid	PAGE 6/6	
		Würth Elektronik eiSos GmbH & Co. KG EMC & Inductive Solutions Max-Eyth-Str. 1 74638 Waldenburg Germany Tel. +49 (0) 79 42 945 - 0 <a href="http://www.we-online.com">www.we-online.com</a> <a href="mailto:eiSos@we-online.com">eiSos@we-online.com</a>			