

CGA4J4C0G2W272J125AA

TDK Item Description : CGA4J4C0G2W272JT****



Equivalent C2012C0G2W272J for Automotive

Application & Main Feature

Automotive Grade (Mid Voltage (100 to 630V))

Series

CGA4(2012) [EIA 0805]

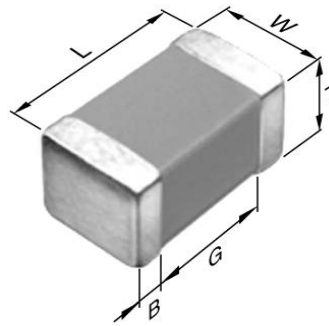

Dimensions

L	2.00mm ±0.20mm
W	1.25mm ±0.20mm
T	1.25mm ±0.20mm
B	0.20mm Min.
G	0.50mm Min.

Temperature Characteristic

C0G (-55 to 125 degC 0+/-30ppm/degC)

Rated Voltage

2W(450Vdc)

Capacitance

2.7nF

Capacitance Tolerance

J (±5%)

Q Factor

1000 Min.

Insulation Resistance

10Gohm Min

AEC-Q200

Yes

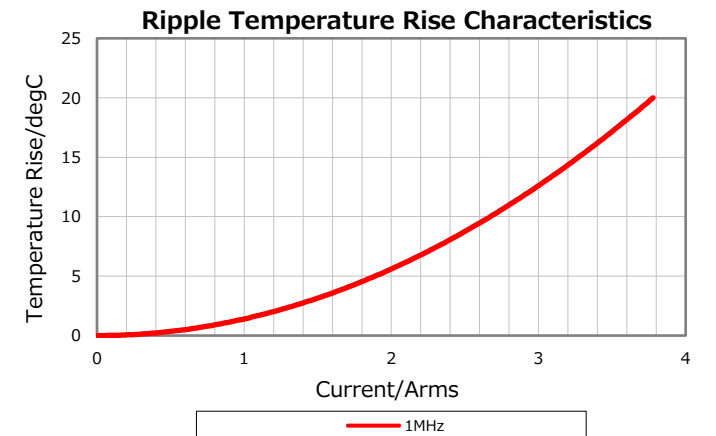
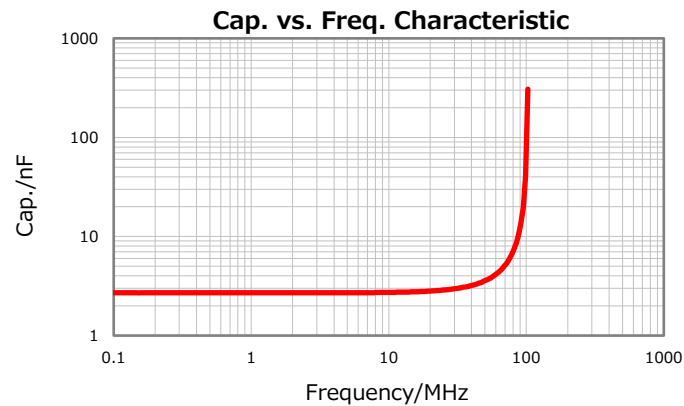
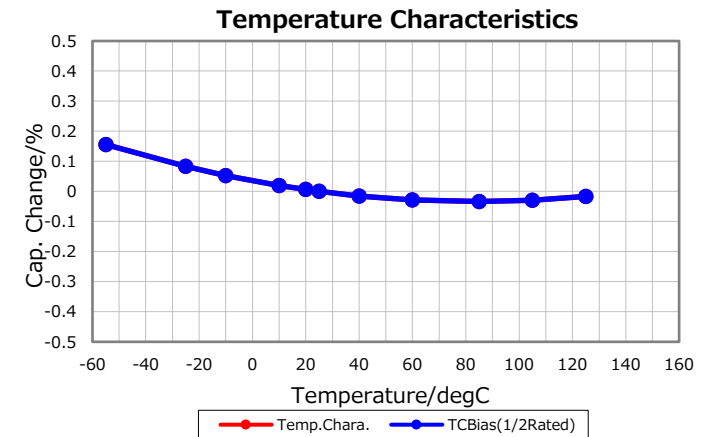
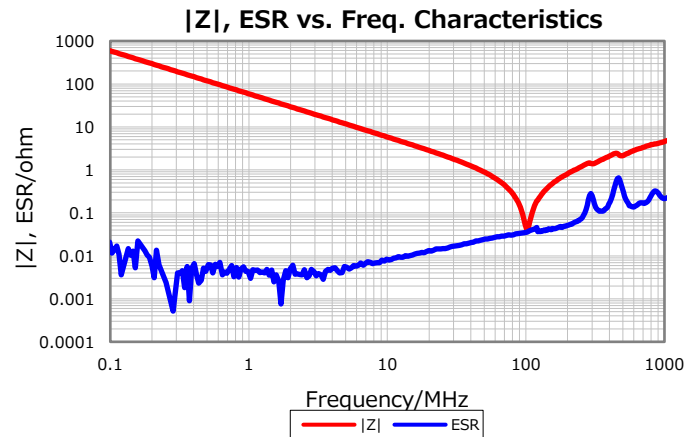
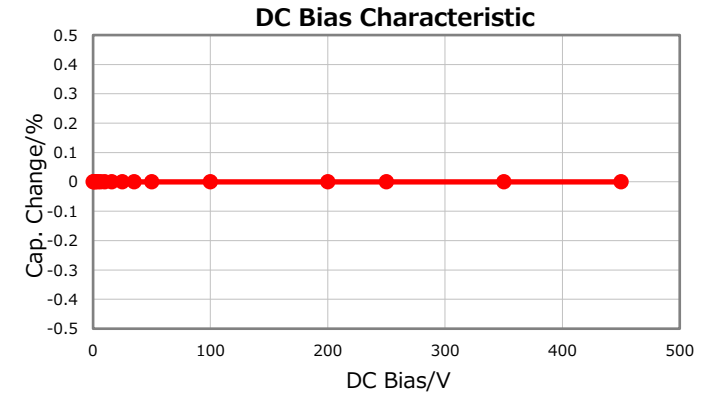

Characterization Sheet (Multilayer Ceramic Chip Capacitors)



All specifications are subject to change without notice.

July 2, 2019