

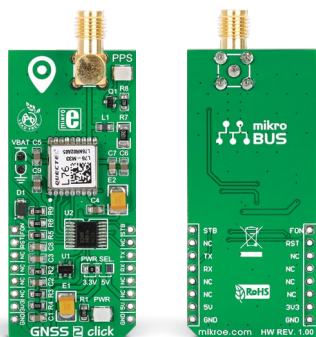

## GNSS2 click™



### 1. Introduction

GNSS2 click™ carries Quectel's L76 module and an SMA antenna connector. L76 can acquire both GPS and GLONASS signals. The larger number of visible satellites increases positioning accuracy (<2.5m CEP) and decreases acquisition time (<5s TTFF with warm start). GNSS2 click™ communicates with the target board MCU through UART (RX, TX) pins; as well as Force on (AN), RST (RST), Standby (PWM). The board can use either 3.3 or 5V power supply and logic levels.

### 2. Soldering the headers

Before using your click™ board, make sure to solder 1x8 male headers to both left and right side of the board. Two 1x8 male headers are included with the board in the package.

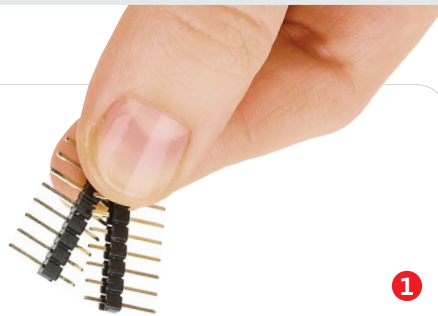

1

2

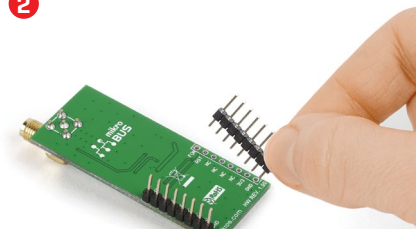

Turn the board upside down so that the bottom side is facing you upwards. Place shorter pins of the header into the appropriate soldering pads.

3

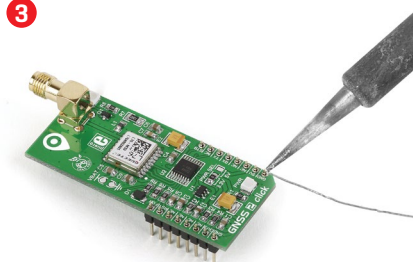

Turn the board upward again. Make sure to align the headers so that they are perpendicular to the board, then solder the pins carefully.

### 3. Plugging the board in

Once you have soldered the headers your board is ready to be placed into the desired mikroBUS™ socket. Make sure to align the cut in the lower-right part of the board with the markings on the silkscreen at the mikroBUS™ socket. If all the pins are aligned correctly, push the board all the way into the socket.

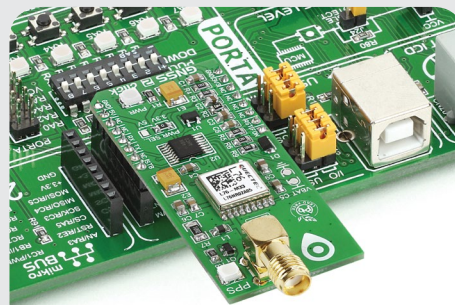
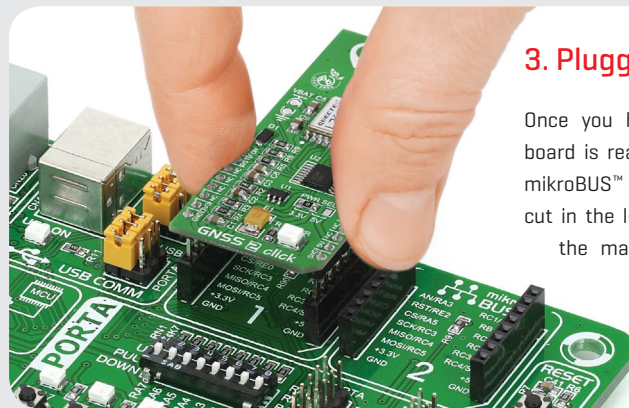

### 4. Essential features

The L76 module on GNSS2 click™ integrates performance-enhancing Quectel technologies. It can automatically predict satellite orbits from data stored in its internal flash (EASY™ technology) and it can adaptively adjust its on/off time to balance between positioning accuracy and power consumption (AlwaysLocate™ technology). GNSS2 click™ also features a VBAT connector for connecting an external power supply which can supply power to the module's SRAM memory (storing GPS information necessary for quick start-up).

click™  
BOARD  
www.mikroe.com



GNSS2 click™ manual  
ver 1.00



0100000078341

## 5. Schematic

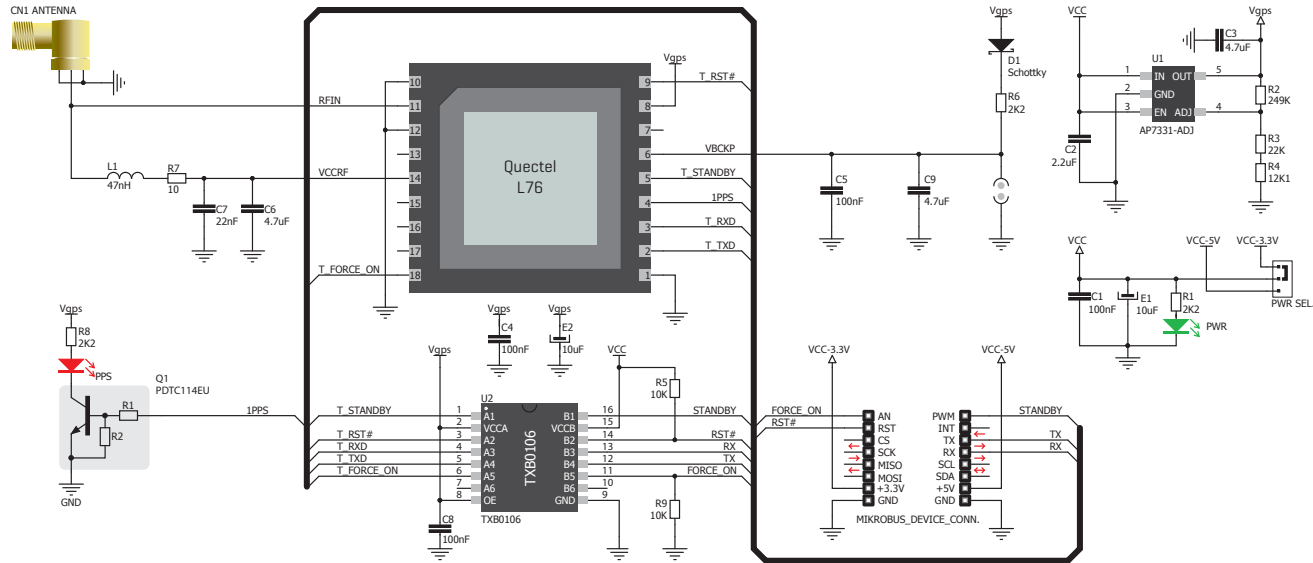

## 6. Dimensions

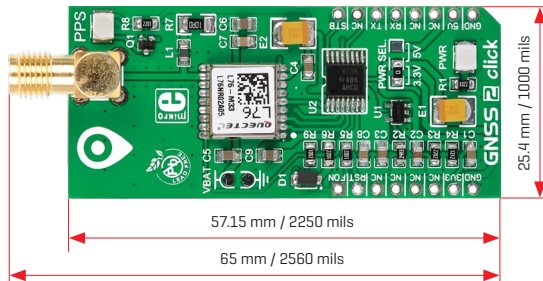

	mm	mils
PCB LENGTH	57.15	2250
FULL LENGTH	65	2560
WIDTH	25.4	1000
HEIGHT*	8	315

\* without headers

## 7. SMD jumper

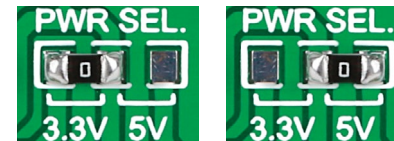

GNSS2 click™ features a PWR SEL jumper [zero ohm resistor], that switches both the power supply and logic level between 3.3V and 5V.

## 8. Code examples

Once you have done all the necessary preparations, it's time to get your click™ board up and running. We have provided examples for mikroC™, mikroBasic™ and mikroPascal™ compilers on our **Libstock** website. Just download them and you are ready to start.



## 9. Support

MikroElektronika offers **free tech support** [[www.mikroe.com/support](http://www.mikroe.com/support)] until the end of the product's lifetime, so if something goes wrong, we're ready and willing to help!



## 10. Disclaimer

MikroElektronika assumes no responsibility or liability for any errors or inaccuracies that may appear in the present document. Specification and information contained in the present schematic are subject to change at any time without notice.

Copyright © 2015 MikroElektronika.  
All rights reserved.