

Description: 0.283" Right Angle / Machined

Dimensions (inch/mm)						
Pins	A	B	C	D	E	F
9	1.213	0.984	0.665	0.327	0.240	0.492
	30.80	25.00	16.90	8.30	6.10	12.50
15	1.543	1.311	0.994	0.327	0.240	0.492
	39.20	33.30	25.25	8.30	6.10	12.50
25	2.089	1.852	1.533	0.327	0.240	0.492
	53.05	47.05	38.95	8.30	6.10	12.50

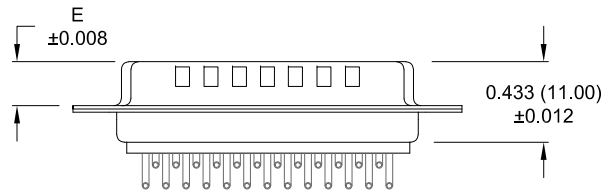
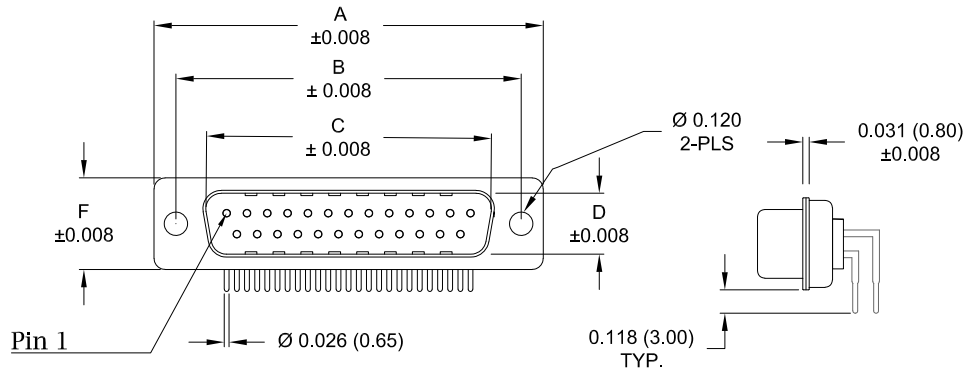

Meets IP67 Standards

(See page 3 for sealing details)

**Material:**

- Shell: Nickel Plated Steel
- Insulator: UL 94V-O Rated, White PA6T
- Process Temperature: 260°C
- Contact: Precision Machined Copper Alloy
- Seal: Flexible F08 Adhesive

**Electrical:**

- Current Rating: 5 AMPS
- Contact Resistance: 10 mOhms Max.
- Insulation Resistance: 5 GOhms Min.
- Working Voltage: 250V
- Temperature: -55° C TO +125° C

773-EYY-11YRYY1

**Series**

**Position**

- E09
- E15
- E25

**Gender**

- 1 = Male

**Termination**

- 1 = PCB Mounting

**Shell Plating**

- 3 = Nickel

**RoHS Compliant**

**Hardware Options**

- 00 = No Hardware
- 01 = 0.065" Clinch Nut (Board Side)
- 0A = 0.098" Clinch Nut (Board Side)
- 14 = Standard Bracket with 4-40 Screwlock
- 46 = Boardlock Bracket with 4-40 Insert

**Plating Options**

- 1 = Gold Flash
- 2 = 30µ" Gold

RoHS COMPLIANT

UNITS = inch [mm]

DO NOT SCALE FROM DRAWING



THESE DRAWINGS AND SPECIFICATIONS ARE THE PROPERTY OF NorComp AND SHALL NOT BE REPRODUCED, COPIED OR USED AS THE BASIS FOR THE MANUFACTURE OR SALE OF APPARATUS WITHOUT WRITTEN PERMISSION.

DRAWN:

Pam Jenkins

DATE:

06/29/2009

NorComp

SCALE:

NTS

SHEET

1

OF

4

REV

15

DWG NO.

773-EYY-11YRYY1

9 POSITION

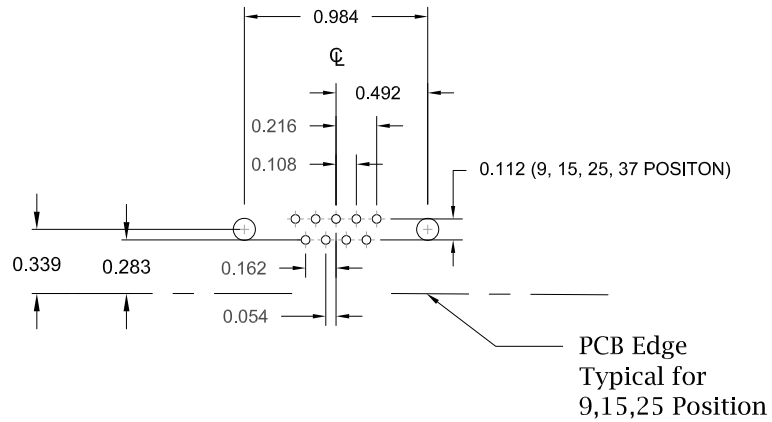

15 POSITION

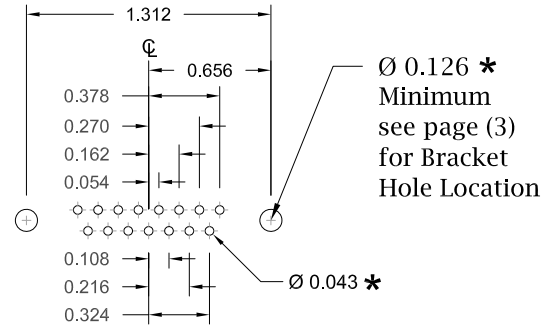

25 POSITION

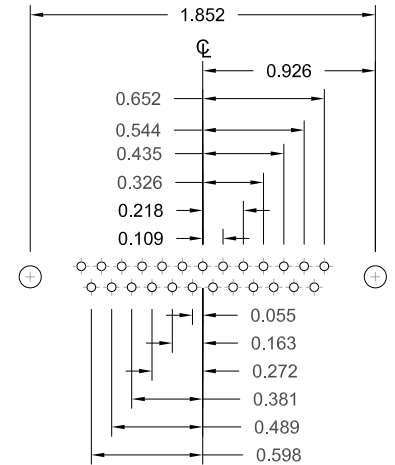

UNITS = inch

\* Typical Suggested Size  
May Not Be Suitable For All Applications

RoHS COMPLIANT

DO NOT SCALE FROM DRAWING



THESE DRAWINGS AND SPECIFICATIONS ARE THE PROPERTY OF NorComp AND SHALL NOT BE REPRODUCED, COPIED OR USED AS THE BASIS FOR THE MANUFACTURE OR SALE OF APPARATUS WITHOUT WRITTEN PERMISSION.

DRAWN:  
Pam Jenkins  
DATE:  
06/29/2009

NorComp

SCALE: NTS	SHEET 2	OF 4	REV 15
DWG NO.		773-EYY-11YRY1	

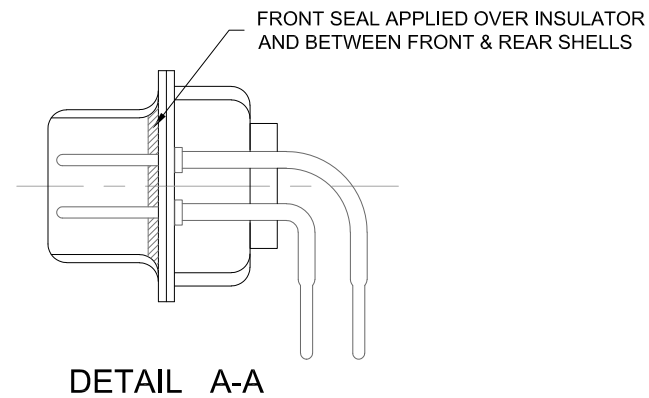
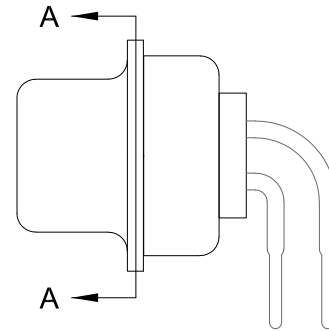

RoHS COMPLIANT

DO NOT SCALE FROM DRAWING



THESE DRAWINGS AND SPECIFICATIONS ARE THE PROPERTY OF NorComp AND SHALL NOT BE REPRODUCED, COPIED OR USED AS THE BASIS FOR THE MANUFACTURE OR SALE OF APPARATUS WITHOUT WRITTEN PERMISSION.

DRAWN:  
Pam Jenkins  
DATE:  
06/29/2009

NorComp

SCALE: NTS	SHEET OF 3 4	REV 15
DWG NO. 773-EYY-11YRYY1		

**01 Hardware Option**  
0.065" Clinch Nut (Board Side)

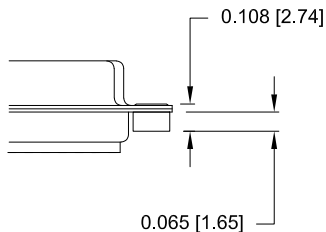

Clinch Nut has 4-40 Internal Threads

**0A Hardware Option**  
0.098" Clinch Nut (Board Side)

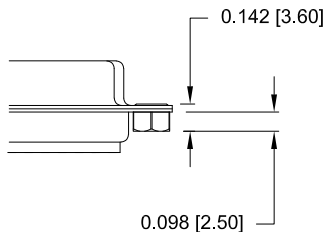

Clinch Nut has 4-40 Internal Threads

14 Hardware Option		
	Description	NorComp Part Number
1	4-40 Screwlock	SFSO4401NR
2	Bracket	K501CZ
3	Lock Washer	LW1T
4	4-40 Nut	N4401N

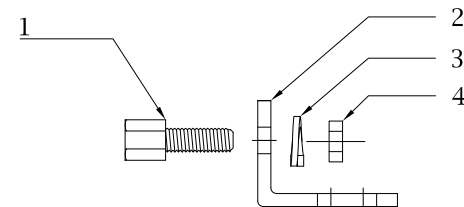

\*\*Search Hardware Part Number To Obtain Technical Specifications.

**46 Hardware Option**  
Boardlock Bracket and 4-40 Insert

#4-40 Threaded Insert

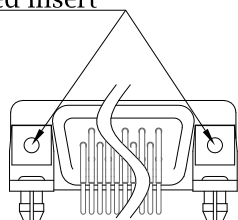

9-25 Position Connector Boardlock Bracket

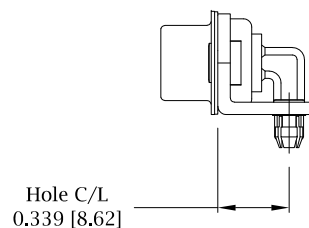

Boardlock Brackets Come Assembled On Connector

RoHS COMPLIANT

UNITS = inch [mm]

DO NOT SCALE FROM DRAWING



THESE DRAWINGS AND SPECIFICATIONS ARE THE PROPERTY OF NorComp AND SHALL NOT BE REPRODUCED, COPIED OR USED AS THE BASIS FOR THE MANUFACTURE OR SALE OF APPARATUS WITHOUT WRITTEN PERMISSION.

DRAWN:  
**Pam Jenkins**  
DATE:  
06/29/2009

**NorComp**

SCALE:  
NTS  
DWG NO.

SHEET OF  
4 4

REV  
15

773-EYY-11YRY1