

# RECOMMENDED PCB LAYOUT AND KEEP-OUT ZONE

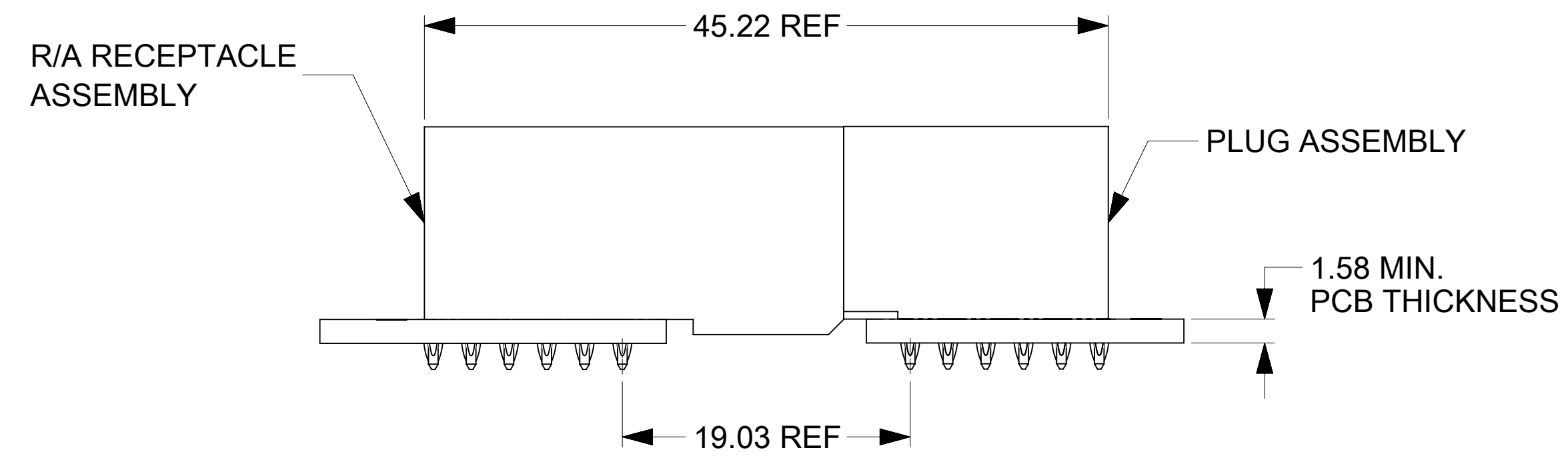

## PLUG MATED TO R/A RECEPTACLE MATED PROFILE

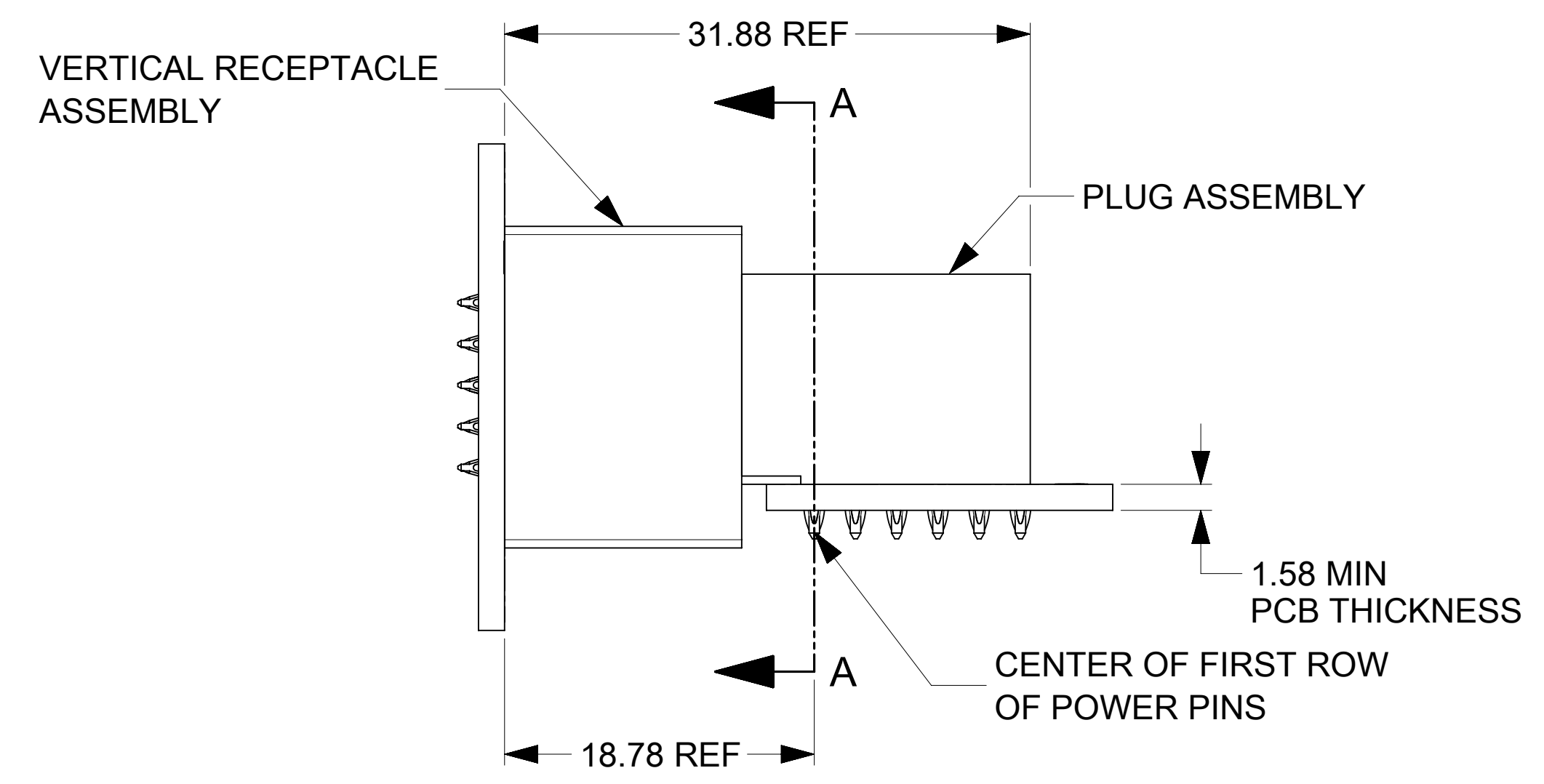

## PLUG MATED TO VERTICAL RECEPTACLE MATED PROFILE

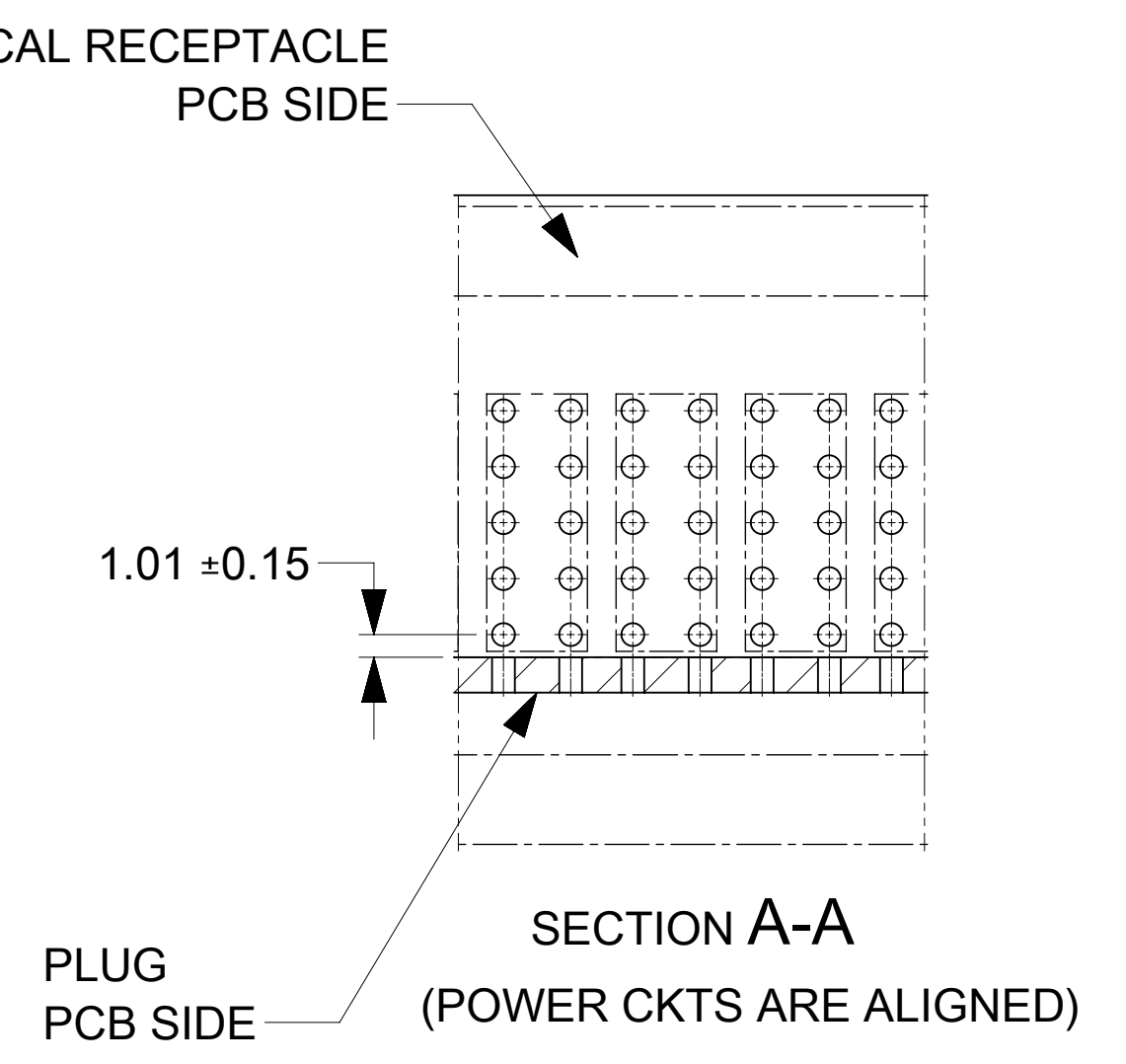
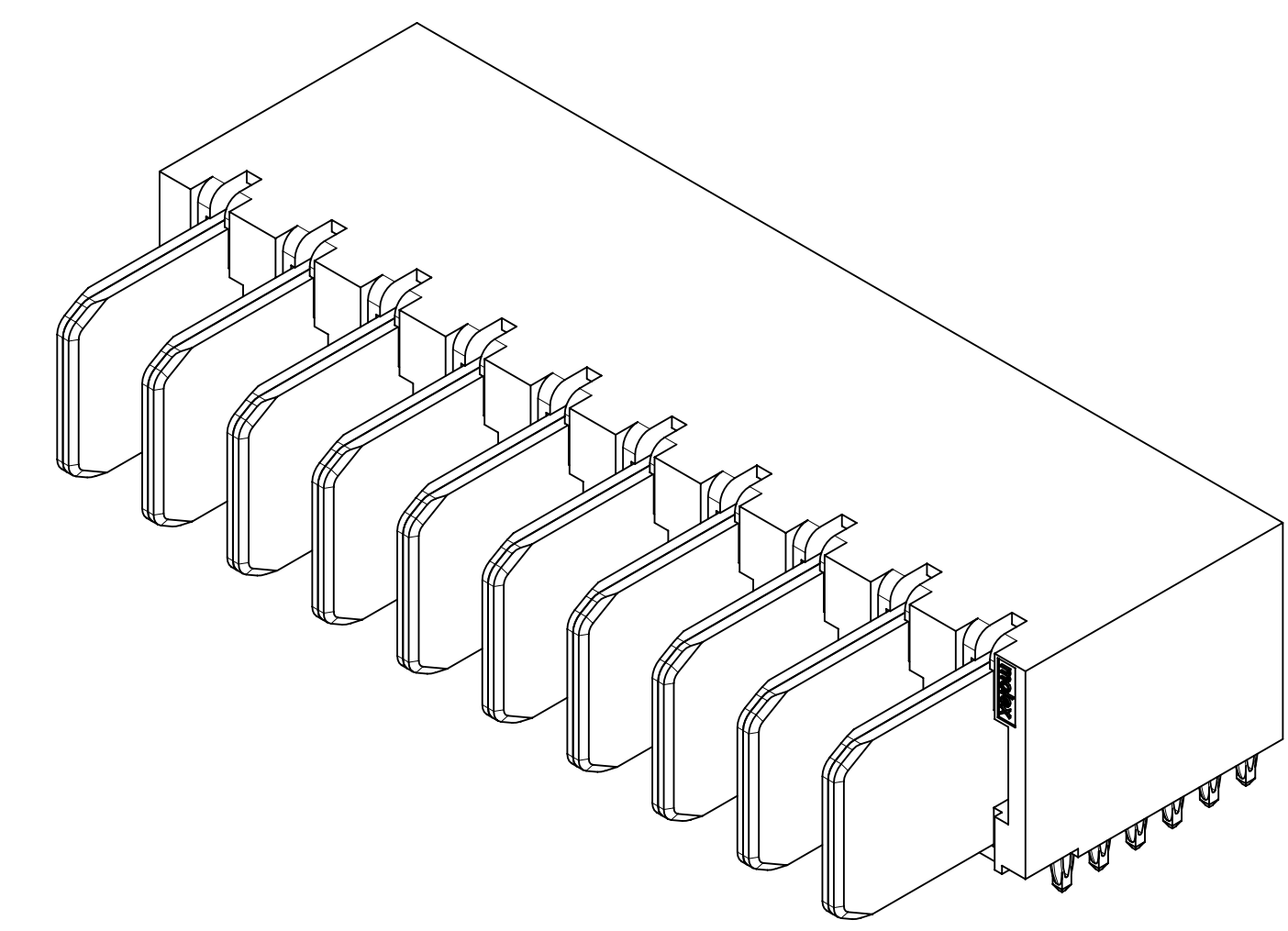

### NOTES:

- MATERIAL:
  - HOUSINGS: LCP UL94, V-0, COLOR : BLACK
  - TERMINALS: HIGH CONDUCTIVITY COPPER ALLOY
  - PLATING: 1.27  $\mu\text{m}$  (50  $\mu\text{in}$ ) NICKEL OVERALL WITH 2.54  $\mu\text{m}$  (100  $\mu\text{in}$ ) SELECTIVE TIN ON TAILS AND 0.762  $\mu\text{m}$  (30  $\mu\text{in}$ ) SELECTIVE GOLD ON CONTACT AREA
- PACKAGING: ASSEMBLIES TO BE TRAY PACKED PER PACKAGING SPEC: 2141130010-PK.
- PLATED THRU HOLE SIZE, REFER TO PRODUCT SPEC. FOR DETAILS.
- PRODUCT SPEC: 2141130000-PS.
- PRODUCT TO MEET RoHS REQUIREMENTS.
- PLUG ASSEMBLY MATES TO MOLEX RECEPTACLES 219563XXXX-SD AND 219564XXXX-SD, SEE DRAWINGS FOR DETAILS.
- TAIL DESIGN: COMPLIANT PIN.
- POWER TERMINALS ARE LUBRICATED.
- APPLICATION SPECIFICATION: 2141130000-AS (FOR COMPLIANT TAILS ONLY).

THIS DRAWING CONTAINS INFORMATION THAT IS PROPRIETARY TO MOLEX ELECTRONIC TECHNOLOGIES, LLC AND SHOULD NOT BE USED WITHOUT WRITTEN PERMISSION										
DIMENSION UNITS	SCALE	CURRENT REV DESC:								
mm	3:1									
GENERAL TOLERANCES (UNLESS SPECIFIED)										
ANGULAR TOL	± °									
4 PLACES	±									
3 PLACES	±									
2 PLACES	± 0.25									
1 PLACE	± 0.3									
0 PLACES	±									
DRAFT WHERE APPLICABLE MUST REMAIN WITHIN DIMENSIONS		THIRD ANGLE PROJECTION	DRAWING	SERIES	MATERIAL NUMBER	CUSTOMER	SHEET NUMBER			
			D-SIZE	219562	SEE CHART		1 OF 2			
		EC NO: 745288		2023/03/21		<div style="text-align: center;"><b>molex</b></div> GUARDIAN HD RA PLUG POWER ONLY UNGUIDED PF PRODUCT CUSTOMER DRAWING				
		DRWN: LZABJANOVSKI		2023/04/10						
		CHK'D: JAYK1		2023/04/10						
		APPR: JAYK1		2023/04/10		DOCUMENT NUMBER		DOC TYPE	DOC PART	REVISION
		INITIAL REVISION:		2022/03/29		2195629003-SD		PSD	000	A1
		DRWN: LZABJANOVSKI		2022/08/04						
		APPR: BPISZCZOR								

PART NUMBER	CONFIGURATION	QUANTITY PER CARTON (DU)
219562-0031	1P	656

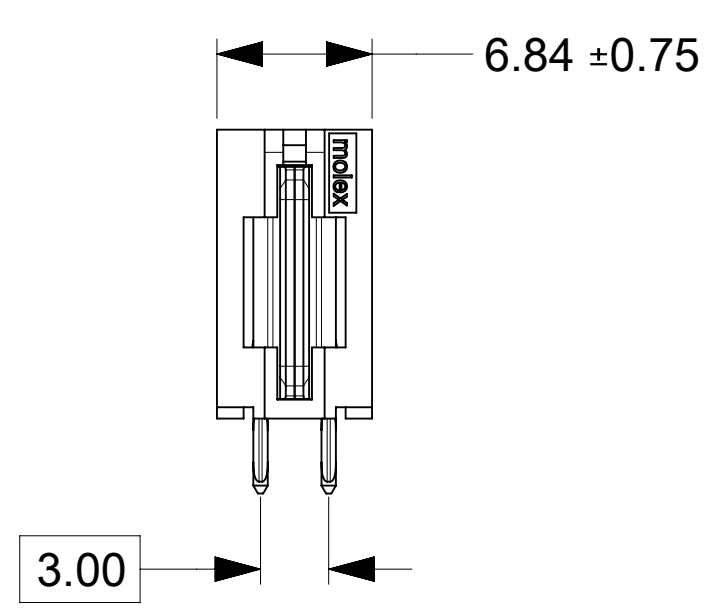

PART NUMBER	CONFIGURATION	QUANTITY PER CARTON (DU)
219562-0032	2P	352

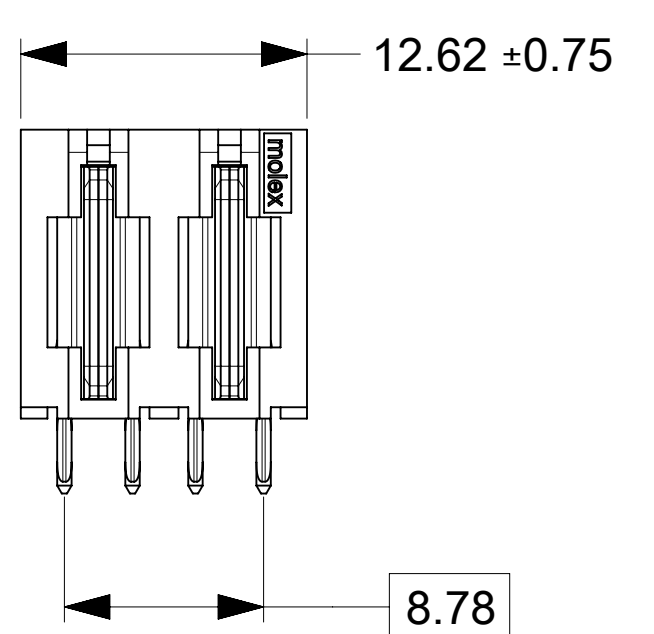

PART NUMBER	CONFIGURATION	QUANTITY PER CARTON (DU)
219562-0033	3P	240

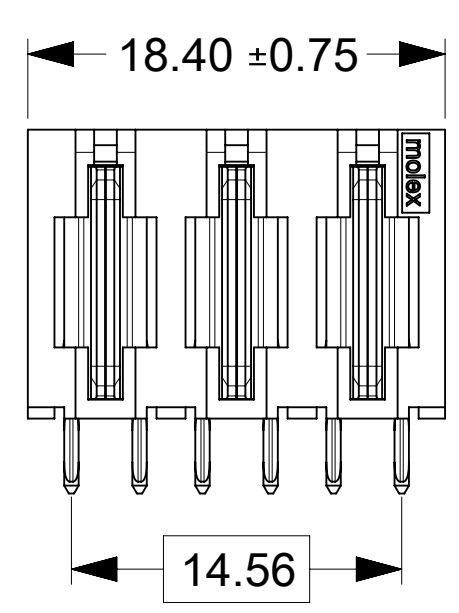

PART NUMBER	CONFIGURATION	QUANTITY PER CARTON (DU)
219562-0034	4P	176

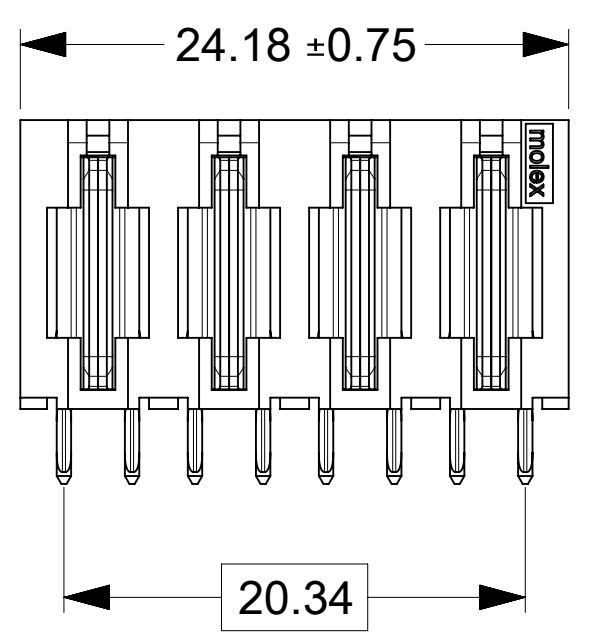

PART NUMBER	CONFIGURATION	QUANTITY PER CARTON (DU)
219562-0035	5P	144

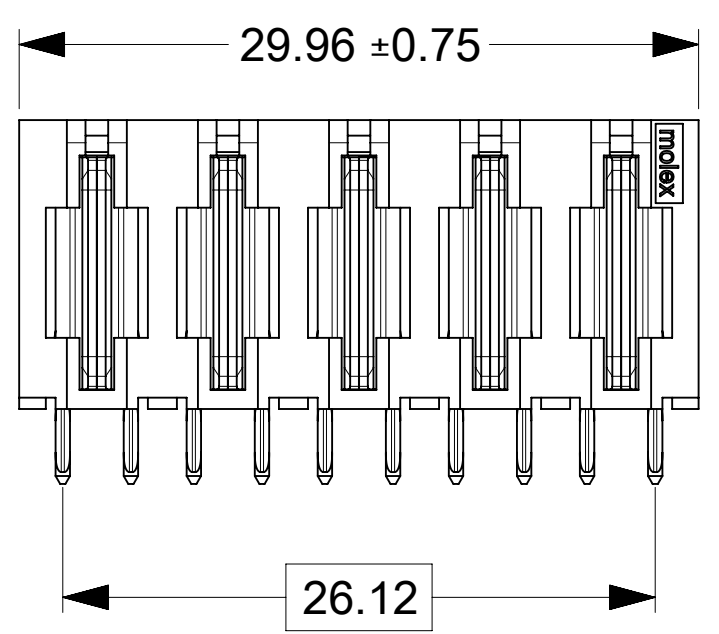

PART NUMBER	CONFIGURATION	QUANTITY PER CARTON (DU)
219562-0036	6P	112

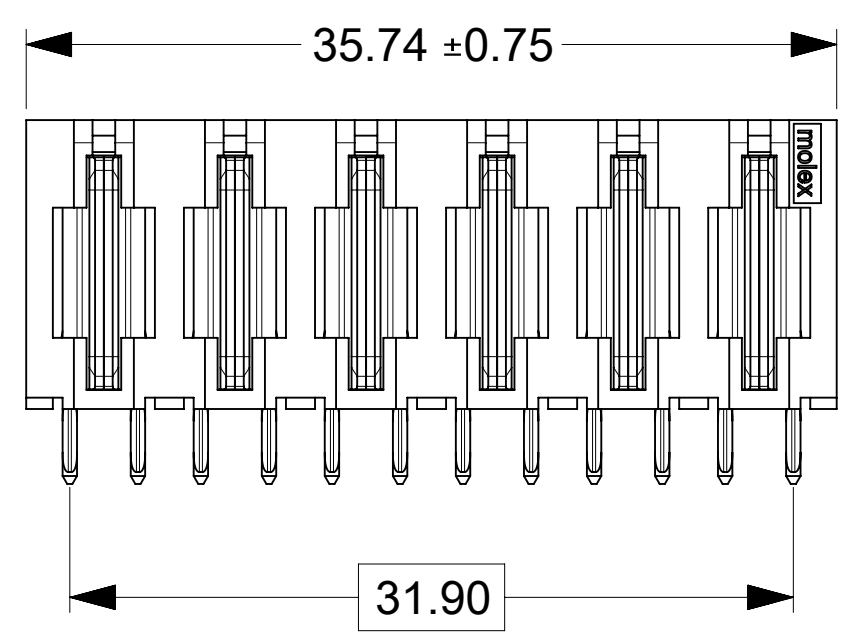

PART NUMBER	CONFIGURATION	QUANTITY PER CARTON (DU)
219562-0037	7P	96

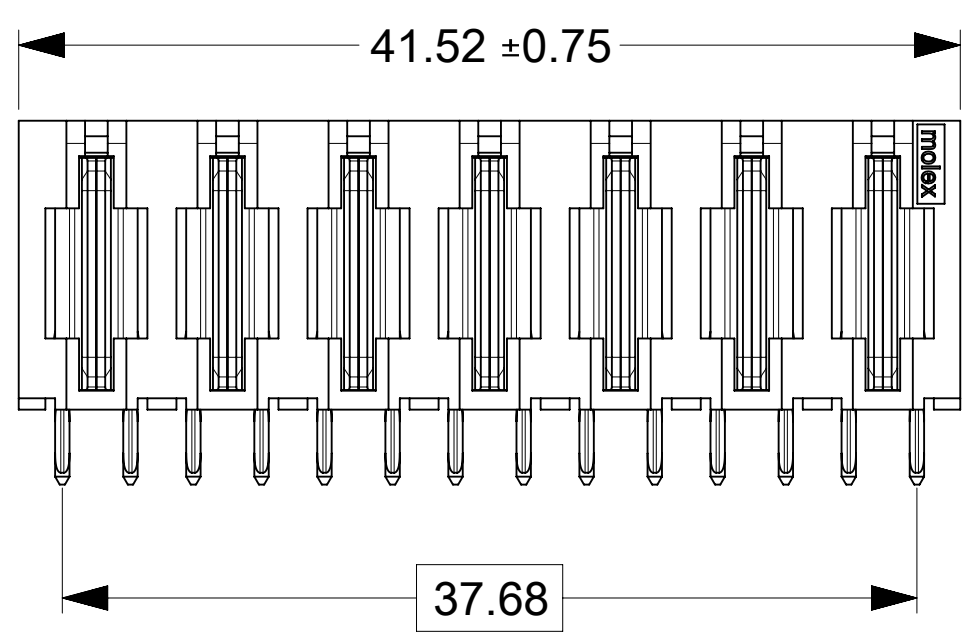

PART NUMBER	CONFIGURATION	QUANTITY PER CARTON (DU)
219562-0038	8P	96

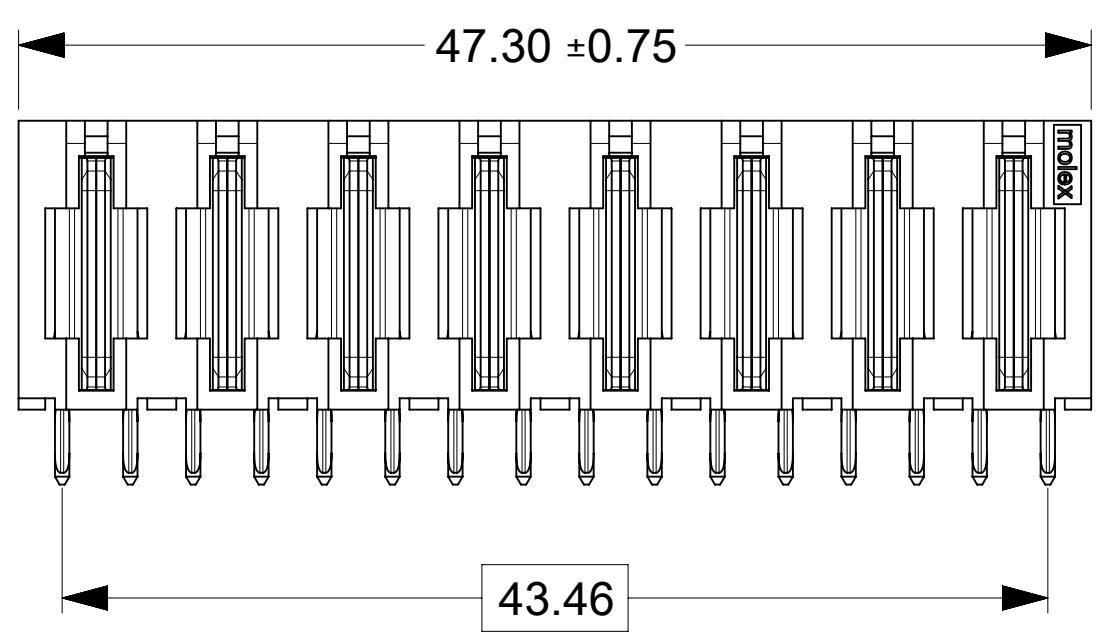

PART NUMBER	CONFIGURATION	QUANTITY PER CARTON (DU)
219562-0039	9P	80

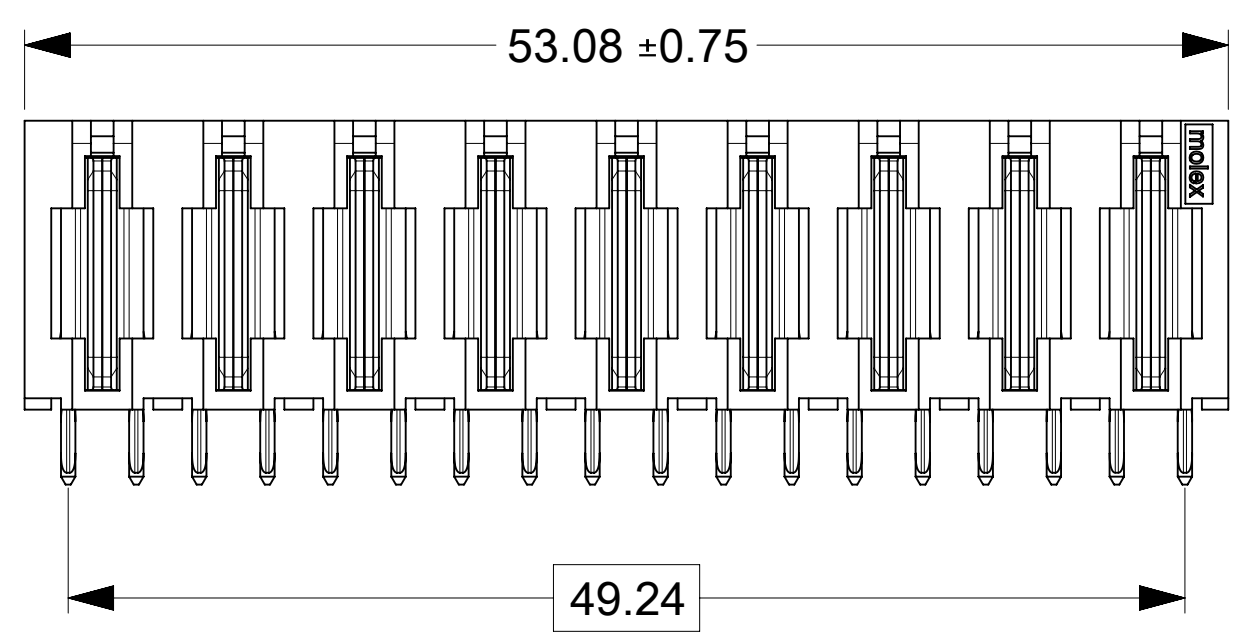

PART NUMBER	CONFIGURATION	QUANTITY PER CARTON (DU)
219562-0040	10P	64

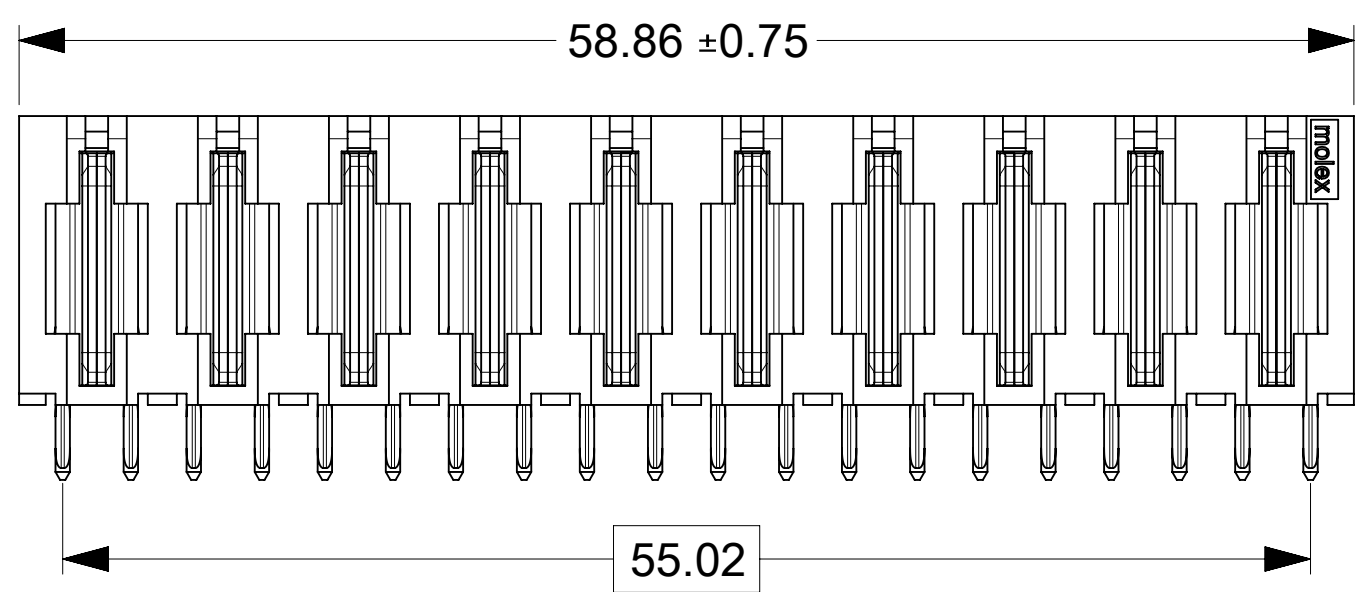

THIS DRAWING CONTAINS INFORMATION THAT IS PROPRIETARY TO MOLEX ELECTRONIC TECHNOLOGIES, LLC AND SHOULD NOT BE USED WITHOUT WRITTEN PERMISSION

DIMENSION UNITS	SCALE	CURRENT REV DESC:	
mm	3:1		
GENERAL TOLERANCES (UNLESS SPECIFIED)			
ANGULAR TOL	±	°	
4 PLACES	±		
3 PLACES	±		
2 PLACES	±	0.25	
1 PLACE	±	0.3	
0 PLACES	±		
DRAFT WHERE APPLICABLE MUST REMAIN WITHIN DIMENSIONS		THIRD ANGLE PROJECTION	DRAWING
		D-SIZE	SERIES
		219562	219562
		MATERIAL NUMBER	CUSTOMER
		SEE CHART	
		SHEET NUMBER	2 OF 2

# molex

GUARDIAN HD RA PLUG POWER ONLY  
UNGUIDED PF

PRODUCT CUSTOMER DRAWING

DOCUMENT NUMBER	DOC TYPE	DOC PART	REVISION
2195629003-SD	PSD	000	A1

DOCUMENT STATUS	P1	RELEASE DATE	2023/04/11	17:04:40
-----------------	----	--------------	------------	----------