

TOLERANCE UNLESS OTHERWISE SPECIFIED	
.X	±0.25
.XX	±0.13
.XXX	±0.05

THIS IS A C.A.D. GENERATED DRAWING  
DO NOT MAKE MANUAL REVISIONS TO MASTER.

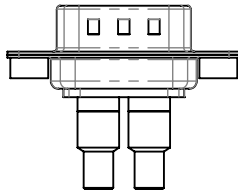

ISSUE NUMBER	
ORIGINAL	①

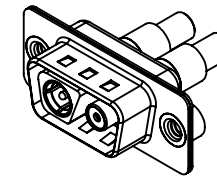
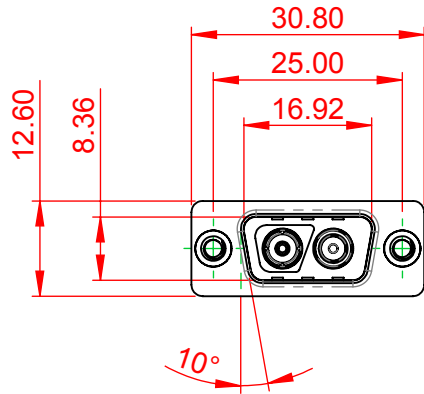

**NOTES:**

**MATERIAL:**

**HOUSING:** THERMOPLASTIC POLYESTER, UL94V-0

**SHELL:** STEEL, Sn or Ni PLATED

**CONTACT:** COPPER ALLOY SEE ORDERING GUIDE FOR PLATING

**OPERATING TEMPERATURE:** -55°C ~ 125°C

**SIGNAL CONTACT CURRENT RATING:** 5A PER CONTACT

**SIGNAL CONTACT RESISTANCE:** 10mΩ MAX.

**INSULATOR RESISTANCE:** 5000MΩ min.

**DIELECTRIC**

**WITHSTANDING VOLTAGE:** 1000V AC rms

**COMBINATION D-SUB**

SW REFERENCE NO.: 627 COMBO ASSEMBLY	
DRAWN: C.B	DATE: JAN. 01/2019
CHECKED:	DATE:
SCALE: (IN C.A.D. 1:1)	SHEET 1 OF 4
DRAWING NUMBER: 627-2WK2622-5T2	ISSUE 1
PART NUMBER: 627-2WK2622-5T2	



THIS SERIES FULLY CONFORMS TO  
THE EUROPEAN UNION DIRECTIVES  
2011/65/EU FOR RoHS COMPLIANCY.



YOUR CONNECTION TO QUALITY & SERVICE

EDAC INC  
TORONTO, ONTARIO  
CANADA

THESE DRAWINGS AND SPECIFICATIONS  
ARE THE PROPERTY OF EDAC INC., AND  
SHALL NOT BE REPRODUCED, OR COPIED  
OR USED AS THE BASIS FOR THE  
MANUFACTURE OR SALE OF APPARATUS  
WITHOUT WRITTEN PERMISSION.

TOLERANCE UNLESS OTHERWISE SPECIFIED	
.X	±0.25
.XX	±0.13
.XXX	±0.05

THIS IS A C.A.D. GENERATED DRAWING  
DO NOT MAKE MANUAL REVISIONS TO MASTER.



ISSUE NUMBER	
ORIGINAL	①



<b>COMBINATION D-SUB</b>		SW REFERENCE NO.: 627 COMBO ASSEMBLY	
		DRAWN: C.B	DATE: JAN. 01/2019
<b>EDAC</b> EDAC INC TORONTO, ONTARIO CANADA YOUR CONNECTION TO QUALITY & SERVICE		CHECKED:	
		DATE:	
<b>EDAC</b> EDAC INC TORONTO, ONTARIO CANADA YOUR CONNECTION TO QUALITY & SERVICE		SCALE: N.T.S	SHEET 2 OF 6
		DRAWING NUMBER: 627-2WK2622-5T2	ISSUE 1
<b>EDAC</b> EDAC INC TORONTO, ONTARIO CANADA YOUR CONNECTION TO QUALITY & SERVICE		PART NUMBER: 627-2WK2622-5T2	
		ISSUE 1	



THIS SERIES FULLY CONFORMS TO  
THE EUROPEAN UNION DIRECTIVES  
2011/65/EU FOR RoHS COMPLIANCY.

THESE DRAWINGS AND SPECIFICATIONS  
ARE THE PROPERTY OF EDAC INC., AND  
SHALL NOT BE REPRODUCED, OR COPIED  
OR USED AS THE BASIS FOR THE  
MANUFACTURE OR SALE OF APPARATUS  
WITHOUT WRITTEN PERMISSION.

TOLERANCE UNLESS OTHERWISE SPECIFIED	
.X	±0.25
.XX	±0.13
.XXX	±0.05

THIS IS A C.A.D. GENERATED DRAWING  
DO NOT MAKE MANUAL REVISIONS TO MASTER.



ISSUE NUMBER	①
ORIGINAL	

2W2 / 2WK2



3W3 / 3WK3



5W1 Male/Female



24W7 Male/Female



5W5 Male



8W8 Male



7W2 Male/Female



21W4 Male/Female



5W5 Female



8W8 Female



11W1 Male/Female



27W2 Male/Female



17W2 Male/Female



21W1 Male/Female



CURRENT RATING /  $\phi$ A

- 10A / 2.2
- 20A / 3.3
- 30A / 3.7
- 40A / 4.2



THIS SERIES FULLY CONFORMS TO  
THE EUROPEAN UNION DIRECTIVES  
2011/65/EU FOR RoHS COMPLIANCY.



YOUR CONNECTION TO QUALITY & SERVICE

COMBINATION D-SUB

EDAC INC  
TORONTO, ONTARIO  
CANADA

THESE DRAWINGS AND SPECIFICATIONS  
ARE THE PROPERTY OF EDAC INC., AND  
SHALL NOT BE REPRODUCED, OR COPIED  
OR USED AS THE BASIS FOR THE  
MANUFACTURE OR SALE OF APPARATUS  
WITHOUT WRITTEN PERMISSION.

SW REFERENCE NO.: 627 COMBO ASSEMBLY	
DRAWN: C.B	DATE: JAN. 01/2019
CHECKED:	DATE:
SCALE: N.T.S	SHEET 3 OF 4
DRAWING NUMBER: 627-2WK2622-5T2	ISSUE 1
PART NUMBER: 627-2WK2622-5T2	

TOLERANCE UNLESS OTHERWISE SPECIFIED	
.X	±0.25
.XX	±0.13
.XXX	±0.05

THIS IS A C.A.D. GENERATED DRAWING  
DO NOT MAKE MANUAL REVISIONS TO MASTER.



ISSUE NUMBER

ORIGINAL

1

9W4 Male



25W3 Male



9W4 Female



25W3 Female



13W3 Male



36W4 Male

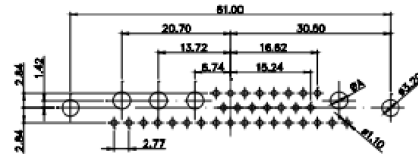

13W3 Female

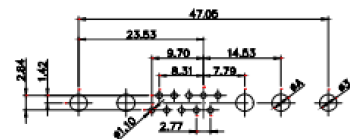

36W4 Female

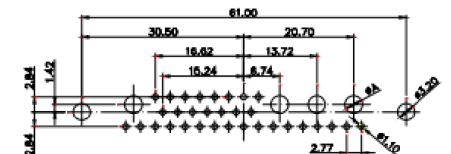

13W6 Male



43W2 Male



13W6 Female



43W2 Female



17W5 Male



47W1 Male

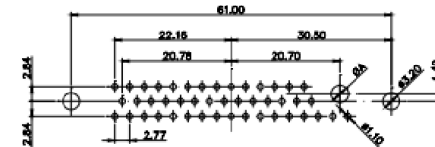

17W5 Female

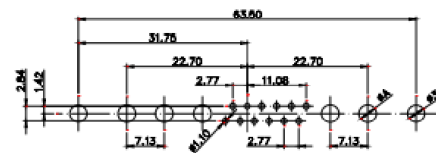

47W1 Female

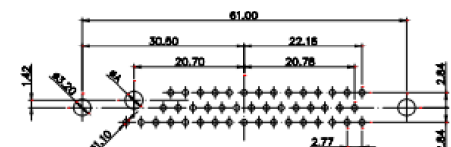

THIS SERIES FULLY CONFORMS TO  
THE EUROPEAN UNION DIRECTIVES  
2011/65/EU FOR RoHS COMPLIANCY.



YOUR CONNECTION TO QUALITY & SERVICE

COMBINATION D-SUB

EDAC INC  
TORONTO, ONTARIO  
CANADA

THESE DRAWINGS AND SPECIFICATIONS  
ARE THE PROPERTY OF EDAC INC., AND  
SHALL NOT BE REPRODUCED, OR COPIED  
OR USED AS THE BASIS FOR THE  
MANUFACTURE OR SALE OF APPARATUS  
WITHOUT WRITTEN PERMISSION.

SW REFERENCE NO.: 627 COMBO ASSEMBLY

DRAWN: C.B DATE: JAN. 01/2019

CHECKED: DATE:

SCALE: N.T.S SHEET 4 OF 4

DRAWING NUMBER: 627-2WK2622-5T2

PART NUMBER: 627-2WK2622-5T2

ISSUE

1