



Aluminum electrolytic capacitors

Axial-lead and soldering star capacitors

Series/Type: B43693, B43793

Date: December 2016

© EPCOS AG 2016. Reproduction, publication and dissemination of this publication, enclosures hereto and the information contained therein without EPCOS' prior express consent is prohibited.

EPCOS AG is a TDK Group Company.

Applications

- Automotive electronics

Features

- High voltage design
- High ripple current capability
- Long useful life
- High vibration stability
- RoHS-compatible

Construction

- Charge/discharge-proof, polar
- Negative pole connected to case
- Version without insulation available upon request

Terminals

- Axial leads, welded to capacitor case and cover disc
- Soldering star option for upright mounting on PCB
- Alternative axial-lead design with double-sided plates for horizontal mounting available upon request

Taping and packing

- Axial-lead capacitors will be delivered in pallet package
Capacitors with $d \times l \leq 16 \times 39$ mm are also available taped on reel
- Soldering star capacitors are packed in blister trays

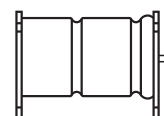
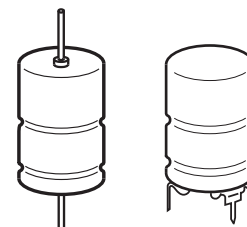

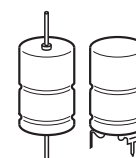

Specifications and characteristics in brief

Rated voltage V_R	140 ... 250 V DC					
Surge voltage V_S	$1.15 \cdot V_R$					
Rated capacitance C_R	47 ... 620 μF					
Capacitance tolerance	$-10/+30\% \triangleq Q$					
Leakage current I_{leak} (5 min, 20 °C)	$I_{\text{leak}} \leq 0.3 \mu\text{A} \cdot \left(\frac{C_R}{\mu\text{F}} \cdot \frac{V_R}{\text{V}} \right)^{0.7} + 4 \mu\text{A}$					
Self-inductance ESL ¹⁾	Diameter d (mm)	14	16	18	21	
	Terminals	Length l (mm)				
	axial	Approx. ESL (nH)				
		25	–	26	30	–
		30	24	29	34	39
		35	–	31	36	41
		39	–	33	38	45
	soldering star	49	–	–	–	50
		25	–	7	8	–
		30	7	8	10	11
35		–	9	10.5	12	
39		–	9	11	13	
49	–	–	–	14		
Useful life ²⁾		Requirements:				
140 °C; V_R ; 0.5 $I_{AC,R}$	1000 h	$\Delta C/C$ $\leq 30\%$ of initial value				
125 °C; V_R ; $I_{AC,R}$	> 2500 h	ESR ≤ 3 times initial specified limit ³⁾				
105 °C; V_R ; $I_{AC,R}$	> 10000 h	$I_{\text{leak}} \leq$ initial specified limit				
85 °C; V_R ; $I_{AC,max}$	> 4000 h					
Voltage endurance test		Post test requirements:				
125 °C; V_R	1500 h	$\Delta C/C$ $\leq 10\%$ of initial value				
		ESR ≤ 1.3 times initial specified limit ³⁾				
		$I_{\text{leak}} \leq$ initial specified limit				
Vibration resistance test	To IEC 60068-2-6, test Fc: Frequency range 10 Hz ... 2 kHz, displacement amplitude max. 1.5 mm, acceleration max. 20 g, duration 3 × 2 h. Capacitor mounted by its wire leads at a distance of (6 ± 1) mm from the case and additionally clamped by the case.					
IEC climatic category	To IEC 60068-1: 40/125/56 (–40 °C/+125 °C/56 days damp heat test)					
Detail specification	Similar to CECC 30301-802					
Sectional specification	IEC 60384-4					

1) If optimum circuit design is used, the values are lower by 30%.

2) Refer to chapter "General technical information, 5 Useful life" on how to interpret useful life.

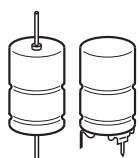
3) ESR_{max} at 100 Hz, 20 °C



B43693, B43793

High voltage – 125 °C

B43693, Axial-lead capacitors

Dimensional drawing

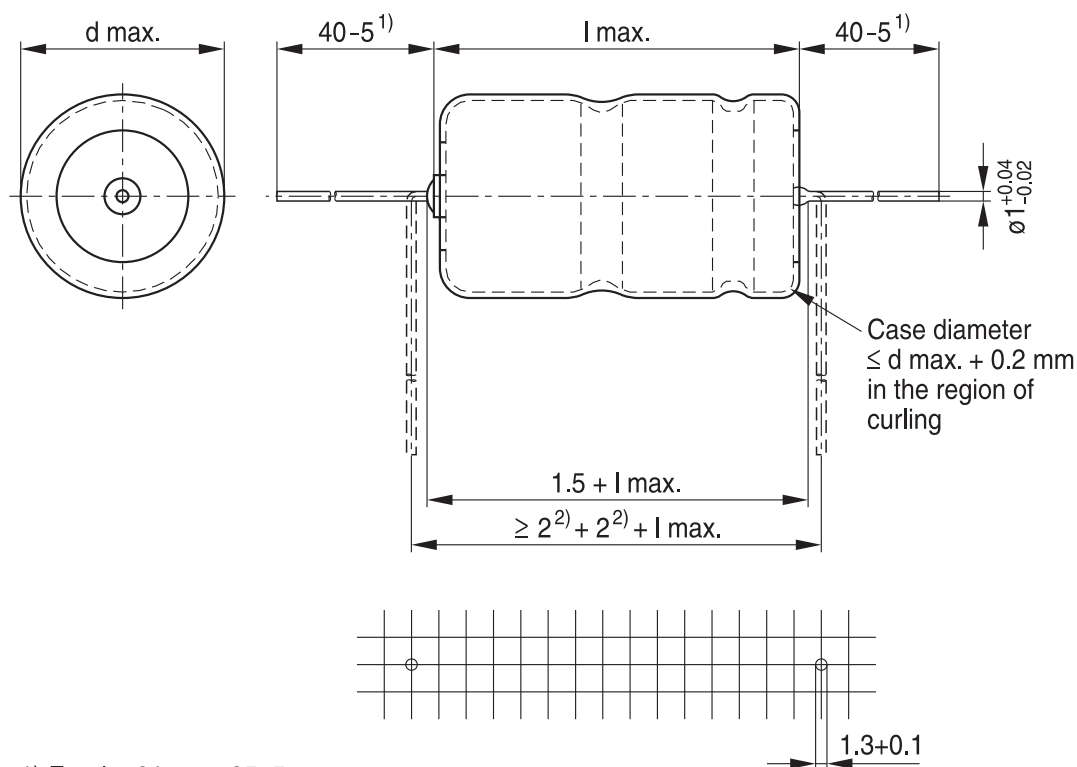

1) For d = 21 mm: 35-5

2) Minimum 2 mm bending distance per wire recommended

KAL1655-Y-E

Dimensions, weights and packing units

d × l mm	d _{max} × l _{max} mm	Approx. weight g	Packing units (pcs.)	
			Pallet	Reel
14 × 30	14.5 × 30.5	6.8	200	350
16 × 25	16.5 × 25.5	7.4	180	250
16 × 30	16.5 × 30.5	8.9	180	250
16 × 35	16.5 × 35.5	10.4	180	250
16 × 39	16.5 × 40	11.7	180	250
18 × 25	18.5 × 25.5	9.3	160	—
18 × 30	18.5 × 30.5	11.1	160	—
18 × 35	18.5 × 35.5	12.8	160	—
18 × 39	18.5 × 40	14.7	160	—
21 × 30	21.5 × 30.5	16.5	140	—
21 × 35	21.5 × 35.5	17.0	140	—
21 × 39	21.5 × 40	20.0	140	—
21 × 49	21.5 × 50	25.0	110	—

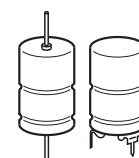
B43793, Soldering star capacitors
Dimensional drawings

 Mounting holes $d = 14 \text{ mm}$

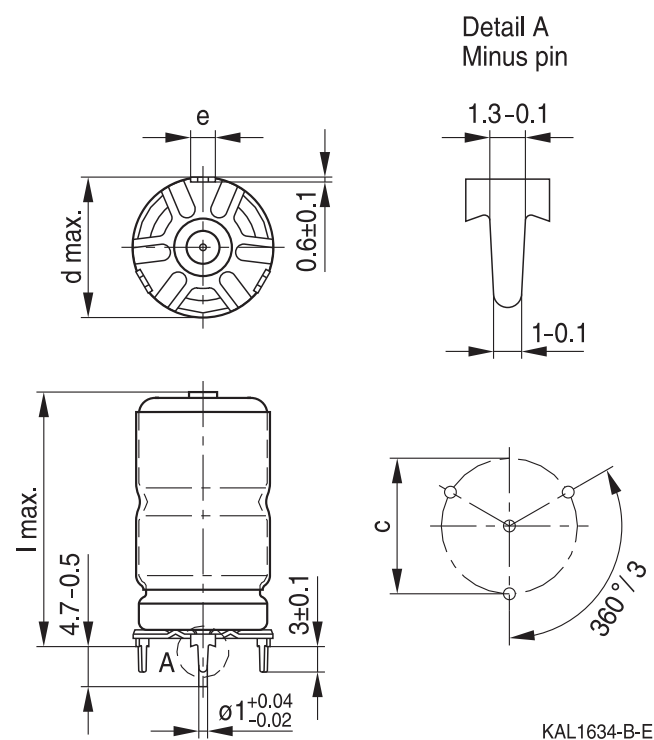
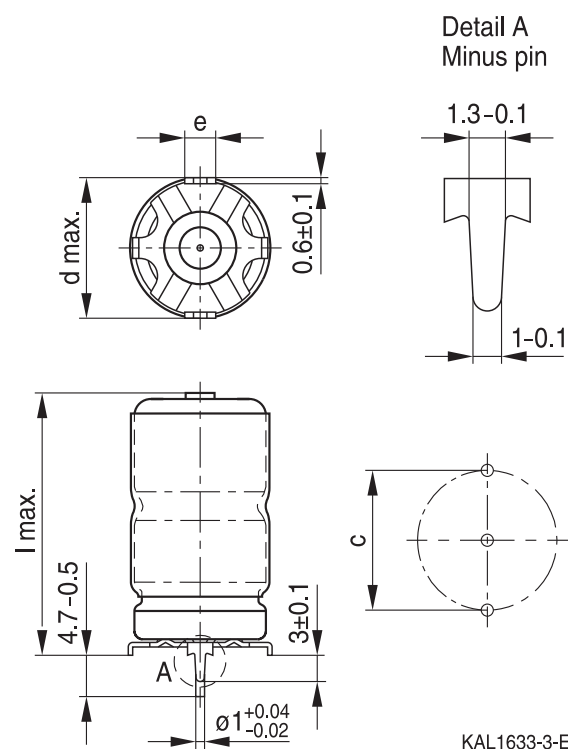
 Mounting holes $d = 16 \text{ mm} \dots 21 \text{ mm}$

Dimensions, weights and packing units

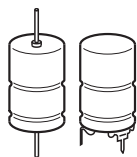
$d \times l$ mm	$d_{\max} \times l_{\max}$ mm	$c \pm 0.1$ mm	$e \pm 0.1$ mm	Approx. weight g	Packing units pcs.
14 × 30	15.5 × 32	14.5	3.0	7.2	480
16 × 25	17.5 × 27	16.5	3.0	7.9	300
16 × 30	17.5 × 32	16.5	3.0	9.4	300
16 × 35	17.5 × 37	16.5	3.0	10.9	200
16 × 39	17.5 × 41.5	16.5	3.0	12.2	200
18 × 25	19.5 × 27	18.5	3.0	9.9	300
18 × 30	19.5 × 32	18.5	3.0	11.8	300
18 × 35	19.5 × 37	18.5	3.0	13.2	200
18 × 39	19.5 × 41.5	18.5	3.0	15.4	200
21 × 30	22.5 × 32	21.5	3.5	17.1	468
21 × 35	22.5 × 37	21.5	3.5	18.3	324
21 × 39	22.5 × 41.5	21.5	3.5	21.0	324
21 × 49	22.5 × 51.5	21.5	3.5	26.0	264



B43693, B43793

High voltage – 125 °C

Overview of available types

V_R (V DC)	140	160	200	250
	Case dimensions $d \times l$ (mm)			
C_R (μF)				
47				14 × 30
51				16 × 25
68				16 × 30
75			14 × 30	18 × 25
82			16 × 25	16 × 35
91		14 × 30 16 × 25		18 × 30
100				16 × 39
110			16 × 30 18 × 25	18 × 35
120	14 × 30 16 × 25	16 × 30		
130		18 × 25	16 × 35	18 × 39 21 × 30
150			18 × 30	
160	16 × 30 18 × 25	16 × 35 18 × 30	16 × 39	21 × 35
180		16 × 39	18 × 35	21 × 39
200	16 × 35	18 × 35	21 × 30	
220	18 × 30		18 × 39	
240	16 × 39	18 × 39 21 × 30	21 × 35	21 × 49
270	18 × 35			
300	21 × 30	21 × 35	21 × 39	
330	18 × 39			
360		21 × 39		
390	21 × 35		21 × 49	
470	21 × 39	21 × 49		
620	21 × 49			

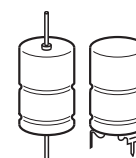
Case dimensions and ordering codes

C_R 100 Hz 20 °C μF	Case dimensions $d \times l$ mm	Ordering code Axial pallet	Ordering code Axial reel	Ordering code Soldering star
$V_R = 140 \text{ V DC}$				
120	14 × 30	B43693C0127Q001	B43693C0127Q003	B43793C0127Q001
120	16 × 25	B43693D0127Q001	B43693D0127Q003	B43793D0127Q001
160	16 × 30	B43693C0167Q001	B43693C0167Q003	B43793C0167Q001
160	18 × 25	B43693D0167Q001		B43793D0167Q001
200	16 × 35	B43693C0207Q001	B43693C0207Q003	B43793C0207Q001
220	18 × 30	B43693C0227Q001		B43793C0227Q001
240	16 × 39	B43693C0247Q001	B43693C0247Q003	B43793C0247Q001
270	18 × 35	B43693C0277Q001		B43793C0277Q001
300	21 × 30	B43693C0307Q001		B43793C0307Q001
330	18 × 39	B43693C0337Q001		B43793C0337Q001
390	21 × 35	B43693C0397Q001		B43793C0397Q001
470	21 × 39	B43693C0477Q001		B43793C0477Q001
620	21 × 49	B43693C0627Q001		B43793C0627Q001
$V_R = 160 \text{ V DC}$				
91	14 × 30	B43693C1916Q001	B43693C1916Q003	B43793C1916Q001
91	16 × 25	B43693D1916Q001	B43693D1916Q003	B43793D1916Q001
120	16 × 30	B43693C1127Q001	B43693C1127Q003	B43793C1127Q001
130	18 × 25	B43693C1137Q001		B43793C1137Q001
160	16 × 35	B43693C1167Q001	B43693C1167Q003	B43793C1167Q001
160	18 × 30	B43693D1167Q001		B43793D1167Q001
180	16 × 39	B43693C1187Q001	B43693C1187Q003	B43793C1187Q001
200	18 × 35	B43693C1207Q001		B43793C1207Q001
240	18 × 39	B43693C1247Q001		B43793C1247Q001
240	21 × 30	B43693D1247Q001		B43793D1247Q001
300	21 × 35	B43693C1307Q001		B43793C1307Q001
360	21 × 39	B43693C1367Q001		B43793C1367Q001
470	21 × 49	B43693C1477Q001		B43793C1477Q001

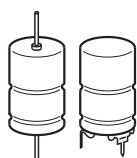

B43693, B43793

High voltage – 125 °C

Case dimensions and ordering codes

C_R 100 Hz 20 °C μF	Case dimensions $d \times l$ mm	Ordering code Axial pallet	Ordering code Axial reel	Ordering code Soldering star
$V_R = 200 \text{ V DC}$				
75	14 × 30	B43693E2756Q001	B43693E2756Q003	B43793E2756Q001
82	16 × 25	B43693E2826Q001	B43693E2826Q003	B43793E2826Q001
110	16 × 30	B43693E2117Q001	B43693E2117Q003	B43793E2117Q001
110	18 × 25	B43693F2117Q001		B43793F2117Q001
130	16 × 35	B43693E2137Q001	B43693E2137Q003	B43793E2137Q001
150	18 × 30	B43693E2157Q001		B43793E2157Q001
160	16 × 39	B43693E2167Q001	B43693E2167Q003	B43793E2167Q001
180	18 × 35	B43693E2187Q001		B43793E2187Q001
200	21 × 30	B43693E2207Q001		B43793E2207Q001
220	18 × 39	B43693E2227Q001		B43793E2227Q001
240	21 × 35	B43693E2247Q001		B43793E2247Q001
300	21 × 39	B43693E2307Q001		B43793E2307Q001
390	21 × 49	B43693E2397Q001		B43793E2397Q001
$V_R = 250 \text{ V DC}$				
47	14 × 30	B43693C2476Q001	B43693C2476Q003	B43793C2476Q001
51	16 × 25	B43693C2516Q001	B43693C2516Q003	B43793C2516Q001
68	16 × 30	B43693C2686Q001	B43693C2686Q003	B43793C2686Q001
75	18 × 25	B43693C2756Q001		B43793C2756Q001
82	16 × 35	B43693C2826Q001	B43693C2826Q003	B43793C2826Q001
91	18 × 30	B43693C2916Q001		B43793C2916Q001
100	16 × 39	B43693C2107Q001	B43693C2107Q003	B43793C2107Q001
110	18 × 35	B43693C2117Q001		B43793C2117Q001
130	18 × 39	B43693C2137Q001		B43793C2137Q001
130	21 × 30	B43693D2137Q001		B43793D2137Q001
160	21 × 35	B43693C2167Q001		B43793C2167Q001
180	21 × 39	B43693C2187Q001		B43793C2187Q001
240	21 × 49	B43693C2247Q001		B43793C2247Q001

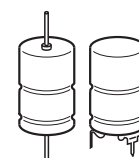
Technical data

C_R 100 Hz 20 °C μF	Case dimensions $d \times l$ mm	ESR_{max} 100 Hz 20 °C m Ω	ESR_{max} 100 Hz –40 °C Ω	ESR_{max} 10 kHz 20 °C m Ω	Z_{max} 100 kHz 20 °C m Ω	$I_{\text{AC,max}}$ 10 kHz 85 °C A	$I_{\text{AC,max}}$ 10 kHz 125 °C A	$I_{\text{AC,R}}$ 10 kHz 125 °C A	$I_{\text{AC,max}}$ 10 kHz 140 °C A
$V_R = 140 \text{ V DC}$									
120	14 × 30	799	26.5	392	384	3.7	2.5	1.3	0.66
120	16 × 25	806	26.5	398	390	3.5	2.4	1.2	0.62
160	16 × 30	605	19.9	299	293	4.4	3.0	1.6	0.79
160	18 × 25	598	19.9	293	287	4.5	3.1	1.6	0.80
200	16 × 35	485	15.9	240	235	5.3	3.6	1.9	0.94
220	18 × 30	436	14.5	214	209	5.7	3.9	2.0	1.02
240	16 × 39	405	13.3	201	197	6.0	4.1	2.2	1.08
270	18 × 35	355	11.8	174	171	6.8	4.6	2.4	1.22
300	21 × 30	323	10.6	160	156	6.9	4.7	2.5	1.23
330	18 × 39	291	9.6	143	140	7.9	5.4	2.8	1.41
390	21 × 35	249	8.1	124	121	8.4	5.7	3.0	1.50
470	21 × 39	207	6.8	103	101	9.6	6.6	3.5	1.73
620	21 × 49	158	5.1	78	77	12.2	8.4	4.4	2.20
$V_R = 160 \text{ V DC}$									
91	14 × 30	918	26.8	396	388	3.7	2.5	1.3	0.66
91	16 × 25	925	26.8	402	394	3.5	2.4	1.2	0.62
120	16 × 30	702	20.4	306	299	4.3	3.0	1.6	0.78
130	18 × 25	642	18.8	277	271	4.6	3.1	1.6	0.82
160	16 × 35	528	15.3	231	226	5.3	3.6	1.9	0.96
160	18 × 30	521	15.3	225	220	5.6	3.8	2.0	1.00
180	16 × 39	469	13.6	205	201	6.0	4.1	2.2	1.07
200	18 × 35	418	12.2	180	177	6.7	4.6	2.4	1.20
240	18 × 39	349	10.2	151	148	7.7	5.3	2.8	1.38
240	21 × 30	352	10.2	153	150	7.0	4.8	2.5	1.25
300	21 × 35	282	8.1	123	121	8.4	5.7	3.0	1.50
360	21 × 39	235	6.8	103	101	9.6	6.6	3.5	1.72
470	21 × 49	181	5.2	79	77	12.2	8.4	4.4	2.19

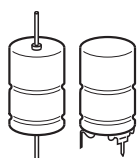

B43693, B43793

High voltage – 125 °C

Technical data

C_R 100 Hz 20 °C μF	Case dimensions $d \times l$ mm	ESR_{max} 100 Hz 20 °C m Ω	ESR_{max} 100 Hz –40 °C Ω	ESR_{max} 10 kHz 20 °C m Ω	Z_{max} 100 kHz 20 °C m Ω	$I_{\text{AC,max}}$ 10 kHz 85 °C A	$I_{\text{AC,max}}$ 10 kHz 125 °C A	$I_{\text{AC,R}}$ 10 kHz 125 °C A	$I_{\text{AC,max}}$ 10 kHz 140 °C A
$V_R = 200 \text{ V DC}$									
75	14 × 30	1040	28.1	414	406	3.6	2.5	1.3	0.65
82	16 × 25	959	25.8	387	379	3.5	2.4	1.3	0.63
110	16 × 30	716	19.2	289	283	4.4	3.0	1.6	0.80
110	18 × 25	708	19.2	282	277	4.5	3.1	1.6	0.82
130	16 × 35	605	16.3	244	239	5.2	3.6	1.9	0.94
150	18 × 30	520	14.1	208	204	5.8	3.9	2.1	1.03
160	16 × 39	493	13.2	200	196	6.0	4.1	2.2	1.08
180	18 × 35	434	11.8	173	170	6.8	4.7	2.5	1.22
200	21 × 30	393	10.6	159	155	6.9	4.7	2.5	1.24
220	18 × 39	355	9.6	142	139	7.9	5.4	2.8	1.41
240	21 × 35	328	8.8	132	129	8.2	5.6	2.9	1.47
300	21 × 39	263	7.0	107	104	9.5	6.5	3.4	1.71
390	21 × 49	203	5.4	82	80	12.0	8.3	4.3	2.17
$V_R = 250 \text{ V DC}$									
47	14 × 30	1380	28.3	414	405	3.6	2.5	1.3	0.65
51	16 × 25	1280	26.1	389	381	3.5	2.4	1.3	0.63
68	16 × 30	961	19.6	293	287	4.4	3.0	1.6	0.79
75	18 × 25	866	17.8	260	255	4.7	3.2	1.7	0.84
82	16 × 35	797	16.2	243	238	5.2	3.6	1.9	0.94
91	18 × 30	713	14.6	214	210	5.7	3.9	2.0	1.02
100	16 × 39	654	13.3	200	196	6.0	4.1	2.2	1.08
110	18 × 35	590	12.1	177	174	6.8	4.6	2.4	1.21
130	18 × 39	500	10.3	150	147	7.7	5.3	2.8	1.38
130	21 × 30	503	10.3	153	150	7.0	4.8	2.5	1.25
160	21 × 35	409	8.3	125	122	8.4	5.7	3.0	1.50
180	21 × 39	363	7.4	111	108	9.4	6.4	3.4	1.68
240	21 × 49	273	5.5	83	81	12.0	8.2	4.3	2.16

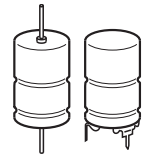

Useful life¹⁾

depending on ambient temperature T_A under ripple current operating conditions at V_R

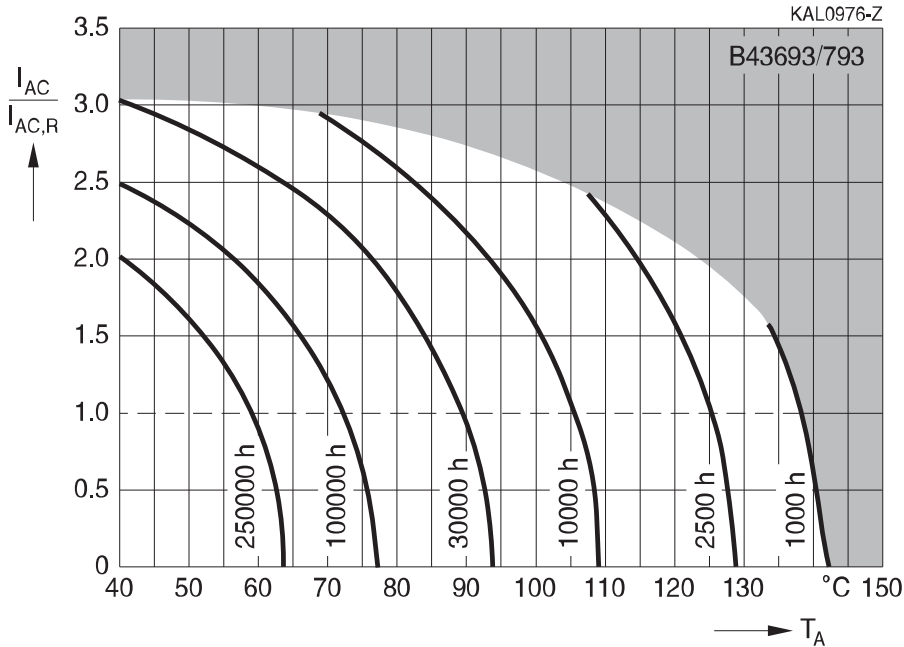

Useful life¹⁾

depending on case temperature T_C under ripple current operating conditions at V_R ¹⁾

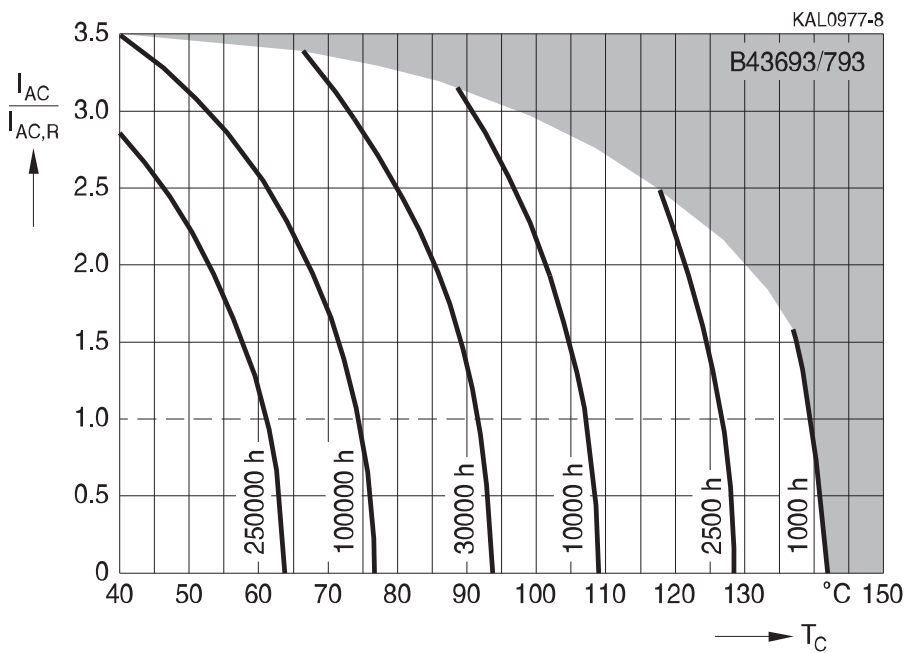

1) Refer to chapter "General technical information, 5 Useful life" on how to interpret useful life.

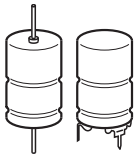

B43693, B43793

High voltage – 125 °C

Frequency factor of permissible ripple current I_{AC} versus frequency f

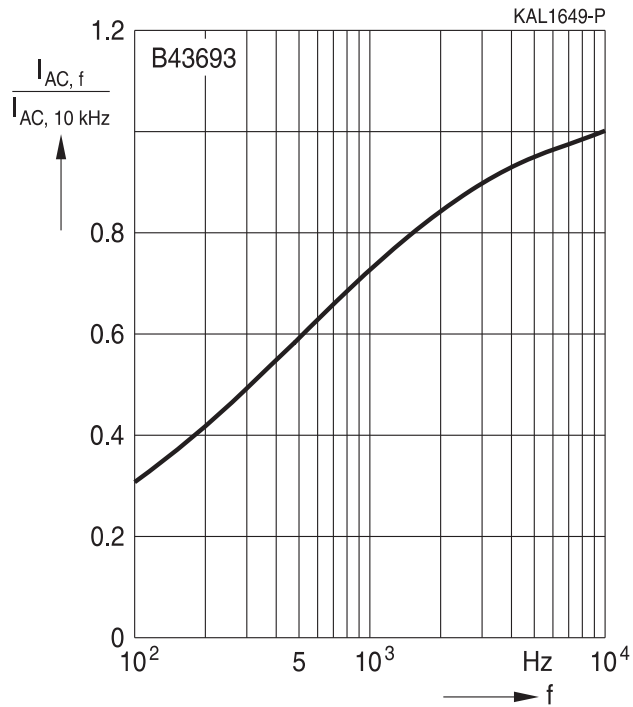

Equivalent series resistance ESR versus frequency f

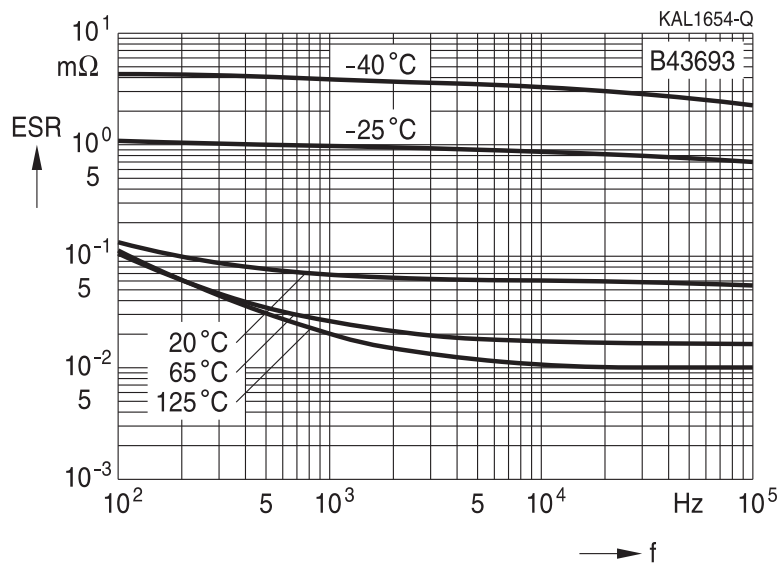

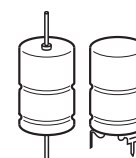

Cautions and warnings

Personal safety

The electrolytes used by EPCOS have been optimized both with a view to the intended application and with regard to health and environmental compatibility. They do not contain any solvents that are detrimental to health, e.g. dimethyl formamide (DMF) or dimethyl acetamide (DMAC).

Furthermore, some of the high-voltage electrolytes used by EPCOS are self-extinguishing.

As far as possible, EPCOS does not use any dangerous chemicals or compounds to produce operating electrolytes, although in exceptional cases, such materials must be used in order to achieve specific physical and electrical properties because no alternative materials are currently known. We do, however, restrict the amount of dangerous materials used in our products to an absolute minimum.

Materials and chemicals used in EPCOS aluminum electrolytic capacitors are continuously adapted in compliance with the EPCOS Corporate Environmental Policy and the latest EU regulations and guidelines such as RoHS, REACH/SVHC, GADSL, and ELV.

MDS (Material Data Sheets) are available on the EPCOS website for all types listed in the data book. MDS for customer specific capacitors are available upon request.

MSDS (Material Safety Data Sheets) are available for all of our electrolytes upon request.

Nevertheless, the following rules should be observed when handling aluminum electrolytic capacitors: No electrolyte should come into contact with eyes or skin. If electrolyte does come into contact with the skin, wash the affected areas immediately with running water. If the eyes are affected, rinse them for 10 minutes with plenty of water. If symptoms persist, seek medical treatment. Avoid inhaling electrolyte vapor or mists. Workplaces and other affected areas should be well ventilated. Clothing that has been contaminated by electrolyte must be changed and rinsed in water.

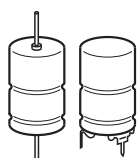

B43693, B43793

High voltage – 125 °C

Product safety

The table below summarizes the safety instructions that must be observed without fail. A detailed description can be found in the relevant sections of chapter "General technical information".

Topic	Safety information	Reference chapter "General technical information"
Polarity	Make sure that polar capacitors are connected with the right polarity.	1 "Basic construction of aluminum electrolytic capacitors"
Reverse voltage	Voltages of opposite polarity should be prevented by connecting a diode.	3.1.6 "Reverse voltage"
Mounting position of screw-terminal capacitors	Screw terminal capacitors must not be mounted with terminals facing down unless otherwise specified.	11.1. "Mounting positions of capacitors with screw terminals"
Robustness of terminals	The following maximum tightening torques must not be exceeded when connecting screw terminals: M5: 2.5 Nm M6: 4.0 Nm	11.3 "Mounting torques"
Mounting of single-ended capacitors	The internal structure of single-ended capacitors might be damaged if excessive force is applied to the lead wires. Avoid any compressive, tensile or flexural stress. Do not move the capacitor after soldering to PC board. Do not pick up the PC board by the soldered capacitor. Do not insert the capacitor on the PC board with a hole space different to the lead space specified.	11.4 "Mounting considerations for single-ended capacitors"
Soldering	Do not exceed the specified time or temperature limits during soldering.	11.5 "Soldering"
Soldering, cleaning agents	Do not allow halogenated hydrocarbons to come into contact with aluminum electrolytic capacitors.	11.6 "Cleaning agents"
Upper category temperature	Do not exceed the upper category temperature.	7.2 "Maximum permissible operating temperature"
Passive flammability	Avoid external energy, e.g. fire.	8.1 "Passive flammability"

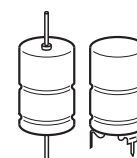

Topic	Safety information	Reference chapter "General technical information"
Active flammability	Avoid overload of the capacitors.	8.2 "Active flammability"
Maintenance	Make periodic inspections of the capacitors. Before the inspection, make sure that the power supply is turned off and carefully discharge the capacitors. Do not apply excessive mechanical stress to the capacitor terminals when mounting.	10 "Maintenance"
Storage	Do not store capacitors at high temperatures or high humidity. Capacitors should be stored at +5 to +35 °C and a relative humidity of ≤ 75%.	7.3 "Shelf life and storage conditions"
		Reference chapter "Capacitors with screw terminals"
Breakdown strength of insulating sleeves	Do not damage the insulating sleeve, especially when ring clips are used for mounting.	"Screw terminals – accessories"

Display of ordering codes for EPCOS products

The ordering code for one and the same product can be represented differently in data sheets, data books, other publications and the website of EPCOS, or in order-related documents such as shipping notes, order confirmations and product labels. The varying representations of the ordering codes are due to different processes employed and do not affect the specifications of the respective products.

Detailed information can be found on the Internet under www.epcos.com/orderingcodes.

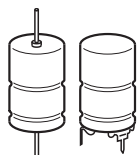

B43693, B43793

High voltage – 125 °C

Symbols and terms

Symbol	English	German
C	Capacitance	Kapazität
C_R	Rated capacitance	Nennkapazität
C_S	Series capacitance	Serienkapazität
$C_{S,T}$	Series capacitance at temperature T	Serienkapazität bei Temperatur T
C_f	Capacitance at frequency f	Kapazität bei Frequenz f
d	Case diameter, nominal dimension	Gehäusedurchmesser, Nennmaß
d_{max}	Maximum case diameter	Maximaler Gehäusedurchmesser
ESL	Self-inductance	Eigeninduktivität
ESR	Equivalent series resistance	Ersatzserienwiderstand
ESR_f	Equivalent series resistance at frequency f	Ersatzserienwiderstand bei Frequenz f
ESR_T	Equivalent series resistance at temperature T	Ersatzserienwiderstand bei Temperatur T
f	Frequency	Frequenz
I	Current	Strom
I_{AC}	Alternating current (ripple current)	Wechselstrom
$I_{AC,RMS}$	Root-mean-square value of alternating current	Wechselstrom, Effektivwert
$I_{AC,f}$	Ripple current at frequency f	Wechselstrom bei Frequenz f
$I_{AC,max}$	Maximum permissible ripple current	Maximal zulässiger Wechselstrom
$I_{AC,R}$	Rated ripple current	Nennwechselstrom
I_{leak}	Leakage current	Reststrom
$I_{leak,op}$	Operating leakage current	Betriebsreststrom
l	Case length, nominal dimension	Gehäuselänge, Nennmaß
l_{max}	Maximum case length (without terminals and mounting stud)	Maximale Gehäuselänge (ohne Anschlüsse und Gewindebolzen)
R	Resistance	Widerstand
R_{ins}	Insulation resistance	Isolationswiderstand
R_{symm}	Balancing resistance	Symmetrierwiderstand
T	Temperature	Temperatur
ΔT	Temperature difference	Temperaturdifferenz
T_A	Ambient temperature	Umgebungstemperatur
T_C	Case temperature	Gehäusetemperatur
T_B	Capacitor base temperature	Temperatur des Gehäusebodens
t	Time	Zeit
Δt	Period	Zeitraum
t_b	Service life (operating hours)	Brauchbarkeitsdauer (Betriebszeit)

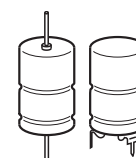

Symbol	English	German
V	Voltage	Spannung
V_F	Forming voltage	Formierspannung
V_{op}	Operating voltage	Betriebsspannung
V_R	Rated voltage, DC voltage	Nennspannung, Gleichspannung
V_S	Surge voltage	Spitzenspannung
X_C	Capacitive reactance	Kapazitiver Blindwiderstand
X_L	Inductive reactance	Induktiver Blindwiderstand
Z	Impedance	Scheinwiderstand
Z_T	Impedance at temperature T	Scheinwiderstand bei Temperatur T
$\tan \delta$	Dissipation factor	Verlustfaktor
λ	Failure rate	Ausfallrate
ϵ_0	Absolute permittivity	Elektrische Feldkonstante
ϵ_r	Relative permittivity	Dielektrizitätszahl
ω	Angular velocity; $2 \cdot \pi \cdot f$	Kreisfrequenz; $2 \cdot \pi \cdot f$

Note

All dimensions are given in mm.

Important notes

The following applies to all products named in this publication:

1. Some parts of this publication contain **statements about the suitability of our products for certain areas of application**. These statements are based on our knowledge of typical requirements that are often placed on our products in the areas of application concerned. We nevertheless expressly point out **that such statements cannot be regarded as binding statements about the suitability of our products for a particular customer application**. As a rule we are either unfamiliar with individual customer applications or less familiar with them than the customers themselves. For these reasons, it is always ultimately incumbent on the customer to check and decide whether a product with the properties described in the product specification is suitable for use in a particular customer application.
2. We also point out that **in individual cases, a malfunction of electronic components or failure before the end of their usual service life cannot be completely ruled out in the current state of the art, even if they are operated as specified**. In customer applications requiring a very high level of operational safety and especially in customer applications in which the malfunction or failure of an electronic component could endanger human life or health (e.g. in accident prevention or life-saving systems), it must therefore be ensured by means of suitable design of the customer application or other action taken by the customer (e.g. installation of protective circuitry or redundancy) that no injury or damage is sustained by third parties in the event of malfunction or failure of an electronic component.
3. **The warnings, cautions and product-specific notes must be observed.**
4. In order to satisfy certain technical requirements, **some of the products described in this publication may contain substances subject to restrictions in certain jurisdictions (e.g. because they are classed as hazardous)**. Useful information on this will be found in our Material Data Sheets on the Internet (www.tdk-electronics.tdk.com/material). Should you have any more detailed questions, please contact our sales offices.
5. We constantly strive to improve our products. Consequently, **the products described in this publication may change from time to time**. The same is true of the corresponding product specifications. Please check therefore to what extent product descriptions and specifications contained in this publication are still applicable before or when you place an order.

We also **reserve the right to discontinue production and delivery of products**. Consequently, we cannot guarantee that all products named in this publication will always be available. The aforementioned does not apply in the case of individual agreements deviating from the foregoing for customer-specific products.

6. Unless otherwise agreed in individual contracts, **all orders are subject to our General Terms and Conditions of Supply**.
7. **Our manufacturing sites serving the automotive business apply the IATF 16949 standard**. The IATF certifications confirm our compliance with requirements regarding the quality management system in the automotive industry. Referring to customer requirements and customer specific requirements ("CSR") TDK always has and will continue to have the policy of respecting individual agreements. Even if IATF 16949 may appear to support the acceptance of unilateral requirements, we hereby like to emphasize that **only requirements mutually agreed upon can and will be implemented in our Quality Management System**. For clarification purposes we like to point out that obligations from IATF 16949 shall only become legally binding if individually agreed upon.

Important notes

8. The trade names EPCOS, CeraCharge, CeraDiode, CeraLink, CeraPad, CeraPlas, CSMP, CTVS, DeltaCap, DigiSiMic, ExoCore, FilterCap, FormFit, LeaXield, MiniBlue, MiniCell, MKD, MKK, MotorCap, PCC, PhaseCap, PhaseCube, PhaseMod, PhiCap, PowerHap, PQSine, PQvar, SIFERRIT, SIFI, SIKOREL, SilverCap, SIMDAD, SiMic, SIMID, SineFormer, SIOV, ThermoFuse, WindCap are **trademarks registered or pending** in Europe and in other countries. Further information will be found on the Internet at www.tdk-electronics.tdk.com/trademarks.

Release 2018-10