

**Customer Part:**

**Description**

- 1.6 x 1.0mm SMD crystal in a hermetically sealed ceramic package.  
Suitable for real time clock applications.
- Model IQXC-90
- Model Issue number 1

**Frequency Parameters**

- Frequency 32.7680kHz
- Frequency Tolerance  $\pm 20.00\text{ppm}$
- Tolerance Condition @ 25°C  $\pm 5^\circ\text{C}$
- Overtone Order Fundamental
- Ageing  $\pm 3\text{ppm}$  max in 1st year @ 25°C  $\pm 3^\circ\text{C}$
- Frequency Stability Coefficient:  $-0.036 \pm 10\%/^\circ\text{C}^2$  typ

**Electrical Parameters**

- Load Capacitance (CL) 7.00pF
- Shunt Capacitance (C0) 1.2pF typ
- Drive Level 500nW max
- ESR 90.00k $\Omega$  max

**Environmental Parameters**

- Storage Temperature Range:  $-55$  to  $125^\circ\text{C}$
- Drop: 100g dummy, 150cm drop (3 directions x 10 times) onto concrete
- Vibration: 1.5mm amplitude, 10Hz-60Hz, 15mins in 3 mutually perpendicular planes, duration 2hrs each plane

**Compliance**

- RoHS Status (2015/863/EU) Compliant
- REACH Status Compliant
- MSL Rating (JDEC-STD-033): Not Applicable

**Packaging Details**

- Pack Style: Reel Tape & reel in accordance with EIA-481-D  
Pack Size: 5,000
- *Alternative packing option available*

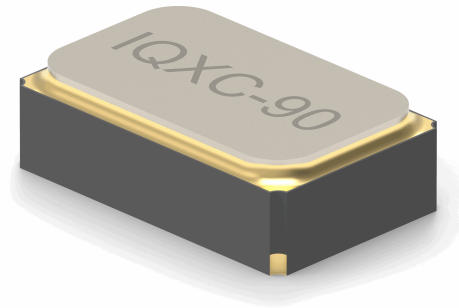

**Outline (mm)**

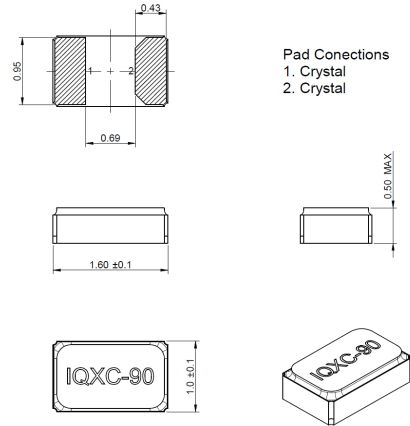

**Recommended Solder Pad Layout**

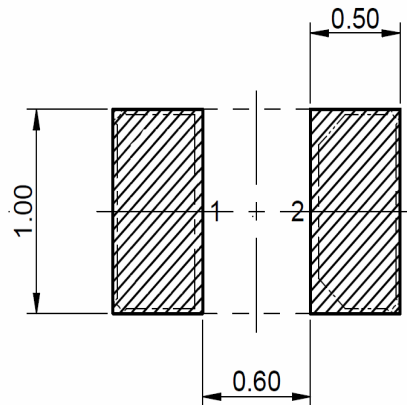

**Sales Office Contact Details:**

UK: +44 (0)1460 270200  
Germany: 0800 1808 443

France: 0800 901 383  
USA: +1.760.318.2824

Email: [info@iqdfrequencyproducts.com](mailto:info@iqdfrequencyproducts.com)  
Web: [www.iqdfrequencyproducts.com](http://www.iqdfrequencyproducts.com)

**Customer Part:**

**Frequency Stability Coefficient**

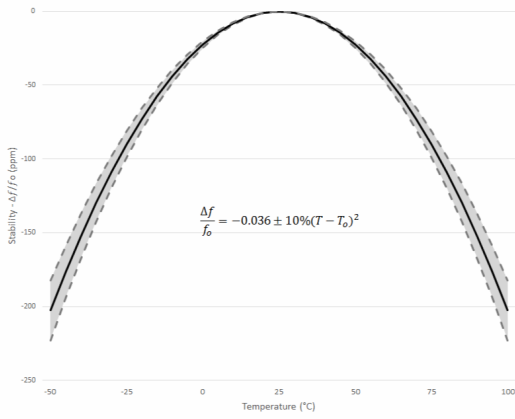

**Reflow Profile**

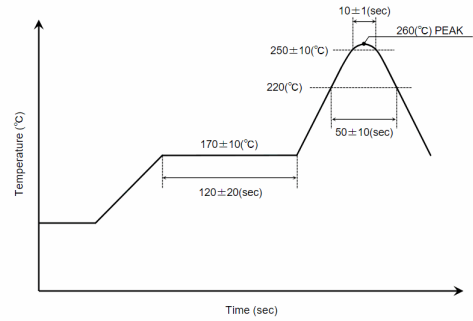

**Note:**  
 (1) The temperature used herein means the temperature on the circuit board.  
 (2) Reflow is permitted 2 times.

**Sales Office Contact Details:**

UK: +44 (0)1460 270200  
 Germany: 0800 1808 443

France: 0800 901 383  
 USA: +1.760.318.2824

Email: [info@iqdfrequencyproducts.com](mailto:info@iqdfrequencyproducts.com)  
 Web: [www.iqdfrequencyproducts.com](http://www.iqdfrequencyproducts.com)