

CRIMPING DIES
HEX 5.41-1.73 (M22520/5-11)

R282.235.011

Series : **OUT**

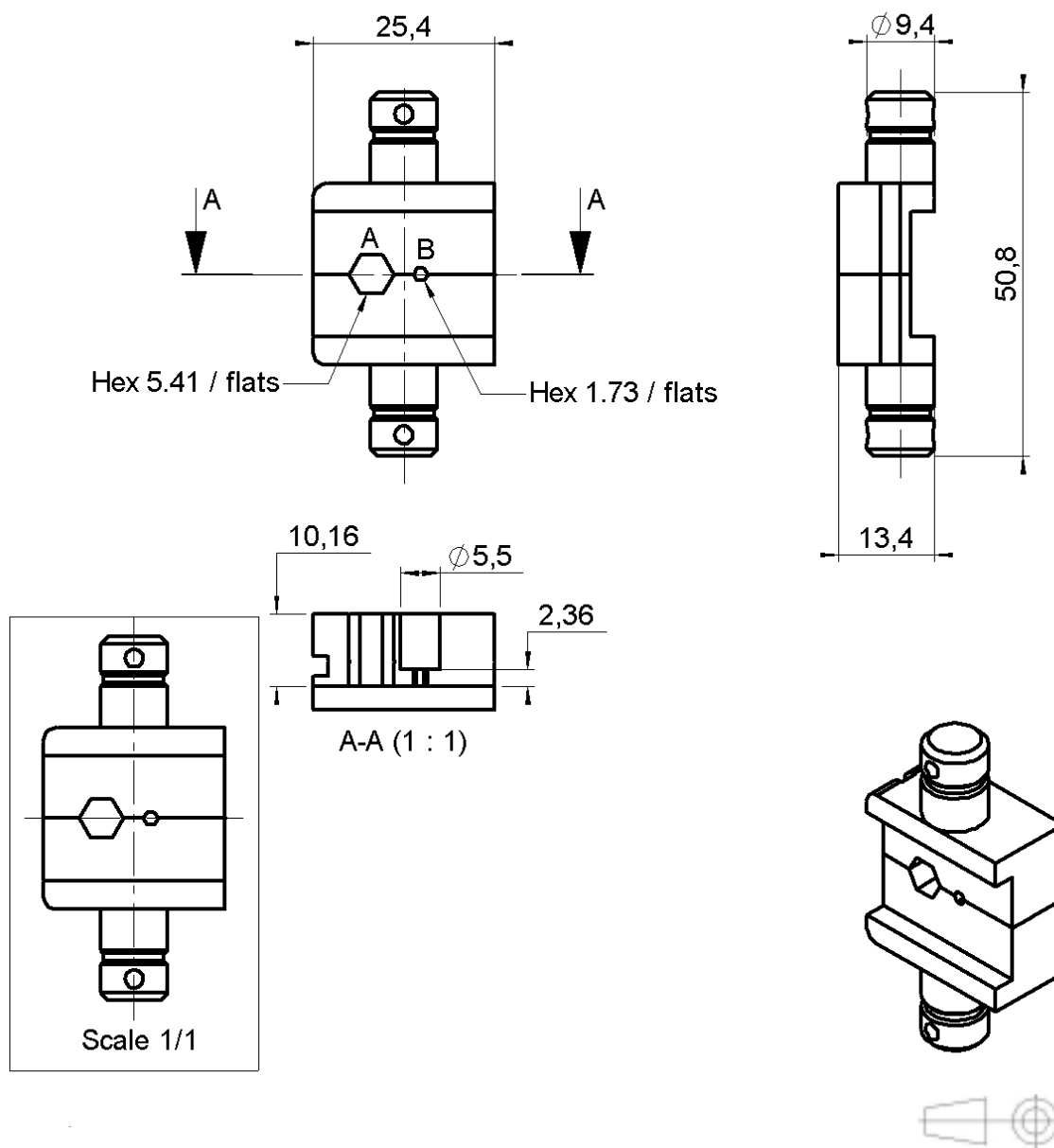

TO BE USED WITH CRIMPING TOOL :
 R282.293.000 (M 22520 / 5-01)

Issue : 0043 A

In the effort to improve our products, we reserve the right to make changes judged to be necessary.

