

SERIES: SWI3-E | **DESCRIPTION:** AC-DC POWER SUPPLY

FEATURES

- up to 3 W continuous power
- IEC 62368 compliant
- CoC Tier 2 compliant
- universal input voltage range
- ultra-compact case
- no load power consumption < 0.075 W
- over voltage, over current, and short circuit protections
- CE, GS safety approvals
- Class II construction



| MODEL | input voltage | input frequency | output voltage | output current | output power | ripple and noise ¹ | efficiency level ² | | no load power consumption |
|----------|---------------|-----------------|----------------|----------------|--------------|-------------------------------|-------------------------------|---------|---------------------------|
| | range (Vac) | range (Hz) | nom (Vdc) | max (A) | max (W) | max (mVp-p) | average ³ (%) | 10% (%) | typ (W) |
| SWI3-5-E | 90 ~ 264 | 47 ~ 63 | 5 | 0.6 | 3 | 150 | 74.9 | 66.2 | 0.05 |

Notes: 1. At full load, nominal AC input voltage, 25°C, 20 MHz bandwidth oscilloscope, output terminated with 0.1 µF and 10 µF capacitors to ground.
 2. CoC Tier 2 compliant.
 3. Average efficiency is measured at 25%, 50%, 75%, and 100% load.

PART NUMBER KEY

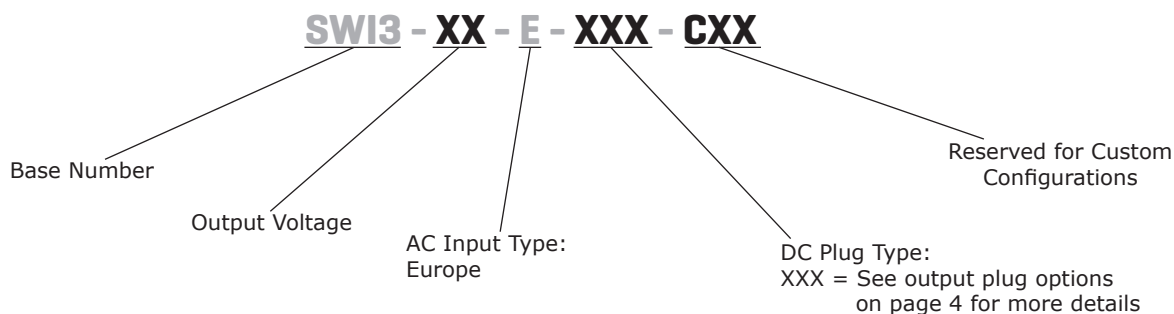

INPUT

| parameter | conditions/description | min | typ | max | units |
|---------------------------|--------------------------------------|-----|-----|-------|-------|
| voltage | | 90 | | 264 | Vac |
| frequency | | 47 | | 63 | Hz |
| current | at nominal input voltage | | | 0.2 | A |
| leakage current | at nominal input voltage & frequency | | | 0.25 | mA |
| no load power consumption | at 115/230 Vac, 60/50 Hz | | | 0.075 | W |

OUTPUT

| parameter | conditions/description | min | typ | max | units |
|-----------------|------------------------|-----|-----|-----|-------|
| line regulation | | 4.9 | | 5.4 | Vdc |
| load regulation | | 4.9 | | 5.4 | Vdc |
| start-up time | at 115 Vac | | | 3 | s |

PROTECTIONS

| parameter | conditions/description | min | typ | max | units |
|--------------------------|------------------------|-----|-----|-----|-------|
| over current protection | auto recovery | | | 1 | A |
| short circuit protection | | | | | |

SAFETY & COMPLIANCE

| parameter | conditions/description | min | typ | max | units |
|-------------------|---|--------|----------------|-----|------------|
| isolation voltage | input to output at 10 mA for 1 minute | | 3,000 4,242 | | Vac Vdc |
| safety approvals | GS (EN 62368) | | | | |
| EMI/EMC | CE (EN 55032, CISPR 32, EN 61000-3-2, EN 61000-3-3, EN 55024, CISPR 24) | | | | |
| MTBF | as per Telcordia SR-332 (Issue 2), at 115/230 Vac, full load, 0°C~40°C | 50,000 | | | hours |
| RoHS | 2011/65/EU | | | | |

ENVIRONMENTAL

| parameter | conditions/description | min | typ | max | units |
|-----------------------|------------------------|-----|-----|-----|-------|
| operating temperature | | 0 | | 40 | °C |
| storage temperature | | -20 | | 60 | °C |
| operating humidity | non-condensing | 20 | | 85 | % |
| storage humidity | non-condensing | 5 | | 95 | % |

MECHANICAL

| parameter | conditions/description | min | typ | max | units |
|------------|------------------------|-----|-----|-----|-------|
| dimensions | 54.0 x 29.5 x 56.0 | | | | mm |
| inlet plug | Europe | | | | |
| weight | | | 51 | | g |

MECHANICAL DRAWING

units: mm

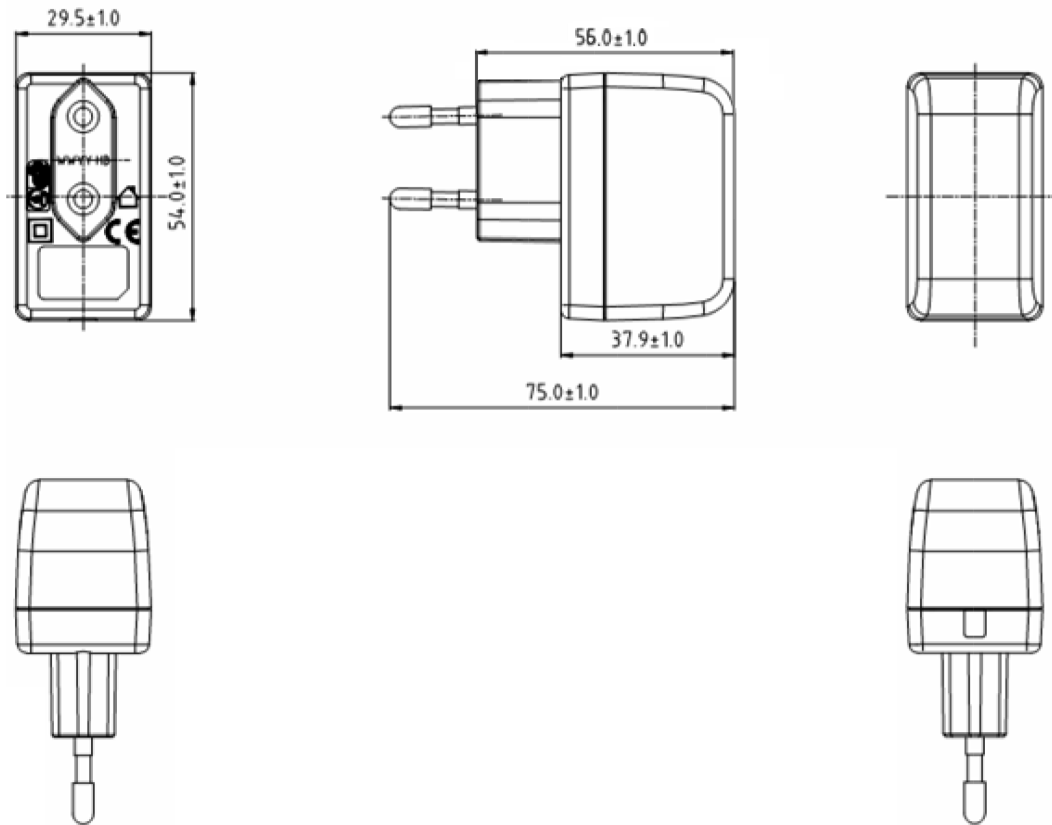

DC CORD

units: mm

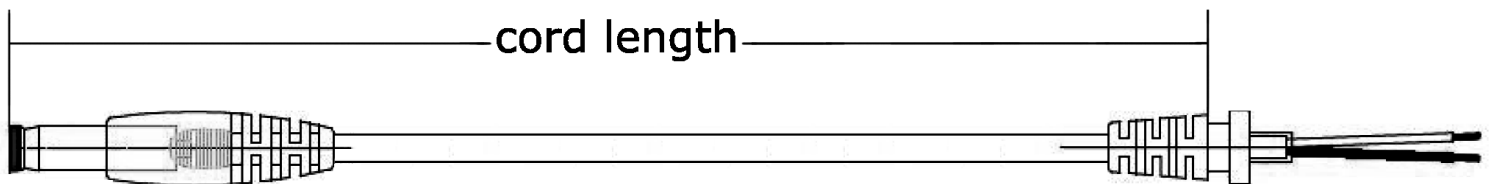

Table 1

| MODEL NO. | CABLE | CORD LENGTH |
|-----------|----------------|-------------------|
| SWI3-5-E | UL1185, 24 AWG | 1,500 mm \pm 50 |

DC PLUG TYPE PART NUMBER KEY

XXX

Plug Polarity:
P = Center Positive
N = Center Negative

Plug Code:
X = Choose a code from the options below

Plug Angle:
"blank" = Straight
R = Right Angle

| Plug Polarity | | Code | | Dimensions (mm) | | | Plug Angle | |
|---------------|-------------|--------|-------------------|------------------|------|-----|------------|-------|
| Center Pos. | Center Neg. | Option | Type | A | B | C | Straight | Right |
| • | • | 5 | Standard | 5.5 | 2.1 | 9.5 | • | • |
| • | • | 6 | Standard | 5.5 | 2.5 | 9.5 | • | • |
| • | • | 7 | Standard | 3.5 | 1.35 | 9.5 | • | • |
| • | • | 8 | Standard | 3.8 | 1.35 | 9.5 | • | • |
| • | • | 9 | Standard | 3.8 | 1.05 | 9.5 | • | • |
| • | • | 10 | Locking | 5.5 | 2.1 | 9.5 | • | N/A |
| • | • | 11 | Locking | 5.5 | 2.5 | 9.5 | • | N/A |
| • | • | 12 | EIAJ-1 | 2.35 | 0.7 | 9.5 | • | • |
| • | • | 13 | EIAJ-2 | 4.0 | 1.7 | 9.5 | • | • |
| • | • | 14 | EIAJ-3 | 4.75 | 1.7 | 9.5 | • | • |
| N/A | N/A | ST | Stripped & Tinned | | | | N/A | N/A |
| N/A | N/A | MUB | USB | Micro USB Type B | | | • | N/A |

Note: 1. Contact CUI for additional plug options

Standard

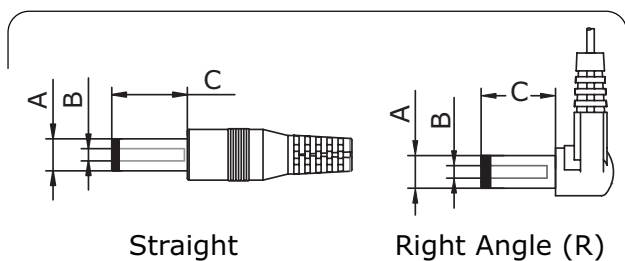

EIAJ

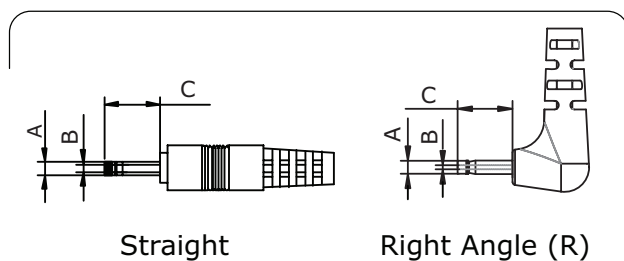

Locking



Stripped & Tinned

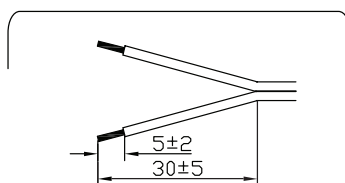

USB

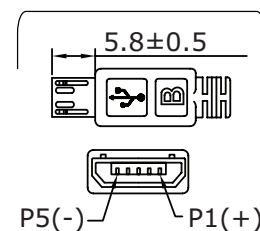

REVISION HISTORY

| rev. | description | date |
|------|------------------------------|------------|
| 1.0 | initial release | 09/14/2017 |
| 1.01 | company logo updated | 09/21/2020 |
| 1.02 | logo and model table updated | 11/27/2020 |
| 1.03 | safety line updated | 12/09/2020 |

The revision history provided is for informational purposes only and is believed to be accurate.



CUI INC

a bel group

Headquarters
20050 SW 112th Ave.
Tualatin, OR 97062
800.275.4899

Fax 503.612.2383
cui.com
techsupport@cui.com

This device complies with part 15 of the FCC Rules. Operation is subject to the following two conditions:

- (1) This device may not cause harmful interference, and
- (2) this device must accept any interference received, including interference that may cause undesired operation.

CUI offers a one (1) year limited warranty. Complete warranty information is listed on our website.

CUI reserves the right to make changes to the product at any time without notice. Information provided by CUI is believed to be accurate and reliable. However, no responsibility is assumed by CUI for its use, nor for any infringements of patents or other rights of third parties which may result from its use.

CUI products are not authorized or warranted for use as critical components in equipment that requires an extremely high level of reliability. A critical component is any component of a life support device or system whose failure to perform can be reasonably expected to cause the failure of the life support device or system, or to affect its safety or effectiveness.