

LENA-S

~11° spot beam

TECHNICAL SPECIFICATIONS:

| | |
|-----------------|--------------------|
| Dimensions | Ø 111.0 mm |
| Height | 80 mm |
| Fastening | socket |
| Colour | metal |
| Box size | 400 x 280 x 380 mm |
| Box weight | 3.8 kg |
| Quantity in Box | 60 pcs |
| ROHS compliant | yes ⓘ |



MATERIAL SPECIFICATIONS:

| Component | Type | Material | Colour | Coating |
|-----------|-----------|----------|--------|---------|
| LENA-S | Reflector | PC | metal | lacquer |

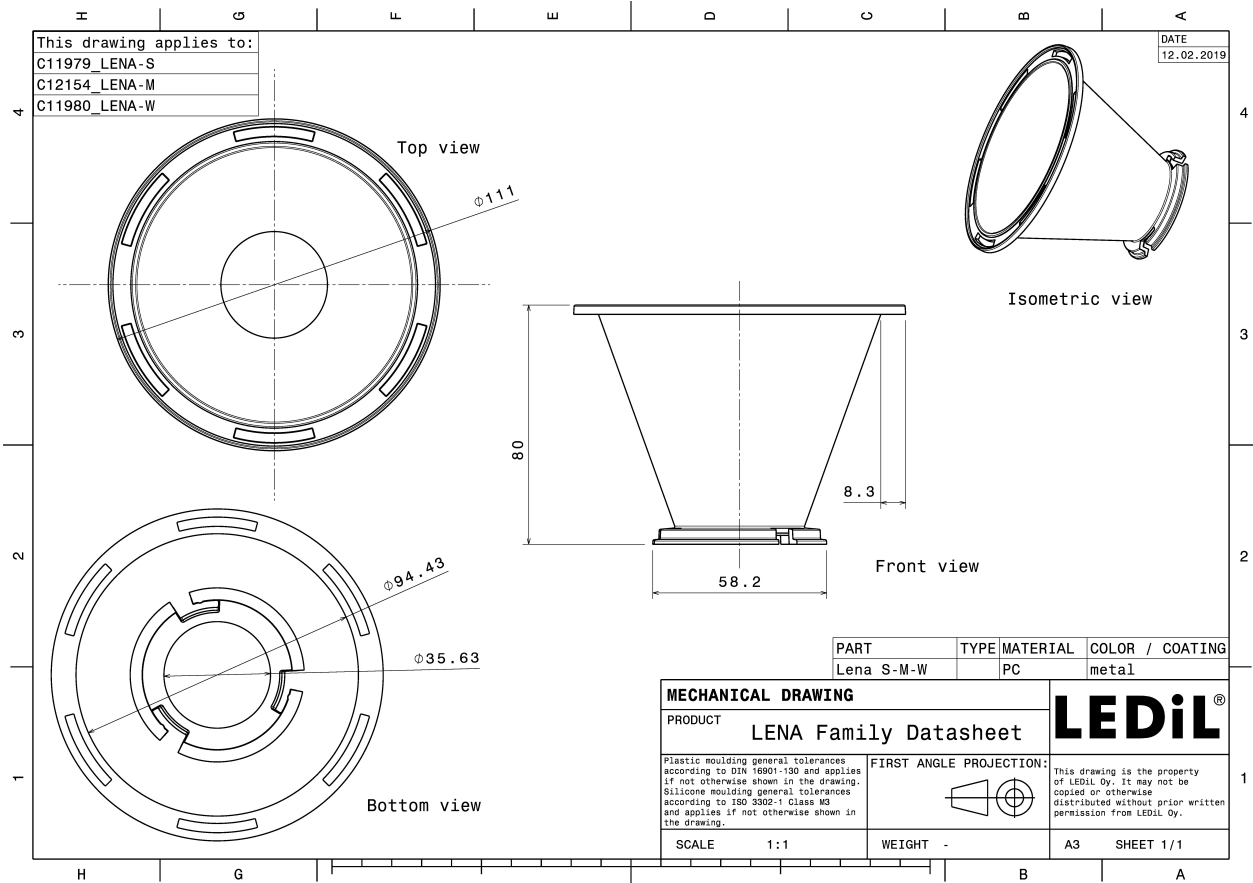

PHOTOMETRIC DATA (MEASURED):

bridgelux.

LED BXRA ES Rectangle
 FWHM 11.0°
 Efficiency 78 %
 Peak intensity cd/lm
 LEDs/each optic 1
 Light colour White
 Required components:
 C12153_LENA-STD-BASE-BXRA
 C11996_LENA-LENS

bridgelux.

LED BXRA RS
 FWHM 20.0°
 Efficiency 80 %
 Peak intensity cd/lm
 LEDs/each optic 1
 Light colour White
 Required components:
 C12229_LENA-STD-BASE-RS
 C11996_LENA-LENS

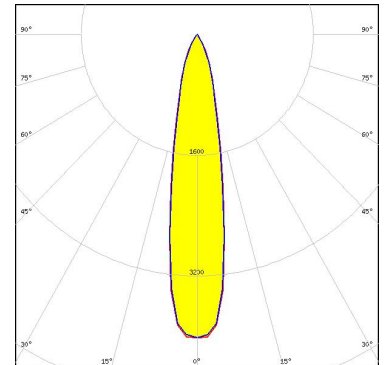

bridgelux.

LED V10 Gen6
 FWHM 9.0°
 Efficiency 76 %
 Peak intensity 12.110 cd/lm
 LEDs/each optic 1
 Light colour White
 Required components:
 C13186_LENA-STD-BASE-CXA15
 C11996_LENA-LENS

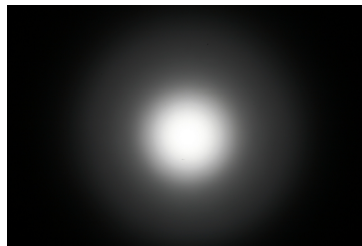



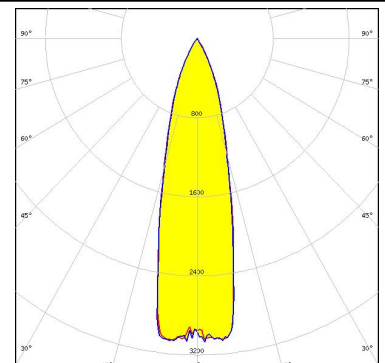
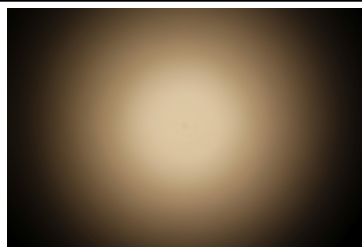

bridgelux.

LED Vero SE 29
 FWHM 27.0°
 Efficiency 87 %
 Peak intensity 3.100 cd/lm
 LEDs/each optic 1
 Light colour White
 Required components:
 C15083_LENA-STD-BASE-VERO29

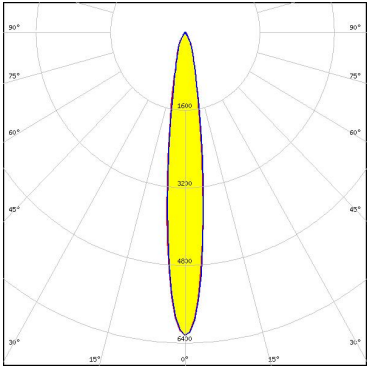

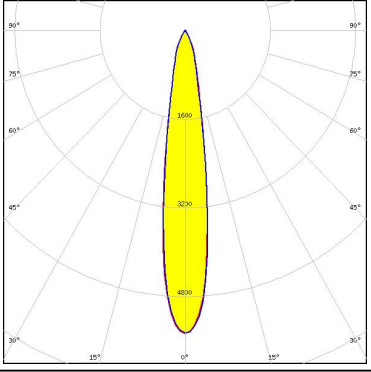
PHOTOMETRIC DATA (MEASURED):

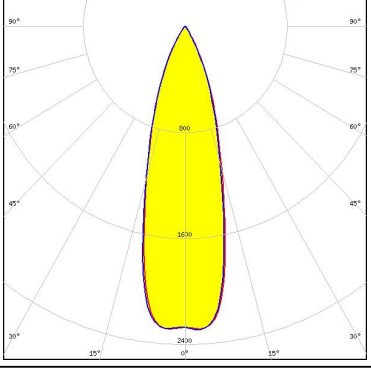
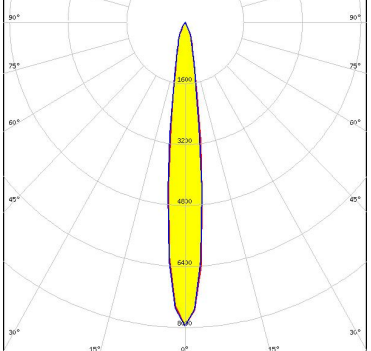
| | | |
|--|--|---|
| <p>bridgelux.</p> <p>LED VERO13 FWHM 14.0° Efficiency 83 % Peak intensity 6.250 cd/lm LEDs/each optic 1 Light colour White</p> <p>Required components: C13868_LENA-STD-BASE-VERO13-18 C11996_LENA-LENS</p> |  |  |
| <p>bridgelux.</p> <p>LED VERO18 FWHM 17.0° Efficiency 83 % Peak intensity 5.500 cd/lm LEDs/each optic 1 Light colour White</p> <p>Required components: C13868_LENA-STD-BASE-VERO13-18 C11996_LENA-LENS</p> |  |  |
| <p>bridgelux.</p> <p>LED VERO29 FWHM 30.0° Efficiency 80 % Peak intensity 2.300 cd/lm LEDs/each optic 1 Light colour White</p> <p>Required components: C13867_LENA-STD-BASE-VERO29</p> |  |  |
| <h3>CITIZEN</h3> <p>LED CL-L340 FWHM 14.0° Efficiency 79 % Peak intensity 8.000 cd/lm LEDs/each optic 1 Light colour White</p> <p>Required components: C11995_LENA-STD-BASE-CL340 C11996_LENA-LENS</p> | |  |

PHOTOMETRIC DATA (MEASURED):

CITIZEN

LED CL-L340
 FWHM 11.0°
 Efficiency 84 %
 Peak intensity 10.100 cd/lm
 LEDs/each optic 1
 Light colour White
 Required components:
 C11995_LENA-STD-BASE-CL340

CITIZEN

LED CL-L340
 FWHM 11.0°
 Efficiency 86 %
 Peak intensity 11.450 cd/lm
 LEDs/each optic 1
 Light colour White
 Required components:
 C11995_LENA-STD-BASE-CL340

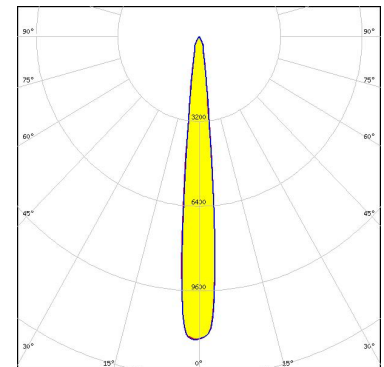

CITIZEN

LED CLL02x/CLU02x (LES10)
 FWHM 10.0°
 Efficiency 80 %
 Peak intensity 11.500 cd/lm
 LEDs/each optic 1
 Light colour White
 Required components:
 C13868_LENA-STD-BASE-VERO13-18
 C11996_LENA-LENS
 Bender Wirth: 434 Typ L1

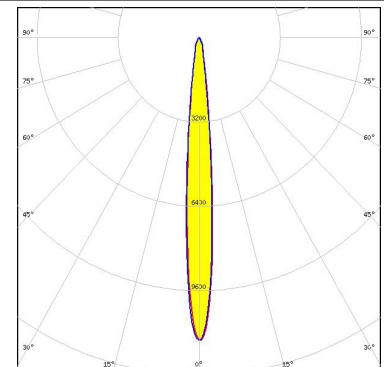
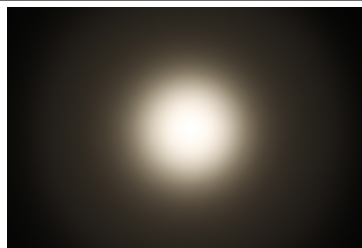

CITIZEN

LED CLL02x/CLU02x (LES10)
 FWHM 8.0°
 Efficiency 85 %
 Peak intensity 26.500 cd/lm
 LEDs/each optic 1
 Light colour White
 Required components:
 C13868_LENA-STD-BASE-VERO13-18
 Bender Wirth: 434 Typ L1

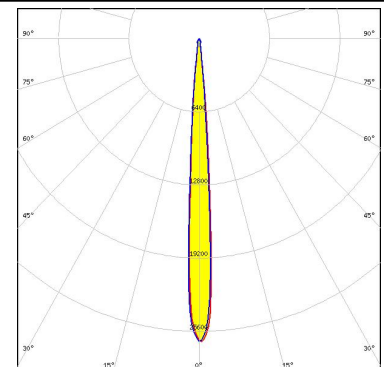

PHOTOMETRIC DATA (MEASURED):

CITIZEN

LED CLL03x/CLU03x
 FWHM 13.0°
 Efficiency 78 %
 Peak intensity 6.400 cd/lm
 LEDs/each optic 1
 Light colour White
 Required components:
 A.A.G. STUCCHI: 8101/G2 + S-8000/11

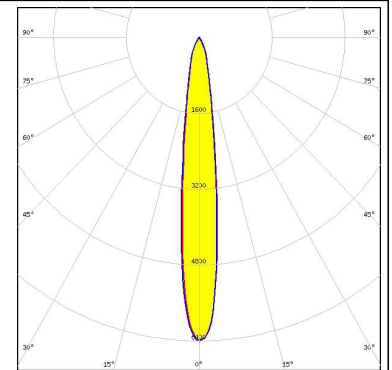
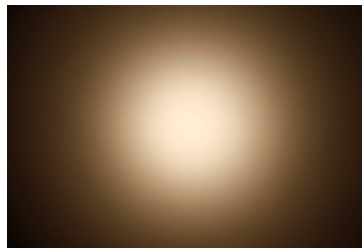

CITIZEN

LED CLL03x/CLU03x
 FWHM 13.0°
 Efficiency 80 %
 Peak intensity 7.600 cd/lm
 LEDs/each optic 1
 Light colour White
 Required components:
 C12691_LENA-STD-BASE-CLL030
 C11996_LENA-LENS

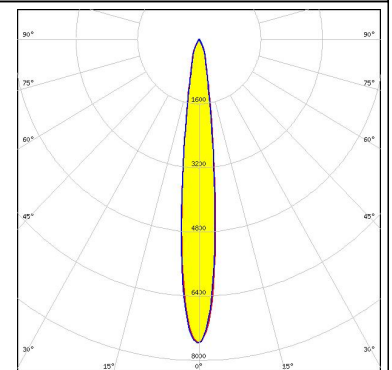
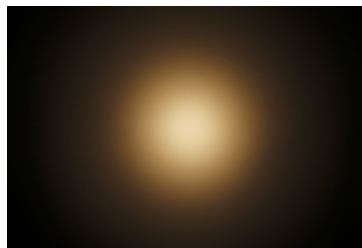

CITIZEN

LED CLL03x/CLU03x
 FWHM 14.0°
 Efficiency 80 %
 Peak intensity 6.700 cd/lm
 LEDs/each optic 1
 Light colour White
 Required components:
 C13868_LENA-STD-BASE-VERO13-18
 C11996_LENA-LENS
 Bender Wirth: 433 Typ L1

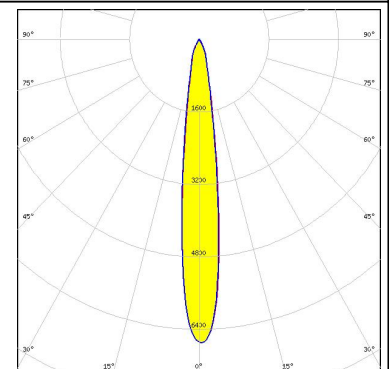
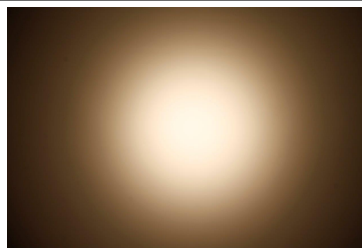

CITIZEN

LED CLL03x/CLU03x
 FWHM 11.0°
 Efficiency 85 %
 Peak intensity 13.000 cd/lm
 LEDs/each optic 1
 Light colour White
 Required components:
 C12691_LENA-STD-BASE-CLL030

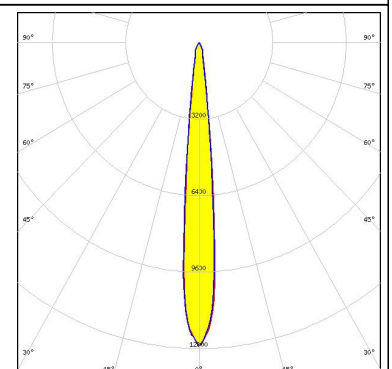
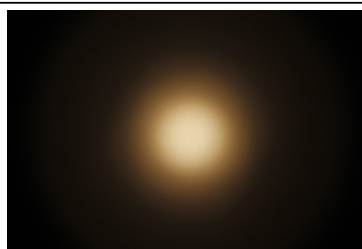

PHOTOMETRIC DATA (MEASURED):

CITIZEN

LED CLL04x/CLU04x
 FWHM 19.0°
 Efficiency 81 %
 Peak intensity 3.600 cd/lm
 LEDs/each optic 1
 Light colour White
 Required components:
 IDEAL: 50-2204CT + 50-2100LN

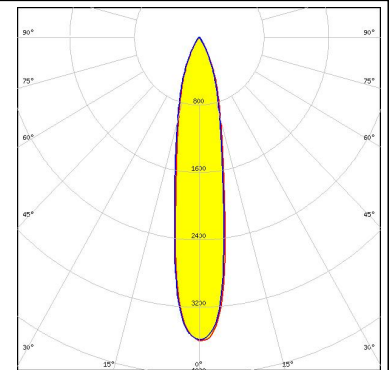

CITIZEN

LED CLL04x/CLU04x
 FWHM 15.0°
 Efficiency 84 %
 Peak intensity 5.250 cd/lm
 LEDs/each optic 1
 Light colour White
 Required components:
 C12692_LENA-STD-BASE-CLL040



CITIZEN

LED CLL04x/CLU04x
 FWHM 16.0°
 Efficiency 79 %
 Peak intensity 3.820 cd/lm
 LEDs/each optic 1
 Light colour White
 Required components:
 C12692_LENA-STD-BASE-CLL040
 C11996_LENA-LENS

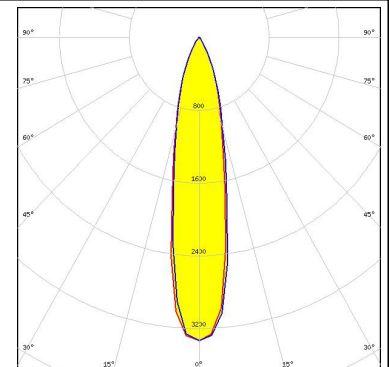
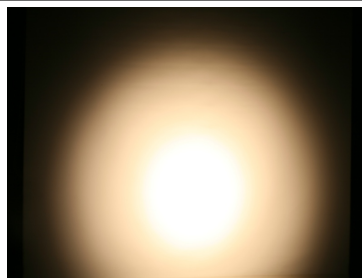

CITIZEN

LED CLL04x/CLU04x
 FWHM 21.0°
 Efficiency 80 %
 Peak intensity 3.400 cd/lm
 LEDs/each optic 1
 Light colour White
 Required components:
 C13867_LENA-STD-BASE-VERO29
 Bender Wirth: 431 Typ L3

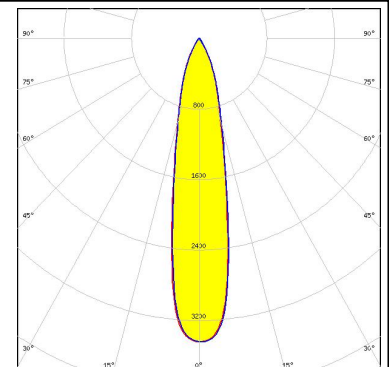
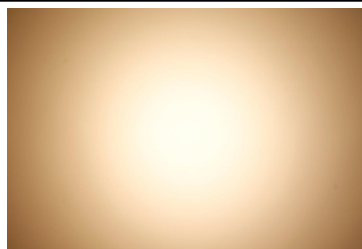

PHOTOMETRIC DATA (MEASURED):

CITIZEN

LED CLL04x/CLU04x
 FWHM 17.0°
 Efficiency 78 %
 Peak intensity 4.800 cd/lm
 LEDs/each optic 1
 Light colour White
 Required components:
 A.A.G. STUCCHI: 8102/G2 + S-8000/12

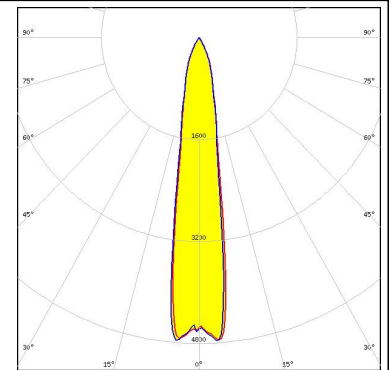

CITIZEN

LED CLL04x/CLU04x
 FWHM 16.0°
 Efficiency 85 %
 Peak intensity 5.200 cd/lm
 LEDs/each optic 1
 Light colour White
 Required components:
 IDEAL: 50-2204CT + 50-2100LN

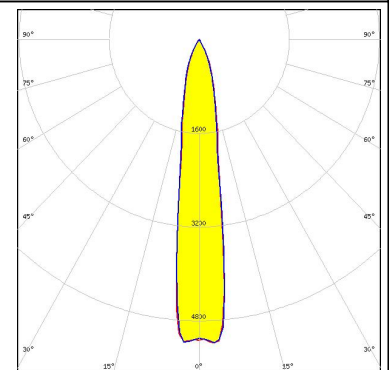

CITIZEN

LED CLL04x/CLU04x
 FWHM 23.0°
 Efficiency 73 %
 Peak intensity 2.500 cd/lm
 LEDs/each optic 1
 Light colour White
 Required components:
 A.A.G. STUCCHI: 8102/G2 + S-8000/12

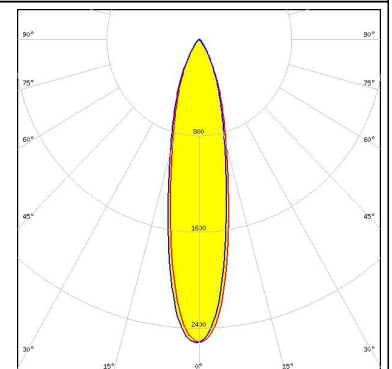
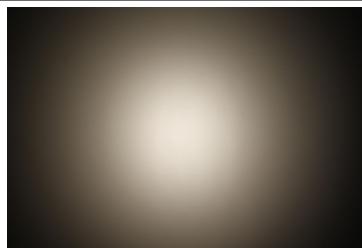

CITIZEN

LED CLU700/701
 FWHM 8.0°
 Efficiency 80 %
 Peak intensity 17.500 cd/lm
 LEDs/each optic 1
 Light colour White
 Required components:
 C13868_LENA-STD-BASE-VERO13-18
 C11996_LENA-LENS
 Bender Wirth: 434 Typ L1

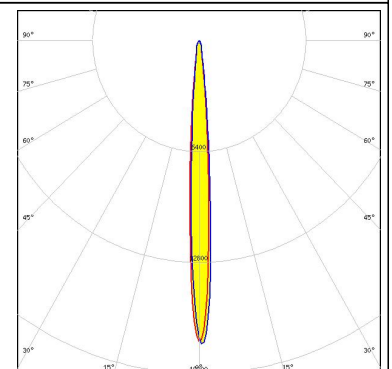

PHOTOMETRIC DATA (MEASURED):

CITIZEN

LED CLU700/701
 FWHM 5.0°
 Efficiency 87 %
 Peak intensity 61.400 cd/lm
 LEDs/each optic 1
 Light colour White
 Required components:
 C13868_LENA-STD-BASE-VERO13-18
 Bender Wirth: 434 Typ L1

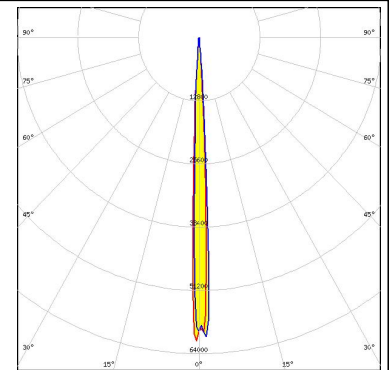

CITIZEN

LED CLU710/711
 FWHM 7.0°
 Efficiency 90 %
 Peak intensity 30.000 cd/lm
 LEDs/each optic 1
 Light colour White
 Required components:
 C12691_LENA-STD-BASE-CLL030

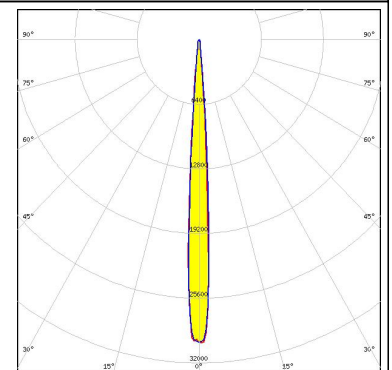

CITIZEN

LED CLU710/711
 FWHM 9.0°
 Efficiency 83 %
 Peak intensity 12.000 cd/lm
 LEDs/each optic 1
 Light colour White
 Required components:
 C12691_LENA-STD-BASE-CLL030
 C11996_LENA-LENS

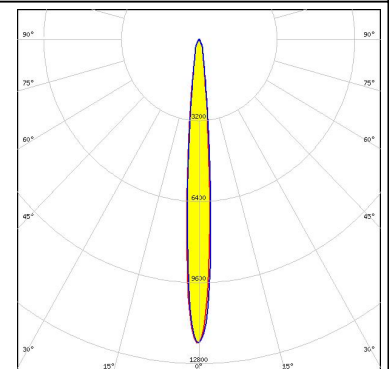
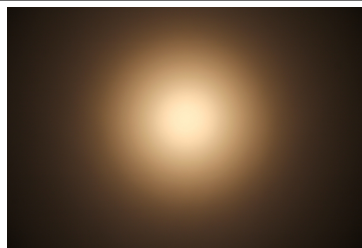

CITIZEN

LED CLU720/721
 FWHM 9.0°
 Efficiency 85 %
 Peak intensity 18.700 cd/lm
 LEDs/each optic 1
 Light colour White
 Required components:
 C12691_LENA-STD-BASE-CLL030

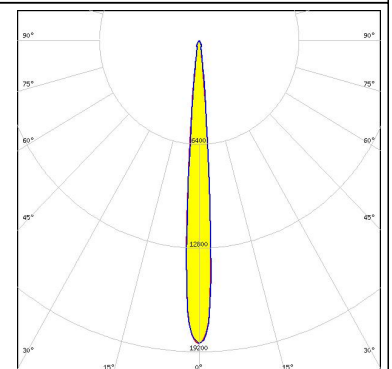
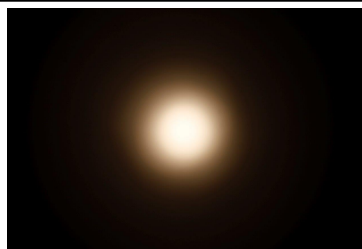

PHOTOMETRIC DATA (MEASURED):

CITIZEN

LED CLU720/721
 FWHM 11.0°
 Efficiency 79 %
 Peak intensity 8.600 cd/lm
 LEDs/each optic 1
 Light colour White
 Required components:
 C12691_LENA-STD-BASE-CLL030
 C11996_LENA-LENS

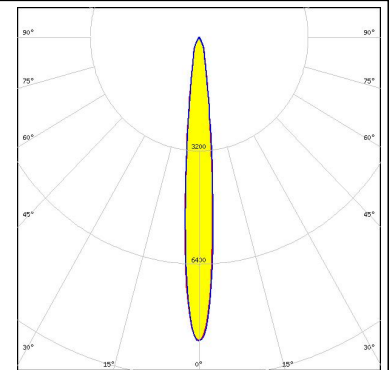

CITIZEN

LED CLU730/731
 FWHM 10.0°
 Efficiency 82 %
 Peak intensity 12.400 cd/lm
 LEDs/each optic 1
 Light colour White
 Required components:
 C12692_LENA-STD-BASE-CLL040

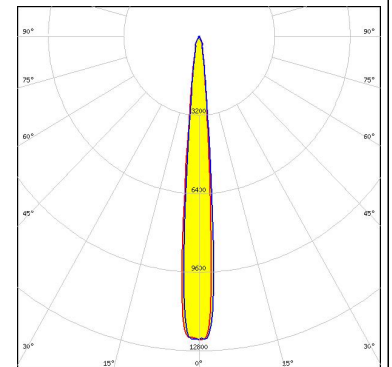

CREE

LED CMA1840
 FWHM 11.0°
 Efficiency 88 %
 Peak intensity 12.000 cd/lm
 LEDs/each optic 1
 Light colour White
 Required components:
 C14146_LENA-STD-BASE-CXA18

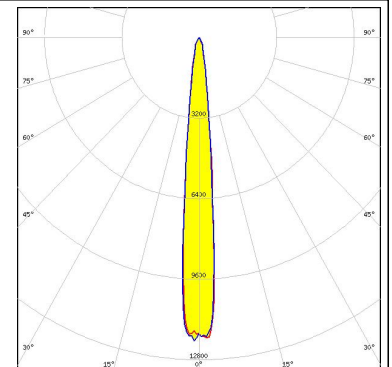
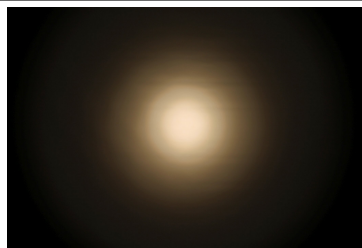

CREE

LED CMA2550
 FWHM 14.0°
 Efficiency 86 %
 Peak intensity 6.900 cd/lm
 LEDs/each optic 1
 Light colour White
 Required components:
 C13324_LENA-STD-BASE-CXA25

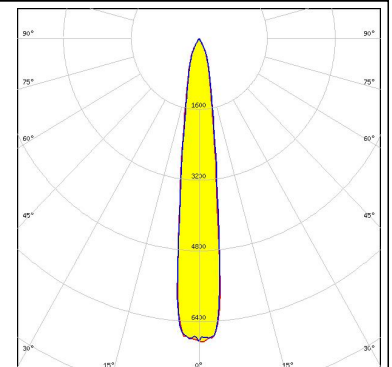
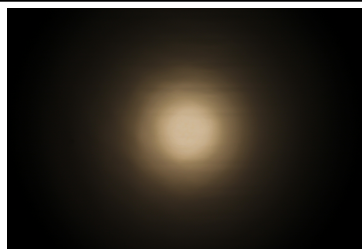

PHOTOMETRIC DATA (MEASURED):

CREE 

LED CMT14xx
 FWHM 8.0°
 Efficiency 88 %
 Peak intensity 24.050 cd/lm
 LEDs/each optic 1
 Light colour White
 Required components:
 C13868_LENA-STD-BASE-VERO13-18
 Bender Wirth: 434 Typ L1

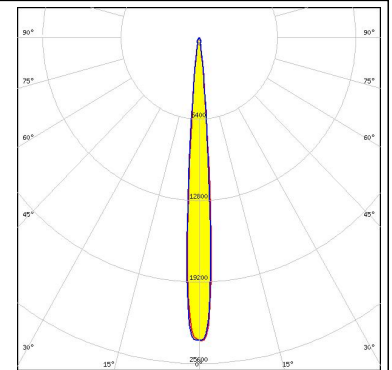
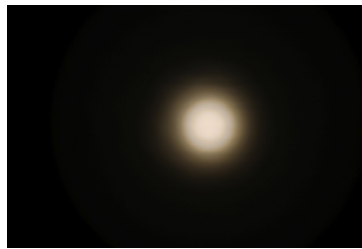

CREE 

LED CMT19xx
 FWHM 12.0°
 Efficiency 88 %
 Peak intensity 11.429 cd/lm
 LEDs/each optic 1
 Light colour White
 Required components:
 C12691_LENA-STD-BASE-CLL030

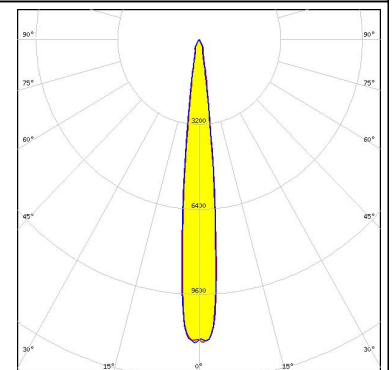

CREE 

LED CMT19xx
 FWHM 12.0°
 Efficiency 87 %
 Peak intensity 11.312 cd/lm
 LEDs/each optic 1
 Light colour White
 Required components:
 C13868_LENA-STD-BASE-VERO13-18
 Bender Wirth: 477 Typ L1

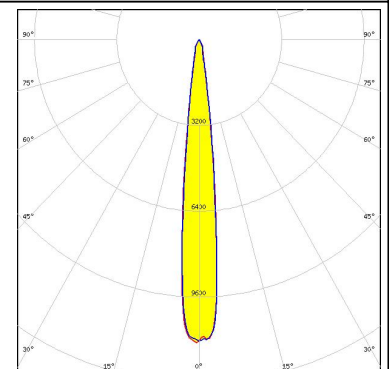
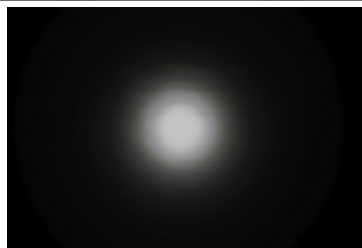

CREE 

LED CXA/B 15xx
 FWHM 8.0°
 Efficiency 80 %
 Peak intensity 16.500 cd/lm
 LEDs/each optic 1
 Light colour White
 Required components:
 C13868_LENA-STD-BASE-VERO13-18
 C11996_LENA-LENS
 Bender Wirth: 441 Typ L1

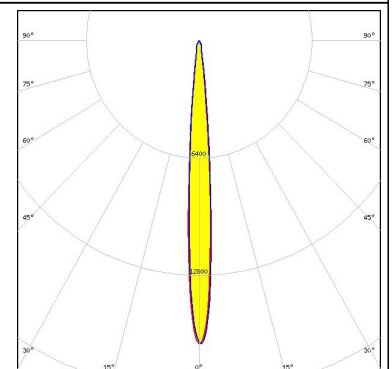

PHOTOMETRIC DATA (MEASURED):



LED CXA/B 15xx
 FWHM 7.0°
 Efficiency 86 %
 Peak intensity 31.300 cd/lm
 LEDs/each optic 1
 Light colour White
 Required components:
 C13868_LENA-STD-BASE-VERO13-18
 Bender Wirth: 441 Typ L1

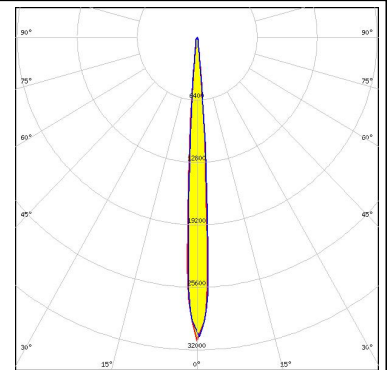

LED CXA/B 15xx
 FWHM 8.0°
 Efficiency 81 %
 Peak intensity 15.500 cd/lm
 LEDs/each optic 1
 Light colour White
 Required components:
 C13186_LENA-STD-BASE-CXA15
 C11996_LENA-LENS

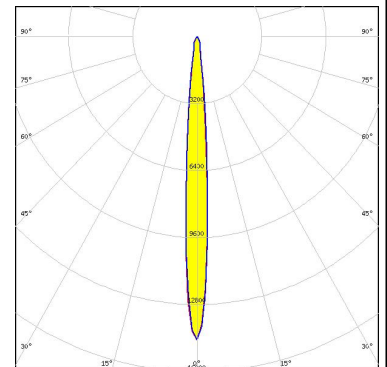

LED CXA/B 15xx
 FWHM 7.0°
 Efficiency 87 %
 Peak intensity 30.120 cd/lm
 LEDs/each optic 1
 Light colour White
 Required components:
 C13186_LENA-STD-BASE-CXA15

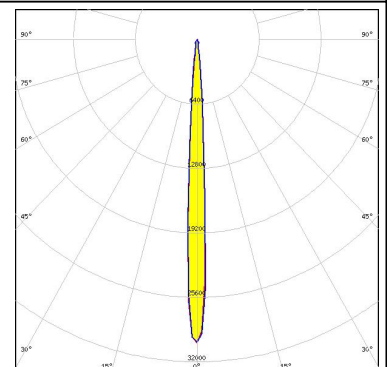

LED CXA/B 1816 & CXA/B 1820 & CXA 1850
 FWHM 10.0°
 Efficiency 87 %
 Peak intensity 17.600 cd/lm
 LEDs/each optic 1
 Light colour White
 Required components:
 C13868_LENA-STD-BASE-VERO13-18
 Bender Wirth: 437 Typ L1

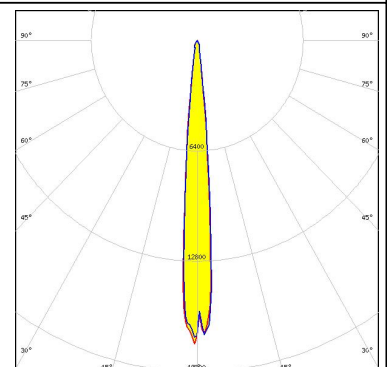

PHOTOMETRIC DATA (MEASURED):



LED CXA/B 1816 & CXA/B 1820 & CXA 1850
 FWHM 12.0°
 Efficiency 82 %
 Peak intensity 8.600 cd/lm
 LEDs/each optic 1
 Light colour White
 Required components:
 C13868_LENA-STD-BASE-VERO13-18
 C11996_LENA-LENS
 Bender Wirth: 437 Typ L1

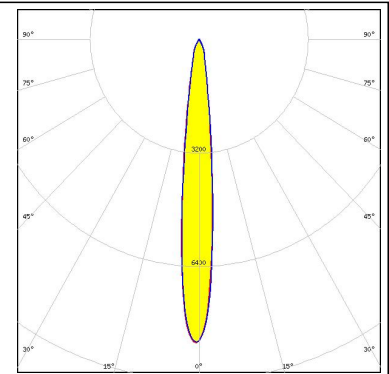

LED CXA/B 1830
 FWHM 18.0°
 Efficiency 75 %
 Peak intensity 2.300 cd/lm
 LEDs/each optic 1
 Light colour White
 Required components:
 C13868_LENA-STD-BASE-VERO13-18
 C12231_LENA-FRESNEL-LENS
 Bender Wirth: 437 Typ L1

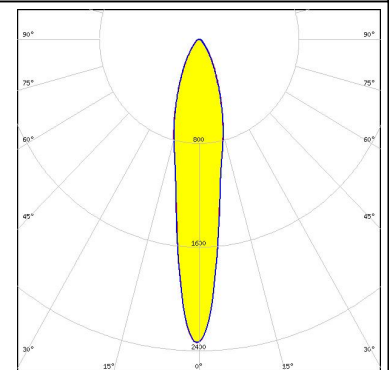
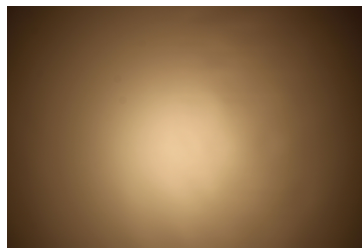

LED CXA/B 1830
 FWHM 12.0°
 Efficiency 87 %
 Peak intensity 11.900 cd/lm
 LEDs/each optic 1
 Light colour White
 Required components:
 C13868_LENA-STD-BASE-VERO13-18
 Bender Wirth: 437 Typ L1

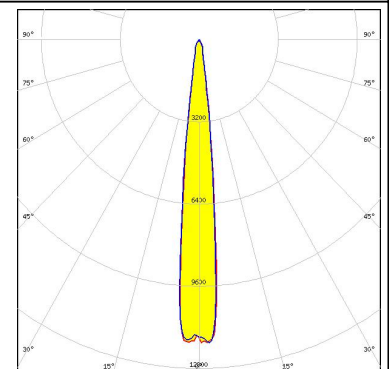
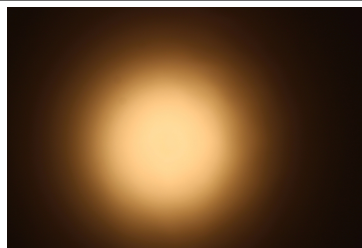

LED CXA/B 1830
 FWHM 12.0°
 Efficiency 82 %
 Peak intensity 10.300 cd/lm
 LEDs/each optic 1
 Light colour White
 Required components:
 C13868_LENA-STD-BASE-VERO13-18
 C14169_LENA-CLEAR-LENS
 Bender Wirth: 437 Typ L1

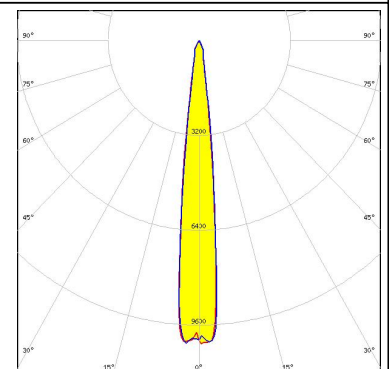
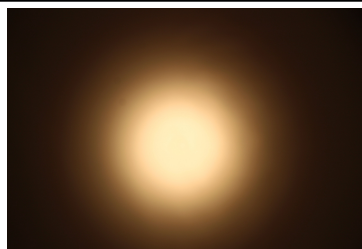

PHOTOMETRIC DATA (MEASURED):

CREE

LED CXA/B 25xx
 FWHM 13.0°
 Efficiency 79 %
 Peak intensity 5.900 cd/lm
 LEDs/each optic 1
 Light colour White
 Required components:
 C13324_LENA-STD-BASE-CXA25
 C11996_LENA-LENS

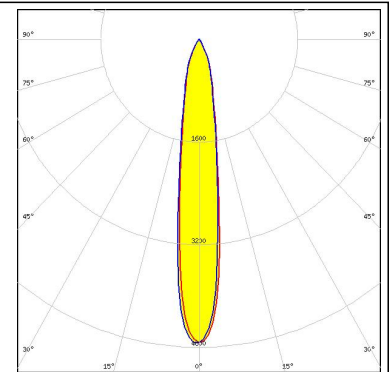

CREE

LED CXA/B 25xx
 FWHM 13.0°
 Efficiency 84 %
 Peak intensity 8.000 cd/lm
 LEDs/each optic 1
 Light colour White
 Required components:
 C13324_LENA-STD-BASE-CXA25

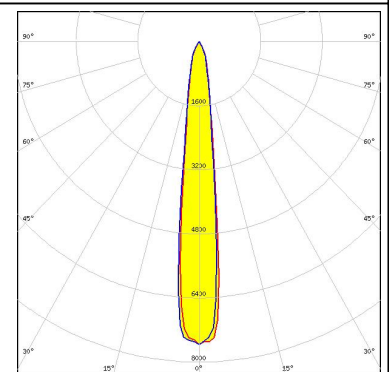

CREE

LED CXA2011
 FWHM 11.0°
 Efficiency 80 %
 Peak intensity cd/lm
 LEDs/each optic 1
 Light colour White
 Required components:
 C12105_LENA-STD-BASE-CXA20
 C11996_LENA-LENS

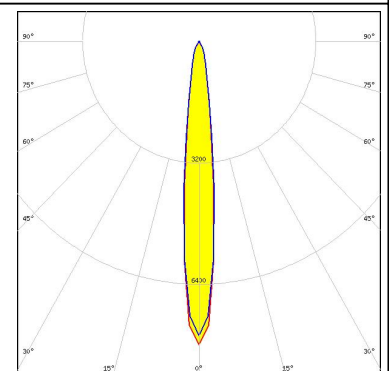

EVERLIGHT

LED CHI3030 19W
 FWHM 20.0°
 Efficiency 86 %
 Peak intensity 4.100 cd/lm
 LEDs/each optic 1
 Light colour White
 Required components:
 C13867_LENA-STD-BASE-VERO29
 Bender Wirth: 468 Typ L3

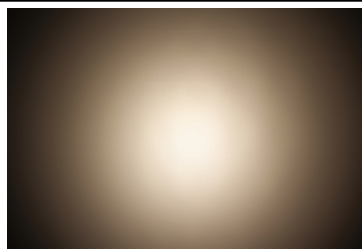

PHOTOMETRIC DATA (MEASURED):

EVERLIGHT

LED CHI3030 29W
 FWHM 25.0°
 Efficiency 80 %
 Peak intensity 2.700 cd/lm
 LEDs/each optic 1
 Light colour White
 Required components:
 C13867_LENA-STD-BASE-VERO29
 Bender Wirth: 468 Typ L3

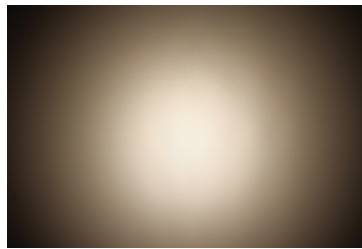

LUMILEDS

LED LUXEON CoB 1202/1203
 FWHM 7.0°
 Efficiency 87 %
 Peak intensity 28.300 cd/lm
 LEDs/each optic 1
 Light colour White
 Required components:
 C13868_LENA-STD-BASE-VERO13-18
 Bender Wirth: 438 Typ L1

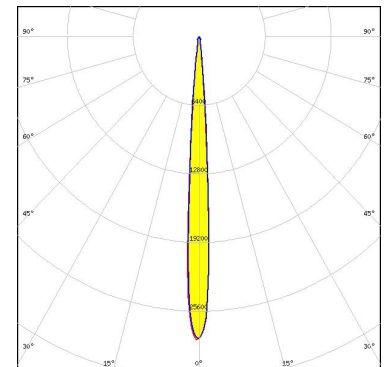

LUMILEDS

LED LUXEON CoB 1204/1205
 FWHM 12.0°
 Efficiency 77 %
 Peak intensity 7.300 cd/lm
 LEDs/each optic 1
 Light colour White
 Required components:
 C12292_LENA-STD-BASE-MEZ
 C11996_LENA-LENS

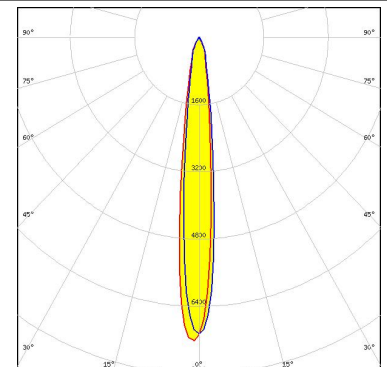

LUMILEDS

LED LUXEON CoB 1204/1205
 FWHM 10.0°
 Efficiency 83 %
 Peak intensity 13.100 cd/lm
 LEDs/each optic 1
 Light colour White
 Required components:
 C12292_LENA-STD-BASE-MEZ

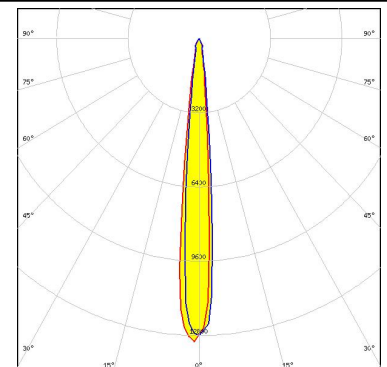

PHOTOMETRIC DATA (MEASURED):

LUMILEDS

LED LUXEON CoB 1204HD
 FWHM 7.5°
 Efficiency 88 %
 Peak intensity 28.800 cd/lm
 LEDs/each optic 1
 Light colour White
 Required components:
 C11981_LENA-STD-BASE-COB-L110

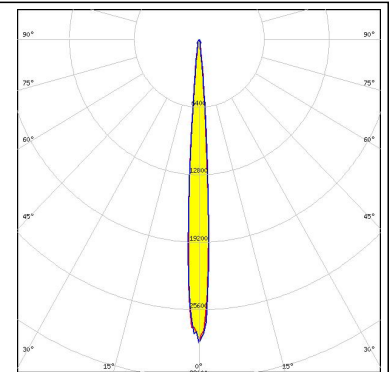

LUMILEDS

LED LUXEON CoB 1205HD
 FWHM 9.0°
 Efficiency 88 %
 Peak intensity 19.200 cd/lm
 LEDs/each optic 1
 Light colour White
 Required components:
 C11981_LENA-STD-BASE-COB-L110

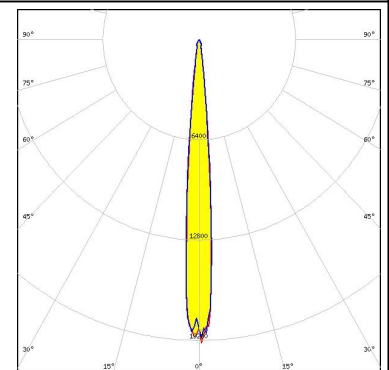

LUMILEDS

LED LUXEON CoB 1208
 FWHM 14.0°
 Efficiency 78 %
 Peak intensity 6.000 cd/lm
 LEDs/each optic 1
 Light colour White
 Required components:
 C12292_LENA-STD-BASE-MEZ
 C11996_LENA-LENS

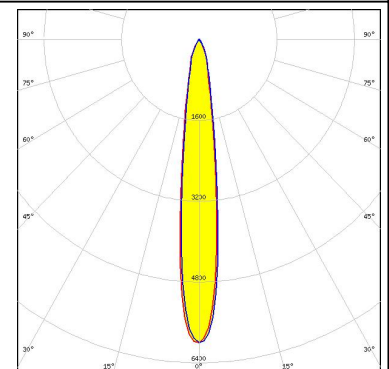
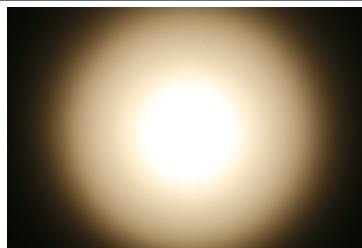

LUMILEDS

LED LUXEON CoB 1208
 FWHM 12.0°
 Efficiency 84 %
 Peak intensity 9.900 cd/lm
 LEDs/each optic 1
 Light colour White
 Required components:
 C12292_LENA-STD-BASE-MEZ

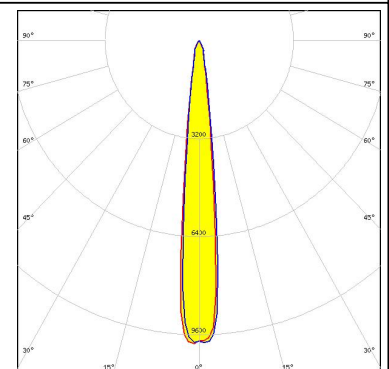

PHOTOMETRIC DATA (MEASURED):

LUMILEDS

LED LUXEON CoB 1211
 FWHM 16.0°
 Efficiency 85 %
 Peak intensity 6.600 cd/m
 LEDs/each optic 1
 Light colour White
 Required components:
 C13867_LENA-STD-BASE-VERO29
 Bender Wirth: 431 Typ L3

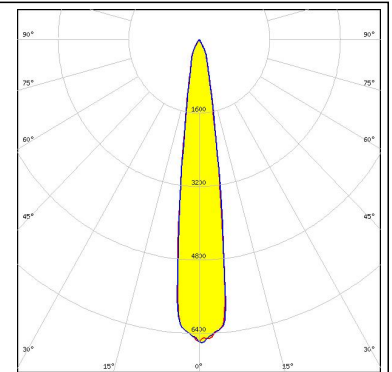

LUMILEDS

LED LUXEON CoB 1211
 FWHM 17.0°
 Efficiency 80 %
 Peak intensity 5.000 cd/m
 LEDs/each optic 1
 Light colour White
 Required components:
 C13867_LENA-STD-BASE-VERO29
 Bender Wirth: 431 Typ L3

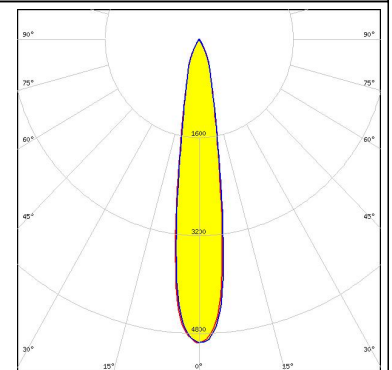
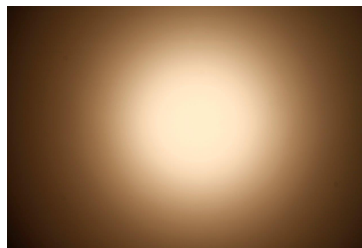

LUMILEDS

LED LUXEON CoB 1216/1812
 FWHM 21.0°
 Efficiency 80 %
 Peak intensity 3.600 cd/m
 LEDs/each optic 1
 Light colour White
 Required components:
 C12692_LENA-STD-BASE-CLL040
 C11996_LENA-LENS

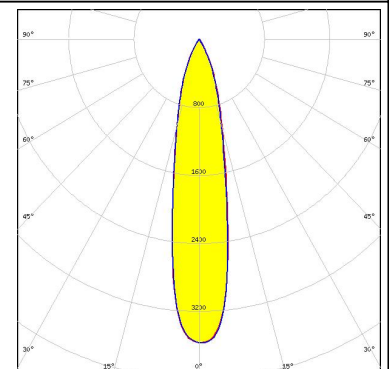
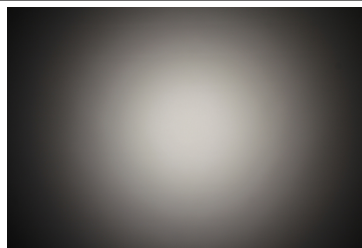

LUMILEDS

LED LUXEON CoB 1216/1812
 FWHM 18.0°
 Efficiency 79 %
 Peak intensity 4.540 cd/m
 LEDs/each optic 1
 Light colour White
 Required components:
 A.A.G. STUCCHI: 8102/G2 + S-8000/12

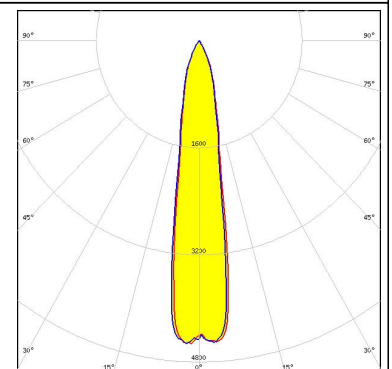

PHOTOMETRIC DATA (MEASURED):



LED LUXEON CoB 1216/1812
 FWHM 23.0°
 Efficiency 74 %
 Peak intensity 2.600 cd/lm
 LEDs/each optic 1
 Light colour White
 Required components:
 A.A.G. STUCCHI: 8102/G2 + S-8000/12

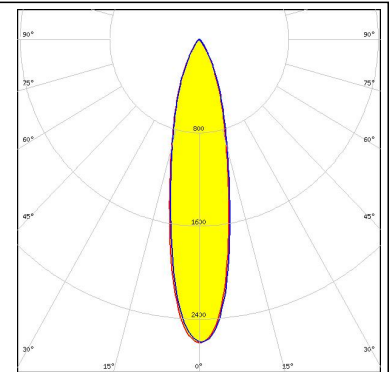

LED CDM-14 (Dim-To-Warm)
 FWHM 13.0°
 Efficiency 82 %
 Peak intensity 8.500 cd/lm
 LEDs/each optic 1
 Light colour White
 Required components:
 C13868_LENA-STD-BASE-VERO13-18
 C11996_LENA-LENS
 Bender Wirth: 491 Typ L2

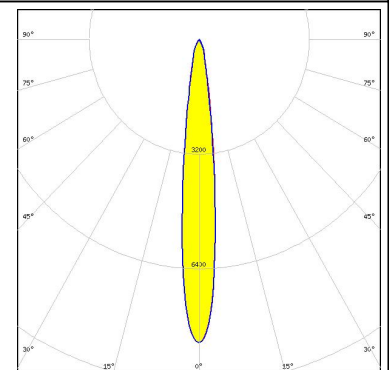
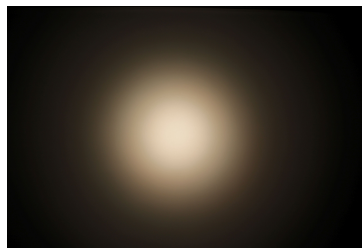

LED CDM-18 (Dim-To-Warm)
 FWHM 16.0°
 Efficiency 82 %
 Peak intensity 5.600 cd/lm
 LEDs/each optic 1
 Light colour White
 Required components:
 C13868_LENA-STD-BASE-VERO13-18
 C11996_LENA-LENS
 Bender Wirth: 491 Typ L2

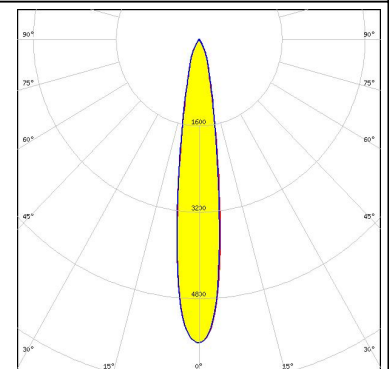
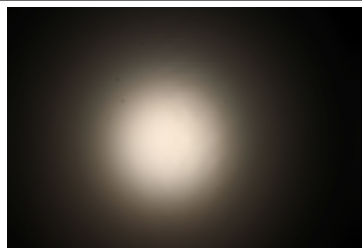

LED CDM-9 (Dim-To-Warm)
 FWHM 10.0°
 Efficiency 81 %
 Peak intensity 13.400 cd/lm
 LEDs/each optic 1
 Light colour White
 Required components:
 C13868_LENA-STD-BASE-VERO13-18
 C11996_LENA-LENS
 Bender Wirth: 490 Typ L1

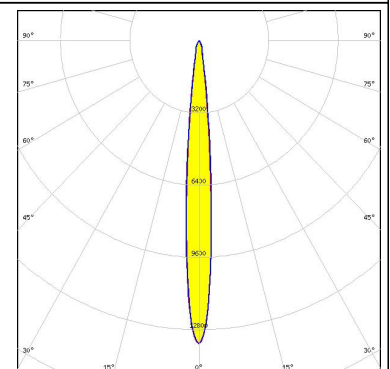

PHOTOMETRIC DATA (MEASURED):



LED CTM-14 (Tunable White)
 FWHM 13.0°
 Efficiency 81 %
 Peak intensity 8.600 cd/lm
 LEDs/each optic 1
 Light colour White
 Required components:
 C13867_LENA-STD-BASE-VERO29
 C12606_LENINA-DL
 Bender Wirth: 442 Typ L3

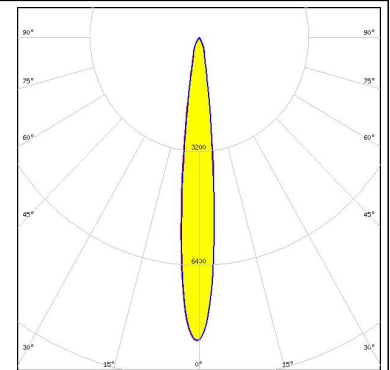
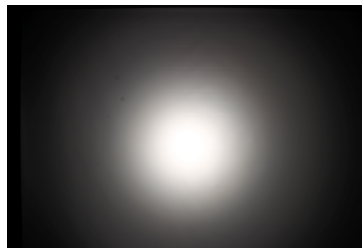

LED CTM-14 (Tunable White)
 FWHM 10.0°
 Efficiency 86 %
 Peak intensity 14.900 cd/lm
 LEDs/each optic 1
 Light colour White
 Required components:
 C13867_LENA-STD-BASE-VERO29
 Bender Wirth: 442 Typ L3

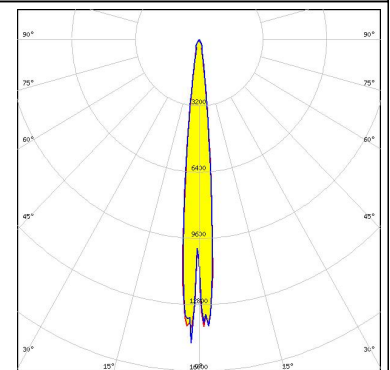

LED CTM-18 (Tunable White)
 FWHM 15.0°
 Efficiency 81 %
 Peak intensity 6.000 cd/lm
 LEDs/each optic 1
 Light colour White
 Required components:
 C13867_LENA-STD-BASE-VERO29
 C11996_LENA-LENS
 Bender Wirth: 442 Typ L3

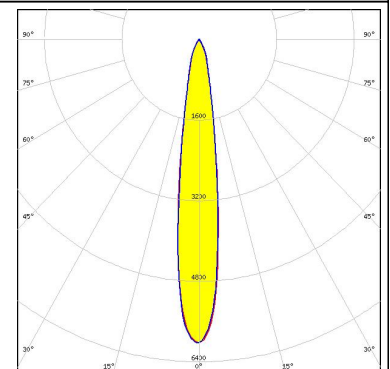
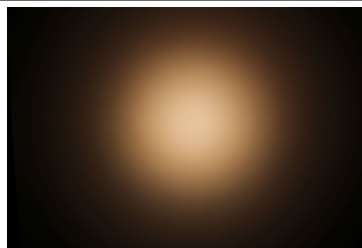

LED CTM-22 (Tunable White)
 FWHM 20.0°
 Efficiency 81 %
 Peak intensity 3.950 cd/lm
 LEDs/each optic 1
 Light colour White
 Required components:
 C13867_LENA-STD-BASE-VERO29
 C11996_LENA-LENS
 Bender Wirth: 494 Typ L3

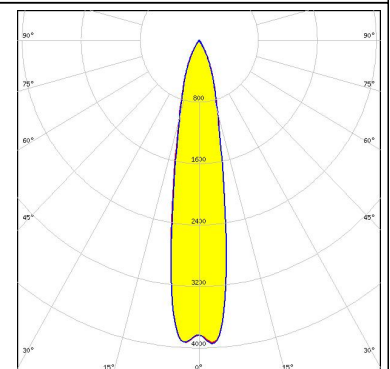
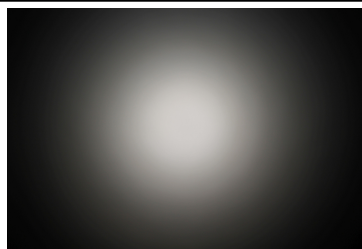

PHOTOMETRIC DATA (MEASURED):



LED CxM-14 (19x19)
 FWHM 14.0°
 Efficiency 80 %
 Peak intensity 7.100 cd/lm
 LEDs/each optic 1
 Light colour White
 Required components:
 C12691_LENA-STD-BASE-CLL030
 C11996_LENA-LENS

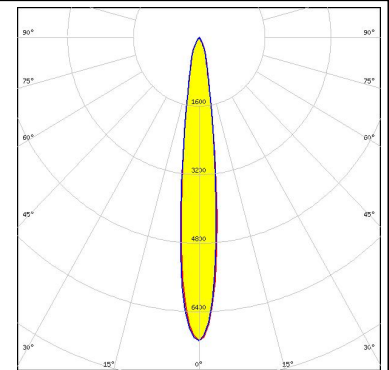

LED CxM-22 (28x28)
 FWHM 21.0°
 Efficiency 80 %
 Peak intensity 3.800 cd/lm
 LEDs/each optic 1
 Light colour White
 Required components:
 C12692_LENA-STD-BASE-CLL040
 C11996_LENA-LENS

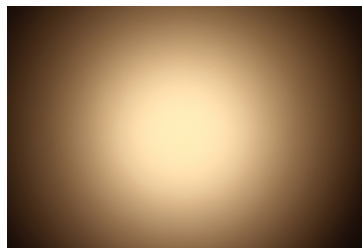

LED COB J-Type
 FWHM 12.0°
 Efficiency 87 %
 Peak intensity 11.600 cd/lm
 LEDs/each optic 1
 Light colour White
 Required components:
 C13868_LENA-STD-BASE-VERO13-18
 Bender Wirth: 463 Typ L2

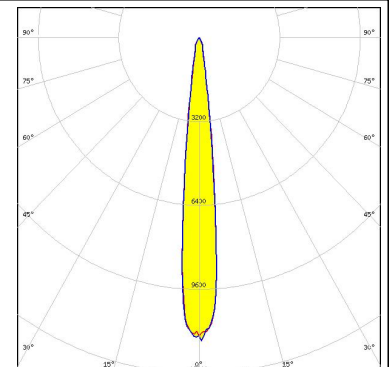

LED COB J-Type
 FWHM 14.0°
 Efficiency 82 %
 Peak intensity 6.500 cd/lm
 LEDs/each optic 1
 Light colour White
 Required components:
 C13868_LENA-STD-BASE-VERO13-18
 C11996_LENA-LENS
 Bender Wirth: 463 Typ L2

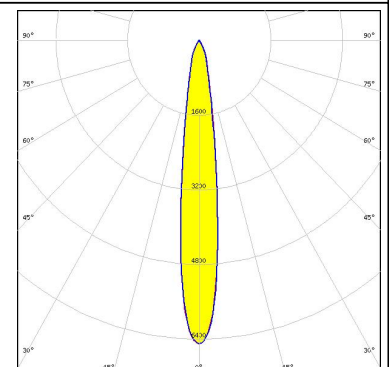

PHOTOMETRIC DATA (MEASURED):



LED COB L-Type (LES 11)
 FWHM 11.0°
 Efficiency 82 %
 Peak intensity 9.400 cd/lm
 LEDs/each optic 1
 Light colour White
 Required components:
 C13868_LENA-STD-BASE-VERO13-18
 C11996_LENA-LENS
 Bender Wirth: 438 Typ L1

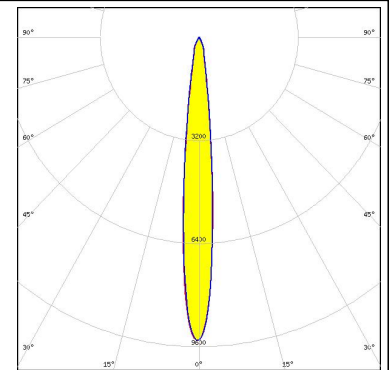

LED COB L-Type (LES 11)
 FWHM 9.0°
 Efficiency 87 %
 Peak intensity 18.800 cd/lm
 LEDs/each optic 1
 Light colour White
 Required components:
 C13868_LENA-STD-BASE-VERO13-18
 Bender Wirth: 438 Typ L1

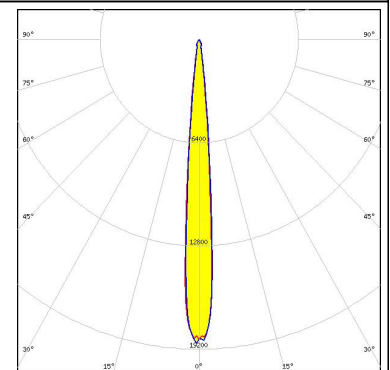

LED COB L-Type (LES 9)
 FWHM 9.0°
 Efficiency 83 %
 Peak intensity 11.900 cd/lm
 LEDs/each optic 1
 Light colour White
 Required components:
 C13868_LENA-STD-BASE-VERO13-18
 C11996_LENA-LENS
 Bender Wirth: 438 Typ L1

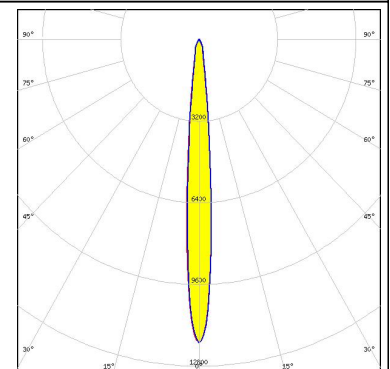
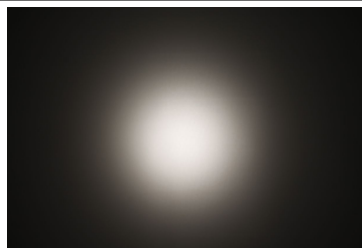

LED COB L-Type (LES 9)
 FWHM 7.0°
 Efficiency 89 %
 Peak intensity 30.700 cd/lm
 LEDs/each optic 1
 Light colour White
 Required components:
 C13868_LENA-STD-BASE-VERO13-18
 Bender Wirth: 438 Typ L1

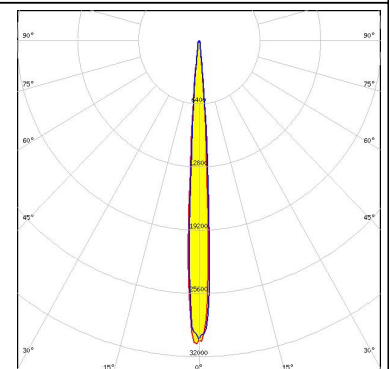

PHOTOMETRIC DATA (MEASURED):



LED NVCWJ024Z-V1MT: COB J-Type Tunable White
 FWHM 11.0°
 Efficiency 81 %
 Peak intensity 10.000 cd/lm
 LEDs/each optic 1
 Light colour White
 Required components:
 C13868_LENA-STD-BASE-VERO13-18
 C11996_LENA-LENS
 Bender Wirth: 498 Typ L2

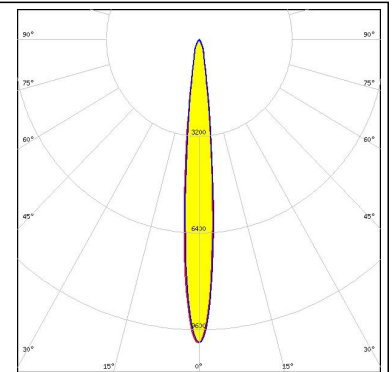
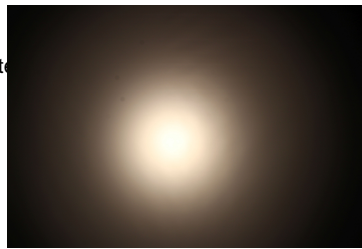

LED NVCWJ024Z-V1MT: COB J-Type Tunable White
 FWHM 9.0°
 Efficiency 87 %
 Peak intensity 21.500 cd/lm
 LEDs/each optic 1
 Light colour White
 Required components:
 C13868_LENA-STD-BASE-VERO13-18
 Bender Wirth: 498 Typ L2

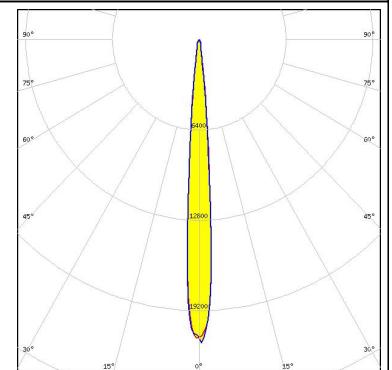

Opto Semiconductors

LED Soleriq S13
 FWHM 12.0°
 Efficiency 80 %
 Peak intensity 8.000 cd/lm
 LEDs/each optic 1
 Light colour White
 Required components:
 C13868_LENA-STD-BASE-VERO13-18
 C11996_LENA-LENS
 Bender Wirth: 437 Typ L1

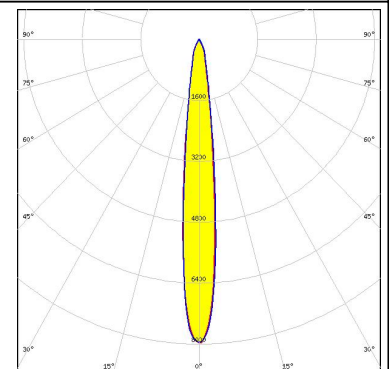
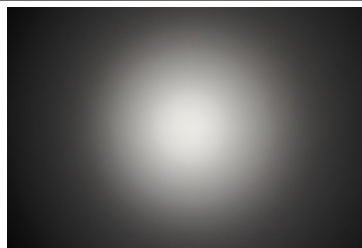

Opto Semiconductors

LED Soleriq S19
 FWHM 15.0°
 Efficiency 80 %
 Peak intensity 6.100 cd/lm
 LEDs/each optic 1
 Light colour White
 Required components:
 C13867_LENA-STD-BASE-VERO29
 Bender Wirth: 462 Typ L3

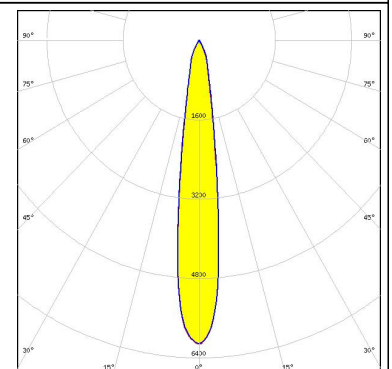
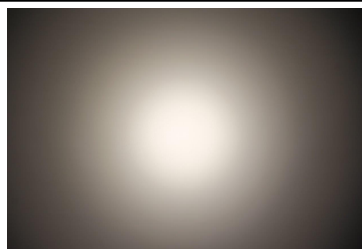

PHOTOMETRIC DATA (MEASURED):

PHILIPS

LED Fortimo SLM L13 CoB
 FWHM 11.0°
 Efficiency 81 %
 Peak intensity 9.900 cd/lm
 LEDs/each optic 1
 Light colour White
 Required components:
 C12292_LENA-STD-BASE-MEZ
 C11996_LENA-LENS

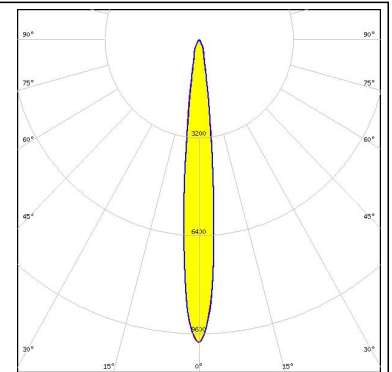

PHILIPS

LED Fortimo SLM L13 CoB
 FWHM 10.0°
 Efficiency 87 %
 Peak intensity 14.400 cd/lm
 LEDs/each optic 1
 Light colour White
 Required components:
 C12292_LENA-STD-BASE-MEZ

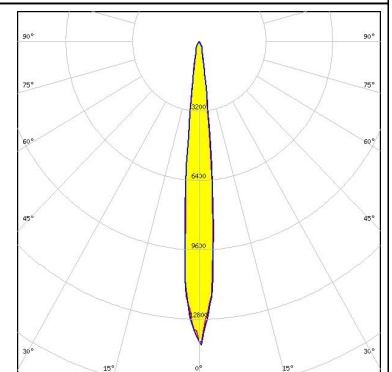

PHILIPS

LED Fortimo SLM L15 CoB
 FWHM 14.0°
 Efficiency 81 %
 Peak intensity 7.400 cd/lm
 LEDs/each optic 1
 Light colour White
 Required components:
 C12292_LENA-STD-BASE-MEZ
 C11996_LENA-LENS

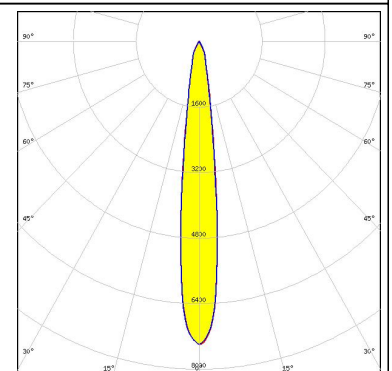
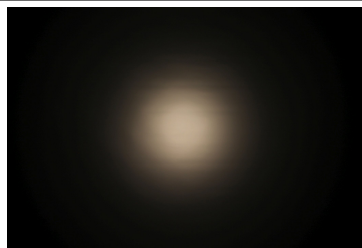

PHILIPS

LED Fortimo SLM L15 CoB
 FWHM 13.0°
 Efficiency 87 %
 Peak intensity 10.600 cd/lm
 LEDs/each optic 1
 Light colour White
 Required components:
 C12292_LENA-STD-BASE-MEZ

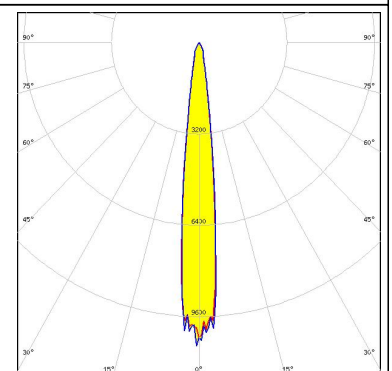

PHOTOMETRIC DATA (MEASURED):

PHILIPS

LED Fortimo SLM L19 CoB
 FWHM 16.0°
 Efficiency 81 %
 Peak intensity 5.100 cd/lm
 LEDs/each optic 1
 Light colour White
 Required components:
 C12692_LENA-STD-BASE-CLL040
 C11996_LENA-LENS

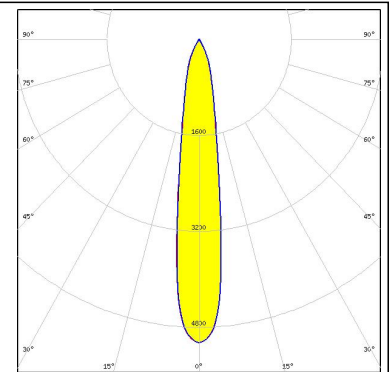

PHILIPS

LED Fortimo SLM L19 CoB
 FWHM 15.0°
 Efficiency 87 %
 Peak intensity 6.800 cd/lm
 LEDs/each optic 1
 Light colour White
 Required components:
 C12692_LENA-STD-BASE-CLL040

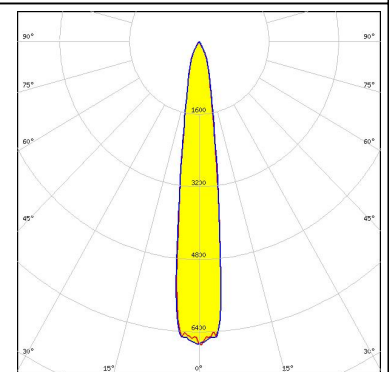
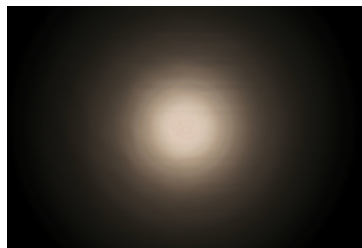

PHILIPS

LED Fortimo SLM L23 CoB
 FWHM 20.0°
 Efficiency 81 %
 Peak intensity 3.800 cd/lm
 LEDs/each optic 1
 Light colour White
 Required components:
 C12692_LENA-STD-BASE-CLL040
 C11996_LENA-LENS

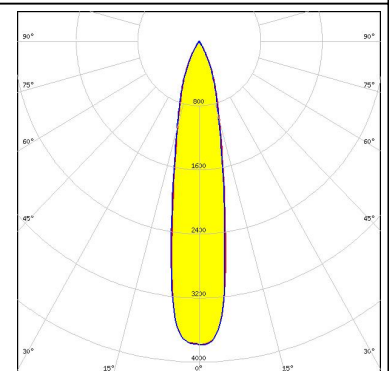
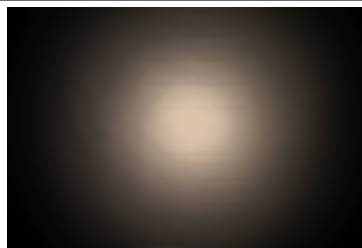

PHILIPS

LED Fortimo SLM L23 CoB
 FWHM 19.0°
 Efficiency 87 %
 Peak intensity 4.800 cd/lm
 LEDs/each optic 1
 Light colour White
 Required components:
 C12692_LENA-STD-BASE-CLL040

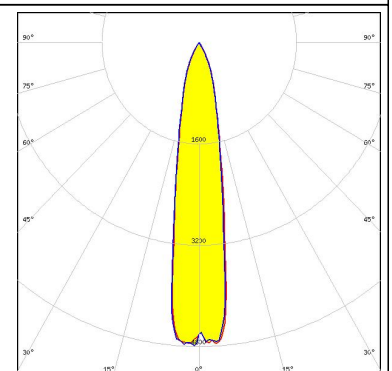
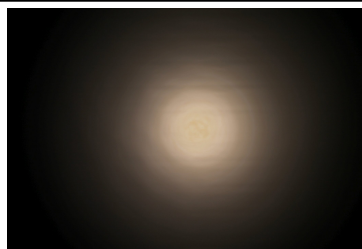

PHOTOMETRIC DATA (MEASURED):

SAMSUNG

LED COB D Series LES 14.5 mm
 FWHM 12.0°
 Efficiency 85 %
 Peak intensity 11.000 cd/lm
 LEDs/each optic 1
 Light colour White
 Required components:
 C12691_LENA-STD-BASE-CLL030

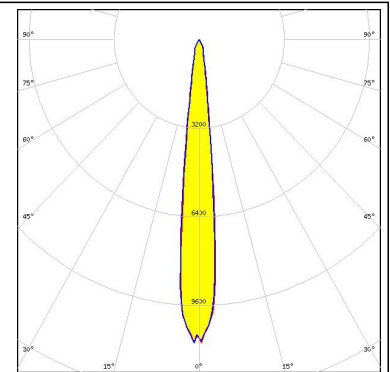
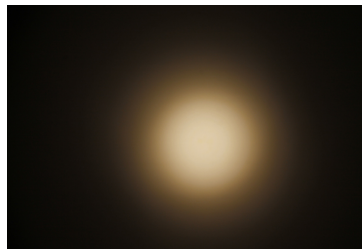

SAMSUNG

LED COB D Series LES 14.5 mm
 FWHM 14.0°
 Efficiency 80 %
 Peak intensity 6.900 cd/lm
 LEDs/each optic 1
 Light colour White
 Required components:
 C12691_LENA-STD-BASE-CLL030
 C11996_LENA-LENS

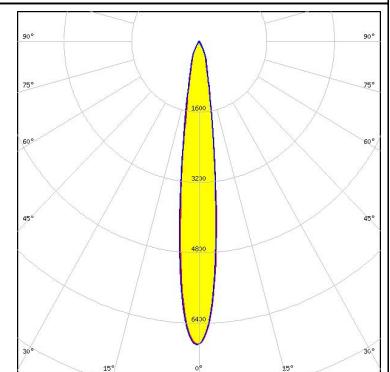
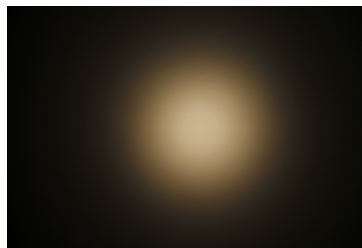

SAMSUNG

LED COB D Series LES 22 mm
 FWHM 22.0°
 Efficiency 80 %
 Peak intensity 3.300 cd/lm
 LEDs/each optic 1
 Light colour White
 Required components:
 C12692_LENA-STD-BASE-CLL040
 C11996_LENA-LENS

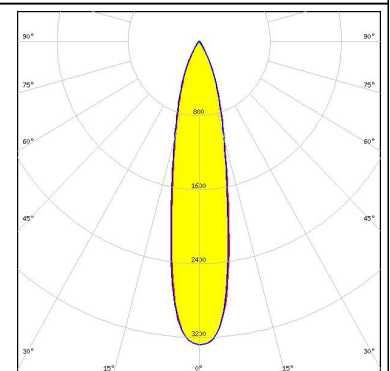
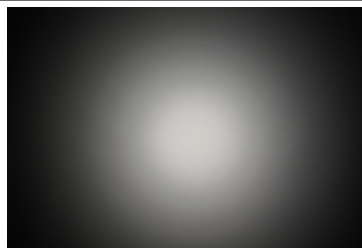

SEOUL SEMICONDUCTOR

LED ZC12/18
 FWHM 12.0°
 Efficiency 80 %
 Peak intensity 8.000 cd/lm
 LEDs/each optic 1
 Light colour White
 Required components:
 C12691_LENA-STD-BASE-CLL030
 C11996_LENA-LENS

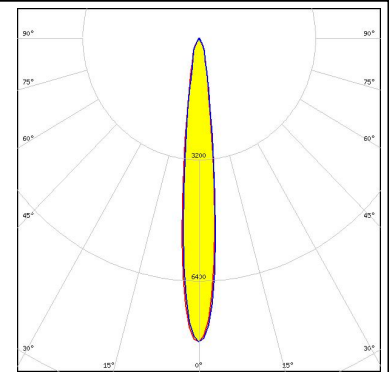
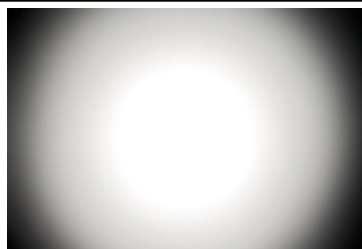

PHOTOMETRIC DATA (MEASURED):

SHARP

LED Mega Zenigata (GW5DGC)
FWHM 13.5°
Efficiency 85 %
Peak intensity cd/lm
LEDs/each optic 1
Light colour White
Required components:
C12292_LENA-STD-BASE-MEZ

SHARP

LED Mega Zenigata (GW5DGC)
FWHM 14.0°
Efficiency 80 %
Peak intensity cd/lm
LEDs/each optic 1
Light colour White
Required components:
C12292_LENA-STD-BASE-MEZ
C11996_LENA-LENS

SHARP

LED Mega Zenigata (GW6DME)
FWHM 14.0°
Efficiency 77 %
Peak intensity 6.150 cd/lm
LEDs/each optic 1
Light colour White
Required components:
C12292_LENA-STD-BASE-MEZ
C11996_LENA-LENS

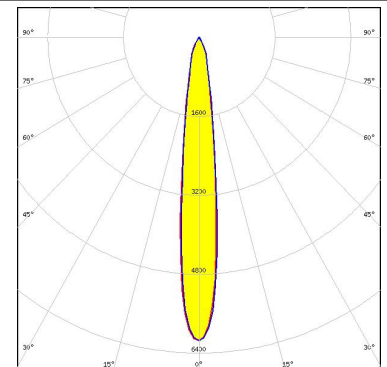

SHARP

LED Mega Zenigata (GW6DME)
FWHM 12.0°
Efficiency 83 %
Peak intensity 10.230 cd/lm
LEDs/each optic 1
Light colour White
Required components:
C12292_LENA-STD-BASE-MEZ

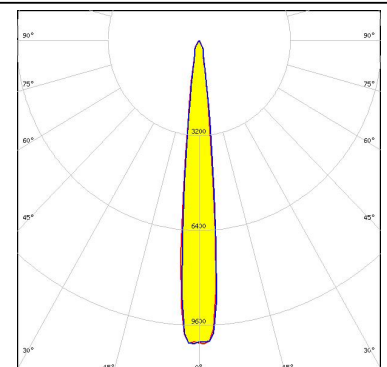

PHOTOMETRIC DATA (MEASURED):

TRIDONIC

LED SLE G7 LES15
 FWHM 11.0°
 Efficiency 88 %
 Peak intensity 12.600 cd/lm
 LEDs/each optic 1
 Light colour White
 Required components:
 C12691_LENA-STD-BASE-CLL030

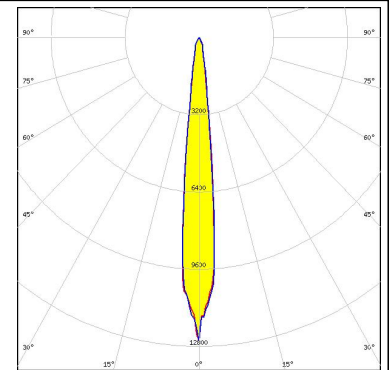

TRIDONIC

LED SLE G7 LES17 H
 FWHM 14.0°
 Efficiency 86 %
 Peak intensity 9.000 cd/lm
 LEDs/each optic 1
 Light colour White
 Required components:
 C14547_LENA-ADAPTER-B

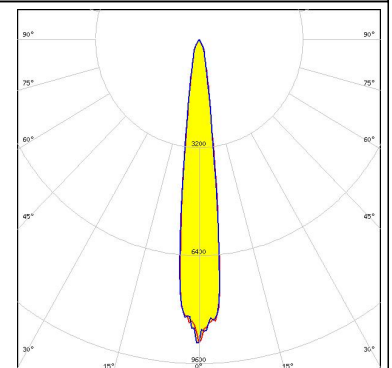

TRIDONIC

LED SLE G7 LES21 H
 FWHM 23.0°
 Efficiency 73 %
 Peak intensity 1.900 cd/lm
 LEDs/each optic 1
 Light colour White
 Required components:
 C14547_LENA-ADAPTER-B

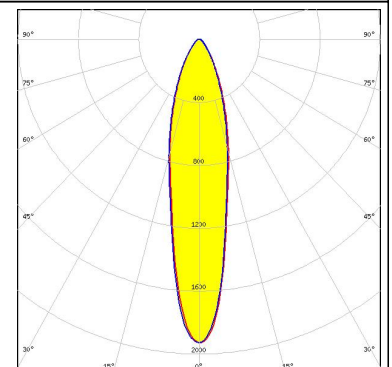
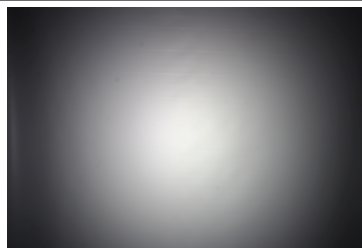

TRIDONIC

LED SLE G7 LES21 H
 FWHM 23.0°
 Efficiency 73 %
 Peak intensity 1.900 cd/lm
 LEDs/each optic 1
 Light colour White
 Required components:
 C12231_LENA-FRESNEL-LENS

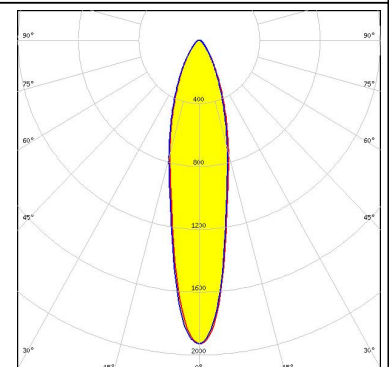
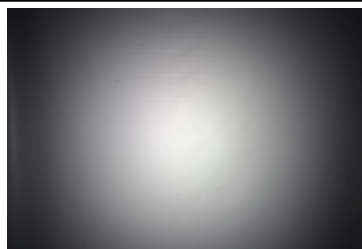

PHOTOMETRIC DATA (MEASURED):

TRIDONIC

LED SLE G7 LES21 H
FWHM 18.0°
Efficiency 86 %
Peak intensity 5.700 cd/lm
LEDs/each optic 1
Light colour White
Required components:
C14547_LENA-ADAPTER-B

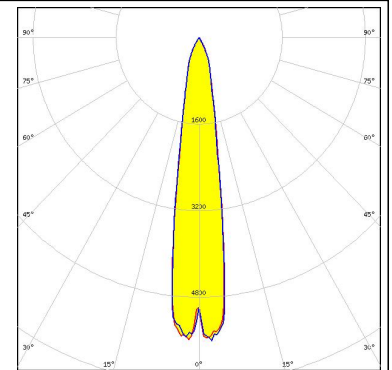

XICATO



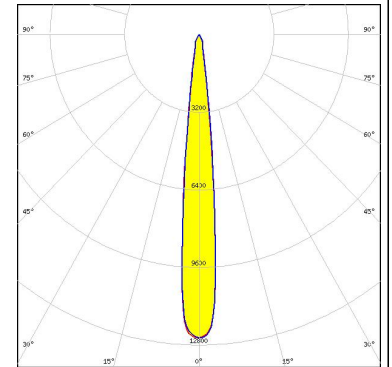



LED XOB 14.5 mm
FWHM 12.0°
Efficiency 89 %
Peak intensity 12.518 cd/lm
LEDs/each optic 1
Light colour White
Required components:
C12691_LENA-STD-BASE-CLL030

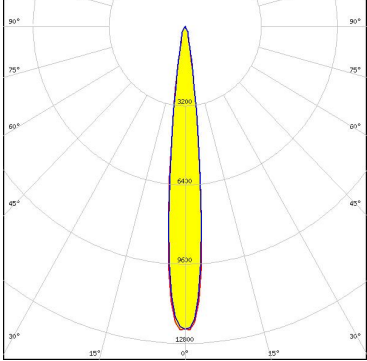

PHOTOMETRIC DATA (SIMULATED):

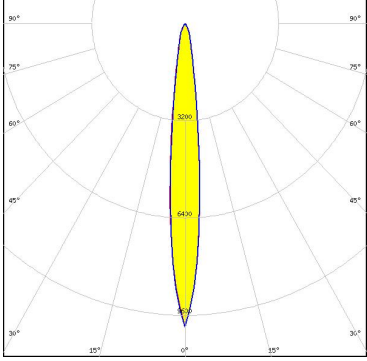
| | |
|--|--|
| <p>bridgelux.</p> <p>LED V10 Gen7 FWHM 11.0° Efficiency 79 % Peak intensity 12.280 cd/lm LEDs/each optic 1 Light colour White Required components: C13868_LENA-STD-BASE-VERO13-18 C11996_LENA-LENS Bender Wirth: 486 Typ L1</p> | |
| <p>bridgelux.</p> <p>LED V10 Gen7 FWHM 9.0° Efficiency 90 % Peak intensity 22.340 cd/lm LEDs/each optic 1 Light colour White Required components: C13868_LENA-STD-BASE-VERO13-18 Bender Wirth: 486 Typ L1</p> | |
| <p>bridgelux.</p> <p>LED V13 Gen7 FWHM 13.0° Efficiency 81 % Peak intensity 9.000 cd/lm LEDs/each optic 1 Light colour White Required components: C13868_LENA-STD-BASE-VERO13-18 C11996_LENA-LENS Bender Wirth: 477 Typ L1</p> | |
| <p>bridgelux.</p> <p>LED V13 Gen7 FWHM 10.0° Efficiency 88 % Peak intensity 12.900 cd/lm LEDs/each optic 1 Light colour White Required components: IDEAL: 50-2103CT + 50-2100LN</p> | |

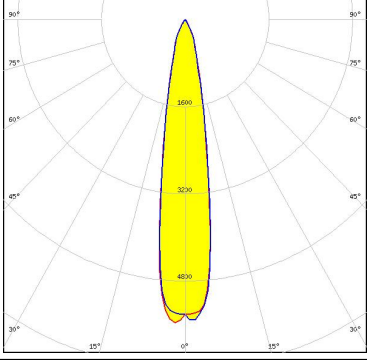
PHOTOMETRIC DATA (SIMULATED):

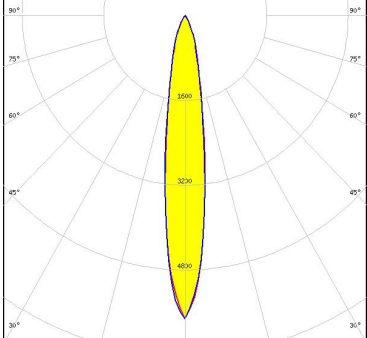
| | |
|---|---|
| <p> bridgelux</p> <p>LED V13 Gen7 FWHM 12.0° Efficiency 89 % Peak intensity 12.270 cd/lm LEDs/each optic 1 Light colour White Required components: C13868_LENA-STD-BASE-VERO13-18 Bender Wirth: 477 Typ L1</p> |  |
| <p> bridgelux</p> <p>LED V13 Gen7 FWHM 11.0° Efficiency 85 % Peak intensity 9.900 cd/lm LEDs/each optic 1 Light colour White Required components: IDEAL: 50-2103CT + 50-2100LN</p> |  |
| <p> bridgelux</p> <p>LED V22 Gen7 FWHM 18.0° Efficiency 90 % Peak intensity 5.583 cd/lm LEDs/each optic 1 Light colour White Required components: C13867_LENA-STD-BASE-VERO29 Bender Wirth: 431 Typ L3</p> |  |
| <p> CREE</p> <p>LED CXA/B 30xx FWHM 16.0° Efficiency 80 % Peak intensity 5.700 cd/lm LEDs/each optic 1 Light colour White Required components: IDEAL: 50-2234C + 50-2100LN</p> |  |

PHOTOMETRIC DATA (SIMULATED):



LED CXA/B 30xx
FWHM 14.0°
Efficiency 87 %
Peak intensity 7.500 cd/lm
LEDs/each optic 1
Light colour White
Required components:
IDEAL: 50-2234C + 50-2100LN

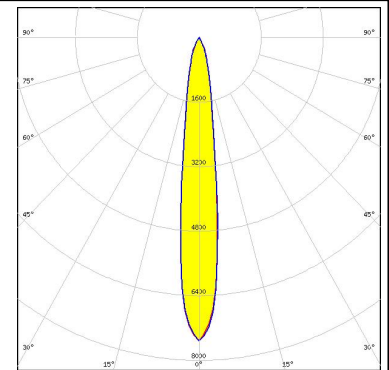

LED CxM-14 (19x19)
FWHM 12.0°
Efficiency 85 %
Peak intensity 11.200 cd/lm
LEDs/each optic 1
Light colour White
Required components:
C13868_LENA-STD-BASE-VERO13-18
Bender Wirth: 433 Typ L1



LED CxM-14 (19x19)
FWHM 14.0°
Efficiency 80 %
Peak intensity 6.700 cd/lm
LEDs/each optic 1
Light colour White
Required components:
C13868_LENA-STD-BASE-VERO13-18
C11996_LENA-LENS
Bender Wirth: 433 Typ L1



LED CxM-9 (13.5x13.5)
FWHM 8.0°
Efficiency 85 %
Peak intensity 26.500 cd/lm
LEDs/each optic 1
Light colour White
Required components:
C13868_LENA-STD-BASE-VERO13-18
Bender Wirth: 434 Typ L1

PHOTOMETRIC DATA (SIMULATED):



LED CxM-9 (13.5x13.5)
FWHM 10.0°
Efficiency 80 %
Peak intensity 11.500 cd/lm
LEDs/each optic 1
Light colour White
Required components:
C13868_LENA-STD-BASE-VERO13-18
C11996_LENA-LENS
Bender Wirth: 434 Typ L1



LED Soleriq S15
FWHM 13.0°
Efficiency 88 %
Peak intensity 10.180 cd/lm
LEDs/each optic 1
Light colour White
Required components:
C12691_LENA-STD-BASE-CLL030

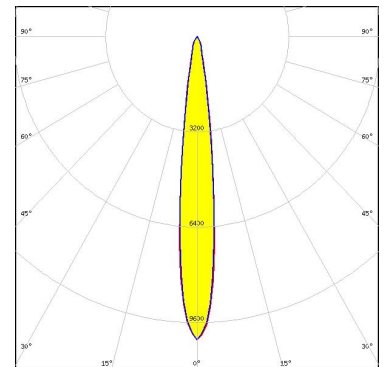

SEOUL SEMICONDUCTOR



LED ZC12/18
FWHM 12.0°
Efficiency 85 %
Peak intensity 11.200 cd/lm
LEDs/each optic 1
Light colour White
Required components:
C13868_LENA-STD-BASE-VERO13-18
Bender Wirth: 433 Typ L1



SEOUL SEMICONDUCTOR

LED ZC12/18
FWHM 14.0°
Efficiency 80 %
Peak intensity 6.700 cd/lm
LEDs/each optic 1
Light colour White
Required components:
C13868_LENA-STD-BASE-VERO13-18
C11996_LENA-LENS
Bender Wirth: 433 Typ L1

PHOTOMETRIC DATA (SIMULATED):

| | |
|---|--------------|
|  | |
| SEOUL SEMICONDUCTOR | |
| LED | ZC4/6 |
| FWHM | 8.0° |
| Efficiency | 85 % |
| Peak intensity | 26.500 cd/lm |
| LEDs/each optic | 1 |
| Light colour | White |
| Required components: | |
| C13868_LENA-STD-BASE-VERO13-18 | |
| Bender Wirth: 434 Typ L1 | |
| <hr/> | |
|  | |
| SEOUL SEMICONDUCTOR | |
| LED | ZC4/6 |
| FWHM | 10.0° |
| Efficiency | 80 % |
| Peak intensity | 11.500 cd/lm |
| LEDs/each optic | 1 |
| Light colour | White |
| Required components: | |
| C13868_LENA-STD-BASE-VERO13-18 | |
| C11996_LENA-LENS | |
| Bender Wirth: 434 Typ L1 | |

GENERAL INFORMATION:

NOTE: The typical beam angle will be changed by different color, chip size and chip position tolerance. The typical total beam angle is the full angle measured where the luminous intensity is half of the peak value.

Due to use of high power COB's with this product, special attention to proper thermal design is highly recommended. LEDiL has no liability for direct, indirect or consecutive damages arising from the LEDiL products being used outside of the recommended temperature range.

MATERIALS:

As part of our continuous research and improvement processes, and to ensure the best possible quality and availability of our products, LEDiL reserves the right to change material grades without notice.

PRODUCT DATA USER AGREEMENT AND DISCLAIMER:

The measured data in the provided downloadable LEDiL Product Datasheets and Mechanical 2D-Drawings is rounded and provided as reference for planning. LEDiL Oy's optical specifications have been verified by conducting performance testing of the products in accordance with the company's quality system. The reported data are averaged results of multiple measurements with typical variation. LEDiL Oy reserves the right to without prior notification make changes and improvements to its products.

LEDiL Oy assumes neither warranty, nor guarantee nor any other liability of any kind for the contents and correctness of the provided data. The provided data has been generated with highest diligence but the provided data may in reality not represent the complete possible variation range of all intrinsic parameters. Therefore, in certain cases a deviation from the provided data could occur.

LEDiL Oy reserves the right to undertake technical changes of its products without further notification which could lead to changes in the provided data. LEDiL Oy assumes no liability of any kind for the possible deviation from any provided data or any other damage resulting from the usage of the provided data.

The user agrees to this disclaimer and user agreement with the download or usage of the provided files.

LEDiL Oy

Joensuunkatu 13
FI-24240 SALO
Finland

LEDiL Inc.

228 West Page Street
Suite D
Sycamore IL 60178
USA

Local sales and technical support

[www.ledil.com/
where_to_buy](http://www.ledil.com/where_to_buy)

Shipping locations

Salo, Finland
Hong Kong, China

Distribution Partners

[www.ledil.com/
where_to_buy](http://www.ledil.com/where_to_buy)