

SERIES: CMEJ-4618-42-LX | **DESCRIPTION:** ELECTRET CONDENSER MICROPHONE

FEATURES

- omnidirectional
- low profile
- multiple lead wire lengths available

ELECTRICAL

| parameter | conditions/description | min | typ | max | units |
|--------------------------------------|--|-----|-----|--------|------------|
| directivity | omnidirectional | | | | |
| sensitivity [S] | at 1 kHz [0 dB = 1 V/Pa] | -45 | -42 | -39 | dB |
| supply voltage [V _{DD}] | | 1.0 | 2.0 | 10 | V |
| current consumption | V _{DD} = 2.0 V, R _L = 2.2 k Ω | | | 0.5 | mA |
| sensitivity reduction | V _{DD} = 2.0 ~ 1.5 V | | | 3 | dB |
| frequency [f] | | 100 | | 10,000 | Hz |
| signal to noise ratio [S/N] | at 1 kHz, P _{in} = 1 Pa [A-weighted] | | 60 | | dB |
| total harmonic distortion [THD] | at 94 dB SPL, 1 kHz | | | 1 | % |
| | at 115 dB SPL, 1 kHz | | | 3 | % |
| acoustic overload point [ADP] | at 1 kHz | | | 115 | dB SPL |
| output impedance [Z _{out}] | at 1 kHz | | | 2.2 | k Ω |

Notes: 1. All specifications measured at 20 \pm 2 $^{\circ}$ C, humidity at 60-70%, unless otherwise noted.

ENVIRONMENTAL

| parameter | conditions/description | min | typ | max | units |
|-----------------------|------------------------|-----|-----|-----|--------------|
| operating temperature | | -40 | | 70 | $^{\circ}$ C |
| storage temperature | | -40 | | 85 | $^{\circ}$ C |
| operating humidity | non-condensing | 30 | | 85 | % |
| storage humidity | non-condensing | 30 | | 75 | % |
| hand soldering | for 1-3 seconds | 340 | 350 | 360 | $^{\circ}$ C |
| RoHS | yes | | | | |

PART NUMBER KEY
CMEJ-4618-42-L XXX

Base Number

 Wire Length:
 008 = 8 mm
 010 = 10 mm
 012 = 12 mm
 015 = 15 mm
 120 = 120 mm
 177 = 177 mm

MECHANICAL

| parameter | conditions/description | min | typ | max | units |
|---------------|------------------------|-----|-----|-----|-------|
| dimensions | Ø4.6 x 1.8 | | | | mm |
| acoustic port | top | | | | |
| terminals | wire leads | | | | |

MECHANICAL DRAWING

units: mm
tolerance: ±0.2 mm

wire: UL 1571, 32 AWG

| WIRE CONNECTIONS | | |
|------------------|------------|------------|
| TERM. | WIRE COLOR | FUNCTION |
| 1 | Red | Output (+) |
| 2 | Black | GND (-) |

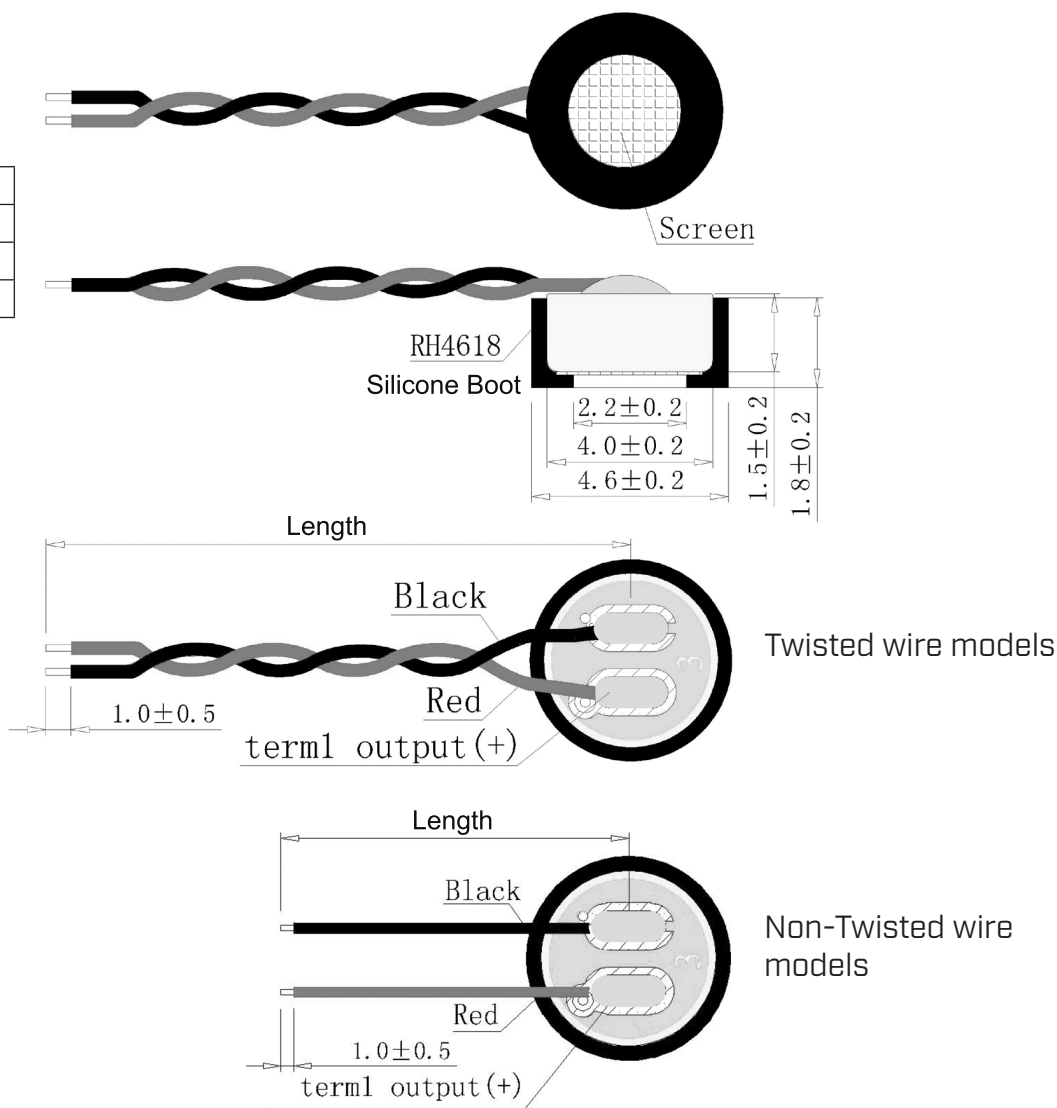

| MODEL NO. | LENGTH [mm] | TWISTED WIRES | WEIGHT [g] |
|-------------------|-------------|---------------|------------|
| CMEJ-4618-42-L008 | 8 ±1 | NO | 0.1 |
| CMEJ-4618-42-L010 | 10 ±1 | NO | 0.1 |
| CMEJ-4618-42-L012 | 12 ±1 | NO | 0.11 |
| CMEJ-4618-42-L015 | 15 ±1 | NO | 0.11 |
| CMEJ-4618-42-L120 | 120 ±5 | YES | 0.26 |
| CMEJ-4618-42-L177 | 177 ±6 | YES | 0.33 |

FREQUENCY RESPONSE CURVE

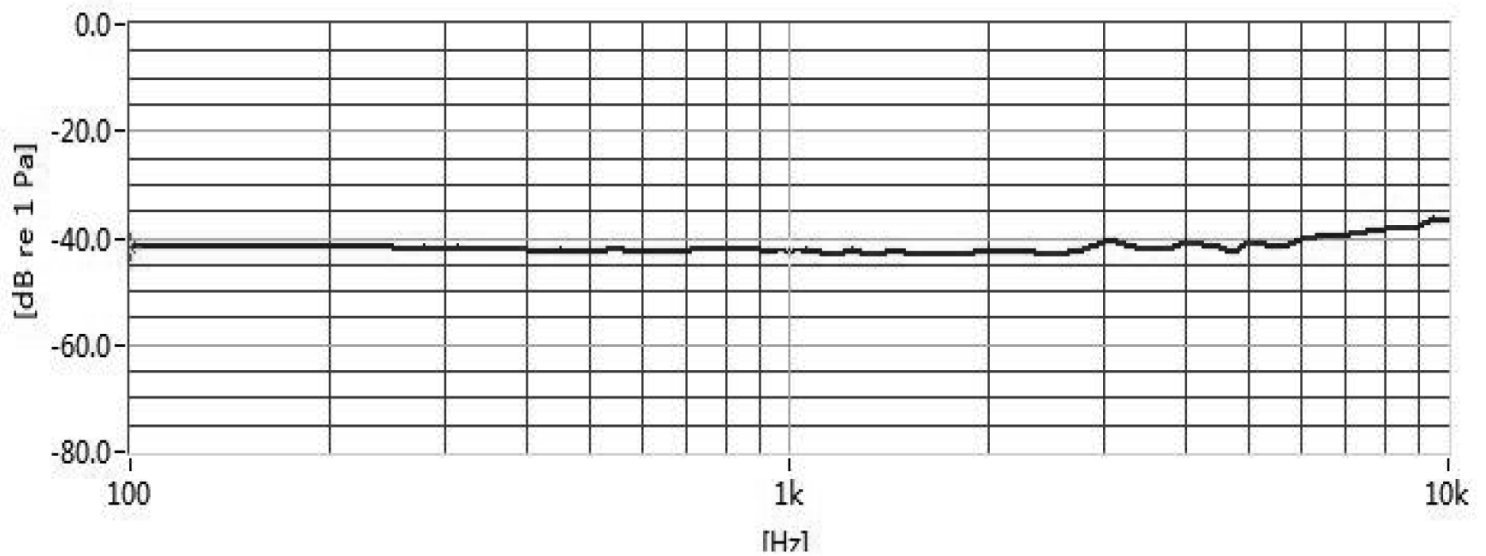

APPLICATION CIRCUIT

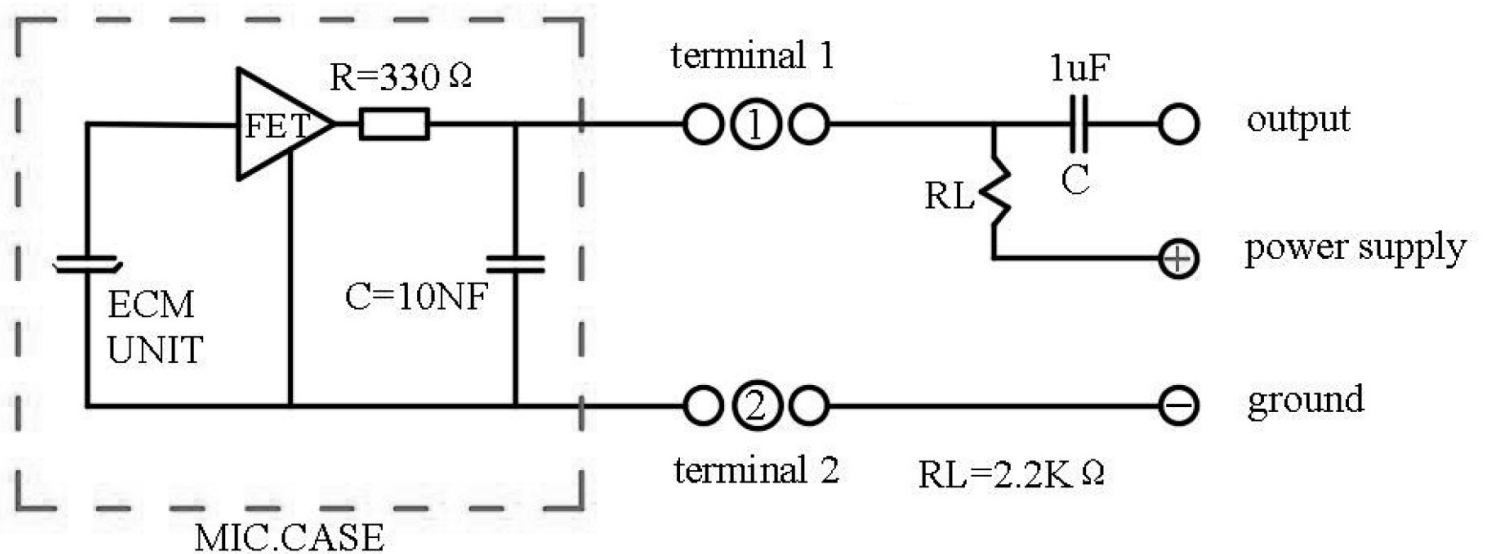

PACKAGING (NON-TWISTED WIRE MODELS)

Carton QTY: 10,000 pcs

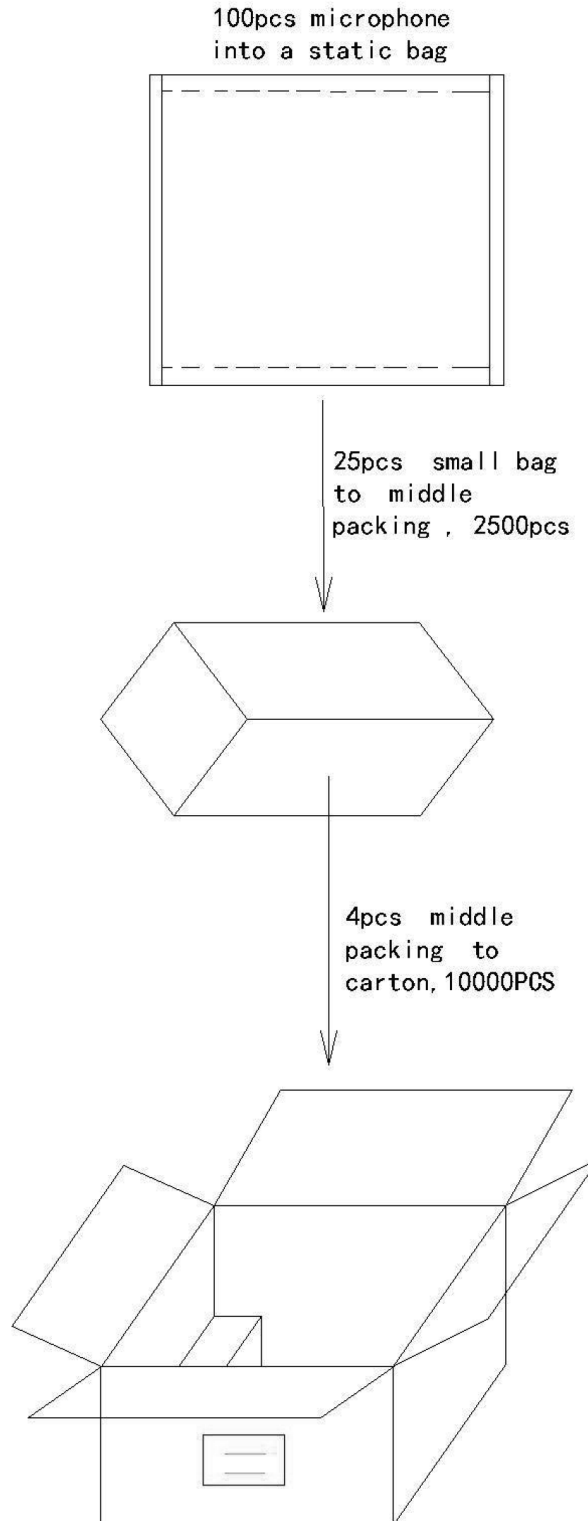

PACKAGING (TWISTED WIRE MODELS)

Carton QTY: 10,000 pcs

100PCS is 1 bundles,

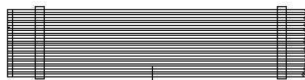

20 bundles of 1 bags

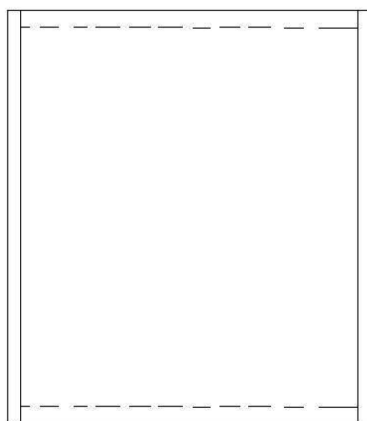

5pcs bag packing
to carton,
10000PCS

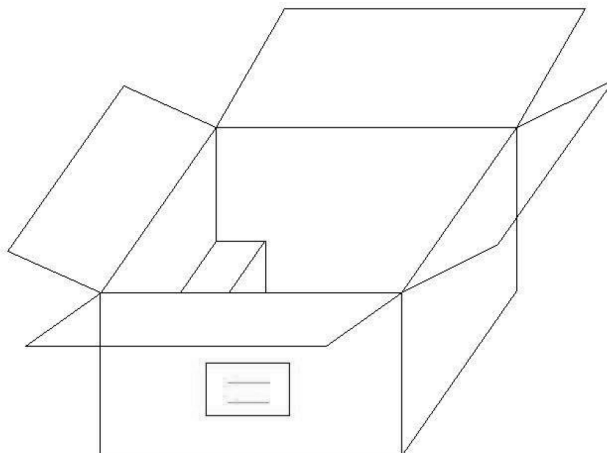

REVISION HISTORY

| rev. | description | date |
|------|------------------------------|------------|
| 1.0 | initial release | 06/07/2019 |
| 1.01 | brand update | 01/23/2020 |
| 1.02 | logo, datasheet style update | 08/05/2022 |

The revision history provided is for informational purposes only and is believed to be accurate.



CUI Devices offers a one (1) year limited warranty. Complete warranty information is listed on our website.

CUI Devices reserves the right to make changes to the product at any time without notice. Information provided by CUI Devices is believed to be accurate and reliable. However, no responsibility is assumed by CUI Devices for its use, nor for any infringements of patents or other rights of third parties which may result from its use.

CUI Devices products are not authorized or warranted for use as critical components in equipment that requires an extremely high level of reliability. A critical component is any component of a life support device or system whose failure to perform can be reasonably expected to cause the failure of the life support device or system, or to affect its safety or effectiveness.

cuidevices.com