

THS6222 8 V to 32 V, Differential HPLC Line Driver with Common-Mode Buffer

1 Features

- Supply range (V_S): 8 V to 32 V
- Integrated midsupply common-mode buffer
- Large-signal bandwidth: 195 MHz ($V_O = 16 V_{PP}$)
- Slew rate (16 V step): 5500 V/ μ s
- Low distortion ($V_S = 12 V$, 50 Ω load):
 - HD2: -80 dBc (1 MHz)
 - HD3: -90 dBc (1 MHz)
- Output current: 338 mA ($V_S = 12 V$, 25 Ω load)
- Wide output swing ($V_S = 12 V$):
 - 19.4 V_{PP} (100 Ω load)
 - 18.6 V_{PP} (50 Ω load)
- Adjustable power modes:
 - Full-bias mode: 19.5 mA
 - Mid-bias mode: 15 mA
 - Low-bias mode: 10.4 mA
 - Low-power shutdown mode
 - IADJ pin for variable bias
- Integrated overtemperature protection
- Pin-compatible with the 24-pin THS6212 VQFN

2 Applications

- SGCC HPLC line drivers
- Smart meters
- Data concentrators
- Power line communications gateways
- Home networking PLC
- Differential DSL line drivers

3 Description

The THS6222 is a differential line-driver amplifier with a current-feedback architecture manufactured using Texas Instruments' proprietary, high-speed, silicon-germanium (SiGe) process. The device is targeted for use in broadband, high-speed, power line communications (HPLC) line driver applications that require high linearity when driving heavy line loads.

The unique architecture of the THS6222 uses minimal quiescent current while achieving very high linearity. The amplifier has an adjustable current pin (IADJ) that sets the nominal current consumption along with the multiple bias modes that allow for enhanced power savings where the full performance of the amplifier is not required. Shutdown bias mode provides further power savings during receive mode in time division multiplexed (TDM) systems while maintaining high output impedance. The integrated midsupply common-mode buffer eliminates external components, reducing system cost and board space.

The wide output swing of 57 V_{PP} (100 Ω load) with 32-V power supplies, coupled with over 650 mA current drive (25 Ω load), allows for wide dynamic range that keeps distortion minimal.

The THS6222 is available in a 24-pin VQFN package with exposed thermal pad and is specified for operation from -40°C to +85°C ambient temperature.

Device Information

PART NUMBER	PACKAGE ⁽¹⁾	BODY SIZE (NOM)
THS6222	VQFN (24)	5.00 mm × 4.00 mm
	Wafer Sale (19)	1261.00 μ m × 1641.00 μ m
	VQFN (16)	3.0 mm × 3.0 mm

(1) For all available packages, see the orderable addendum at the end of the data sheet.

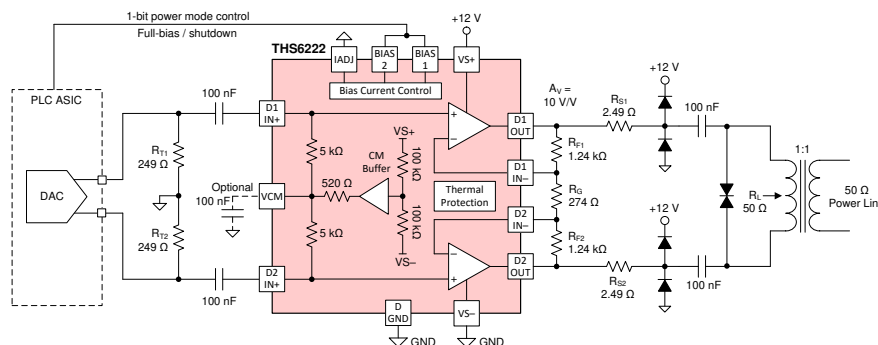

Typical Line-Driver Circuit Using the THS6222



Table of Contents

1 Features	1	8 Application and Implementation	26
2 Applications	1	8.1 Application Information.....	26
3 Description	1	8.2 Typical Applications.....	26
4 Revision History	2	8.3 What to Do and What Not to Do.....	28
5 Pin Configuration and Functions	3	9 Power Supply Recommendations	28
6 Specifications	5	10 Layout	29
6.1 Absolute Maximum Ratings	5	10.1 Layout Guidelines.....	29
6.2 ESD Ratings	5	10.2 Wafer and Die Information.....	30
6.3 Recommended Operating Conditions	5	10.3 Layout Examples.....	32
6.4 Thermal Information	5	11 Device and Documentation Support	33
6.5 Electrical Characteristics: $V_S = 12\text{ V}$	6	11.1 Development Support.....	33
6.6 Electrical Characteristics: $V_S = 32\text{ V}$	8	11.2 Documentation Support.....	33
6.7 Timing Requirements	10	11.3 Receiving Notification of Documentation Updates..	33
6.8 Typical Characteristics: $V_S = 12\text{ V}$	10	11.4 Support Resources.....	33
6.9 Typical Characteristics: $V_S = 32\text{ V}$	17	11.5 Trademarks.....	33
7 Detailed Description	20	11.6 Electrostatic Discharge Caution.....	33
7.1 Overview.....	20	11.7 Glossary.....	33
7.2 Functional Block Diagram.....	20	12 Mechanical, Packaging, and Orderable Information	33
7.3 Feature Description.....	21		
7.4 Device Functional Modes.....	25		

4 Revision History

NOTE: Page numbers for previous revisions may differ from page numbers in the current version.

Changes from Revision C (November 2020) to Revision D (April 2021)	Page
• Corrected the wrong pin diagram image that was tagged incorrectly during system migration.....	3

Changes from Revision B (April 2020) to Revision C (November 2020)	Page
• Updated the numbering format for tables, figures, and cross-references throughout the document	1
• Added VQFN (16) Package to the <i>Device Information</i> table.....	1
• Updated the RHF package in the <i>Pin Configuration and Functions</i> section.....	3
• Added the RGT package in the <i>Pin Configuration and Functions</i> section.....	3

Changes from Revision A (December 2019) to Revision B (April 2020)	Page
• Added Wafer Sale Package and Body Size (NOM) to the Device Information table	1
• Added the YS Die bondpad and functions.....	3
• Updated Table 1 BIAS-1 and BIAS-2 Logic Table.....	25
• Added Wafer and Die Information section.....	30

Changes from Revision * (August 2019) to Revision A (December 2019)	Page
• Changed device status from advance information to production data	1

5 Pin Configuration and Functions

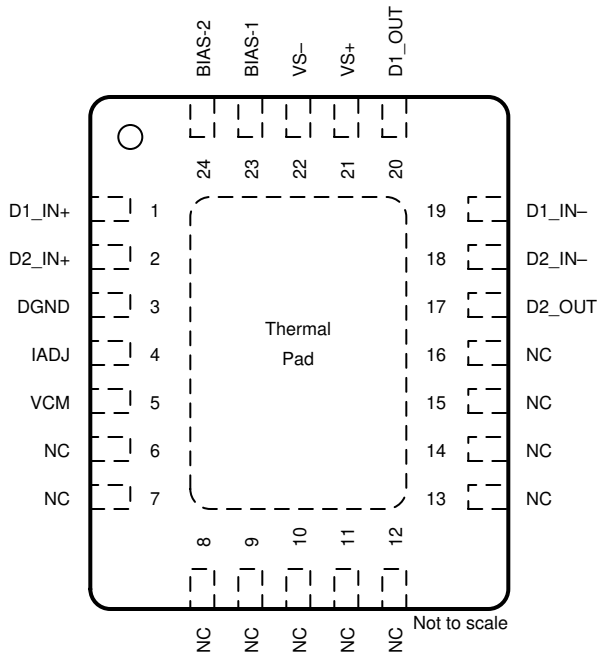

NC = no internal connection.

**Figure 5-1. RHF Package
24-Pin VQFN With Exposed Thermal Pad
Top View**

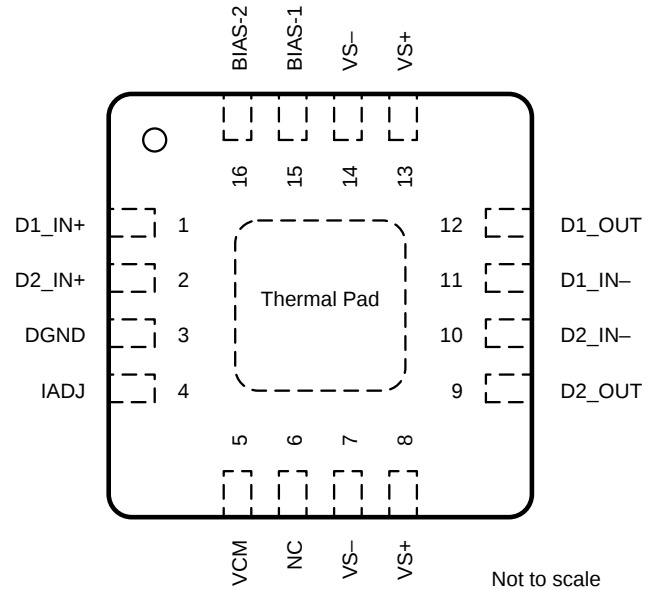

Not to scale

**Figure 5-2. RGT Package
16-Pin VQFN With Exposed Thermal Pad
Top View**

Table 5-1. Pin Functions

NAME	PIN		TYPE ⁽¹⁾	DESCRIPTION
	RHF	RGT		
BIAS-1 ⁽²⁾	23	15	I	Bias mode control, LSB
BIAS-2 ⁽²⁾	24	16	I	Bias mode control, MSB
D1_IN-	19	11	I	Amplifier D1 inverting input
D2_IN-	18	10	I	Amplifier D2 inverting input
D1_IN+	1	1	I	Amplifier D1 noninverting input
D2_IN+	2	2	I	Amplifier D2 noninverting input
D1_OUT	20	12	O	Amplifier D1 output
D2_OUT	17	9	O	Amplifier D2 output
DGND ⁽³⁾	3	3	I	Ground reference for bias control pins
IADJ	4	4	I	Bias current adjustment pin
NC	6-16	6	—	No internal connection
VCM	5	5	O	Common-mode buffer output
VS-	22	7, 14	P	Negative power-supply connection
VS+	21	8, 13	P	Positive power-supply connection
Thermal Pad			P	Electrically connected to die substrate and VS-. Connect to VS- on the printed circuit board (PCB) for best performance.

(1) I = input, O = output, and P = power,

(2) The THS6222 defaults to the shutdown (disable) state if a signal is not present on the bias pins.

(3) The DGND pin ranges from VS- to (VS+ – 5 V).

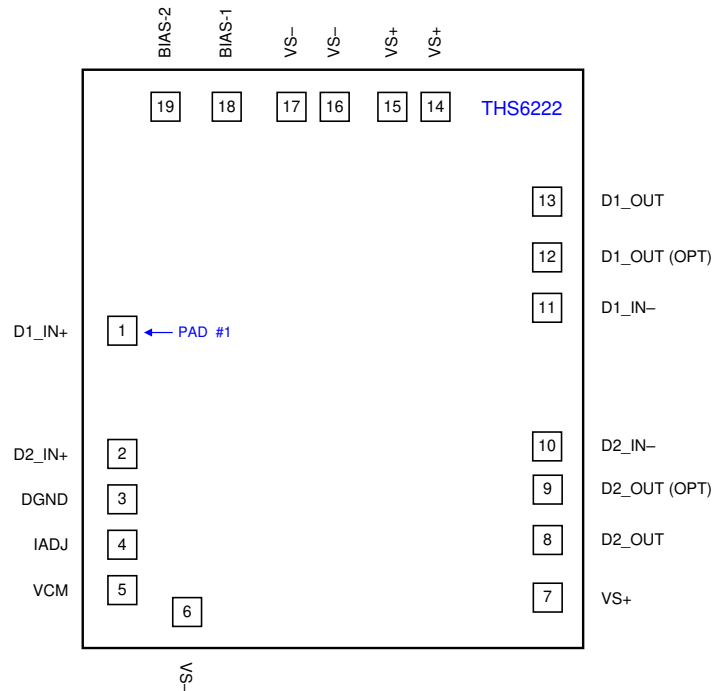

**Figure 5-3. YS Die
19-Pad Wafer Sale
Top View**

Bond Pad Functions

PAD		Type ⁽¹⁾	DESCRIPTION
NAME	NO.		
BIAS-1 ⁽²⁾	18	I	Bias mode parallel control, LSB
BIAS-2 ⁽²⁾	19	I	Bias mode parallel control, MSB
D1_IN-	11	I	Amplifier D1 inverting input
D2_IN-	10	I	Amplifier D2 inverting input
D1_IN+	1	I	Amplifier D1 noninverting input
D2_IN+	2	I	Amplifier D2 noninverting input
D1_OUT	13	O	Amplifier D1 output (must be used for D1 output)
D1_OUT (OPT)	12	O	Optional amplifier D1 output (pad can be left unconnected or connected to pad 13)
D2_OUT	8	O	Amplifier D2 output (must be used for D2 output)
D2_OUT (OPT)	9	O	Optional amplifier D2 output (can be left unconnected or connected to pad 8)
DGND ⁽³⁾	3	I	Ground reference for bias control pins
IADJ	4	I	Bias current adjustment pin
VCM	5	O	Common-mode buffer output
VS-	6, 16, 17	P	Negative power-supply connection
VS+	7, 14, 15	P	Positive power-supply connection
Backside	—	—	Must be connected to the lowest voltage potential on the die (generally VS-)

(1) I = input, O = output, and P = power.

(2) The THS6222 defaults to the shutdown (disable) state if a signal is not present on the bias pins.

(3) The DGND pin ranges from VS- to (VS+ – 5 V).

6 Specifications

6.1 Absolute Maximum Ratings

over operating free-air temperature range (unless otherwise noted)⁽¹⁾

		MIN	MAX	UNIT
Voltage	Supply voltage, $V_S = (V_{S+}) - (V_{S-})$ ⁽²⁾		33	V
	Bias control pin voltage, referenced to DGND	0	16.5	V
	Common-mode voltage, V_{CM}	See Common-Mode Buffer		V
	All pins except V_{S+} , V_{S-} , VCM, and BIAS control	$(V_{S-}) - 0.5$	$(V_{S+}) + 0.5$	V
Temperature	Maximum junction, T_J (under any condition)		150	°C
	Maximum junction, T_J (continuous operation, long-term reliability) ⁽³⁾		125	
	Storage, T_{stg}	-65	150	

- (1) Stresses beyond those listed under [Absolute Maximum Rating](#) may cause permanent device damage. These are stress ratings only, which do not imply functional operation of the device at these or any other conditions beyond those indicated under [Recommended Operating Condition](#). Exposure to absolute-maximum-rated conditions for extended periods may affect device reliability.
- (2) Refer to [Breakdown Supply Voltage](#) for breakdown test results.
- (3) The absolute maximum junction temperature for continuous operation is limited by the package constraints. Operation above this temperature can result in reduced reliability or lifetime of the device. THS6222 has thermal protection that shuts down the device at approximately 175°C junction temperature and recovery at approximately 145°C.

6.2 ESD Ratings

			VALUE	UNIT
$V_{(ESD)}$	Electrostatic discharge	Human body model (HBM), per ANSI/ESDA/ JEDEC JS-001, all pins ⁽¹⁾	±3500	V
		Charged device model (CDM), per JEDEC specification JESD22-C101, all pins ⁽²⁾	±1250	

- (1) JEDEC document JEP155 states that 500-V HBM allows safe manufacturing with a standard ESD control process.
- (2) JEDEC document JEP157 states that 250-V CDM allows safe manufacturing with a standard ESD control process.

6.3 Recommended Operating Conditions

over operating free-air temperature range (unless otherwise noted)

		MIN	NOM	MAX	UNIT
V_S	Supply voltage, $V_S = (V_{S+}) - (V_{S-})$	8		32	V
DGND	DGND pin voltage	V_{S-}		$V_{S+} - 5$	V
T_A	Ambient operating air temperature	-40	25	85	°C

6.4 Thermal Information

THERMAL METRIC ⁽¹⁾		THS6222		UNIT
		RHF (VQFN)	RGT (VQFN)	
		24 PINS	16 PINS	
$R_{\theta JA}$	Junction-to-ambient thermal resistance	43.4	48.4	°C/W
$R_{\theta JC(top)}$	Junction-to-case (top) thermal resistance	35	55.1	°C/W
$R_{\theta JB}$	Junction-to-board thermal resistance	21.3	22.6	°C/W
Ψ_{JT}	Junction-to-top characterization parameter	1.3	1.6	°C/W
Y_{JB}	Junction-to-board characterization parameter	21.2	22.6	°C/W

THERMAL METRIC ⁽¹⁾		THS6222		UNIT
		RHF (VQFN)	RGT (VQFN)	
		24 PINS	16 PINS	
R _{θJC(bot)}	Junction-to-case (bottom) thermal resistance	9.3	8.6	°C/W

(1) For more information about thermal metrics, see the [Semiconductor and IC Package Thermal Metrics](#) application report.

6.5 Electrical Characteristics: V_S = 12 V

at T_A ≈ 25°C, differential closed-loop gain (A_V) = 10 V/V, differential load (R_L) = 50 Ω, series isolation resistor (R_S) = 2.5 Ω each, R_F = 1.24 kΩ, R_{ADJ} = 0 Ω, VCM = open, V_O = D1_OUT – D2_OUT, and full bias (unless otherwise noted)

PARAMETER		TEST CONDITIONS	MIN	TYP	MAX	UNIT
AC PERFORMANCE						
SSBW	Small-signal bandwidth	A _V = 5 V/V, R _F = 1.5 kΩ, V _O = 2 V _{PP}		250		MHz
		A _V = 10 V/V, R _F = 1.24 kΩ, V _O = 2 V _{PP}		180		
		A _V = 15 V/V, R _F = 1 kΩ, V _O = 2 V _{PP}		165		
	0.1-dB bandwidth flatness			17		MHz
LSBW	Large-signal bandwidth	V _O = 16 V _{PP}		195		MHz
SR	Slew rate (20% to 80%)	V _O = 16-V step		5500		V/μs
	Rise and fall time (10% to 90%)	V _O = 2 V _{PP}		2.1		ns
HD2	2nd-order harmonic distortion	A _V = 10 V/V, V _O = 2 V _{PP} , R _L = 50 Ω	Full bias, f = 1 MHz		–80	dBc
			Mid bias, f = 1 MHz		–78	
			Low bias, f = 1 MHz		–78	
			Full bias, f = 10 MHz		–61	
			Mid bias, f = 10 MHz		–61	
			Low bias, f = 10 MHz		–61	
HD3	3rd-order harmonic distortion	A _V = 10 V/V, V _O = 2 V _{PP} , R _L = 50 Ω	Full bias, f = 1 MHz		–90	dBc
			Mid bias, f = 1 MHz		–86	
			Low bias, f = 1 MHz		–83	
			Full bias, f = 10 MHz		–69	
			Mid bias, f = 10 MHz		–65	
			Low bias, f = 10 MHz		–62	
e _n	Differential input voltage noise	f ≥ 1 MHz, input-referred, with and without 100 nF noise-decoupling capacitor on VCM pin		2.5		nV/√Hz
i _{n+}	Noninverting input current noise	f ≥ 1 MHz, each amplifier		1.4		pA/√Hz
i _{n-}	Inverting input current noise	f ≥ 1 MHz, each amplifier		18		pA/√Hz
DC PERFORMANCE						
Z _{OL}	Open-loop transimpedance gain			1300		kΩ
	Input offset voltage (each amplifier)			±12		mV
		T _A = –40°C		±16		
		T _A = 85°C		±11		
	Noninverting input bias current			±1		μA
		T _A = –40°C		±1		
		T _A = 85°C		±1		
	Inverting input bias current			±8		μA
		T _A = –40°C		±7		
		T _A = 85°C		±4		

6.5 Electrical Characteristics: $V_S = 12\text{ V}$ (continued)

at $T_A \approx 25^\circ\text{C}$, differential closed-loop gain (A_V) = 10 V/V, differential load (R_L) = 50 Ω , series isolation resistor (R_S) = 2.5 Ω each, $R_F = 1.24\text{ k}\Omega$, $R_{ADJ} = 0\text{ }\Omega$, $V_{CM} = \text{open}$, $V_O = \text{D1_OUT} - \text{D2_OUT}$, and full bias (unless otherwise noted)

PARAMETER		TEST CONDITIONS	MIN	TYP	MAX	UNIT	
INPUT CHARACTERISTICS							
	Common-mode input range	Each input with respect to midsupply		± 3.0		V	
CMRR	Common-mode rejection ratio	Each input		64		dB	
		$T_A = -40^\circ\text{C}$		67			
		$T_A = 85^\circ\text{C}$		62			
	Noninverting differential input resistance			$10 \parallel 2$		$\text{k}\Omega \parallel \text{pF}$	
	Inverting input resistance			43		Ω	
COMMON-MODE BUFFER CHARACTERISTICS							
V_{CM-OS}	Common-mode offset voltage	Voltage at V_{CM} with respect to midsupply		± 2.5		mV	
		$T_A = -40^\circ\text{C}$		± 5			
		$T_A = 85^\circ\text{C}$		± 1			
	Common-mode voltage noise	With and without 100-nF V_{CM} noise-decoupling capacitor, $f \geq 50\text{ kHz}$		20		$\text{nV}/\sqrt{\text{Hz}}$	
	Common-mode output resistance	$f = \text{DC}$	AC-coupled inputs	650		Ω	
			DC-coupled inputs	520		Ω	
OUTPUT CHARACTERISTICS							
V_O	Output voltage swing	$R_L = 100\text{ }\Omega$, $R_S = 0\text{ }\Omega$		± 9.7		V	
		$R_L = 50\text{ }\Omega$, $R_S = 0\text{ }\Omega$		± 9.3			
		$R_L = 25\text{ }\Omega$, $R_S = 0\text{ }\Omega$		± 8.4			
I_O	Output current (sourcing and sinking)	$R_L = 25\text{ }\Omega$, $R_S = 0\text{ }\Omega$, based on V_O specification		± 338		mA	
	Short-circuit output current			± 0.81		A	
Z_O	Closed-loop output impedance	$f = 1\text{ MHz}$, differential		0.03		Ω	
POWER SUPPLY							
V_S	Operating voltage			8	12	32	V
		$T_A = -40^\circ\text{C}$ to $+85^\circ\text{C}$		8		32	
DGND	DGND pin voltage			V_{S-}	0	$V_{S+} - 5$	V
I_{S+}	Quiescent current	Full bias (BIAS-1 = 0, BIAS-2 = 0)		19.5		mA	
		Mid bias (BIAS-1 = 1, BIAS-2 = 0)		15			
		Low bias (BIAS-1 = 0, BIAS-2 = 1)		10.4			
		Bias off (BIAS-1 = 1, BIAS-2 = 1)		1.1			
I_{S-}	Quiescent current	Full bias (BIAS-1 = 0, BIAS-2 = 0)		18.8		mA	
		Mid bias (BIAS-1 = 1, BIAS-2 = 0)		14.4			
		Low bias (BIAS-1 = 0, BIAS-2 = 1)		9.8			
		Bias off (BIAS-1 = 1, BIAS-2 = 1)		0.4			
	Current through DGND pin	Full bias (BIAS-1 = 0, BIAS-2 = 0)		0.8		mA	
+PSRR	Positive power-supply rejection ratio	Differential		83		dB	
-PSRR	Negative power-supply rejection ratio	Differential		83		dB	
BIAS CONTROL							
	Bias control pin voltage range	With respect to DGND, $T_A = -40^\circ\text{C}$ to $+85^\circ\text{C}$		0	3.3	12	V

6.5 Electrical Characteristics: $V_S = 12\text{ V}$ (continued)

at $T_A \approx 25^\circ\text{C}$, differential closed-loop gain (A_V) = 10 V/V, differential load (R_L) = 50 Ω , series isolation resistor (R_S) = 2.5 Ω each, $R_F = 1.24\text{ k}\Omega$, $R_{ADJ} = 0\ \Omega$, $V_{CM} = \text{open}$, $V_O = D1_OUT - D2_OUT$, and full bias (unless otherwise noted)

PARAMETER		TEST CONDITIONS	MIN	TYP	MAX	UNIT
	Bias control pin logic threshold	Logic 1, with respect to DGND, $T_A = -40^\circ\text{C}$ to $+85^\circ\text{C}$	2.1			V
		Logic 0, with respect to DGND, $T_A = -40^\circ\text{C}$ to $+85^\circ\text{C}$	0.8			
	Bias control pin current ⁽¹⁾	BIAS-1, BIAS-2 = 0.5 V (logic 0)	-9.6			μA
		BIAS-1, BIAS-2 = 3.3 V (logic 1)	0.3			
	Open-loop output impedance	Off bias (BIAS-1 = 1, BIAS-2 = 1)	70 5			$\text{M}\Omega$ pF

(1) Current is considered positive out of the pin.

6.6 Electrical Characteristics: $V_S = 32\text{ V}$

at $T_A \approx 25^\circ\text{C}$, differential closed-loop gain (A_V) = 10 V/V, differential load (R_L) = 100 Ω , $R_F = 1.24\text{ k}\Omega$, $R_{ADJ} = 0\ \Omega$, $V_{CM} = \text{open}$, $V_O = D1_OUT - D2_OUT$, and full bias (unless otherwise noted)

PARAMETER		TEST CONDITIONS	MIN	TYP	MAX	UNIT
AC PERFORMANCE						
SSBW	Small-signal bandwidth, -3 dB	$A_V = 5\text{ V/V}$, $R_F = 1.5\text{ k}\Omega$, $V_O = 2\text{ V}_{PP}$	285			MHz
		$A_V = 10\text{ V/V}$, $R_F = 1.24\text{ k}\Omega$, $V_O = 2\text{ V}_{PP}$	205			
	0.1-dB bandwidth flatness		13			MHz
LSBW	Large-signal bandwidth	$V_O = 40\text{ V}_{PP}$	170			MHz
SR	Slew rate (20% to 80% level)	$V_O = 40\text{-V}$ step	11,000			$\text{V}/\mu\text{s}$
	Rise and fall time	$V_O = 2\text{ V}_{PP}$	2			ns
HD2	2nd-order harmonic distortion	$A_V = 10\text{ V/V}$, $V_O = 2\text{ V}_{PP}$, $R_L = 100\ \Omega$	Full bias, $f = 1\text{ MHz}$	-86		dBc
			Low bias, $f = 1\text{ MHz}$	-79		
			Full bias, $f = 10\text{ MHz}$	-71		
			Low bias, $f = 10\text{ MHz}$	-63		
HD3	3rd-order harmonic distortion	$A_V = 10\text{ V/V}$, $V_O = 2\text{ V}_{PP}$, $R_L = 100\ \Omega$	Full bias, $f = 1\text{ MHz}$	-101		dBc
			Low bias, $f = 1\text{ MHz}$	-88		
			Full bias, $f = 10\text{ MHz}$	-80		
			Low bias, $f = 10\text{ MHz}$	-65		
e_n	Differential input voltage noise	$f \geq 1\text{ MHz}$, input-referred	2.5			$\text{nV}/\sqrt{\text{Hz}}$
i_{n+}	Noninverting input current noise (each amplifier)	$f \geq 1\text{ MHz}$	1.7			$\text{pA}/\sqrt{\text{Hz}}$
i_{n-}	Inverting input current noise (each amplifier)	$f \geq 1\text{ MHz}$	18			$\text{pA}/\sqrt{\text{Hz}}$
DC PERFORMANCE						
Z_{OL}	Open-loop transimpedance gain		1500			$\text{k}\Omega$
	Input offset voltage		± 12			mV
	Input offset voltage drift	$T_A = -40^\circ\text{C}$ to $+85^\circ\text{C}$	-40			$\mu\text{V}/^\circ\text{C}$
	Input offset voltage matching	Amplifier A to B	± 0.5			mV
	Noninverting input bias current		± 1			μA
	Inverting input bias current		± 6			μA
	Inverting input bias current matching		± 8			μA

6.6 Electrical Characteristics: $V_S = 32\text{ V}$ (continued)

at $T_A \approx 25^\circ\text{C}$, differential closed-loop gain (A_V) = 10 V/V, differential load (R_L) = 100 Ω , $R_F = 1.24\text{ k}\Omega$, $R_{ADJ} = 0\ \Omega$, $V_{CM} =$ open, $V_O = D1_OUT - D2_OUT$, and full bias (unless otherwise noted)

PARAMETER	TEST CONDITIONS	MIN	TYP	MAX	UNIT	
INPUT CHARACTERISTICS						
	Common-mode input range	Each input	± 11	± 12	V	
CMRR	Common-mode rejection ratio	Each input	53	65	dB	
	Noninverting input resistance		10 2		k Ω pF	
	Inverting input resistance		38		Ω	
COMMON-MODE BUFFER CHARACTERISTICS						
V_{CM-OS}	Common-mode offset voltage	Voltage at V_{CM} with respect to midsupply		± 3.9	mV	
	Common-mode voltage noise	With and without 100-nF V_{CM} noise-decoupling capacitor, $f \geq 50\text{ kHz}$		21	nV/ $\sqrt{\text{Hz}}$	
	Common-mode output resistance	$f = \text{DC}$		520	Ω	
OUTPUT CHARACTERISTICS						
V_O	Output voltage swing ⁽¹⁾	$R_L = 100\ \Omega$		± 28.5	V	
		$R_L = 25\ \Omega$		± 16.3		
I_O	Output current (sourcing and sinking) ⁽¹⁾	$R_L = 25\ \Omega$, based on V_O specification	± 580	± 665	mA	
		Short-circuit output current		1		A
Z_O	Output impedance	$f = 1\text{ MHz}$, differential		0.01	Ω	
POWER SUPPLY						
V_S	Operating voltage		8	12	32	V
		$T_A = -40^\circ\text{C}$ to $+85^\circ\text{C}$	8		32	
I_{S+}	Quiescent current	Full bias (BIAS-1 = 0, BIAS-2 = 0)		23		mA
		Mid bias (BIAS-1 = 1, BIAS-2 = 0)		17.7		
		Low bias (BIAS-1 = 0, BIAS-2 = 1)		12.2		
		Bias off (BIAS-1 = 1, BIAS-2 = 1)		1.5	1.8	
I_{S-}	Quiescent current	Full bias (BIAS-1 = 0, BIAS-2 = 0)		22		mA
		Mid bias (BIAS-1 = 1, BIAS-2 = 0)		16.7		
		Low bias (BIAS-1 = 0, BIAS-2 = 1)		11.2		
		Bias off (BIAS-1 = 1, BIAS-2 = 1)		0.5	0.8	
	Current through GND pin	Full bias (BIAS-1 = 0, BIAS-2 = 0)		1		mA
+PSRR	Positive power-supply rejection ratio	Differential		83		dB
-PSRR	Negative power-supply rejection ratio	Differential		77		dB
BIAS CONTROL						
	Bias control pin range	With respect to DGND, $T_A = -40^\circ\text{C}$ to $+85^\circ\text{C}$	0	3.3	16.5	V
	Bias control pin logic threshold	Logic 1, with respect to DGND, $T_A = -40^\circ\text{C}$ to $+85^\circ\text{C}$	1.9			V
		Logic 0, with respect to DGND, $T_A = -40^\circ\text{C}$ to $+85^\circ\text{C}$			0.8	
	Bias control pin current ⁽²⁾	BIAS-1, BIAS-2 = 0.5 V (logic 0)	-15	-10		μA
		BIAS-1, BIAS-2 = 3.3 V (logic 1)		0.1	1	

(1) See [Output Voltage and Current Drive](#) and [Figure 6-51](#) for output voltage vs output current characteristics.

(2) Current is considered positive out of the pin.

6.7 Timing Requirements

		MIN	NOM	MAX	UNIT
t_{ON}	Turnon time delay: time for output to start tracking the input		25		ns
t_{OFF}	Turnoff time delay: time for output to stop tracking the input		275		ns

6.8 Typical Characteristics: $V_S = 12\text{ V}$

At $T_A \approx 25^\circ\text{C}$, $A_V = 10\text{ V/V}$, $R_F = 1.24\text{ k}\Omega$, $R_L = 50\ \Omega$, $R_S = 2.5\ \Omega$, $R_{ADJ} = 0\ \Omega$, full-bias mode, and $V_{CM} = \text{open}$ (unless otherwise noted).

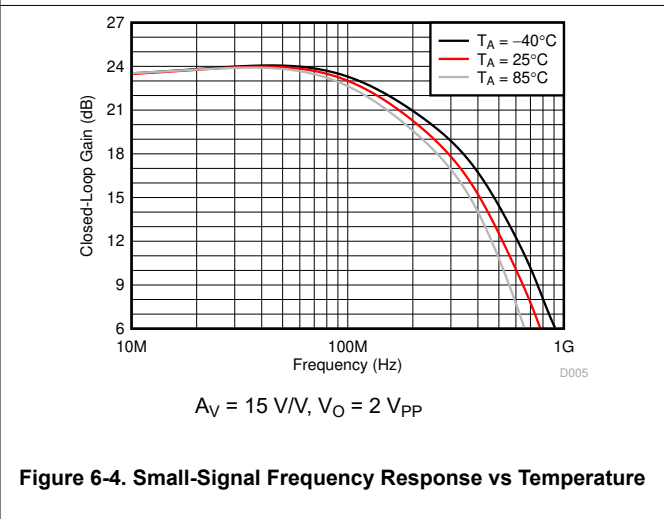
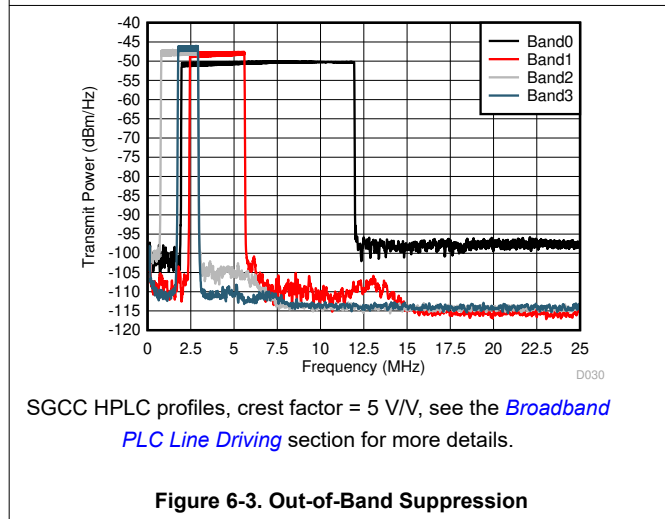
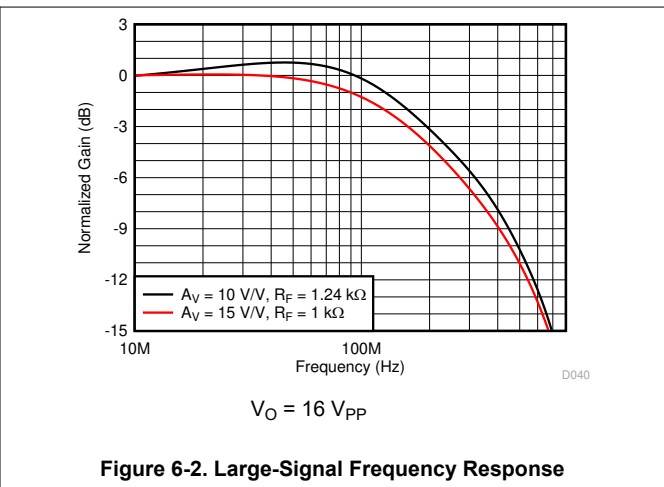
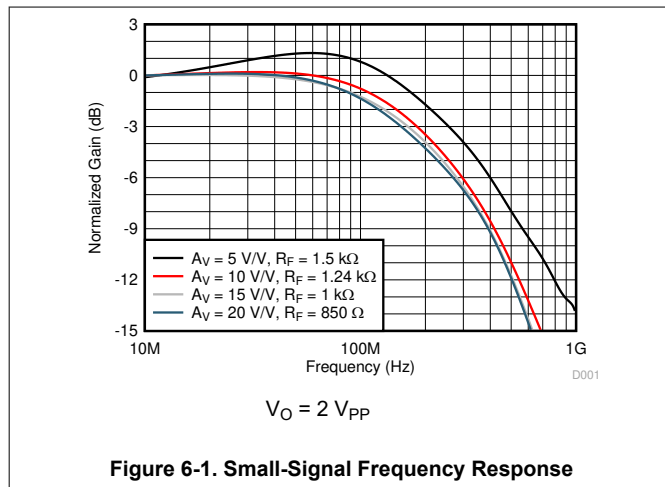

6.8 Typical Characteristics: $V_S = 12\text{ V}$ (continued)

At $T_A \approx 25^\circ\text{C}$, $A_V = 10\text{ V/V}$, $R_F = 1.24\text{ k}\Omega$, $R_L = 50\ \Omega$, $R_S = 2.5\ \Omega$, $R_{ADJ} = 0\ \Omega$, full-bias mode, and $V_{CM} = \text{open}$ (unless otherwise noted).

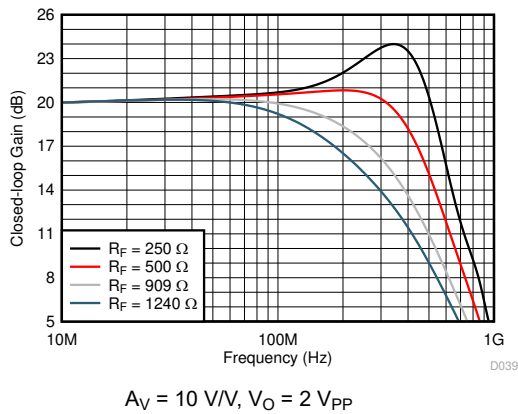

Figure 6-5. Small-Signal Frequency Response vs R_F

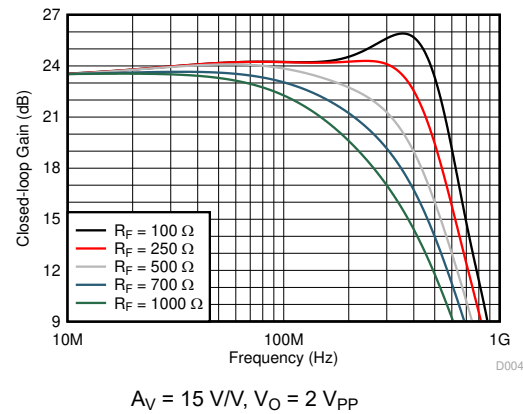

Figure 6-6. Small-Signal Frequency Response vs R_F

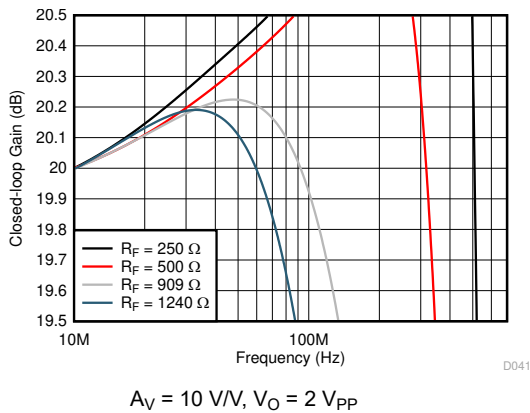

Figure 6-7. Small-Signal Gain Flatness vs R_F

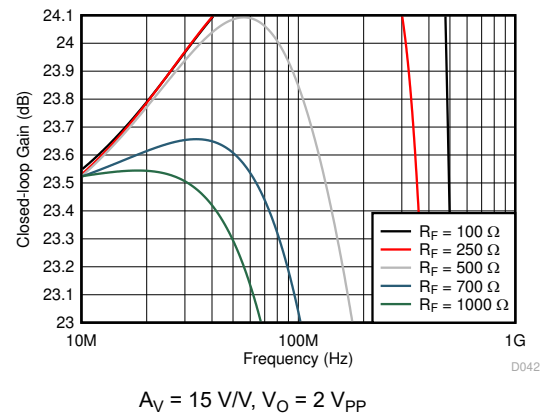

Figure 6-8. Small-Signal Gain Flatness vs R_F

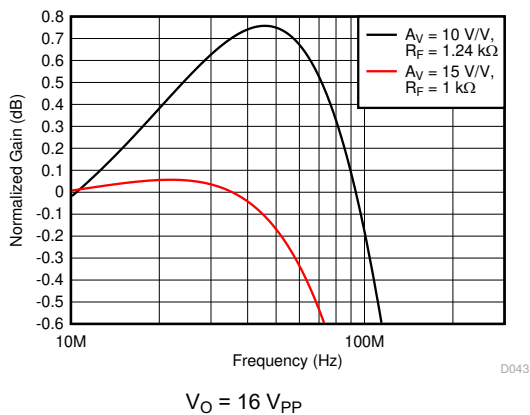
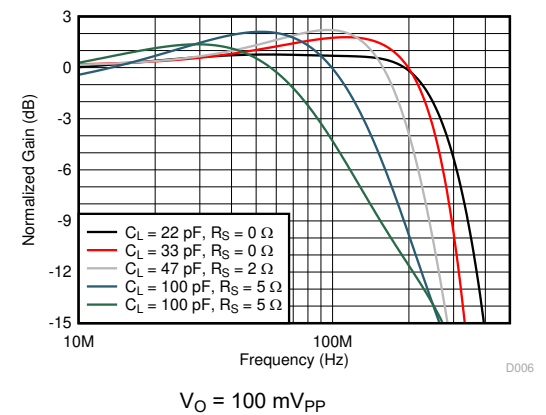

Figure 6-9. Large-Signal Gain Flatness



Frequency response is measured at the device output pin before the isolation resistor.

Figure 6-10. Small-Signal Frequency Response vs C_{LOAD}

6.8 Typical Characteristics: $V_S = 12\text{ V}$ (continued)

At $T_A \approx 25^\circ\text{C}$, $A_V = 10\text{ V/V}$, $R_F = 1.24\text{ k}\Omega$, $R_L = 50\ \Omega$, $R_S = 2.5\ \Omega$, $R_{ADJ} = 0\ \Omega$, full-bias mode, and $V_{CM} = \text{open}$ (unless otherwise noted).

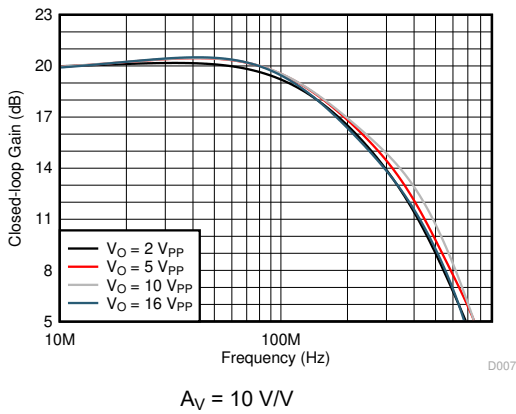

Figure 6-11. Large-Signal Frequency Response vs V_O

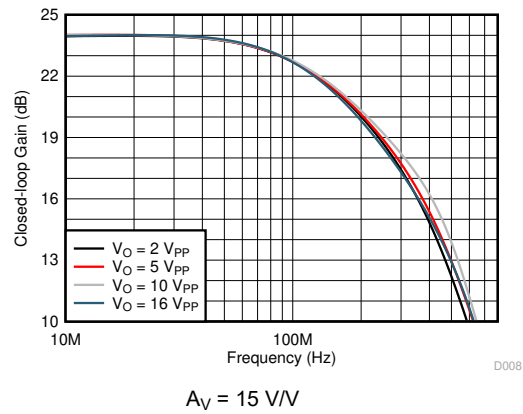

Figure 6-12. Large-Signal Frequency Response vs V_O

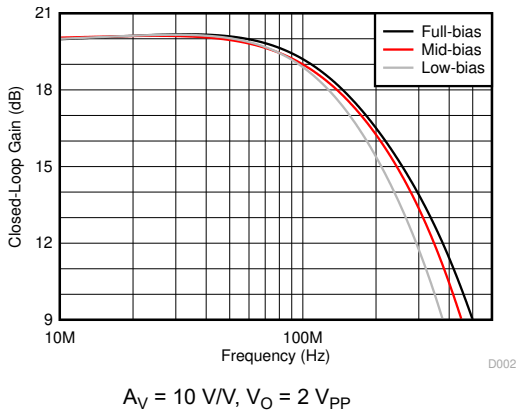

Figure 6-13. Small-Signal Frequency Response vs Bias Modes

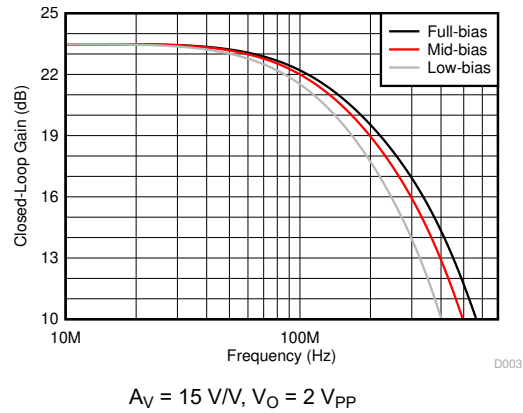

Figure 6-14. Small-Signal Frequency Response vs Bias Modes

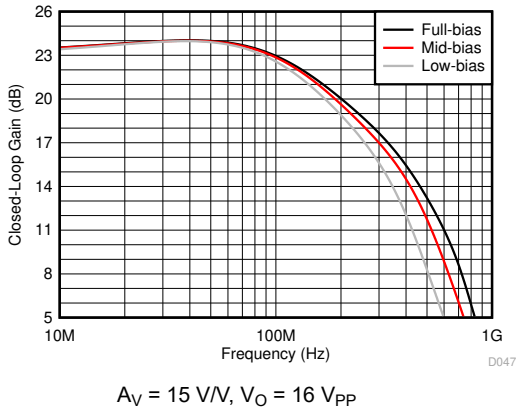

Figure 6-15. Large-Signal Frequency Response vs Bias Modes

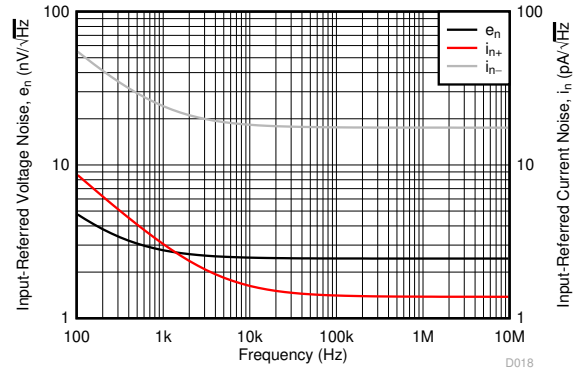

Figure 6-16. Input Voltage and Current Noise Density vs Frequency

6.8 Typical Characteristics: $V_S = 12\text{ V}$ (continued)

At $T_A \approx 25^\circ\text{C}$, $A_V = 10\text{ V/V}$, $R_F = 1.24\text{ k}\Omega$, $R_L = 50\ \Omega$, $R_S = 2.5\ \Omega$, $R_{ADJ} = 0\ \Omega$, full-bias mode, and $V_{CM} = \text{open}$ (unless otherwise noted).

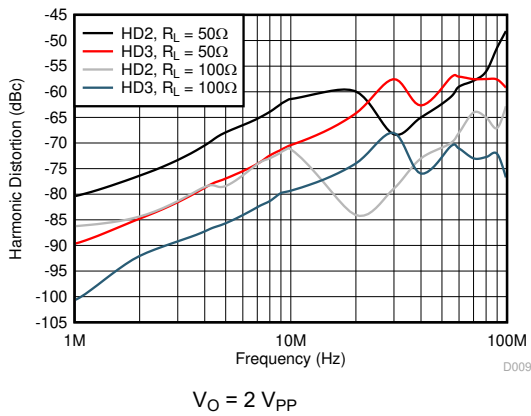

Figure 6-17. Harmonic Distortion vs Frequency

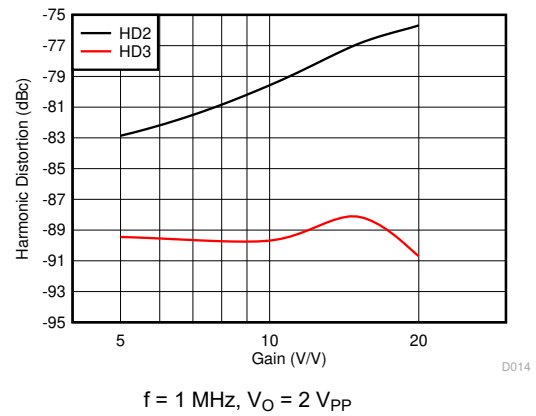

Figure 6-18. Harmonic Distortion vs Gain

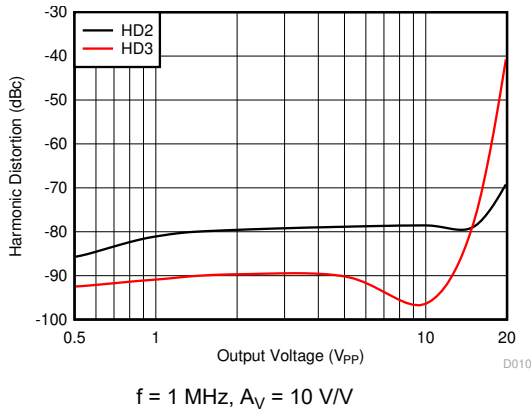

Figure 6-19. Harmonic Distortion vs V_O

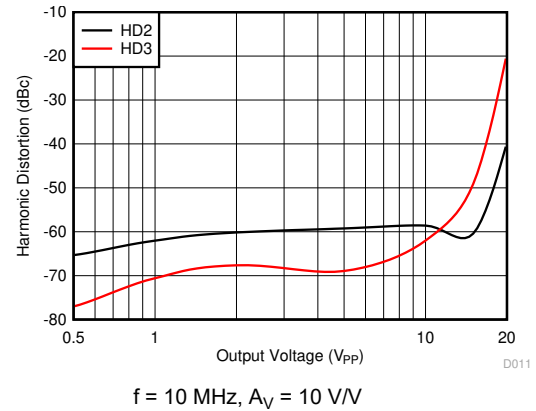

Figure 6-20. Harmonic Distortion vs V_O

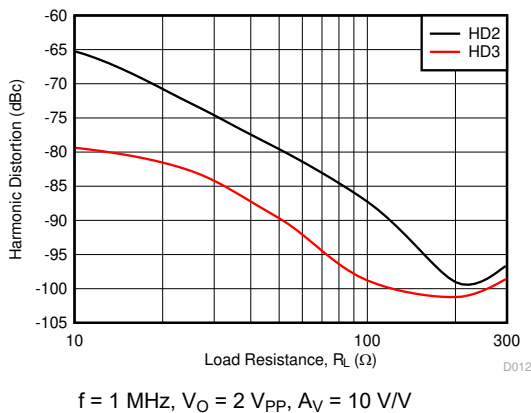

Figure 6-21. Harmonic Distortion vs R_L

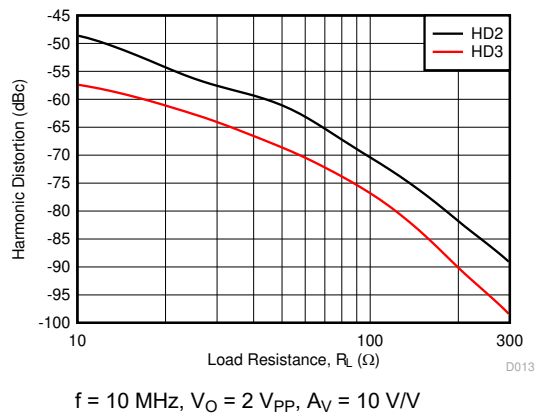

Figure 6-22. Harmonic Distortion vs R_L

6.8 Typical Characteristics: $V_S = 12\text{ V}$ (continued)

At $T_A \approx 25^\circ\text{C}$, $A_V = 10\text{ V/V}$, $R_F = 1.24\text{ k}\Omega$, $R_L = 50\ \Omega$, $R_S = 2.5\ \Omega$, $R_{ADJ} = 0\ \Omega$, full-bias mode, and $V_{CM} = \text{open}$ (unless otherwise noted).

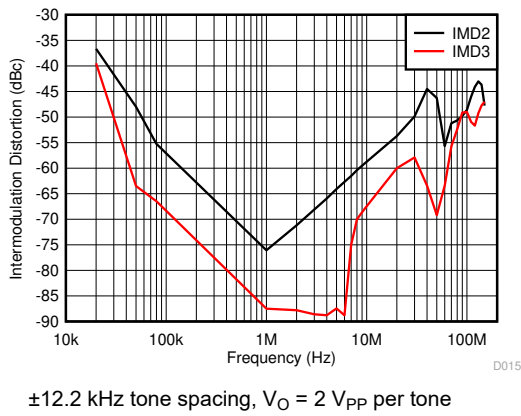

Figure 6-23. Intermodulation Distortion vs Frequency

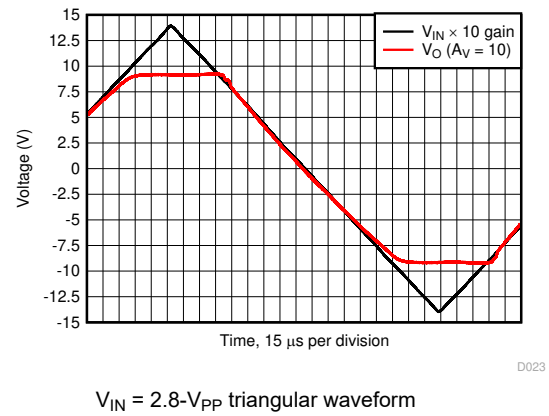

Figure 6-24. Overdrive Recovery

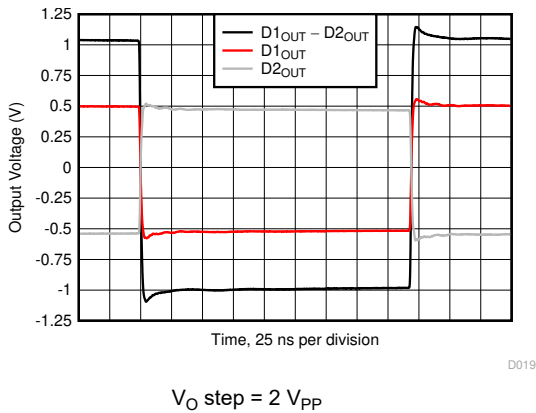

Figure 6-25. Small-Signal Pulse Response

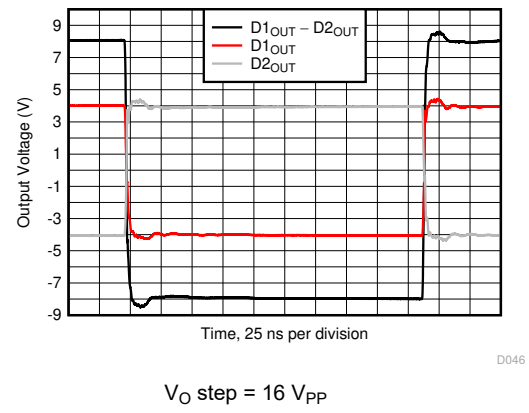

Figure 6-26. Large-Signal Pulse Response

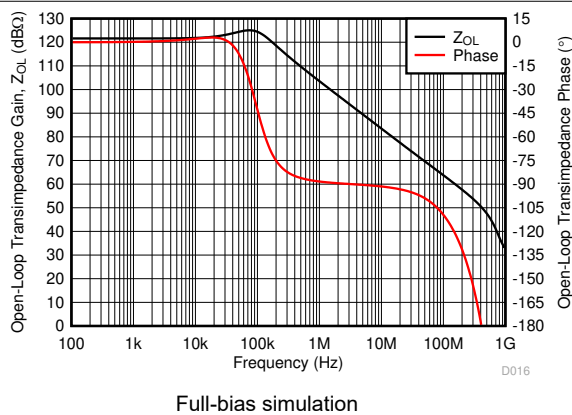

Figure 6-27. Open-Loop Transimpedance Gain and Phase vs Frequency

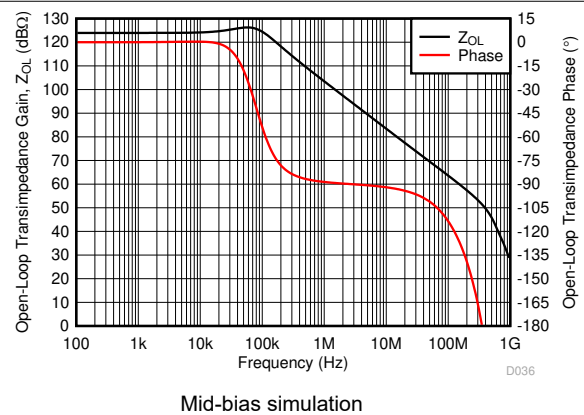
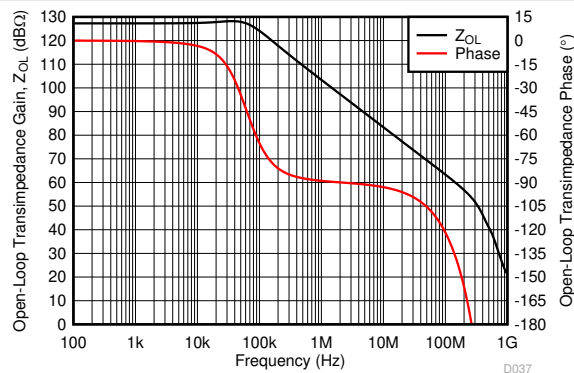

Figure 6-28. Open-Loop Transimpedance Gain and Phase vs Frequency

6.8 Typical Characteristics: $V_S = 12\text{ V}$ (continued)

At $T_A \approx 25^\circ\text{C}$, $A_V = 10\text{ V/V}$, $R_F = 1.24\text{ k}\Omega$, $R_L = 50\ \Omega$, $R_S = 2.5\ \Omega$, $R_{ADJ} = 0\ \Omega$, full-bias mode, and $V_{CM} = \text{open}$ (unless otherwise noted).



Low-bias simulation

Figure 6-29. Open-Loop Transimpedance Gain and Phase vs Frequency

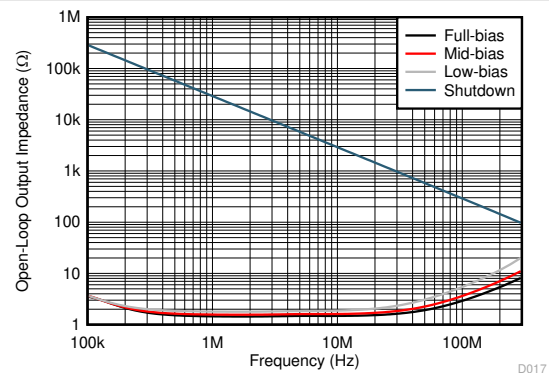

Simulation

Figure 6-30. Open-Loop Output Impedance vs Frequency

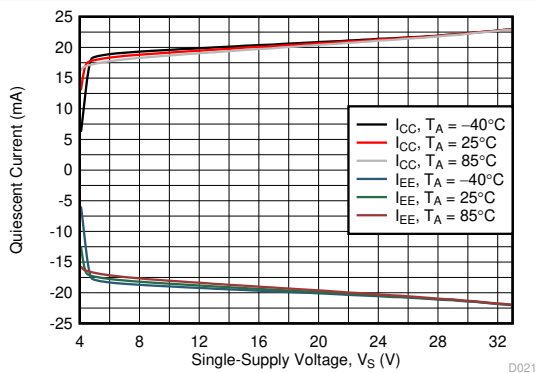

$R_L = \text{no load}$, average of 30 devices

Figure 6-31. Quiescent Current vs Single-Supply Voltage

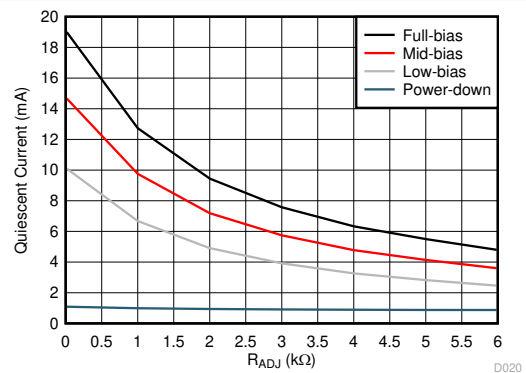

Average of 30 devices

Figure 6-32. Quiescent Current vs R_{ADJ}

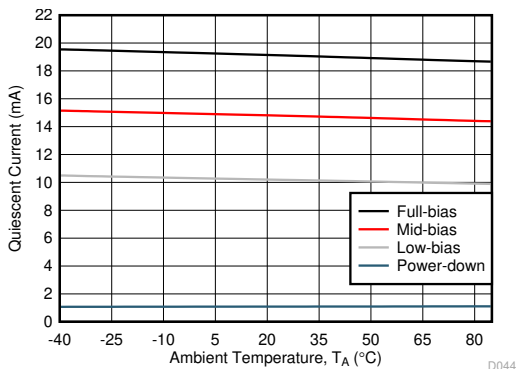

$R_L = \text{no load}$, average of 30 devices

Figure 6-33. Quiescent Current vs Temperature

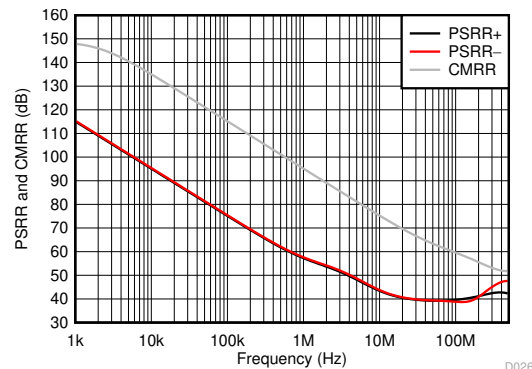

$T_J = 50^\circ\text{C}$, simulation

Figure 6-34. PSRR and CMRR vs Frequency

6.8 Typical Characteristics: $V_S = 12\text{ V}$ (continued)

At $T_A \approx 25^\circ\text{C}$, $A_V = 10\text{ V/V}$, $R_F = 1.24\text{ k}\Omega$, $R_L = 50\ \Omega$, $R_S = 2.5\ \Omega$, $R_{ADJ} = 0\ \Omega$, full-bias mode, and $V_{CM} = \text{open}$ (unless otherwise noted).

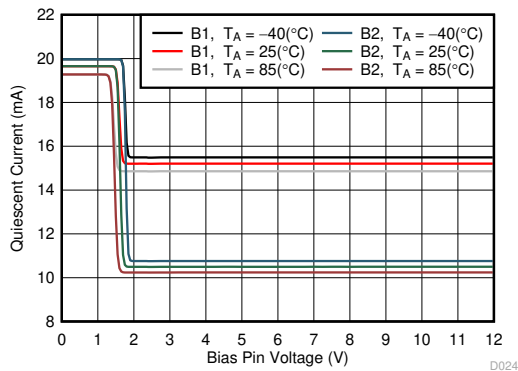

B1 = full-bias to mid-bias transition with B2 = DGND, B2 = full-bias to low-bias transition with B1 = DGND, DGND = V_{S-}

Figure 6-35. Mode Transition Voltage Threshold

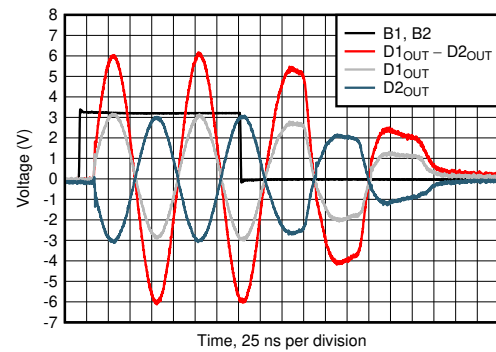

Figure 6-36. Full-Bias and Shutdown Mode Transition Timing

6.9 Typical Characteristics: $V_S = 32\text{ V}$

At $T_A \approx 25^\circ\text{C}$, $A_V = 10\text{ V/V}$, $R_F = 1.24\text{ k}\Omega$, $R_L = 100\ \Omega$, $R_S = 2.5\ \Omega$, $R_{ADJ} = 0\ \Omega$, full-bias mode, and $V_{CM} = \text{open}$ (unless otherwise noted).

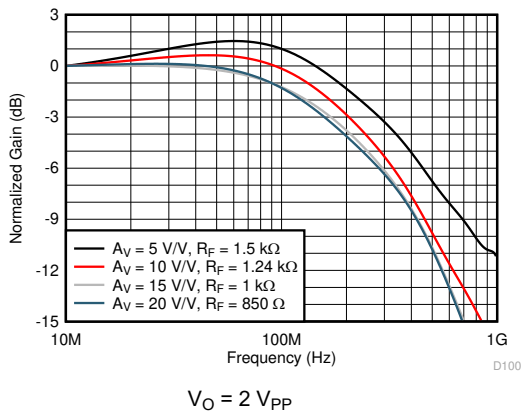

Figure 6-37. Small-Signal Frequency Response

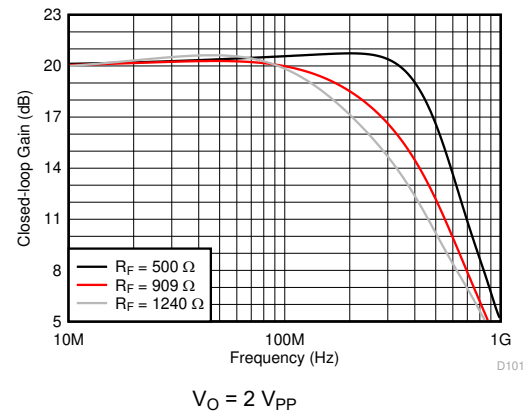

Figure 6-38. Small-Signal Frequency Response vs R_F

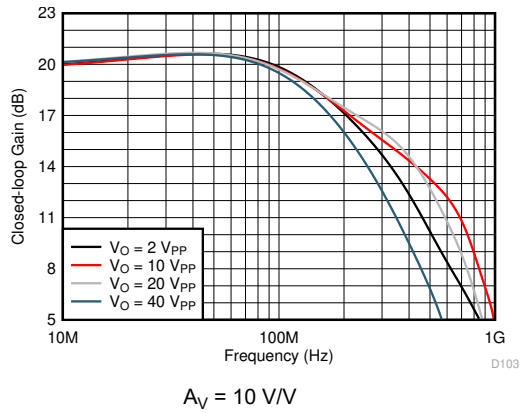

Figure 6-39. Large-Signal Frequency Response vs V_O

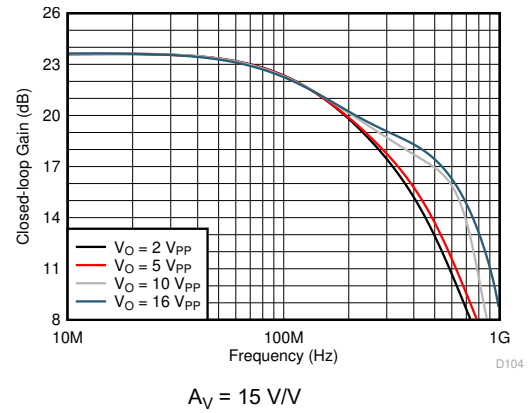

Figure 6-40. Large-Signal Frequency Response vs V_O

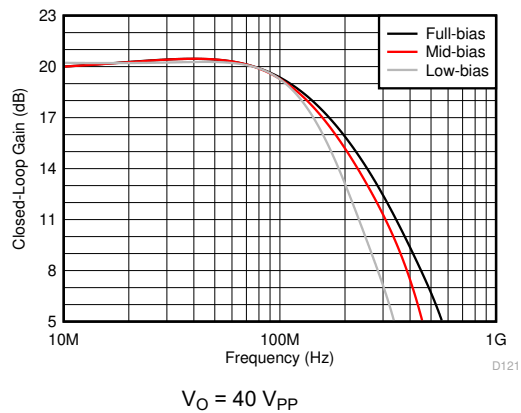

Figure 6-41. Large-Signal Frequency Response vs Bias Modes

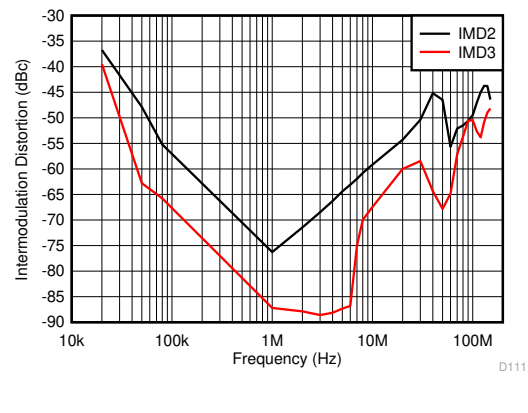

Figure 6-42. Intermodulation Distortion vs Frequency

6.9 Typical Characteristics: $V_S = 32\text{ V}$ (continued)

At $T_A \approx 25^\circ\text{C}$, $A_V = 10\text{ V/V}$, $R_F = 1.24\text{ k}\Omega$, $R_L = 100\ \Omega$, $R_S = 2.5\ \Omega$, $R_{ADJ} = 0\ \Omega$, full-bias mode, and $V_{CM} = \text{open}$ (unless otherwise noted).

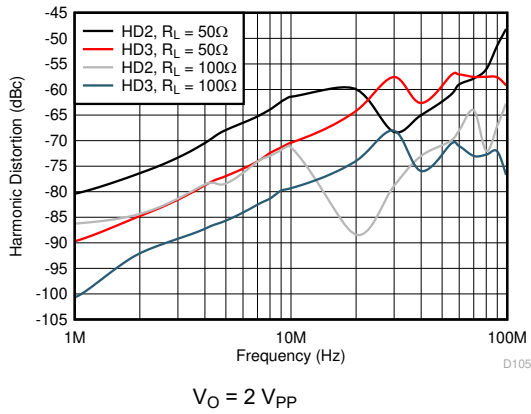

Figure 6-43. Harmonic Distortion vs Frequency

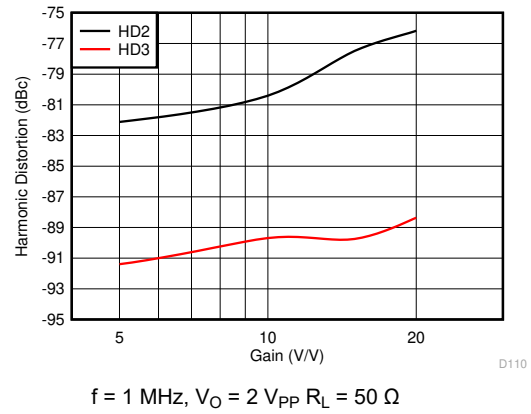

Figure 6-44. Harmonic Distortion vs Gain

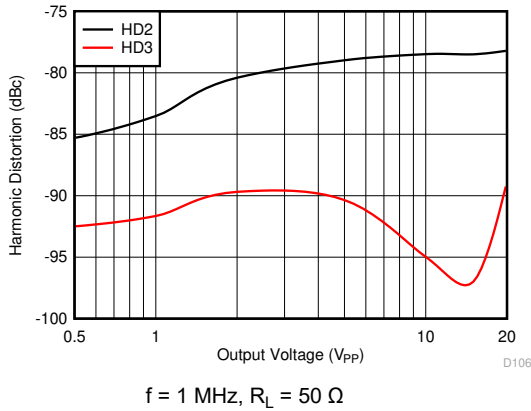

Figure 6-45. Harmonic Distortion vs V_O

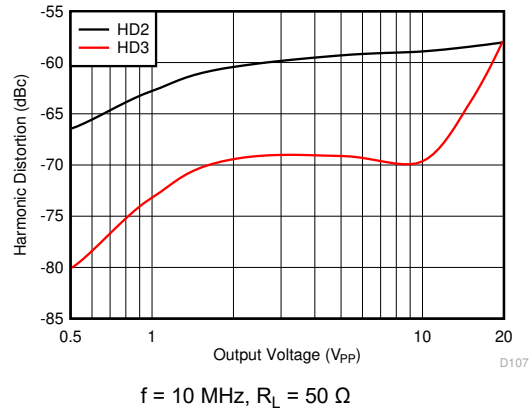

Figure 6-46. Harmonic Distortion vs V_O

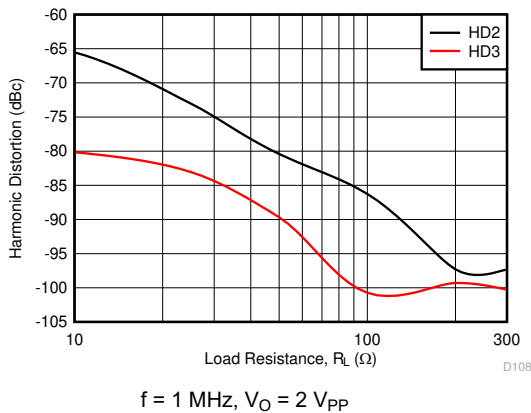

Figure 6-47. Harmonic Distortion vs R_L

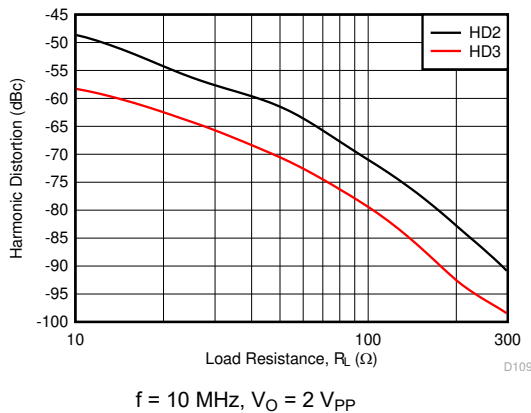

Figure 6-48. Harmonic Distortion vs R_L

6.9 Typical Characteristics: $V_S = 32\text{ V}$ (continued)

At $T_A \approx 25^\circ\text{C}$, $A_V = 10\text{ V/V}$, $R_F = 1.24\text{ k}\Omega$, $R_L = 100\ \Omega$, $R_S = 2.5\ \Omega$, $R_{ADJ} = 0\ \Omega$, full-bias mode, and $V_{CM} = \text{open}$ (unless otherwise noted).

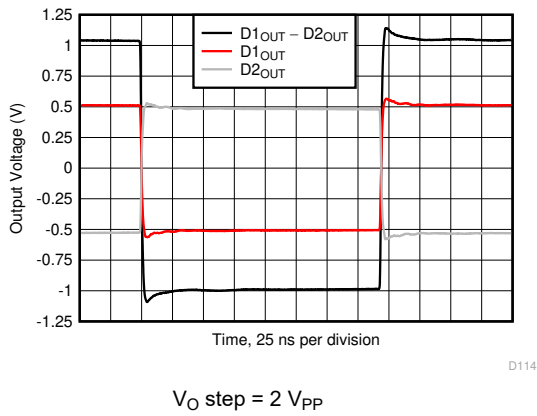

Figure 6-49. Small-Signal Pulse Response

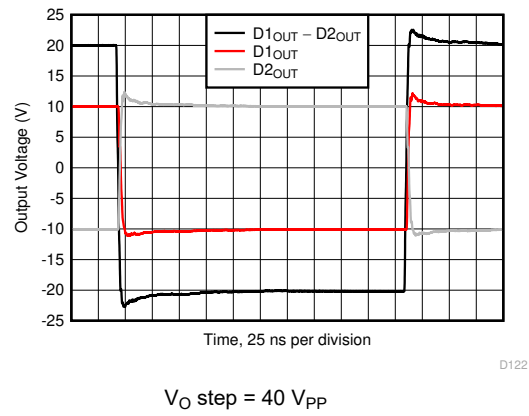
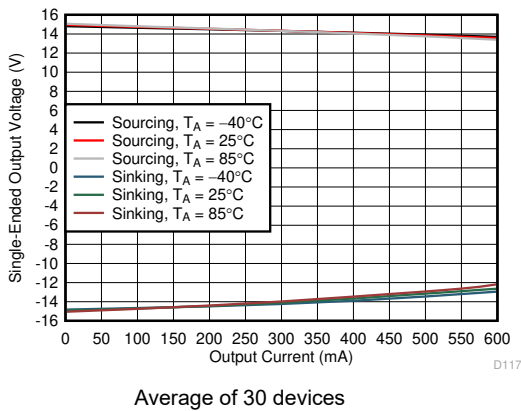

Figure 6-50. Large-Signal Pulse Response



Output voltage is slammed and I_O is pulsed to maintain T_J as close to T_A as possible.

Figure 6-51. Single-Ended Output Voltage vs I_O and Temperature

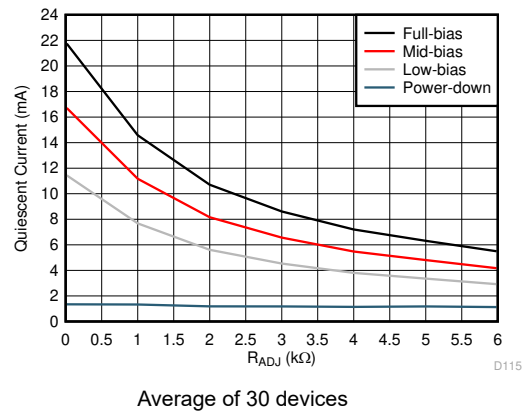

Figure 6-52. Quiescent Current vs R_{ADJ}

7 Detailed Description

7.1 Overview

The THS6222 is a differential line-driver amplifier with a current-feedback architecture. The device is targeted for use in line-driver applications such as narrow-band and broadband power-line communications (PLC) that are often found in smart metering and home networking applications.

The THS6222 is designed as a single-port differential line driver solution that can be a drop-in replacement for the THS6212. The integrated common-mode buffer featured in the THS6222 reduces the number of external components required for level shifting the input common-mode voltage in PLC applications that are often ac coupled, resulting in space savings on the circuit board and reducing the overall system cost. The THS6222 uses an architecture that does not allow using the two current-feedback amplifiers, D1 and D2, independently; therefore, these amplifiers must always be driven differentially.

The architecture of the THS6222 is designed to provide maximum flexibility with adjustable power modes that are selectable based on application performance requirements, and also provides an external current adjustment pin (IADJ) to further optimize the quiescent power of the device. The wide output swing (18.6 V_{PP}) into 50-Ω differential loads with 12-V power supplies and high current drive of the THS6222 make the device ideally suited for high-power, line-driving applications. By using 32-V power supplies and with good thermal design that keep the device within the safe operating temperature, the THS6222 is capable of swinging 57 V_{PP} into 100-Ω loads.

7.2 Functional Block Diagram

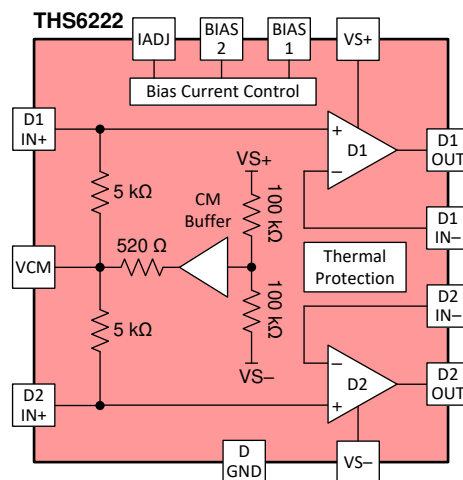

7.3 Feature Description

7.3.1 Common-Mode Buffer

The THS6222 is a differential line driver that features an integrated common-mode buffer. Most common line driving applications for the THS6222 are ac-coupled applications; see [Figure 8-2](#). Therefore, the inputs must be common-mode shifted to ensure the input signals are within the common-mode specifications of the device. To maximize the dynamic range, the common-mode voltage is shifted to midsupply in most ac-coupled applications. With the integrated common-mode buffer, no external components are required to shift the input common-mode voltage. Often, engineers choose to connect a noise-decoupling capacitor to the VCM pin. However, as shown in [Figure 7-1](#), assuming the circuit is reasonably shielded from external noise sources, no difference in common-mode noise is observed with the 100 nF capacitor or without the capacitor.

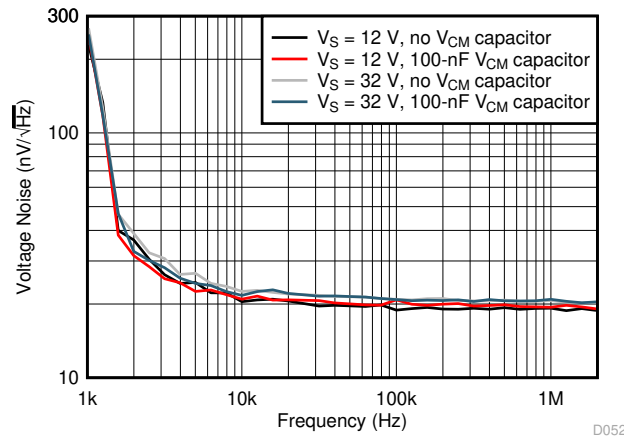

Figure 7-1. Common-Mode Voltage Noise Density vs Frequency

There are ESD protection diodes in series directly at the output of the common-mode buffer between the internal 520 Ω resistor and the common-mode buffer output. These diodes are referenced to midsupply. Any voltage that is 1.4 V above or below the midsupply applied to the VCM pin forward biases the protection diodes. This biasing results in either current flowing into or out of the VCM pin. The current is limited by the 520 Ω resistor in series, but to prevent permanent damage to the device, the current must be limited to the current specifications in the [Absolute Maximum Ratings](#) table.

7.3.2 Thermal Protection and Package Power Dissipation

The THS6222 is designed with thermal protection that automatically puts the device in shutdown mode when the junction temperature reaches approximately 175°C. In this mode, the device behavior is the same as if the bias pins are used to power-down the device. The device resumes normal operation when the junction temperature reaches approximately 145°C. In general, the thermal shutdown condition must be avoided. If and when the thermal protection triggers, thermal cycling occurs where the device repeatedly goes in and out of thermal shutdown until the junction temperature stabilizes to a value that prevents thermal shutdown.

A common technique to calculate the maximum power dissipation that a device can withstand is by using the junction-to-ambient thermal resistance ($R_{\theta JA}$), provided in the [Thermal Information](#) table. Using the equation $\text{power dissipation} = (\text{junction temperature, } T_J - \text{ambient temperature, } T_A) / R_{\theta JA}$, the amount of power a package can dissipate can be estimated. [Figure 7-2](#) illustrates the package power dissipation based on this equation to reach junction temperatures of 125°C and 150°C at various ambient temperatures. The $R_{\theta JA}$ value is determined using industry standard JEDEC specifications and allows ease of comparing various packages. Power greater than that in [Figure 7-2](#) can be dissipated in a package by good printed circuit board (PCB) thermal design, using heat sinks, and or active cooling techniques. See the [Thermal Design By Insight, Not Hindsight](#) application report for an in-depth discussion on thermal design.

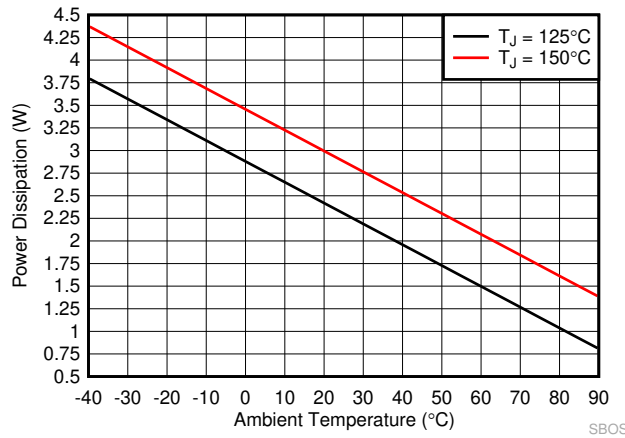

Figure 7-2. Package Power Dissipation vs Ambient Temperature

7.3.3 Output Voltage and Current Drive

The THS6222 provides output voltage and current capabilities that are unsurpassed in a low-cost, monolithic op amp. Under no load at room temperature, the output voltage typically swings closer than 1.1 V to either supply rail and typically swings to within 1.1 V of either supply with a 100 Ω differential load. The THS6222 can deliver over 350 mA of current with a 25 Ω load.

Good thermal design of the system is important, including use of heat sinks and active cooling methods, if the THS6222 is pushed to the limits of its output drive capabilities. Figure 7-3 and Figure 7-4 show the output drive of the THS6222 under two different sets of conditions where T_A is approximately equal to T_J . In practical applications, T_J is often much higher than T_A and is highly dependent on the device configuration, signal parameters, and PCB thermal design. In order to represent the full output drive capability of the THS6222 in Figure 7-3 and Figure 7-4, $T_J \approx T_A$ is achieved by pulsing or sweeping the output current for a duration of less than 100 ms.

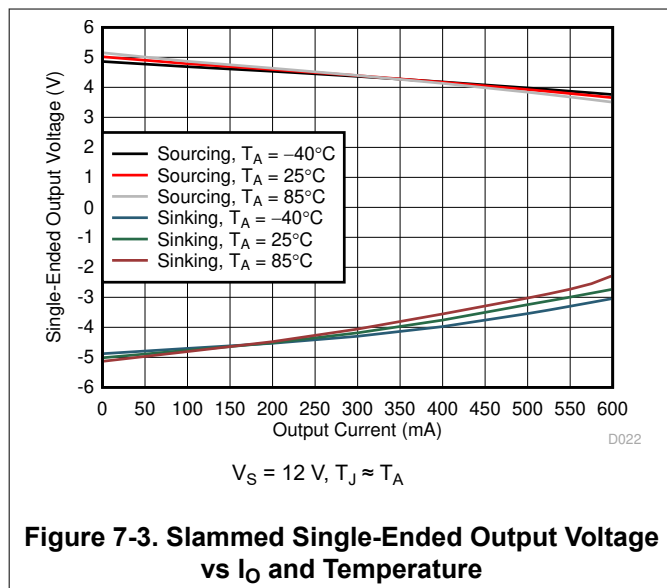

Figure 7-3. Slammed Single-Ended Output Voltage vs I_O and Temperature

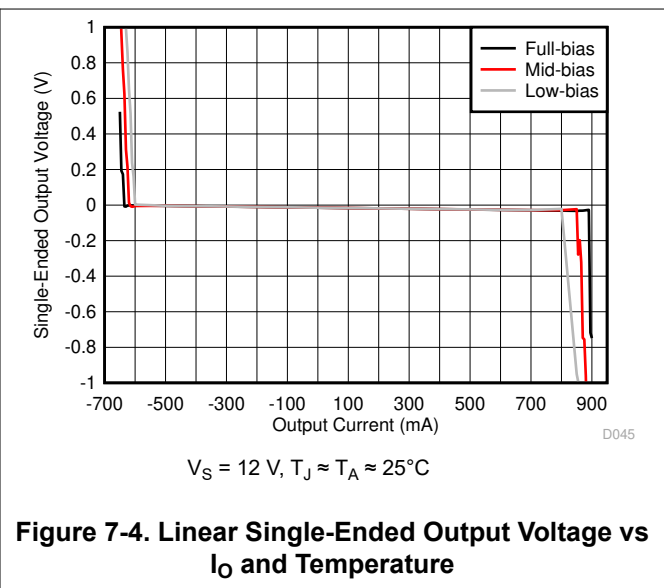

Figure 7-4. Linear Single-Ended Output Voltage vs I_O and Temperature

In Figure 7-3, the output voltages are differentially slammed to the rail and the output current is single-endedly sourced or sunk using a source measure unit (SMU) for less than 100 ms. The single-ended output voltage of each output is then measured prior to removing the load current. After removing the load current, the outputs are brought back to mid-supply before repeating the measurement for different load currents. This entire process is repeated for each ambient temperature. Under the slammed output voltage condition of Figure 7-3, the output

transistors are in saturation and the transistors start going into linear operation as the output swing is backed off for a given I_O ,

In [Figure 7-4](#), the inputs are floated and the output voltages are allowed to settle to the mid-supply voltage. The load current is then single-endedly swept for sourcing (greater than 0 mA) and sinking (less than 0 mA) conditions and the single-ended output voltage is measured at each current-forcing condition. The current sweep is completed in a few seconds (approximately 3 to 4 seconds) so as not to significantly raise the junction temperature (T_J) of the device from the ambient temperature (T_A). The output is not swinging and the output transistors are in linear operation in [Figure 7-4](#) until the current drawn exceeds the device capabilities, at which point the output voltage starts to deviate quickly from the no load output voltage.

To maintain maximum output stage linearity, output short-circuit protection is not provided. This absence of short-circuit protection is normally not a problem because most applications include a series-matching resistor at the output that limits the internal power dissipation if the output side of this resistor is shorted to ground. However, shorting the output pin directly to the adjacent positive power-supply pin, in most cases, permanently damages the amplifier.

7.3.4 Breakdown Supply Voltage

To estimate the margin beyond the maximum supply voltage specified in the [Absolute Maximum Ratings](#) table and exercise the robustness of the device, several typical units were tested beyond the specifications in the [Absolute Maximum Ratings](#) table. [Figure 7-5](#) shows the configuration used for the test. The supply voltage, V_S , was swept manually and quiescent current was recorded at each 0.5-V supply voltage increment. [Figure 7-6](#) shows the results of the single-supply voltage where the typical units started breaking. Under a similar configuration as the one shown in [Figure 7-5](#), a unit was subjected to $V_S = 42$ V for 168 hours and tested for quiescent current at the beginning and at the end of the test. There was no notable difference in the quiescent current before and after the 168 hours of testing and the device did not show any signs of damage or abnormality.

The primary objective of these tests was to estimate the margins of robustness for typical devices and does not imply performance or maximum limits beyond those specified in the [Absolute Maximum Ratings](#) and [Recommended Operating Conditions](#) tables.

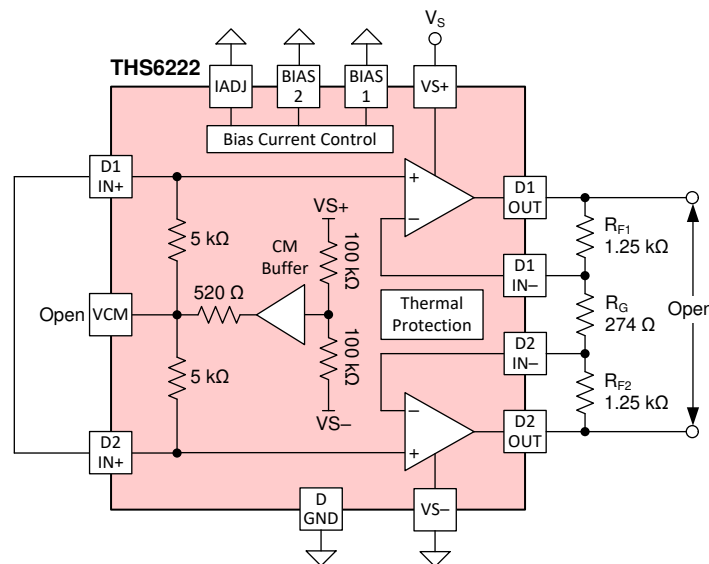

Figure 7-5. Breakdown Supply Voltage Test Configuration

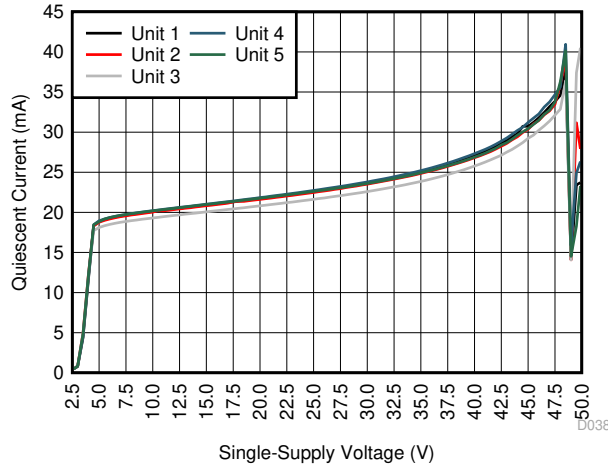

Figure 7-6. Typical Device Breakdown Supply Voltage ($T_A = 27^\circ\text{C}$)

7.3.5 Surge Test Results

Line drivers such as the THS6222 often directly interface with power lines through a transformer and various protection components in high-speed power line communications (HPLC) smart-meters and digital subscriber line (DSL) applications. Surge testing is an important requirement for such applications. To validate the performance and surge survivability of the THS6222, the THS6222 circuit configuration shown in Figure 7-7 was subjected to a ± 4 kV common-mode surge and a ± 2 kV differential-mode surge. The common-mode and differential-mode surge voltages were applied at V_{CM} and V_{DIFF} , respectively, in Figure 7-7. The 1.2/50 μs surge profile was used per the IEC 61000-4-5 test with $R_{EQ} = 42 \Omega$ as explained in the [TI's IEC 61000-4-x Tests and Procedures application report](#). Five devices were tested in full-bias and shutdown modes, and were subjected to the surge five times for each polarity. No device showed any discernable change in quiescent current after being subjected to the surge test, and the out-of-band suppression tests did not show any performance deterioration either, as shown in Figure 7-8 through Figure 7-11 for the state grid corporation of China (SGCC) HPLC bands.

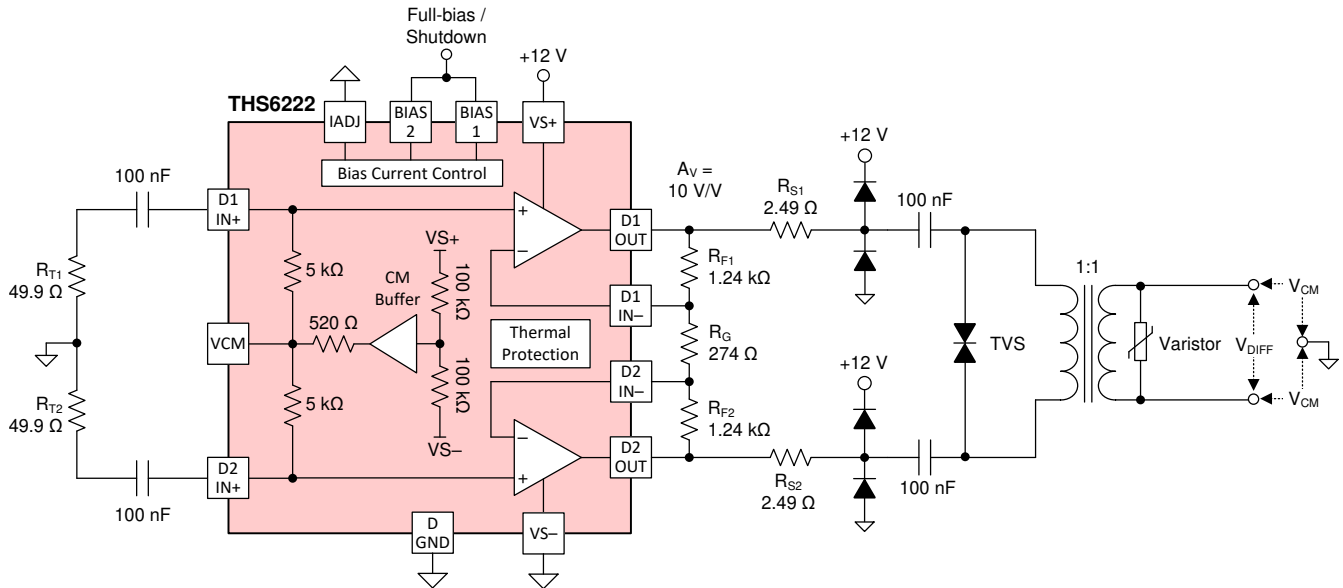

Figure 7-7. Surge Test Configuration

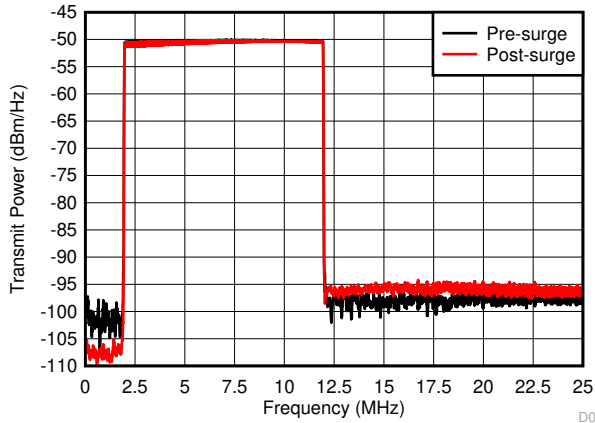

Figure 7-8. China SGCC HPLC Band0 Pre-Surge and Post-Surge

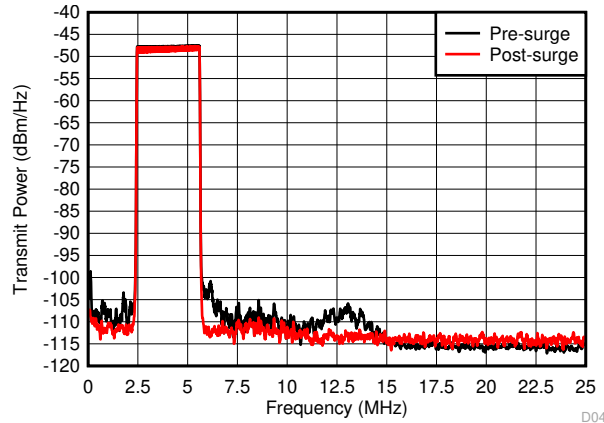

Figure 7-9. China SGCC HPLC Band1 Pre-Surge and Post-Surge

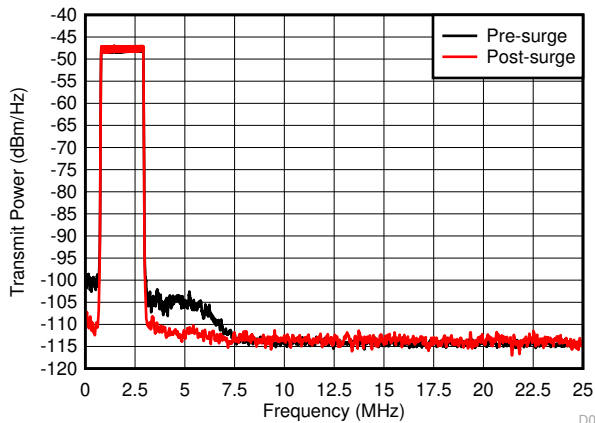

Figure 7-10. China SGCC HPLC Band2 Pre-Surge and Post-Surge

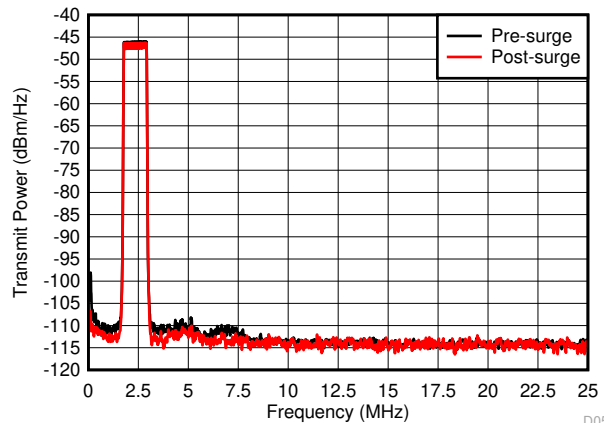

Figure 7-11. China SGCC HPLC Band3 Pre-Surge and Post-Surge

7.4 Device Functional Modes

The THS6222 has four different functional modes set by the BIAS-1 and BIAS-2 pins. [Table 7-1](#) shows the truth table for the device mode pin configuration and the associated description of each mode.

Table 7-1. BIAS-1 and BIAS-2 Logic Table

BIAS-1	BIAS-2	FUNCTION	DESCRIPTION
0	0	Full-bias mode (100%)	Amplifiers on with lowest distortion possible
1	0	Mid-bias mode (75%)	Amplifiers on with power savings and a reduction in distortion performance
0	1	Low-bias mode (50%)	Amplifiers on with enhanced power savings and a reduction of overall performance
1	1	Shutdown mode	Amplifiers off and output is high impedance

If the PLC application requires switching the line driver between all four power modes and if the PLC application-specific integrated circuit (ASIC) has two control bits, then the two control bits can be connected to the bias pins BIAS-1 and BIAS-2 for switching between any of the four power modes. However, most PLC applications only require the line driver to switch between one of the three active power modes and the shutdown mode. This type of 1-bit power mode control is illustrated in [Figure 8-1](#), where the line driver can be switched between the full-bias and shutdown modes using just one control bit from the PLC ASIC. If switching between the mid-bias or low-bias modes and the shutdown mode is required for the application, then either the BIAS-1 or BIAS-2 pin can be connected to ground and the control pin from the PLC ASIC can be connected to the non-grounded BIAS pin.

8 Application and Implementation

Note

Information in the following applications sections is not part of the TI component specification, and TI does not warrant its accuracy or completeness. TI's customers are responsible for determining suitability of components for their purposes. Customers should validate and test their design implementation to confirm system functionality.

8.1 Application Information

The THS6222 is typically used for high output power line-driving applications with various load conditions, as is often the case in power line communications (PLC) applications. In the [Typical Applications](#) section, the amplifier is presented in a typical, broadband, current-feedback configuration driving a 50 Ω line load. However, the amplifier is also applicable for many different general-purpose and specific line-driving applications beyond what is shown in the [Typical Applications](#) section.

8.2 Typical Applications

8.2.1 Broadband PLC Line Driving

The THS6222 provides the exceptional ac performance of a wideband current-feedback op amp with a highly linear, high-power output stage. The low output headroom requirement and high output current drive capability makes the THS6222 an excellent choice for 12 V PLC applications. The primary advantage of a current-feedback op amp such as the THS6222 over a voltage-feedback op amp is that the ac performance (bandwidth and distortion) is relatively independent of signal gain. [Figure 8-1](#) shows a typical ac-coupled broadband PLC application circuit where a current-output digital-to-analog converter (DAC) of the PLC application-specific integrated circuit (ASIC) drives the inputs of the THS6222. Though [Figure 8-1](#) shows the THS6222 interfacing with a current-output DAC, the THS6222 can just as easily be interfaced with a voltage-output DAC by using much larger terminating resistors, R_{T1} and R_{T2} .

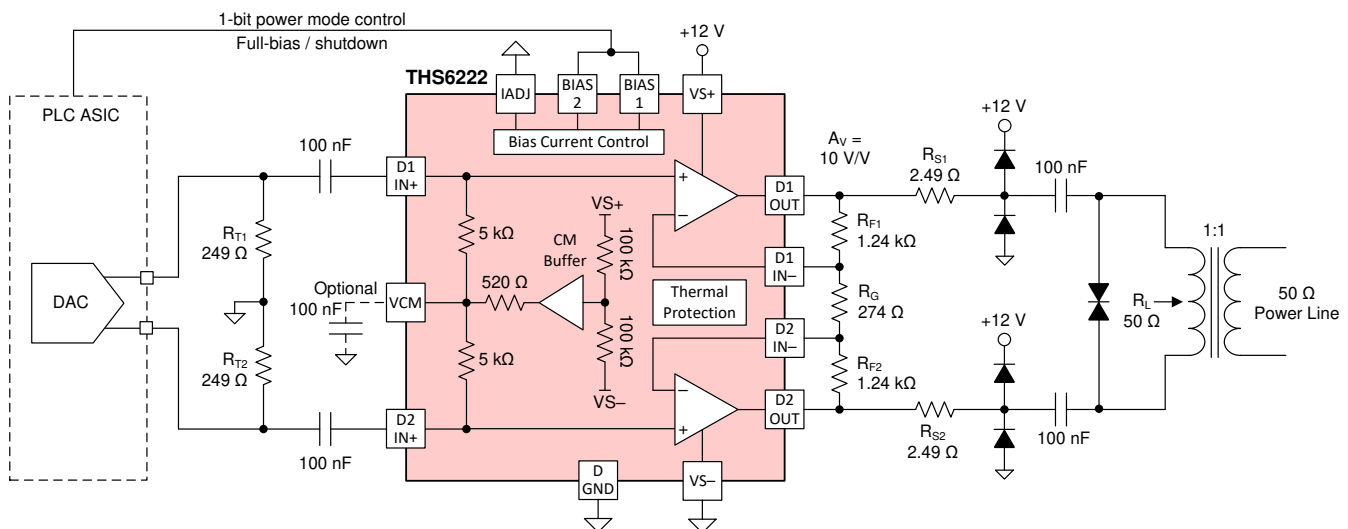

Figure 8-1. Typical Broadband PLC Configuration

8.2.1.1 Design Requirements

The main design requirements for an ac-coupled wideband current-feedback operation are to choose power supplies that satisfy the output voltage requirement, and also to use a feedback resistor value that allows for the proper bandwidth while maintaining stability. Use the design requirements shown in Table 8-1 to design a broadband PLC application circuit.

Table 8-1. Design Requirements

DESIGN PARAMETER	VALUE
Power supply	12 V, single-supply
Differential gain, A_V	10 V/V
Spectrum profile	China SGCC HPLC band0, band1, band2, and band3
In-band power spectral density	-50 dBm/Hz
Minimum out-of-band suppression	35 dB

8.2.1.2 Detailed Design Procedure

The closed-loop gain equation for a differential line driver such as the THS6222 is given as $A_V = 1 + 2 \times (R_F / R_G)$, where $R_F = R_{F1} = R_{F2}$. The THS6222 is a current-feedback amplifier and thus the bandwidth of the closed-loop configuration is set by the value of the R_F resistor. This advantage of the current-feedback architecture allows for flexibility in setting the differential gain by choosing the value of the R_G resistor without reducing the bandwidth as is the case with voltage-feedback amplifiers. The THS6222 is designed to provide optimal bandwidth performance with $R_{F1} = R_{F2} = 1.24 \text{ k}\Omega$. To configure the device in a gain of 10 V/V, the R_G resistor is chosen to be $274 \text{ }\Omega$. See the TI Precision Labs for more details on how to choose the R_F resistor to optimize the performance of a current-feedback amplifier.

Often, a key requirement for PLC applications is the out-of-band suppression specifications. The in-band frequencies carry the encoded data with a certain power level. The line driver must not generate any spurs beyond a certain power level outside the in-band spectrum. In the design requirements of this application example, the minimum out-of-band suppression specification of 35 dB means there must be no frequency spurs in the out-of-band spectrum beyond the -80 dBm/Hz power spectral density, considering the in-band power spectral density is -50 dBm/Hz.

The circuit shown in Figure 8-2 measures the out-of-band suppression specification. The minor difference in components between the circuits of Figure 8-1 and Figure 8-2 does not have any significant impact on the out-of-band suppression results.

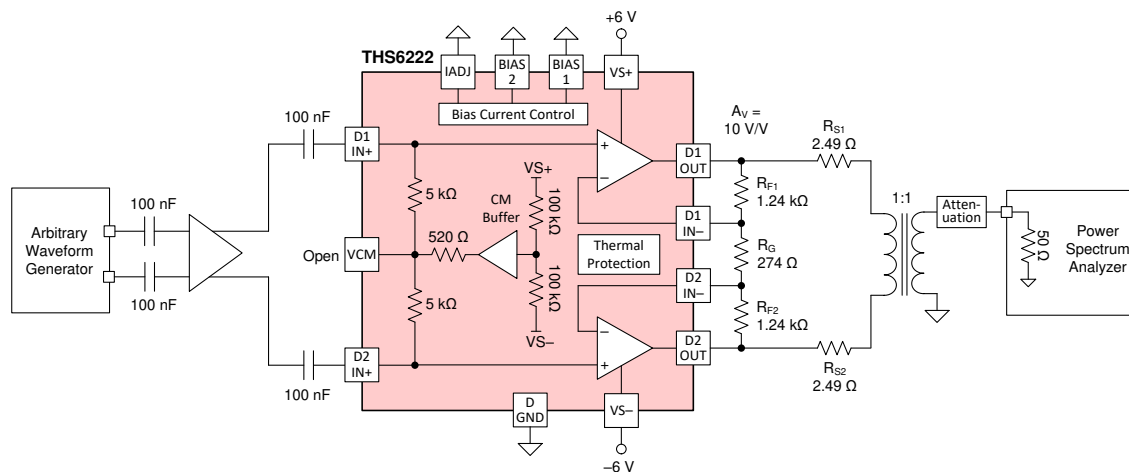

Figure 8-2. Measurement Test Circuit for Out-of-Band Suppression

8.2.1.3 Application Curve

Figure 8-3 shows the out-of-band suppression measurement results of the circuit. Out-of-band suppression is a good indicator of the linearity performance of the device. The results in Figure 8-3 show over 40 dB of out-of-band suppression, which is well beyond the 35 dB requirement and indicative of the excellent linearity performance of the THS6222.

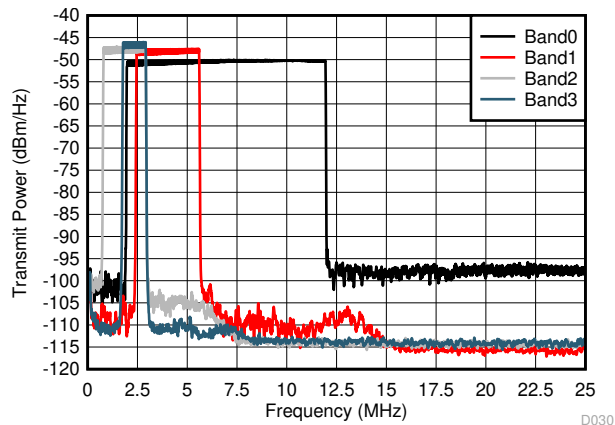

Figure 8-3. Out-of-Band Suppression

8.3 What to Do and What Not to Do

8.3.1 Do

- Include a thermal design at the beginning of the project.
- Use well-terminated transmission lines for all signals.
- Use solid metal layers for the power supplies.
- Keep signal lines as straight as possible.
- Keep the traces carrying differential signals of the same length.

8.3.2 Do Not

- Do not use a lower supply voltage than necessary.
- Do not use thin metal traces to supply power.
- Do not treat the D1 and D2 amplifiers as independent single-ended amplifiers.

9 Power Supply Recommendations

The THS6222 supports single-supply and split-supply power supplies, and balanced and unbalanced bipolar supplies. The device has a wide supply range of 8 V (–3 V to +5 V) to 32 V (± 16 V). Choose power-supply voltages that allow for adequate swing on both the inputs and outputs of the amplifier to prevent affecting device performance. Operating from a single supply can have numerous advantages. With the negative supply at ground, the errors resulting from the –PSRR term can be minimized. The DGND pin provides the ground reference for the bias control pins. For applications that use split bipolar supplies, care must be taken to design within the DGND voltage specifications and must be within V_{S-} to $(V_{S+} - 5$ V); the DGND pin must be a minimum bias of 5 V. Thus, the minimum positive supply that can be used in split-supply applications is $V_{S+} = 5$ V. The negative supply, V_{S-} , can then be set to a voltage anywhere in between –3 V and –27 V, as per the [Recommended Operating Conditions](#) specifications.

10 Layout

10.1 Layout Guidelines

Achieving optimum performance with a high-frequency amplifier such as the THS6222 requires careful attention to board layout parasitic and external component types. The [THS6222RHFEVM](#) can be used as a reference when designing the circuit board. Recommendations that optimize performance include:

1. Minimize parasitic capacitance to any ac ground for all signal I/O pins. Parasitic capacitance, particularly on the output and inverting input pins, can cause instability; on the noninverting input, this capacitance can react with the source impedance to cause unintentional band limiting. To reduce unwanted capacitance, a window around the signal I/O pins must be opened in all ground and power planes around these pins. Otherwise, ground and power planes must be unbroken elsewhere on the board.
2. Minimize the distance (less than 0.25 in, or 6.35 mm) from the power-supply pins to high-frequency 0.1 μF decoupling capacitors. At the device pins, the ground and power plane layout must not be in close proximity to the signal I/O pins. Avoid narrow power and ground traces to minimize inductance between the pins and the decoupling capacitors. The power-supply connections must always be decoupled with these capacitors. An optional supply decoupling capacitor across the two power supplies (for bipolar operation) improves second-harmonic distortion performance. Larger (2.2 μF to 6.8 μF) decoupling capacitors, effective at lower frequencies, must also be used on the main supply pins. These capacitors can be placed somewhat farther from the device and can be shared among several devices in the same area of the PCB.
3. Careful selection and placement of external components preserves the high-frequency performance of the THS6222. Resistors must be of a very low reactance type. Surface-mount resistors work best and allow a tighter overall layout. Metal film and carbon composition, axially-leaded resistors can also provide good high-frequency performance.

Again, keep leads and PCB trace length as short as possible. Never use wire-wound type resistors in a high-frequency application. Although the output pin and inverting input pin are the most sensitive to parasitic capacitance, always position the feedback and series output resistor, if any, as close as possible to the output pin. Other network components, such as noninverting input termination resistors, must also be placed close to the package. Where double-side component mounting is required, place the feedback resistor directly under the package on the other side of the board between the output and inverting input pins. The frequency response is primarily determined by the feedback resistor value, as described in the [Broadband PLC Line Driving](#) section. Increasing the value reduces the bandwidth, whereas decreasing the value leads to a more peaked frequency response. The 1.24 k Ω feedback resistor used in the [Typical Characteristics: \$V_s = 12\text{ V}\$](#) is a good starting point for a gain of 10 V/V design.

4. Connections to other wideband devices on the board can be made with short direct traces or through onboard transmission lines. For short connections, consider the trace and the input to the next device as a lumped capacitive load. Relatively wide traces (50-mils to 100-mils, 0.050-in to 0.100-in, or 1.27-mm to 2.54-mm) must be used, preferably with ground and power planes opened up around them.
5. Socketing a high-speed part such as the THS6222 is not recommended. The additional lead length and pin-to-pin capacitance introduced by the socket can create an extremely troublesome parasitic network, and can make achieving a smooth, stable frequency response almost impossible. Best results are obtained by soldering the THS6222 directly onto the board.
6. Use the V_{S-} plane to conduct the heat out of the package. The package attaches the die directly to an exposed thermal pad on the bottom, and must be soldered to the board. This pad must be connected electrically to the same voltage plane as the most negative supply voltage (V_{S-}) applied to the THS6222. Place as many vias as possible on the thermal pad connection and connect the vias to a heat spreading plane that is at the same potential as V_{S-} on the bottom side of the PCB.

10.2 Wafer and Die Information

Table 10-1 lists wafer and bond pad information for the YS package.

Table 10-1. Wafer and Bond Pad Information

WAFER BACKSIDE FINISH	WAFER THICKNESS	BACKSIDE POTENTIAL	BOND PAD METALLIZATION	BOND PAD DIMENSIONS (X × Y)
Silicon without backgrind	25 mils	Must be connected to the lowest voltage potential on the die (generally V_{S-})	Al	76.0 μm × 76.0 μm

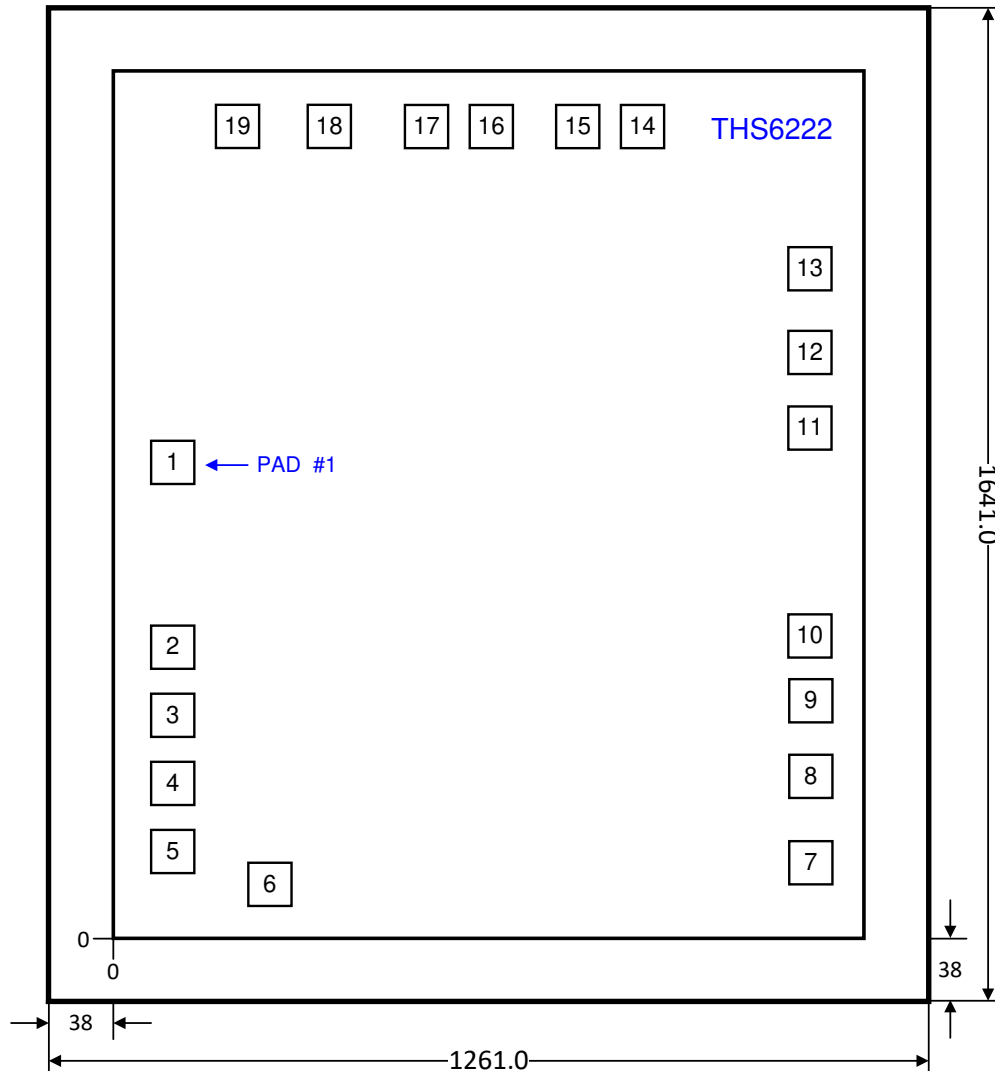

All dimensions are in micrometers (μm).

Figure 10-1. Die Dimensions

Table 10-2 lists the bond pad locations for the YS package. All dimensions are in micrometers (μm).

Table 10-2. Bond Pad Locations

PAD NUMBER	PAD NAME	X MIN	Y MIN	X MAX	Y MAX	DESCRIPTION
1	D1_IN+	71.050	878.875	147.050	954.875	Amplifier D1 noninverting input
2	D2_IN+	71.050	525.125	147.050	601.125	Amplifier D2 noninverting input
3	DGND	71.050	384.025	147.050	460.025	Ground reference for bias control pins
4	IADJ	71.050	267.025	147.050	343.025	Bias current adjustment pin
5	VCM	71.050	150.025	147.050	226.025	Common-mode buffer output
6	VS-	209.175	85.925	285.175	161.925	Negative power-supply connection
7	VS+	1007.475	95.500	1083.475	171.500	Positive power-supply connection
8	D2_OUT	1007.475	222.500	1083.475	298.500	Amplifier D2 output (must be used for D2 output)
9	D2_OUT (OPT)	1007.475	369.900	1083.475	445.900	Optional amplifier D2 output (can be left unconnected or connected to pad 8)
10	D2_IN-	1007.475	487.375	1083.475	563.375	Amplifier D2 inverting input
11	D1_IN-	1007.450	919.375	1083.450	995.375	Amplifier D1 inverting input
12	D1_OUT (OPT)	1007.475	1034.100	1083.475	1110.100	Optional amplifier D1 output (pad can be left unconnected or connected to pad 13)
13	D1_OUT	1007.475	1181.500	1083.475	1257.500	Amplifier D1 output (must be used for D1 output)
14	VS+	851.675	1417.950	927.675	1493.950	Positive power-supply connection
15	VS+	718.900	1417.950	794.900	1493.950	Positive power-supply connection
16	VS-	557.375	1417.950	633.375	1493.950	Negative power-supply connection
17	VS-	424.600	1417.950	500.600	1493.950	Negative power-supply connection
18	BIAS-1	293.075	1417.750	369.075	1493.750	Bias mode parallel control, LSB
19	BIAS-2	159.250	1417.750	235.250	1493.750	Bias mode parallel control, MSB

10.3 Layout Examples

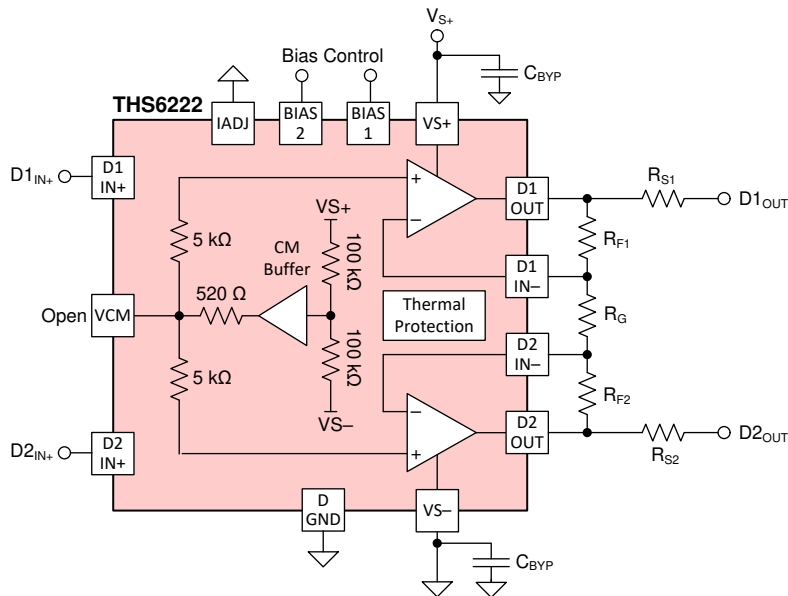

Figure 10-2. Representative Schematic for the Layout in Figure 10-3

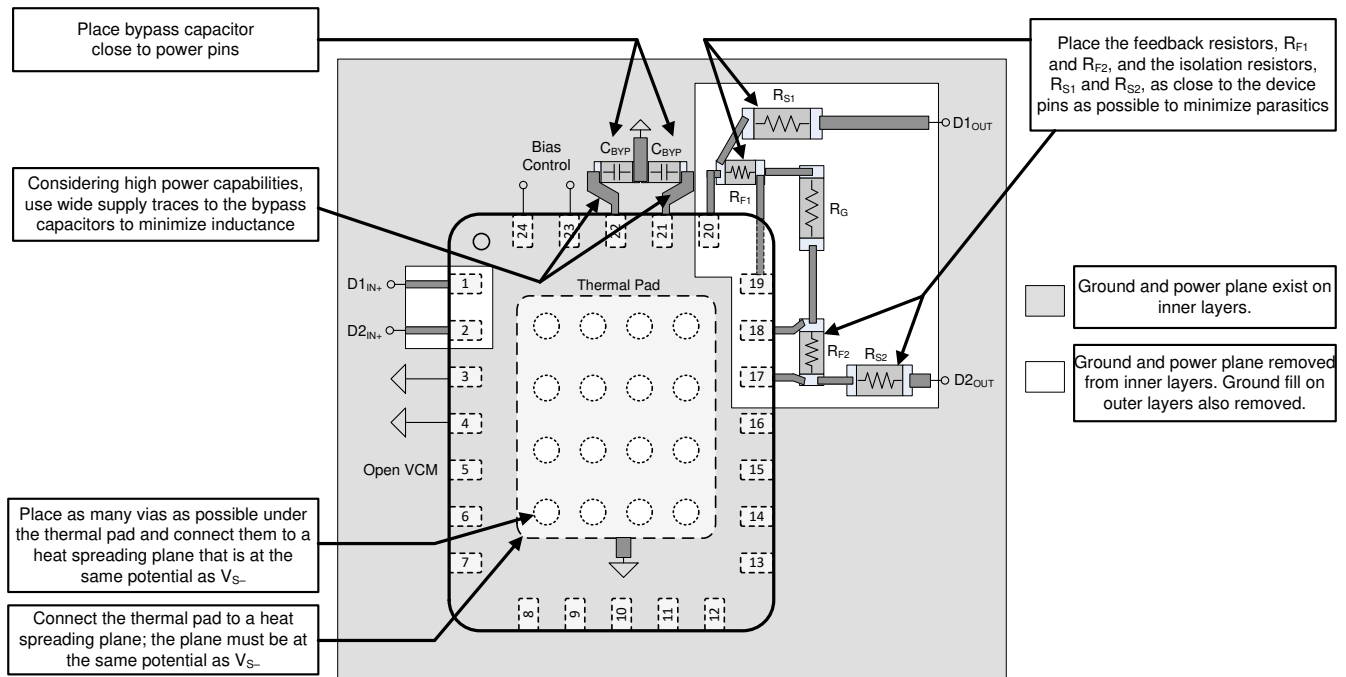

Figure 10-3. Layout Recommendations

11 Device and Documentation Support

11.1 Development Support

[TI Precision Labs](#)

11.2 Documentation Support

11.2.1 Related Documentation

For related documentation see the following:

- Texas Instruments, [THS6212 Differential Broadband PLC Line Driver Amplifier data sheet](#)
- Texas Instruments, [THS6214 Dual-Port, Differential, VDSL2 Line Driver Amplifiers data sheet](#)
- Texas Instruments, [Thermal Design By Insight, Not Hindsight application report](#)
- Texas Instruments, [TI's IEC 61000-4-x Tests and Procedures application report](#)
- Texas Instruments, [THS6222 Evaluation Module user guide](#)

11.3 Receiving Notification of Documentation Updates

To receive notification of documentation updates, navigate to the device product folder on ti.com. In the upper right corner, click on *Alert me* to register and receive a weekly digest of any product information that has changed. For change details, review the revision history included in any revised document.

11.4 Support Resources

[TI E2E™ support forums](#) are an engineer's go-to source for fast, verified answers and design help — straight from the experts. Search existing answers or ask your own question to get the quick design help you need.

Linked content is provided "AS IS" by the respective contributors. They do not constitute TI specifications and do not necessarily reflect TI's views; see TI's [Terms of Use](#).

11.5 Trademarks

TI E2E™ is a trademark of Texas Instruments.
All trademarks are the property of their respective owners.

11.6 Electrostatic Discharge Caution



This integrated circuit can be damaged by ESD. Texas Instruments recommends that all integrated circuits be handled with appropriate precautions. Failure to observe proper handling and installation procedures can cause damage.

ESD damage can range from subtle performance degradation to complete device failure. Precision integrated circuits may be more susceptible to damage because very small parametric changes could cause the device not to meet its published specifications.

11.7 Glossary

[TI Glossary](#) This glossary lists and explains terms, acronyms, and definitions.

12 Mechanical, Packaging, and Orderable Information

The following pages include mechanical, packaging, and orderable information. This information is the most current data available for the designated devices. This data is subject to change without notice and revision of this document. For browser-based versions of this data sheet, refer to the left-hand navigation.

PACKAGING INFORMATION

Orderable Device	Status (1)	Package Type	Package Drawing	Pins	Package Qty	Eco Plan (2)	Lead finish/ Ball material (6)	MSL Peak Temp (3)	Op Temp (°C)	Device Marking (4/5)	Samples
THS6222IRGTR	ACTIVE	VQFN	RGT	16	3000	RoHS & Green	NIPDAU	Level-1-260C-UNLIM	-40 to 85	TH6222	Samples
THS6222IRHFR	ACTIVE	VQFN	RHF	24	3000	RoHS & Green	NIPDAU NIPDAUAG	Level-2-260C-1 YEAR	-40 to 85	(THS, THS6222) 6222	Samples
THS6222IRHFT	ACTIVE	VQFN	RHF	24	250	RoHS & Green	NIPDAU	Level-2-260C-1 YEAR	-40 to 85	(THS, THS6222) 6222	Samples
THS6222YS	ACTIVE	WAFERSALE	YS	0	1	TBD	Call TI	Call TI	-40 to 85		Samples

(1) The marketing status values are defined as follows:

ACTIVE: Product device recommended for new designs.

LIFEBUY: TI has announced that the device will be discontinued, and a lifetime-buy period is in effect.

NRND: Not recommended for new designs. Device is in production to support existing customers, but TI does not recommend using this part in a new design.

PREVIEW: Device has been announced but is not in production. Samples may or may not be available.

OBSOLETE: TI has discontinued the production of the device.

(2) **RoHS:** TI defines "RoHS" to mean semiconductor products that are compliant with the current EU RoHS requirements for all 10 RoHS substances, including the requirement that RoHS substance do not exceed 0.1% by weight in homogeneous materials. Where designed to be soldered at high temperatures, "RoHS" products are suitable for use in specified lead-free processes. TI may reference these types of products as "Pb-Free".

RoHS Exempt: TI defines "RoHS Exempt" to mean products that contain lead but are compliant with EU RoHS pursuant to a specific EU RoHS exemption.

Green: TI defines "Green" to mean the content of Chlorine (Cl) and Bromine (Br) based flame retardants meet JS709B low halogen requirements of <=1000ppm threshold. Antimony trioxide based flame retardants must also meet the <=1000ppm threshold requirement.

(3) MSL, Peak Temp. - The Moisture Sensitivity Level rating according to the JEDEC industry standard classifications, and peak solder temperature.

(4) There may be additional marking, which relates to the logo, the lot trace code information, or the environmental category on the device.

(5) Multiple Device Markings will be inside parentheses. Only one Device Marking contained in parentheses and separated by a "~" will appear on a device. If a line is indented then it is a continuation of the previous line and the two combined represent the entire Device Marking for that device.

(6) Lead finish/Ball material - Orderable Devices may have multiple material finish options. Finish options are separated by a vertical ruled line. Lead finish/Ball material values may wrap to two lines if the finish value exceeds the maximum column width.

Important Information and Disclaimer: The information provided on this page represents TI's knowledge and belief as of the date that it is provided. TI bases its knowledge and belief on information provided by third parties, and makes no representation or warranty as to the accuracy of such information. Efforts are underway to better integrate information from third parties. TI has taken and

continues to take reasonable steps to provide representative and accurate information but may not have conducted destructive testing or chemical analysis on incoming materials and chemicals. TI and TI suppliers consider certain information to be proprietary, and thus CAS numbers and other limited information may not be available for release.

In no event shall TI's liability arising out of such information exceed the total purchase price of the TI part(s) at issue in this document sold by TI to Customer on an annual basis.

TAPE AND REEL INFORMATION

QUADRANT ASSIGNMENTS FOR PIN 1 ORIENTATION IN TAPE

*All dimensions are nominal

Device	Package Type	Package Drawing	Pins	SPQ	Reel Diameter (mm)	Reel Width W1 (mm)	A0 (mm)	B0 (mm)	K0 (mm)	P1 (mm)	W (mm)	Pin1 Quadrant
THS6222IRGTR	VQFN	RGT	16	3000	330.0	12.4	3.3	3.3	1.1	8.0	12.0	Q2
THS6222IRHFR	VQFN	RHF	24	3000	330.0	12.4	4.3	5.3	1.1	8.0	12.0	Q1
THS6222IRHFR	VQFN	RHF	24	3000	330.0	12.4	4.3	5.3	1.3	8.0	12.0	Q1
THS6222IRHFT	VQFN	RHF	24	250	180.0	12.4	4.3	5.3	1.3	8.0	12.0	Q1

TAPE AND REEL BOX DIMENSIONS

*All dimensions are nominal

Device	Package Type	Package Drawing	Pins	SPQ	Length (mm)	Width (mm)	Height (mm)
THS6222IRGTR	VQFN	RGT	16	3000	367.0	367.0	35.0
THS6222IRHFR	VQFN	RHF	24	3000	338.0	355.0	50.0
THS6222IRHFR	VQFN	RHF	24	3000	367.0	367.0	35.0
THS6222IRHFT	VQFN	RHF	24	250	210.0	185.0	35.0

RGT 16

GENERIC PACKAGE VIEW

VQFN - 1 mm max height

PLASTIC QUAD FLATPACK - NO LEAD



Images above are just a representation of the package family, actual package may vary.
Refer to the product data sheet for package details.

4203495/1



SIDE WALL METAL THICKNESS DIM A	
OPTION 1	OPTION 2
0.1	0.2



4222419/D 04/2022

NOTES:

1. All linear dimensions are in millimeters. Any dimensions in parenthesis are for reference only. Dimensioning and tolerancing per ASME Y14.5M.
2. This drawing is subject to change without notice.
3. The package thermal pad must be soldered to the printed circuit board for thermal and mechanical performance.

EXAMPLE BOARD LAYOUT

RGT0016C

VQFN - 1 mm max height

PLASTIC QUAD FLATPACK - NO LEAD

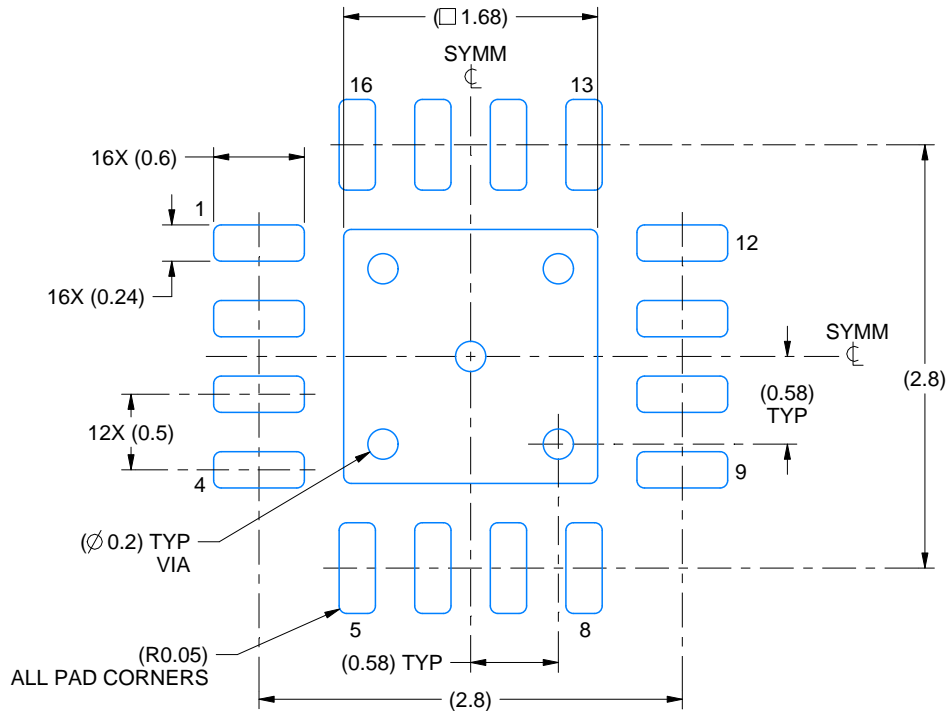

LAND PATTERN EXAMPLE
EXPOSED METAL SHOWN
SCALE:20X

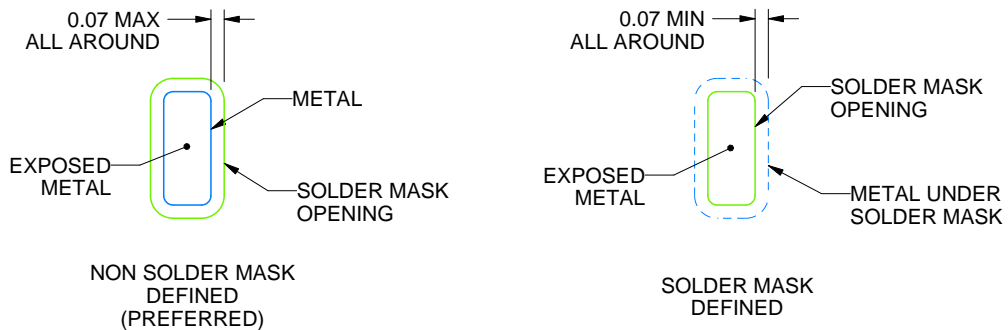

SOLDER MASK DETAILS

4222419/D 04/2022

NOTES: (continued)

- This package is designed to be soldered to a thermal pad on the board. For more information, see Texas Instruments literature number SLUA271 (www.ti.com/lit/slua271).
- Vias are optional depending on application, refer to device data sheet. If any vias are implemented, refer to their locations shown on this view. It is recommended that vias under paste be filled, plugged or tented.

EXAMPLE STENCIL DESIGN

RGT0016C

VQFN - 1 mm max height

PLASTIC QUAD FLATPACK - NO LEAD

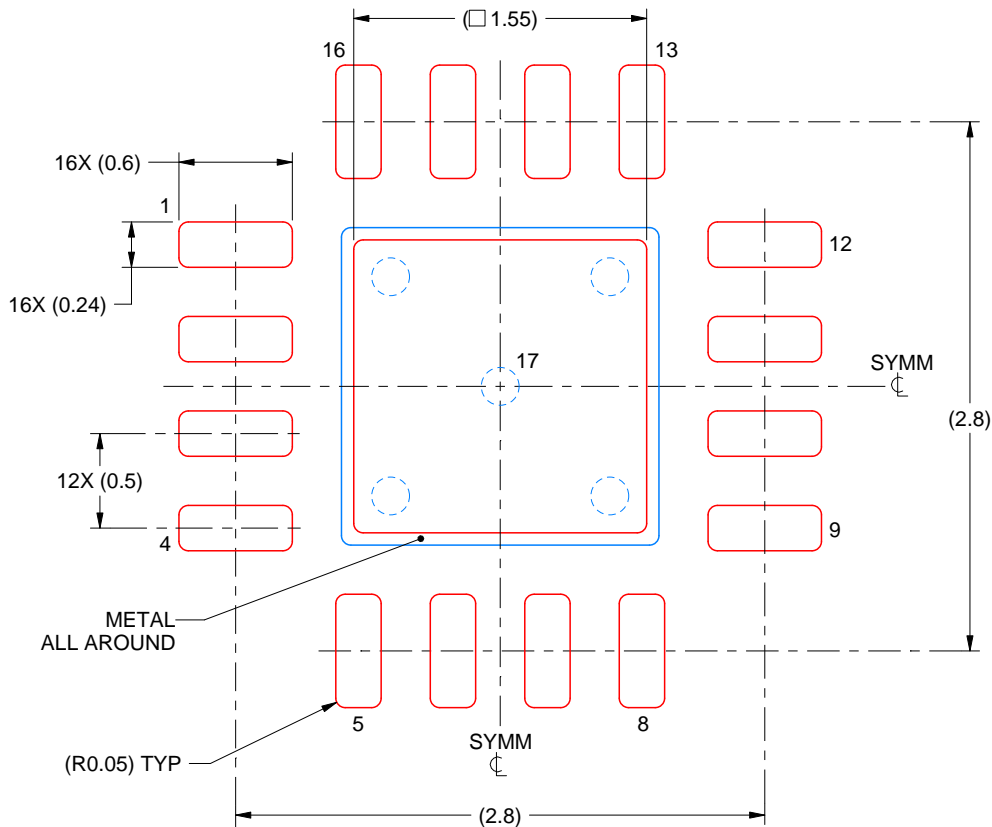

SOLDER PASTE EXAMPLE
BASED ON 0.125 mm THICK STENCIL

EXPOSED PAD 17:
85% PRINTED SOLDER COVERAGE BY AREA UNDER PACKAGE
SCALE:25X

4222419/D 04/2022

NOTES: (continued)

6. Laser cutting apertures with trapezoidal walls and rounded corners may offer better paste release. IPC-7525 may have alternate design recommendations.

RHF0024A

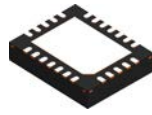

PACKAGE OUTLINE

VQFN - 1 mm max height

PLASTIC QUAD FLATPACK - NO LEAD

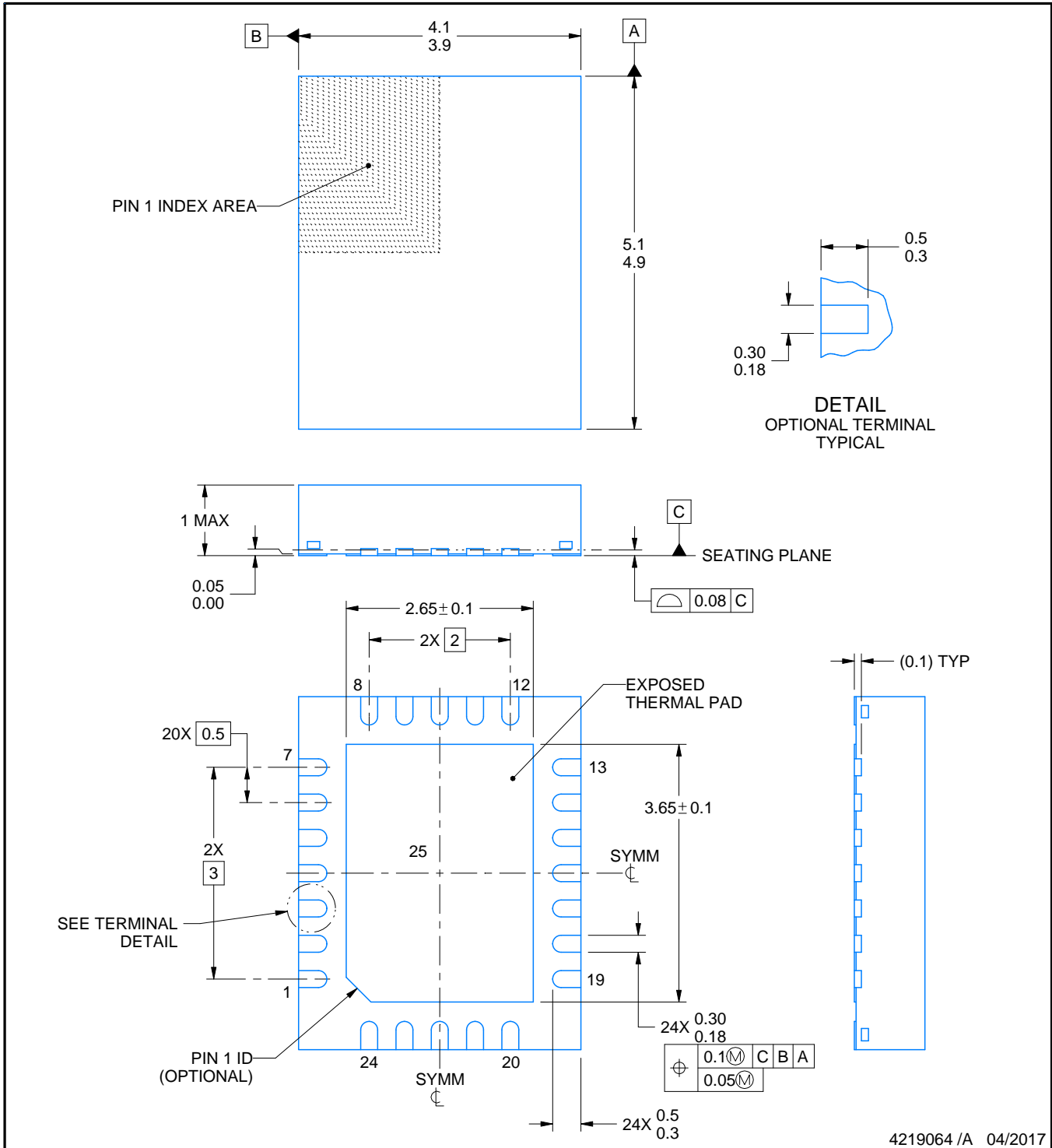

4219064 /A 04/2017

NOTES:

1. All linear dimensions are in millimeters. Any dimensions in parenthesis are for reference only. Dimensioning and tolerancing per ASME Y14.5M.
2. This drawing is subject to change without notice.
3. The package thermal pad must be soldered to the printed circuit board for thermal and mechanical performance.

EXAMPLE BOARD LAYOUT

RHF0024A

VQFN - 1 mm max height

PLASTIC QUAD FLATPACK - NO LEAD

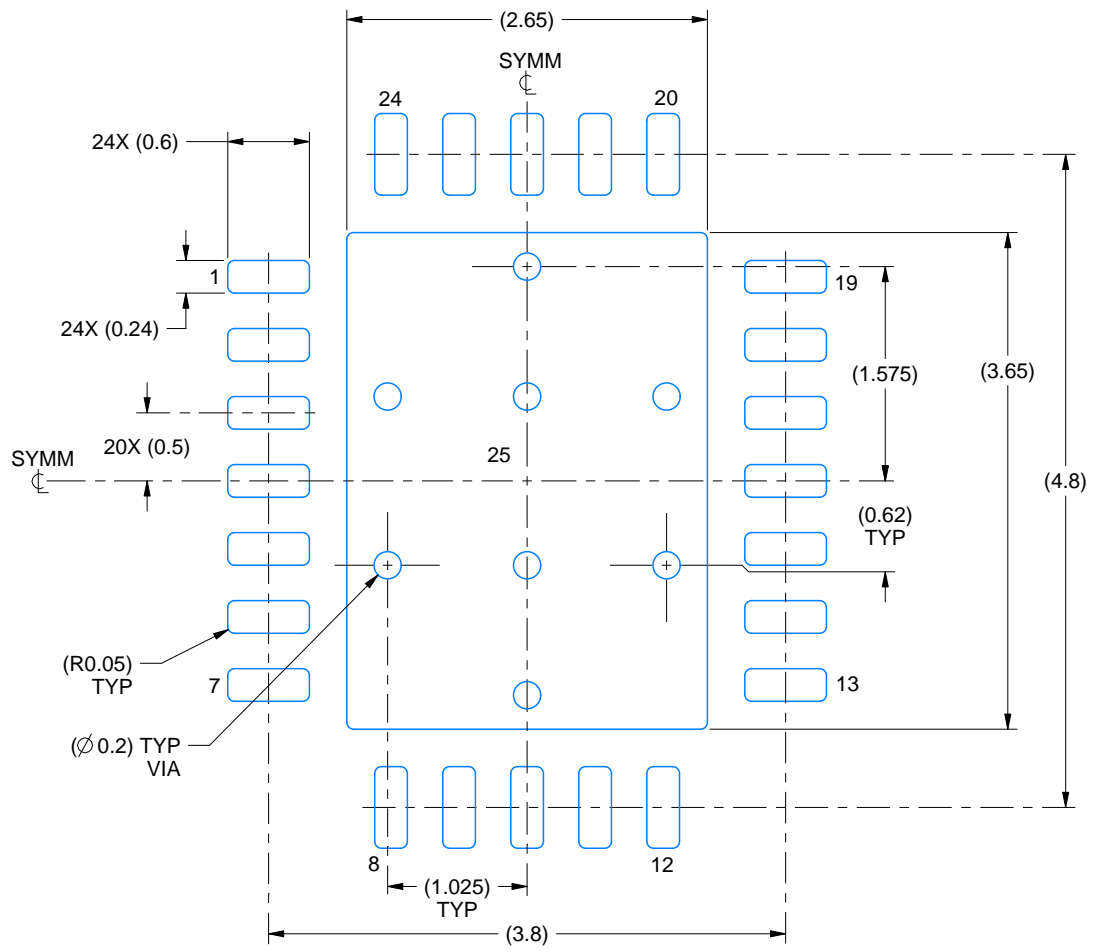

LAND PATTERN EXAMPLE
EXPOSED METAL SHOWN
SCALE:18X

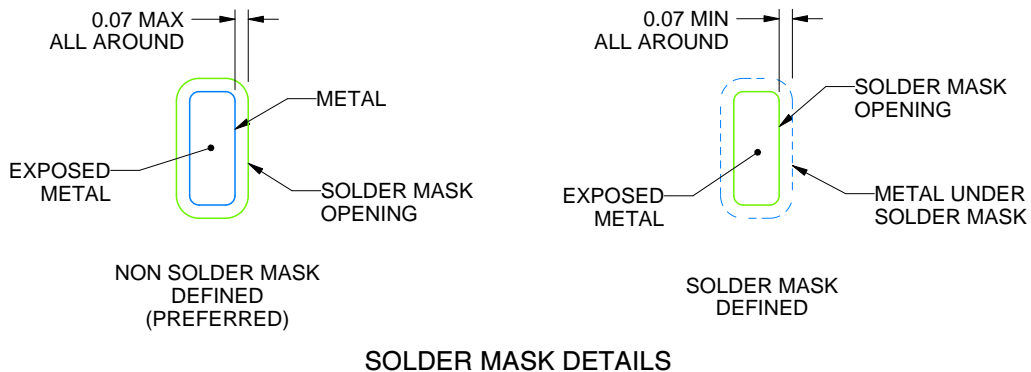

SOLDER MASK DETAILS

4219064 /A 04/2017

NOTES: (continued)

- This package is designed to be soldered to a thermal pad on the board. For more information, see Texas Instruments literature number SLUA271 (www.ti.com/lit/slua271).
- Vias are optional depending on application, refer to device data sheet. If any vias are implemented, refer to their locations shown on this view. It is recommended that vias under paste be filled, plugged or tented.

EXAMPLE STENCIL DESIGN

RHF0024A

VQFN - 1 mm max height

PLASTIC QUAD FLATPACK - NO LEAD

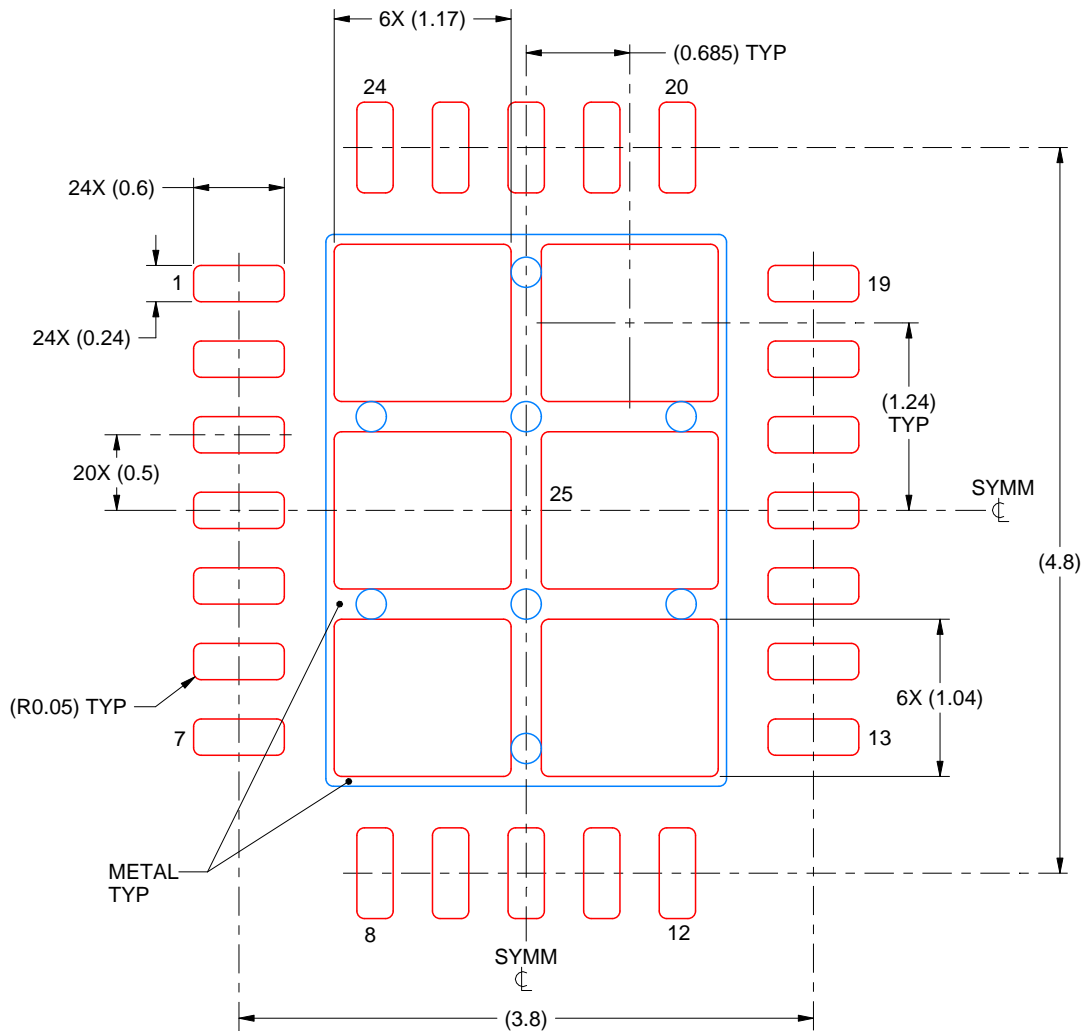

SOLDER PASTE EXAMPLE
BASED ON 0.125 mm THICK STENCIL

EXPOSED PAD 25
75% PRINTED SOLDER COVERAGE BY AREA UNDER PACKAGE
SCALE:20X

4219064 /A 04/2017

NOTES: (continued)

6. Laser cutting apertures with trapezoidal walls and rounded corners may offer better paste release. IPC-7525 may have alternate design recommendations.

IMPORTANT NOTICE AND DISCLAIMER

TI PROVIDES TECHNICAL AND RELIABILITY DATA (INCLUDING DATA SHEETS), DESIGN RESOURCES (INCLUDING REFERENCE DESIGNS), APPLICATION OR OTHER DESIGN ADVICE, WEB TOOLS, SAFETY INFORMATION, AND OTHER RESOURCES "AS IS" AND WITH ALL FAULTS, AND DISCLAIMS ALL WARRANTIES, EXPRESS AND IMPLIED, INCLUDING WITHOUT LIMITATION ANY IMPLIED WARRANTIES OF MERCHANTABILITY, FITNESS FOR A PARTICULAR PURPOSE OR NON-INFRINGEMENT OF THIRD PARTY INTELLECTUAL PROPERTY RIGHTS.

These resources are intended for skilled developers designing with TI products. You are solely responsible for (1) selecting the appropriate TI products for your application, (2) designing, validating and testing your application, and (3) ensuring your application meets applicable standards, and any other safety, security, regulatory or other requirements.

These resources are subject to change without notice. TI grants you permission to use these resources only for development of an application that uses the TI products described in the resource. Other reproduction and display of these resources is prohibited. No license is granted to any other TI intellectual property right or to any third party intellectual property right. TI disclaims responsibility for, and you will fully indemnify TI and its representatives against, any claims, damages, costs, losses, and liabilities arising out of your use of these resources.

TI's products are provided subject to [TI's Terms of Sale](#) or other applicable terms available either on [ti.com](https://www.ti.com) or provided in conjunction with such TI products. TI's provision of these resources does not expand or otherwise alter TI's applicable warranties or warranty disclaimers for TI products.

TI objects to and rejects any additional or different terms you may have proposed.

Mailing Address: Texas Instruments, Post Office Box 655303, Dallas, Texas 75265
Copyright © 2023, Texas Instruments Incorporated