

P	LTR	DESCRIPTION	DATE	DWN	APVD
C2		REVISED PER ECR-16-011494	20JUN2017	NK	CX
C3		ECO-19-006934	13MAY2019	AP	WLS
C4		REVISED PER ECO-20-010933	05AUG2020	WLS	VS
C5		REVISED PER ECN-23-198901	16FEB2023	WLS	VS

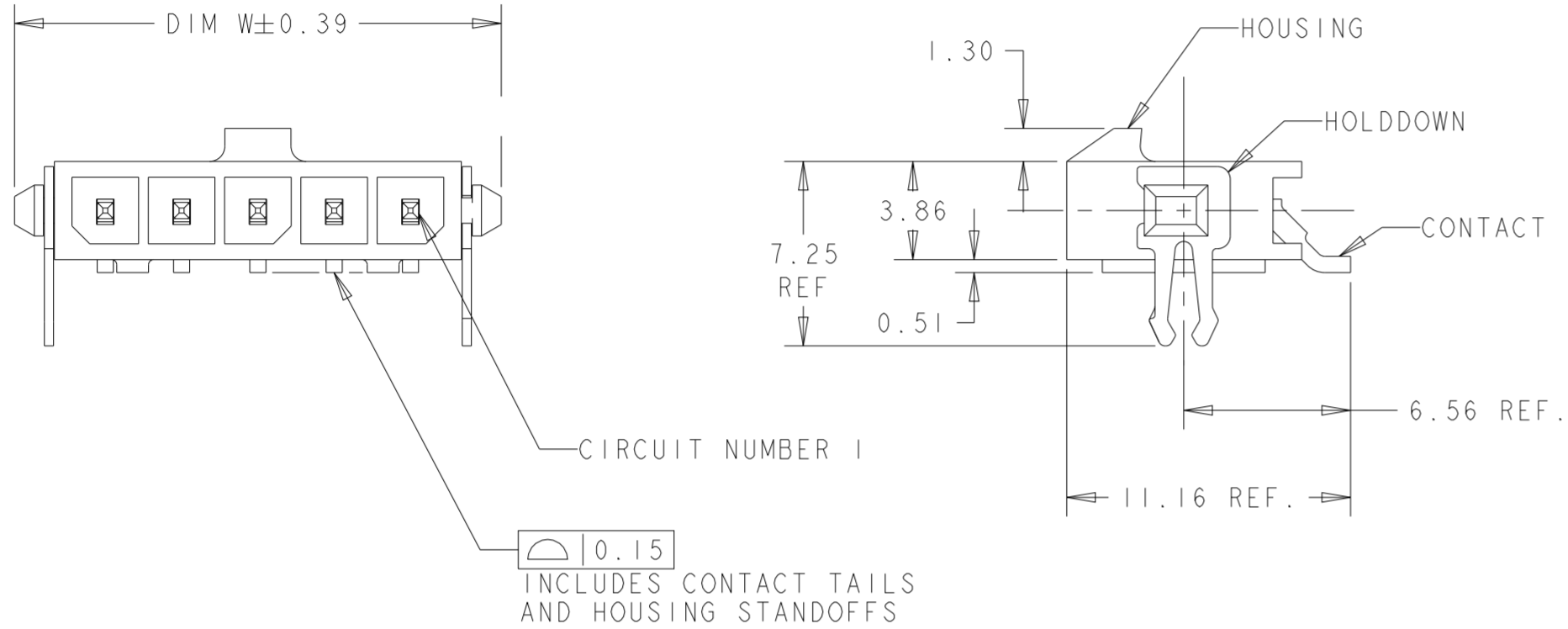

- 1 MATERIAL: HOUSING - UL 94V-0 RATED HIGH TEMP NYLON, COLOR BLACK.
CONTACTS - BRASS
HOLDDOWNS - PHOSPHOR BRONZE.
- 2 RECOMMENDED PC BOARD THICKNESS OF 1.57.
- 3 PLATING: CONTACTS - 2.54µm MINIMUM MATTE TIN OVER 1.27µm MINIMUM NICKEL.
HOLDDOWNS - 2.54µm MINIMUM MATTE TIN OVER 1.27µm MINIMUM NICKEL.
- 4 COUNTERPART RECOMMENDED IS PN 1445022 OR 2008571 (DASH ACC. TO NUMBER OF POSITION).
- 5 FOR REELING DIRECTION AND PACKAGING TYPE, SEE SPECIFICATION 114-13000.

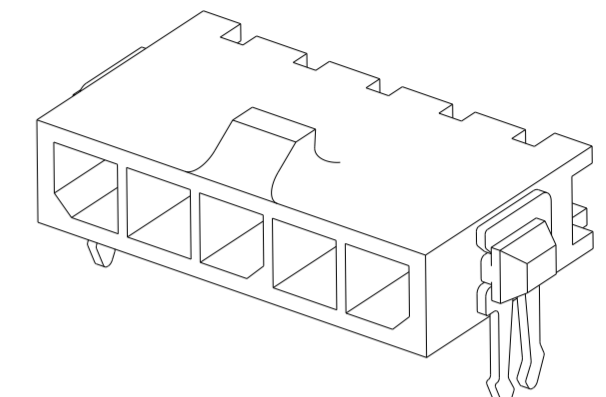
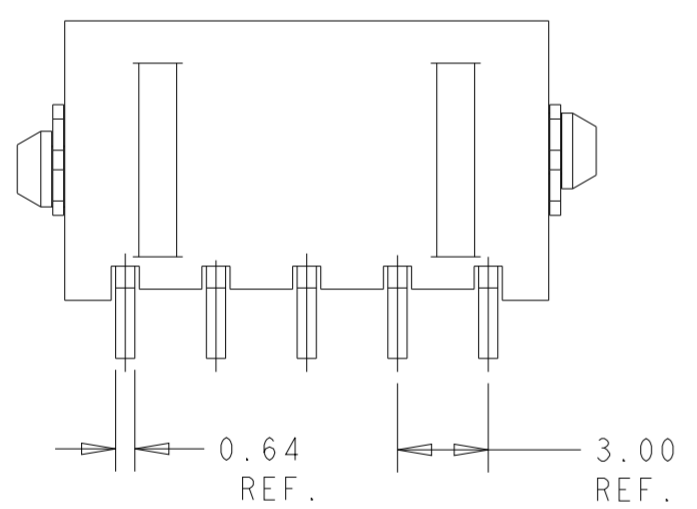

33.00	37.43	40.00	12	3-1445056-2
30.00	34.43	37.00	11	3-1445056-1
27.00	31.43	34.00	10	3-1445056-0
24.00	28.43	31.00	9	2-1445056-9
21.00	25.43	28.00	8	2-1445056-8
18.00	22.43	25.00	7	2-1445056-7
15.00	19.43	22.00	6	2-1445056-6
12.00	16.43	19.00	5	2-1445056-5
9.00	13.43	16.00	4	2-1445056-4
6.00	10.43	13.00	3	2-1445056-3
3.00	7.43	10.00	2	2-1445056-2
DIM Z	DIM V	DIM W	NO. OF POSN	PART NUMBER

THIS DRAWING IS A CONTROLLED DOCUMENT.

DWN	J.ROOT	03OCT2000
CHK	K.WHITAKER	13-MAR-2001
APVD	K.WHITAKER	13-MAR-2001
PRODUCT SPEC	108-1836	
APPLICATION SPEC	114-13000	
WEIGHT	-	
CUSTOMER DRAWING	SCALE 4:1	SHEET 1 OF 2

STE TE Connectivity

NAME: RT ANGLE SURFACE MOUNT HEADER ASSY, TIN CONTACTS W/THRU HOLE HOLDDOWNS, SINGLE ROW, MICRO MATE-N-LOK™

SIZE: A2 CAGE CODE: 00779 DRAWING NO: C-1445056 RESTRICTED TO: -

REV C5

REVISIONS

P	LTR	DESCRIPTION	DATE	DWN	APVD
-	-	SEE SHEET 1	-	-	-

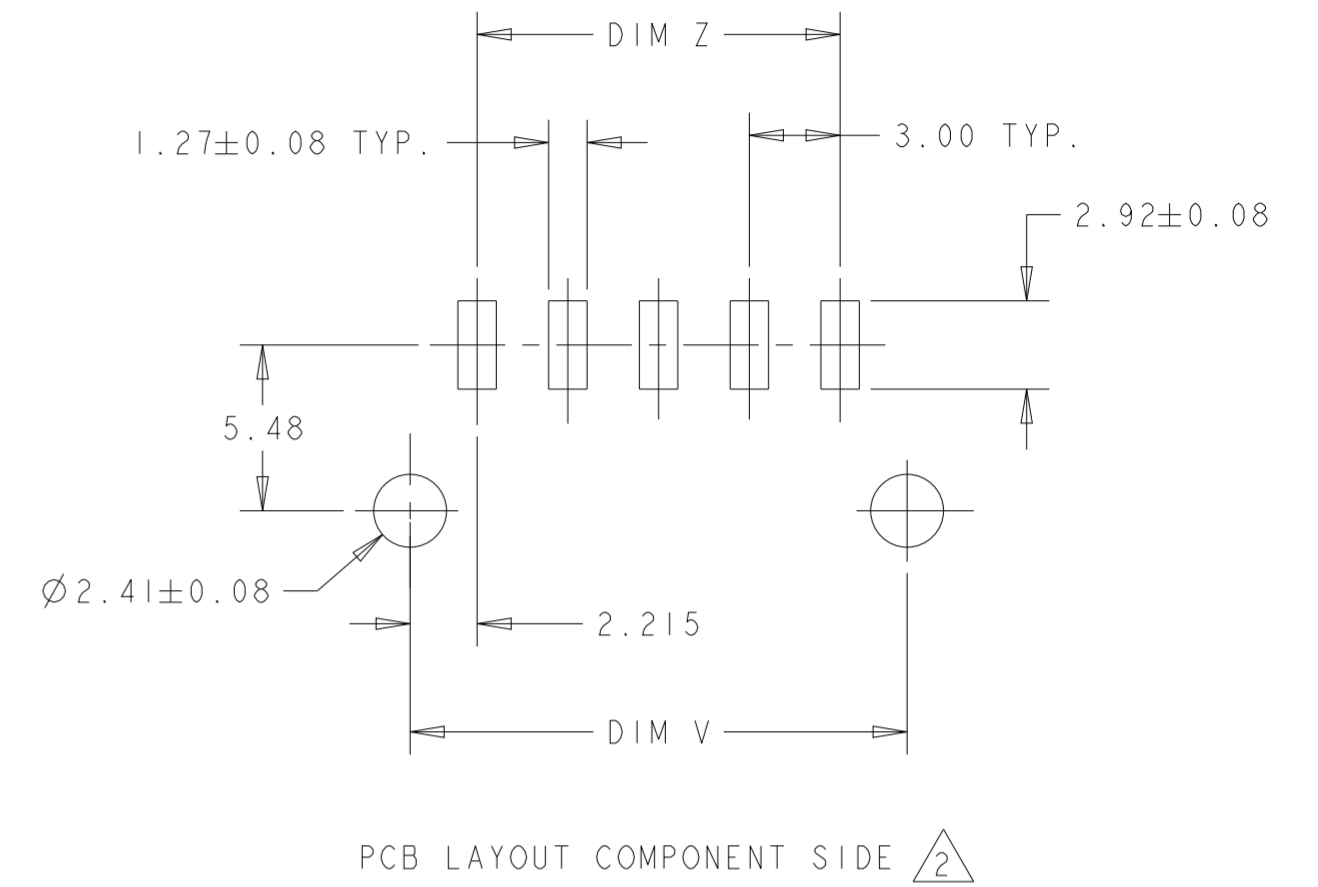
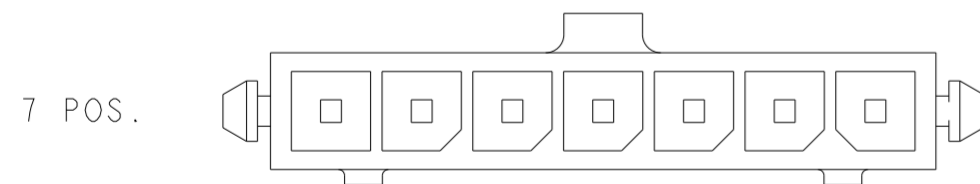
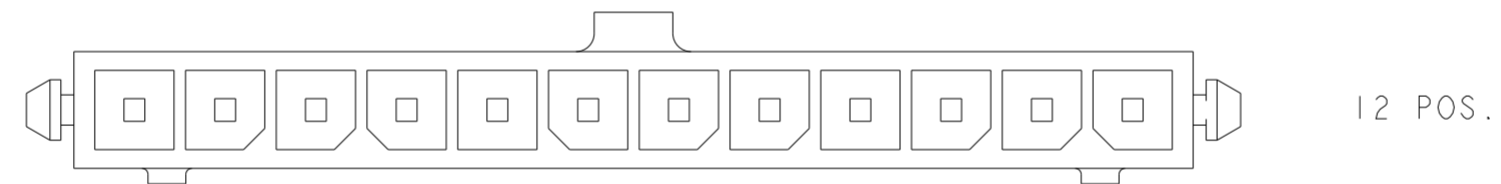
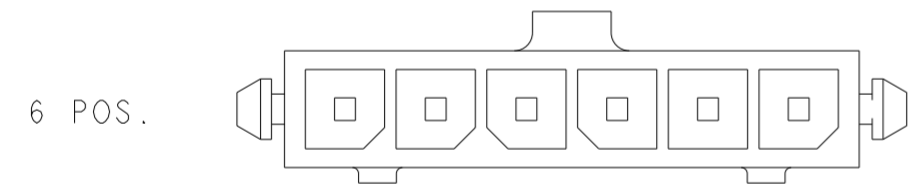
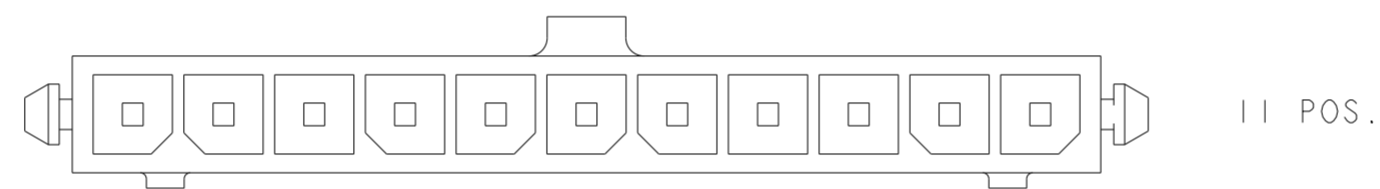
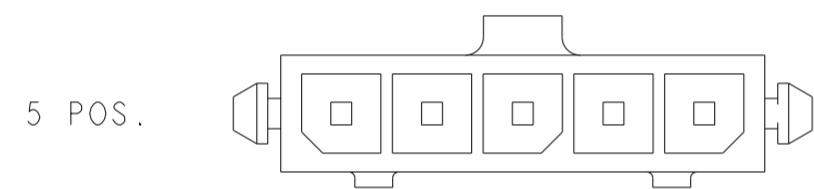
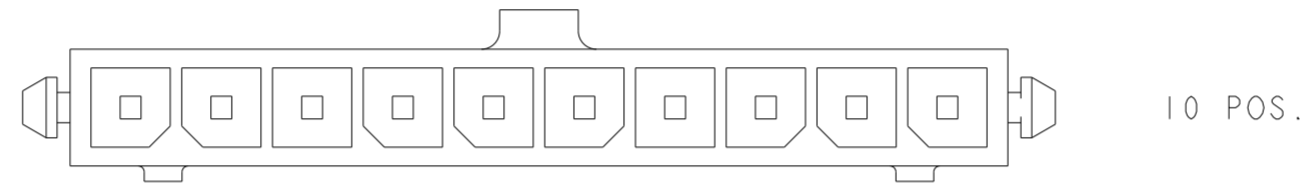
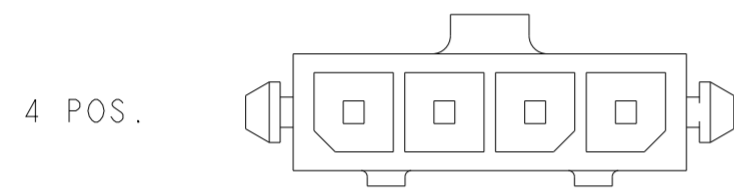
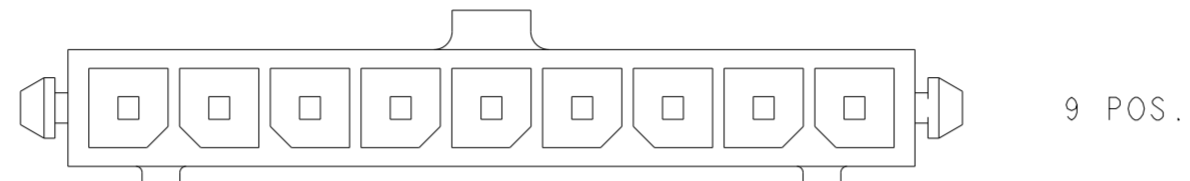
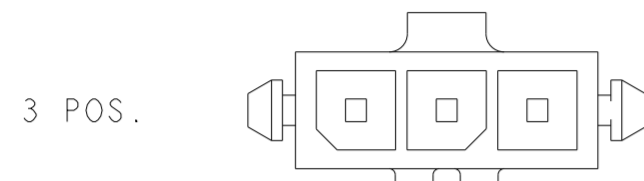
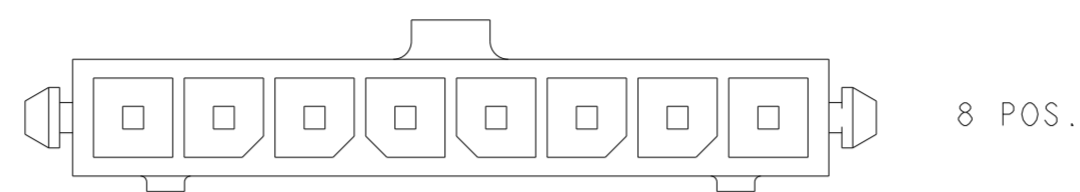
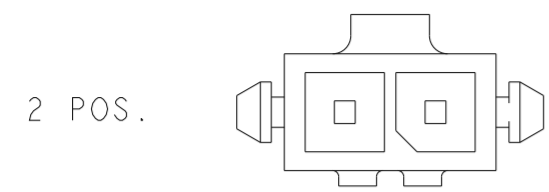

KEYING BY POSITION SIZE

THIS DRAWING IS A CONTROLLED DOCUMENT.		DWN J. ROOT 03OCT2000	TE Connectivity			
DIMENSIONS: mm		CHK K. WHITAKER 13-MAR-2001				
TOLERANCES UNLESS OTHERWISE SPECIFIED:		APVD K. WHITAKER 13-MAR-2001	NAME RT ANGLE SURFACE MOUNT HEADER ASSY, TIN CONTACTS W/THRU HOLE HOLDDOWNS, SINGLE ROW, MICRO MATE-N-LOK			
		PRODUCT SPEC 108-1836	SIZE A2	CAGE CODE 00779	DRAWING NO. C-1445056	RESTRICTED TO -
MATERIAL	FINISH	APPLICATION SPEC 114-13000	SCALE 5:1	SHEET 2 OF 2	REV C5	
-	-	WEIGHT -	CUSTOMER DRAWING			