

SECTION Z-Z

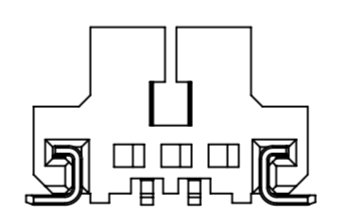

2, 3極形状 (1ロック)
FIGURE OF 2, 3 CIRCUIT (1 LOCK)

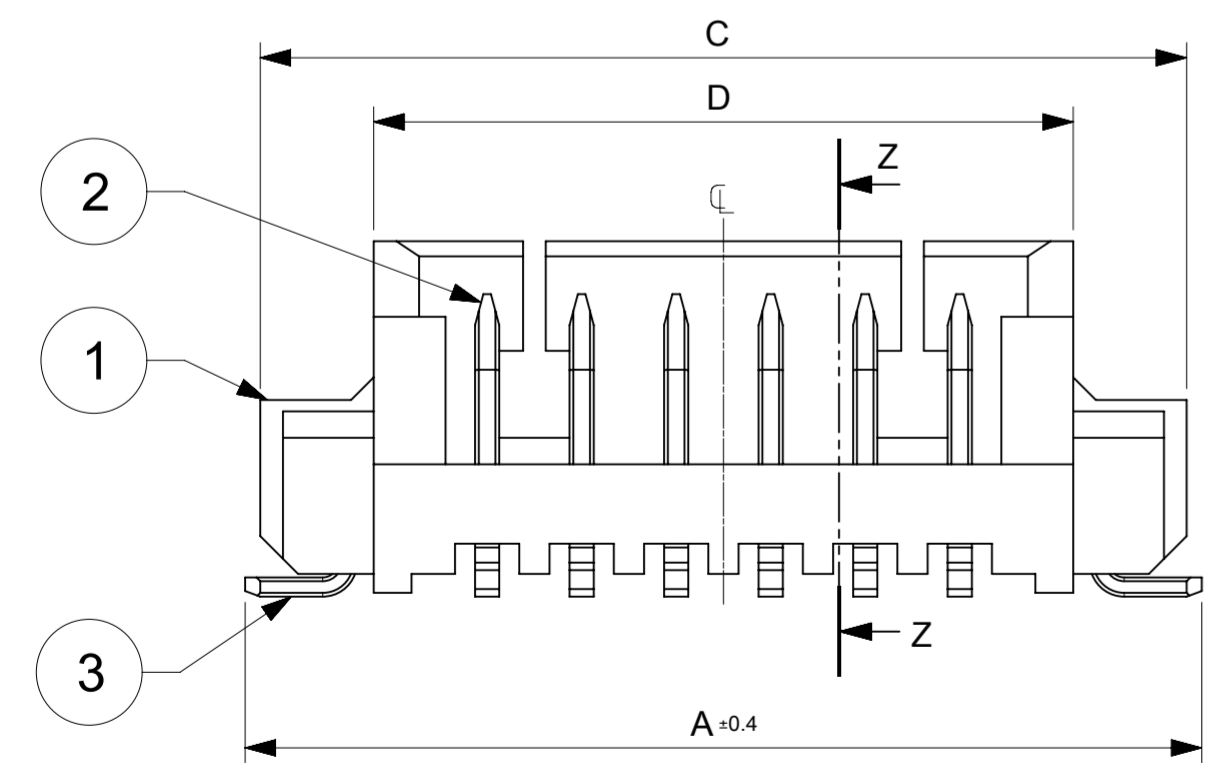
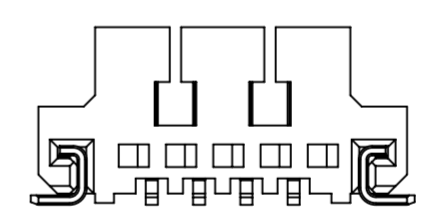

4~15極形状 (2ロック)
FIGURE OF 4-15 CIRCUIT (2 LOCKS)

TABLE 1

番号 NO.	部品 PART	材質 MATERIAL	
①	ハウジング HOUSING	ポリアミド(PA), UL94V-0, GLASS-FILLED, 色: 表参照 POLYAMIDE(PA), UL94V-0, GLASS-FILLED, COLOR: SEE CHART	
②	ターミナル TERMINAL	母材 MATERIAL	りん青銅 PHOSPHOR BRONZE
		コンタクト部 CONTACT AREA	無光沢錫めっき 1.0 MICROMETER MINIMUM
		テール部 TAIL AREA	MATTE TIN PLATING 1.0 MICROMETER MINIMUM
		下地めっき UNDER PLATING	ニッケルめっき 1.0 MICROMETER MINIMUM
③	ネイル NAIL	母材 MATERIAL	りん青銅 PHOSPHOR BRONZE
		テール部 TAIL AREA	無光沢錫めっき 1.0 MICROMETER MINIMUM
		下地めっき UNDER PLATING	ニッケルめっき 1.0 MICROMETER MINIMUM
		下地めっき UNDER PLATING	NICKEL PLATING 1.0 MICROMETER MINIMUM

THIS DRAWING CONTAINS INFORMATION THAT IS PROPRIETARY TO MOLEX ELECTRONIC TECHNOLOGIES, LLC AND SHOULD NOT BE USED WITHOUT WRITTEN PERMISSION

DIMENSION UNITS	SCALE	CURRENT REV DESC:
mm	NTS	
GENERAL TOLERANCES (UNLESS SPECIFIED)		
ANGULAR TOL	± 3.0°	
4 PLACES	± 0.2	EC NO: 706542
3 PLACES	± 0.2	DRWN: QHE31 2022/05/02
2 PLACES	± 0.2	CHK'D: KOMURAKAMI 2022/06/03
1 PLACE	± 0.2	APPR: SAKIYAMA 2022/06/03
0 PLACES	± 0.2	INITIAL REVISION:
DRAFT WHERE APPLICABLE MUST REMAIN WITHIN DIMENSIONS		
THIRD ANGLE PROJECTION	DRAWING	SERIES
	A2-SIZE	53398
DOCUMENT NUMBER		DOC TYPE DOC PART REVISION
533980000-SD		PSD 000 C
MATERIAL NUMBER	CUSTOMER	SHEET NUMBER
SEE CHART	GENERAL	1 OF 5

NOTES

- 材料および仕上げ (めっき仕様) : TABLE 1参照
MATERIAL AND FINISHES : SEE TABLE 1
- 適用製品及び各種仕様書はSHEET 5を参照のこと
REFER TO SHEET 5 ABOUT APPLICABLE PRODUCTS AND VARIOUS SPECIFICATIONS
- 梱包形態 : SHEET 3 参照
PACKAGING INFORMATION : SEE SHEET 3
- 水平面上におけるハウジング底面 W とソルダーテール及びネイル底面とのズレ量を示す。
MISALIGNMENT OF SOLDER TAIL AND NAIL FROM W
- 偶数極のみに適用
APPLY TO EVEN CIRCUIT PRODUCTS.
- 端子テール部およびネイルの平坦度は0.1以下
COPLANARITY OF TAIL AND NAIL TO BE 0.1 MAX.
- ロックの数は、2,3極は1ロック、4極以上は2ロック。
LOCKING WINDOW: ONE PLACE FOR 2 AND 3 CIRCUIT, AND TWO PLACES FOR MORE THAN 4 CIRCUIT.
- 本製品は錫めっき品です。金めっき品は533980002-SDをご参照ください
THIS PRODUCT IS TIN PLATING TYPE. PLEASE REFER TO 533980002-SD FOR GOLD PLATING TYPE

18.6	19.3	20.5	23.5	17.5	23.9	15
17.35	18.05	19.25	22.25	16.25	22.65	14
16.1	16.8	18	21	15	21.4	13
14.85	15.55	16.75	19.75	13.75	20.15	12
13.6	14.3	15.5	18.5	12.5	18.9	11
12.35	13.05	14.25	17.25	11.25	17.65	10
11.1	11.8	13	16	10	16.4	9
9.85	10.55	11.75	14.75	8.75	15.15	8
8.6	9.3	10.5	13.5	7.5	13.9	7
7.35	8.05	9.25	12.25	6.25	12.65	6
6.1	6.8	8	11	5	11.4	5
4.85	5.55	6.75	9.75	3.75	10.15	4
3.6	4.3	5.5	8.5	2.5	8.9	3
2.35	3.05	4.25	7.25	1.25	7.65	2
F	E	D	C	B	A	極数 CIRCUIT SIZE

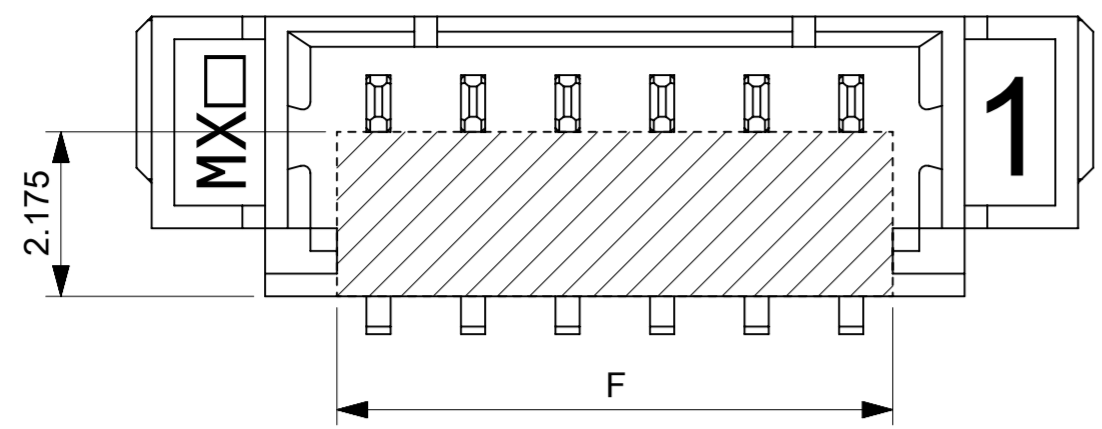

吸着面
VACUUM AREA

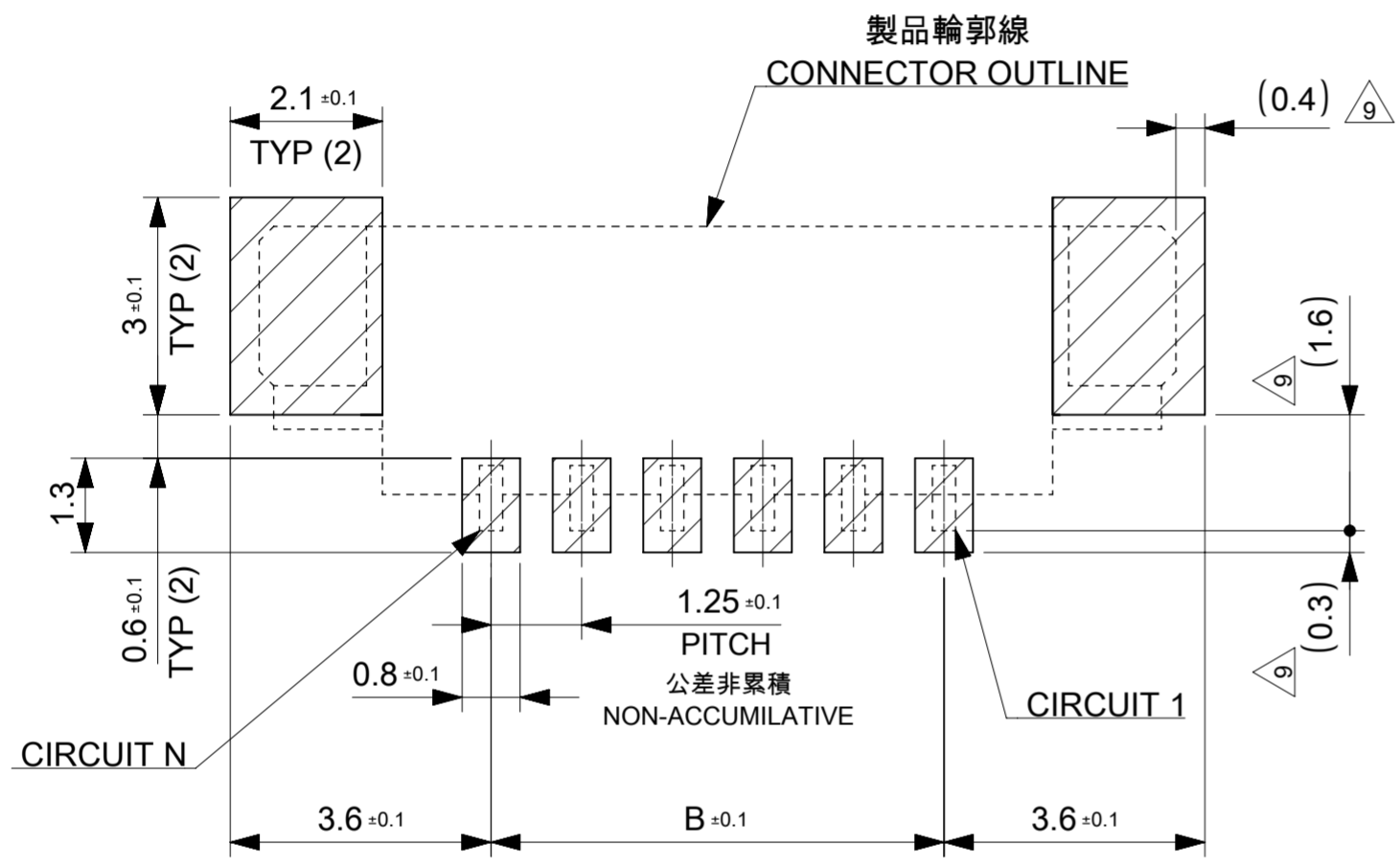

△10 推奨基板レイアウト (実装面側)

RECOMMENDED PCB LAYOUT : COMPONENT SIDE

(参考 : 基板厚 1.0 MILLIMETER, メタルマスク厚 : 0.15 MILLIMETER, マスク開口率:100%)
(REFERENCE : PCB THICKNESS 1.0 MILLIMETER, STENCIL THICKNESS: 0.15 MILLIMETER, APERTURE:100%)

嵌合相手 : 51021 シリーズ
MATE WITH : 51021 SERIES

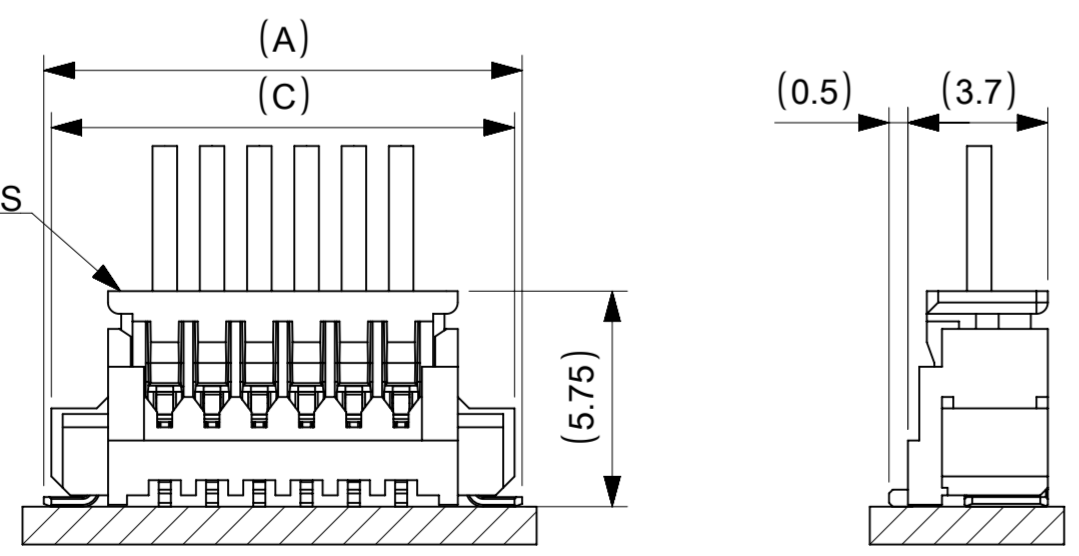

嵌合図
MATED CONNECTORS

NOTES

- △9 製品輪郭線からパッドまでの寸法を示す。
DIMENSIONS FROM CONNECTOR OUTLINE TO PAD
- △10 製品の基板実装部以外の金属露出部と基板パターンとの干渉、および製品と基板上の突起物との干渉が生じないようにご配慮をお願いいたします。
PLEASE TAKE CARE NOT TO CAUSE INTERFERENCE BETWEEN EXPOSED METAL PARTS EXCLUDING MOUNTING PORTION OF PRODUCT AND PCB PATTERN, AND INTERFERENCE BETWEEN PRODUCT AND PROTRUSIONS ON PCB.

18.6	19.3	20.5	23.5	17.5	23.9	15
17.35	18.05	19.25	22.25	16.25	22.65	14
16.1	16.8	18	21	15	21.4	13
14.85	15.55	16.75	19.75	13.75	20.15	12
13.6	14.3	15.5	18.5	12.5	18.9	11
12.35	13.05	14.25	17.25	11.25	17.65	10
11.1	11.8	13	16	10	16.4	9
9.85	10.55	11.75	14.75	8.75	15.15	8
8.6	9.3	10.5	13.5	7.5	13.9	7
7.35	8.05	9.25	12.25	6.25	12.65	6
6.1	6.8	8	11	5	11.4	5
4.85	5.55	6.75	9.75	3.75	10.15	4
3.6	4.3	5.5	8.5	2.5	8.9	3
2.35	3.05	4.25	7.25	1.25	7.65	2
F	E	D	C	B	A	極数 CIRCUIT SIZE

THIS DRAWING CONTAINS INFORMATION THAT IS PROPRIETARY TO MOLEX ELECTRONIC TECHNOLOGIES, LLC AND SHOULD NOT BE USED WITHOUT WRITTEN PERMISSION

DIMENSION UNITS mm	SCALE NTS	CURRENT REV DESC:	molex			
GENERAL TOLERANCES (UNLESS SPECIFIED)						
ANGULAR TOL ± 3.0°		EC NO: 706542	PICOBLADE 1.25 SMT VERTICAL TIN PLATING TYPE			
4 PLACES ± 0.2		DRWN: QHE31 2022/05/02				
3 PLACES ± 0.2		CHK'D: KOMURAKAMI 2022/06/03	PRODUCT CUSTOMER DRAWING			
2 PLACES ± 0.2		APPR: SAKIYAMA 2022/06/03				
1 PLACE ± 0.2		INITIAL REVISION:	DOCUMENT NUMBER	DOC TYPE	DOC PART	REVISION
0 PLACES ± 0.2		DRWN: SOBARA01 2019/04/04	533980000-SD	PSD	000	C
		APPR: AIDA 2019/10/30				
DRAFT WHERE APPLICABLE MUST REMAIN WITHIN DIMENSIONS	THIRD ANGLE PROJECTION	DRAWING	SERIES	MATERIAL NUMBER	CUSTOMER	SHEET NUMBER
		A2-SIZE	53398	SEE CHART	GENERAL	2 OF 5

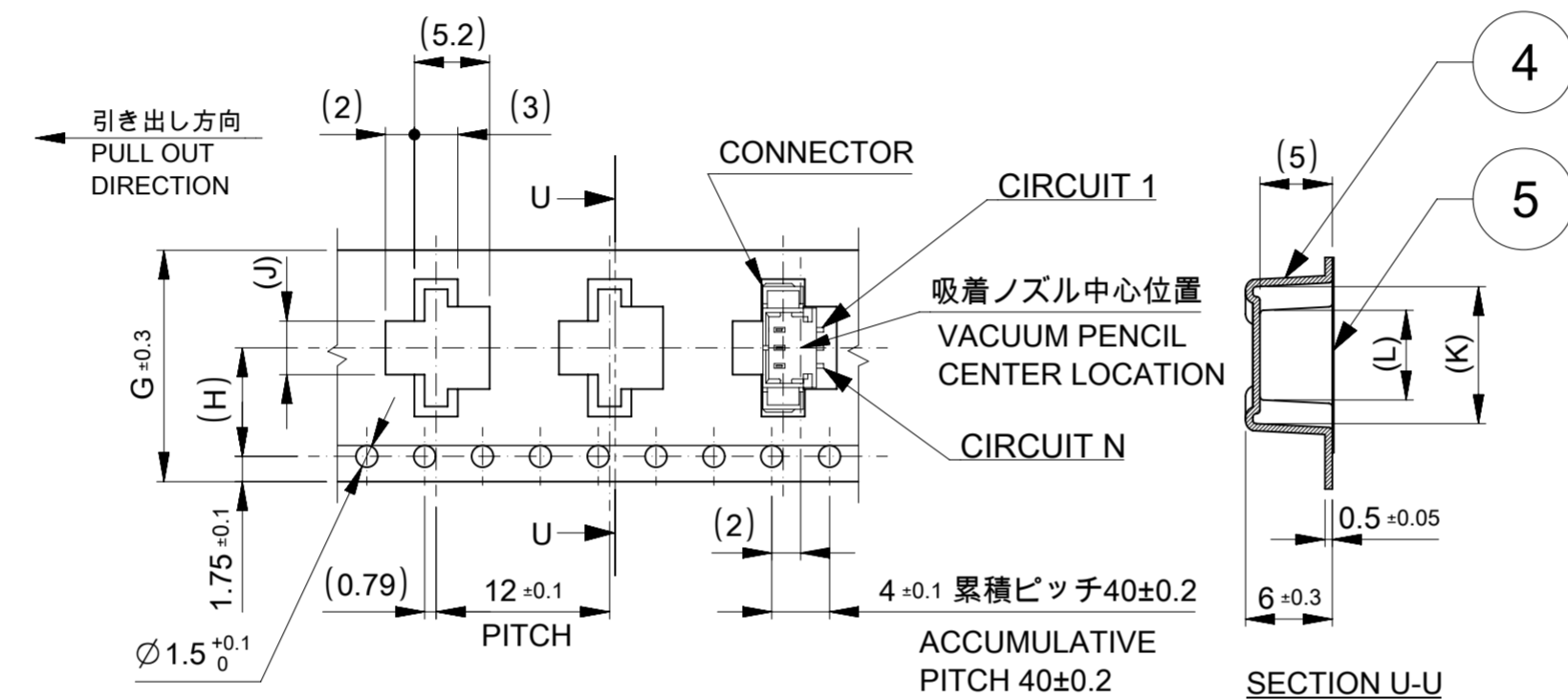
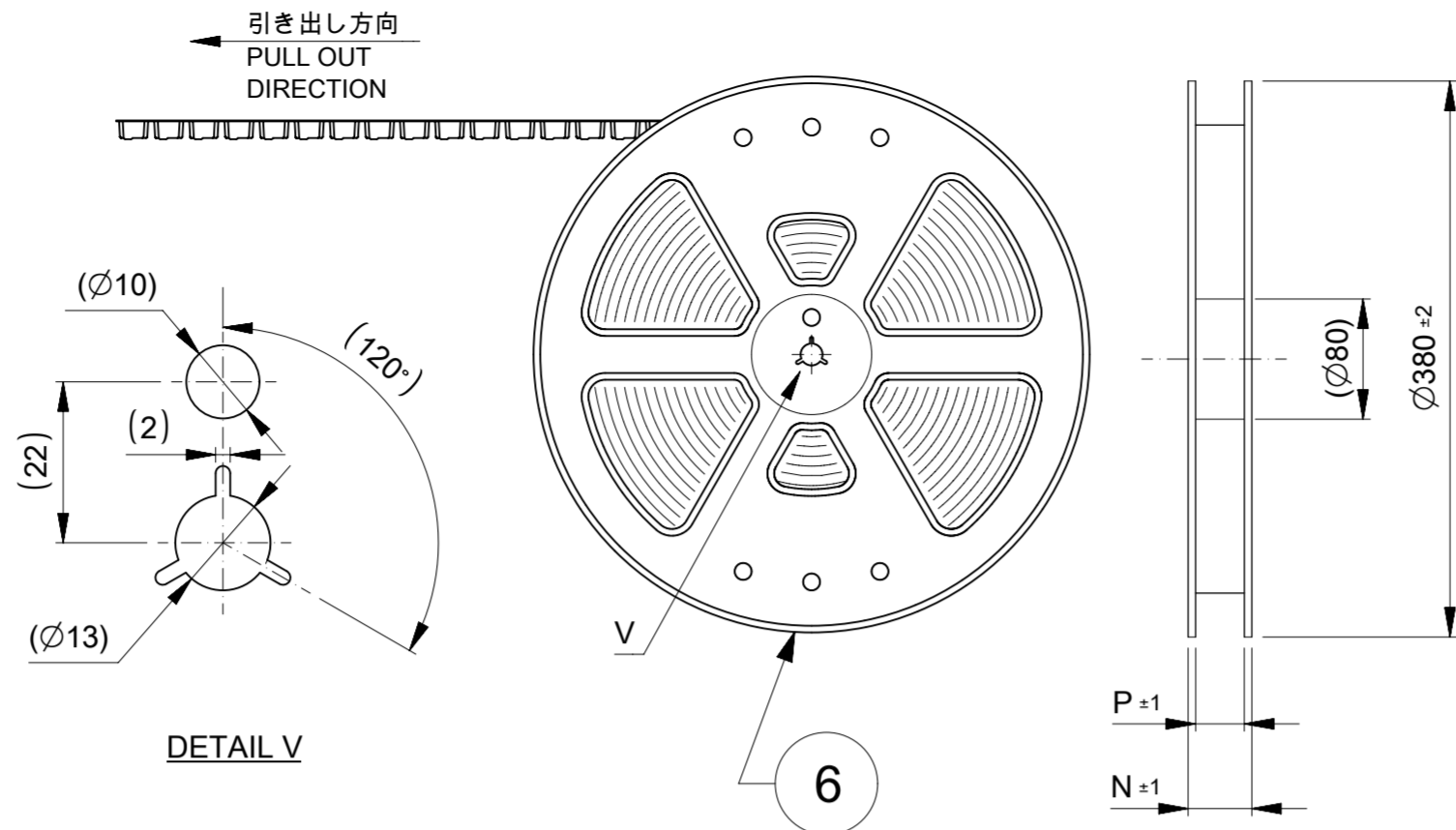

16mm幅(2~3極用)および24mm幅(4~10極用)キャリアテープ
16mm (FOR 2-3 CIRCUIT) OR 24mm (FOR 4-10 CIRCUIT) WIDTH CARRIER TAPE

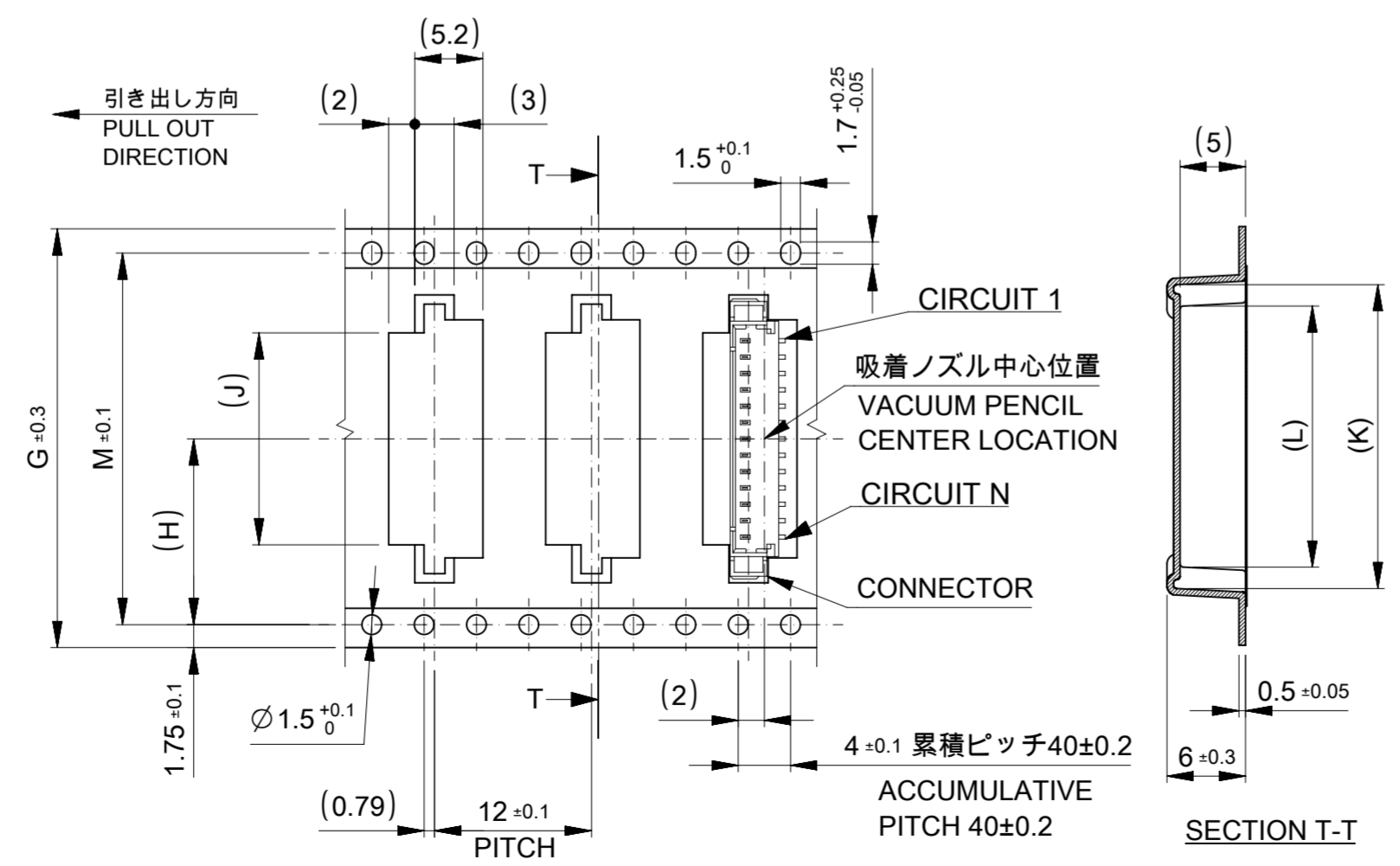

32mm幅(11~13極用)および44mm幅(13~15極用)キャリアテープ
32mm (FOR 11-13 CIRCUIT) OR 44mm (FOR 13-15 CIRCUIT) WIDTH CARRIER TAPE

NOTES

- 梱包数量 : 1000個/リール
NUMBER OF CONNECTOR : 1000PCS / REEL
 - リードテープ長さ
LEAD TAPE LENGTH
-
- 材料 : TABLE 2 参照
MATERIAL : REFER TO TABLE 2
 - トップテープの剥離強度はIEC60286-3に準拠
TOP TAPE PELING FORCE IS DEFINED BY IEC60286-3.
 - 本製品は乾燥剤入り、ハイバリア梱包仕様による納品となります。
THIS PRODUCT IS DELIVERED IN A HIGH BARRIER PACKAGE WITH DESICCANT.
 - 梱包仕様書 : SPK-53398-002
PACKING SPECIFICATION : SPK-53398-002

TABLE 2

番号 NO.	部品 PART	材質 MATERIAL
④	キャリアテープ CARRIER TAPE	ポリプロピレン(PP) POLYPROPYLENE(PP)
⑤	トップテープ TOP TAPE	ポリエチレン (PE)、その他 POLYETHYLENE (PE), ETC
⑥	リール REEL	ポリスチレン(PS) <リサイクル材を含む> POLYSTYRENE(PS) <RECYCLE MATERIAL CONTAINED >

17. 発注番号
ORDER NUMBER

53398****

極数
CIRCUIT

533981576	533981571	15
533981476	533981471	14
533981376	533981371	13
533981276	533981271	12
533981176	533981171	11
533981076	533981071	10
533980976	533980971	9
533980876	533980871	8
533980776	533980771	7
533980676	533980671	6
533980576	533980571	5
533980476	533980471	4
533980376	533980371	3
533980276	533980271	2

色 : 黒 COLOUR: BLACK	色 : ナチュラル(ベージュ) COLOUR: NATURAL (BEIGE)	極数 CIRCUIT
発注番号 ORDER NO.		
梱包形態 : エンボス梱包		
PACKAGING : EMBOSSED TAPE AND REEL		

DOCUMENT STATUS	P1	RELEASE DATE	2022/06/03	11:50:50
-----------------	----	--------------	------------	----------

THIS DRAWING CONTAINS INFORMATION THAT IS PROPRIETARY TO MOLEX ELECTRONIC TECHNOLOGIES, LLC AND SHOULD NOT BE USED WITHOUT WRITTEN PERMISSION

DIMENSION UNITS	SCALE	CURRENT REV DESC:
mm	NTS	
GENERAL TOLERANCES (UNLESS SPECIFIED)		
ANGULAR TOL	± 3.0°	
4 PLACES	± 0.2	EC NO: 706542
3 PLACES	± 0.2	DRWN: QHE31 2022/05/02
2 PLACES	± 0.2	CHK'D: KOMURAKAMI 2022/06/03
1 PLACE	± 0.2	APPR: SAKIYAMA 2022/06/03
0 PLACES	± 0.2	INITIAL REVISION:
		DRWN: SOBARA01 2019/04/04
		APPR: AIDA 2019/10/30
DRAFT WHERE APPLICABLE MUST REMAIN WITHIN DIMENSIONS	THIRD ANGLE PROJECTION	DRAWING SERIES
		A2-SIZE 53398
MATERIAL NUMBER		CUSTOMER
SEE CHART		GENERAL
DOCUMENT NUMBER		DOC TYPE DOC PART REVISION
533980000-SD		PSD 000 C
SHEET NUMBER		
3 OF 5		

molex

PICOBLADE 1.25
SMT VERTICAL TIN PLATING TYPE

PRODUCT CUSTOMER DRAWING

18 533981071
 韓国生産分に適用
 APPLIES TO PRODUCT
 PRODUCED BY MXK

NOTES

18 韓国生産分の533981071(10極品)は、キャリアテープ幅32mmでの納品となります。
 533981071 (10 CIRCUIT) MADE IN MXK IS DELIVERED WITH 32mm WIDTH CARRIER TAPE.

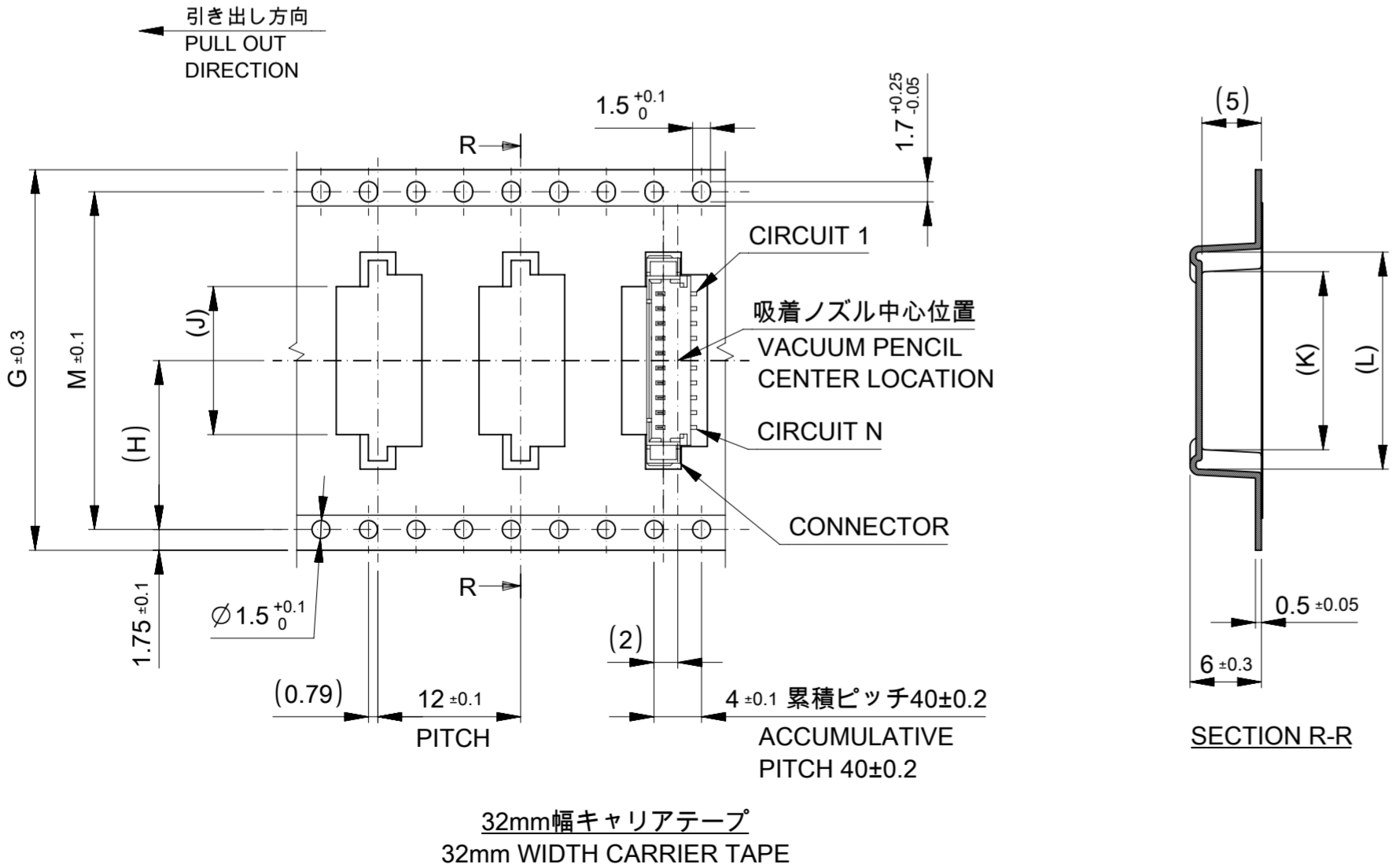
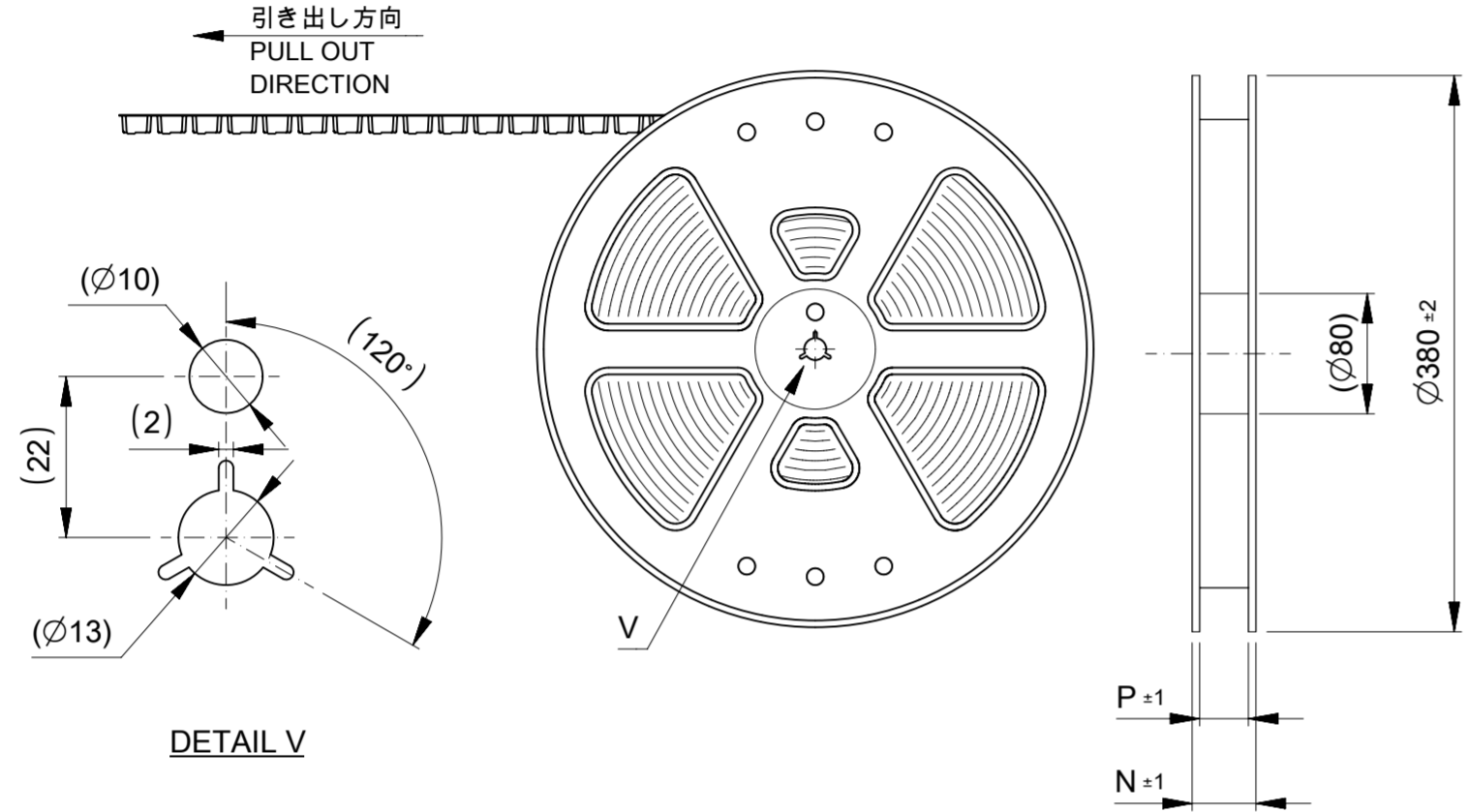

33.4	37.4	28.4	18.25	14.55	12.45	14.2	32	10
P	N	M	L	K	J	H	キャリアテープ幅 G CARRIER TAPE WIDTH G	極数 CIRCUIT SIZE

THIS DRAWING CONTAINS INFORMATION THAT IS PROPRIETARY TO MOLEX ELECTRONIC TECHNOLOGIES, LLC AND SHOULD NOT BE USED WITHOUT WRITTEN PERMISSION

DIMENSION UNITS	SCALE	CURRENT REV DESC:	molex		
mm	NTS				
GENERAL TOLERANCES (UNLESS SPECIFIED)			PICOBLADE 1.25 SMT VERTICAL TIN PLATING TYPE		
ANGULAR TOL	± 3.0°	EC NO: 706542	PRODUCT CUSTOMER DRAWING		
4 PLACES	± 0.2	DRWN: QHE31 2022/05/02	DOCUMENT NUMBER		
3 PLACES	± 0.2	CHK'D: KOMURAKAMI 2022/06/03	533980000-SD		
2 PLACES	± 0.2	APPR: SAKIYAMA 2022/06/03	DOC TYPE	DOC PART	REVISION
1 PLACE	± 0.2	INITIAL REVISION:	PSD	000	C
0 PLACES	± 0.2	DRWN: SOBARA01 2019/04/04	SHEET NUMBER		
DRAFT WHERE APPLICABLE MUST REMAIN WITHIN DIMENSIONS		APPR: AIDA 2019/10/30	MATERIAL NUMBER	CUSTOMER	4 OF 5
THIRD ANGLE PROJECTION		DRAWING	SERIES	GENERAL	
A2-SIZE		53398	SEE CHART		

△ 適合製品及び各種仕様書
 APPLICABLE PRODUCTS AND SPECIFICATIONS

梱包仕様書 PACKING SPECIFICATION		PART NUMBER 53398**71 / 53398**76		SPECIFICATION NUMBER SPK-53398-002	
適合ハウジング APPLICABLE HOUSING		PART NUMBER 51021**00			
適合圧着端子 APPLICABLE TERMINAL	PLATING	TIN			
	PART NUMBER	500798*00	500588*00	500798001	500588001
	WIRE SIZE (AWG)	#26-28	#28-32	#26-28	#28-32
製品仕様書 PRODUCT SPECIFICATION		PS-51021-024 PS 001		510211124-PS PS 000	
アプリケーション仕様書 (取扱説明書) APPLICATION SPECIFICATION		510210000-AS PS 000			

THIS DRAWING CONTAINS INFORMATION THAT IS PROPRIETARY TO MOLEX ELECTRONIC TECHNOLOGIES, LLC AND SHOULD NOT BE USED WITHOUT WRITTEN PERMISSION										
DIMENSION UNITS	SCALE	CURRENT REV DESC:				molex				
mm	NTS									
GENERAL TOLERANCES (UNLESS SPECIFIED)						PICOBLADE 1.25 SMT VERTICAL TIN PLATING TYPE				
ANGULAR TOL	± 3.0°	EC NO: 706542				PRODUCT CUSTOMER DRAWING				
4 PLACES	± 0.2	DRWN: QHE31		2022/05/02						
3 PLACES	± 0.2	CHK'D: KOMURAKAMI		2022/06/03						
2 PLACES	± 0.2	APPR: SAKIYAMA		2022/06/03						
1 PLACE	± 0.2	INITIAL REVISION:				DOCUMENT NUMBER				
0 PLACES	± 0.2	DRWN: SOBARA01		2019/04/04		533980000-SD		PSD	000	C
DRAFT WHERE APPLICABLE MUST REMAIN WITHIN DIMENSIONS		THIRD ANGLE PROJECTION		DRAWING	SERIES	MATERIAL NUMBER	CUSTOMER	SHEET NUMBER		
				A2-SIZE	53398	SEE CHART	GENERAL	5 OF 5		

DOCUMENT STATUS	P1	RELEASE DATE	2022/06/03	11:50:50
-----------------	----	--------------	------------	----------