



TE Connectivity

CUSTOMER DATA

PART NO.

1432873-1

SHT. 1
OF 2

DRAWN V.NESTOROVSKI	APPROVAL B. TOEPFER	DATE FIRST_DRAWN 08-10-06	SCALE 1:1
------------------------	------------------------	------------------------------	--------------

CUSTOMER TYCO_ELECTRONICS_STANDARD

TOLERANCE	0.X	=	+/-
UNLESS	0.XX	=	+/-
SPECIFIED	0.XXX	=	+/-
OTHERWISE	ANGLES	=	+/-

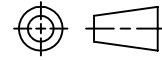

DO NOT SCALE THIS DRAWING

CHANGES

REV.	DATE	CO	APP.
	04OCT2016	ECR-16-014229	B.T.
	07NOV2017	ECO-17-003787	B.T.

NOT TO BE USED IN AUTOMOTIVE APPLICATIONS OR APPLICATIONS REQUIRING PPAP AND/OR IMDS DOCUMENTATION

ELECTRICAL CHARACTERISTICS: (ALL DATA APPLIES @ 23°C UNLESS OTHERWISE SPECIFIED)COIL DATA:

NOMINAL VOLTAGE:	6 VDC
OPERATE VOLTAGE:	3.9 VDC MAXIMUM
RELEASE VOLTAGE:	0.6 VDC MINIMUM
COIL RESISTANCE:	22.5 OHMS +/- 10%
OPERATE TIME:	8 mSEC. MAXIMUM EXCLUDING BOUNCE
RELEASE TIME:	5 mSEC. MAXIMUM EXCLUDING BOUNCE
TEMPERATURE RANGE:	OPERATING -40°C TO +85°C

CONTACT DATA: (CONTACT DATA IS FORMATTED N.O./N.C.)

CONTACT ARRANGEMENT:	1 FORM C (SPDT)
CONTACT MATERIAL:	AgSnO (SILVER TIN-OXIDE)
CONTACT MILLIVOLT DROP:	200mv @ 35A ON N.O. CONTACTS (AFTER SWITCHING) 250mv @ 20A ON N.C. CONTACTS (AFTER SWITCHING)
MAXIMUM MAKE CURRENT:	90A/30A (LAMP) @ 16 VDC
MAXIMUM BREAK CURRENT:	40A/30A @ 16 VDC RESISTIVE
MAXIMUM CONTINUOUS CURRENT:	40A/30A @ 23°C , 35A/20A @ 85°C
INITIAL BREAKDOWN CURRENT	500V RMS CONTACTS TO COIL

EXPECTED LIFE:	100,000 OPERATIONS, 40 A, 14 VDC RESISTIVE ON NORMALLY OPEN CONTACT
----------------	---

MECHANICAL CHARACTERISTICS:

EXPECTED LIFE:	10 MILLION OPERATIONS, NO CONTACT LOAD
TERMINALS	COPPER, UNPLATED



TE Connectivity

CUSTOMER DATA

PART NO.

1432873-1

SHT. 2
OF 2

DRAWN V.NESTOROVSKI	APPROVAL B. TOEPFER	DATE FIRST_DRAWN 08-10-06	SCALE 1:1
------------------------	------------------------	------------------------------	--------------

CUSTOMER
TYCO_ELECTRONICS_STANDARD

TOLERANCE 0.X = +/-
 UNLESS 0.XX = +/-
 SPECIFIED 0.XXX = +/-
 OTHERWISE ANGLES = +/-

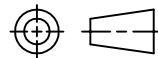

DO NOT SCALE THIS DRAWING

REV D

MILLIMETERS

MARKING TO INCLUDE:

TYCO ELECTRONICS NAME, TYCO ELECTRONICS PART NUMBER, SCHEMATIC, COIL VOLTAGE, COUNTRY OF ORIGIN, AND DATE CODE

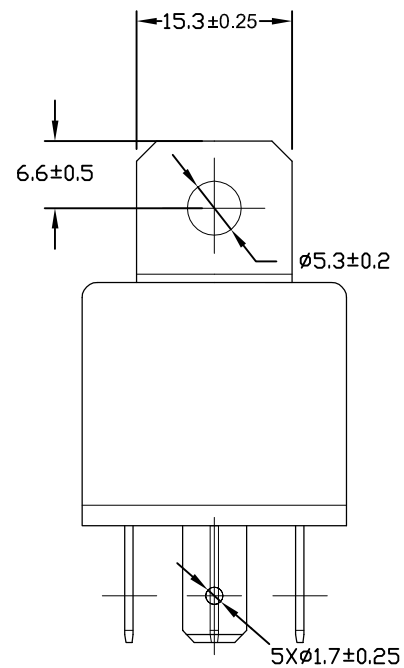
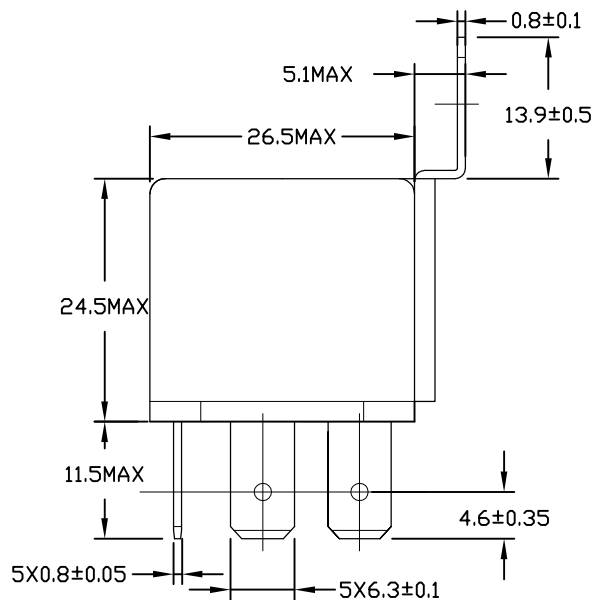

* TERMINAL LOCATIONS APPLY AT THE BASE OF THE TERMINALS

K Aspect

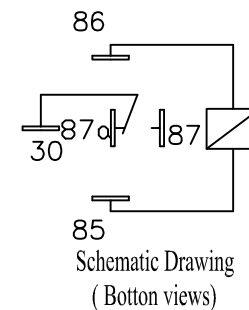
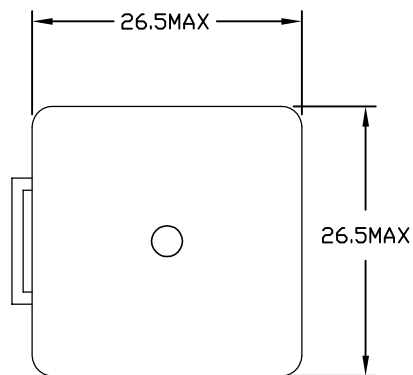
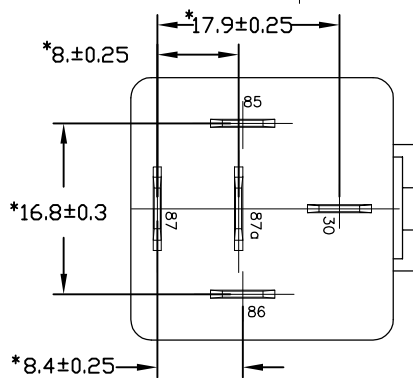

NOT TO BE USED IN AUTOMOTIVE APPLICATIONS OR APPLICATIONS REQUIRING PPAP AND/OR IMDS DOCUMENTATION