



Trusted RF Solutions™

NuPower Xtender™ 12B04A-D30 L- & S-Band Bidirectional Amplifier

15 Watt CW

2.5 Watts Linear, 5% EVM @ 34 dBm

1.0 GHz - 2.5 GHz



P/N: NW-BA-12B04A-D30

(includes NW-BA-ACC-CB09MA)

The NuPower Xtender™ 12B04A-D30 is a small, lightweight, and power-efficient bidirectional amplifier ideal for extending the communication range of half-duplex L- or S-band transceivers running constant-envelope or near-constant-envelope waveforms. The bidirectional amplifier generates over 10 Watts of RF power from 1000 to 2500 MHz in transmit mode and the integrated low-noise amplifier provides a minimum of 13 dB of gain in receive mode.

Based on the latest gallium nitride (GaN) technology, the Xtender offers 30% power efficiency within a small form factor making it ideal for integration into space-constrained platforms. Adjacent radio frequency bands, such as the popular 900 MHz Industrial, Scientific and Medical (ISM) band, are also supported by the bidirectional PA, at lower peak power levels.

Accepting a +30 dBm RF input, the Xtender provides more than 10 dB of transmit gain. The Xtender also features over-voltage and reverse-voltage protection and operates over a wide temperature range of -30 to +60 °C.

Extend your operational communication range with NuPower™ amplifiers from NuWaves Engineering.

Features

- 15 Watts RF Output Power
- 1.0 to 2.5 GHz
- Bidirectional Operation
- 10 dB of Transmit Gain
- 13 dB Gain LNA
- Fast T/R Mode Switching with Auto-Sensing or Manual T/R Line
- Small Form Factor
- High Efficiency GaN Technology
- Over-Voltage & Reverse-Voltage Protection

Applications

- Unmanned Aircraft Systems (UAS) - Group 2 and Group 3
- Unmanned Ground Vehicles (UGV)
- RF Communication Systems
- Software Defined Radios

NuPower Xtender™ 12B04A-D30 BDA

Specifications

Absolute Maximums

Parameter	Rating	Unit
Max Device Voltage	32	V
Max Device Current	3.5	A
Max Peak RF Input Power, $Z_L = 50 \Omega$	33	dBm
Max Operating Temperature (ambient)	60	°C
Max Operating Temperature (baseplate)	85	°C
Max Storage Temperature	85	°C

Export Classification
EAR99

Absolute Maximums (cont.)

Description	Autosense T/R Mode	Manual T/R Mode	Unit
Max Receive Input Power (No Damage)	-13.5	+30	dBm
Max Receive Input Power (Linear Operation)	-13.5	0	dBm

Electrical Specifications - Operational @ 28 VDC, 25 °C, $Z_S=Z_L=50 \Omega$

Parameter	Symbol	Min	Typ	Max	Unit	Condition
Operating Frequency	BW	1000		2500	MHz	
Switching Speed	$T_{XON/OFF}$			1.5	μ S	10% to 90%
Operating Voltage	VDC	11	28	32	V	
Operating Current	I_{DD}		2.2	2.6	A	CW, Pin = +30 dBm
Module Efficiency			30		%	CW, Pin = +30 dBm

Electrical Specifications - Transmit @ 28 VDC, 25 °C, $Z_S=Z_L=50 \Omega$

Parameter	Symbol	Min	Typ	Max	Unit	Condition
RF Output Power, Linear	P_L		2.5		W	802.11g, 10 MHz BW, 16 QAM
RF Output Power, Psat	P_{sat}	10	15		W	CW, Pin = +30 dBm
Transmit Gain	G	10			dB	CW, Pin = +30 dBm
2nd Harmonic				-13	dBc	CW, Pin = +30 dBm
Nominal Input Drive Level	P_{IN}		30		dBm	
Transmit Current	I_{TX}		2.5	3.2	A	CW, Pin = +30 dBm
Transmit Output Mismatch VSWR				10:1	ψ	No damage at all phase angles
Transmit Input VSWR			1.7:1			

Electrical Specifications - Receive @ 28 VDC, 25 °C, $Z_S=Z_L=50 \Omega$

Parameter	Symbol	Min	Typ	Max	Unit	Condition
Receive P1dB	P1dB				dBm	
Receive Gain	G		13		dB	
Receive Gain Flatness	ΔG				dB	
Receive Current	I_{RX}		100		mA	
Receive Noise Figure	NF		3.5			

NuPower Xtender™ 12B04A-D30 BDA

Specifications (cont.)

Mechanical Specifications

Parameter	Value	Unit	Limits
Dimensions	3.0 x 2.0 x 1.16	in	Max
Weight	5.8	oz	Max
RF Connectors, Input/Output	SMA Female		
Interface Connector	Micro-D, 9-pin Socket		
Cooling	Adequate Heatsink Required		

Environmental Specifications

Parameter	Symbol	Min	Typ	Max	Unit
Operating Temperature (ambient)	T _A	-40		+60	°C
Operating Temperature (baseplate)	T _C	-40		+85	°C
Storage Temperature	T _{STG}	-55		+85	°C
Relative Humidity (non-condensing)	RH			95	%
Altitude MIL-STD-810F - Method 500.4	ALT			30,000	ft
Vibration / Shock Profile (Random profile in x,y, z axis, as per Figure for 15 minute duration in each axis)					

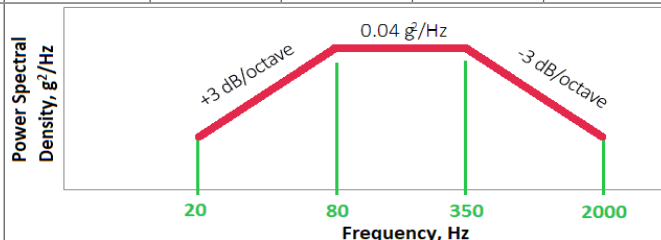

NuPower Xtender™ 12B04A-D30 BDA

Performance Plots

Test Conditions: +28 VDC, +25 °C, $Z_S=Z_L=50 \Omega$

Output Power [+30 dBm Input Power]

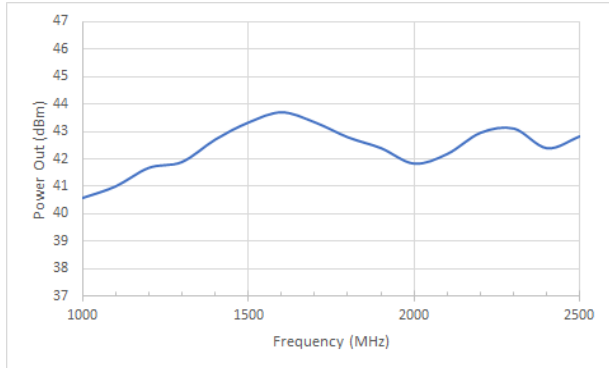

Small Signal Gain [0 dBm Input Power]

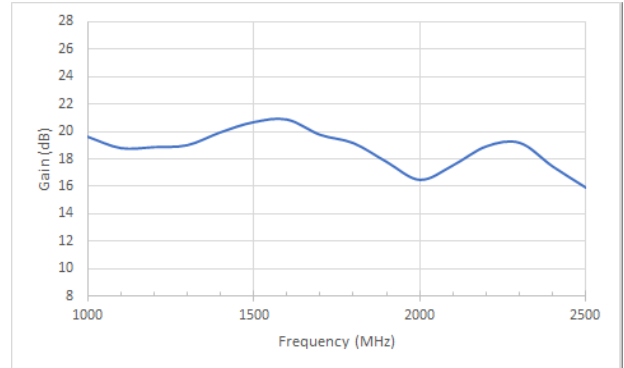

Efficiency [+30 dBm Input Power]

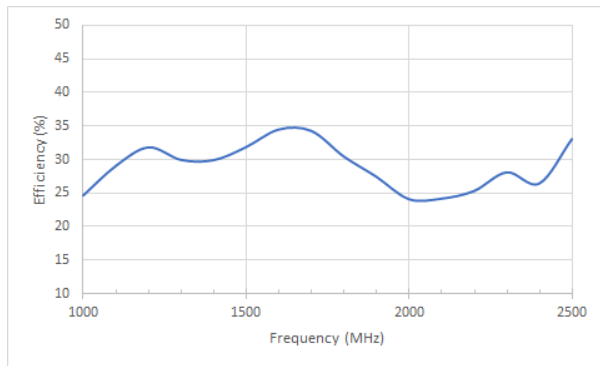

Output Power vs. Input Power

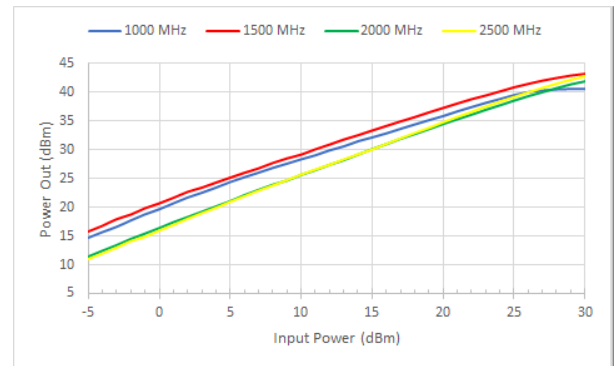

Efficiency vs. Output Power

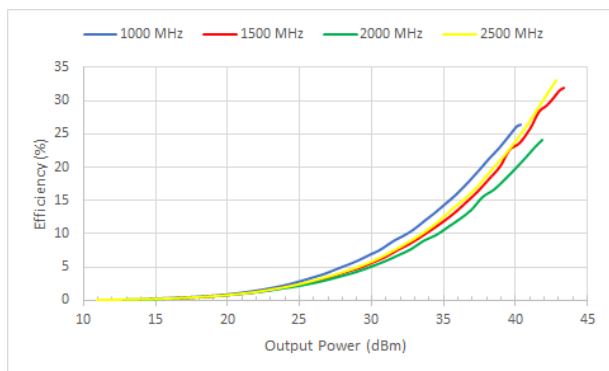

Efficiency vs. Input Power

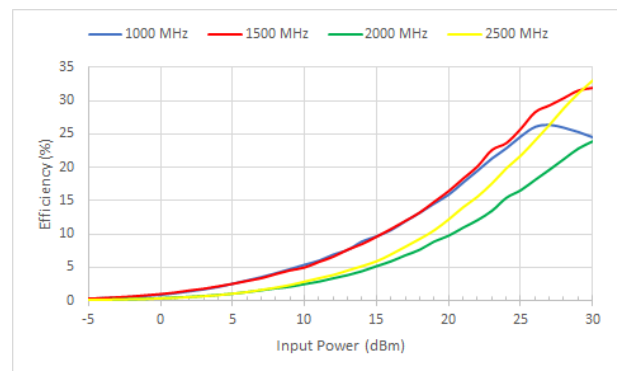

NuPower Xtender™ 12B04A-D30 BDA

Mechanical Outline

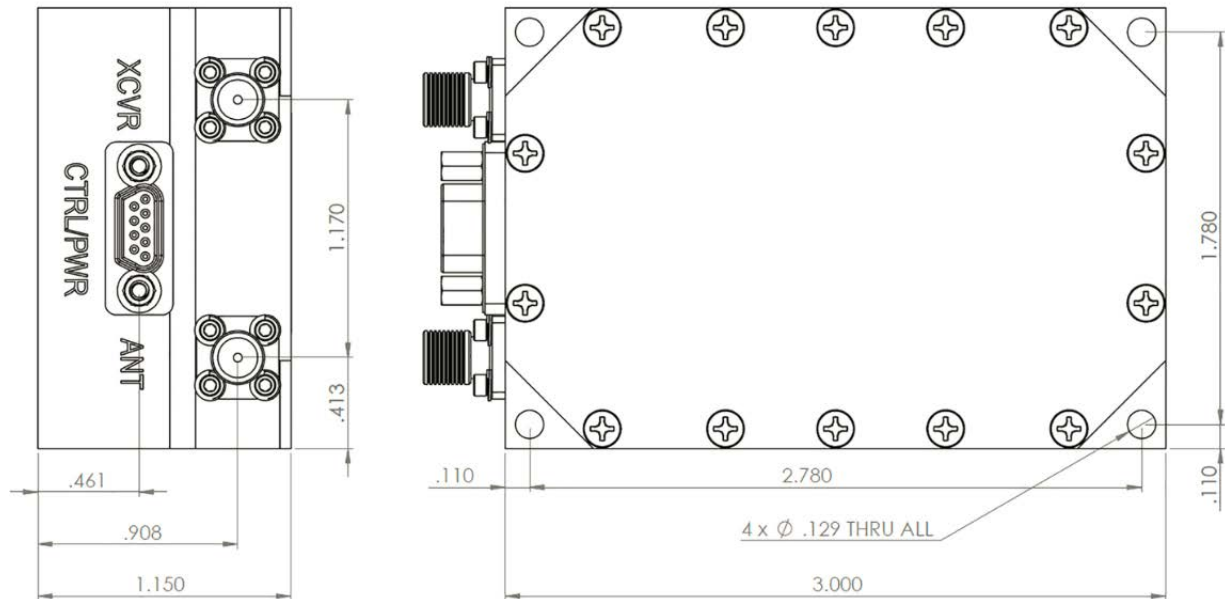

Accessory Part Numbers

Part Number	Description
NW-FL-05LPLE-2500-SFSF-M01	Harmonic Filter Module
NW-BA-ACC-CB09MA	Standard Interface Cable Assembly - Flying Leads (included with module)
NW-BA-ACC-CT09MA	Upgraded Interface Cable Assembly - Banana Plug Termination
NW-BA-ACC-KT01	Accessory Kit, which includes Fan-Cooled Heatsink and Upgraded Interface Cable
NW-BA-ACC-HS02	Heatsink with Integrated Fan

Pinout

Function	I/O	Pin
DC Power (+11 to +32 Volts)	I	1, 2, 9
Ground	I	3, 4, 5
RS-485 Data Transmit	O	6
RS-485 Data Receive	I	7
Transmit/Receive Source or Sink	I/O	8

For information on product disposal (end-of-life), please refer to this document: <https://nuwaves.com/wp-content/uploads/Product-Disposal-End-of-Life.pdf>

Contact NuWaves



NuWaves Engineering
132 Edison Drive
Middletown, OH 45044

www.nuwaves.com
product.sales@nuwaves.com
513.360.0800

NuWaves
engineering

Trusted RF Solutions™