

**General Safety Instructions:**

READ SAFETY INSTRUCTIONS

**Servicing:**

These products are not customer serviceable. TDK-Lambda UK LTD. and their authorised agents only are permitted to carry out repairs.

**Critical Components:**

These products are not authorised for use as critical components in nuclear control systems, life support systems or equipment for use in hazardous environments without the express written approval of the Managing Director of TDK-Lambda EMEA.

**Product Usage:**

These products are designed for use within a host equipment which restricts access to authorised competent personnel.

This product is a component power supply and is only to be installed by qualified persons within other equipment and must not be operated as a stand alone product.

This product is for sale to business to business customers and can be obtained via distribution channels.

It is not intended for sale to end users.

This product is a component power supply and does not fall within the scope of the EMC directive. Compliance with the EMC directive must be considered in the final installation. Please contact your local TDK-Lambda office

**Environmental:**

These products are IPX0, and therefore chemicals/solvents, cleaning agents and other liquids must not be used.

**Environment:**

This power supply is a switch mode power supply for use in applications within a Pollution Degree 2, overvoltage category II environment. Material Group IIIb PCB's are used within it.

**Output Loading:**

The output power taken from the power supply must not exceed the rating stated on the power supply label, except as stated in the product limitations in this instruction manual.

**Input Parameters:**

This product must be operated within the input parameters stated in the product limitations in this instruction manual.

**End of Life Disposal:**

The unit contains components that require special disposal. Make sure that the unit is properly disposed of at the end of its service life and in accordance with local regulations.



RISK OF ELECTRIC SHOCK

**High Voltage Warning:**

Dangerous voltages are present within the power supply. The professional installer must protect service personnel from inadvertent contact with these dangerous voltages in the end equipment.

This product must be reliably earthed and professionally installed in accordance with the prevailing local electrical wiring regulations and safety standards.

The (+) or (-) output(s) can be earthed or left floating.

The unit cover(s)/chassis must not be made user accessible.

The mains input connector is not acceptable for use as field wiring terminals.

For encased products, do not use mounting screws, which penetrate the unit more than 4.5mm.

An internal fuse protects the unit and must not be replaced by the user. In case of internal defect, the unit must be returned to TDK-Lambda UK LTD or one of their authorised agents.

**WARNING:** These products are Class 1 and must therefore be reliably earthed and professionally installed in accordance with the prevailing electrical wiring regulations and the safety standards covered herein.

On units with end fans and IEC 60320 connector, the fan and connector end is permitted to be user accessible.

A suitable mechanical, electrical and fire enclosure must be provided by the end use equipment for mechanical, electric shock and fire hazard protection.

The ventilation openings on these products must not be impeded. Ensure that there is at least 50mm spacing between any obstruction and the ventilation openings.

The unit cover/chassis is designed to protect skilled personnel from hazards. They must not be used as part of the external covers of any equipment where they may be accessible to operators, since under full load conditions, part or parts of the unit chassis may reach temperatures in excess of those considered safe for operator access.

**Energy Hazards:**

The power supply contains dangerous voltages and should only be handled by qualified personnel when the power supply has been disconnected from the mains supply voltage for more than 3 minutes

**Allgemeine Sicherheitsvorschriften:**

LESEN SIE DIE SICHERHEITSVORSCHRIFTEN

**Wartung:**

Diese Produkte können nicht durch den Kunden gewartet werden. Nur TDK-Lambda UK LTD. und deren zugelassene Vertriebshändler sind zur Durchführung von Reparaturen berechtigt.

**Kritische Komponenten:**

Diese Produkte sind nicht für die Verwendung als kritische Komponenten in nuklearen Kontrollsystemen, Lebenserhaltungssystemen oder Geräten in gefährlichen Umgebungen geeignet, sofern dies nicht ausdrücklich und in Schriftform durch den Geschäftsführer von TDK-Lambda EMEA genehmigt wurde.

**Produktverwendung:**

Diese Produkte sind zur Verwendung innerhalb von Host-Anlagen gedacht, die einen auf das Fachpersonal beschränkten Zugang haben.

Dieses Produkt ist eine Stromversorgungs-Komponente und sie darf nur von qualifiziertem Personal in andere Geräte eingebaut werden und sie darf NICHT als eigenständiges ("Stand-Alone") Gerät betrieben werden. Dieses Produkt ist für den Verkauf an Geschäftskunden entwickelt worden und es kann über Distributionskanäle bezogen werden.

Es ist NICHT für den Verkauf an Endkunden gedacht und konzipiert.

Dieses Produkt ist eine Stromversorgungsbaugruppe und sie fällt NICHT in den Bereich der EMV Direktive.

Die Konformität mit der EMV Richtlinie muss in der finalen Gesamtinstallation betrachtet werden.

Bitte kontaktieren Sie Ihr regionales TDK-Lambda Vertriebsbüro im Falle von Rückfragen.

**Umwelt:**

Diese Produkte sind IPX0, aus diesem Grund dürfen keine Chemikalien/Lösungsmittel, Reinigungsmittel und andere Flüssigkeiten verwendet werden.

**Umgebung:**

Dieses Netzteil ist ein Schaltnetzteil zur Verwendung in einer Umgebung mit einem Verschmutzungsgrad 2, Überspannungskategorie II. Materialgruppe IIIb mit darin verwendeten PCBs.

**Ausgangsstrom:**

Der Ausgangsstrom des Netzteiles darf die Leistung, die auf dem Label des Netzteiles vermerkt ist, nur dann überschreiten, wenn dies in den Produktgrenzen dieses Handbuches ausgezeichnet ist.

**Eingangsparameter:**

Dieses Produkt muss innerhalb der Eingangsparameter, die in den Produktgrenzen dieses Handbuches angegeben sind, betrieben werden.

**Entsorgung am Ende der Betriebszeit:**

Das Gerät enthält Komponenten die unter Sondermüll fallen. Das Gerät muss am Ende der Betriebszeit ordnungsgemäß und in Übereinstimmung mit den regionalen Bestimmungen entsorgt werden.



GEFAHR DURCH ELEKTRISCHEN SCHLAG

**Hochspannungswarnung:**

Innerhalb des Netzteiles gibt es gefährliche Spannungen. Der Elektroinstallateur muss das Wartungspersonal vor versehentlichem Kontakt mit den gefährlichen Spannungen im Endgerät schützen.

Dies Produkt muss sicher geerdet und von qualifiziertem Personal in Übereinstimmung mit den gültigen regionalen Bestimmungen zu Verdrahtungen sowie den Sicherheitsstandards installiert werden.

Die (+) oder (-) Ausgänge können geerdet werden oder unangeschlossen bleiben.

Die Abdeckung des Gerätes/das Gehäuse darf für den Benutzer nicht zugänglich sein.

Der Haupteingangsanschluss ist nicht für die Verwendung als Feldverdrahtungsanschluss geeignet.

Verwenden Sie keine Befestigungsschrauben, die mehr als 4.5mm in das Gerät eindringen.

Eine interne Sicherung schützt das Gerät und darf durch den Benutzer nicht ausgetauscht werden. Im Fall von internen Defekten muss das Gerät an TDK-Lambda UK LTD oder einen der autorisierten Vertriebshändler zurückgeschickt werden.

**WARNUNG:** Diese Produkte sind Produkte der Klasse 1 und müssen daher sicher geerdet und von qualifiziertem Personal in Übereinstimmung mit den gültigen regionalen Bestimmungen zu Verdrahtungen sowie den Sicherheitsstandards installiert werden.

An Geräten mit Endlüftern und IEC 60320 Anschluss, kann das Ende des Gerätes, in dem der Lüfter und der Anschluss untergebracht sind, für den Benutzer zugänglich sein.

Ein geeignetes mechanisches, elektrisches und brandgeschütztes Gehäuse muss als Schutz vor der Gefahr von mechanischen Risiken, Stromschlägen und Brandschutz in dem Endgerät vorgesehen werden.

Die Belüftungsöffnungen an diesem Produkt dürfen nicht blockiert werden. Achten Sie darauf, dass mindestens 50 mm Abstand zwischen Hindernissen und den Belüftungsöffnungen bleibt.

Die Geräteabdeckung/das Gehäuse ist so entworfen, dass das Fachpersonal vor Gefahren geschützt wird. Sie dürfen nicht als Teil der externen Abdeckung für Geräte verwendet werden, die für den Betreiber zugänglich sein müssen, da Teile oder das gesamte Gerätegehäuse unter voller Auslastung übermäßige Temperaturen erreichen kann, die für den Zugang des Betreibers nicht mehr als sicher betrachtet werden.

Gefahren durch elektrische Energie:

Das Netzteil steht unter hoher Spannung und sollte deshalb mindestens 3 Minuten vom Netz getrennt sein. Die Bedienung darf nur durch Fachpersonal erfolgen

**Consignes générales de sécurité:**

LIRE LES CONSIGNES DE SECURITE

**Entretien:**

Ces produits ne peuvent pas être réparés par l'utilisateur. Seuls, TDK-Lambda UK LTD et ses agents agréés sont autorisés à effectuer des réparations.

**Composants critiques:**

Ces produits ne doivent pas être utilisés en tant que composants critiques dans des systèmes de commande nucléaire, dans des systèmes de sauvetage ou dans des équipements utilisés dans des environnements dangereux, sans l'autorisation écrite expresse du directeur général de TDK-Lambda EMEA.

**Utilisation du produit:**

Ces produits sont conçus pour être utilisés dans un équipement hôte dont l'accès n'est autorisé qu'aux personnes compétentes.

Ce produit est une alimentation considérée comme un composant devant être installé par des personnes qualifiées, dans un autre équipement. Il ne doit pas être utilisé en tant que produit fini.

Ce produit est destiné à la vente entre entreprises et peut être obtenu via des canaux de distribution.

Il n'est pas prévu à la vente pour les particuliers.

Ce produit est une alimentation considérée comme un composant, il ne relève pas du champ d'application de la directive CEM. Le respect de la directive CEM doit être pris en compte dans l'installation finale. Veuillez contacter votre bureau TDK-Lambda le plus proche.

**Environnement:**

Ces produits sont IPX0, et donc on ne doit pas utiliser des produits chimiques/solvants, des produits de nettoyage et d'autres liquides.

**Environnement fonctionnel :**

Cette alimentation fonctionne en mode commutation pour utilisation dans des applications fonctionnant dans un environnement avec Degré de Pollution 2 et catégorie de surtension II. Elle utilise des cartes des circuits imprimés (PCB) de Groupe IIIb.

**Intensité soutirée:**

L'intensité soutirée de l'alimentation ne doit pas dépasser l'intensité nominale marquée sur la plaque signalétique, sauf indications contraires dans les limitations du produit décrit dans ce manuel.

**Paramètres d'entrée:**

Ce produit doit être utilisé à l'intérieur des paramètres d'entrée indiqués dans les limitations du produit dans ce manuel.

**Elimination en fin de vie:**

L'alimentation contient des composants nécessitant des dispositions spéciales pour leur élimination. Vérifiez que cette alimentation est mise au rebut correctement en fin de vie utile et conformément aux réglementations locales en vigueur.



RISQUE DE CHOC ELECTRIQUE

**Attention-Danger haute tension:**

Des tensions dangereuses sont présentes dans l'alimentation. L'installateur doit protéger le personnel d'entretien contre un contact involontaire avec ces tensions dangereuses dans l'équipement final.

Ce produit doit être raccordé à une terre fiable et installé par des professionnels en respectant les réglementations locales de câblages électriques en vigueur et les normes de sécurité.

Les sorties (+) ou (-) peuvent être raccordées à la terre ou laissées flottantes.

Le couvercle/châssis de l'alimentation ne doit pas être accessible à l'utilisateur.

Le connecteur d'entrée d'alimentation principale ne doit pas être utilisé comme borne de raccordement.

N'utilisez pas de vis pénétrant dans le module sur une profondeur supérieure à 4.5 mm.

Un fusible interne protège le module et ne doit pas être remplacé par l'utilisateur. En cas de défaut interne, le module doit être renvoyé à TDK-Lambda UK LTD ou l'un de ses agents agréés.

**AVERTISSEMENT:** Ces produits sont des produits Classe 1 et donc doivent être raccordés à une terre fiable et installés par un professionnel en respectant les réglementations de câblage électrique en vigueur et les normes de sécurité indiquées ici.

Sur les modules avec ventilateurs d'extrémité et connecteur IEC 60320, le ventilateur et le connecteur sont accessibles pour l'utilisateur.

Une enceinte appropriée doit être prévue par l'utilisateur final pour assurer la protection contre les chocs mécaniques, les chocs électriques et l'incendie.

Les orifices de ventilation sur ces produits ne doivent pas être obstrués. Vérifiez qu'il y a un espace libre d'au moins 50 mm entre une obstruction et les orifices de ventilation.

Le couvercle et le châssis du module sont conçus pour protéger des personnels expérimentés. Ils ne doivent pas être utilisés comme couvercles extérieurs d'un équipement, accessible aux opérateurs car en condition de puissance maximum, des parties du châssis peuvent atteindre des températures considérées comme dangereuses pour l'opérateur.

**Energies dangereuses:**

L'alimentation délivre des tensions dangereuses et doit seulement être manipulée par du personnel qualifié quand celle-ci a été déconnectée du secteur pendant plus de 3 minutes.

**Norme generali di sicurezza:**

SI PREGA DI LEGGERE LE NORME DI SICUREZZA

**Manutenzione:**

Il cliente non può eseguire alcuna manutenzione su questi prodotti. L'esecuzione delle eventuali riparazioni è consentita solo a TDK-Lambda UK LTD e ai suoi agenti autorizzati.

**Componenti critici:**

Non si autorizza l'uso di questi prodotti come componenti critici all'interno di sistemi di controllo nucleari, sistemi necessari alla sopravvivenza o apparecchiature destinate all'impiego in ambienti pericolosi, senza l'esplicita approvazione scritta dell'Amministratore Delegato di TDK-Lambda EMEA.

**Uso dei prodotti:**

Questi prodotti sono progettati per l'uso all'interno di un'apparecchiatura ospite che limiti l'accesso al solo personale competente e autorizzato.

Questo prodotto è da considerarsi come un alimentatore professionale componente e come tale deve essere installato da personale qualificato all'interno di altre apparecchiature e non può essere utilizzato come prodotto indipendente.

Questo prodotto non è inteso per la vendita al dettaglio o agli utilizzatori finali.

Questo alimentatore è da considerarsi come un componente e come tale non è assoggettato dagli scopi della direttiva EMC. Conformità alla direttiva EMC deve essere considerata nell'installazione finale di utilizzo. Gli uffici di TDK-Lambda Sas Succursale Italiana sono a vostra disposizione per ulteriori raggugli.

**Condizioni ambientali:**

Questi prodotti sono classificati come IPX0, dunque non devono essere utilizzati sostanze chimiche/solventi, prodotti per la pulizia o liquidi di altra natura.

**Ambiente:**

Questo prodotto è un alimentatore a commutazione, destinato all'uso in applicazioni rientranti in ambienti con le seguenti caratteristiche: Livello inquinamento 2, Categoria sovratensione II. Questo prodotto contiene schede di circuiti stampati in materiali di Gruppo IIIb.

**Carico in uscita:**

La potenza in uscita ottenuta dall'alimentatore non deve superare la potenza nominale indicata sulla targhetta dell'alimentatore, fatto salvo dove indicato nei limiti per il prodotto specificati in questo manuale.

**Parametri di alimentazione:**

Questo prodotto deve essere utilizzato entro i parametri di alimentazione indicati nei limiti per il prodotto, specificati in questo manuale.

**Smaltimento:**

L'unità contiene componenti che richiedono procedure speciali di smaltimento. Accertarsi che l'unità venga smaltita in modo corretto al termine della vita utile e nel rispetto delle normative locali.



RISCHIO DI SCOSSA ELETTRICA

**Avvertimento di alta tensione:**

All'interno dell'alimentatore sono presenti tensioni pericolose. Gli installatori professionali devono proteggere il personale di manutenzione dal rischio di contatto accidentale con queste tensioni pericolose all'interno dell'apparecchiatura finale.

Questo prodotto deve essere messo a terra in modo affidabile e installato in modo professionale, nel rispetto delle norme di sicurezza e dei regolamenti vigenti in ambito locale in materia di collegamenti elettrici.

Le uscite (+) o (-) possono essere messa a terra o lasciate isolate.

I coperchi/il telaio dell'unità non devono essere accessibili da parte dell'utente.

Il connettore dell'alimentazione principale non può essere utilizzato come terminale di collegamento di campo.

Non utilizzare viti che penetrano nell'unità per più di 4.5 mm.

Un fusibile interno protegge l'unità e non deve essere sostituito dall'utente. Nell'eventualità di un difetto interno, restituire l'unità a TDK-Lambda UK LTD o a uno dei suoi agenti autorizzati.

**AVVERTIMENTO:** Questi prodotti sono di Classe 1 e come tali devono essere messi a terra in modo affidabile e installati in modo professionale, nel rispetto dei regolamenti vigenti in ambito locale in materia di collegamenti elettrici e nelle norme di sicurezza in essi contemplati.

Sulle unità provviste di ventole terminali e di connettori a norma IEC 60320, è possibile consentire all'utente accesso al lato della ventola e del connettore dell'unità.

L'apparecchiatura finale deve includere una recinzione meccanica, elettrica e antincendio per proteggere dai pericoli di natura meccanica, dalle scosse elettriche e dai pericoli di incendio.

Le griglie di ventilazione su questi prodotti non devono essere ostruite. Verificare che vi sia una distanza minima di 50 mm fra le griglie di ventilazione e qualsiasi eventuale ostruzione.

Il coperchio/telaio dell'unità è realizzato per proteggere il personale esperto dai pericoli. Non deve essere usato come parte degli involucri esterni di qualsiasi apparecchiatura, se risulta accessibile da parte degli addetti, poiché è possibile che in condizioni di pieno carico una o più parti del telaio dell'unità giunga/giungano a temperature superiori ai limiti considerati sicuri per l'accesso da parte degli addetti.

**Pericoli energetici:**

L'alimentatore contiene tensioni pericolose e deve essere gestito da personale qualificato previo scollegamento dalla tensione di rete da più di 3 minuti



**Instrucciones generales de seguridad:**

LEA LAS INSTRUCCIONES DE SEGURIDAD

**Servicio:**

Estos productos no pueden ser reparados por los clientes. TDK-Lambda UK LTD. y sus agentes autorizados son los únicos que pueden llevar a cabo las reparaciones.

**Componentes fundamentales:**

Estos productos no pueden ser utilizados como componentes fundamentales en sistemas de control nuclear, sistemas de soporte vital o equipos a utilizar en entornos peligrosos sin el consentimiento expreso por escrito del Director General de TDK-Lambda EMEA.

**Uso de los productos:**

Estos productos han sido diseñados para ser utilizados en un equipo central que restrinja el acceso al personal cualificado autorizado.

Este producto es una fuente de alimentación y sólo puede ser instalado por personal cualificado dentro de otros equipos y no debe ser tratado como un producto independiente. Este producto debe ser vendido entre empresas profesionales y solo puede obtenerse a través de los canales de distribución. No está destinado para la venta a usuarios finales.

Este producto es una fuente de alimentación y no se ve afectada por la directiva EMC. El cumplimiento de la directiva EMC se debe considerar en la instalación final. Por favor, póngase en contacto con su oficina local de TDK – Lambda.

**Medioambiental:**

Estos productos son IPX0 y, por tanto, no pueden utilizarse sustancias químicas/disolventes, agentes de limpieza ni otros líquidos.

**Medio ambiente:**

Esta fuente de alimentación es una fuente de alimentación de modo conmutado a utilizar en aplicaciones dentro de un entorno con un Grado de contaminación 2 y una Categoría de sobretensión II. En él se utilizan policloruros de bifenilo del Grupo de materiales IIIb.

**Carga de salida:**

La potencia de salida tomada de la fuente de alimentación no puede sobrepasar el valor nominal indicado en la etiqueta de la fuente de alimentación, excepto en los casos indicados en las limitaciones del producto en este manual.

**Parámetros de entrada:**

Este producto debe ser utilizado dentro de los parámetros de entrada indicados en las limitaciones del producto en este manual.

**Desecho de la unidad:**

La unidad contiene componentes que deben ser desechados de una manera especial. Asegúrese de desechar correctamente la unidad al final de su vida útil y conforme a las normas locales vigentes.



PELIGRO DE DESCARGAS ELÉCTRICAS

**Advertencia de alta tensión:**

En esta fuente de alimentación hay tensiones peligrosas. El instalador profesional debe proteger al personal de servicio contra cualquier contacto accidental con estas tensiones peligrosas en el equipo final.

Este producto se puede conectar de forma fiable a tierra e instalar profesionalmente de conformidad con las regulaciones locales para los cableados eléctricos y las normas de seguridad vigentes.

La salida o salidas (+) o (-) pueden conectarse a tierra o se las puede dejar flotando.

Debe impedirse el acceso de los usuarios a la cubierta o cubiertas y al chasis de la unidad.

El conector de entrada de la red no es apto para ser utilizado a modo de bornes de cableado de campo.

No utilice tornillos de montaje susceptibles de penetrar en la unidad más de 4.5 mm.

Un fusible interno protege la unidad y este no debe ser nunca reemplazado por el usuario. En caso de existir algún defecto interno, la unidad debe ser enviada a TDK-Lambda UK LTD o a uno de sus agentes autorizados.

**AVISO:** Estos productos son de Clase 1 y, por tanto, se deben conectar de forma fiable a tierra y sólo pueden ser instalados por profesionales de acuerdo con las regulaciones sobre cableados eléctricos y las normas de seguridad vigentes cubiertas en este documento.

En las unidades con ventiladores y un conector IEC 60320 finales, se debe permitir el acceso al usuario al extremo de la unidad donde se encuentra el ventilador y el conector.

El equipo de uso final debe constituir un recinto de protección mecánica, eléctrica y contra incendios de protección mecánica, contra descargas eléctricas y contra el peligro de incendios.

Las aberturas de ventilación de estos productos no deben obstruirse jamás. Asegúrese de que quede una separación de 50 mm por lo menos entre cualquier obstrucción y las aberturas de ventilación.

La cubierta/chasis de la unidad ha sido diseñada para que proteja a las personas cualificadas de los peligros. No deben ser utilizadas como parte de las cubiertas externas de cualquier equipo al que pueden acceder los operarios, ya que bajo unas condiciones de carga completa, la pieza o piezas del chasis de la unidad pueden alcanzar temperaturas superiores a las consideradas seguras para el acceso de los operarios.

**Peligros de energía:**

El suministro eléctrico contiene tensiones peligrosas y, en caso de que se haya desconectado de la alimentación principal durante más de 3 minutos, deberá ser manipulado únicamente por personal cualificado.

**Instruções gerais de segurança:**

LEIA AS INSTRUÇÕES DE SEGURANÇA

**Manutenção:**

Estes produtos não são podem ser submetidos a manutenção por parte do cliente. Apenas a TDK-Lambda UK LTD e os seus agentes autorizados têm permissão para realizar reparações.

**Componentes essenciais:**

Não é autorizada a utilização destes produtos como componentes essenciais de sistemas de controlo nuclear, sistemas de suporte de vida ou equipamento para utilização em ambientes perigosos sem a expressa autorização por escrito do Director-Geral da TDK-Lambda EMEA.

**Utilização do produto:**

Estes produtos foram concebidos para utilização dentro de um equipamento de alojamento que apenas permita o acesso a pessoal qualificado autorizado.

Este produto é uma alimentação considerado com um componente para ser instalado por pessoas qualificadas, em outros equipamentos. Não deve ser usado como um produto acabado.

Este produto é destinado para venda entre as empresas e pode ser obtido através de canais de distribuição.

Não se destina à venda aos particulares

Este produto é uma alimentação considerado com um componente, não é dentro do application âmbito da directiva CEM.

Conformidade com a directiva CEM devem ser considerados na instalação final.

Entre em contacto com seu escritório TDK-Lambda mais próximo.

**Ambiental:**

Estes produtos são IPX0 e, como tal, não se devem utilizar químicos/solventes, agentes de limpeza e outros líquidos.

**Ambiente:**

Esta fonte de alimentação é uma fonte de alimentação do modo de comutação para utilização em aplicações com um Nível de Poluição 2 e ambientes da categoria de sobretensão II. São utilizadas placas de circuitos impressos do grupo de materiais IIIb.

**Carga de saída:**

A potência de saída extraída da fonte de alimentação não deve exceder a classificação assinalada na etiqueta da fonte de alimentação, excepto quando indicado nas limitações do produto neste guia.

**Parâmetros de entrada:**

Este produto deve ser utilizado dentro dos parâmetros de entrada indicados nas limitações do produto neste guia.

**Eliminação no fim de vida:**

A unidade contém componentes que necessitam de procedimentos especiais de eliminação. Certifique-se de que a unidade é devidamente eliminada no fim da sua vida útil e que tal é feito em conformidade com os regulamentos locais.



RISCO DE CHOQUE ELÉCTRICO

**Aviso de alta tensão:**

Estão presentes tensões perigosas dentro da fonte de alimentação. O profissional que realizar a instalação deve proteger o pessoal de assistência contra contactos inadvertidos com estas tensões perigosas do equipamento final.

Este produto deve ser ligado à terra de forma fiável e instalado por um profissional, de acordo com as normas de segurança e os regulamentos locais vigentes em relação a cablagens eléctricas.

As saídas (+) e (-) podem ser ligadas à terra ou deixadas soltas.

O chassis/cobertura(s) da unidade não deve estar acessível ao utilizador.

O conector de entrada de alimentação não deve ser utilizado como terminal de cablagens no local.

Não utilize parafusos de montagem, uma vez que estes penetrarão na unidade em mais do que 4.5 mm.

Existe um fusível interno que protege a unidade e que não deve ser substituído pelo utilizador. Em caso de defeito interno, a unidade deve ser devolvida à TDK-Lambda UK LTD ou a um dos seus agentes autorizados.

**AVISO:** Estes produtos pertencem à Classe 1, devendo assim ser ligados à terra de forma fiável e instalado por profissionais, de acordo com os regulamentos locais vigentes em relação a cablagens eléctricas e as normas de segurança aqui mencionadas.

Em unidades com ventiladores finais e conectores IEC 60320, o lado do ventilador e do conector da unidade pode estar acessível ao utilizador.

O equipamento de utilização final deve fornecer um bastidor com protecção mecânica, eléctrica e contra incêndios adequada.

As aberturas de ventilação destes produtos não devem ser obstruídas. Certifique-se de que existe um espaçamento de pelo menos 50 mm entre qualquer obstrução e as aberturas de ventilação.

O chassis/cobertura da unidade está concebido de forma a proteger o pessoal especializado de perigos. Não devem ser utilizados como parte das coberturas externas de qualquer equipamento em que possam estar acessíveis aos operadores, uma vez que em condições de carga máxima, algumas peças do chassis da unidade podem atingir temperaturas superiores às consideradas seguras para o acesso do operador.

**Perigos de energia:**

A fonte de alimentação contém tensões perigosas e apenas deve ser manuseada por pessoal qualificado quando a fonte de alimentação tiver sido desligada da tensão de alimentação eléctrica há mais de 3 minutos.

Special Instructions for medical applications of the following standards:

**IEC/EN 60601-1 2<sup>nd</sup> Edition**

**UL 60601-1 1st Edition**

**CAN/CSA-C22.2 No. 601.1-M90**

**IEC/EN 60601-1 3<sup>rd</sup> Edition**

**ANSI/AAMI ES 60601-1**

**CSA 22.2 No 60601-1**

These products are designed for continuous operation within an overall enclosure, and must be mounted such that access to the mains terminals is restricted.

These products are NOT suitable for use in the presence of flammable anaesthetic mixtures with air or with oxygen, or with nitrous oxide.

For IEC/EN 60601-1 2<sup>nd</sup> Edition, UL 60601-1 1st Edition, CAN/CSA-C22.2 No. 601.1-M90, these products have a reinforced insulation barrier between input and output for –M and –MR options and a basic insulation barrier for all other models.

For IEC/EN 60601-1 3<sup>rd</sup> Edition, ANSI/AAMI ES 60601-1, CSA 22.2 No 60601-1, these products provide reinforced insulation between input and outputs of 2 MOPPs for –M and –MR options and 2 MOOPs for all other products. Between outputs and earth there is functional insulation.

They are NOT protected against the ingress of water.

Connect only apparatus complying with the standards listed above as appropriate to the signal ports.

All outputs have operational spacings to earth, and due consideration must be given to this in the end product design.

These products have SELV outputs.

Reference should be made to local regulations concerning the disposal of these products at the end of their useful life.

Where any part of this product is made accessible to the operator in the end use equipment, the operator must not touch this part and the patient at the same time.

These products have not been assessed to IEC/EN60601-1-2 (EMC) but EMC test data is available from TDK-Lambda UK Ltd.

### Output Limitations

These products have SELV outputs according to 60950-1

All outputs are ES1 according to 62368-1

### Special Instructions for IEC/EN/UL/CSA 61010-1

If the earth terminal of the NV175 PSU is connected to the main incoming earth conductor of the end equipment, the installer must cover the NV175 earth symbol with a label bearing the earth symbol of IEC60417-5019.

**WARNING: No modification of this product is allowed.**

### Important Safety Instructions

#### Protective Earth

The filtering capacitors are connected to Protective Earth through Y1 to Y4 for standard models and additionally Y5 and Y6 for global options models. Open frame models will need additional assessment in the end product if Y1 to Y6 are not connected to Protective Earth in the end use equipment.

CAUTION DO NOT HANDLE OPEN FRAME MODELS BY THE CONTROL BOARD.

**Environmental Specifications:**

Description	Operation	Storage
Use	Indoor	-
Temperature	0 to 65°C(derating 2.5% above 50°C)	-40°C to +70°C
Humidity	5 to 95% RH, non-condensing	
Altitude	-200m to 3000m, 4000m* (5000m for –H and –HR)	-200m to 5000m
Pressure	70kPa to 106kPa	54kPa to 106kPa
Orientation	Customer air models: All, except Horizontal with PWB uppermost	Fan models: Horizontal cover uppermost, PSU on its side, Vertical with input lowest
Material Group		IIIb
Pollution Degree		2
Overvoltage Category		II
Class		I
Weight		600g
IP Rating		IPX0

Note: fan models require a 50mm gap at the input and output ends.

\* Model NV1-1G000-M

**Level of Insulation:**

Dielectric Strength testing is carried out as follows:

Primary mains circuit to earth - 2.25 - 2.35Kvdc.

\*Primary mains circuits to secondary:4.25-4.35kVDC.

Outputs to earth are isolated to 200VDC.

\*Important Note: This test is not possible with Y capacitors fitted to the unit as damage to these capacitors will occur. It is also necessary to short circuit the outputs together and to earth

**Safety Approvals:**

IEC/EN/UL60950-1 and CSA22.2 No.60950-1 - UL Recognised. C-UL for Canada.

IEC/EN/UL62368-1 and CSA22.2 No.62368-1 - UL Recognised. C-UL for Canada.

IEC/EN/UL/CSA 60601-1/ANSI/AAMI ES 60601-1 - UL + C -UL approval

IEC/EN/UL 61010-1, CAN/CSA 22.2 No. 61010-1-12

IEC/EN62368-1 – CE and UKCA mark.

CE marking when applied to any NV175 product, indicates compliance with the Low Voltage Directive in that it complies with EN62368-1 and with the RoHS Directive.

UKCA marking when applied to any NV175 product indicates compliance with the Electrical Equipment (Safety) Regulations 2016 in that it complies with EN62368-1 and with the Restriction of the Use of Certain Hazardous Substances in Electrical and Electronic Equipment Regulations 2012.

**Fusing:** Internal fuse (F1): T3.15AH, 250V, 5x20mm.

**Symbols:**



AC

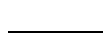

DC



EARTH

N – Neutral

L – Live



**Danger, shock hazard**



**Caution: See instructions for use**

**Note: All output voltages/variants may not be available as standard units, refer to datasheet for standard product range. These (and other variants) may be available as non-standard or custom units, please contact our sales team for details.**

**PRODUCTS COVERED**

**Unit Configuration Code:**

NVx-abcde-f-g-h-ijk

- where: x = 1 for 175
- a = Number of Outputs : 1, 2, 3 or 4
- b = Channel 1 Output Voltage†: 5, T, F, E or G
- c = Channel 2 Output Voltage†: 1, 2, 3, 5, 5L, 7 or 0
- d = Channel 3 Output Voltage†: 3L, 5L, 7, TL, FL, T, F, G followed by Y for negative output or 0
- e = Channel 4 Output Voltage†: 3H, 5H, 7, T, F, TH, FH, 0H (fan only channel 4 output) followed by V for variable output followed by P for positive output or 0
- f = Global Option : N for 5V version, N1 for 12V version, N2 for 13.5V version, N3 for 5V version with ATX compatibility, N4 for 12V version with ATX compatibility, N5 for 13.5V version with ATX, N6 for 12-13.5V version, N7 for 12-13.5V version with ATX or nothing for no Global Option present
- g = U for U chassis, C for U chassis and cover, F for U chassis and cover with fan, I for U chassis and cover with fan and IEC inlet or nothing for Open Frame
- h = Blank is the standard upright output connector, R is for the right angle output connector, H is for high altitude, HR is for high altitude with right angle output connector, M is for IEC60601-1 2<sup>nd</sup> edition reinforced insulation spacings, MR is for IEC60601-1 2<sup>nd</sup> edition reinforced insulation spacings with right angle connector.
- ijk = Three numbers from 0 to 9 which denotes various output voltages and currents within the specified ranges of each output for a particular unit or blank for standard output settings

† Table1: Output Voltage Cross Reference	
Designation	Output Voltage
0	Omit output
A	1.5
1	1.8
B	2
2	2.7
3	3.3
5	5
7	7
T	12
F	15
E	18
G	24

All ratings apply for ambient temperatures up to 50°C. From 50 to 65°C the total output power and the module current ratings are both derated at 2.5% per deg C.

Potentiometers should be adjusted using Bourns tool H91.

**Input Parameters**

NOMINAL INPUT VOLTAGE RANGE	100 - 240V AC	133 – 318V DC*
MAX. INPUT VOLTAGE RANGE	90 - 264V AC	120 –350V DC*
INPUT FREQUENCY	45 - 440Hz*	DC*
MAXIMUM INPUT CURRENT	3A AC	2.2A DC*
INRUSH CURRENT	<40A	<40A

\* For IEC/EN60601-1 and IEC/EN61010-1 standards, 100 – 240Vac Nom. and 45 – 63Hz only DC input for specific non-standard models only.

Output channels and Global Options ratings are in accordance with the following table:

Output Channel	Voltage designation	Vout (V)	Adjustment Range (V)	Output Current (A)
CH1	5	5	5 - 5.5	25
	T	12	12 - 15.5	15
	F	15	12 - 15.5	15
	E	18	16 - 20	10
	G	24	24 - 28.5	7.5
CH2	1	1.8	0.9 - 3.8	15
	2	2.7	2.5 - 3.8	15
	3	3.3	2.5 - 3.8	15
CH2 (CH1 12V)	5	5	3.3 - 5.5	10
CH2 (CH1 15V)	5	5	3.3 - 5.5	10
CH2 (CH1 24V)	5L	5	Fixed	2
	5	5	3.3 - 5.5	8
	7	7	5.5 - 8	5.5
CH3	7	+/-7	7 - 8	5
	T	+/-12	12 - 15	5
	F	+/-15	12 - 15	5
	G	+/-24	18 - 24.5	2.5
	3L	+/-3.3	Fixed	2
	5L	+/-5	Fixed	2
	TL	+/-12	Fixed	2
	FL	+/-15	Fixed	2
CH4	3H	+/-3.3	Fixed	2
	5H	+/-5	Fixed	2
	7	+/-7	7 - 8	1
	T	+/-12	Fixed	1
	F	+/-15	Fixed	1
	TH	+/-12	Fixed	2
	FH	+/-15	Fixed	2
	THV	+/-12	12 - 15	2
	FHV	+/-15	12 - 15	2
CH4 (fan output)	OH	-	-	-
Global Option	N	5	Fixed	2
	N1	12	Fixed	1
	N2	13.5	Fixed	1
	N3	5 (ATX version)	Fixed	2
	N4	12 (ATX version)	Fixed	1
	N5	13.5 (ATX version)	Fixed	1
	N6	12	12 – 13.5*	1
N7	12 (ATX version)	12 – 13.5*	1	

Channels 1 and 2 combined output currents must not exceed 25A

\*Can only be set at the factory.

#### Variations and limitations of use:

- All NV175 PSUs can output 180W except 5V channel 1 models which can output 175W.
- Units with channel 1 T and G outputs (no other channels fitted) have a peak power output of 200W including the global option with the following duty cycles:

In any 5 minutes 30% at 200W followed by 70% at 171W (average 180W)

In any 5 minutes 20% at 200W followed by 80% at 175W (average 180W)

- Options –M and –MR meet IEC60601-1 Edition 2 Reinforced spacings with the following limitations:



Channel 1 cannot be 5V model (T1 and T2 with foils)  
 Channel 2 cannot be fitted  
 Cannot be global option variants

4. There is no -F, -M, -MR or -I options for the NV175 -H or -HR high altitude models

5. Fan versions:

Channel 1 with G output, 25V maximum with 5V channel 2 maximum output current of 7A.  
 Channel 1 with G output, 25V maximum with 7V channel 2 maximum output current of 5.5A.  
 Channel 1 with G output, 5L channel 2 maximum output current 1.8A.  
 Channel 2 with T and F outputs, channel 2 maximum output current of 9A.  
 Channel 4 maximum output current of 1.5A

6. Model NV1-1G000 (with or without global option or -M/-MR option) may also be run with Channel 1 output voltage range 22.5V to 28V with maximum current of 7.5A and maximum power of 180W

7. Model NV1-1G000 (with or without -M option) may also be run at 88.9Vac to 240Vac nominal input (tested for continuous running at 80Vac input), output: 24V to 28V at 6.25A maximum current and 150W maximum power.

8. Model NV1-1G000-M operation to 4000m (60601-1 3<sup>rd</sup> ed only).

The products listed in the following table are typical examples:

Model	CH1	CH2	CH3	CH4	Global Option
NV1-453FF	5V/25A	3.3V/15A	15V/5A	-15V/1A	-
NV1-4G5FFH-N3	24V/7.5A	5V/8A	15V/5A	-15V/2A	5V/2A
NV1-350TT-N	5V/25A	-	12V/5A	-12V/1A	5V/2A
NV1-453TT-N1	5V/25A	3.3V/15A	12V/5A	-12V/1A	12V/1A
NV1-250T0-N2	5V/25A	-	12V/5A	-	13.5V/1A

**Custom Models:**

All ratings as per standard models unless otherwise stated.

Model: NS-LAM/NV1-453TTH-N2-C (K10035)  
 Rated to 4600m altitude (operating air pressure: 54kPa to 106kPa)  
 Input voltage range from 90Vac to 264Vac

Model: NS-LAMF/NV1-4G5TTH-F (K10066)  
 5L low current channel 2 fitted.  
 Channel 2 rated: 5V, 1.4A

## Capacitive Loads

Outputs on NV175 are designed for use with capacitive loads up to the value shown in the table below. Applications where a discharged capacitor is switched onto the power supply output create additional loading for which a non standard product may be required. Consult factory for details.

Capacitive loading table

Output voltage CH1	CH1 ( $\leq 6V$ )	CH2 ( $> 6V$ )	CH3	CH4 <sup>2</sup>
Max Capacitive load ( $\mu F/Amp$ ) <sup>1</sup>	1000 $\mu F/A$	1000 $\mu F/A$	100 $\mu F/A$	1000 $\mu F/A$

Notes:

1. To calculate the allowed capacitance multiply the figure in the table above by the maximum allowed current rating of the output
2. Applies to fixed output voltage CH4.

## Customer Air Cooling (open frame, options C and U):

The following method must be used for determining the safe operation of PSUs.

The components listed in the following table must not exceed the temperatures given. To determine the component temperatures the heating tests must be conducted in accordance with the requirements of the standard in question. Consideration should also be given to the requirements of other safety standards. Test requirements include: PSU to be fitted in its end-use equipment and operated under the most adverse conditions permitted in the end-use equipment instruction manual/specification and which will result in the highest temperatures in the PSU. To determine the most adverse conditions consideration should be given to the end use equipment maximum operating ambient, the PSU loading and input voltage, ventilation, end use equipment orientation, the position of doors & covers, etc. Temperatures should be monitored using type K fine wire thermocouples (secured with cyanoacrylate adhesive, or similar) placed on the hottest part of the component (out of any direct airflow) and the equipment should be run until all temperatures have stabilised.

Circuit Ref.	Description	Max. Temperature (°C)
L3, L7	Common mode choke winding	130 † (140)
C1, C4	X capacitors	100
C6, C12	Capacitor	105
L2	Boost choke winding	130
C7	Electrolytic capacitor	70 † (105)
T1, T2	Transformer winding	130
XU3	Control board optocoupler	100
TX701	Global option transformer	90
L5	Ch 1 Output choke	125
XL401	Ch 2 Output choke (SMA 1 )	125
XV406	Ch 2 highside FET (SMA 1 )	115
XL601	5L Ch 2 output choke (SMA 1 )	125
XU601	5L Ch 2 IC (SMA 1 )	115
XL501	Ch 3 (SMA 2) and CH 4†† (SMA 3) output choke	125
XV504	Ch 3 (SMA 2) and CH 4†† (SMA 3) highside FET	115
XL601	Ch 3* (SMA 2) and CH 4 (SMA 3) output choke	125
XU601	Ch 3* (SMA 2) and CH 4 (SMA 3) IC	115
IC1**	Ch 4 Voltage regulator	110
Various	All other electrolytic capacitors	90 † (105)

\* Ch 3 xL where x = 3, 5, T or F.

\*\* 1A channel 4 only.

† The higher temperatures limits in brackets may be used but product life may be reduced.

†† Ch 4 THV and FHV

See diagrams below for components to be monitored:

## Input Connections:

Molex 3 pin header 7A/250V MAX.  
IEC 60320 inlet.

**COMPONENTS TO BE MONITORED**

Base board (NV175 -Nx versions)

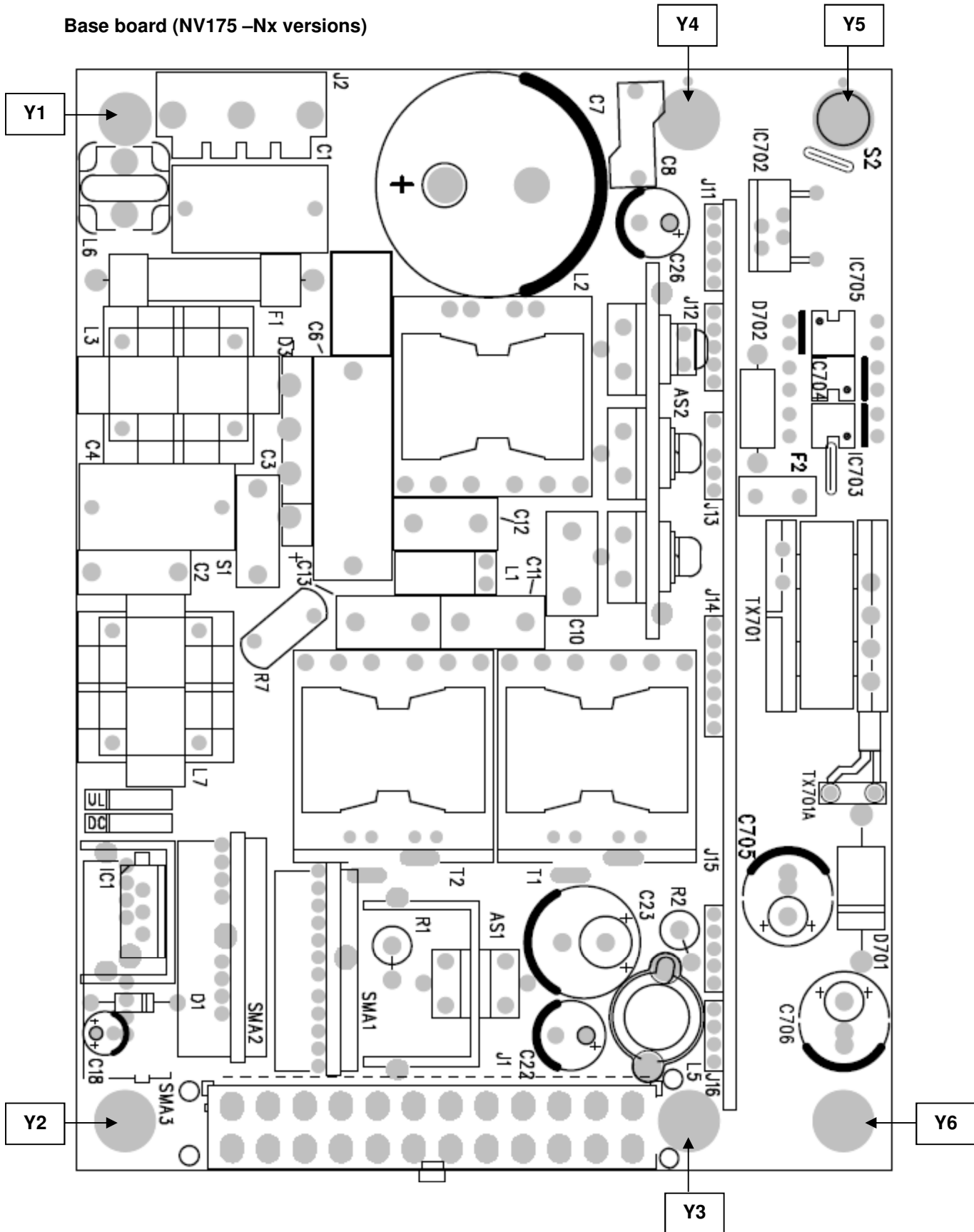

Base board (NV175 Narrow and -M & -MR versions)

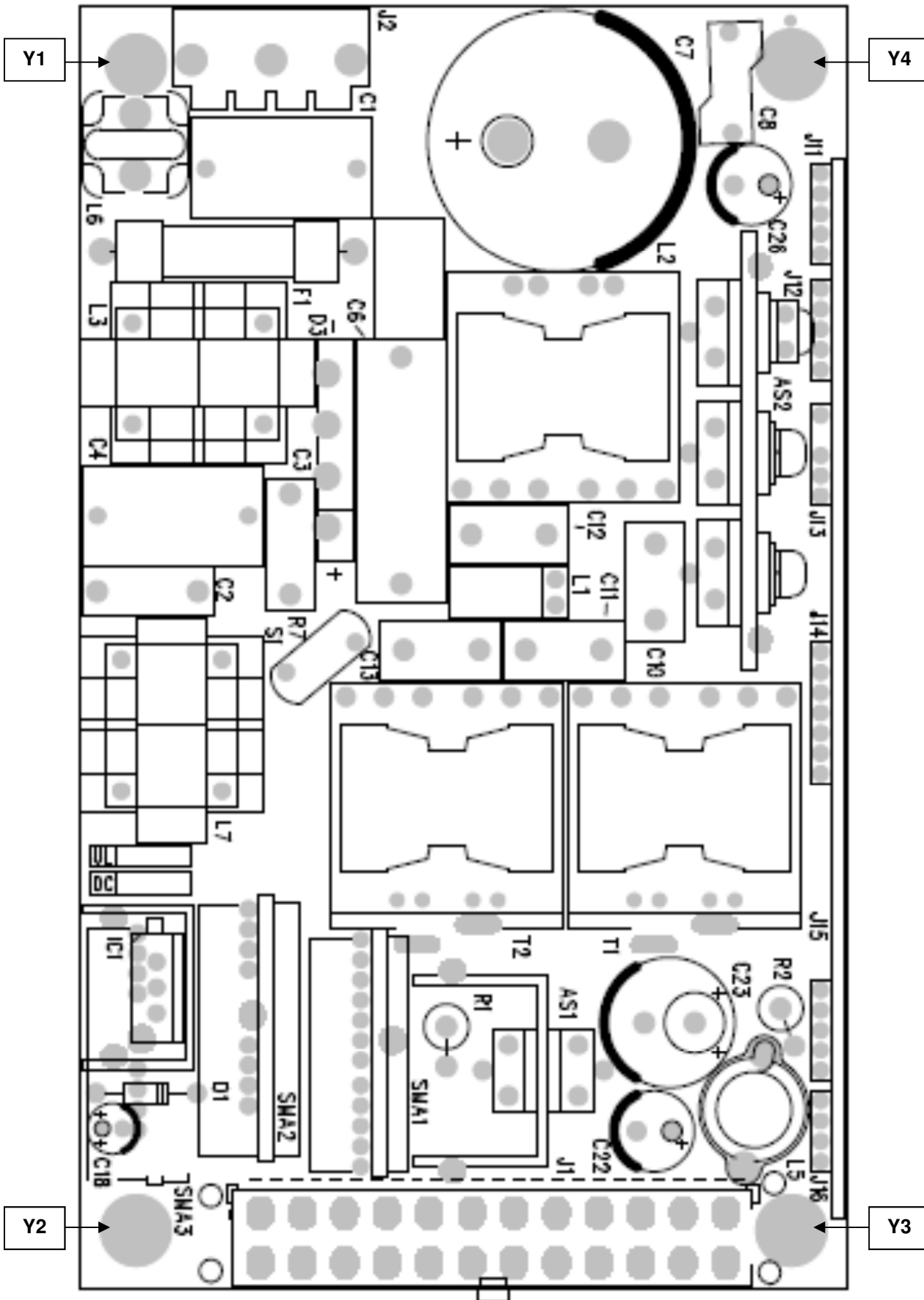

Control board

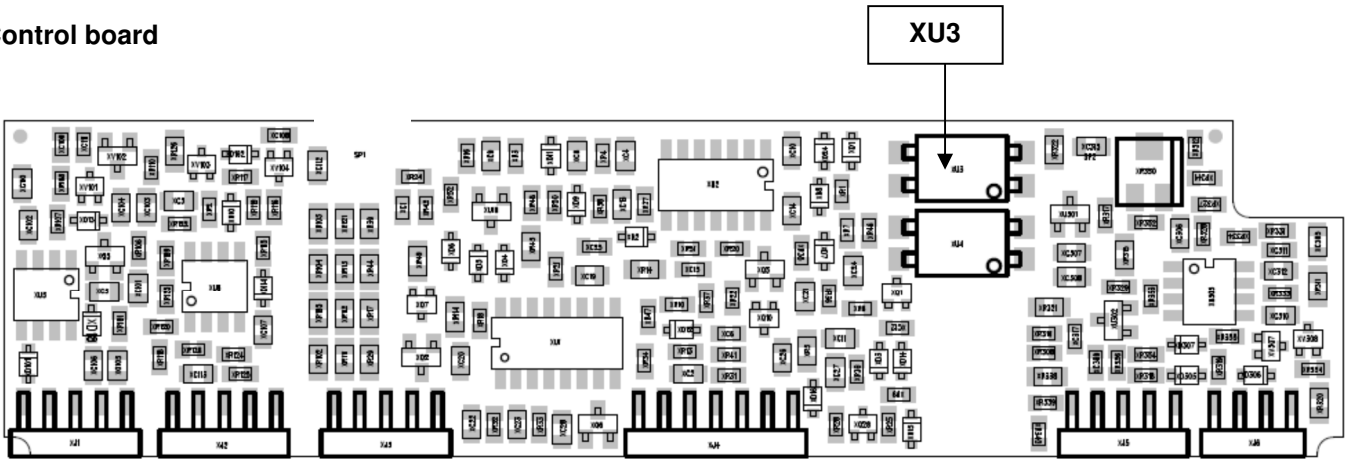

SMA 1 channel 2 board

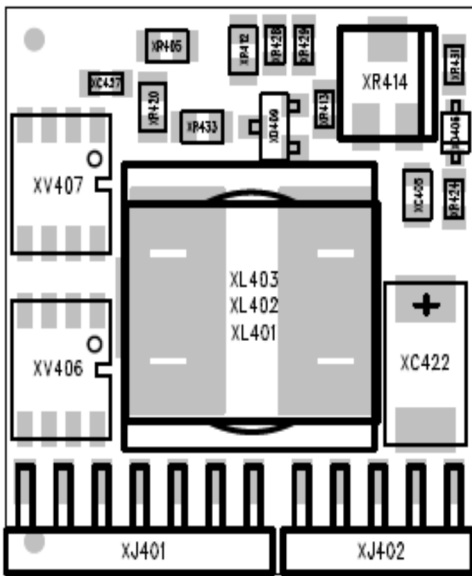

SMA 2 channel 3 board (SMA 3 channel 4 THV, FHV)

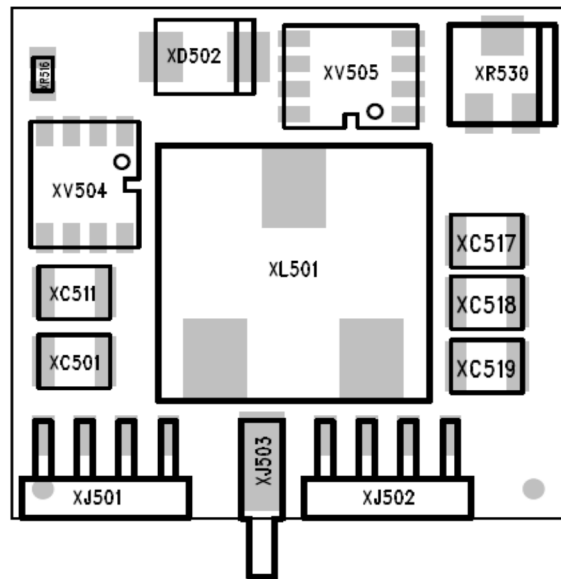

SMA 3 channel 4 board (SMA 1 channel 2 5L, SMA 2 channel 3 xL, where x = 3, 5, T or F)

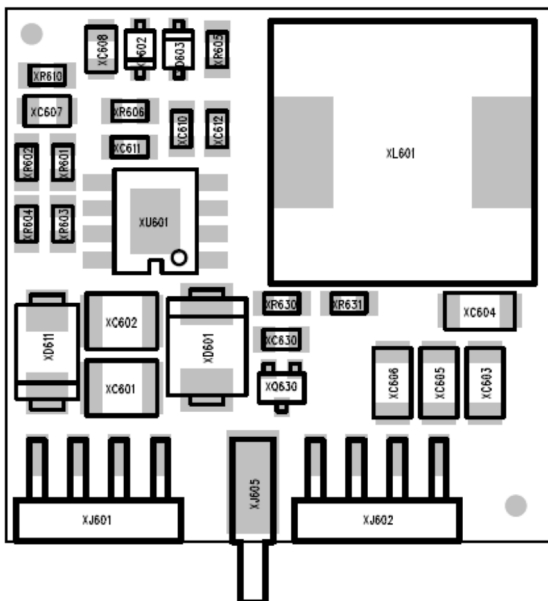

Open Frame Version with Vertical Output Connector

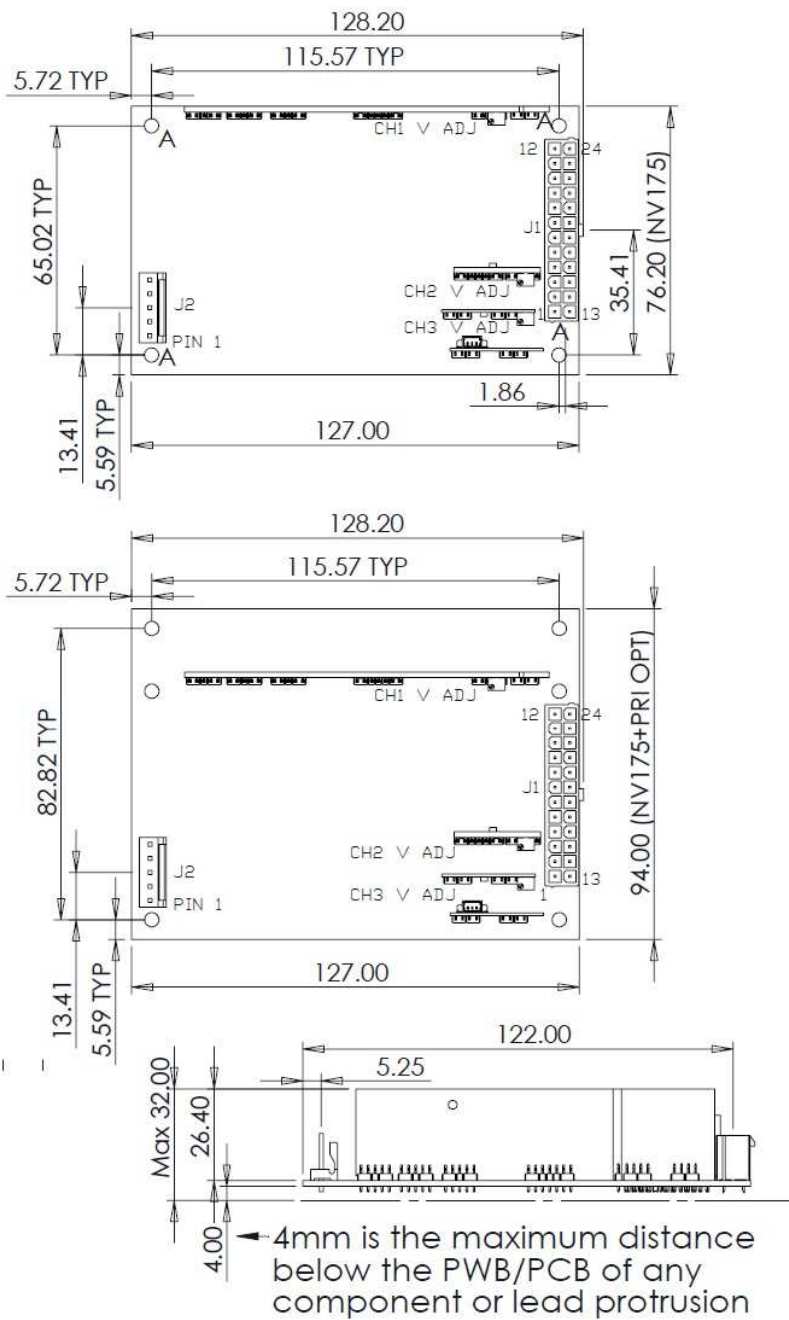

J2

PIN	FUNCTION
1	EARTH
2	NOT CONNECTED
3	LIVE
4	NOT CONNECTED
5	NEUTRAL

J1

PIN	FUNCTION	PIN	FUNCTION
12	STANDBY +Ve	24	STANDBY RETURN
11	POWER GOOD	23	REMOTE ON/OFF
10	CH1 OUTPUT	22	CH1 GOOD SIGNAL
9	CH1 OUTPUT	21	CH1 OUTPUT
8	CH1 OUTPUT	20	CH1 OUTPUT
7	+SENSE CH1	19	-SENSE CH1
6	0V COMMON	18	0V COMMON
5	0V COMMON	17	0V COMMON
4	CH2 OUTPUT	16	0V COMMON
3	CH2 OUTPUT	15	CH2 OUTPUT
2	+SENSE CH2	14	-SENSE CH2
1	CH3 OUTPUT	13	CH4 OUTPUT

MATING PARTS (MOLEX OR EQUIVALENT)

CONN	HOUSING	PINS
J1	39-01-2245	44476-3112 45750-3112
J2	09-50-8051	08-52-0113

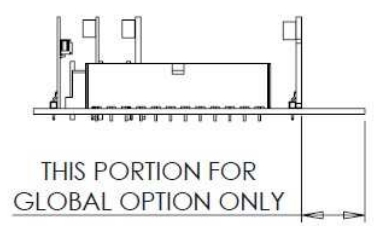

NOTE:  
'A' HOLES Ø 4.06mm CLEARANCE FOR M3 FIXINGS.

Cased Version with Vertical Output Connector

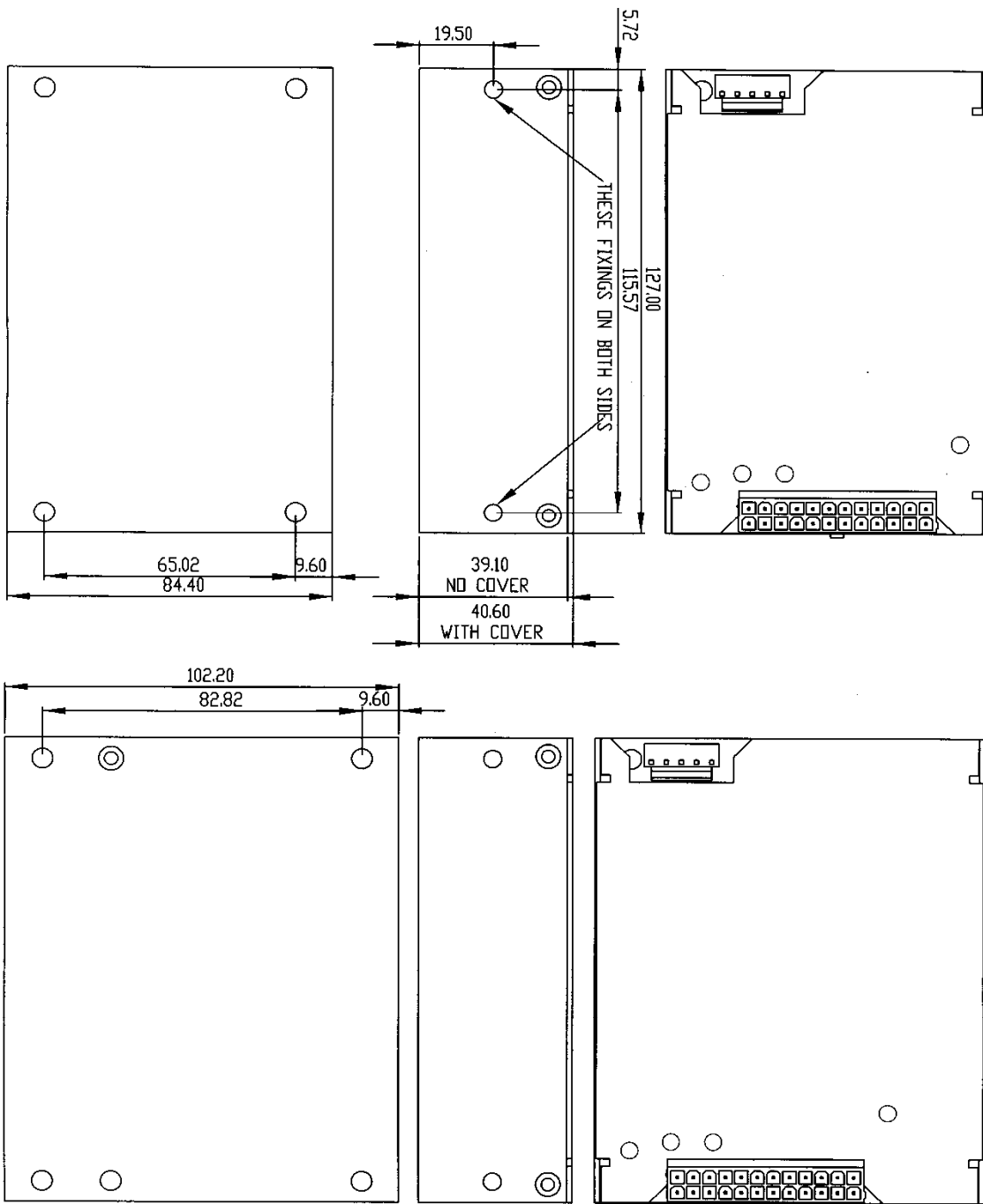

NV175 WITH OPTIONAL CASE

NOTES  
 1 ALL CUSTOMER FIXINGS M3  
 MAXIMUM PENETRATION 4.5mm  
 MAXIMUM TORQUE 0.5-0.6Nm  
 2 ALL TOLERANCES +/-0.5mm

ISSUE 5 04.07.06

Open Frame Version with Right Angled Output Connector (-R & -MR)

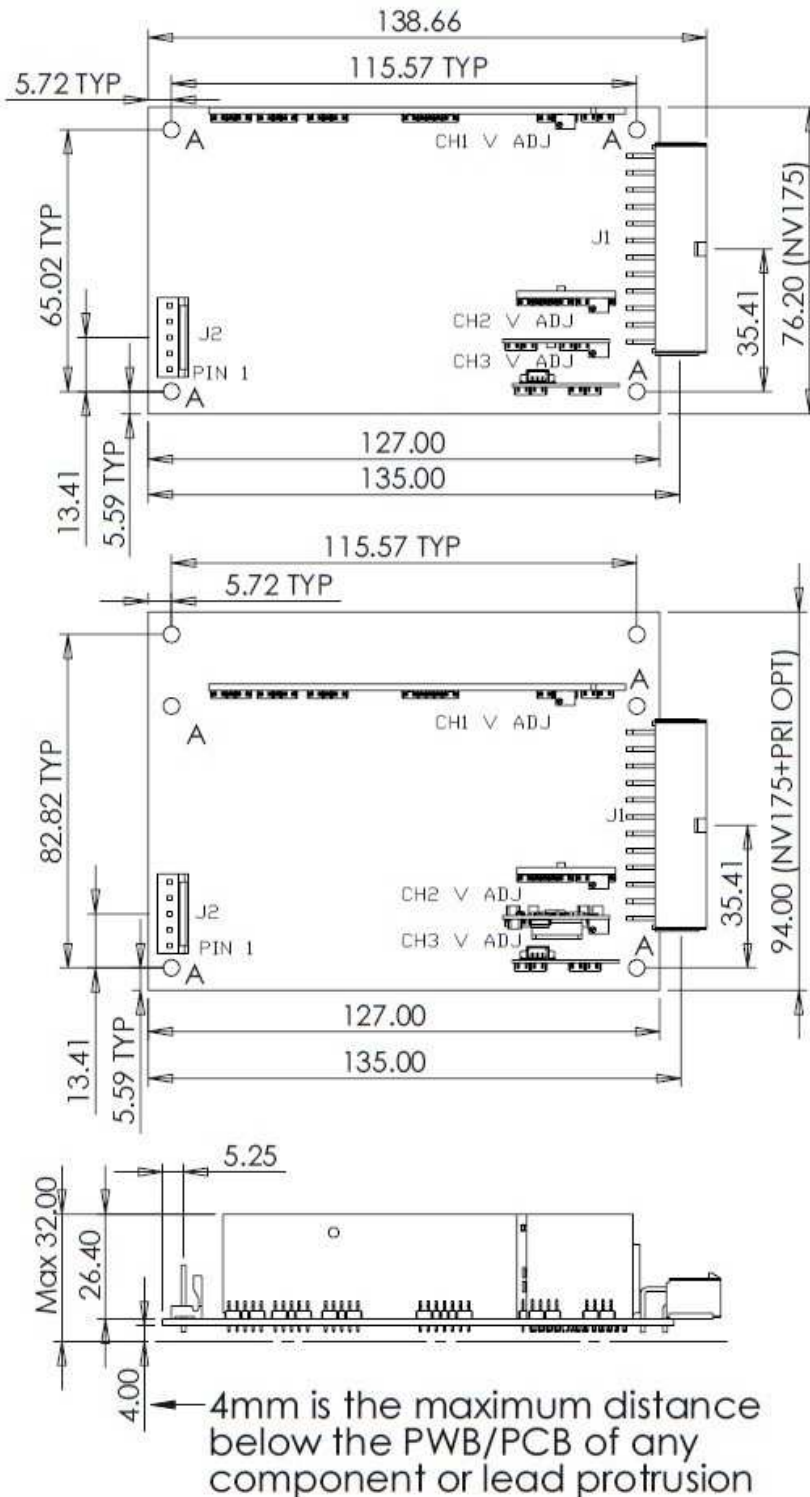

J2

PIN	FUNCTION
1	EARTH
2	NOT CONNECTED
3	LIVE
4	NOT CONNECTED
5	NEUTRAL

J1

PIN	FUNCTION	PIN	FUNCTION
13	STANDBY +V <sub>e</sub>	1	STANDBY RETURN
14	POWER GOOD	2	REMOTE ON/OFF
15	CH1 OUTPUT	3	CH1 GOOD SIGNAL
16	CH1 OUTPUT	4	CH1 OUTPUT
17	CH1 OUTPUT	5	CH1 OUTPUT
18	+SENSE CH1	6	-SENSE CH1
19	0V COMMON	7	0V COMMON
20	0V COMMON	8	0V COMMON
21	CH2 OUTPUT	9	0V COMMON
22	CH2 OUTPUT	10	CH2 OUTPUT
23	+SENSE CH2	11	-SENSE CH2
24	CH3 OUTPUT	12	CH4 OUTPUT

MATING PARTS (MOLEX OR EQUIVALENT)

CONN	HOUSING	PINS
J1	39-01-2245	4425-315 4575-315
J2	09-50-8051	00-52-013

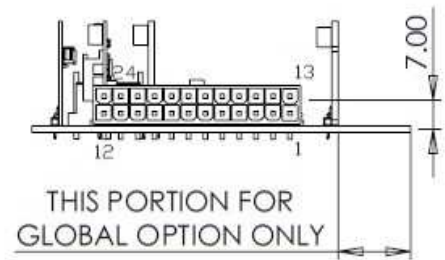

NOTE:  
'A' HOLES Ø4.06mm CLEARANCE FOR M3 FIXINGS.



Cased Version with R Output Connector

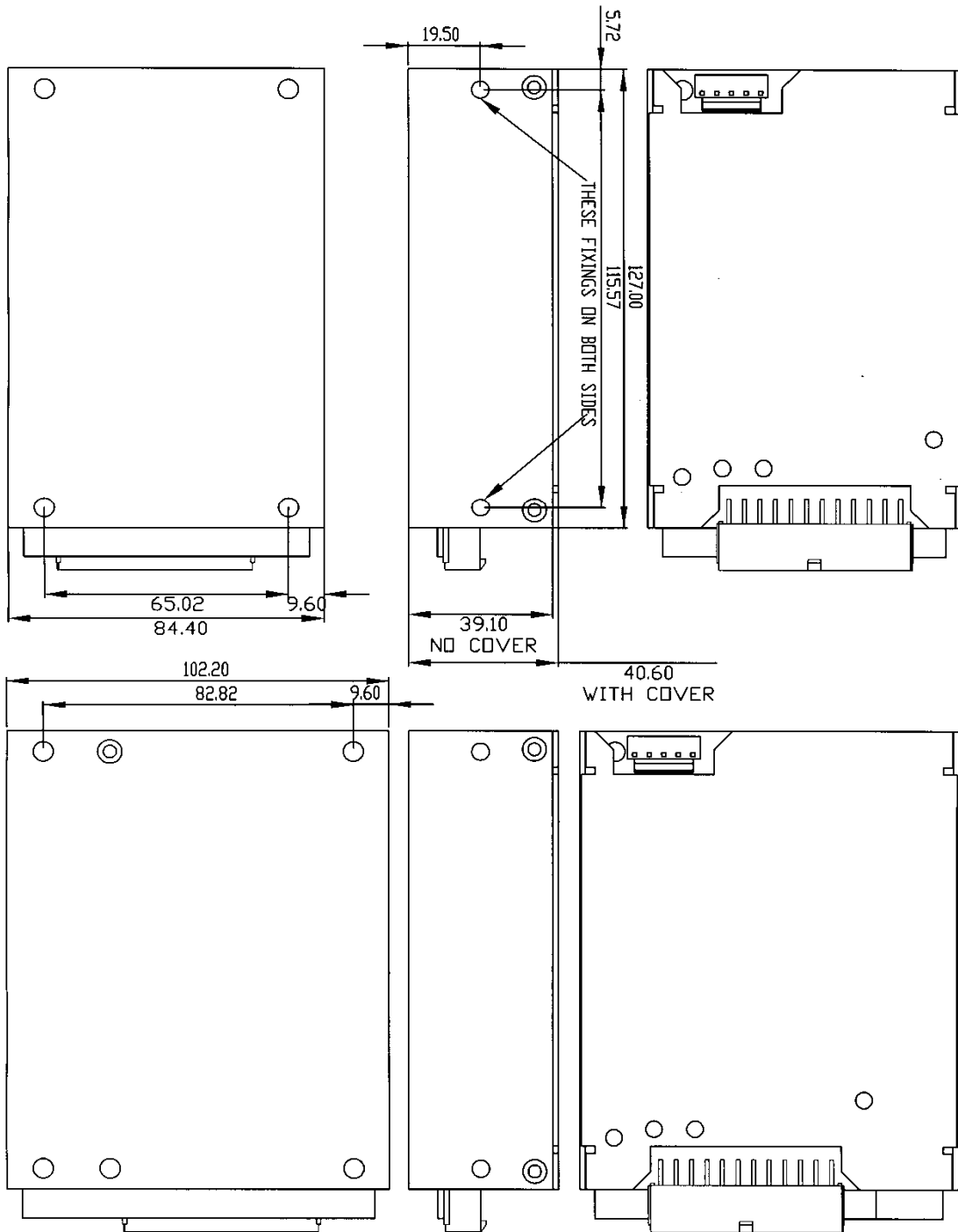

NV175 WITH OPTIONAL CASE

NOTES  
 1 ALL CUSTOMER FIXINGS M3  
 MAXIMUM PENETRATION 4.5mm  
 MAXIMUM TORQUE 0.5-0.6Nm  
 2 ALL TOLERANCES +/-0.5mm

ISSUE 5 04.07.06

Fan/IEC version chassis layout with vertical output connector

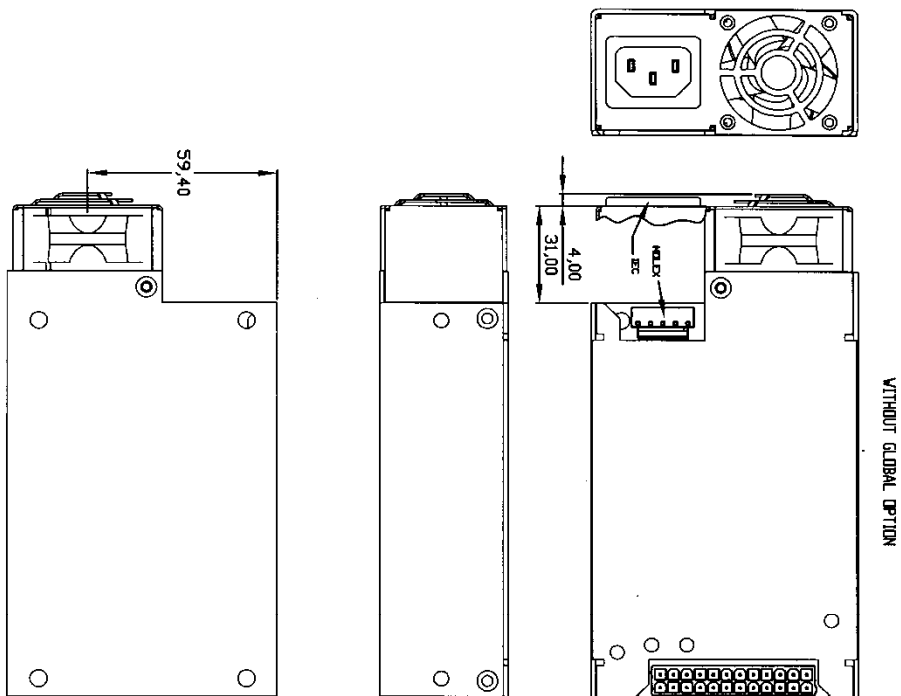

NV175 WITH OPTIONAL CASE & FAN

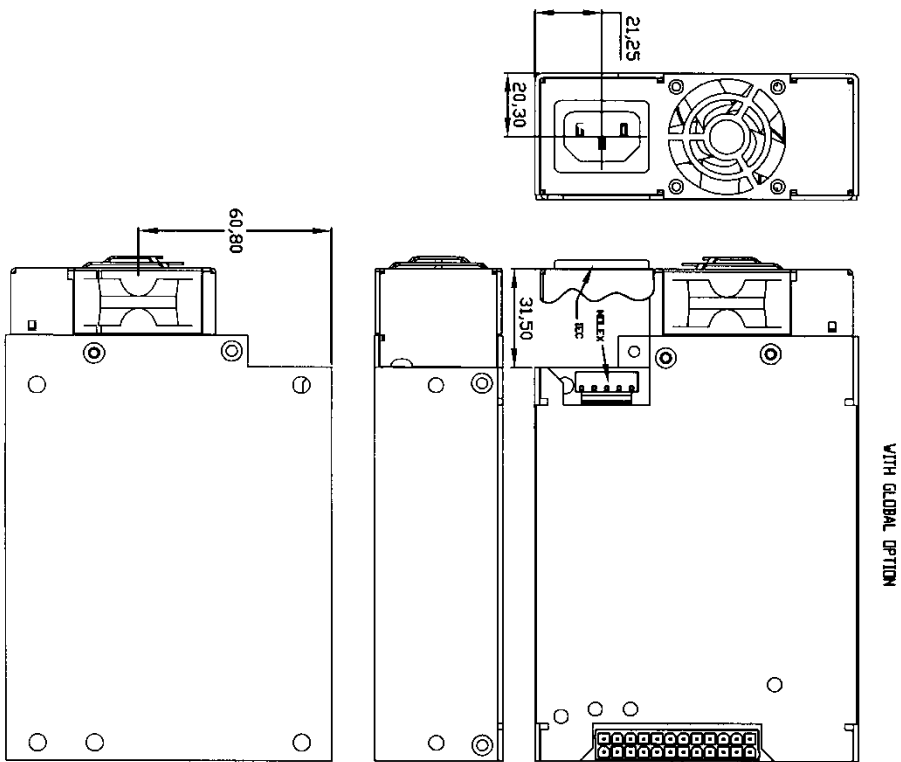

OTHER DIMENSIONS AS PER CASES WITHOUT FANS

ISSUE 4 150306

Fan/IEC version chassis layout with right angle connector

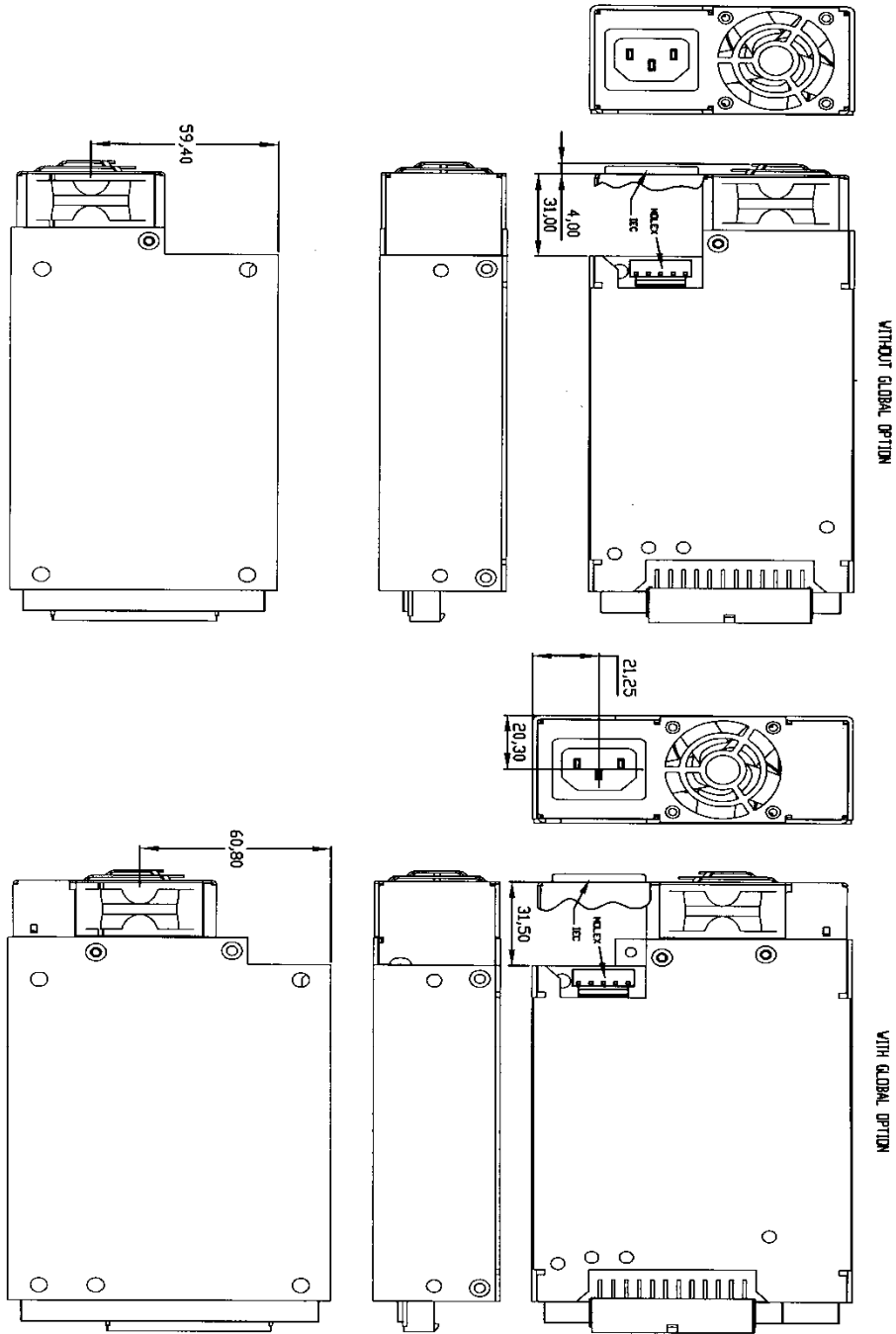

ISSUE 5 04/07/06

OTHER DIMENSIONS AS PER CASES WITHOUT FANS

**TDK-Lambda**

TDK-Lambda UK Ltd  
 Kingsley Avenue, Ilfracombe  
 Devon, EX34 8ES  
 Telephone - Sales and Service +44 (0)1271 856666  
 Head Office and Works +44 (0)1271 856600  
 Facsimile +44 (0)1271 864894  
 WEBSITE: [www.uk.tdk-lambda.com](http://www.uk.tdk-lambda.com)