

# Ceramic High Pass Filter

## HFCW-9000+

50Ω      10000 to 19500 MHz

### The Big Deal

- Good rejection, 34 dB typical
- Small size 0603 (0.063" X 0.032" X 0.024")
- Good Power handling, 2.5W
- Ceramic construction



Generic photo used for illustration purposes only  
CASE STYLE: JC0603C

### Product Overview

HFCW-9000+ is a high pass filter with passband from 10000 MHz to 19500 MHz supporting a variety of applications. This model provides good insertion loss over a wide band due to strategically constructed layout. Housed in a tiny 0603 ceramic form factor with wraparound terminations, the filter is ideal for dense PCB layouts with minimal performance variation due to parasitics.

### Key Features

Feature	Advantages
Small size, 0603 (0.063" X 0.032" X 0.024")	Accommodates tight space requirements for dense PCB layouts.
Wrap around termination	Provides excellent solderability and easy visual inspection capability.
LTCC construction	Provides a rugged package that is well suited for tough environments including high humidity and high temperature extremes.
Ultra-wide pass band	This filter has a very wide passband from 10 GHz to 19.5 GHz.

#### Notes

- A. Performance and quality attributes and conditions not expressly stated in this specification document are intended to be excluded and do not form a part of this specification document.  
B. Electrical specifications and performance data contained in this specification document are based on Mini-Circuit's applicable established test performance criteria and measurement instructions.  
C. The parts covered by this specification document are subject to Mini-Circuits standard limited warranty and terms and conditions (collectively, "Standard Terms"); Purchasers of this part are entitled to the rights and benefits contained therein. For a full statement of the Standard Terms and the exclusive rights and remedies thereunder, please visit Mini-Circuits' website at [www.minicircuits.com/MCLStore/terms.jsp](http://www.minicircuits.com/MCLStore/terms.jsp)



# Ceramic High Pass Filter

## HFCW-9000+

50Ω 10000 to 19500 MHz



Generic photo used for illustration purposes only  
CASE STYLE: JC0603C

**+RoHS Compliant**

The +Suffix identifies RoHS Compliance. See our web site for RoHS Compliance methodologies and qualifications

### Features

- Good rejection, 34 dB typ.
- Small size 0603 (0.063" X 0.032" X 0.024")
- Temperature stable
- LTCC construction

### Applications

- Test and measurements
- Military applications
- Telecommunications and broadband wireless systems

### Functional Schematic

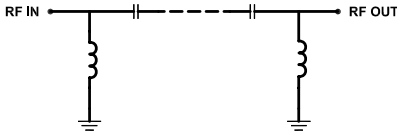

### Electrical Specifications<sup>(1,2)</sup> at 25°C

Parameter		F#	Frequency (MHz)	Min.	Typ.	Max.	Unit
Stop Band	Rejection Loss	DC-F1	DC - 6000	29	34	-	dB
		F1-F2	6000 - 7200	23	34	-	dB
	Freq. Cut-Off	F3*	9100	-	3.2	-	dB
Pass Band	Insertion Loss	F4-F5	10000 - 11500	-	2.0	-	dB
		F5-F6	11500 - 17000	-	0.9	1.6	dB
		F6-F7	17000 - 19500	-	1.7	-	dB
	Return Loss	F4-F5	10000 - 11500	-	12	-	dB
		F5-F6	11500 - 17000	-	11	-	dB
		F6-F7	17000 - 19500	-	9	-	dB

1 This component is not intended to act as a DC block. Please consult with Mini-Circuits for further details

2 Measured on Mini-Circuits Characterization Test Board TB-HFCW-9000+

\* Typically, a ±5% frequency deviation from the stated value may occur on a unit-to-unit basis.

### Maximum Ratings

Operating Temperature	-55°C to 125°C
Storage Temperature	-55°C to 125°C
RF Power Input*	2.5W @ 25°C

\* Passband rating, derate linearly to 0.6W at 125°C ambient  
Permanent damage may occur if any of these limits are exceeded.

### Typical Performance Data at 25°C

Frequency (MHz)	Insertion Loss (dB)	Return Loss (dB)
10	80.06	0.10
100	62.59	0.11
500	49.80	0.17
2000	38.89	0.18
4000	35.83	0.12
6000	40.89	0.23
7200	35.14	0.46
7425	30.34	0.54
7500	28.87	0.57
7950	20.39	0.89
8975	3.08	10.60
9000	2.90	11.45
9100	2.35	15.13
10000	1.19	23.57
11500	0.88	14.57
14000	0.65	16.78
15000	0.67	14.79
17000	0.56	16.08
18000	0.48	18.75
19500	0.56	18.23

### Typical Frequency Response

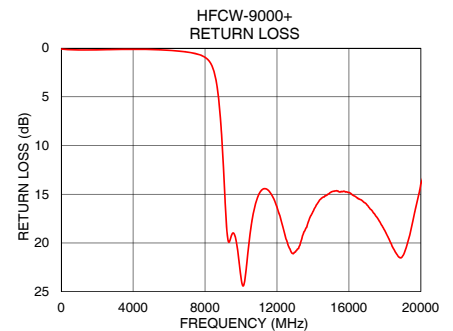
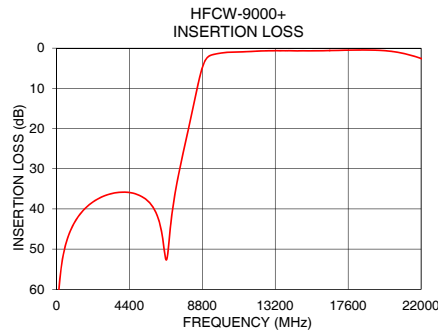
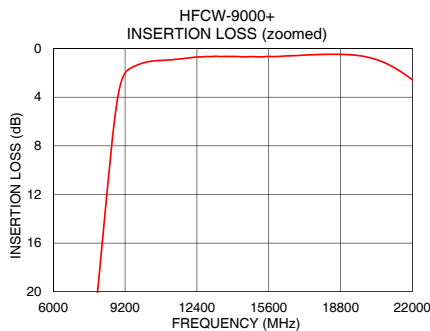
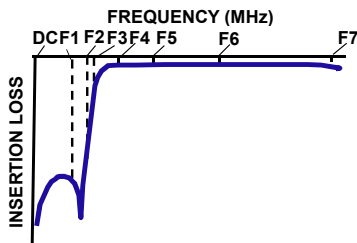

#### Notes

- Performance and quality attributes and conditions not expressly stated in this specification document are intended to be excluded and do not form a part of this specification document.
- Electrical specifications and performance data contained in this specification document are based on Mini-Circuit's applicable established test performance criteria and measurement instructions.
- The parts covered by this specification document are subject to Mini-Circuits standard limited warranty and terms and conditions (collectively, "Standard Terms"); Purchasers of this part are entitled to the rights and benefits contained therein. For a full statement of the Standard Terms and the exclusive rights and remedies thereunder, please visit Mini-Circuits' website at [www.minicircuits.com/MCLStore/terms.jsp](http://www.minicircuits.com/MCLStore/terms.jsp)



[www.minicircuits.com](http://www.minicircuits.com) P.O. Box 350166, Brooklyn, NY 11235-0003 (718) 934-4500 sales@minicircuits.com

REV. OR  
ECO-011096  
HFCW-9000+  
EDU4273  
URJ  
211213  
Page 2 of 3

## Pad Connections

INPUT	1
OUTPUT	3
GROUND	2,4,5,6

## Product Marking: 6

**Demo Board MCL P/N: TB-HFCW-9000+**  
**Suggested PCB Layout (PL-704)**

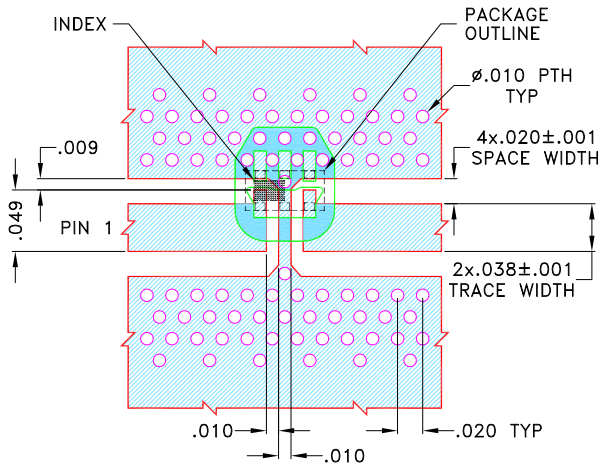

### NOTES:

1. COPLANAR WAVEGUIDE PARAMETERS ARE SHOWN FOR ROGERS (RO3003) WITH DIELECTRIC THICKNESS .020±.001 COPPER: 1/2 Oz. EACH SIDE. FOR OTHER MATERIALS TRACE WIDTH AND GAP MAY NEED TO BE MODIFIED.
  2. BOTTOM SIDE OF THE PCB IS CONTINUOUS GROUND PLANE.
- DENOTES PCB COPPER PATTERN WITH SMOBC (SOLDER MASK OVER BARE COPPER)  
 DENOTES PCB COPPER PATTERN FREE OF SOLDERMASK

## Outline Drawing

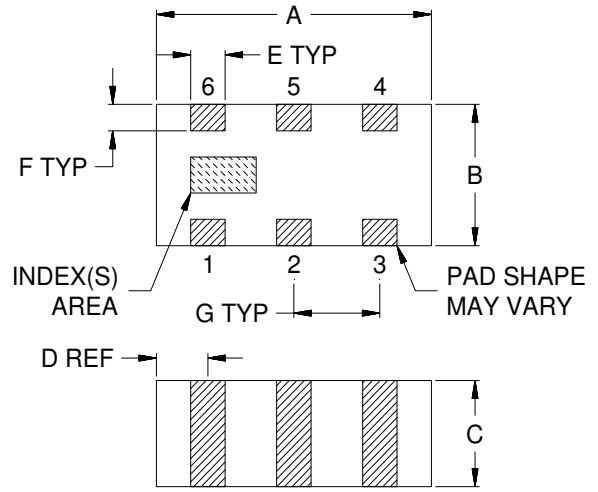

### Outline Dimensions ( inch )

A	B	C	D	E	F	G	Wt.
.063	.032	.024	.012	.008	.006	.020	grams
1.60	0.80	0.60	0.30	0.20	0.15	0.50	.005

*Note: Please refer to case style drawing for details.*

### Notes

- A. Performance and quality attributes and conditions not expressly stated in this specification document are intended to be excluded and do not form a part of this specification document.  
 B. Electrical specifications and performance data contained in this specification document are based on Mini-Circuit's applicable established test performance criteria and measurement instructions.  
 C. The parts covered by this specification document are subject to Mini-Circuits standard limited warranty and terms and conditions (collectively, "Standard Terms"); Purchasers of this part are entitled to the rights and benefits contained therein. For a full statement of the Standard Terms and the exclusive rights and remedies thereunder, please visit Mini-Circuits' website at [www.minicircuits.com/MCLStore/terms.jsp](http://www.minicircuits.com/MCLStore/terms.jsp)