

Multilayer Ceramic Chip Capacitor

Part Number: 2220YA300563KSTS3X

Description: 2220 305Vac (X2) 50/60Hz / 1000Vdc 56nF
±10% X7R (2R1) to AEC-Q200

Approval Specifications: IEC/EN60384-14:2013+A1
UL60384-14, CAN/CSA E60384-14:14

Certification: TÜV R60153664 / ID1111233479
UL/cUL E228790-20200928

Classification: IEC/EN 60384-14:2013+A1 Class X2
UL/cUL FOWX2, FOWX8

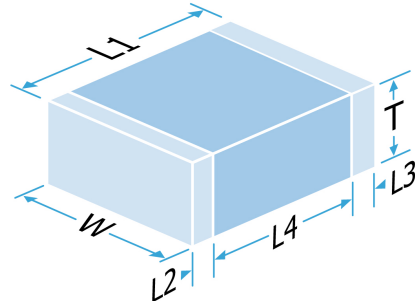

Component Marking and Certification Bodies:

Material Group I : CTI >= 600



Mechanical Specification

Size Code	2220
Length (L1) in mm (")	5.7 ± 0.40 (0.225 ± 0.016)
Width (W) in mm (")	5.0 ± 0.40 (0.197 ± 0.016)
Thickness (T) in mm (")	4.5 Max (0.177 Max)
Minimum Termination Band (L2,L3) in mm (")	0.25 (0.010)
Maximum Termination Band (L2,L3) in mm (")	1.00 (0.040)
Minimum Band Gap (L4) in mm (")	4.0 (0.158)
Termination Material	FlexiCap™ Polymer termination, Nickel barrier, Sn Plated Solder (RoHS compliant)
Solderability	IEC-60068-2-58
Packaging	7" Reel Horizontal Orientation, 500 per reel

General Electrical Specification

Rated Voltage	Class X2 (305Vac), 50/60Hz, 2.5kV impulse
Humidity Grade	Not applicable
Maximum DC Working Voltage	1000Vdc certified / (1500Vdc outside scope of any specification)
Nominal Capacitance Value	56nF
Capacitance Tolerance	±10%
Tangent of Loss Angle (Tan δ)	≤0.025
Capacitance and Tan δ Test Conditions	1.0Vrms @ 1kHz
Voltage Proof (50mA max charging current for DC tests)	100% test: 3000Vdc 1s min / 5s max AQL test: 3225Vdc / 1505Vac 60s min / 2.5kV 1.2x50µs impulse
Min Insulation Resistance (IR)	17.86GOhm @ 100Vdc
Dielectric Classification	X7R (2R1) to AEC-Q200
Rated Temperature Range	-55°C / +125°C
Maximum Capacitance Change over Temperature Range	No DC Voltage ±15% Rated DC Voltage -
Climatic Category (IEC)	55/125/56
Ageing Characteristic	<2% per decade

Knowles Precision Devices - Sales

Europe: KPD-Europe-sales@knowles.com

Asia: KPD-Asia-sales@knowles.com

USA: KPD-NA-sales@knowles.com

www.knowlescapacitors.com

This datasheet is for a standard item and is confirmed valid on the date generated, the latest published data for this part may differ and is available at <http://www.knowlescapacitors.com> or by contacting us.

© The information contained on this drawing is confidential and may not be copied in whole or part in any form or disclosed to a third party without the consent of Knowles and any customer mentioned within this specification.

Data is correct to the best of our knowledge, errors and omissions excepted.

Date: Thursday, September 02, 2021

20210902 220158280UTC

Multilayer Ceramic Chip Capacitor

Part Number: 2220YA300563KSTS3X

Description: 2220 305Vac (X2) 50/60Hz / 1000Vdc 56nF ±10% X7R (2R1) to AEC-Q200

Environmental

RoHS Compliant to 2011/65/EC as amended by 2015/863/EU	Compliant
REACH Compliant	211 compliant
California Proposition 65	No exposure risk

Board Layout

Knowles' conventional 2-terminal chip capacitors can generally be mounted using pad designs in accordance with international specification IPC-7351, Generic Requirements for Surface Mount Design and Land Pattern Standards, but there are some other factors that have been shown to reduce mechanical stress, such as reducing the pad width to less than the chip width. In addition, the position of the chip on the board should be considered.

Some high voltage parts may require modifications to the board layout and/or the addition of a conformal coating to prevent flashover. Refer to application note AN0043 for further information.

IPC-7351 pad design

	2220	
C	5.30mm	0.209"
Y	1.50mm	0.059"
X	5.40mm	0.213"

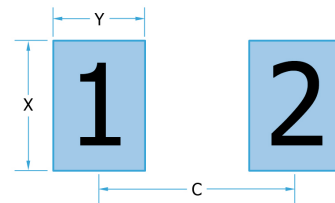

Packaging

Tape packaging information for tape-and-reel parts:

Tape and reel packing of surface mounting chip capacitors for automatic placement are in accordance with IEC60286-3.

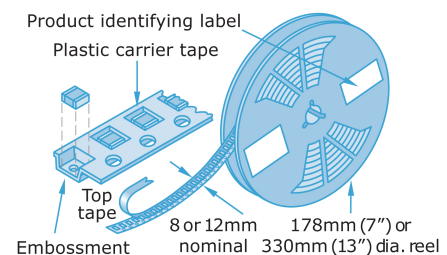

Soldering

Reflow solder in accordance with IPC-A-610. Recommended reflow profile as laid down in IPC/JEDEC J-STD-020.

Wave soldering is also possible, but care must be taken for case sizes 1210 and larger and component thickness >1.0mm. Trials are encouraged.

Hand soldering is not recommended and can lead to component damage through thermal shock.

Application notes with mounting and handling guidance are available on request.



Compex DLI Johanson MFG Novacap Syfer Voltronics

Knowles Precision Devices - Sales

Europe: KPD-Europe-sales@knowles.com

Asia: KPD-Asia-sales@knowles.com

USA: KPD-NA-sales@knowles.com

www.knowlescapacitors.com

This datasheet is for a standard item and is confirmed valid on the date generated, the latest published data for this part may differ and is available at <http://www.knowlescapacitors.com> or by contacting us.

© The information contained on this drawing is confidential and may not be copied in whole or part in any form or disclosed to a third party without the consent of Knowles and any customer mentioned within this specification.

Data is correct to the best of our knowledge, errors and omissions excepted.

Date: Thursday, September 02, 2021

20210902 220158280UTC