

THIS DOCUMENT IS SUBJECT TO CHANGE WITHOUT NOTICE. IT IS CONFIDENTIAL AND A PROPERTY OF Amphenol LTW. DISCLOSURE TO THIRD PARTY HAS TO BE AUTHORIZED BY Amphenol LTW.

REV.	ECN NO.	DATE	SIGN	DESCRIPTION
A	Initial Release	2018/06/20	Mafei	Change Rev.01 To Rev.A

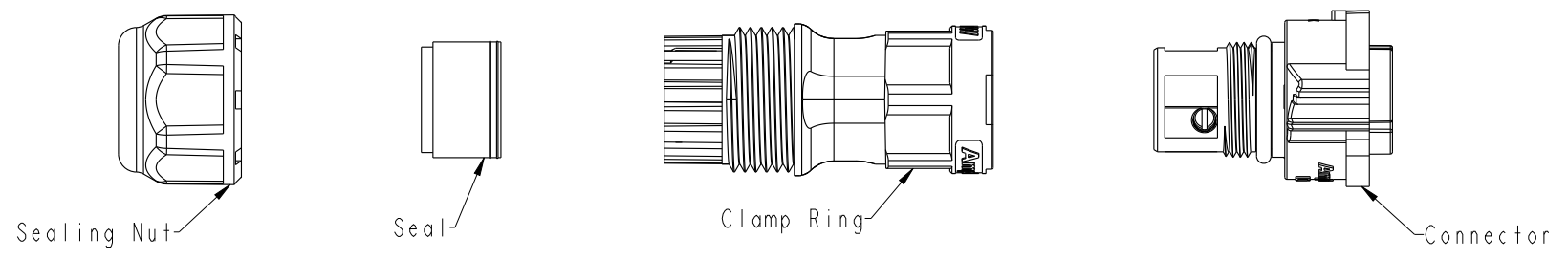

Material Specification:

- * Connector: Thermoplastic
- * Terminal: Copper Alloy, Gold Plated.
- * Gasket & O-Ring: Rubber.
- * UL Rated: UL 94V-0, fl.
- * RoHS Compliant.

Electrical Specification:

- * Contact Resistance: 10mΩ Max.
- * Insulation Resistance: 100MΩ Min.
- * Dielectric Withstand Voltage: 1,600 Vac.

Mechanical Specification:

- * Durability: 1000 Cycles.
- * Tensile strength: 10 kgf.
- * Wire conductor: 14AWG~12AWG(2.0mm²~3.3mm²).
- * Wire insulation OD: Max 4.0mm.
- * Torque Force for Clamp Ring: 6~8 kgf-cm
- * Torque Force for Seal Nut: 8~15 kgf-cm
- * Torque Force for Screw: 4~5 kgf-cm

Environmental Specification:

- * Waterproof Rating: IP68(Mated, 1M/24 Hours)
- * Temperature Range: -40°C to 105°C.
- * Salt Spray: Mated, 500 Hours.
- * Safety Compliance: UL 1977.

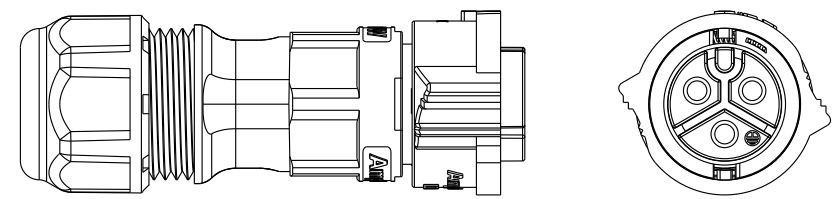
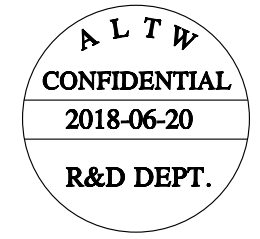
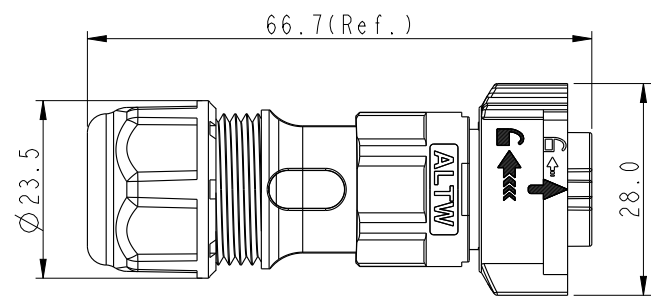

UNIT:mm		
TOLERANCE		
±0.5 mm		

TITLE X-Lok C-Size Field Installable Cable Screw-in Type F Conn F Pin			
SCALE 8:5	SIZE A4	SHEET 1 OF 2	
REV. A	WC-REV. A.3	QC: Inspection item	

Amphenol LTW
安費諾亮泰企業股份有限公司

ITEM NO	DRAWN BY Mafei	DATE 2018-06-20
DWG NO CC-XXBFFB-QL8XPP	CHECKED BY Jerry	DATE 2018-06-20
CUSTOMER ALTW	APPROVED BY Max	DATE 2018-06-20

THIS DOCUMENT IS SUBJECT TO CHANGE WITHOUT NOTICE. IT IS CONFIDENTIAL AND A PROPERTY OF Amphenol LTW. DISCLOSURE TO THIRD PARTY HAS TO BE AUTHORIZED BY Amphenol LTW.

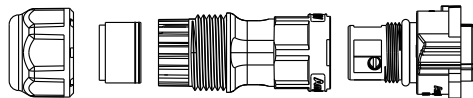

QTY: 1 Pcs

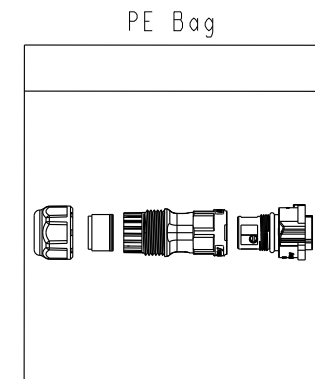

QTY: XX Pcs

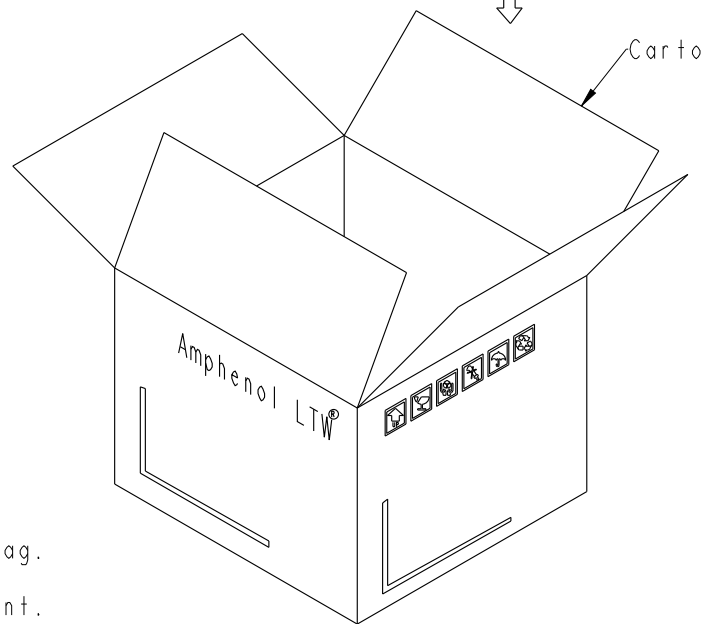

Ordering Information:

CC-XXBFFB-QL8XPP

Number of Contacts

02
03

S: With Red Color Seal 1, Cable OD 6.0~8.0mm.
M: With Yellow Color Seal 2, Cable OD 8.0~10.0mm.
L: With Blue Color Seal 3, Cable OD 10.0~12.0mm.
A: With Seal 1 & Seal 2 & Seal 3.



20A ; 300Vac/Vdc
3 Contacts(03)

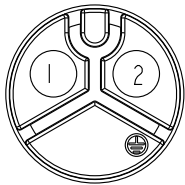

20A ; 300Vac/Vdc
2 Contacts(02)

Note:

- * One Set Unassembled In One PE Bag.
(每一組未組裝，放置於一個PE袋，並封口，如圖示)
- * Label is Attached To PE Bag Front.
(標籤貼在PE袋正面)

UNIT:mm	
TOLERANCE	±0.5 mm

TITLE X-Lok C-Size Field Installable Cable Screw-in Type F Conn F Pin			
SCALE 8:5	SIZE A4	SHEET 2 OF 2	
REV. A	WC-REV. A.3	Ⓞ: Inspection item	

Amphenol LTW
安費諾亮泰企業股份有限公司

ITEM NO	DRAWN BY Mafei	DATE 2018-03-14
DWG NO CC-XXBFFB-QL8XPP	CHECKED BY Jerry	DATE 2018-03-14
CUSTOMER ALTW	APPROVED BY Max	DATE 2018-03-14