

## YASMEEN-50-WW-C-WHT

~60° spot beam. Assembly with holder C compatible with LEDiL HEKLA. White version.

### SPECIFICATION:

Dimensions	Ø 49.9 mm
Height	28.1 mm
ROHS compliant	yes ⓘ



### MATERIALS:

Component	Type	Material	Colour	Finish
YASMEEN-50-WW	Single lens	PMMA	clear	
YASMEEN-50-HLD-C-WHT	Holder	PC	white	





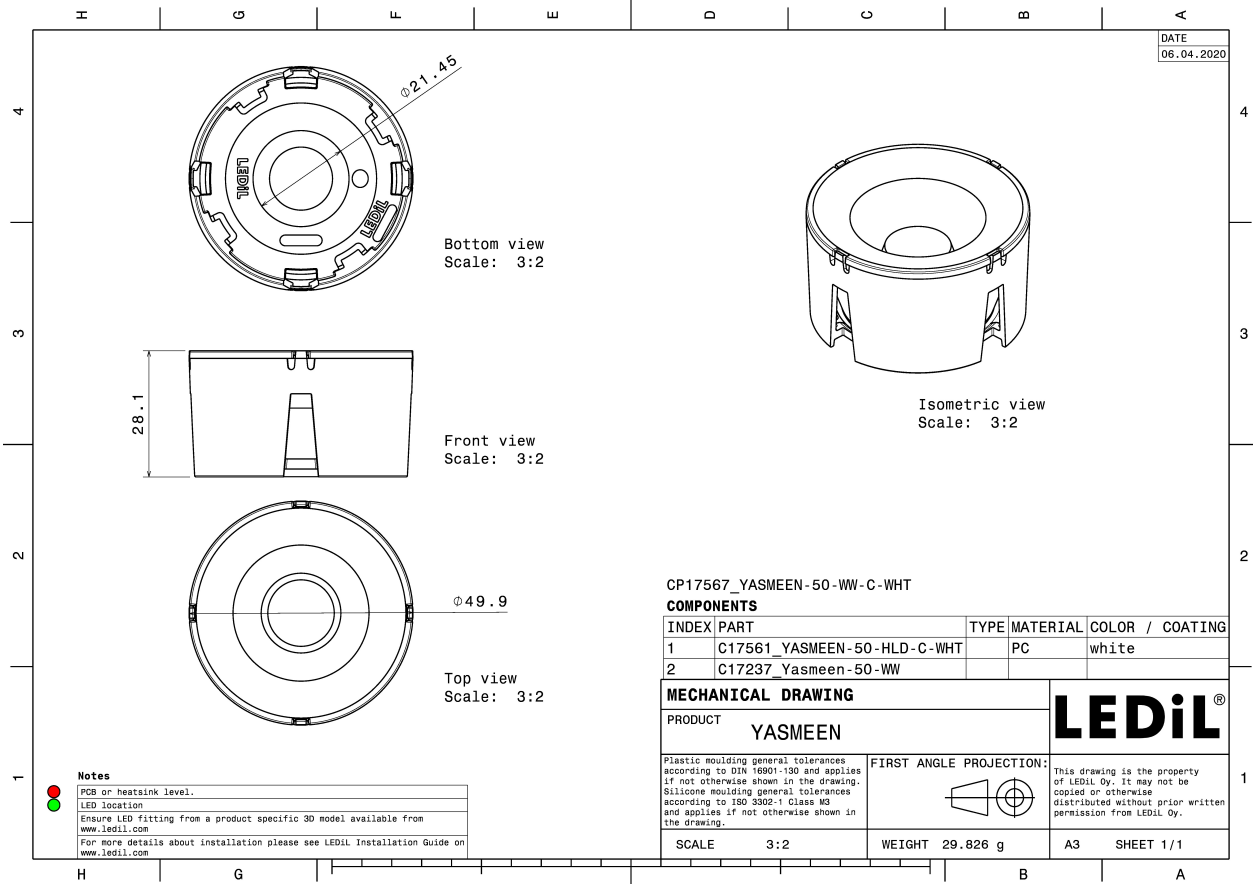

### ORDERING INFORMATION:

Component	Type	Qty in box	MOQ	MPQ	Box weight (kg)
CP17567_YASMEEN-50-WW-C-WHT » Box size: 476 x 273 x 305 mm	Single lens	252	112	28	9.8

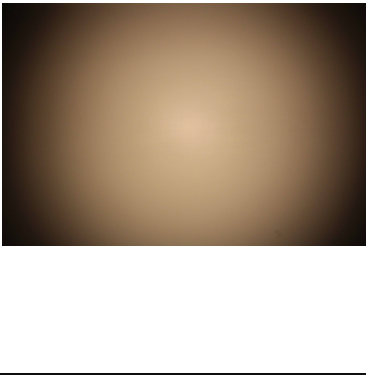
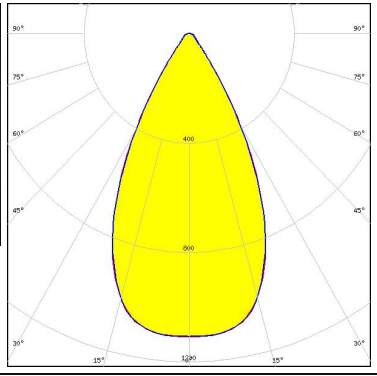

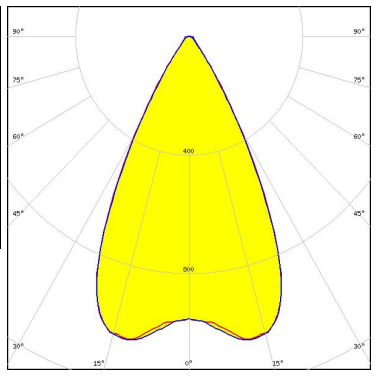

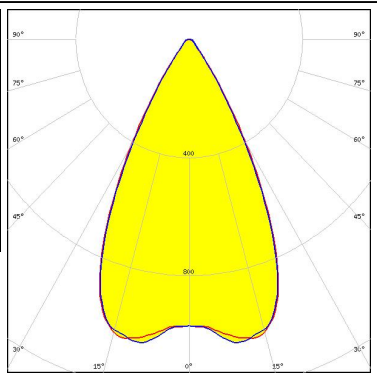

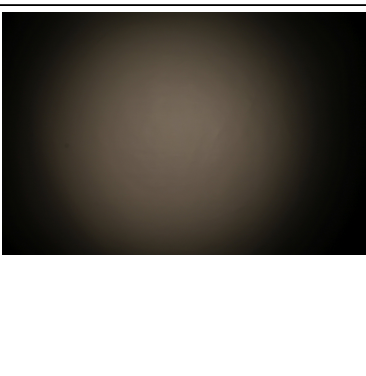
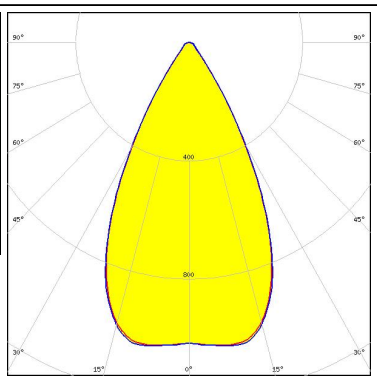

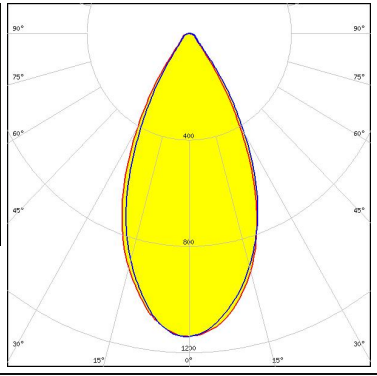

See also our general installation guide: [www.ledil.com/installation\\_guide](http://www.ledil.com/installation_guide)

#### OPTICAL RESULTS (MEASURED):

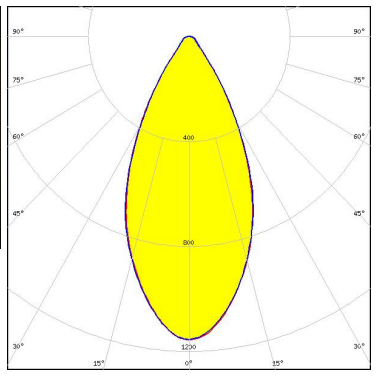
<p></p> <p>LED V11 HD Gen 8</p> <p>FWHM / FWTM 54.0° / 78.0°</p> <p>Efficiency 92 %</p> <p>Peak intensity 1.1 cd/m</p> <p>LEDs/each optic 1</p> <p>Light colour White</p> <p>Required components: Bender Wirth: 633d Hekla</p>		
<p></p> <p>LED V4 HD Gen 7</p> <p>FWHM / FWTM 54.0° / 76.0°</p> <p>Efficiency 91 %</p> <p>Peak intensity 1.1 cd/m</p> <p>LEDs/each optic 1</p> <p>Light colour White</p> <p>Required components: F15253_HEKLA-SOCKET-A</p>		
<p></p> <p>LED V6 HD Gen 7</p> <p>FWHM / FWTM 55.0° / 77.0°</p> <p>Efficiency 91 %</p> <p>Peak intensity 1.1 cd/m</p> <p>LEDs/each optic 1</p> <p>Light colour White</p> <p>Required components: F15255_HEKLA-SOCKET-C</p>		
<p></p> <p>LED VERO10</p> <p>FWHM / FWTM 55.0° / 78.0°</p> <p>Efficiency 90 %</p> <p>Peak intensity 1.1 cd/m</p> <p>LEDs/each optic 1</p> <p>Light colour White</p> <p>Required components: F15616_HEKLA-SOCKET-F</p>		

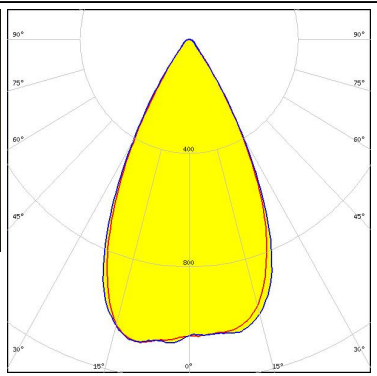
#### OPTICAL RESULTS (MEASURED):

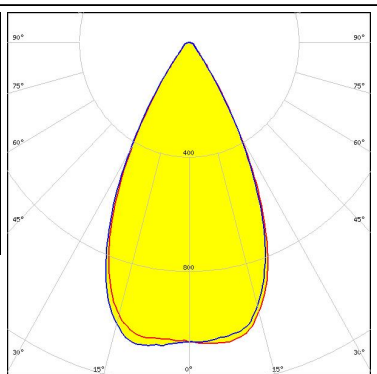
<p></p> <p>LED Vesta DTW 13mm (21W)            FWHM / FWTM 51.0° / 80.0°            Efficiency 90 %            Peak intensity 1.1 cd/lm            LEDs/each optic 1            Light colour Tunable White            Required components:            Bender Wirth: 632b Hekla XL</p>		
<p></p> <p>LED Vesta DTW 15mm (33W)            FWHM / FWTM 49.0° / 80.0°            Efficiency 89 %            Peak intensity 1.2 cd/lm            LEDs/each optic 1            Light colour Tunable White            Required components:            Bender Wirth: 632b Hekla XL</p>		
<p></p> <p>LED Vesta DTW 9mm (4W/6W/12W)            FWHM / FWTM 55.0° / 77.0°            Efficiency 92 %            Peak intensity 1.1 cd/lm            LEDs/each optic 1            Light colour White            Required components:            Bender Wirth: 652b Hekla</p>		
<p><b>CITIZEN</b></p> <p>LED CLL02x/CLU02x (LES10)            FWHM / FWTM 54.0° / 78.0°            Efficiency 91 %            Peak intensity 1.1 cd/lm            LEDs/each optic 1            Light colour White            Required components:            F17435_HEKLA-G2-C</p>		

#### OPTICAL RESULTS (MEASURED):

#### CITIZEN

LED CLU700/701/702/703  
 FWHM / FWTM 55.0° / 77.0°  
 Efficiency 92 %  
 Peak intensity 1.1 cd/m  
 LEDs/each optic 1  
 Light colour White  
 Required components:  
 F17435\_HEKLA-G2-C

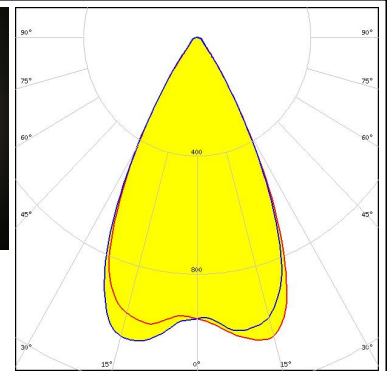
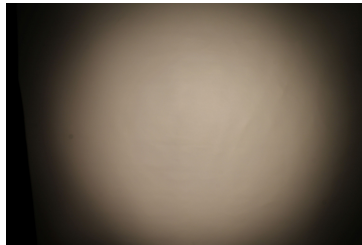

#### CITIZEN

LED CLU7A2/7A3  
 FWHM / FWTM 55.0° / 76.0°  
 Efficiency 92 %  
 Peak intensity 1.1 cd/m  
 LEDs/each optic 1  
 Light colour White  
 Required components:  
 F17435\_HEKLA-G2-C

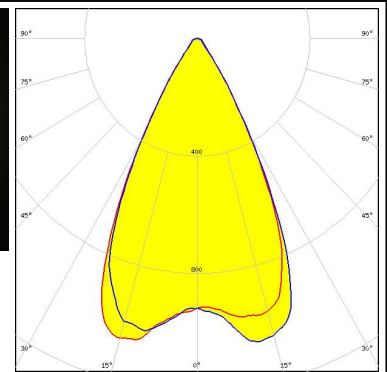
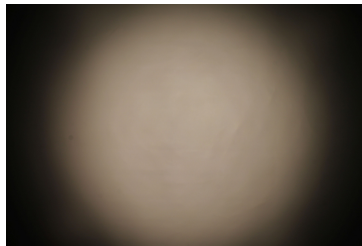

#### CITIZEN

LED CLU7B2  
 FWHM / FWTM 55.0° / 76.0°  
 Efficiency 92 %  
 Peak intensity 1.1 cd/m  
 LEDs/each optic 1  
 Light colour White  
 Required components:  
 F17435\_HEKLA-G2-C

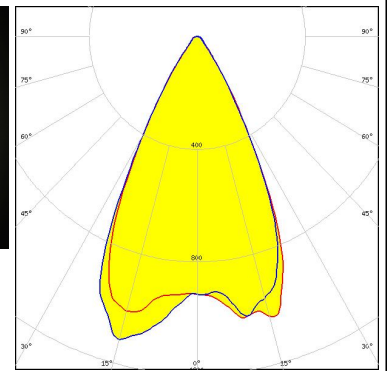
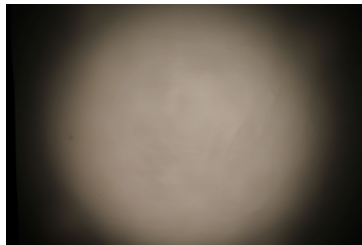

#### CREE LED

LED CMA1516  
 FWHM / FWTM 54.0° / 78.0°  
 Efficiency 91 %  
 Peak intensity 1.1 cd/m  
 LEDs/each optic 1  
 Light colour White  
 Required components:  
 F17436\_HEKLA-G2-D

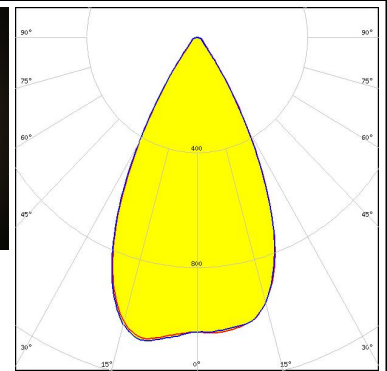
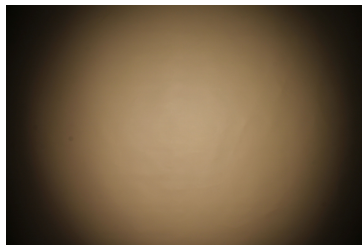

#### OPTICAL RESULTS (MEASURED):

##### CREE LED

LED CMT14xx  
 FWHM / FWTM 54.0° / 78.0°  
 Efficiency 91 %  
 Peak intensity 1.1 cd/m  
 LEDs/each optic 1  
 Light colour White  
 Required components:  
 F17435\_HEKLA-G2-C

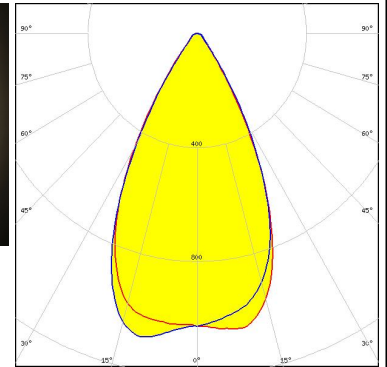

##### CREE LED

LED CXA/B 13xx  
 FWHM / FWTM 55.0° / 77.0°  
 Efficiency 92 %  
 Peak intensity 1.1 cd/m  
 LEDs/each optic 1  
 Light colour White  
 Required components:  
 F17439\_HEKLA-G2-J

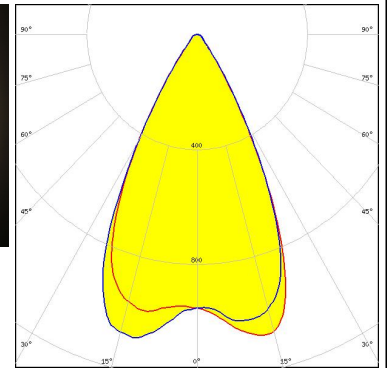
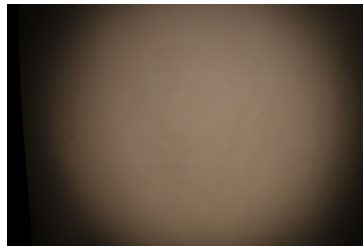

##### CREE LED

LED CXA/B 15xx  
 FWHM / FWTM 55.0° / 78.0°  
 Efficiency 92 %  
 Peak intensity 1.1 cd/m  
 LEDs/each optic 1  
 Light colour White  
 Required components:  
 F17436\_HEKLA-G2-D

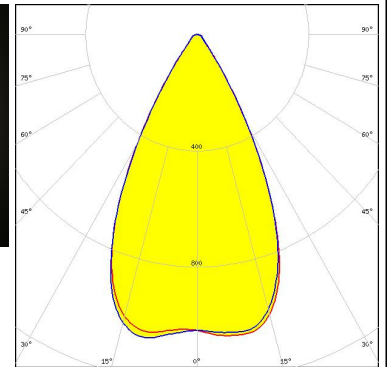
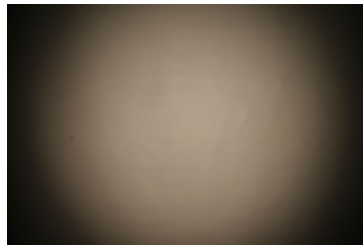

##### LUMILEDS

LED LUXEON CoB 1202/1203  
 FWHM / FWTM 54.0° / 77.0°  
 Efficiency 91 %  
 Peak intensity 1.1 cd/m  
 LEDs/each optic 1  
 Light colour White  
 Required components:  
 F17437\_HEKLA-G2-H

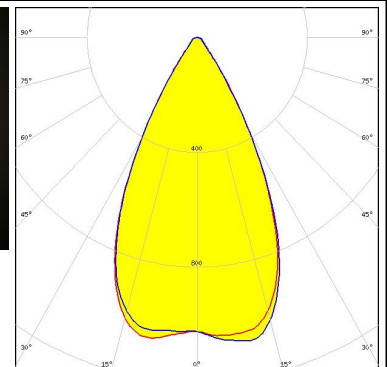
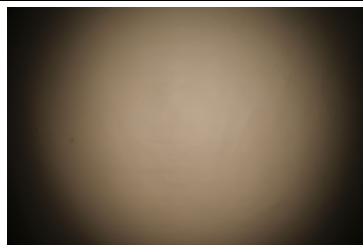

#### OPTICAL RESULTS (MEASURED):

#### LUMILEDS

LED LUXEON CoB 1204HD  
 FWHM / FWTM 54.0° / 77.0°  
 Efficiency 92 %  
 Peak intensity 1.1 cd/lm  
 LEDs/each optic 1  
 Light colour White  
 Required components:  
 F17437\_HEKLA-G2-H

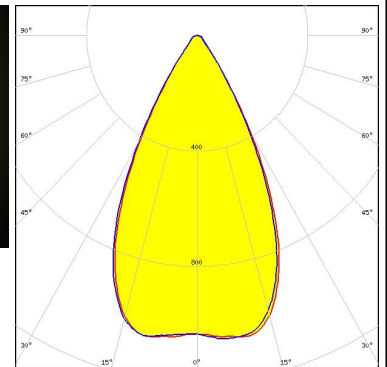
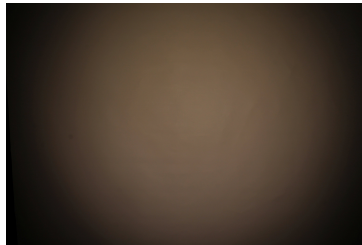

#### LUMILEDS

LED LUXEON CoB M02/M03  
 FWHM / FWTM 54.0° / 77.0°  
 Efficiency 92 %  
 Peak intensity 1.1 cd/lm  
 LEDs/each optic 1  
 Light colour White  
 Required components:  
 F17436\_HEKLA-G2-D

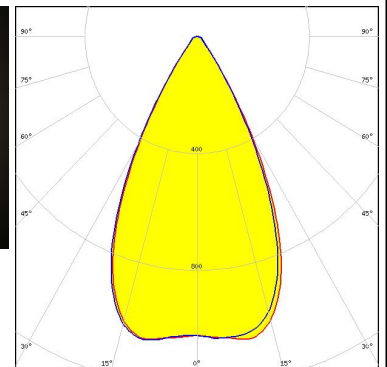
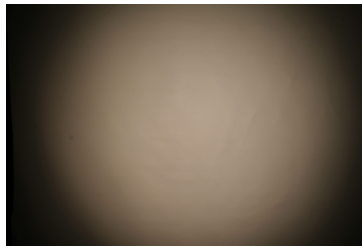

#### LUMILEDS

LED LUXEON CoB S01  
 FWHM / FWTM 55.0° / 77.0°  
 Efficiency 92 %  
 Peak intensity 1.1 cd/lm  
 LEDs/each optic 1  
 Light colour White  
 Required components:  
 F17439\_HEKLA-G2-J

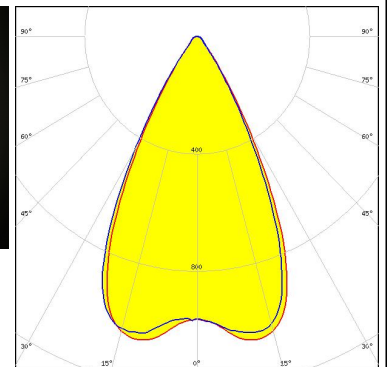
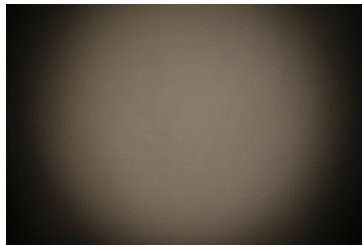

#### LUMINUS

LED CXM-3  
 FWHM / FWTM 55.0° / 76.0°  
 Efficiency 92 %  
 Peak intensity 1.1 cd/lm  
 LEDs/each optic 1  
 Light colour White  
 Required components:  
 F17435\_HEKLA-G2-C

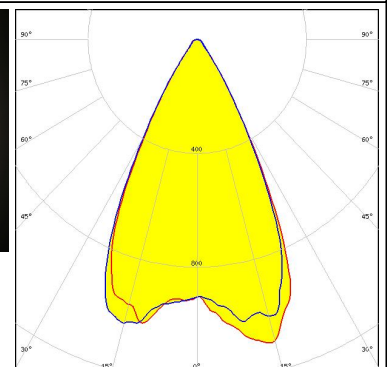
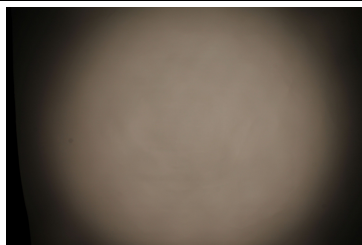

#### OPTICAL RESULTS (MEASURED):



LED CXM-4  
 FWHM / FWTM 55.0° / 77.0°  
 Efficiency 92 %  
 Peak intensity 1.1 cd/lm  
 LEDs/each optic 1  
 Light colour White  
 Required components:  
 F17435\_HEKLA-G2-C

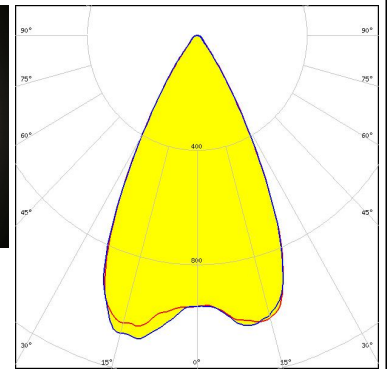
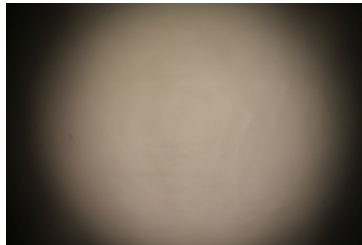

LED COB L-Type (LES 9)  
 FWHM / FWTM 55.0° / 78.0°  
 Efficiency 91 %  
 Peak intensity 1.1 cd/lm  
 LEDs/each optic 1  
 Light colour White  
 Required components:  
 F17437\_HEKLA-G2-H

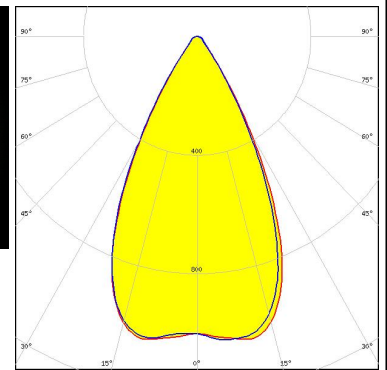
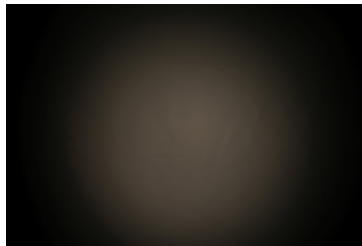

LED COB S-Type (LES 7)  
 FWHM / FWTM 55.0° / 77.0°  
 Efficiency 90 %  
 Peak intensity 1 cd/lm  
 LEDs/each optic 1  
 Light colour White  
 Required components:  
 F15848\_HEKLA-SOCKET-G

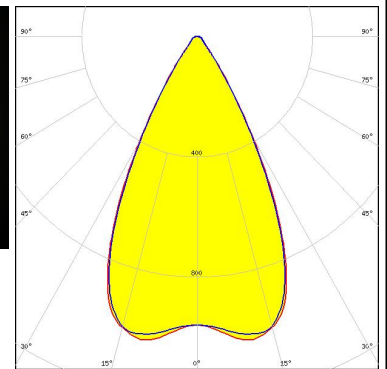
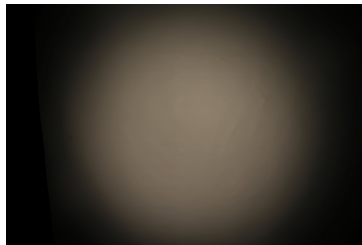

LED Fortimo SLM L09 CoB  
 FWHM / FWTM 54.0° / 77.0°  
 Efficiency 92 %  
 Peak intensity 1.1 cd/lm  
 LEDs/each optic 1  
 Light colour White  
 Required components:  
 F17437\_HEKLA-G2-H

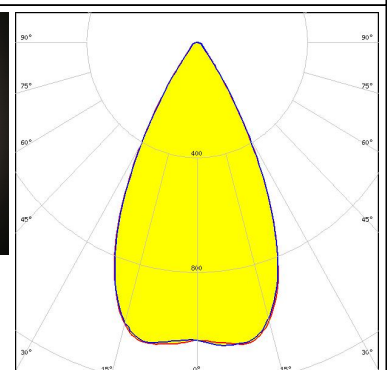
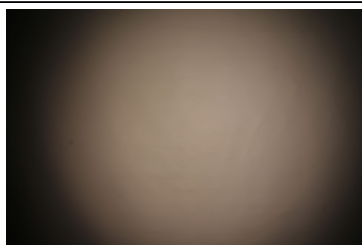



#### OPTICAL RESULTS (MEASURED):

### SAMSUNG

LED LC003D / LC006D / LC009D / LC013D  
 FWHM / FWTM 54.0° / 78.0°  
 Efficiency 91 %  
 Peak intensity 1.1 cd/m  
 LEDs/each optic 1  
 Light colour White  
 Required components:  
 F17435\_HEKLA-G2-C

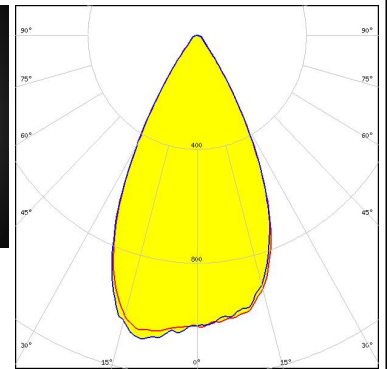
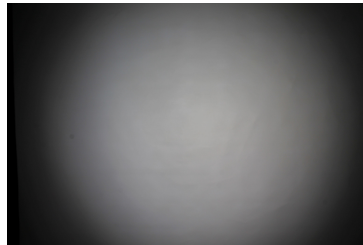

SEOUL SEMICONDUCTOR

LED MJT COB LES 6  
 FWHM / FWTM 55.0° / 77.0°  
 Efficiency 93 %  
 Peak intensity 1.1 cd/m  
 LEDs/each optic 1  
 Light colour White  
 Required components:  
 F17435\_HEKLA-G2-C

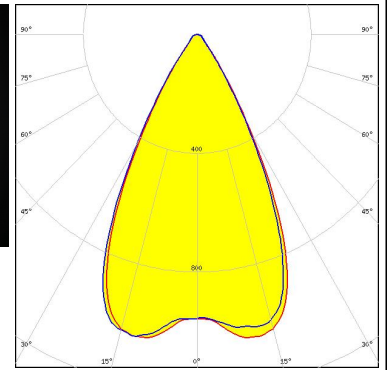
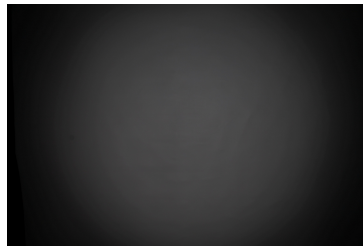

SEOUL SEMICONDUCTOR

LED MJT COB LES 9.8  
 FWHM / FWTM 54.0° / 78.0°  
 Efficiency 91 %  
 Peak intensity 1.1 cd/m  
 LEDs/each optic 1  
 Light colour White  
 Required components:  
 F17435\_HEKLA-G2-C

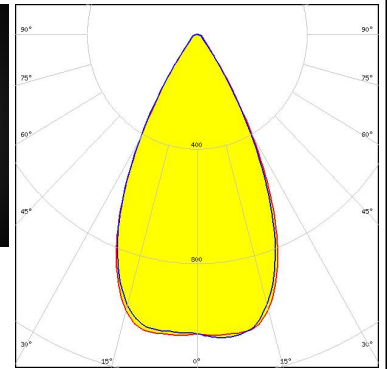
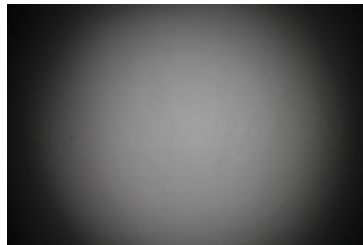

### TRIDONIC

LED SLE G7 LES09  
 FWHM / FWTM 55.0° / 78.0°  
 Efficiency 92 %  
 Peak intensity 1.1 cd/m  
 LEDs/each optic 1  
 Light colour White  
 Required components:  
 F17435\_HEKLA-G2-C

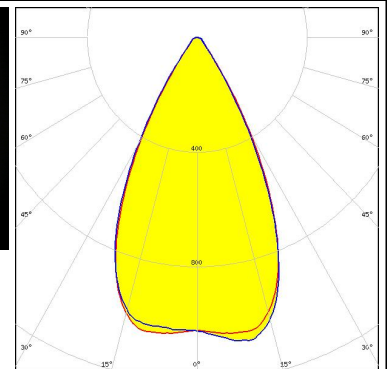
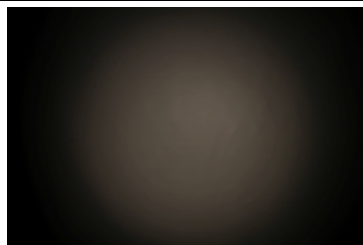

#### OPTICAL RESULTS (SIMULATED):

##### OSRAM

Opto Semiconductors

LED	Soleriq S15
FWHM / FWTM	56.0° / 84.0°
Efficiency	89 %
Peak intensity	1 cd/lm
LEDs/each optic	1
Light colour	White
Required components:	
	F17438_HEKLA-G2-I

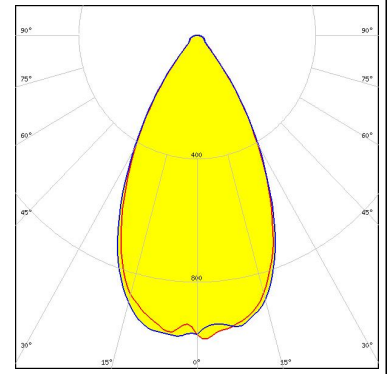

### GENERAL INFORMATION:

NOTE: The typical beam angle will be changed by different color, chip size and chip position tolerance. The typical total beam angle is the full angle measured where the luminous intensity is half of the peak value.

Due to use of high power COB's with this product, special attention to proper thermal design is highly recommended. LEDiL has no liability for direct, indirect or consecutive damages arising from the LEDiL products being used outside of the recommended temperature range.

### MATERIALS:

As part of our continuous research and improvement processes, and to ensure the best possible quality and availability of our products, LEDiL reserves the right to change material grades without notice.

### PRODUCT DATA USER AGREEMENT AND DISCLAIMER:

The measured data in the provided downloadable LEDiL Product Datasheets and Mechanical 2D-Drawings is rounded and provided as reference for planning. LEDiL Oy's optical specifications have been verified by conducting performance testing of the products in accordance with the company's quality system. The reported data are averaged results of multiple measurements with typical variation. LEDiL Oy reserves the right to without prior notification make changes and improvements to its products.

LEDiL Oy assumes neither warranty, nor guarantee nor any other liability of any kind for the contents and correctness of the provided data. The provided data has been generated with highest diligence but the provided data may in reality not represent the complete possible variation range of all intrinsic parameters. Therefore, in certain cases a deviation from the provided data could occur.

LEDiL Oy reserves the right to undertake technical changes of its products without further notification which could lead to changes in the provided data. LEDiL Oy assumes no liability of any kind for the possible deviation from any provided data or any other damage resulting from the usage of the provided data.

The user agrees to this disclaimer and user agreement with the download or usage of the provided files.

#### LEDiL Oy

Joensuunkatu 13  
FI-24240 SALO  
Finland

#### LEDiL Inc.

228 West Page Street  
Suite D  
Sycamore IL 60178  
USA

#### Ledil Optics Technology (Shenzhen) Co., Ltd.

# 405 , Block B  
Casic Motor Building  
Shenzhen 518057  
P.R.CHINA

#### Local sales and technical support

[www.ledil.com/  
where\\_to\\_buy](http://www.ledil.com/where_to_buy)

#### Shipping locations

Salo, Finland  
Hong Kong, China

#### Distribution Partners

[www.ledil.com/  
where\\_to\\_buy](http://www.ledil.com/where_to_buy)