

Data sheet

11192.4

PKB 130/9/5,00-BL DG

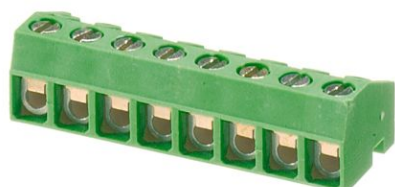

M2.6

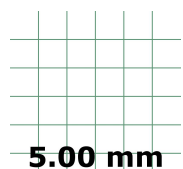
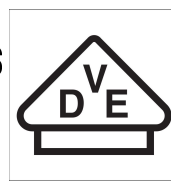

5.00 mm



Female socket block, Wire protection, No. of poles: 9, Width: 45 mm, Colour: Dark grey

Business data

Connector version	Free connector
Packaging unit	50
Quantity unit	PC
Packaging type	Carton
Type of banding	Without
Weight per piece (not including packaging)	7.83 g
Weight per piece (including packaging)	9.03 g
Unit of weight	G
Customs number	85366930
Country of origin	TN
Prio-Article	11192.1

11192.4

PKB 130/9/5,00-BL DG

Technical data

Dimensions

Length	10.8 mm
Width	45 mm
Width left	2.5 mm
Width right	2.5 mm
Height	13.5 mm
Pitch	5 mm

Ratings

Rated voltage	250 V
Rated current	7 A
Rated cross-section	1.5 mm ²
Rated impulse voltage	4 kV
Overvoltage category	III
Contamination degree	3

Technical data

Connection data

Connection principle	Wire protection
Angle of wire connection/contact	0°/180° (horizontal)
Number of plug-in rows	1
No. of poles	9
Contact version	Female connector
Wire cross-section single-core (rigid) / stranded, min.	0.14 mm ²
Wire cross-section single core (rigid)/stranded, max.	2.5 mm ²
Wire cross-section stranded, min.	0.14 mm ²
Wire cross-section stranded, max.	1.5 mm ²
Wire cross-section stranded with wire-end ferrules, min.	0.14 mm ²
Wire cross-section stranded with wire-end ferrules, max.	1.5 mm ²
Wire cross-section AWG, min.	22
Wire cross-section AWG, max.	14
Stripping length	6 mm
Screw threading	M 2,6
Torque	0.4 Nm

Materials

Insulation housing	Polyamide 6.6
Flammability class UL 94	V-0
Working temperature, min.	-30 °C
Working temperature, max.	105 °C
Clamping element	Brass
Contact spring	Copper alloy
Screws	Steel

11192.4

PKB 130/9/5,00-BL DG

Technical data

Further technical data

Storage temperature, min.	-40 °C
Storage temperature, max.	105 °C
Insulation resistance	1*10 ¹³ Ohm x cm
Creepage-current resistance	CTI 600
Glow wire flammability index GWFI	GWFI 850
GWFI after-glow time	30 Sek.
Glow wire ignition temperature GWIT	GWIT 775 °C
GWIT exposure time	5 Sek.
Connection cycles, in compliance with standard	5
Plug-in cycles acc. to standard	100

Print

Colour	Dark grey
--------	-----------

Environmental Product Compliance

REACH Conform	No
REACH Reference date	2022-01-17
REACH Candidate Substance Note	No
REACH CAS 1 Substance	LEAD
REACH CAS 1 Percent minimal	0.1 %
REACH CAS 1 Percent maximum	4 %
REACH CAS 1 Number	7439-92-1
RoHS Conform	yes
RoHS Exception rule	6c

11192.4

PKB 130/9/5,00-BL DG

Approvals

cUL Recognized

cUL approval	CSA 22.2 No.158
cUL Usegroup B: rated voltage	300 V
cUL Usegroup B: rated current	8 A
cUL Usegroup C: rated voltage	150 V
cUL Usegroup C: rated current	8 A
cUL Usegroup D: rated voltage	300 V
cUL Usegroup D: rated current	8 A
cUL wire cross-section single-core (rigid) AWG, min.	22
cUL wire cross-section single-core (rigid) AWG, max.	14
cUL wire cross-section stranded AWG, min.	22
cUL wire cross-section stranded AWG, max.	14
cUL torque	0.45 Nm
cUL wire material	Cu
cUL Recognized	yes

11192.4

PKB 130/9/5,00-BL DG

Approvals

UL Recognized

UL approval	UL 1059
UL Usegroup B: rated voltage	300 V
UL Usegroup B: rated current	8 A
UL Usegroup C: rated voltage	150 V
UL Usegroup C: rated current	8 A
UL Usegroup D: rated voltage	300 V
UL Usegroup D: rated current	8 A
UL wire cross-section single-core (rigid) AWG, min.	22
UL wire cross-section single-core (rigid) AWG, max.	14
UL wire cross-section stranded AWG, min.	22
UL wire cross-section stranded AWG, max.	14
UL torque	4 Lb In
UL wire material	Cu
UL factory wiring	yes
UL field wiring	yes
UL Recognized	yes

Approvals

VDE approval

VDE approval	DIN EN 61984
VDE approval granted	yes
VDE rated voltage	250 V
VDE rated current	7 A
VDE rated current wire cross-section rigid, min.	5 A
VDE rated current wire cross-section rigid, max.	7 A
VDE rated current wire cross-section stranded, min.	5 A
VDE rated current wire cross-section stranded, max.	7 A
VDE rated impulse voltage	4 kV
VDE wire cross-section rigid, min.	0.5 mm ²
VDE wire cross-section rigid, max.	2.5 mm ²
VDE wire cross-section stranded, min.	0.5 mm ²
VDE wire cross-section stranded, max.	1.5 mm ²
VDE screw threading	M 2,6
VDE torque	0.4 Nm
VDE overvoltage category	III
VDE contamination degree	3

11192.4

PKB 130/9/5,00-BL DG

Media

M2.6

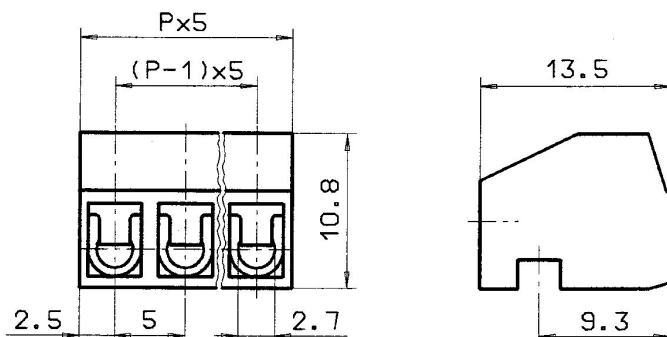
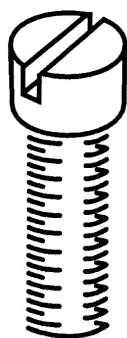

CRA[®] US

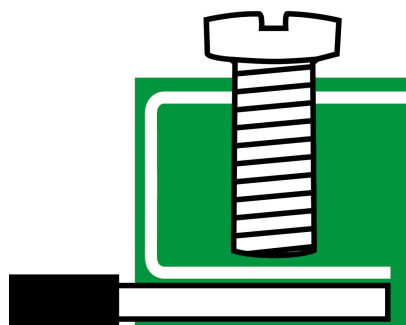
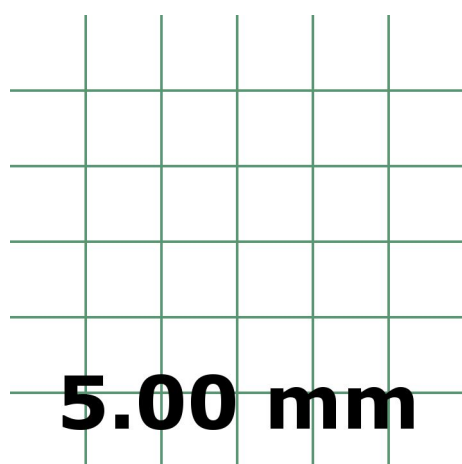

Data sheet

11192.4

PKB 130/9/5,00-BL DG



Accessories
