

400U SERIES ROCKER SWITCH

- ANTI-VANDAL SWITCHES
- DETECTOR SWITCHES
- DIP SWITCHES
- KEYLOCK SWITCHES
- NAVIGATION SWITCHES
- PUSHBUTTON SWITCHES
- ROCKER SWITCHES**
- ROTARY SWITCHES
- SLIDE SWITCHES
- SNAP ACTION SWITCHES
- TACTILE SWITCHES
- TOGGLE SWITCHES
- CAP OPTIONS

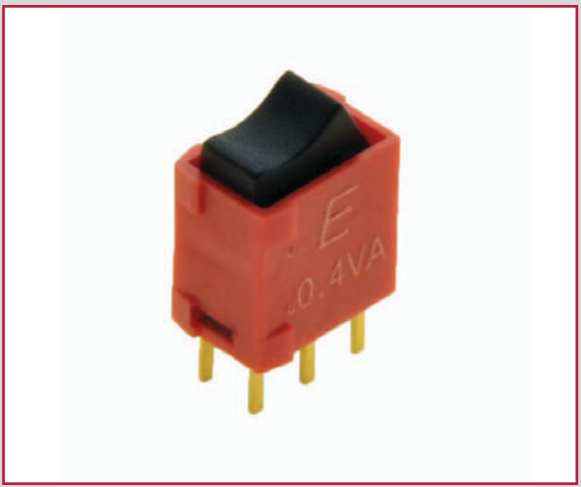

APPLICATIONS / MARKETS

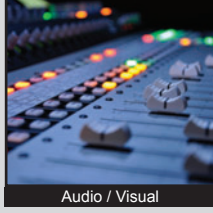

Audio / Visual



Consumer Electronics



Vending Machines



Kiosks



Instrumentation



Medical Equipment

RoHS

SPECIFICATIONS

Electrical Rating: 0.4VA @ 20V Max (AC or DC)
Life Cycles: 50,000 Cycles
Contact Resistance: 100mΩ initial
Insulation Resistance: 500 MΩ Min. @ 500VDC
Dielectric Strength: 500VAC
Operating/Storage Temperature: -30°C to 85°C

FEATURES & BENEFITS

- Ultra-miniature in size
- Lever or rocker actuator options
- Multiple termination options
- Multiple actuator colors
- Double pole

PART NUMBER CONFIGURATOR

Series	Circuit	Function	Actuator	Actuator Color	Terminal	Contact Material	Seal
<input type="text" value="4"/> <input type="text" value="0"/> <input type="text" value="0"/> <input type="text" value="U"/>	<input type="text" value="D"/> <input type="text" value="P"/>	<input type="text" value="1"/>	<input type="text" value="R"/> <input type="text" value="1"/>	<input type="text" value="B"/> <input type="text" value="L"/> <input type="text" value="K"/>	<input type="text" value="M"/> <input type="text" value="2"/>	<input type="text" value="R"/>	<input type="text" value="E"/>
400U	DP - Double Pole	1 - ON-NONE-ON	R1 - Rocker L1 - Lever	BLK - Black RED - Red WHT - White	M2 - PC thru-hole M6 - Right Angle, PC thru-hole M7 - Vertical right angle, PC thru-hole	R - Gold	E - Epoxy

Specifications subject to change without notice



E-SWITCH®

www.e-switch.com

800.867.2717

400U SERIES ROCKER SWITCH

M2 TERMINATION

Rocker Actuator

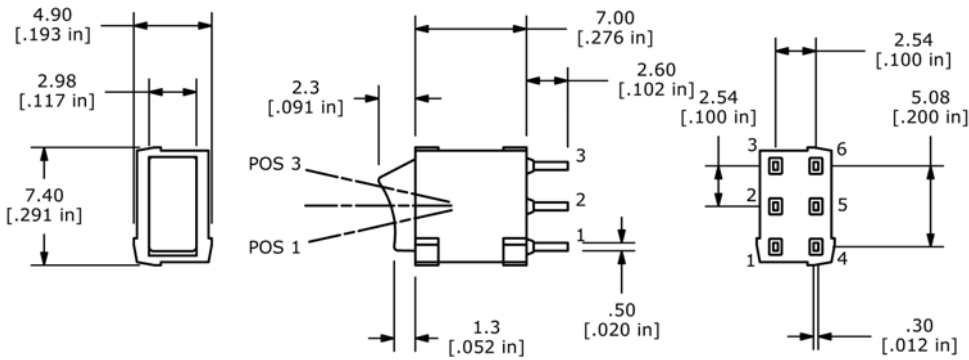

Lever Actuator

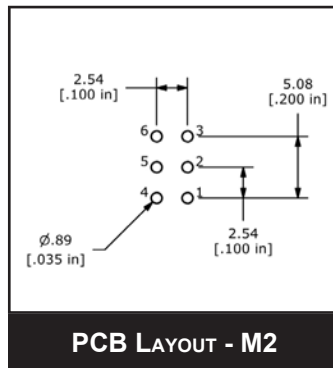
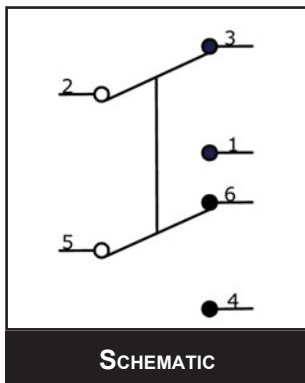
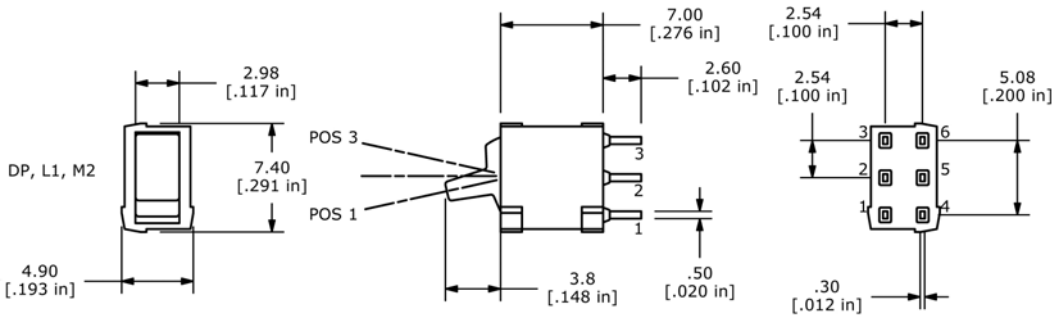

SWITCH FUNCTION		
POS. 1	POS. 2	POS. 3
ON	NONE	ON
5-6; 2-3	NONE	5-4; 2-1



ANTI-VANDAL SWITCHES
 DETECTOR SWITCHES
 DIP SWITCHES
 KEYLOCK SWITCHES
 NAVIGATION SWITCHES
 PUSHBUTTON SWITCHES
ROCKER SWITCHES
 ROTARY SWITCHES
 SLIDE SWITCHES
 SNAP ACTION SWITCHES
 TACTILE SWITCHES
 TOGGLE SWITCHES
 CAP OPTIONS

400U SERIES ROCKER SWITCH

M6 TERMINATION

Rocker Actuator

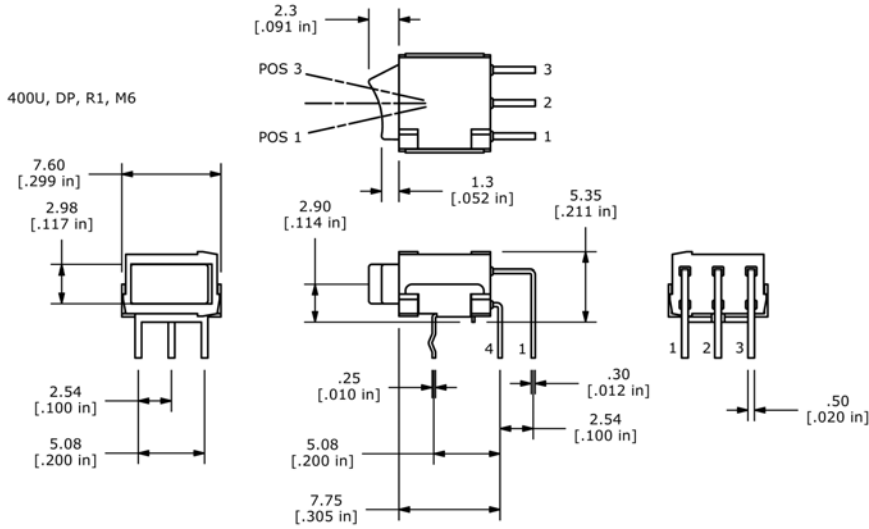

Lever Actuator

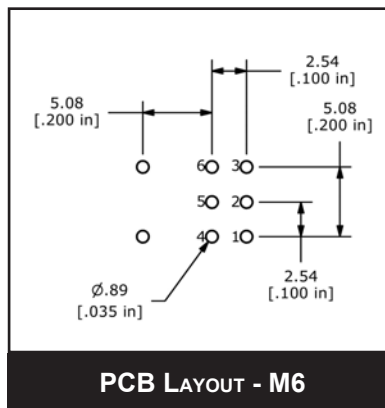
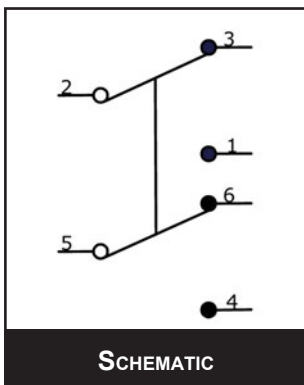
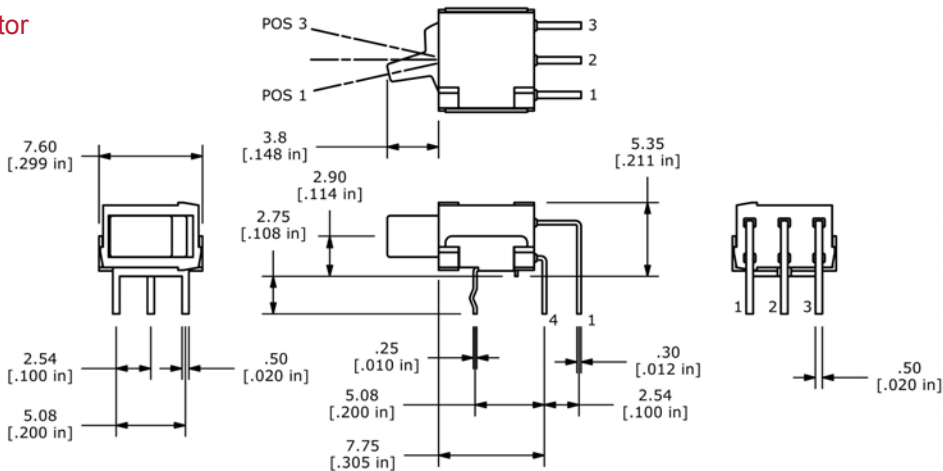

SWITCH FUNCTION		
POS. 1	POS. 2	POS. 3
ON	NONE	ON
5-6; 2-3	NONE	5-4; 2-1



400U SERIES ROCKER SWITCH

M7 TERMINATION

Rocker Actuator

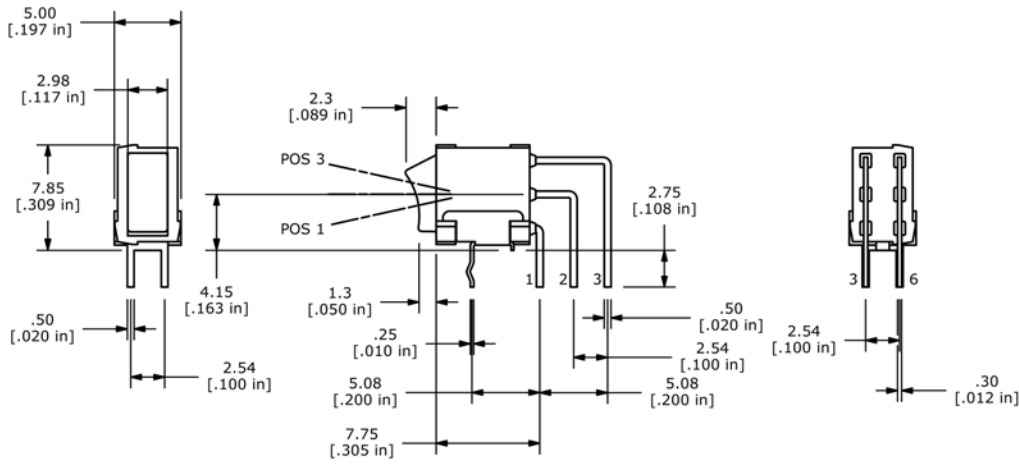

Lever Actuator

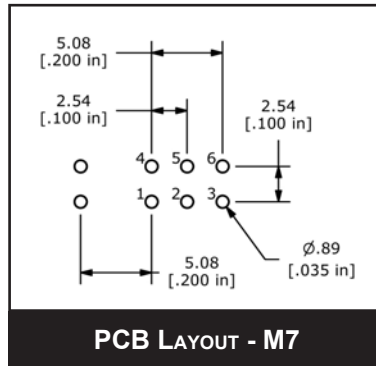
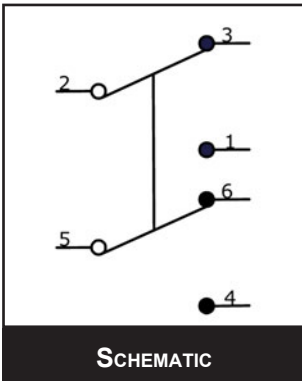
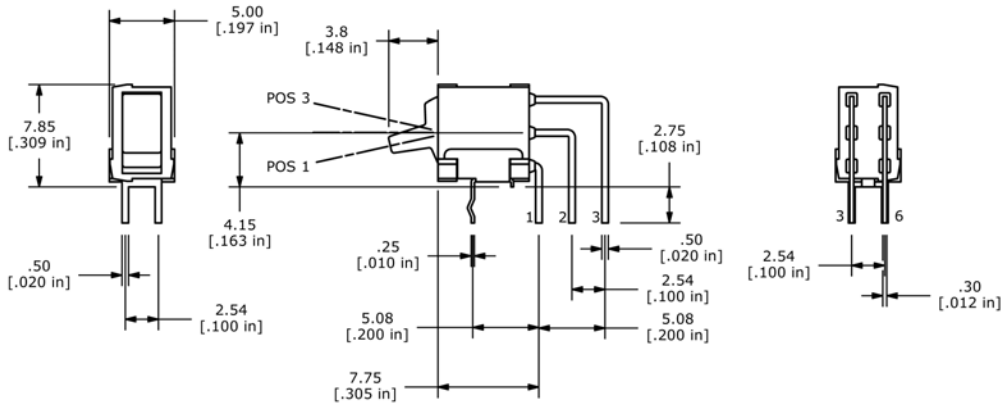

SWITCH FUNCTION		
POS. 1	POS. 2	POS. 3
ON	NONE	ON
5-6; 2-3	NONE	5-4; 2-1

