

ITEM	Q'TY	PART NUMBER	PART DESCRIPTION
1	1	FLPV-XX	Flexible Light Pipe Adapter, Vertical, w/LED
2	1	FLP5-XX.X	Flexible Light-Pipe Lens Cap Assembly, 7mm Round

REV.	DESCRIPTION	DATE	APPROVED
A	Engineering Release.	07/14/08	M. C.
B	3UWC-0.6K-F Changed to 3UWC1.035C-F	04/03/12	T. Y.
C	Updated Table For Length "L"	11/16/12	T. Y.

**NOTE: FLPV-XXX ADAPTER SHIPPED NON-ASSEMBLED**

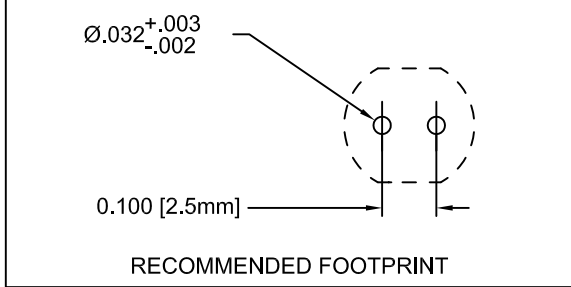
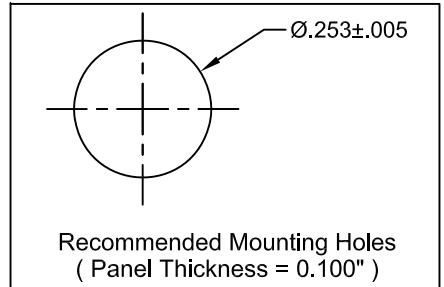
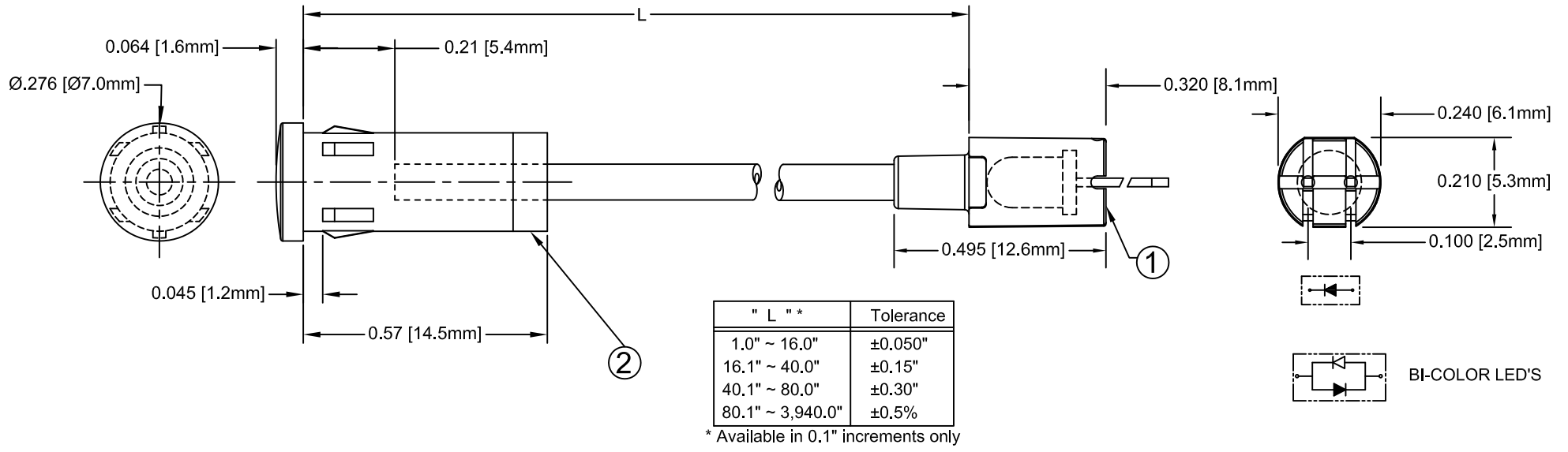

SHORT LEAD CATHODE	LED PART NO.	LONG LEAD CATHODE
RED	3xBCC-F	GREEN
YELLOW	3xBCC-Y/G-F	GREEN
RED	3xBCC-R/Y-F	YELLOW
AMBER	3xBCC-A/G-F	GREEN

**ABSOLUTE MAXIMUM RATINGS (Ta=25°C)**



REVERSE VOLTAGE \_\_\_\_\_ 5V  
 REVERSE CURRENT \_\_\_\_\_ 100uA  
 OPERATING TEMPERATURE RANGE \_\_\_\_\_ -25° C – 85° C  
 STORAGE TEMPERATURE \_\_\_\_\_ -30° C – 100° C  
 LEAD SOLDERING TEMPERATURE(1/16" FROM BODY) \_\_\_\_\_ 260° C FOR 5 SECONDS

STANDARD TOLERANCE (UNLESS OTHERWISE SPECIFIED)		<b>BIVAR</b> <sup>®</sup> 4 THOMAS, IRVINE, CA. 92618 TEL: (949) 951-8808 FAX: (949) 951-3974	
DECIMALS	ANGULAR		
.X ±.1	X° ± 1°	<b>TITLE: FLEXIBLE LIGHT-PIPE ASSY VERTICAL, 7mm LENS CAP W/LED</b> <b>PART NO: FLP5VX.X-XX</b> <b>REVISION: C</b>	
.XX ±.02			
.XXX ±.010			
DESIGNED: <b>Raffy Paje</b>	DATE: <b>07/14/08</b>	CAGE CODE : <b>32559</b>	SHEET # <b>1 OF 3</b>
CHECKED: <b>T. Yin</b>	DATE: <b>07/14/08</b>	CAD GENERATED DOCUMENT, DO NOT MEASURE DRAWING.	

REV.	DESCRIPTION	DATE	APPROVED
	SEE SHEET #1		



FLP5VX.X-XX Part No.	LED Part No.	Chip			Lens Appearance	Absolute Max. Ratings				Electro-Optical Data @ 20mA			Viewing Angle 2 $\theta$ 1/2 (Deg)
		Material	Peak Wave Length $\lambda p$ (nm)	Emitted Color		$\Delta\lambda$ (nm)	Pd (mW)	If (mA)	Peak If(mA)	Vf (V)		Iv (mcd)	
										TYP	MAX	TYP	
FLP5VX.X-SG	3SGC-F	GaP/GaP	568	SUPER GREEN	WATER CLEAR	30	80	30	150	2.1	2.8	50	20
FLP5VX.X-SY	3SYC-F	GaAsP/GaP	590	SUPER YELLOW	WATER CLEAR	35	85	30	150	2.0	2.8	50	20
FLP5VX.X-SA	3SAC-F	AlGaInP	605	SUPER AMBER	WATER CLEAR	17	100	30	150	1.8	2.4	300	20
FLP5VX.X-SR	3SRC-F	GaAlAs/GaAs	645	SUPER RED	WATER CLEAR	20	70	30	150	1.7	2.4	60	20

FLP5VX.X-XX PART NO.	LED Part No.	Chip			Lens Appearance	Absolute Max. Ratings				Electro-Optical Data @ 20mA			Viewing Angle 2 $\theta$ 1/2 (Deg)
		Material	Peak Wave Length $\lambda p$ (nm)	Emitted Color		$\Delta\lambda$ (nm)	Pd (mW)	If (mA)	Peak If(mA)	Vf (V)		Iv (mcd)	
										Typ.	Max.	Typ.	
FLP5VX.X-UBW.6K	3UBWC-0.6K-F	GaN/SiC	470	BLUE	WATER CLEAR	65	150	25	70	4.0	4.5	400	20
FLP5VX.X-UT	3UTC-F	GaN/SiC	500	TURQUOISE	WATER CLEAR	30	70	30	150	3.5	4.0	800	20
FLP5VX.X-UG	3UGC-F	AlGaInP	570	GREEN	WATER CLEAR	30	100	30	150	2.1	2.4	200	20
FLP5VX.X-SUG	3SUGC-F	AlGaInP	570	GREEN	WATER CLEAR	30	100	30	150	2.1	2.4	300	20
FLP5VX.X-UY	3UYC-F	AlGaInP	590	YELLOW	WATER CLEAR	35	85	30	150	2.0	2.4	300	20
FLP5VX.X-SUY	3SUYC-F	AlGaInP	590	YELLOW	WATER CLEAR	35	85	30	150	2.0	2.4	400	20
FLP5VX.X-UJY	3UJYC-F	AlGaInP	590	YELLOW	WATER CLEAR	35	85	30	150	2.0	2.4	600	20
FLP5VX.X-UO	3UOC-F	AlGaInP	625	ORANGE	WATER CLEAR	20	100	30	150	1.8	2.4	300	20
FLP5VX.X-SUO	3SUOC-F	AlGaInP	625	ORANGE	WATER CLEAR	20	100	30	150	1.8	2.4	400	20
FLP5VX.X-UR	3URC-F	GaAlAs/GaAs	645	RED	WATER CLEAR	20	60	30	150	1.7	2.4	200	20
FLP5VX.X-SUR	3SURC-F	AlGaInP	640	RED	WATER CLEAR	20	70	30	150	1.8	2.4	200	20
FLP5VX.X-UW.6K	3UWC1.035C-F	InGaNSapphire	X=30 Y=31	WHITE	WATER CLEAR	-	70	30	100	3.4	3.8	1000	35

STANDARD TOLERANCE ( UNLESS OTHERWISE SPECIFIED )		 <b>BIVAR</b> <sup>®</sup> 4 THOMAS, IRVINE, CA. 92618 TEL: (949) 951-8808 FAX: (949) 951-3974	
DECIMALS	ANGULAR		
		TITLE: FLEXIBLE LIGHT-PIPE ASSY VERTICAL, 7mm LENS CAP W/LED	
		DESIGNED: <b>Raffy Paje</b>	DATE: <b>07/14/08</b>
CHECKED: <b>T. Yin</b>	DATE: <b>07/14/08</b>	CAGE CODE : <b>32559</b>	SHEET # <b>2 OF 3</b>
CAD GENERATED DOCUMENT, DO NOT MEASURE DRAWING.			

REV.	DESCRIPTION	DATE	APPROVED
	SEE SHEET #1		

FLP5VX.X-XX Part No.	LED Part No.	Chip			Lens Appearance	Absolute Max. Ratings				Electro-Optical Data @ 20mA			Viewing Angle 2 $\theta$ 1/2 (Deg)
		Material	Peak Wave Length $\lambda_p$ (nm)	Emitted Color		$\Delta\lambda$ (nm)	Pd (mW)	If (mA)	Peak If(mA)	Vf (V)		Iv (mcd)	
										TYP	MAX	TYP	
FLP5VX.X-BC	3BCC-F	GaAsP/GaP	625	HE RED	WATER CLEAR	35	80	30	150	2.0	2.8	8.0	40
		GaP/GaP	568	GREEN		30	80	30	150	2.1	2.8	8.0	
FLP5VX.X-BC-Y/G	3BCC-Y/G-F	GaAsP/GaP	590	YELLOW	WATER CLEAR	35	80	30	150	2.0	2.8	6.0	40
		GaP/GaP	568	GREEN		30	80	30	150	2.1	2.8	8.0	
FLP5VX.X-BC-R/Y	3BCC-R/Y-F	GaAsP/GaP	590	YELLOW	WATER CLEAR	35	80	30	150	2.0	2.8	6.0	40
		GaAsP/GaP	625	HE RED		30	80	30	150	2.0	2.8	8.0	
FLP5VX.X-BC-A/G	3BCC-A/G-F	GaAsP/GaP	605	AMBER	WATER CLEAR	35	80	30	150	2.0	2.8	6.0	40
		GaP/GaP	568	GREEN		30	80	30	150	2.0	2.8	8.0	
FLP5VX.X-SBC	3SBCC-F	GaAlAs/GaAs	645	SUPER RED	WATER CLEAR	20	70	30	150	1.7	2.4	100	20
		GaP/GaP	568	HE GREEN		30	80	30	150	2.1	2.8	60	
FLP5VX.X-SBC-Y/G	3SBCC-Y/G-F	AlGalnP	590	SUPER YELLOW	WATER CLEAR	35	85	30	150	2.0	2.4	20	20
		GaP/GaP	568	HE GREEN		30	80	30	150	2.1	2.8	15	
FLP5VX.X-SBC-R/Y	3SBCC-R/Y-F	GaAlAs/GaAs	645	SUPER RED	WATER CLEAR	20	70	30	150	1.7	2.4	100	20
		AlGalnP	590	SUPER YELLOW		35	85	30	150	2.0	2.4	300	

STANDARD TOLERANCE ( UNLESS OTHERWISE SPECIFIED ) DECIMALS                      ANGULAR		 <b>BIVAR</b> <sup>®</sup> 4 THOMAS, IRVINE, CA. 92618 TEL: (949) 951-8808    FAX: (949) 951-3974	
			
DESIGNED: <b>Raffy Paje</b>	DATE: <b>07/14/08</b>	<b>TITLE: FLEXIBLE LIGHT-PIPE ASSY VERTICAL, 7mm LENS CAP W/LED</b>	
CHECKED: <b>T. Yin</b>	DATE: <b>07/14/08</b>	<b>PART NO:</b> FLP5VX.X-XX	<b>REVISION:</b> C
		<b>CAGE CODE :</b> 32559	<b>SHEET #</b> 3 <b>OF</b> 3
CAD GENERATED DOCUMENT, DO NOT MEASURE DRAWING.			