



PrismaSeT G

Catalog 2022

Wall-mounted
and floor-standing enclosures
for Electrical Distribution up to 630 A



se.com

Life Is On

Schneider
Electric







Table of contents

Index Catalog number index
> p. A-2



Overview Presentation > p. B-2
PrismaSeT G - Reliable, Easily connected > p. B-4
Wireless Sensor for Early Detection of Overheating Cables > p. B-5

Functional system

Functional units > p. C-1	Circuit breakers > p. C-3  ComPacT NSX100/630	Switch-disconnect. > p. C-17  ComPacT INS-INV250/630	Manual srce. changeover system > p. C-21  Circuit breaker ComPacT NSX100/250 Switch-discon. ComPacT INS-INV250	Fusegear > p. C-26  FuPacT GS FuPacT ISFT/ISFT-N
-------------------------------------	---	--	---	---

Accessories	 Other modular devices switchboard lighting	 Front plates, rails, slotted mounting	 Finishing parts labels	 Partitioning Cable running
--------------------	---	--	--	---





Linery distribution and connections systems

Linery > p. D-1	Panorama of the solution > p. D-2	Power busbars > p. D-4  Linery BW insulated busbars	 Linery BS rear flat busbars	 Linery BS multi-stage busbars
---------------------------	---	--	--	---

Enclosures

IP30, IP4X enclosures presentation > p. E-1	 Wall-mounted and Floor-standing enclosures	 Combinations	 Installation lifting accessories Accessories Gland plates Spare-parts	 Dimensions
---	--	--	--	--

Pack 160 enclosures/Pack 250

Pack 160 enclosures presentation > p. F-1	 Wall-mounted enclosures	 Kilowatt-hour meters Accessories	 Accessories, Spare-parts	 Distribution and connection in Pack enclosures with Linery	 Dimensions
---	---	---	---	--	--

Additional information

Electrical characteristics > p. G-2	Practical Information > p. G-9	Standards > p. G-12	Enclosure characteristics > p. G-18
---	--	-------------------------------	---

PrismaSeT G

Index
A-2

A

PrismaSeT G pack 160-250 enclosures
> p. B-10

PrismaSeT P cubicles
> p. B-11

Overview
B-2

B

Functional system
C-1

C

Modular devices
> p. C-31



Switchb. incomer
Outgoers

Other devices
> p. C-33



Kilowatt-hour meters
Industrial control
Human-switchboard interface



Installation accessories



Connections blocks
Power supply blocks
Linergy BW and devices connection



Management of the internal temperature

Accessories

Linergy distribution and connections systems

D-1

D

Quick distribution block > p. D-10



Linergy DX, Linergy DP,
Linergy DS, Linergy FM
distribution blocks



Linergy FH
horizontal
comb busbars



Linergy TB, Linergy TR,
Linergy TA
terminal blocks

IP55 enclosures
presentation
> p. E-20



IP55
enclosures



Combinations



Installation accessories
Gland plates
Partial door
Side panels
Door accessories
Spare-parts

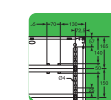

Dimensions

Enclosures

E-1

E

Pack 160 enclosures/Pack 250

F-1

F

Pack 250
presentation
> p. F-12



Wall-
mounted
Floor stand.
enclos.



Installation /
lifting
accessories



Gland plates
Cable running
Door accessories



Linergy distribution
and accessories

Thermal
characteristics
> p. G-26

Additional
information

G-1

G

Catalog number index

Com. no.	Page	Com. no.	Page	Com. no.	Page	Com. no.	Page
LVS01...		LVS01261	E-16	LVS03125	C-30	LVS03221	C-4, C-6, C-8, C-31, C-32, C-35, C-52, F-7
LVS01005	C-51	LVS01264	F-8	LVS03126	C-29	LVS03222	C-10, C-12, C-52
LVS01006	C-51	LVS01265	F-8	LVS03152	C-34, F-5	LVS03223	C-32, C-50
LVS01007	C-51	LVS03...		LVS03155	C-34	LVS03231	C-17
LVS01008	C-51	LVS03001	B-32, C-31, C-32, C-33, C-35, C-52	LVS03156	C-34	LVS03232	B-32, C-5, C-7
LVS01017	E-15	LVS03002	C-4, C-6, C-8, C-10, C-12, C-18, C-27, C-31, C-35, C-52	LVS03158	C-34	LVS03234	C-7
LVS01018	E-14	LVS03003	C-18, C-36, C-52, F-4	LVS03160	C-34	LVS03235	C-22
LVS01020	F-8	LVS03004	B-32, C-35, C-36, C-52, F-4	LVS03164	C-53	LVS03239	C-17
LVS01025	E-23, E-24, E-30	LVS03005	C-53	LVS03165	C-53	LVS03241	C-10
LVS01028	E-16	LVS03006	C-31, C-32, C-33, C-35, C-52	LVS03166	C-53	LVS03243	C-6, C-8
LVS01029	E-16	LVS03007	C-4, C-31, C-35, C-36, C-52	LVS03170	C-52	LVS03244	C-12
LVS01030	E-16	LVS03008	F-4	LVS03171	C-36, C-52	LV429285	C-12
LVS01032	E-14	LVS03010	C-31, C-32, C-33, C-35, C-52	LVS03172	C-36, C-52	LVS03245	C-21
LVS01033	E-8, E-15	LVS03011	C-4, C-6, C-8, C-10, C-18, C-31, C-35, C-36, C-52	LVS03173	C-52	LVS03247	C-22
LVS01034	E-8, E-15	LVS03018	F-4	LVS03175	C-36, C-52	LVS03248	C-18
LVS01035	E-8, E-15	LVS03020	C-3	LVS03176	C-52	LVS03249	C-10, C-12, C-52
LVS01036	E-14	LVS03021	C-3	LVS03177	C-52	LVS03251	C-18
LVS01039	E-15	LVS03030	B-32, C-5, C-17, C-19	LVS03178	C-52	LVS03253	C-6, C-8
LVS01040	E-8, E-15	LVS03031	C-7, C-11	LVS03180	C-53	LVS03260	F-13
LVS01041	E-8, E-15	LVS03032	C-7, C-18	LVS03181	C-53	LVS03261	F-13
LVS01042	E-8, E-15	LVS03033	C-5, C-9	LVS03182	C-53	LVS03264	F-13
LVS01043	E-8, E-15	LVS03040	C-6, C-10, C-18	LVS03183	C-53	LVS03267	F-14
LVS01044	E-8, E-15	LVS03041	C-8, C-12	LVS03185	C-53	LVS03271	C-19
LVS01045	E-8, E-15	LVS03043	C-21, C-22	LVS03186	C-53	LVS03274	C-20
LVS01046	E-8, E-15	LVS03050	C-6, C-10, C-18	LVS03187	C-53	LVS03275	C-14
LVS01047	E-8, E-15	LVS03051	C-8	LVS03194	C-53	LVS03281	C-20
LVS01050	E-16	LVS03070	C-13, C-19	LVS03195	C-53	LVS03287	C-19
LVS01051	E-16	LVS03073	C-14, C-15, C-20	LVS03196	C-53	LVS03289	C-13
LVS01052	E-16	LVS03074	C-14, C-15	LVS03197	C-53	LVS03290	C-7
LVS01053	E-16	LVS03080	C-16, C-20	LVS03198	C-53	LVS03292	C-9, C-11
LVS01063	E-16	LVS03117	C-26, C-27	LVS03199	C-53	LV429285	C-11
LVS01064	E-16	LVS03118	C-26, C-27	LVS03202	C-33, C-50	LVS03293	C-10
LVS01065	E-16	LVS03120	C-29	LVS03203	B-32, C-32, C-33, C-35, C-50	LVS03294	C-5
LVS01066	E-16	LVS03121	C-28	LVS03204	B-32, C-31, C-32, C-50	LVS03295	C-9, C-11
LVS01067	E-16	LVS03121	C-29	LVS03205	C-4, C-31, C-35, C-50	LVS03296	C-13
LVS01069	E-16	LVS03122	C-29	LVS03206	C-24	LVS03297	C-15
LVS01070	E-15	LVS03123	C-30	LVS03207	C-25	LV429285	C-15
LVS01125	E-15	LVS03124	C-28	LVS03208	C-24	LVS03299	C-16
LVS01201	D-4	LVS03125	C-30	LVS03209	C-25	LVS03301	C-7
LVS01202	D-17	LVS03126	C-29	LVS03213	C-32, C-33, C-35, C-50	LVS03308	C-26, C-27
LVS01210	D-4	LVS03127	C-28	LVS03214	C-4, C-31, C-32, C-50	LVS03309	C-26, C-27
LVS01211	D-4	LVS03128	C-29	LVS03216	C-32, C-33, C-35, C-50	LVS03318	C-29
LVS01218	E-15, F-17	LVS03129	C-29	LVS03217	C-31, C-32, C-50	LVS03320	C-29
LVS01247	E-30	LVS03130	C-29	LVS03218	C-4, C-31, C-35, C-50	LVS03321	C-29
LVS01248	E-30	LVS03131	C-29	LVS03220	C-4, C-6, C-8, C-31, C-32, C-35, C-52, F-7	LVS03326	C-28
LVS01249	E-30	LVS03132	C-30			LVS03327	C-30
LVS01254	E-16	LVS03133	C-30			LVS03328	C-28
LVS01257	E-16	LVS03134	C-30			LVS03329	C-30
LVS01258	E-16						
LVS01259	E-16						
LVS01260	F-4						

Com. no.	Page	Com. no.	Page	Com. no.	Page	Com. no.	Page
LVS03330	C-3			LVS04018	D-16, F-19	LVS04066	B-32, C-5, C-17, C-42, G-6
LVS03331	C-3	LVS03811	C-6, C-8, C-18, C-50, F-14	LVS04021	D-4, D-9		
LVS03332	C-3			LVS04024	C-45, D-7, D-9, D-16	LVS04067	B-32, C-5, C-17, C-42, G-6
LVS03333	C-3	LVS03812	C-4, C-10, C-16, C-20, C-31, C-35, C-36, C-50, F-14	LVS04026	D-16		
LVS03334	C-5, C-7			LVS04029	C-45, D-6, D-9, D-16	LVS04070	C-13, C-42, D-5, G-6
LVS03335	C-5, C-7	LVS03813	C-35, C-50, F-14			LVS04070	C-19
LVS03336	C-28			LVS04030	C-3, C-45, D-6, D-7, D-9, D-16	LVS04071	C-13, C-19, C-42, D-5, G-6
LVS03337	C-28	LVS03814	C-36, C-50, F-14			LVS04073	C-16, D-5
LVS03338	C-29	LVS03815	C-50, F-14	LVS04031	C-4, C-27, C-31, D-11		
LVS03342	B-32, C-33, C-35, C-36, C-50	LVS03816	C-50, F-14	LVS03002	C-30	LVS04074	C-14, C-15, C-16, C-20, C-43, D-5
LVS03343	C-33, C-34, C-35, C-36, C-50	LVS03817	C-34, C-50, F-14	LVS04046	F-18	LVS04073	C-20
LVS03806	F-5	LVS03813	F-14	LVS04046	F-9	LVS04075	C-16, C-44, D-7
LVS03344	C-33, C-34, C-50, F-5	LVS03851	C-5, C-17, C-28, C-50	LVS04033	C-6, C-8, C-9, C-10, C-11, C-12, C-17, C-18, D-12	LVS04076	C-13, C-42, G-6
LVS03345	C-33, C-50	LVS03853	C-13, C-19, C-35, C-50			LVS04103	D-4
LVS03352	C-33, C-35, C-36, C-50	LVS03854	C-50	LVS04034	C-5, C-7	LVS04104	D-4
LVS03353	C-33, C-35, C-50	LVS03856	C-34, C-50			LVS04107	D-4
LVS03354	C-33, C-34, C-50	LVS03859	C-34, C-50	LVS04034	C-6, C-8, C-9, C-10, C-11, C-12, C-17, C-18, D-12	LVS04108	D-4
LVS03363	C-33, C-34, C-35, C-36, C-50	LVS03861	C-50	LVS04156	F-18	LVS04111	B-33, D-4
LVS03364	C-33, C-34, C-35, C-50	LVS03890	C-50	LVS04037	C-18	LVS04112	B-33, D-4
LVS03426	C-24	LVS03891	C-48, C-50	LVS04038	D-13, F-18	LVS04113	B-33, D-4
LVS03427	C-25	LVS03892	C-48	LVS04039	C-3, C-4	LVS04114	B-33, D-4
LVS03581	C-53	LVS03894	C-48	LVS04039	D-13, F-18	LVS04116	B-33, D-4
LVS03583	C-53	LVS03895	C-48, C-50	LVS04040	D-10	LVS04117	B-33, D-4
LVS03801	B-32, C-5, C-7, C-10, C-11, C-12, C-14, C-15, C-17, C-18, C-28, C-35, C-36, C-50	LVS03900	C-38	LVS04041	F-9, F-18	LVS04118	B-33, D-4
LVS03802	B-32, C-6, C-8, C-10, C-12, C-14, C-18, C-20, C-22, C-28, C-29, C-50	LVS03901	C-38	LVS04041	D-10	LVS04119	B-33, D-4
LVS03803	B-32, C-6, C-8, C-13, C-14, C-15, C-18, C-19, C-21, C-22, C-35, C-50	LVS03902	C-38	LVS04045	C-4, C-31, D-11, F-9, F-18	LVS04121	B-33, D-4
LVS03804	C-6, C-8, C-10, C-12, C-15, C-20, C-36, C-50	LVS03903	C-38			LVS04122	B-33, D-4
LVS03805	C-14, C-36, C-50	LVS03904	C-38	LVS04046	C-4, C-31, D-11	LVS04123	B-33, D-4
LVS03806	C-18, C-34, C-36, C-50	LVS03907	C-38, C-39	LVS04047	C-4, C-31, D-11	LVS04124	B-33, D-4
LVS03808	C-50	LVS03908	C-38, C-39	LVS04052	D-8, F-18	LVS04126	B-33, D-4
LVS03809	C-28, C-29	LVS03909	C-39	LVS04053	D-8, F-18	LVS04127	B-33, D-4
		LVS03910	C-38	LVS04054	D-8	LVS04128	B-33, D-4
		LVS03911	C-38	LVS04055	D-8	LVS04129	B-33, D-4
		LVS03913	C-38			LVS04130	D-5
		LVS03914	C-38	LVS04060	B-32, C-5, C-7, C-9, C-11, C-17, C-42, D-5, G-6	LVS04145	C-44, D-5
		LVS03919	C-39			LVS04146	C-4
		LVS03923	C-39	LVS04061	C-6, C-8, C-10, C-12, C-26, C-27, C-28, C-30, C-43, D-5	LVS04145	F-9
		LVS03925	C-39			LVS04146	C-44, D-5
		LVS03928	C-38, E-11	LVS04064	C-18	LVS04147	C-44, D-5
		LVS03929	C-38			LVS04148	C-44, D-5
		LVS04...		LVS04064	C-6, C-8, D-5	LVS04149	C-4, C-31, D-11
		LVS04004	D-16, F-9, F-19	LVS04062	C-6, C-8, D-5	LVS04150	D-4
		LVS04008	D-16, F-9, F-19	LVS04064	C-6, C-8, D-5	LVS04151	C-44, D-4
		LVS04012	D-16	LVS04064	C-6, C-8, D-5	LVS04152	C-44, D-4
		LVS04014	F-19	LVS04065	C-6, C-8, C-10, C-44, D-7	LVS04156	D-12
		LVS04013	D-16			LVS04158	D-4
		LVS04014	D-16				



Catalog number index

Com. no.	Page	Com. no.	Page	Com. no.	Page	Com. no.	Page
LVS04161	D-6, D-7, F-18	LVS04234	C-46	LVS08012	F-5	LVS08136	B-33, E-6, F-13, F-14
LVS04162	D-6, D-7	LVS04235	C-46	LVS08064	F-13, F-14	LVS08137	B-33, E-6, F-13, F-14
LVS04172	F-18	LVS04239	C-47	LVS08065	F-13, F-14	LVS08138	E-6, F-13, F-14
LVS04163	D-6, D-7	LVS04243	F-9	LVS08066	F-13, F-14	LVS08172	B-33, E-6, E-8
LVS04171	D-6, D-7	LVS04243	C-47	LVS08067	F-13, F-14	LVS08173	B-33, E-6, E-8
LVS04172	D-6, D-7	LVS04255	C-46, F-9	LVS08068	F-13, F-14	LVS08174	B-33, E-6, E-8, F-14
LVS04173	D-6, D-7	LVS04256	C-46	LVS08069	F-13, F-14	LVS08175	B-33, E-6, E-8, F-14
LVS04174	D-6, D-7	LVS04257	C-46, F-9	LVS08072	F-13, F-14	LVS08176	B-33, E-6, E-8, F-14
LVS04190	C-44, D-6	LVS04263	C-47	LVS08073	F-13, F-14	LVS08177	B-33, E-6, E-8, F-14
LVS04191	C-3, C-4, C-5, C-6, C-7, C-8, C-9, C-10, C-11, C-12, C-13, C-14, C-15, C-16, C-17, C-18, C-19, C-20, C-26, C-27, C-28, C-30, C-31, D-6, F-18	LVS04264	C-47	LVS08074	F-13, F-14	LVS08178	E-6, E-8, F-14
LVS04192	C-3, C-4, C-5, C-6, C-7, C-8, C-9, C-10, C-11, C-12, C-13, C-14, C-15, C-16, C-17, C-18, C-19, C-20, C-26, C-27, C-28, C-30, C-31, D-7	LVS04265	C-46	LVS08082	F-4, F-5	LVS08179	E-6, E-8, F-14
LVS04194	D-9	LVS04266	C-46	LVS08083	F-4	LVS08182	B-33, E-6, E-8
LVS04195	D-9	LVS04267	C-46	LVS08084	F-4	LVS08183	B-33, E-6, E-8
LVS04197	C-16, D-7	LVS04330	C-41	LVS08085	F-4	LVS08184	B-33, E-6, E-8, F-14
LVS04198	C-16, D-6	LVS04331	C-34, C-41	LVS08086	F-4	LVS08185	B-33, E-6, E-8, F-14
LVS04200	D-23	LVS04332	C-34, C-41	LVS08092	F-4, F-5	LVS08186	B-33, E-6, E-8, F-14
LVS04201	B-33, D-23	LVS04333	F-5	LVS08082	F-5	LVS08187	B-33, E-6, E-8, F-14
LVS04214	B-33, D-23	LVS04335	C-41	LVS08093	F-4	LVS08188	E-6, E-8, F-14
LVS04202	D-23, F-19	LVS04336	C-41	LVS08083	F-5	LVS08197	B-33, E-6, E-8, F-14
LVS04210	F-19	LVS04742	C-45	LVS08094	F-4	LVS08198	E-6, E-8, F-14
LVS04202	D-23	LVS04743	C-45, D-16	LVS08095	F-4	LVS08202	E-6
LVS04203	D-26	LVS04746	C-45	LVS08096	F-4	LVS08203	E-6
LVS04206	C-40, C-46, F-9	LVS04751	C-45	LVS08102	B-33, E-6	LVS08204	E-6
LVS04207	C-40	LVS04752	C-45	LVS08103	B-33, E-6	LVS08212	E-6
LVS04208	C-40	LVS04753	C-45	LVS08104	B-33, E-6	LVS08213	E-6
LVS04210	D-23	LVS07...		LVS08105	B-33, E-6	LVS08214	E-6
LVS04214	B-33, D-23	LVS07051	D-9	LVS08106	B-33, E-6	LVS08215	E-6
LVS04215	B-33, D-23	LVS07052	D-9	LVS08107	B-33, E-6	LVS08222	E-6, F-13, F-14
LVS04220	B-33, C-40	LVS07053	D-9	LVS08108	E-6	LVS08223	E-6, F-13, F-14
LVS04223	C-40	LVS07931	E-13, F-8	LVS08109	E-6	LVS08224	E-6, F-13, F-14
LVS04224	C-53	LVS07932	E-13	LVS08113	E-6	LVS08225	E-6
LVS04225	C-52, F-4	LVS07933	E-13	LVS08114	E-6	LVS08232	E-6, F-13, F-14
LVS04226	B-33, C-52, F-4	LVS07938	E-13, F-8, F-17	LVS08115	E-6	LVS08233	E-6, F-13, F-14
LVS04227	C-52, F-4	LVS07940	E-13	LVS08116	E-6	LVS08234	E-6, F-13, F-14
LVS04228	D-26	LVS07941	E-13	LVS08117	E-6	LVS08235	E-6
LVS04233	C-46	LVS07942	E-13	LVS08118	E-6	LVS08242	E-6
		LVS07943	E-13	LVS08119	E-6		
		LVS07944	E-13	LVS08122	B-33, E-6		
		LVS07945	E-13	LVS08123	B-33, E-6		
		LVS07946	E-13	LVS08124	B-33, E-6, F-13, F-14		
		LVS07949	E-13	LVS08125	B-33, E-6, F-13, F-14		
		LVS07951	E-13	LVS08126	B-33, E-6, F-13, F-14		
		LVS07953	E-13	LVS08127	B-33, E-6, F-13, F-14		
		LVS07956	E-13	LVS08128	E-6, F-13, F-14		
		LVS08...		LVS08132	B-33, E-6		
		LVS08002	F-4	LVS08133	B-33, E-6		
		LVS08003	F-4	LVS08134	B-33, E-6, F-13, F-14		
		LVS08004	F-4	LVS08135	B-33, E-6, F-13, F-14		
		LVS08005	F-4				
		LVS08006	F-4				

Com. no.	Page	Com. no.	Page	Com. no.	Page	Com. no.	Page
LVS08243	E-6	LVS08330	E-23	LVS08802	E-23	LVS08878	F-6
LVS08244	E-6	LVS08332	E-23	LVS08803	F-7	LVS08879	F-6
LVS08245	E-6	LVS08333	E-23	LVS08804	E-10, F-15	LVS08880	E-15
LVS08252	E-6	LVS08334	E-23	LVS08805	E-11, F-15	LVS08882	E-9
LVS08253	E-6	LVS08335	E-23	LVS08806	E-11	LVS08884	E-15
LVS08254	E-6	LVS08336	E-23	LVS08807	E-11, F-15	LVS08885	E-9
LVS08255	E-6	LVS08337	E-23	LVS08809	E-10	LVS08886	E-7
LVS08262	E-6	LVS08339	E-23	LVS08811	E-9, E-10	LVS08887	E-7
LVS08263	E-6	LVS08340	E-23	LVS08812	E-9, E-10, F-15	LVS08888	E-7
LVS08264	E-6	LVS08342	E-23	LVS08813	E-9, E-10	LVS08889	E-7
LVS08265	E-6	LVS08343	E-23	LVS08814	E-9, E-10	LVS08893	E-7
LVS08272	E-6, E-8, F-14	LVS08344	E-23	LVS08815	E-14	LVS08898	E-26
LVS08273	E-6, E-8, F-14	LVS08345	E-23	LVS08816	E-9	LVS08899	E-26
LVS08274	E-6, E-8, F-14	LVS08346	E-23	LVS08817	E-9, F-5, F-7	LVS08900	C-51
LVS08275	E-6, E-8	LVS08347	E-23	LVS08818	E-9	LVS08903	C-51
LVS08282	E-6, E-8, F-14	LVS08349	E-23	LVS08819	E-11	LVS08904	C-51
LVS08283	E-6, E-8, F-14	LVS08352	E-23	LVS08820	E-11	LVS08905	C-51
LVS08284	E-6, E-8, F-14	LVS08353	E-23	LVS08821	F-6	LVS08906	C-51
LVS08285	E-6, E-8	LVS08354	E-23	LVS08822	F-7	LVS08908	C-51
LVS08292	E-6, E-8, F-14	LVS08355	E-23	LVS08823	F-6	LVS08910	C-34, E-11, F-8, F-17
LVS08293	E-6, E-8, F-14	LVS08356	E-23	LVS08824	E-11	LVS08911	E-11, F-5, F-8, F-17
LVS08294	E-6, E-8, F-14	LVS08357	E-23	LVS08826	E-9, E-10	LVS08913	C-51
LVS08295	E-6, E-8	LVS08359	E-23	LVS08827	E-7	LVS08914	C-51
LVS08302	E-23	LVS08364	E-28	LVS08830	E-7, F-15	LVS08915	C-51
LVS08303	E-23	LVS08369	E-28	LVS08831	E-7	LVS08916	C-51
LVS08304	E-23	LVS08371	E-23	LVS08832	E-7, F-15	LVS08917	C-51
LVS08305	E-23	LVS08371	E-23	LVS08833	E-7	LVS08918	C-51
LVS08306	E-23	LVS08372	E-23	LVS08836	E-7	LVS08934	E-29
LVS08307	E-23	LVS08374	E-27	LVS08837	E-7	LVS08935	E-29
LVS08309	E-23	LVS08376	E-27	LVS08841	E-7, F-6, F-15	LVS08936	E-29
LVS08311	E-23	LVS08381	E-24	LVS08842	E-7	LVS08939	E-29
LVS08312	E-23	LVS08382	E-24	LVS08843	E-7	LVS08961	C-51
LVS08313	E-23	LVS08381	E-24	LVS08844	E-7	LVS08963	C-51
LVS08314	E-23	LVS08383	E-24	LVS08845	E-7	LVS08964	C-33
LVS08315	E-23	LVS08383	E-24	LVS08846	E-7	LVS08965	C-33
LVS08316	E-23	LVS08384	C-41	LVS08847	E-7	LVS09...	
LVS08317	E-23	LVS08386	E-25	LVS08848	E-7	LVS09932	E-29
LVS08319	E-23	LVS08387	E-25	LVS08853	E-12	LVS09933	E-29
LVS08322	E-23	LVS08391	E-24, E-25	LVS08854	E-12	LVS09937	E-29
LVS08323	E-23	LVS08392	E-23, E-25	LVS08855	E-12	LVS09942	E-29
LVS08324	E-23	LVS08393	E-25	LVS08861	E-27, E-28	LVS09943	E-29
LVS08325	E-23	LVS08394	E-25	LVS08862	E-27	LVS09945	E-29
LVS08325	E-23	LVS08392	E-25	LVS08866	C-47	LVS09947	E-29
LVS08326	E-23	LVS08393	E-23	LVS08867	C-47, F-9	LVS09948	E-29
LVS08327	E-23	LVS08394	E-25	LVS08868	B-33, C-47	10...	
LVS08329	E-23	LVS08394	E-23	LVS08870	E-12	10405	D-21
		LVS08393	E-25	LVS08871	E-12	10545	D-21
		LVS08394	E-25	LVS08874	E-12	10546	D-21
		LVS08395	E-25	LVS08875	E-12	10547	D-21
		LVS08396	E-24	LVS08876	E-26		
		LVS08585	C-52				
		LVS08783	C-47				
		LVS08801	E-10, F-15				



Catalog number index

Com. no.	Page	Com. no.	Page
13...		A9XPCD04	D-19, D-20
13735	C-51	A9XPCM04	D-19
13736	C-51	A9XPCM04	D-20
14...		A9XPE110	D-19
14811	D-18	A9XPE210	D-19
14812	D-18	A9XPE310	D-19
14813	D-18	A9XPE410	D-19
14814	D-18	A9XPH106	D-19
14818	D-18	A9XPH112	D-19
14885	D-18	A9XPH124	D-19
19...		A9XPH157	D-19
19512	D-21	A9XPH212	D-19
19516	D-21	A9XPH224	D-19
21...		A9XPH257	D-19
21089	D-21	A9XPH312	D-19
21093	D-21	A9XPH324	D-19
21094	D-21	A9XPH357	D-19
21095	D-21	A9XPH412	D-19
21096	D-21	A9XPH424	D-19
21098	D-21	A9XPH457	D-19
21501	D-21	A9XPH512	D-19
21503	D-21	A9XPH518	D-19
21505	D-21	A9XPH524	D-19
21507	D-21	A9XPH557	D-19
31...		A9XPM212	D-20
31073	C-22	A9XPM412	D-20
31141	C-22	A9XPM512	D-20
49...		A9XPT920	D-19, D-20
49860	C-30	D...	
49861	C-30	DZ5CA005	D-25
49862	C-30	DZ5CA007	D-25
49863	C-30	DZ5CA010	D-25
49865	C-30	DZ5CA015	D-25
A...		DZ5CA025	D-25
A9N21035	D-22	DZ5CA042	D-25
A9N21036	D-22	DZ5CA062	D-25
A9N21037	D-22	DZ5CA102	D-25
A9N21038	D-22	DZ5CA162	D-25
A9N21039	D-22	DZ5CA253	D-25
A9N21040	D-22	DZ5CA352	D-25
A9N21041	D-22	DZ5CA502	D-25
A9N21042	D-22	DZ5CE005	D-25
A9N21050	D-22	DZ5CE007	D-25
A9XAH157	D-19	DZ5CE010	D-25
A9XAH257	D-19	DZ5CE015	D-25
A9XAH357	D-19	DZ5CE025	D-25
A9XAH457	D-19	DZ5CE042	D-25
A9XAH557	D-19	DZ5CE062	D-25
A9XAH657	D-19	DZ5CE102	D-25
		DZ5CE162	D-25
		DZ5CE252	D-25

Com. no.	Page	Com. no.	Page
DZ5CE352	D-25	LV429518	C-5
DZ5CE502	D-25		C-5, C-6, C-7, C-8, C-9, C-10, C-11, C-12, C-17, C-18, C-20, C-21, C-22
L...		LV429518	
LGY4193	C-13, C-14, C-15, C-20, D-6	LV429593	C-13, C-20
LGY4230	D-26	LV429594	C-13, C-20
LGY4231	D-26	LV432504	G-6
LGY112510	D-14	LV432505	G-6
LGY412548	D-14, F-9, F-19	LV432506	G-6
LGY412560	D-14, F-9, F-19	LV432507	G-6
LGYN12515	F-9	LV432591	C-16
LGY416048	D-14, F-9, F-19	LV432592	C-16
LGY412560	F-19		C-13, C-14, C-15, C-16, C-19
LGY116013	D-14	LV432593	
LGY412548	F-19		C-13, C-14, C-15, C-16, C-19
LGY416048	F-9	LV432594	
LGY125014	D-14, F-19		C-26, C-27
LGY410028	D-14, F-19	LV480756	C-29, C-30
LGYN1007	D-15, F-9, F-19	LV480811	C-30
LGYN12512	F-9	LV480812	C-30
LGY412548	D-14	LV480813	C-30
LGY412560	D-14	LV480814	C-30
LGY416048	D-14	LV480818	C-30
LGYN1007	D-14	LV480819	C-28, C-29, C-30
LGYN12512	D-14	LV480824	C-28, C-30
LGYN12515	D-14	N...	
LV426912	C-3	NSX100	F-18
LV426913	C-3	NSXm	F-18
LV429285	C-11	NSXm125	C-44
LV429306	C-7	NSXm160	C-44
LV429307	C-7	NSYCAF125	C-48
LV429358	C-21, C-22	NSYCAF125T	C-48
LV429359	C-21, C-22	NSYCAF223	C-48
LV429369	C-21	NSYCAF223T	C-48
LV429504	G-6	NSYCCOTH	C-49
LV429505	G-6	NSYCR55WU2	C-49
LV429506	G-6	NSYCR100WU2	C-49
LV429507	G-6	NSYCR 250W230VV	C-49
LV429515	C-6, C-7, C-8, C-10, C-12, C-18, C-20	NSYCVF 85M230PF	C-48
LV429516	C-6, C-7, C-8, C-10, C-12, C-18, C-20	NSYCVF 165M230PF	C-48
LV429517	C-5, C-6, C-7, C-8, C-9, C-10, C-11, C-12, C-17, C-18, C-20, C-21, C-22	NSYTRAB560	D-24
		NSYTRAB570	D-24
		NSYTRAB580	D-24
		NSYTRAB590	D-24
		NSYTRAB610	D-24
		NSYTRAB620	D-24

Com. no.	Page	Com. no.	Page
NSYTRAB630	D-24	NSYTRP23BL	D-24
NSYTRAB640	D-24	NSYTRP24	D-24
NSYTRAB690	D-24	NSYTRP24BL	D-24
NSYTRAB5100	D-24	NSYTRP24D	D-24
NSYTRAB6100	D-24	NSYTRP24DBL	D-24
NSYTRAB51100	D-24	NSYTRP26T	D-24
NSYTRAB61100	D-24	NSYTRP26TBL	D-24
NSYTRABF510	D-24	NSYTRP42	D-24
NSYTRABF520	D-24	NSYTRP42BL	D-24
NSYTRABF530	D-24	NSYTRP43	D-24
NSYTRABF540	D-24	NSYTRP43BL	D-24
NSYTRABF550	D-24	NSYTRpppppp	D-24
NSYTRAC22	D-24	NSYTRR22	D-24
NSYTRAC22BL	D-24	NSYTRR22AR	D-24
NSYTRAC23	D-24	NSYTRR22BL	D-24
NSYTRAC24	D-24	NSYTRR22M	D-24
NSYTRACE24	D-24	NSYTRR22MBL	D-24
NSYTRACE26	D-24	NSYTRR22MF	D-24
NSYTRACP43	D-24	NSYTRR22MFBL	D-24
NSYTRACPE26	D-24	NSYTRR22MFF	D-24
NSYTRACR22	D-24	NSYTRR22MP	D-24
NSYTRACR22BL	D-24	NSYTRR22MPBL	D-24
NSYTRACR23	D-24	NSYTRR23	D-24
NSYTRACR23BL	D-24	NSYTRR23AR	D-24
NSYTRACR24	D-24	NSYTRR23BL	D-24
NSYTRACR24BL	D-24	NSYTRR24	D-24
NSYTRACR42	D-24	NSYTRR24BL	D-24
NSYTRACR43	D-24	NSYTRR24D	D-24
NSYTRACRE24	D-24	NSYTRR24DBL	D-24
NSYTRACRE26	D-24	NSYTRR24M	D-24
NSYTRAL22	D-24	NSYTRR24MBL	D-24
NSYTRAL23	D-24	NSYTRR24MP	D-24
NSYTRAL24	D-24	NSYTRR24MPBL	D-24
NSYTRAL25	D-24	NSYTRR26T	D-24
NSYTRAL42	D-24	NSYTRR26TBL	D-24
NSYTRAL43	D-24	NSYTRR42	D-24
NSYTRAL44	D-24	NSYTRR42AR	D-24
NSYTRAL45	D-24	NSYTRR42BL	D-24
NSYTRAL210	D-24	NSYTRR43	D-24
NSYTRAL210BL	D-24	NSYTRR43BL	D-24
NSYTRAL210GR	D-24	NSYTRV22	D-24
NSYTRAL220	D-24	NSYTRV22AR	D-24
NSYTRAL410	D-24	NSYTRV22BL	D-24
NSYTRAL410BL	D-24	NSYTRV22M	D-24
NSYTRAL410GR	D-24	NSYTRV22MBL	D-24
NSYTRAL420	D-24	NSYTRV23	D-24
NSYTRP22	D-24	NSYTRV23BL	D-24
NSYTRP22AR	D-24	NSYTRV24	D-24
NSYTRP22BL	D-24	NSYTRV24BL	D-24
NSYTRP23	D-24	NSYTRV24D	D-24
NSYTRP23AR	D-24	NSYTRV24DBL	D-24

Com. no.	Page
NSYTRV26T	D-24
NSYTRV26TBL	D-24
NSYTRV42	D-24
NSYTRV42AR	D-24
NSYTRV42BL	D-24
NSYTRV42M	D-24
NSYTRV42MBL	D-24
NSYTRV43	D-24
NSYTRV43BL	D-24
NSYTRV44	D-24
X...	
XB5PRJ45	D-26
XB5PUSB3	D-26



Catalog number index with designations

Com. no.	Designation	Page
LVS01...		
LVS01005	10 black line L900 stickers	C-51
LVS01006	10 black arrow out. stickers	C-51
LVS01007	10 black arrow inc. stickers	C-51
LVS01008	10 black transformer stickers	C-51
LVS01017	Plain upper/low plate W600 PrismaSeT G IP30	E-15
LVS01018	Enclosure accessories PrismaSeT G IP30	E-14
LVS01020	Gland plate with 2 FL21 cut-out pack 160	F-8
LVS01025	2 single pilars RAL 9003 IP55	E-23, E-24, E-30
LVS01028	Combination profile 33m PrismaSeT G IP30	E-16
LVS01029	Combination profile 30m PrismaSeT G IP30	E-16
LVS01030	Combination profile 27m PrismaSeT G IP30	E-16
LVS01032	Door accessories PrismaSeT G IP30	E-14
LVS01033	33m side panel PrismaSeT G IP30	E-8, E-15
LVS01034	30m side panel PrismaSeT G IP30	E-8, E-15
LVS01035	27m side panel PrismaSeT G IP30	E-8, E-15
LVS01036	Combination accessories PrismaSeT G IP30	E-14
LVS01039	Plain upper/low plate W300 PrismaSeT G IP30	E-15
LVS01040	6m side panel PrismaSeT G IP30	E-8, E-15
LVS01041	9m side panel PrismaSeT G IP30	E-8, E-15
LVS01042	12m side panel PrismaSeT G IP30	E-8, E-15
LVS01043	15m side panel PrismaSeT G IP30	E-8, E-15
LVS01044	18m side panel PrismaSeT G IP30	E-8, E-15
LVS01045	21m side panel PrismaSeT G IP30	E-8, E-15
LVS01046	24m side panel PrismaSeT G IP30	E-8, E-15
LVS01047	36m side panel PrismaSeT G IP30	E-8, E-15
LVS01050	2 drilled bases PrismaSeT G IP30	E-16
LVS01051	2 plain bases PrismaSeT G IP30	E-16
LVS01052	W600 plinth front face PrismaSeT G IP30	E-16
LVS01053	W300 plinth front face PrismaSeT G IP30	E-16
LVS01063	Combination profile 9m PrismaSeT G Active IP30	E-16
LVS01064	Combination profile 12m PrismaSeT G Active IP30	E-16
LVS01065	Combination profile 15m PrismaSeT G Active IP30	E-16
LVS01066	Combination profile 18m PrismaSeT G IP30	E-16
LVS01067	Combination profile 21m PrismaSeT G IP30	E-16
LVS01069	Combination profile 36m PrismaSeT G IP30	E-16
LVS01070	Plain upper plate W850 PrismaSeT G IP30	E-15
LVS01125	Prisma G W850 Basic Green Signature	E-15
LVS01201	2 IPXXB clip-on covers Linergy BW	D-4
LVS01202	4 IPXXB covers Linergy FM 200	D-17
LVS01210	Linergy BW accessories 160-400A	D-4
LVS01211	Linergy BW accessories 630A	D-4
LVS01218	Rotative handle PrismaSeT G IP30/4X	E-15, F-17
LVS01247	Enclosure accessory AFS IP55	E-30
LVS01248	Door accessories AFS IP55	E-30
LVS01249	Closing system AFS IP55	E-30
LVS01254	2 plate uprights 18m PrismaSeT G IP30	E-16
LVS01257	2 plate uprights 27m PrismaSeT G IP30	E-16
LVS01258	Front cover support uprights IP30	E-16

Com. no.	Designation	Page
LVS01259	2 plate uprights 33m PrismaSeT G IP30	E-16
LVS01260	Modular device rail pack 160	F-4
LVS01261	Front cover support uprights IP30	E-16
LVS01264	Decentered plate 4m pack 160	F-8
LVS01265	Decentered plate 4,5m pack 160	F-8
LVS03...		
LVS03001	W600 modular device rail PrismaSeT G	B-32, C-31, C-32, C-33, C-35, C-52
LVS03002	W600 adjustable mod. dev. rail PrismaSeT G	C-4, C-6, C-8, C-10, C-12, C-18, C-27, C-31, C-35, C-52
LVS03003	W600 recessed modular dev. rail PrismaSeT G	C-18, C-36, C-52, F-4
LVS03004	W600 rear modular device rail PrismaSeT G	B-32, C-35, C-36, C-52, F-4
LVS03005	2 modular dev.rail supports 30° PrismaSeT G	C-53
LVS03006	W850 modular device rail PrismaSeT G	C-31, C-32, C-33, C-35, C-52
LVS03007	W850 adjustable mod. dev. rail PrismaSeT G	C-4, C-31, C-35, C-36, C-52
LVS03008	NG160 device rail pack 160	F-4
LVS03010	W300 modular device rail PrismaSeT G	C-31, C-32, C-33, C-35, C-52
LVS03011	W300 adjustable mod. dev. rail PrismaSeT G	C-4, C-6, C-8, C-10, C-18, C-31, C-35, C-36, C-52
LVS03018	NSXm device rail in pack 160	F-4
LVS03020	M.plate NSXm/Vigi/sdx hz. toggle W600	C-3
LVS03021	M.plate NSXm hz rot.handle W600	C-3
LVS03030	M.plate NSX/CVS/INS 250 hz.fixed toggle	B-32, C-5, C-17, C-19
LVS03031	M.pl.NSX/CVS/Vigi 250 hz.fix. rot.handle	C-7, C-11
LVS03032	M.plate NSX 250 hz. fix+mot/plug-in	C-7, C-18
LVS03033	M.plate Vigi NSX/CVS 250 hz.fixed toggle	C-5, C-9
LVS03040	M.pl. NSX/CVS/Vigi/INS 250 v. fix.toggle	C-6, C-10, C-18
LVS03041	M.pl. NSX/CVS/Vigi 250 v. fix.rot.handle	C-8, C-12
LVS03043	MOUNTING PLATE NSX/INS-INV250 CHANGEVER ROT.HAND	C-21, C-22
LVS03050	M.pl. NSX/CVS/Vigi/INS 250 v. fix.toggle	C-6, C-10, C-18
LVS03051	M.pl.NSX/CVS/INS 250 v. fixed rot.handle	C-8
LVS03070	M.plate NSX/CVS/INS 630 hz. fix. toggle	C-13, C-19
LVS03073	M.pl NSX/CVS/Vigi/INS 630 v. fix. toggle	C-14, C-15, C-20
LVS03074	M.pl NSX/CVS/Vigi 630 v. fix. rot.handle	C-14, C-15
LVS03080	M.pl NSX/CVS/Vigi/INS 630 v. fix. toggle	C-16, C-20
LVS03117	M. PL. GS32 3P/4P ROT.HANDLE HZ/VT	C-26, C-27
LVS03118	M. PL.GS63-160 3P/4P ROT.HANDLE HZ/VT	C-26, C-27
LVS03120	MOUNTING PLATE ISFT100 VERTICAL	C-29
LVS03121	M.plate ISFT160 vertical/horizontal	C-28

Catalog number index with designations

Com. no.	Designation	Page	Com. no.	Designation	Page
LVS03122	MOUNTING PLATE BUSBAR ISFT 100N/160 VERTICAL	C-29	LVS03217	4 divisible blanking plates W90	C-31, C-32, C-50
LVS03123	M.plate ISFT 160 fixed vertical W300	C-30	LVS03218	NSX blanking plate electronic trip unit	C-4, C-31, C-35, C-50
LVS03124	M.plate ISFT 250 fixed horizontal	C-28	LVS03220	Front plate 3 modular rows W600/W650 8m	C-4, C-6, C-8, C-31, C-32, C-35, C-52, F-7
LVS03125	M.plate ISFT 250 fixed vertical W300	C-30	LVS03221	4 divisible blanking plates W90	C-4, C-6, C-8, C-31, C-32, C-35, C-52, F-7
LVS03126	MOUNTING PLATE V ISFT 100N VERTICAL W600	C-29	LVS03222	NSX blanking plate electronic trip unit	C-10, C-12, C-52
LVS03152	M.plate for 2 3P-meters	C-34, F-5	LVS03223	Front plate 3 modular rows W600/W650 8m	C-32, C-50
LVS03155	Front plate for 3 1P-meters W600 6m	C-34	LVS03231	FRONT PLATE INS-INV250 HORIZ. W600 4M	C-17
LVS03156	M.plate for 1 3P-meter W300	C-34	LVS03232	Fr.pl. NSX/CVS250 hz.fix.tog/rot W600 4m	B-32, C-5, C-7
LVS03158	Front plate for 2 3P-meter W600 9m	C-34	LVS03234	Fr.plate NSX250 hz.fixed motor W600 4m	C-7
LVS03160	Mounting plate for 2 3P-meters W600 6m	C-34	LVS03235	FR.PL.CHANGEOVER INS-INV250 ROT W600 5M	C-22
LVS03164	20 M4 clip-nuts mod.dev.rails	C-53	LVS03239	FRONT PLATE INS250 HORIZONTAL W850 4M	C-17
LVS03165	20 M5 clip-nuts mod.dev.rails	C-53	LVS03241	Fr.pl.3-4 Vigi NSX/CVS250 v.fix.tog. 7m	C-10
LVS03166	20 M6 clip-nuts mod.dev.rails	C-53	LVS03243	Fr.pl.3-4 NSX/CVS250 v.fixed tog/rot 5m	C-6, C-8
LVS03170	Slotted mounting plate W600 4m	C-52	LVS03244	Fr.pl.3-4Vigi NSX/CVS250 v.rot/tl/plug 7m	
LVS03171	Recessed slotted m.plate W600 4m	C-36, C-52	LVS03245	FR.PL. CHANGEOVER NSX250 V.ROT. W600 5M	C-21
LVS03172	Recessed slotted m.plate W600 6m	C-36, C-52	LVS03247	FRONT PLATE CHANGEOVER INS250 W600 5M	C-22
LVS03173	Recessed slotted m.plate W600 9m	C-52	LVS03248	FRONT PLATE INS250 VERTICAL W600/W650 5M	C-18
LVS03175	Slotted mounting plate W300 4m	C-36, C-52	LVS03249	Blanking plate NSX/CVS250-EZC100 W147	C-10, C-12, C-52
LVS03176	Recessed slotted m.plate W300 4m	C-52	LVS03251	FRONT PLATE INS-INV250 VERTICAL W300 9M	C-18
LVS03177	Recessed slotted m.plate W300 6m	C-52	LVS03253	Fr.pl. NSX/CVS 250 v.fix.tog/rot W300 9m	C-6, C-8
LVS03178	Recessed slotted m.plate W300 9m	C-52	LVS03260	M+fr plate NG125/INS160 W600 6m	F-13
LVS03180	20 slotted m.pl. M4 clip-nuts	C-53	LVS03261	M+fr plate NSXm160 W600 6m	F-13
LVS03181	20 slotted m.pl. M5 clip-nuts	C-53	LVS03264	M+fr plate INS/INV250 h.fix.tog. W600 6m	F-13
LVS03182	20 slotted m.pl. M6 clip-nuts	C-53	LVS03267	M+fr plate INS/INV250 W300 9m	F-14
LVS03183	20 M5 self-tapping screws/fu	C-53	LVS03271	FRONT PLATE INS630 HORIZONTAL W600 9M	C-19
LVS03185	4 hexagonal spacers M5 H9	C-53	LVS03274	FRONT PLATE INS630 VERTIC. W600/W650 10M	C-20
LVS03186	4 hexagonal spacers M5 H23	C-53	LVS03275	Fr.pl.NSX/CVS 630 v.tog/rot/plug W600 9m	C-14
LVS03187	4 hexagonal spacers M5 H55	C-53	LVS03281	FRONT PLATE INS-INV 250-630 V. W300 10M	C-20
LVS03194	20 hexa.spacer M6 captive nuts	C-53	LVS03287	FRONT PLATE INS630 HZ W850 6M	C-19
LVS03195	4 hexagonal spacers M6 H9	C-53	LVS03289	Front plate NSX630 hz fix.tog. W850 6m	C-13
LVS03196	4 hexagonal spacers M6 H23	C-53	LVS03290	Fr.plate NSX250 hz plug-in tog. W600 4m	C-7
LVS03197	4 hexagonal spacers M6 H55	C-53	LVS03292	Fr.pl.Vigi NSX/CVS 250 h.tog/rot W600 4m	C-9, C-11
LVS03198	4 hexagonal spacers M6 H25	C-53	LVS03293	Front plate Vigi NSX250 v.tog. W300 11m	C-10
LVS03199	4 hexagonal spacers M8 H40+10	C-53	LVS03294	Front plate NSX250 hz fix/tog. W850 4m	C-5
LVS03202	Modular front plate W600/W650 2m	C-33, C-50	LVS03295	Fr.plate Vigi NSX250 hz.fix.tog W850 4m	C-9, C-11
LVS03203	Modular front plate W600/W650 3m	B-32, C-32, C-33, C-35, C-50	LVS03296	Front plate NSX630 hz fix.tog.W600 6m	C-13
LVS03204	Modular front plate W600/W650 4m	B-32, C-31, C-32, C-50	LVS03297	Fr.pl.Vigi NSX/CVS630 v.tog/rot W600 9m	C-15
LVS03205	Modular front plate W600/W650 5m	C-4, C-31, C-35, C-50	LVS03299	Front pl.Vigi NSX630 v.fix.tog.W300 10m	C-16
LVS03206	Front Plate, Transfer Pact, 3P/4P, 160A, Vertical, W650, 8M	C-24	LVS03301	Front pl. NSX/CVS 250 hz.fix.rot.W850 4m	C-7
LVS03207	Front Plate, Transfer Pact, 3P/4P, 160A, Vertical, W650, 8M	C-25	LVS03308	FRONT PL. GS32 3P/4P W600 HZ/VT 3M	C-26, C-27
LVS03208	Front Plate, Transfer Pact, 3P/4P, 63A, Vertical, W850, 6M	C-24	LVS03309	FRONT PL. GS63-160 3P/4P W600 HZ/VT 5M	C-26, C-27
LVS03209	Front Plate, Transfer Pact, 3P/4P, 160A, Vertical, W650, 8M	C-25			
LVS03213	4 divisible blanking plates W90	C-32, C-33, C-35, C-50			
LVS03214	NSX blanking plate electronic trip unit	C-4, C-31, C-32, C-50			
LVS03216	Front plate 3 modular rows W600/W650 8m	C-32, C-33, C-35, C-50			

Catalog number index with designations

Com. no.	Designation	Page	Com. no.	Designation	Page
LVS03326	Front plate ISFT160 horizontal W600 3m	C-28	LVS03811	Plain front plate W300 1m	C-6, C-8, C-18, C-50, F-14
LVS03327	Front plate ISFT160 vertical W300 6m	C-30	LVS03812	Plain front plate W300 2m	C-4, C-10, C-16, C-20, C-31, C-35, C-36, C-50, F-14
LVS03328	Front plate ISFT250 horizontal W600 5m	C-28	LVS03813	Plain front plate W300 3m	C-35, C-50, F-14
LVS03329	Front plate ISFT250 vertical W300 9m	C-30	LVS03814	Plain front plate W300 4m	C-36, C-50, F-14
LVS03330	Fr. plate NSXm/Vigi/sdx hz.tog. W600 3m	C-3	LVS03815	Plain front plate W300 5m	C-50, F-14
LVS03331	Fr. plate NSXm hz.rot.W600 3m	C-3	LVS03816	Plain front plate W300 6m	C-50, F-14
LVS03332	Fr.pl.NSXm/Vigi/sdx hz.tog.+1cut W850 3m	C-3	LVS03817	Plain front plate W300 9m	C-34, C-50, F-14
LVS03333	Fr.pl.NSXm hz.rot.+ 1Pre cut-out W850 3m	C-3	LVS03818	Plain front plate W300 3m	F-14
LVS03334	Fr.pl.NSX/NSXVigi+PowerTag Hz T/R L600 4m	C-5, C-7	LVS03851	Plain front plate W850 1m	C-5, C-17, C-28, C-50
LVS03335	Fr.pl.NSX/NSXVigi+PowerTag Hz T/R L850 4m	C-5, C-7	LVS03853	Plain front plate W850 3m	C-13, C-19, C-35, C-50
LVS03342	Transparent front plate W600/W650 4m	B-32, C-33, C-35, C-36, C-50	LVS03854	Plain front plate W850 4m	C-50
LVS03343	Transparent front plate W600/W650 6m	C-33, C-34, C-35, C-36, C-50	LVS03856	Plain front plate W850 6m	C-34, C-50
LVS03344	Transparent front plate W600/W650 9m	C-33, C-34, C-50, F-5	LVS03859	Plain front plate W850 9m	C-34, C-50
LVS03345	Transparent front plate W600/W650 12m	C-33, C-50	LVS03861	Plain front plate W850 11m	C-50
LVS03352	Transparent front plate W300 4m	C-33, C-35, C-36, C-50	LVS03890	Front plate for fan/grill W600/W650 7m	C-50
LVS03353	Transparent front plate W300 6m	C-33, C-35, C-50	LVS03891	IP30 ventilated front plate W600/W650 1m	C-48, C-50
LVS03354	Transparent front plate W300 9m	C-33, C-34, C-50	LVS03895	IP30 ventilated front plate W600/W650 3m	C-48, C-50
LVS03363	Transparent front plate W850 6m	C-33, C-34, C-35, C-36, C-50	LVS03900	Support 72x72 met.dev/pb for 03904/03928	C-38
LVS03364	Transparent front plate W850 9m	C-33, C-34, C-35, C-50	LVS03901	Support 96x96 met.dev/pb for 03904/03928	C-38
LVS03426	Mounting Plate, Transfer Pact, 3P/4P, 63A, Vertical W600	C-24	LVS03902	Supp.cut-out 72x72met.dev/pb 03904/03928	C-38
LVS03427	Mounting Plate, Transfer Pact, 3P/4P, 160A, Vertical W600	C-25	LVS03903	Supp.cut-out 96x96met.dev/pb 03904/03928	C-38
LVS03581	2 universal angle brackets	C-53	LVS03904	Fr.pl.72²/96² cut-out met.dev/pb W600 3m	C-38
LVS03583	6 universal angle brackets	C-53	LVS03907	Support 72x72 met.dev/pb for 03910/03912	C-38, C-39
LVS03801	Plain front plate W600/W650 1m	B-32, C-5, C-7, C-10, C-11, C-12, C-14, C-15, C-17, C-18, C-28, C-35, C-36, C-50	LVS03908	Support 96x96 met.dev/pb for 03911/03913	C-38, C-39
LVS03802	Plain front plate W600/W650 2m	B-32, C-6, C-8, C-10, C-12, C-14, C-18, C-20, C-22, C-28, C-29, C-50	LVS03910	Fr.pl.72x72 6 cut-out met.dev/pb W600 3m	C-38
LVS03803	Plain front plate W600/W650 3m	B-32, C-6, C-8, C-13, C-14, C-15, C-18, C-19, C-21, C-22, C-35, C-50	LVS03911	Fr.pl.96x96 3 cut-out met.dev/pb W600 3m	C-38
LVS03804	Plain front plate W600/W650 4m	C-6, C-8, C-10, C-12, C-15, C-20, C-36, C-50	LVS03913	Fr.pl.96x96 1 cut-out met.dev/pb W600 3m	C-38
LVS03805	Plain front plate W600/W650 5m	C-14, C-36, C-50	LVS03914	Fr.pl. 12Push-button/lamps W600/W650 2m	C-38
LVS03806	Plain front plate W600/W650 6m	C-18, C-34, C-36, C-50	LVS03923	Fr.pl. 1 pre cut-out 96x96 W300 3m	C-39
LVS03808	Plain front plate W600/W650 12m	C-50	LVS03925	Fr.pl. 4 pre cut-out 96x96 W850 3m	C-39
LVS03809		C-28, C-29	LVS03928	Visor 30°for metering dev/pb 72x72/96x96	C-38, E-11
LVS04...					
LVS04004	Linery FM 4P dist.block 80A	D-16, F-9, F-19	LVS04008	Linery FM 4P dist.block 63A 12m 20holes	D-16, F-9, F-19
LVS04012	Linery FM 2P dis.block 200A 24m 24holes	D-16	LVS04013	Linery FM 3P dis.block 200A 24m 42holes	D-16
LVS04014	Linery FM 4P dis.block 200A 24m 54holes	D-16	LVS04018	Linery FM 4P dis.block 160A 12m 27holes	D-16, F-19
LVS04021	4P conn.lin.bw insul.bb/lin.fm d.blk200A	D-4, D-9	LVS04024	4P conn.lin.bs stage bb/lin.fm d.blk200A	C-45, D-7, D-9, D-16
LVS04026	Linery FM 4P dis.block 200A 36m 81holes	D-16	LVS04029	4 conn.lin.bs rear bb/lin.fm d.blk 200A	C-45, D-6, D-9, D-16

Catalog number index with designations

Com. no.	Designation	Page	Com. no.	Designation	Page
LVS04030	4 conn. NSXm160/Linergy FM dist.blk 160A	C-3, C-45, D-6, D-7, D-9, D-16	LVS04107	Linergy BW 3P Insulated busbar 125A L750	D-4
LVS04031	Linergy DX 1P dist.block 160A 4m 6holes	C-4, C-27, C-31, D-11	LVS04108	Linergy BW 4P Insulated busbar 125A L750	D-4
LVS04033	Linergy DP 3P d.blk/comPacT 250A 27holes	C-6, C-8, C-9, C-10, C-11, C-12, C-17, C-18, D-12	LVS04111	Linergy BW 3P Insulated b.bar 160A L1000	B-33, D-4
LVS04034	Linergy DP 4P d.blk/comPacT 250A 36holes	C-6, C-8, C-9, C-10, C-11, C-12, C-17, C-18, D-12	LVS04112	Linergy BW 3P Insulated b.bar 250A L1000	B-33, D-4
LVS04038	Linergy DP/NSXm 3P 160A 18T	D-13, F-18	LVS04113	Linergy BW 3P Insulated b.bar 400A L1000	B-33, D-4
LVS04039	Linergy DP/NSXm 4P 160A 24T	D-13, F-18	LVS04114	Linergy BW 3P Insulated b.bar 630A L1000	B-33, D-4
LVS04040	Linergy DX 4P 63A top incoming	D-10	LVS04116	Linergy BW 3P Insulated b.bar 160A L1400	B-33, D-4
LVS04041	Linergy DX 4P 63A bottom incoming	D-10	LVS04117	Linergy BW 3P Insulated b.bar 250A L1400	B-33, D-4
LVS04045	Linergy DX 4P dist.block 125A 6m 52holes	C-4, C-31, D-11, F-9, F-18	LVS04118	Linergy BW 3P Insulated b.bar 400A L1400	B-33, D-4
LVS04046	Linergy DX 4P d.blk/NSXm 160A 6m 52holes	C-4, C-31, D-11	LVS04119	Linergy BW 3P Insulated b.bar 630A L1400	B-33, D-4
LVS04047	4 conn.NG125/Linergy DX dist.block 125A	C-4, C-31, D-11	LVS04121	Linergy BW 4P Insulated b.bar 160A L1000	B-33, D-4
LVS04052	Linergy BS 4P multistage bb 160A 52holes	D-8, F-18	LVS04122	Linergy BW 4P Insulated b.bar 250A L1000	B-33, D-4
LVS04053	Linergy BS 4P multistage bb 250A 52holes	D-8, F-18	LVS04123	Linergy BW 4P Insulated b.bar 400A L1000	B-33, D-4
LVS04054	Linergy BS 4P multistage bb 400A 52holes	D-8	LVS04124	Linergy BW 4P Insulated b.bar 400A L1001	B-33, D-4
LVS04055	Linergy BS 4P multistage bb 630A 52holes	D-8	LVS04126	Linergy BW 4P Insulated b.bar 160A L1400	B-33, D-4
LVS04060	Power supply blk NSX/CVS/INS/INV 250 4P	B-32, C-5, C-7, C-9, C-11, C-17, C-42, D-5, G-6	LVS04127	Linergy BW 4P Insulated b.bar 250A L1400	B-33, D-4
LVS04061	Power supply block universal 250A 4P	C-6, C-8, C-10, C-12, C-26, C-27, C-28, C-30, C-43, D-5	LVS04128	Linergy BW 4P Insulated b.bar 400A L1400	B-33, D-4
LVS04062	Cu conn 250A 4P/universal power supply	C-6, C-8, D-5	LVS04129	Linergy BW 4P Insulated b.bar 630A L1400	B-33, D-4
LVS04064	Cu conn 250A 4P/universal power supply	C-6, C-8, D-5	LVS04145	Cu connections 125A 4P W230	C-44, D-5
LVS04065	Cu conn.NSX/CVS/INS 250 v.4P/staged bb	C-6, C-8, C-10, C-44, D-7	LVS04146	Cu connections 160A 4P W250	C-4
LVS04066	Incomer conn.block NSX/INS/INV250 4P top	B-32, C-5, C-17, C-42, G-6	LVS04147	Connect.160A 4P lin.bw/device 160A W165	C-44, D-5
LVS04067	Incomer conn.bl NSX/INS/INV250 4P bottom	B-32, C-5, C-17, C-42, G-6	LVS04148	Connect.160A 4P lin.bw/device 160A W440	C-44, D-5
LVS04070	Power supply blk NSX/CVS/INS-INV 400 4P	C-19	LVS04149	Connection 160A 4P L380 /Linergy DX 1P	C-4, C-31, D-11
LVS04071	Power supply blk NSX/CVS/INS-INV 630 4P	C-13, C-19, C-42, D-5, G-6	LVS04150	8 IPXXB covers/ Linergy BW Insulated bb	D-4
LVS04073	Cu conn.NSX/CVS/INS-INV630 4P/pow.supply	C-16, D-5	LVS04151	12 terminals 6/10 ² for Linergy BW bbar	C-44, D-4
LVS04074	Universal power supply block 400-630A	C-14, C-15, C-16, C-20, C-43, D-5	LVS04152	12 terminals 1x16 ² for Linergy BW bbar	C-44, D-4
LVS04075	Cu conn. NSX/CVS/INS 630 v.4P/ staged bb	C-16, C-44, D-7	LVS04156	Additional blk 2x35 ² 4P/ Linergy DP 250A	D-12
LVS04076	Incoming connection bl.NSX630 hz in-duct	C-13, C-42, G-6	LVS04158	20 screws 8.8 class M6x12/ Linergy BW bb	D-4
LVS04103	Linergy BW 3P Insulated busbar 125A L450	D-4	LVS04161	4 threaded bars 160A L1000/Linergy BS bb	D-6, D-7, F-18
LVS04104	Linergy BW 4P Insulated busbar 125A L450	D-4	LVS04162	4 threaded bars 250A L1000/Linergy BS bb	D-6, D-7
			LVS04163	4 threaded bars 400A L1000/Linergy BS bb	D-6, D-7
			LVS04171	4 threaded bars 160A L1400/Linergy BS bb	D-6, D-7
			LVS04172	4 threaded bars 250A L1400/Linergy BS bb	D-6, D-7
			LVS04173	4 threaded bars 400A L1400/Linergy BS bb	D-6, D-7
			LVS04174	4 threaded bars 630A L1400/Linergy BS bb	D-6, D-7
			LVS04190	4 copper angle brackets 250A	C-44, D-6
			LVS04191	Linergy BS rear busbar support 400A	C-3, C-4, C-5, C-6, C-7, C-8, C-9, C-10, C-11, C-12, C-13, C-14, C-15, C-16, C-17, C-18, C-19, C-20, C-26, C-27, C-28, C-30, C-31, D-6, F-18

Catalog number index with designations

Com. no.	Designation	Page	Com. no.	Designation	Page
LVS04192	Linery BS multistage b.bar support 630A	C-3, C-4, C-5, C-6, C-7, C-8, C-9, C-10, C-11, C-12, C-13, C-14, C-15, C-16, C-17, C-18, C-19, C-20, C-26, C-27, C-28, C-30, C-31, D-7	LVS04751	Insulated flex.bar 32x5 L1800	C-45
LVS04194	20 bolts 8.8 class M6x20/5mm copper bar	D-9	LVS04752	Insulated flex.bar 32x6 L1800	C-45
LVS04195	40 screws 8.8 class M6x16/threaded bar	D-9	LVS04753	Insulated flex.bar 32x8 L1800	C-45
LVS04197	Barrier H1500mm/Linery BS multistage bb	C-16, D-7	LVS07...		
LVS04198	Barrier H100mm/Linery BS rear busbar	C-16, D-6	LVS07051	4 cable connect.1P 160A 70mm ² Linery BS	D-9
LVS04200	Earth bar 35 ² /40 clamps L450 Linery TB	D-23	LVS07052	4 cable conn.1P 250A 185mm ² Linery BS	D-9
LVS04201	12x3mm dir.earth bar 35 ² L330 Linery TB	B-33, D-23	LVS07053	4 cable connect 1P 400A 300mm ² Linery BS	D-9
LVS04202	2 earth bar 35 ² /20 clamp L200 Linery TB		LVS07931	RAL 7016 rotative handle PrismaSeT P/ PrismaSeT G	E-13, F-8
LVS04203	Auxiliary bus duct L1755 Linery TA 4P	D-26	LVS07932	Euro rotative white handle PrismaSeT P/ PrismaSeT G	E-13
LVS04206	2 fix.brack.v.earth bar enc.H15	C-40, C-46, F-9	LVS07933	Assa rotative white handle PrismaSeT P/ PrismaSeT G	E-13
LVS04207	2 fix.brack.v.earth bar enc.H45	C-40	LVS07938	Handle padlocking kit for 1 locker	E-13, F-8, F-17
LVS04208	2 fix.brack.v.earth bar enc.H80	C-40	LVS07940	Barrel bloc with combination lock 405	E-13
LVS04210	2 Insulat.spacers/neutral bar Linery TB	D-23	LVS07941	Barrel bloc with combination lock 455	E-13
LVS04214	4 earth blk 12x4 ² term.clamp Linery TB	B-33, D-23	LVS07942	Barrel bloc with combination lock 1242e	E-13
LVS04215	4 earth blk 3x16 ² term.clamp Linery TB	B-33, D-23	LVS07943	Barrel bloc with combination lock 3113a	E-13
LVS04220	M.brac.term.blk-earth bar duct	B-33, C-40	LVS07944	Barrel bloc with combination lock 2433a	E-13
LVS04223	M.br.4v.mod.dev.rails term.blk	C-40	LVS07945	Insert bloc combinaison.din double bar	E-13
LVS04224	5 practic raisers	C-53	LVS07946	Insert bloc combinaison.screwdriver slot	E-13
LVS04225	Set of 12 raisers H11/ mod.rail for NSXm	C-52, F-4	LVS07949	Insert bloc combi.8mm male triangle	E-13
LVS04226	2 modular device rails L1600	B-33, C-52, F-4	LVS07951	Insert bloc combinaison.6mm male square	E-13
LVS04227	Rail and raisers modular	C-52, F-4	LVS07953	Insert bloc combinaison.8mm male square	E-13
LVS04228	Linery TA auxil.term.blk 10 in/20 out	D-26	LVS07956	Barrel bloc with combination lock 2432E	E-13
LVS04233	Trunking door L2000	C-46	LVS08...		
LVS04234	10 wiring through fr.grommets	C-46	LVS08002	Wall-mounted enclosure 2 rows pack 160	F-4
LVS04235	Wiring to door flex.trunking	C-46	LVS08003	Wall-mounted enclosure 3 rows pack 160	F-4
LVS04239	12 hz.cable straps	C-47	LVS08004	Wall-mounted enclosure 4 rows pack 160	F-4
LVS04243	4 covers hz.cable straps	C-47	LVS08005	Wall-mounted enclosure 5 rows pack 160	F-4
LVS04255	12 hz.trunking supports	C-46, F-9	LVS08006	Wall-mounted enclosure 6 rows pack 160	F-4
LVS04256	10 hz. adjustable trunking sup	C-46	LVS08012	Extension enclosure 2 rows pack 160	F-5
LVS04257	4hz.trunking sections L450+sup	C-46, F-9	LVS08064	Wall-mounted encl. 2rows+6m pack250 IP30	F-13, F-14
LVS04263	2 v.cable straps L1000 covers	C-47	LVS08065	Wall-mounted encl. 3rows+6m pack250 IP30	F-13, F-14
LVS04264	12 v.cable straps system g	C-47	LVS08066	Wall-mounted encl. 4rows+6m pack250 IP30	F-13, F-14
LVS04265	12 v.trunking supports	C-46	LVS08067	Wall-mounted encl. 5rows+6m pack250 IP30	F-13, F-14
LVS04266	10 vertical trunking plates	C-46	LVS08068	Wall-mounted encl. 6rows+6m pack250 IP30	F-13, F-14
LVS04267	Vertical trunking L2000	C-46	LVS08069	Wall-mounted encl. 7rows+6m pack250 IP30	F-13, F-14
LVS04330	Vertical partition PrismaSeT G IP30	C-41	LVS08072	Floor-stand.encl. 7rows+6m pack250 IP30	F-13, F-14
LVS04331	Horizontal partition W600 PrismaSeT G	C-34, C-41	LVS08073	Floor-stand.encl. 8rows+6m pack250 IP30	F-13, F-14
LVS04332	Horizontal partition W300 PrismaSeT G	C-34, C-41	LVS08074	Floor-stand.encl. 9rows+6m pack250 IP30	F-13, F-14
LVS04333	Horizontal partition PrismaSeT pack 160	F-5	LVS08082	Plain door 2R pack 160	F-4, F-5
LVS04335	Vertical partition H36m PrismaSeT G IP30	C-41	LVS08083	Plain door 3R pack 160	F-4
LVS04336	Horizontal partition W850 PrismaSeT G	C-41	LVS08084	Plain door 4R pack 160	F-4
LVS04742	Insulated flex.bar 20x2 L1800	C-45	LVS08085	Plain door 5R pack 160	F-4
LVS04743	Insulated flex.bar 20x3 L1800	C-45, D-16	LVS08086	Plain door 6R pack 160	F-4
LVS04746	Insulated flex.bar 24X5 L1800	C-45	LVS08092	Transparent door 2R pack 160	F-4, F-5
			LVS08093	Transparent door 3R pack 160	F-4
			LVS08094	Transparent door 4R pack 160	F-4
			LVS08095	Transparent door 5R pack 160	F-4
			LVS08096	Transparent door 6R pack 160	F-4
			LVS08102	Wall-mounted encl.W600 6m PrismaSeT G IP30	B-33, E-6

Catalog number index with designations

Com. no.	Designation	Page	Com. no.	Designation	Page
LVS08103	Wall-mounted encl.W600 9m PrismaSeT G IP30	B-33, E-6	LVS08179	Wall-mounted duct W300 27m PrismaSeT G IP30	E-6, E-8, F-14
LVS08104	Wall-mounted encl.W600 12m PrismaSeT G IP30	B-33, E-6	LVS08182	Plain duct door W300 6m PrismaSeT G IP30/4X	B-33, E-6, E-8
LVS08105	Wall-mounted encl.W600 15m PrismaSeT G IP30	B-33, E-6	LVS08183	Plain duct door W300 9m PrismaSeT G IP30/4X	B-33, E-6, E-8
LVS08106	Wall-mounted encl.W600 18m PrismaSeT G IP30	B-33, E-6	LVS08184	Plain duct door W300 12m PrismaSeT G IP30/4X	B-33, E-6, E-8, F-14
LVS08107	Wall-mounted encl.W600 21m PrismaSeT G IP30	B-33, E-6	LVS08185	Plain duct door W300 15m PrismaSeT G IP30/4X	B-33, E-6, E-8, F-14
LVS08108	Wall-mounted encl.W600 24m PrismaSeT G IP30	E-6	LVS08186	Plain duct door W300 18m PrismaSeT G IP30/4X	B-33, E-6, E-8, F-14
LVS08109	Wall-mounted encl.W600 27m PrismaSeT G IP30	E-6	LVS08187	Plain duct door W300 21m PrismaSeT G IP30/4X	B-33, E-6, E-8, F-14
LVS08113	Extension enclos. W600 9m PrismaSeT G IP30	E-6	LVS08188	Plain duct door W300 24m PrismaSeT G IP30/4X	E-6, E-8, F-14
LVS08114	Extension enclos. W600 12m PrismaSeT G IP30	E-6	LVS08197	Transp. duct door W300 21m g IP30/4X	B-33, E-6, E-8, F-14
LVS08115	Extension enclos. W600 15m PrismaSeT G IP30	E-6	LVS08198	Transp. duct door W300 24m g IP30/4X	E-6, E-8, F-14
LVS08116	Extension enclos. W600 18m PrismaSeT G IP30	E-6	LVS08212	PrismaSeT G Floor Standing W600 - Enclosure/ H27 - Extension	E-6
LVS08117	Extension enclos. W600 21m PrismaSeT G IP30	E-6	LVS08213	PrismaSeT G Floor Standing W600 - Enclosure/ H30- Extension	E-6
LVS08118	Extension enclos. W600 24m PrismaSeT G IP30	E-6	LVS08214	PrismaSeT G Floor Standing W600 - Enclosure/ H33- Extension	E-6
LVS08119	Extension enclos. W600 27m PrismaSeT G IP30	E-6	LVS08215	PrismaSeT G Floor Standing W600 - Enclosure/ H36- Extension	E-6
LVS08122	Plain door W600 6m PrismaSeT G IP30/4X	B-33, E-6	LVS08222	Plain door W600 27m PrismaSeT G IP30/4X	E-6, F-13, F-14
LVS08123	Plain door W600 9m PrismaSeT G IP30/4X	B-33, E-6	LVS08223	Plain door W600 30m PrismaSeT G IP30/4X	E-6, F-13, F-14
LVS08124	Plain door W600 12m PrismaSeT G IP30/4X	B-33, E-6, F-13, F-14	LVS08224	Plain door W600 33m PrismaSeT G IP30/4X	E-6, F-13, F-14
LVS08125	Plain door W600 15m PrismaSeT G IP30/4X	B-33, E-6, F-13, F-14	LVS08225	Plain door W600 36m PrismaSeT G IP30/4X	E-6
LVS08126	Plain door W600 18m PrismaSeT G IP30/4X	B-33, E-6, F-13, F-14	LVS08232	Transp. door W600 27m PrismaSeT G IP30/4X	E-6, F-13, F-14
LVS08127	Plain door W600 21m PrismaSeT G IP30/4X	B-33, E-6, F-13, F-14	LVS08233	Transp. door W600 30m PrismaSeT G IP30/4X	E-6, F-13, F-14
LVS08128	Plain door W600 24m PrismaSeT G IP30/4X	E-6, F-13, F-14	LVS08234	Transp. door W600 33m PrismaSeT G IP30/4X	E-6, F-13, F-14
LVS08132	Transp. door W600 6m PrismaSeT G IP30/4X	B-33, E-6	LVS08235	Transp. door W600 36m PrismaSeT G IP30/4X	E-6
LVS08133	Transp. door W600 9m PrismaSeT G IP30/4X	B-33, E-6	LVS08242	PrismaSeT G Floor Standing W850 - Enclosure/ H27 - Extension	E-6
LVS08134	Transp. door W600 12m PrismaSeT G IP30/4X	B-33, E-6, F-13, F-14	LVS08243	PrismaSeT G Floor Standing W850 - Enclosure/ H30 - Extension	E-6
LVS08135	Transp. door W600 15m PrismaSeT G IP30/4X	B-33, E-6, F-13, F-14	LVS08244	PrismaSeT G Floor Standing W850 - Enclosure/ H33 - Extension	E-6
LVS08136	Transp. door W600 18m PrismaSeT G IP30/4X	B-33, E-6, F-13, F-14	LVS08245	PrismaSeT G Floor Standing W850 - Enclosure/ H36 - Extension	E-6
LVS08137	Transp. door W600 21m PrismaSeT G IP30/4X	B-33, E-6, F-13, F-14	LVS08252	Plain door W850 27m PrismaSeT G IP30/4X	E-6
LVS08138	Transp. door W600 24m PrismaSeT G IP30/4X	E-6, F-13, F-14	LVS08253	Plain door W850 30m PrismaSeT G IP30/4X	E-6
LVS08172	Wall-mounted duct W300 6m PrismaSeT G IP30	B-33, E-6, E-8	LVS08254	Plain door W850 33m PrismaSeT G IP30/4X	E-6
LVS08173	Wall-mounted duct W300 9m PrismaSeT G IP30	B-33, E-6, E-8	LVS08255	Plain door W850 36m PrismaSeT G IP30/4X	E-6
LVS08174	Wall-mounted duct W300 12m PrismaSeT G IP30	B-33, E-6, E-8, F-14	LVS08262	Transp. door W850 27m PrismaSeT G IP30/4X	E-6
LVS08175	Wall-mounted duct W300 15m PrismaSeT G IP30	B-33, E-6, E-8, F-14	LVS08263	Transp. door W850 30m PrismaSeT G IP30/4X	E-6
LVS08176	Wall-mounted duct W300 18m PrismaSeT G IP30	B-33, E-6, E-8, F-14	LVS08264	Transp. door W850 33m PrismaSeT G IP30/4X	E-6
LVS08177	Wall-mounted duct W300 21m PrismaSeT G IP30	B-33, E-6, E-8, F-14	LVS08265	Transp. door W850 36m PrismaSeT G IP30/4X	E-6
LVS08178	Wall-mounted duct W300 24m PrismaSeT G IP30	E-6, E-8, F-14	LVS08272	Floor-stand. duct W300 27m PrismaSeT G IP30	E-6, E-8, F-14
			LVS08273	Floor-stand. duct W300 30m PrismaSeT G IP30	E-6, E-8, F-14

Catalog number index with designations

Com. no.	Designation	Page	Com. no.	Designation	Page
LVS08274	Floor-stand.duct W300 33m PrismaSeT G IP30	E-6, E-8, F-14	LVS08344	Duct (rear encl+door) W300 15m g IP55	E-23
LVS08275	Floor-stand.duct W300 36m PrismaSeT G IP30	E-6, E-8	LVS08345	Duct (rear encl+door) W300 19m g IP55	E-23
LVS08282	Plain duct door W300 27m PrismaSeT G IP30/4X	E-6, E-8, F-14	LVS08346	Duct (rear encl+door) W300 23m g IP55	E-23
LVS08283	Plain duct door W300 30m PrismaSeT G IP30/4X	E-6, E-8, F-14	LVS08347	Duct (rear encl+door) W300 27m g IP55	E-23
LVS08284	Plain duct door W300 33m PrismaSeT G IP30/4X	E-6, E-8, F-14	LVS08349	Duct (rear encl+door) W300 33m g IP55	E-23
LVS08285	Plain duct door W300 36m PrismaSeT G IP30/4X	E-6, E-8	LVS08352	2 side panels 7m PrismaSeT G IP55	E-23
LVS08292	Transp. duct door W300 27m g IP30/4X	E-6, E-8, F-14	LVS08353	2 side panels 11m PrismaSeT G IP55	E-23
LVS08293	Transp. duct door W300 30m g IP30/4X	E-6, E-8, F-14	LVS08354	2 side panels 15m PrismaSeT G IP55	E-23
LVS08294	Transp. duct door W300 33m g IP30/4X	E-6, E-8, F-14	LVS08355	2 side panels 19m PrismaSeT G IP55	E-23
LVS08295	Transp. duct door W300 36m g IP30/4X	E-6, E-8	LVS08356	2 side panels 23m PrismaSeT G IP55	E-23
LVS08302	Wall-mounted encl.W600 7m PrismaSeT G IP55	E-23	LVS08357	2 side panels 27m PrismaSeT G IP55	E-23
LVS08303	Wall-mounted encl.W600 11m PrismaSeT G IP55	E-23	LVS08359	2 side panels 33m PrismaSeT G IP55	E-23
LVS08304	Wall-mounted encl.W600 15m PrismaSeT G IP55	E-23	LVS08364	2 side panels 15m 2cut-out PrismaSeT G IP55	E-28
LVS08305	Wall-mounted encl.W600 19m PrismaSeT G IP55	E-23	LVS08369	2 side panels 33m 2cut-out PrismaSeT G IP55	E-28
LVS08306	Wall-mounted encl.W600 23m PrismaSeT G IP55	E-23	LVS08371	2 plain up/low plate W600 PrismaSeT G IP55	E-23
LVS08307	Wall-mounted encl.W600 27m PrismaSeT G IP55	E-23	LVS08372	2 plain up/low plate W300 PrismaSeT G IP55	E-23
LVS08309	Wall-mounted encl.W600 33m PrismaSeT G IP55	E-23	LVS08374	Partial plain door 4m g IP55/11-27m	E-27
LVS08311	PrismaSeT G Floor Standing W850 - Enclosure/H33	E-23	LVS08376	Partial plain door 4m g IP55/11-27m	E-27
LVS08312	Extension encl. W600 7m PrismaSeT G IP55	E-23	LVS08381	Hz/v. combination kit PrismaSeT G IP55	E-24
LVS08313	Extension encl. W600 11m PrismaSeT G IP55	E-23	LVS08382	I combination kit PrismaSeT G IP55	E-24
LVS08314	Extension encl. W600 15m PrismaSeT G IP55	E-23	LVS08383	Square combination kit PrismaSeT G IP55	E-24
LVS08315	Extension encl. W600 19m PrismaSeT G IP55	E-23	LVS08384	Vertical partition PrismaSeT G IP55	C-41
LVS08316	Extension encl. W600 23m PrismaSeT G IP55	E-23	LVS08386	Canopy W600 PrismaSeT G IP55	E-25
LVS08317	Extension encl. W600 27m PrismaSeT G IP55	E-23	LVS08387	Canopy W300 PrismaSeT G IP55	E-25
LVS08319	Extension encl. W600 33m PrismaSeT G IP55	E-23	LVS08391	1 mounting upright I1950 PrismaSeT G IP55	E-24, E-25
LVS08322	Plain door+frame W600 7m PrismaSeT G IP55	E-23	LVS08392	1 lateral plinth support H150 g IP55	
LVS08323	Plain door+frame W600 11m PrismaSeT G IP55	E-23	LVS08393	1 plinth cover panel W600 PrismaSeT G IP55	E-25
LVS08324	Plain door+frame W600 15m PrismaSeT G IP55	E-23	LVS08394	1 plinth cover panel W300 PrismaSeT G IP55	E-25
LVS08325	Plain door+frame W600 19m PrismaSeT G IP55	E-23	LVS08395		E-25
LVS08326	Plain door+frame W600 23m PrismaSeT G IP55	E-23	LVS08396	2 lifting rings PrismaSeT G IP55	E-24
LVS08327	Plain door+frame W600 27m PrismaSeT G IP55	E-23	LVS08585	Front plate hinge kit	C-52
LVS08329	Plain door+frame W600 33m PrismaSeT G IP55	E-23	LVS08783	Form c cable tie sup. L1600	C-47
LVS08330	Plain door+frame W850 33m PrismaSeT G IP55	E-23	LVS08801	2 lifting rings for PrismaSeT G IP30	E-10, F-15
LVS08332	Transparent door+frame W600 7m g IP55	E-23	LVS08802	Plinth H150 W850 PrismaSeT G IP55	E-23
LVS08333	Transparent door+frame W600 11m g IP55	E-23	LVS08803	4 external brackets for pack 160	F-7
LVS08334	Transparent door+frame W600 15m g IP55	E-23	LVS08804	4 external brackets for PrismaSeT G IP30	E-10, F-15
LVS08335	Transparent door+frame W600 19m g IP55	E-23	LVS08805	Plinth raiser W600 H100mm PrismaSeT G IP30	E-11, F-15
LVS08336	Transparent door+frame W600 23m g IP55	E-23	LVS08806	Plinth raiser W850 H100mm PrismaSeT G IP30	E-11
LVS08337	Transparent door+frame W600 27m g IP55	E-23	LVS08807	Plinth raiser W300 H100mm PrismaSeT G IP30	E-11, F-15
LVS08339	Transparent door+frame W600 33m g IP55	E-23	LVS08809	2 lifting cross-members W850+300 /g IP30	E-10
LVS08340	Transparent door+frame W850 33m g IP55	E-23	LVS08811	2 lifting cross-members W600+600 /g IP30	E-9, E-10
LVS08342	Duct (rear encl+door) W300 7m g IP55	E-23	LVS08812	2 lifting cross-members W600+300 /g IP30	E-9, E-10, F-15
LVS08343	Duct (rear encl+door) W300 11m g IP55	E-23	LVS08813	2 lifting x-members W600+300+600 /g IP30	E-9, E-10
			LVS08814	2 lifting x-members 2x(W600+300) /g IP30	E-9, E-10
			LVS08815	Combination kit/fl.st.encl.PrismaSeT G IP30	E-14
			LVS08816	Additional combination kit PrismaSeT G IP30	E-9
			LVS08817	2 vertical combination uprights/g IP30	E-9, F-5, F-7
			LVS08818	Multiple combination kit PrismaSeT G IP30	E-9
			LVS08819	Flush-mount.kit W600 H6-18m encl/g IP30	E-11
			LVS08820	Flush-mount.kit W600 H21-27m encl/g IP30	E-11
			LVS08821	Trunking spreader pack 160	F-6

Catalog number index with designations

Com. no.	Designation	Page	Com. no.	Designation	Page
LVS08822	Flush-mounting kit pack 160	F-7	LVS08906	12 adhesive label holders 36x180 W300	C-51
LVS08823	IP31 canopy for pack 160	F-6	LVS08908	12 adhesive label holders 36x650 W850	C-51
LVS08824	Trunking spreader for PrismaSeT G IP30	E-11	LVS08910	Earthing braid 6mm ²	C-34, E-11, F-8, F-17
LVS08826	2 lifting x-member 2xW600+ 3xW300/g IP30	E-9, E-10	LVS08911	Earthing wire 6mm ²	E-11, F-5, F-8, F-17
LVS08827	IP41 canopy W600+W300+W300 g IP30/4X	E-7	LVS08913	12 clip-on labels 18x35	C-51
LVS08830	IP41 canopy W600 PrismaSeT G IP30/4X	E-7, F-15	LVS08914	12 engraving plates 18x35 /support 08913	C-51
LVS08831	IP41 canopy W600+W600 PrismaSeT G IP30/4X	E-7	LVS08915	12 clip-on labels 18x72	C-51
LVS08832	IP41 canopy W600+W300 PrismaSeT G IP30/4X	E-7, F-15	LVS08916	12 engraving plates 18x72 /support 08915	C-51
LVS08833	IP41 canopy W600+W300+W600 g IP30/4X	E-7	LVS08917	12 clip-on labels 25x85	C-51
LVS08836	IP41 canopy W850 PrismaSeT G IP30/4X	E-7	LVS08918	12 engraving plates 25x85 /support 08917	C-51
LVS08837	IP41 canopy W850+W300 PrismaSeT G IP30/4X	E-7	LVS08934	IP55 euro handle for cylinder	E-29
LVS08841	IP43 door gasket I5300 PrismaSeT G IP30/4X	E-7, F-6, F-15	LVS08935	IP55 handle I155	E-29
LVS08842	IP41 CANOPY W600 PRISMASET G ACTIVE	E-7	LVS08936	IP55 door latch+lock-2x405keys	E-29
LVS08843	IP41 CANOPY W600+300 PRISMASET G ACTIVE	E-7	LVS08939	IP55 handle padlocking kit	E-29
LVS08844	IP41 CANOPY W600+600 PRISMASET G ACTIVE	E-7	LVS08961	Touch-up paint brush	C-51
LVS08845	IP41 CANOPY W600+300+300 PRISMASET G ACTIVE	E-7	LVS08963	Adhesive drawing holder	C-51
LVS08846	IP41 CANOPY W600+300+600 PRISMASET G ACTIVE	E-7	LVS08964	Switchboard lighting syst g	C-33
LVS08847	IP41 CANOPY L850 PRISMASET G ACTIVE	E-7	LVS08965	Switchboard portable lamp	C-33
LVS08848	IP41 CANOPY L850+300 PRISMASET G ACTIVE	E-7	LVS09...		
LVS08853	INTERFACE PLATE W300 PRISMASET G IP30	E-12	LVS09932	Double bar lock adaptation	E-29
LVS08854	INTERFACE PLATE W600 PRISMASET G IP30	E-12	LVS09933	Lock with 2 n°2433A keys	E-29
LVS08855	INTERFACE PLATE W800 PRISMASET G IP30	E-12	LVS09937	7mm triangle lock accessory	E-29
LVS08861	Blanking plate/support 200x112 IP55	E-27, E-28	LVS09942	Barrel lock+2 n°242E keys	E-29
LVS08862	Support 200x112 for 8 pb diam22 IP55	E-27	LVS09943	Barrel lock+2 n°3113A keys	E-29
LVS08866	2 cable tie support adapter	C-47	LVS09945	Lock 2 n°455 keys	E-29
LVS08867	2 cable tie support W600 PrismaSeT G	C-47, F-9	LVS09947	7mm male square insert	E-29
LVS08868	4 cable tie support W300 PrismaSeT G	B-33, C-47	LVS09948	8mm male square insert	E-29
LVS08870	Plain metal gland plate W600 /g IP30	E-12			
LVS08871	Cut-out metal gland plate W600 /g IP30	E-12			
LVS08874	Plain metal gland plate W300 /g IP30	E-12			
LVS08875	Cut-out metal gland plate W300 /g IP30	E-12			
LVS08876	Cut-out plate/FL21 gland plate g IP55	E-26			
LVS08878	Plate+plastic interface pack 160 IP30	F-6			
LVS08879	Plain metal gland plate pack 160 IP30	F-6			
LVS08882	Horizontal combination strip W600/g IP30	E-9			
LVS08885	Horizontal combination strip W300/g IP30	E-9			
LVS08886	PrismaSeT G W300 Basic Green Roof IP30	E-7			
LVS08887	Gland plate for W600 plinth floor-st.enc	E-7			
LVS08888	Gland plate for W300 plinth floor-st.enc	E-7			
LVS08889	Gland plate for W850 plinth floor-st.enc	E-7			
LVS08893	PrismaSeT G W600 Basic Green Roof IP30	E-7			
LVS08898	Gl.plate 39 in D7-26mm dir.mount.g IP55	E-26			
LVS08899	Gl.plate 2 in D33-72mm dir.mount.g IP55	E-26			
LVS08900	Switchboard identification pl.	C-51			
LVS08903	12 adhesive label holders 24X432	C-51			
LVS08904	12 adhesive label holders 36x432	C-51			
LVS08905	12 adhesive label holders 24X180 W300	C-51			

Presentation

Contents

PrismaSeT G - Reliable, Easily connected	B-4
Wireless Sensor for Early Detection of Overheating Cables	B-5
PrismaSeT G Pack 160 - 250 enclosures up to 630 A - IP30, IP40, IP41, IP43, IP55	B-9
PrismaSeT P cubicles up to 4000 A - IP30, IP31, IP55	B-11
The switchboard, central to the electrical installation	B-14
Original Manufacturer and Assembly Manufacturer: Both involved in tested assemblies	B-15
The main 10 functions of standard IEC 61439	B-16
Electrical switchboards up to 630 A	B-18
Modular Devices	B-21
Upgradable PrismaSeT Functional Units	B-22
ComPacT NSX circuit breakers for PrismaSeT G Source changeover system	B-23
Presentation of FuPacT fusegear for PrismaSeT G	B-24
Harmony - Switches and Pushbuttons	B-25
Smart Panel	B-26
Rapsody Software	B-29
Green Premium - Endorsing Eco-Friendly Products in the Industry	B-34

PrismaSeT G - Reliable, Easily connected

New design with sustainable packaging

Enhance buildings with in-built connectivity and efficient design

The new design of PrismaSeT G increases the robustness of the panels, helps to gain efficiency on every level and provides peace of mind to the panel builders, electrical contractors and facility managers.

In addition, the new 100% green packaging decreases the quantity of waste and its disposal cost by using only cardboards.

Green Packaging

- Progressive cancellation of plastic and polystyrene of packaging.
- 100% recyclable cardboards.
- Time & money saving to sort waste.
- New cross beam in cardboard for a more robust packaging.



Increase Plinth Robustness

- Metallic reinforcement all along the plinth to facilitate transportation.

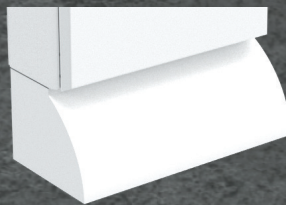

New Improved Handle

- More robust handle.
- Ergonomic handle design.
- Aesthetically appealing look.



Digital Instruction Sheets

- Cancellation of systematic printed instruction in each packaging.
- 1 printed 'Super Leaflet' with all instructions (available to order once).
- 1 systematic QR code to link to the right instruction sheets.



Wireless Sensor for Early Detection of Overheating Cables



SMT10020

HeatTag is a smart sensor for early detection of overheating wire connections or overheating cables. HeatTag helps prevent electrical switchboards from being damaged, by analyzing gas and particles in the air and sending alerts before any smoke or insulator browning.

Standards

The HeatTag smart sensor complies with the following standards:

- IEC 61010-1:2017 UL/CSA/EU CENELEC deviations
- IEC/EN 61326-1b FCC Part 15B and 15C
- ETSI/EN 300328
- ETSI/EN 301489-1
- IEEE 802.15.4

Note:

Do not use HeatTag as a safety device. HeatTag does not replace the fire protection devices of the building.

Presentation

HeatTag smart sensor:

- Sends three levels of alert depending on the severity of the situation it detects.
- Helps prevent potential fire damages by analyzing gas and micro-particles emitted by cable sheaths when overheating.
- Measures temperature and humidity.
- Communicates with all Schneider Electric EcoStruxure panel servers or gateways.
- Is integrated in EcoStruxure solutions.

The HeatTag sensor must be installed only in non-forced air ventilated switchboards. It must be mounted on a DIN rail.

During the first 30 minutes after commissioning, HeatTag can generate an alert for test. It then takes another 8 hours for HeatTag to define its nominal environment and to be fully operational. Each time the HeatTag sensor is powered on, these 30-minute and 8-hour sequences are repeated.

Operation

Paired with Schneider Electric panel servers or gateways, HeatTag reports:

- Alerts
- Air quality index
- Temperature and humidity measurement
- Self-diagnosis information

Air Quality

HeatTag provides an air quality index, ranging from 0 to 10, and displays the air quality evolution trend in a table.

When the air quality index is equal or above 10, HeatTag sends an alert. It has detected abnormal cable sheath heating in the switchboard.

Detection Alert

An alert is triggered when HeatTag detects abnormal cable sheath heating in the switchboard, which can be caused by:

- One or more loose connections (too high contact resistance)
- A poorly sized cable compared to the rated current
- Overcurrent and poorly regulated protective equipment

Alerts are triggered with three severity levels:

- Low level: a cable is slowly overheating in the installation, you must plan a maintenance visit of the installation.
- Medium level: a cable is overheating in the installation, you must go quickly to the installation for maintenance.
- High level: a cable overheats very quickly, you must check the installation immediately.

The orange application led flashes when HeatTag sends an alert to the panel servers or gateways.

Temperature

HeatTag provides a temperature value with a 30 second default transmission period. The transmission period can be increased by the system in case of high wireless data traffic.

Humidity

The HeatTag provides a humidity rate with a 30 second default transmission period. The transmission period can be increased by the system in case of high wireless data traffic.

Self-Diagnosis

HeatTag carries out two types of diagnosis:

- A minor alert is sent when the fan rpm is 80% of its nominal rpm, which means fan clogging.
- A major alert is sent when HeatTag is faulty. In this case it cannot report measures at all, nor reports incorrect measures.

Wireless Sensor for Early Detection of Overheating Cables

HeatTag Smart Design

- No settings
- Nominal environment auto-learning to avoid false alerts
- Concentrator auto-discovery
- Alerts generated by a powerful algorithm integrated in HeatTag

Electrical Characteristics

Supply voltage	110-277 V AC, -15 % / +15 %
Frequency	50-60 Hz
Max. consumption	0.1 A
Operating temperature	-15 °C / +70 °C (5 °F to 158 °F)
Storage temperature	-20 °C / +85 °C (-4 °F to 185 °F)
Relative humidity in operation	15-90 %
Altitude of use	0-2000 m (0-6500 ft)
Degree of pollution (IEC 60664-1)	3
Overvoltage category	OVC III

Sensor Characteristics

Temperature measurement	Measurement range	-15 °C / +70 °C (5 °F to 158 °F)
	Measurement accuracy	-1.1 °C / +1.1 °C
	Default transmission period	30 seconds (higher in case of high wireless data traffic)
Humidity measurement	Measurement range	15-90 %
	Measurement accuracy	±9 RH %
	Default transmission period	30 seconds (higher in case of high wireless data traffic)
Air quality		Index (0 to 10), alert generation when index ≥ 10
Test alert after pairing		During the first 30 minutes
Environment auto-learning phase		8 hours after the first 30 minutes

Installation

Communication Architecture

List of compatible communicators:

- EcoStruxure Panel Servers
- PowerTag Link
- PrismaSeT Wireless Panel Server

Wiring

HeatTag must be protected by 2 A breaker.

It is delivered with a separate connector.

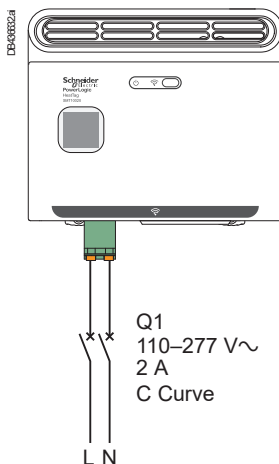

Mechanical Characteristics

Dimensions (w x h x d)	108 x 107 x 55 mm
Weight	270 g
Degree of protection (IEC 60529)	IP20

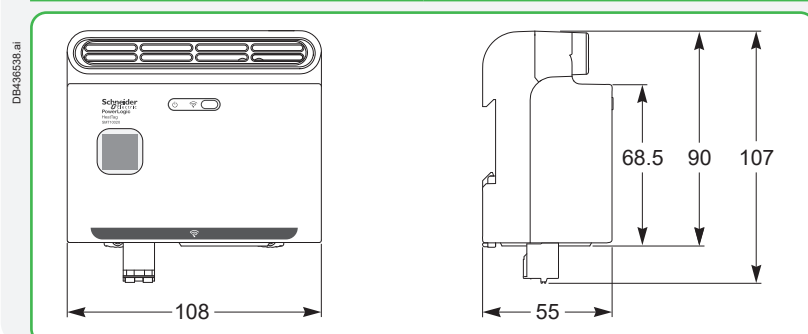

Wireless Sensor for Early Detection of Overheating Cables

Integration in PrismaSeT G

HeatTag must be installed following the Instruction Sheet recommendations (MFR5173801-02).

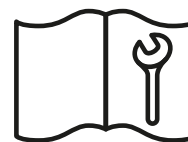
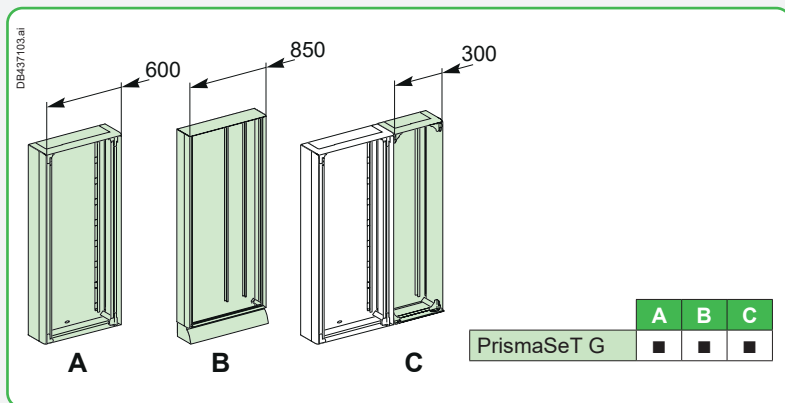

MFR5173801-02



HeatTag must be installed on a DIN rail.

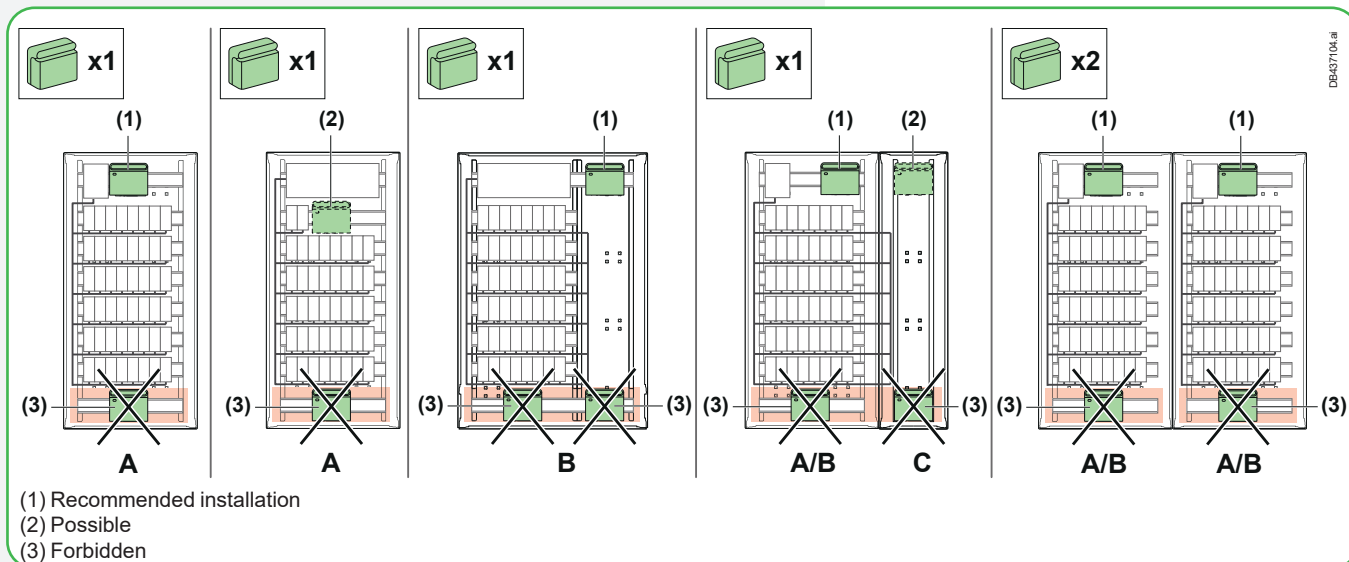
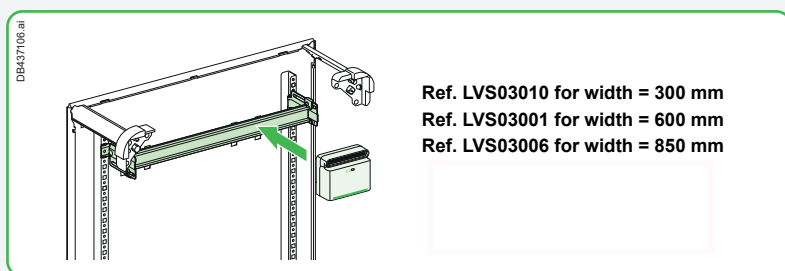

To respond to increasing building requirements

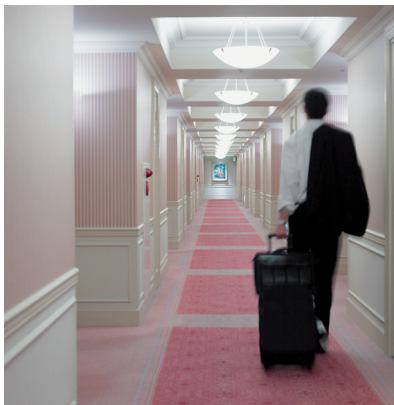

Improve the continuity of service



Ensure the safety of life and property



Control deadlines and costs

PrismaSeT:

the optimised, tested and IEC compliant solution,
for low voltage electrical distribution and control switchboards.

B



PrismaSeT, a comprehensive range of enclosures and cubicles

- > A solution based on more than **30 years of experience** in low voltage switchboards.
- > Integrating Schneider Electric switchgear offerings and ensuring electrical, mechanical and communication **functions complete consistency**.
- > Quality production, **certified ISO 9001** and manufactured in Montmélian (France).

Pack 160 A enclosures PrismaSeT Pack 250 A enclosures PrismaSeT G enclosures IP30 / IP4X, IP55, up to 630 A



160 A

250 A

630 A

- Schools
- Small shops
- Hotels, etc.

Pack



- Small companies
- Buildings
- Offices
- Laboratories
- Healthcare centres
- Hotels
- Supermarkets
- Malls, etc.

PrismaSeT G



PrismaSeT P cubicles up to 4000 A IP30, IP31, IP55

The optimised, tested and IEC compliant solution, for low voltage electrical distribution and control switchboards.



- Hospitals
- Data centres
- Logistics centres
- Shopping centres
- Offices buildings
- Medium industrial solutions

PrismaSeT P



Simple, functional systems for safe, up to 630 A



Switchboards that are safe...

With **PrismaSeT G** you can be sure to build **100 % Schneider Electric** switchboards that are safe, optimised:

- > All components (switchgear, distribution blocks, prefabricated connections, etc.) are perfectly rated and coordinated to work together;
- > All switchboard configurations, even the most demanding ones, have been tested.

You can prove that your switchboard meets the current standards, at any time.

You can be sure to build a reliable electrical installation and give your customers full satisfaction in terms of dependability and safety for people.

...aesthetics

PrismaSeT G with its discreet design, blends harmoniously into all tertiary buildings, including in entrance halls and passageways.



Available power

Safety of people and property

Controlled costs and delivery times

Upgradeability

upgradeable LV switchboards

...optimised and upgradeable

With **PrismaSeT G** you can build just the right switchboard for your customer, sized precisely to fit costs and needs. With this complete, prefabricated and tested system, it's easy to upgrade your installation and still maintain the performance levels.

- > The wall-mounted and floor-standing enclosures combine easily with switchboards already in service.
- > Devices can be replaced or added at any time.



Simple gestures for cabling in the workshop



All connection points are fully accessible and easy to check.

Efficient installation and connection work on site



Easy connection on site, whatever the cable cross-section or installation location.

Easy maintenance throughout the switchboard



Easy and direct access to devices, in a switchboard in service.

The switchboard, central to the electrical installation

Both the point of arrival of energy and a device for distribution to the site applications, the LV switchboard is the intelligence of the system, central to the electrical installation.

It plays an essential role in the availability of electric power, while meeting the needs of personal and property safety. Its definition, design and installation are based on precise rules; there is no place for improvisation. The IEC 61439 standard aims to better define "low voltage switchgear and controlgear assemblies", ensuring that the specified performances are reached. It specifies in particular:

- > the responsibilities of each player, distinguishing those of the original equipment manufacturer; the organisation that performed the original design and associated verification of an assembly in accordance with the standard, and of the assembly manufacturer - the organisation taking responsibility for the finished assembly;
- > the design and verification rules, constituting a benchmark for product certification.

All the component parts of the electrical switchboard are concerned by the IEC 61439 standard. Equipment produced in accordance with the requirements of this switchboard standard ensures the safety and reliability of the installation.

A switchboard must comply with the requirements of standard IEC 61439-1 and 2 to guarantee the safety and reliability of the installation. Managers of installations, fully aware of the professional and legal liabilities weighing on their company and on themselves, demand a high level of safety for the electrical installation.

What is more, the serious economic consequences of prolonged halts in production mean that the electrical switchboard must provide excellent continuity of service, whatever the operating conditions.

The Schneider Electric solution

- > Specify switchboards that comply with standard IEC 61439-1 and 2.
- > Guarantee a level of safety that has been 100 % tested, from the day the switchboard is installed and throughout its service life.
- > Ensure a lasting investment through easy upgrading of the installation in compliance with the standard.
- > Guarantee that the switchboard complies with the technical specifications.

PrismaSeT tested switchboards

The conformity of the switchboard has been tested and proven.

A PrismaSeT switchboard is:

- > made up of Schneider Electric low voltage devices and components that all comply with the applicable standards;
- > based on configurations in our catalog;
- > made up of PrismaSeT and Linergy mechanical and electrical components that have been subjected to the verification of original equipment manufacturer;
- > mounted and wired by a panelbuilder in compliance with professional standards;
- > subjected to the individual verification.

Schneider Electric makes available to the panelbuilder everything required to create tested PrismaSeT switchboards, including the basic configurations in the low voltage distribution catalog, all the documentation for switchboard design and mounting, calculation and design software, etc.

Panelbuilders can demonstrate conformity with standard IEC 61439-1 and 2 by presenting the declarations or certificates of conformity for type tests carried out by independent laboratories (ASEFA, ASTA, etc.) and supplied by Schneider Electric. The panelbuilder is responsible for the individual routine verification and delivers the corresponding declarations of conformity.

Original Manufacturer and Assembly Manufacturer: Both involved in tested assemblies

Standard IEC 61439 clearly defines the type of verifications that must be conducted by both organisations involved in final conformity of the solution: the **Original Manufacturer**, guaranteeing assembly system design and the **Assembly Manufacturer**, responsible for the final conformity of the switchboard.

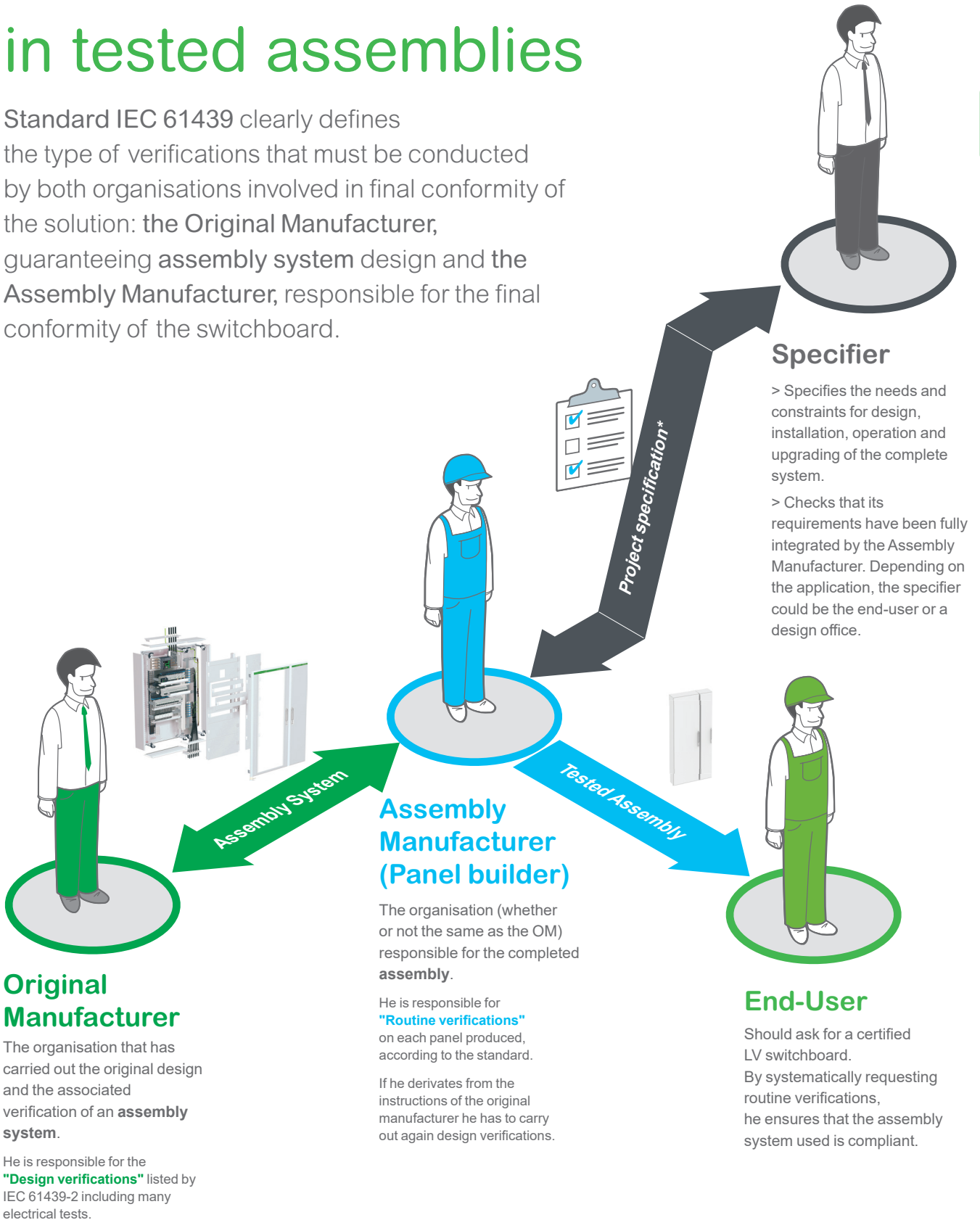

B

The main 10 functions of standard IEC 61439

For each of the following 10 functions, the standard IEC 61439 requires design verifications from the system manufacturer - mainly through type-tests - and routine verifications on each panel from the Panel Builder to achieve 3 basic goals: safety, continuity of service and compliance with end-user requirements.



Safety

Voltage stresses withstand capability

To withstand long term voltages, and transient and temporary overvoltages according to the insulation coordination principles and requirements.

Current-carrying capability

To protect against burns and to withstand temperature rise:

- > when any circuit is continuously loaded, alone, to the specified current
- > when the **assembly** is loaded to the specified current according to the specified load pattern (between circuits and/or as a function of the time).

Short-circuit withstand capability

To withstand the stresses resulting from the prospective short-circuit current and from the associated data (High forces between conductors, temp. rise in a very short time, air ionization, overpressure).

Protection against electric shock

- > Hazardous-live-parts not to be accessible (basic protection)
- > Accessible conductive parts not to become hazardous-live (fault protection).

Protection against risk of fire or explosion

- > Resistance to internal glowing elements
- > **Note:** protection of persons, and optional protection of the **assembly**, against arcing due to internal fault can be specified through a "special test" according to IEC 61641.



Continuity of service

Maintenance and modification capability

Capability to preserve continuity of supply without impairing safety during **assembly** maintenance or modification

- > Electrical condition of the **assembly** or various circuits
- > Speed of exchange of the functional units
- > Test facilities...

Electro-Magnetic compatibility

To properly function (immunity) and not to generate EM disturbances (emission) in specified environmental conditions:

- > Industrial networks or locations (Environment A)
- > Domestic, commercial, and light industrial locations (Environment B).



Compliance with end-user requirements

Capability to operate the electrical installation

To properly function, according to:

- > The electrical diagram of the overall system and related information (voltages, coordination...)
- > The specified operating facilities (e.g. free or restricted access to Man Machine Interfaces, isolation of the outgoing circuits...).

Capability to be installed on site

- > To withstand handling, transport, storage... and installation constraints
- > Capability to be erected and connected (type of enclosure, type, material and cross sectional areas of external conductors).

Protection of the **assembly** against mechanical and atmospheric environmental conditions

- > Presence of water or solid foreign bodies (IP according to IEC 60529)
- > External mechanical impacts (optional IK according to IEC 62262)
- > Indoor or outdoor installation (humidity, UV).

IEC 61439-1 paragraph 11.4

Protection against electric shocks and integrity of protection circuits

The following should be checked visually:

- > presence of protective shields against direct and indirect contacts on live parts;
- > presence of the PE conductor.

The continuity of protection circuits is ensured by compliance with the assembly instructions delivered with each product.

IEC 61439-1 paragraph 11.5

Integration of incorporated components

The assembly manufacturer must comply with the instructions of the original equipment manufacturer for installation and wiring of the components used.

IEC 61439-1 paragraph 11.6

Internal electric circuits and connections

Schneider Electric recommends marking the nut with a tinted acrylic lacquer, indelible and temperature-resistant.

This allows:

- > not only self-checking to check effective tightening to torque;
- > but also identification of any loosening.

IEC 61439-1 paragraph 11.9

Dielectric properties

The main circuits, and the auxiliary and control circuits connected to the main circuit, shall be subjected to the test voltage in accordance.

IEC 61439-1 paragraph 11.10

Wiring, operating performance and function

Verification of wiring and marking conformity with the drawings, parts list and diagram.

Standard individual check sheet

in accordance with the IEC 61439-1 and 2 standard from the assembly manufacturer (panelbuilder)

B

Job No.:

Switchboard No.:

Drawing No./Rev. No.:

	Chapter	Verified
Degrees of protection provided by enclosures	11.2	<input type="checkbox"/>
Insulation clearances and creepage distances	11.3	<input type="checkbox"/>
Protection against electric shocks and integrity of protection circuits	11.4	<input type="checkbox"/>
Integration of incorporated components	11.5	<input type="checkbox"/>
Internal electric circuits and connections	11.6	<input type="checkbox"/>
Terminals for external conductors	11.7	<input type="checkbox"/>
Mechanical operation	11.8	<input type="checkbox"/>
Dielectric properties	11.9	<input type="checkbox"/>
Wiring, operating performance and function	11.10	<input type="checkbox"/>

Date of verification:

..... / /

Verifications performed by:

.....

The PrismaSeT G functional system can be used for all types of low voltage distribution switchboards up to 630 A, in commercial and industrial environments.



PB113427.eps

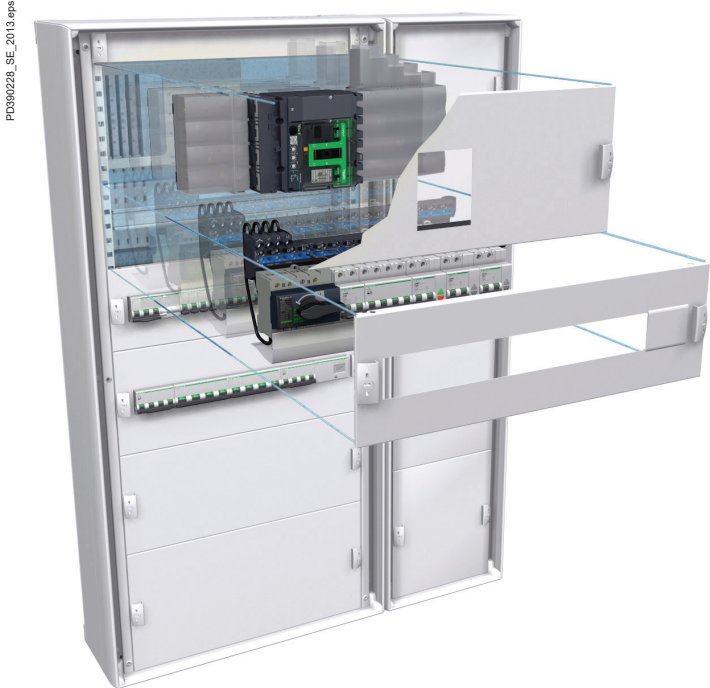

PD090228_SE_2013.eps



Switchboard design is very simple

1 A metal structure

The switchboard is made up of one or more enclosures, combined width-wise and/or height-wise, with a choice of doors (plain or transparent).

2 A distribution system

A complete offer of centralised or row distribution blocks, with busbars in duct or on rear of enclosure, provides current distribution over the full height of the switchboard.

3 Complete functional units

Built around each device, the functional unit includes:

- a dedicated mounting plate for device installation
- a front plate to block direct access to live parts
- prefabricated busbar connections to connect devices to the busbar
- cable-running accessories can be clipped onto the back of double-profile modular rails.

Each functional unit contributes to a function in the switchboard. The system includes everything required for functional unit mounting, supply and connection.

The PrismaSeT G and functional unit components, in particular, have been designed and tested according to device characteristics.

This design approach ensures a high degree of reliability in system operation and optimum safety.



Assets of PrismaSeT switchboards

1 A dependable electrical installation

The total compatibility of Schneider Electric devices with the PrismaSeT enclosure is a key advantage in ensuring a high level of installation dependability.

2 An upgradeable electrical installation

Thanks to modular design, PrismaSeT switchboards can be easily modified to integrate new functional units as needed.

Maintenance operations, carried out with the switchboard de-energised, are fast and straight-forward due to easy access to devices.

3 Total safety for personnel

Work in a switchboard must be carried out by authorised persons in compliance with all applicable safety regulations.

To increase the safety of personnel, devices are installed behind protective front plates; only the operating handles are accessible.

Additional internal protection (partitions, barriers) is available to protect against direct contact with live parts.

Terminal shields are mandatory for installing ComPacT NSX and INS/INV devices in PrismaSeT for even more personnel safety.

Electrical switchboards up to 630 A

System design has been validated by type tests as per standard IEC 61439-1 & 2 and benefits from the combined experience of Schneider Electric over many years.

PB115632_73_09fs

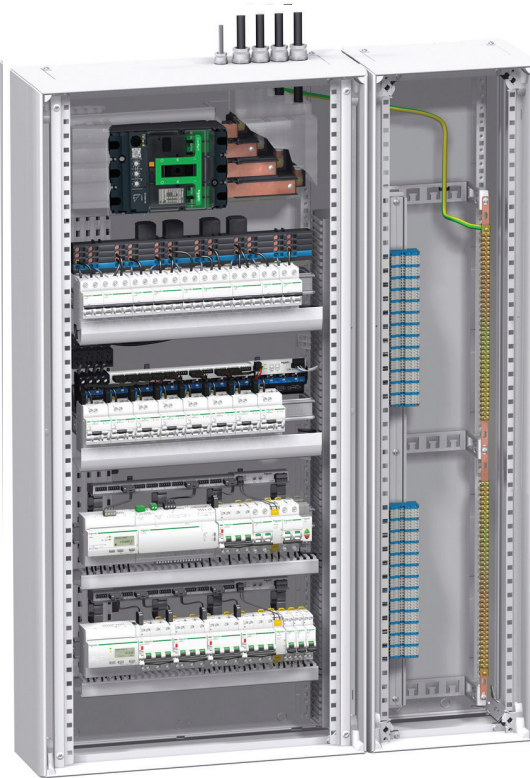

Electrical characteristics

Comply with IEC 62208 and EN 62208 standards:

- rated insulation of main busbars at rear of enclosure: 1000 V
- InA: 630 A
- rated peak withstand current Ipk: 53 kA
- short-circuit current Icc: 70 kA
- frequency: 50/60 Hz

B



Mechanical characteristics

- Steel sheet metal
- Electrophoresis treatment + hot-polymerised polyester epoxy powder, white colour RAL 9003.
- Enclosures supplied in kit form, totally dismantlable, designed to be assembled and wired horizontally on a work station.
- Can be combined side by side and one on top of another
- Degree of protection:
 - IP30: without door
 - IP40: with door
 - IP41: with door + canopy
 - IP43: with door + gasket + canopy
 - IP55: IP55 PrismaSeT G offer, supplied in kit form
- degree of protection against mechanical impacts:
 - IK07: without door
 - IK08: with door (transparent)
 - IK10: with plain door
 - IK10: for PrismaSeT G IP55
- Seismic characteristics: 2,5G without accessories
- Enclosure dimensions:
 - 3 widths:
 - W = 300: ducts
10 modules width
 - W = 600: Wall-mounted and floor-standing enclosures,
24 modules width
 - W = 850: Floor-standing enclosures
36 modules width
 - depth with door:
 - enclosures G IP30: 250 mm
 - enclosures G IP55: 260 mm
 - heights:
 - PrismaSeT G IP30: 12 heights: 330 mm to 1980 mm
 - PrismaSeT G IP55: 7 heights: 450 mm to 1750 mm
- Inside switchboards.



Readily available close by

The kit concept makes handling and transport easier and you get to benefit from Schneider Electric's efficient international logistics. Your distributor, hand-picked by Schneider Electric, can give you the very best advice.



Electrical switchboards built using the PrismaSeT functional system and Schneider Electric recommendations fully comply with international standard IEC 61439-1&2.

With PrismaSeT, your solution is 100 % optimised

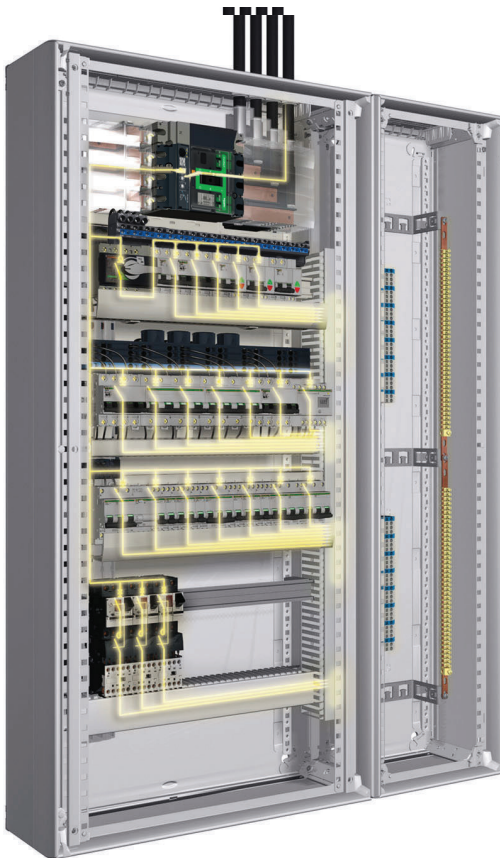

Flexible design for building applications and their operation

Thanks to PrismaSeT solutions, design offices can design and customise switchboards easily and quickly:

- > organisation by functional units, each corresponding to an application in the building (lighting, HVAC, lifts, etc.)
- > organisation by dedicated physical zones: one for functional units (switchgear, mounting plates, front plates), one for power distribution, and one for connections.

100 % dependable and optimised design, in compliance with costs and deadlines

By supporting design offices with the services and software tools (Ecodial, Rapsody...) needed to quickly design switchboards, we help them to highlight their professionalism: switchboards with tested architectures to meet the most stringent specifications.

Our tools and services also enable them to meet requirements concerning compliance with costs and deadlines: optimised selection of the appropriate components for each switchboard (switchgear, distribution systems, enclosures with perfect electrical and mechanical consistency), front panel design and fast cost studies.



100 %

of dedicated building switchboard architectures are tested in compliance with IEC standards and can be customised.

Modular devices

Acti 9

NG125, C120 circuit breakers INS-INV40/160 switch disconnecter



Presentation

A double-profile modular rail offering a high level of performance
Made of an aluminium alloy with a magnetic properties, the rail design is extremely rigid. The rail supports are crimp mounted.

Fast mounting

The supports have positioning studs to guide the rail on the rear uprights. Only two mounting screws are required.

Multiple functions

A number of devices can be clipped directly onto the rails, including Linergy FM 80 and 200 A distribution systems, all horizontal cable-running accessories such as cable straps and trunking supports, as well as the supports for Linergy TB earth bars.

Supply from all directions

Supply to the rows, using Linergy FH comb busbars or Linergy FM distribution systems via:

- > Linergy BS or insulated busbar Linergy BW installed behind the devices.
- > Linergy BS busbar installed in the duct.

Centralised power supply

Via Linergy DX or DS distribution blocks, Linergy DP.

PB115632_09 eps

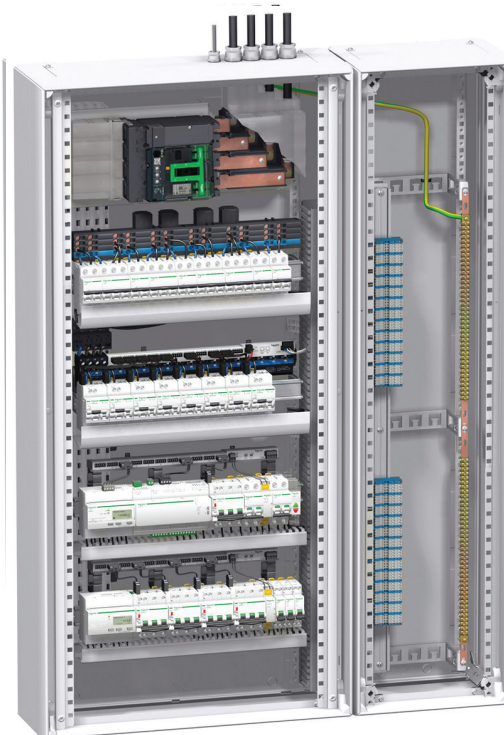

B



Distribution

Linergy FM 80 and 200 A device feeders

- > Fast and secure front connection using spring terminals.
- > Reliable connections, with balanced tightening, insensitive to vibrations and thermal variations.
- > All types of modular devices can be mixed.
- > Easy balancing of phases.
- > Interchangeable devices.
- > Easy installation upgrades.
- > Fully insulated (IPxxB).

Linergy FH comb busbars

- > Direct connection to device terminals or via a connector.
- > Fully insulated.
- > Can be cut to length.

Linergy DX quick distribution blocks

- > See page D-10

Linergy DP distribution blocks

- > See pages D-12, D-13

Linergy DS screw distribution blocks

- > See page D-14



Cable running

Straps

- > Easy and fast to install.
- > Low cost.
- > Perfectly organised and integrated cable running
- > Professional finish.
- > Mounting at the back of modular rail, very comPacT dimensions.

Trunking

- > Traditional solution.

PB115636 eps

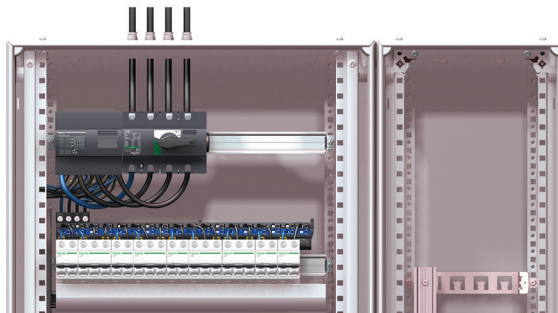

Upgradeable PrismaSeT functional units = the best electrical + mechanical + communication consistency.

Functional units include switchgear mounting plates, front plates, connections, barriers for ensuring the best level of continuity of service, and helps in securing life and property.



ComPacT NSX up to 630 A
> page C-3



ComPacT NSXm up to 160
> page C-3



ComPacT INS-INV250-630 A
> page C-17



ComPacT INS-INV 40 to 60
> page C-31



Source changeover systems
ComPacT NSX
> page C-21



Source changeover systems
ComPacT INS-INV
> page C-22



FuPacT GS from 32 to 160 A
> page C-26

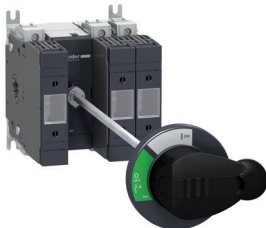

FuPacT ISFT from 160 to 250 A
> page C-28



NG125, INS-INV40 to 160,
C120 - Acti 9
> page C-31



Industrial control switchgears, metering
> page C-35
Human-switchboard interface
> page C-37



ComPacT NSX circuit breakers for PrismaSeT G Source changeover system



Presentation

A range of intelligent circuit breakers

ComPacT NSX improves management of electrical installations

In addition to protection functions, the new generation of ComPacT NSX moulded-case circuit breakers provides new features (analysis, measurements and communication) with access to information:

- > either directly on the LCD screen of the trip unit to set the circuit breaker or read the main electrical values, including U, I, f, P(W) and E (kWh)
- > or on the FDM 121 or FDM128 display on the front of the PrismaSeT switchboard (duct door with special front plate) for quick access to a greater wealth of information.

A cable connects the display to the trip unit without any special settings or configuration, making it easy to personalise alarms and displays or read event logs and maintenance indicators.

Integration of ComPacT NSX in PrismaSeT

Installation of ComPacT NSX devices in a PrismaSeT functional switchboard is very easy and made of a functional unit system:

- > dedicated mounting plates for ComPacT NSX offer
- > matching power connections Linergy DP distribution block and prefabricated connections, connection blocks, power supply blocks)
- > partitioning
- > compliance with the safety perimeter, by design.

Installation architectures for the measurement function

ComPacT NSX circuit breakers equipped with Micrologic 5/6 A or E trip units provide measurements that can be read on the FDM 121 or FDM128 display module or directly on the circuit breaker. This makes it possible to optimise the space required by the functional unit.

Installation times have also been reduced with respect to system with current transformers.

What is more, installation and connections are made easier because the FDM121 or FDM128 may be installed:

- > via a direct cut-out in a plain door
- > on the front of a W600 enclosure for one or four 96 x 96 devices on partial door cut-out.

A new front plate

The front of ComPacT NSX circuit breakers has an eye-pleasing curved profile, making PrismaSeT switchboards even more attractive. Assets of PrismaSeT switchboards. PrismaSeT front plates are designed for all types of controls (toggle, motor mechanism, rotary handle).

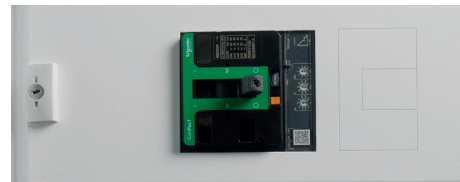

Presentation



To ensure the supply of energy at all times, certain electrical installations are connected to two

sources:

- > normal source S1
- > replacement source S2 which steps in to supply the installation if the normal source is not available.

A mechanical and/or electrical interlocking system between two ComPacT switch-disconnectors or circuit breakers (or a mixture) avoids simultaneous connection of the two sources during switching. In PrismaSeT G, a manual changeover with mechanical interlocking of devices may be installed.

This is the simplest system. A human operator is required and consequently, the transfer from the normal source to the replacement source is delayed.

A manual source-changeover system comprises two or three manually controlled devices (circuit breakers or switch-disconnectors) that are mechanically interlocked.

The interlocking system avoids simultaneous connection (even transient) of the two sources.

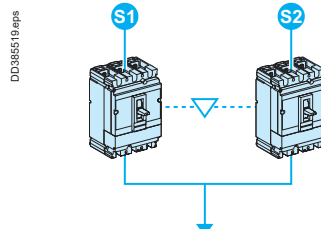

For more information on the communication functions of ComPacT NSX, see the ULP system user manual, ref. TRV99100, and the ComPacT NSX catalog, ref. LVPED208001_EN. See catalog "ComPacT, MasterPacT source changeover systems", ref. LVPED21122EN



Presentation of FuPacT fusegear for PrismaSeT G

★ Presentation

Whatever the switchboard configuration, PrismaSeT range offers tested and certified solution guaranteeing the safety of life and properties.

2 families of FuPacT fusegears

FuPacT GS

FuPacT GS ensures your power application for:

- > distribution switchboards
- > disconnection, isolation, locking and primary control of incoming circuits
- > emergency stop,
- > motor feeders (protect motors against single-phasing).

FuPacT fusegears have a test position for greater flexibility, easy to use.



FuPacT ISFT

FuPacT ISFT fuse-switch disconnectors are particularly suited for:

- > secondary distribution circuits
- > powering and control of industrial motors as local isolation device.



✂ Installation

- > FuPacT fusegears have dedicated mounting plates and front plates.
- > The upstream and downstream connections are made by the panelbuilder.
- > Vertical mounting allows to install several FuPacT fusegears.

Positioning and mounting of the devices in the switchboard and filling rate of it take into account temperature rise, withstand short-circuit capacities, isolation clearances.





Presentation

Get more out of your electrical panels with robust and ergonomic pushbuttons, switches.

Robust performance that can withstand even the most severe environments.



Metal_Green-010-CM,IN.psd

A touch of style electrical panels and machines.

Modern design for customizing new and existing enclosures to meet the requirements of customers.

New offers, taking smart panels to the next level.

The new USB and RJ45 ports offer you a simple, effective way to connect a PC or USB memory device right to the front plate of your machine enclosure to:

- > Export data
- > Update the PLC and HMI program
- > No need to open the door:
 - Eliminate electrical hazards
 - Keep dust out of the enclosure



XBE_633_CPSC16029A.eps



XBE_633_CPSC16027B.eps



Standards

Harmony metal accessories for robust performance in all situations

From severe environments and potentially-explosive atmospheres, to extremely hot or cold temperatures, you can count on Harmony.

- > Compliance with international standards (IEC, UL, CSA, CCC, EAC, JIS)
- > Marine certified (BV, RINA, LROS, DNV, GL)
- > Sealing effectiveness rated (IP66, IP67, IP69, IP69K, Type 4X)
- > Operating temperature range of -40 °C
- > to +70 °C
- > High impact resistance: up to IK06
- > High vibration resistance: shake-proof connector screws
- > Standard and low-load, high-power electrical contact



Installation

The Harmony range for faster, simpler installation

Designed for efficiency that helps keep costs down.

- > Can be mounted with a single hand
- > Fastens with a single anti-rotation locking screw
- > Accessories compatible with the entire Harmony diameter 22 mm range



**Smart Panels:
powerful technologies, easy to implement**

In addition to basic functions and enclosures, the Smart Panel solution is enhanced with new features for collecting and transmitting energy data from the main switchboard panel and all subpanels, making it a highly flexible and accurate energy management system. All the panels, from main, division to tertiary, are smart panels with data gathering and transmission functions).

Smart Panel solution

The Smart Panel solution automates energy usage data collection to eliminate time-consuming and error-prone manual meter reading. Automatic metering at the source lets you see exactly how and where the building is using energy. It also performs intelligent cross references of energy usage:

- by zones (offices, lobby, storage, parking, etc.)
- with usage by type (lighting, heating, hot water for sanitation, etc.).

Metering and monitoring form the basis of the Smart Panel solution.

Energy management has never been simpler



1. Measure

Embedded and stand alone metering & control capabilities

2. Connect

- > Integrated communication interfaces
- > Ready to connect to energy management platforms

3. Act

- > Data-driven energy efficiency actions
- > Real time monitoring and control
- > Access to energy and site information through on-line services



Switchboards are the most convenient location to collect data about electrical supplies throughout the building.

Schneider Electric provides best-in-class devices for electrical protection, control, and measurement, as well as efficient switchboard build-up systems.

We offer new digital possibilities through better connectivity, thanks to the enerlin'X system components embedded in our power operating devices.

Connecting is easy with Smart Panels.

Ethernet is today the most widespread communication protocol in professional building, providing fast data transmission. Thanks to the Enerlin'X digital system, switchboards can be connected via Ethernet like any other device through an RJ45 socket.

The design of Enerlin'X:

- > grouping of similar functions in the smart components (e.g. Acti 9 Smartlink)
- > error-free cabling, fast connection-disconnection
- > space-savings in the enclosure.

Schneider Electric serves the needs of any building, regardless of size and criticality, and helps find savings opportunities.

Our solutions provide different mixes of energy, network, and asset management features tailored to each size. Clear visibility of the energy supply system and consumption is provided by locally installed software while online services offer improved mobility and convenience.

1. Measure

Power supply and protection monitoring, metering

ComPacT circuit breakers and switches

They offer reliable protection as well as support energy management by providing energy consumption date, equipment status, and operational support information.

Acti 9 circuit breakers, residual current devices, surge arresters

Each Acti 9 protection devices contributes to electrical supply reliability. Easy-to-fit auxiliaries transmit real-time status to the Enerlin'X system and additional RCA modules enable digitally controlled resetting after a trip.

Circuit and load control

Acti 9 contactors and impulse relays, remote controlled ComPacT

To improve user comfort, lighting or other loads are switched on and off, separately or all together via the digital system.

PowerLogics meter

monitor key distribution points 24 hours a day, from generators, substations, and services entrances, to main feeders and loads. Help improve network reliability by tracking real-time power quality equipment status, trading loads, and logging events and alarms.

Modular energy meters

Basic kWh meter for elementary applications to MID-compliant meters for billing applications, and advanced energy meters capable of measuring a variety of electrical parameters.

2. Connect

Acti 9 Smartlink

- > Digital interface for Acti 9 or third-party devices.
- > Modular rail clippable, no extra space required; 100 % prefabricated connections.
- > 2 versions: Modbus SL slave or Ethernet + Modbus SL.
- > Automatic e-mail sent upon critical events (configurable).
- > Embedded web pages for energy monitoring & control master.

Com'X 200 energy data logger

- > Collects data from electrical and other devices throughout the building.
- > Delivers batches of data ready to be processed by StruxureWare™ solutions and online services.

Enerlin'X I/O

Provides tailored additional functions.

Enerlin'X IFM

Modbus connection and data collection for one ComPacT device.

Com'X 510 energy server

- > Collects data from electrical and other devices throughout the building.
- > Provides detailed and global views of energy consumption as soon as as connected, with data accessible via web browser.

Enerlin'X IFE

- > Ethernet communication interface for power circuit breakers
- > Embedded web pages for energy control, and maintenance
- > Modbus master, with automatic detection and configuration of "slave" devices
- > Automatic e-mail sent upon critical events (configurable)

3. Act

Enerlin'X FDM121

- > Access to switchgear settings, status, and measurements.
- > Auto discovery of Modbus SL connected devices.

Com'X 510 web pages

- All-in-one energy management for small and medium buildings, allowing you to detect the most important opportunities for savings.
- > Provides dashboards and historical trend charts for consumption, viewable via web browser.
 - > Connection to network via WiFi or Ethernet.
 - > Aggregates electrical data with gas, steam, air, water.

Powerview

User-friendly web pages

User-friendly displays of all datas stored in enerlin'X devices, accessible via Ethernet and viewable with web browsers. includes user-configurable e-mail notification feature.

Remote access

Powerview webpages accessible anytime anywhere through secure, private internet access. User-configurable e-mail notification feature also included.

Rapsody software

Easy design with Rapsody software

A time-saver in the design and quotation phases.

More flexibility since modifications and upgrades are possible throughout the project.



5 easy steps to design a switchboard

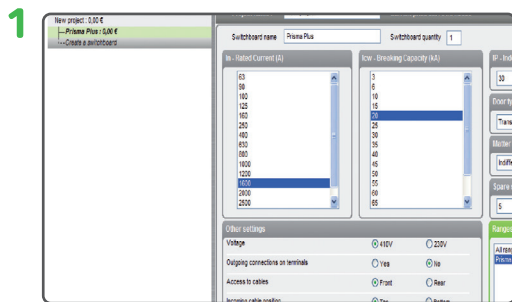

Define the switchboard's electrical and environmental characteristics, in a few clicks.

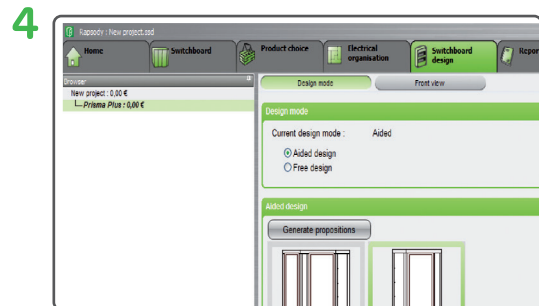

Choose the switchboard and let the software set up the enclosure.

A list of mounting and connection accessories is proposed to make mounting work easier.

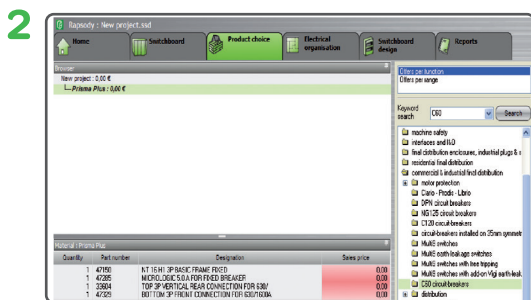

Choose and configure the devices to be installed, with no risk of error.

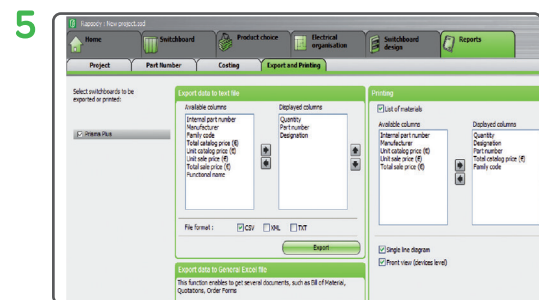

Automatically **export** the information required to make a clear, comprehensive and professional quotation.

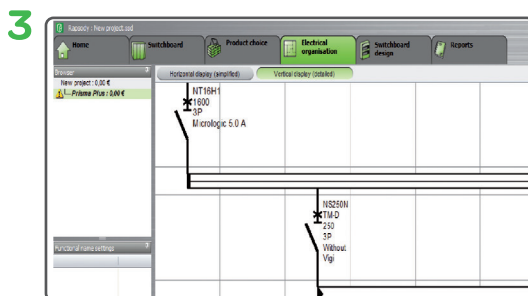

Customise, and easily modify the single-line diagram. **Move or duplicate** devices. **Generate** current distribution and connection systems.

Incomer

INS-INV 160 A

Incoming cables via top

Distribution

Linery DX distribution block 4P

Outgoing devices

Acti 9 devices

Supply Linery FM distribution block +
Linery FH comb busbar

Cable running Straps + cover + trunking

Connection Linery TR, TB terminal block at
bottom of switchboard

IP30/IP4X enclosure

Wall-mounted enclosure, W = 595 mm, H = 1080 mm

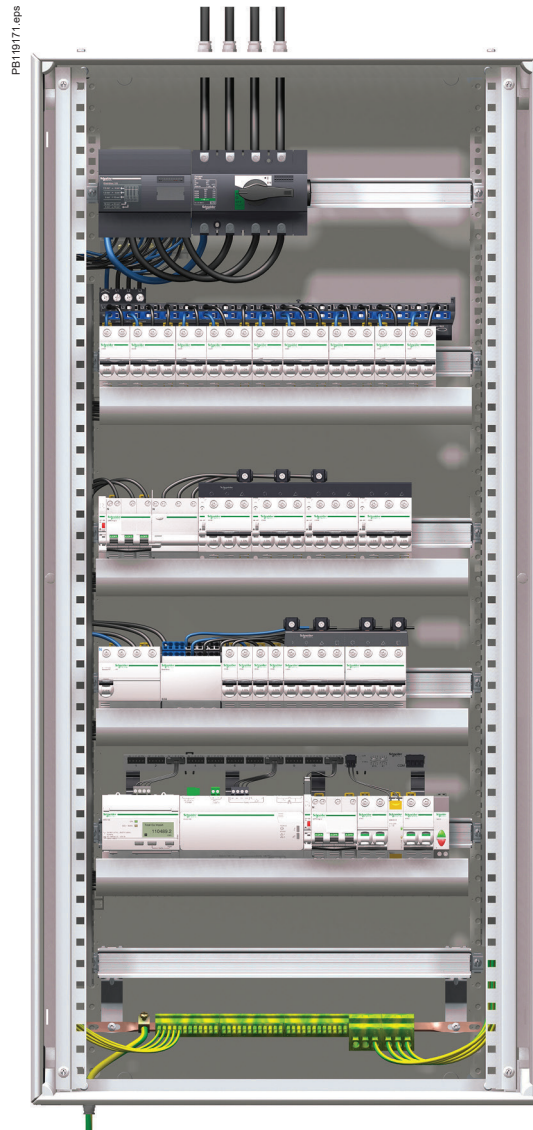

Incomer

ComPacT NSX250
 Fixed, front connection
 Toggle
 Incoming cables via top on incoming connection block

Distribution

Linergy BW rear busbar

Outgoing devices

Acti 9 + NG160 devices

Supply Linergy FM + Linergy FH comb busbar + Linergy DS distribution block 4P + Linergy DX

Cable running Straps + cover + trunking

Connection Linergy TR, TB terminal block in duct

IP30/IP4X enclosure

Wall-mounted enclosure, W = 595 mm, H = 1450 mm
 Duct W = 305, H = 1450

PEB118172.eps

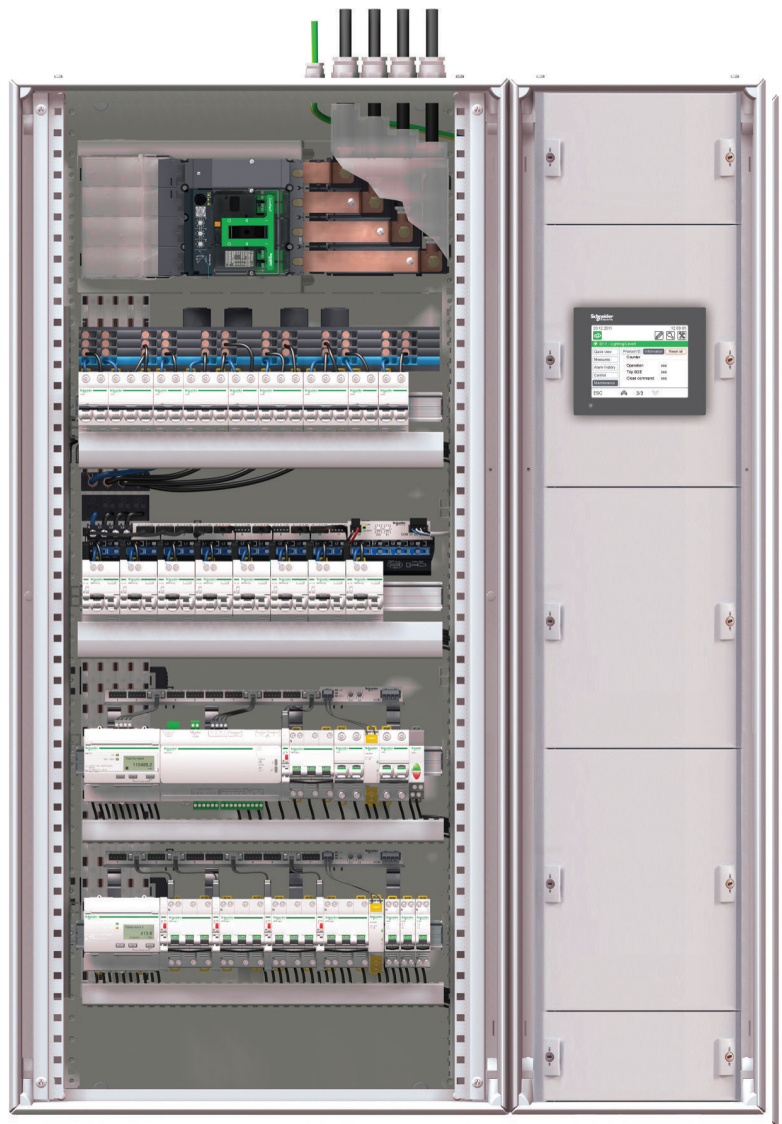

B

Starting with the electrical diagram: IP30/IP4X switchboard

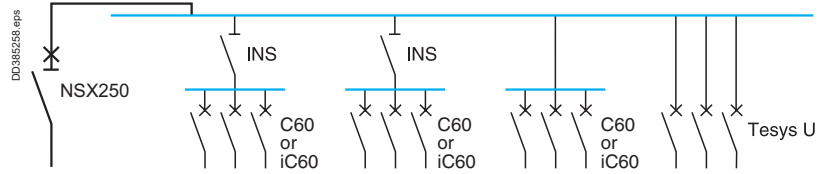

Install the incomer

> see page C-3

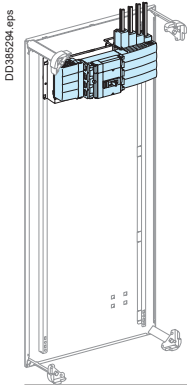

- order the mounting plates and the front plates
- the incoming connection block
- the power supply block for the Linergy BW busbars.

1 Installation / connection

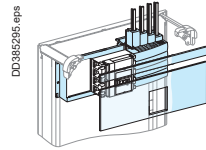

2 Distribution using Linergy BW busbars

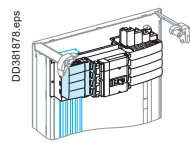

Device	No. of vertical modules	Mounting plate	Cut-out front plate	Upstream front plate	Connection block Cables via top	Cables via bottom
Fixed ComPacT NSX						
NSX100/250	5	LVS03030	LVS03232	LVS03801	LVS04066	or LVS04067

Device	Power supply block	Terminal shields (set of 2)	Linerigy BW busbars
Fixed ComPacT NSX and VigicomPacT NSX			
NSX100/250	LVS04060		

Install the modular devices

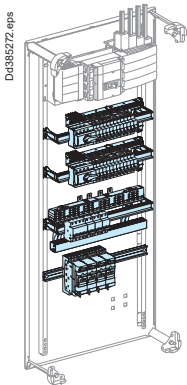

- Order the mounting plates and front plates taking into account:
- supply to the rows
 - cable running.

1 Acti 9

> see page C-31

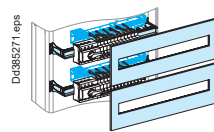

Device	No. of vertical modules	Modular rail	Modular front plate
All Multi 9 or Acti 9 devices			
All supply systems (Linerigy FH) with cable straps and trunking sections	4	LVS03001	LVS03204
Multi 9 or Acti 9 devices y 40 A			
Supply via 63/80 A Linergy FM or Linergy FH with cable straps	3	LVS03001	LVS03203

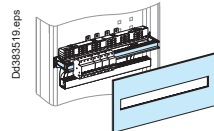

Device	No. of vertical modules	Modular rail	Modular front plate
All Multi 9 or Acti 9 devices			
All supply systems (Linerigy FH) with cable straps and trunking sections	4	LVS03001	LVS03204
Multi 9 or Acti 9 devices y 40 A			
Supply via 63/80 A Linergy FM or Linergy FH with cable straps	3	LVS03001	LVS03203

2 TeSys "U"

> see page C-35

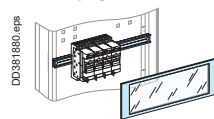

Device	No. of vertical modules	Useful length of rail (mm)	Rear modular rail	Transparent front plate
TeSys U model				
TeSys U model	4	432	LVS03004	LVS03342

- Linerigy FM distribution block > see page D-16
- Cable running > see page C-36

Determine the size of the switchboard

- count the number of occupied modules
- determine the corresponding wall-mount enclosure
- order the additional plain front plate.

19 modules

21 modules

Plain front plate > see page C-50

500 mm wide plain front plate	Cat. no.
1 module (H = 50 mm)	LVS03801
2 modules (H = 100 mm)	LVS03802
3 modules (H = 150 mm)	LVS03803

Plan the distribution system

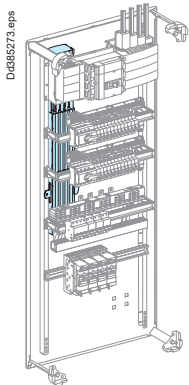

DD385273.eps

Linery BW busbars > see page B-29, D-4

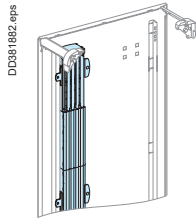

DD381882.eps

Linery BW busbars		160 A	250 A	400 A	630 A
Three-pole	W = 1000 mm	LVS04111	LVS04112	LVS04113	LVS04114
	W = 1400 mm	LVS04116	LVS04117	LVS04118	LVS04119
Four-pole	W = 1000 mm	LVS04121	LVS04122	LVS04123	LVS04124
	W = 1400 mm	LVS04126	LVS04127	LVS04128	LVS04129



Select the Linery TR terminal blocks and the Linery TB earth bar

> see page D-24, page D-24

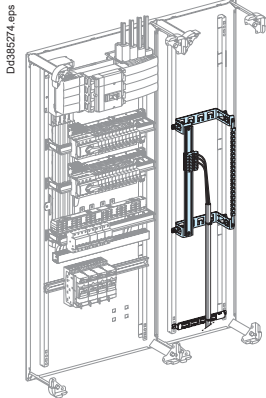

DD385274.eps

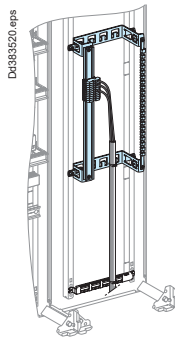

DD383820.eps

Designation	Cat. no.
Mounting plate for terminal block and Linery TB earth bar	LVS04220
Modular rail, W = 1600 mm	LVS04226
12 x 3 mm direct earth bar with 1 terminal 352 L330 Linery TB	LVS04201
4 earth block 12 x 42 quick connection Linery TB	LVS04214
4 earth block 3 x 162 quick connection Linery TB	LVS04215

Select the enclosures

> see page E-4

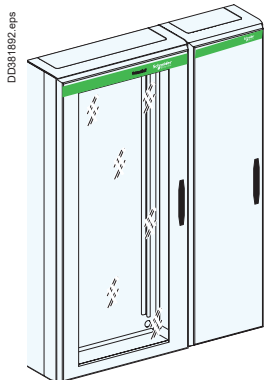

DD381882.eps

1 IP wall-mount enclosure

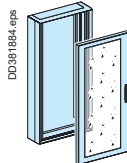

DD381884.eps

2 Duct, W = 300 mm

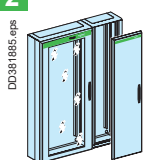

DD381885.eps

3 Cable tie supports

4 Accessories for lifting, handling, wall mounting, finishing parts, etc.

No. of vertical modules	Height of enclosure	Enclosure	Plain door	Transparent door
Wall-mount enclosure (IP30)				
6	330	LVS08102	LVS08122	LVS08132
9	480	LVS08103	LVS08123	LVS08133
12	630	LVS08104	LVS08124	LVS08134
15	780	LVS08105	LVS08125	LVS08135
18	930	LVS08106	LVS08126	LVS08136
21	1080	LVS08107	LVS08127	LVS08137

No. of vertical modules	Height of duct	Duct, W = 300 mm	Plain door	Transparent door
Duct (IP30)				
6	330	LVS08172	LVS08182	
9	480	LVS08173	LVS08183	
12	630	LVS08174	LVS08184	
15	780	LVS08175	LVS08185	
18	930	LVS08176	LVS08186	
21	1080	LVS08177	LVS08187	LVS08197

Designation	Cat. no.
4 cable-tie supports for 300 mm wide ducts	LVS08868



Green Premium™

Endorsing eco-friendly products in the industry



Green Premium™ Product

Green Premium is the only label that allows you to effectively develop and promote an environmental policy whilst preserving your business efficiency. This ecolabel guarantees compliance with up-to-date environmental regulations, but it does more than this.

Over 75% of Schneider Electric manufactured products have been awarded the Green Premium ecolabel



Discover what we mean by green ...

Check your products!

Schneider Electric's Green Premium ecolabel is committed to offering transparency, by disclosing extensive and reliable information related to the environmental impact of its products:

RoHS

Schneider Electric products are subject to RoHS requirements at a worldwide level, even for the many products that are not required to comply with the terms of the regulation. Compliance certificates are available for products that fulfil the criteria of this European initiative, which aims to eliminate hazardous substances.

REACH

Schneider Electric applies the strict REACH regulation on its products at a worldwide level, and discloses extensive information concerning the presence of SVHC (Substances of Very High Concern) in all of its products.

PEP: Product Environmental Profile

Schneider Electric publishes complete set of environmental data, including carbon footprint and energy consumption data for each of the lifecycle phases on all of its products, in compliance with the ISO 14025 PEP ecopassport program. PEP is especially useful for monitoring, controlling, saving energy, and/or reducing carbon emissions.

EoLI: End of Life Instructions

Available at the click of a button, these instructions provide:

- Recyclability rates for Schneider Electric products.
- Guidance to mitigate personnel hazards during the dismantling of products and before recycling operations.
- Parts identification for recycling or for selective treatment, to mitigate environmental hazards/ incompatibility with standard recycling processes.



Functional system

Contents

Circuit breakers

ComPacT and ComPacT Vigi NSXm up to 160	
Horizontal mounting - Toggle - Rotary handle	C-3
Vertical mounting on modular rail - Toggle	C-4
ComPacT and ComPacT Vigi NSX100/160/250	
Horizontal mounting - Toggle	C-5
Vertical mounting - Toggle	C-6
Horizontal mounting - Rotary handle / Motor mechanism module / Plug-in	C-7
Vertical mounting - Rotary handle	C-8
VigicomPacT NSX100/160/250	
Horizontal mounting - Toggle	C-9
Vertical mounting - Toggle	C-10
Horizontal mounting - Rotary handle	C-11
Vertical mounting - Rotary handle	C-12
ComPacT and ComPacT Vigi NSX400/630	
Horizontal mounting - Toggle	C-13
Vertical mounting - Toggle / Rotary handle	C-14
VigicomPacT NSX400/630	
Vertical mounting - Toggle / Rotary handle	C-16

Switch-disconnector

ComPacT INS-INV100/160/250	
Horizontal mounting - Direct front handle	C-17
Vertical mounting - Direct front handle	C-18
ComPacT INS-INV320/630	
Horizontal mounting - Direct front handle	C-19
Vertical mounting - Direct front handle	C-20

Changeover system

ComPacT NSX100/250 circuit breakers changeover system	
Vertical mounting - Manual source	C-21
ComPacT INS-INV250 switch-disconnectors changeover system	
Vertical mounting - Manual source	C-22
TransferPacT 32A-100A Automatic source changeover system	C-24
TransferPacT 80A-160A Automatic source changeover system	C-25

Fusegear

FuPacT GS32/63/100/160	
Horizontal mounting - Extended rotary handle	C-26
Vertical mounting - Extended rotary handle	C-27
FuPacT ISFT160/250	
Horizontal mounting	C-28
FuPacT ISFT100/100N, ISFT160/250	
Vertical mounting	C-29

Modular devices

≤ 160 A switchboard incomer	C-31
outgoers ≤ 63 A	C-32

Other devices

Other modular devices - Switchboard lighting	C-33
Kilowatt-hour meters - Class II	C-34

Industrial control devices

TeSys, Altistart, Phaseo	C-36
---------------------------------	-------------

Other devices

Human-switchboard interface	
Devices 72 x 72 / 96 x 96 - 144 x 144 - Ø22 Lamps and pushbuttons	C-37

Accessories

Terminal block and earth bar installation	C-40
--	-------------

Partitioning of functional units

Partitioning in PrismaSeT G IP30 and IP55 - Horizontal and Vertical system	C-41
---	-------------

Prefabricated connections

Connections blocks - Power supply blocks	
Horizontal / Vertical mounting	C-42
Vertical mounting	C-43
Linergy BW and devices connections - Other prefabricated connections	C-44
Other prefabricated connections - Insulated flexible bars	C-45

Organisation of switchboard

Trunking - Trunking support - Grommets	C-46
Straps - Cable-tie supports	C-47
Thermal management	C-48

Front plates and accessories

Front plates	C-50
---------------------	-------------

Finishing parts

Labels, mimic diagram, accessories	C-51
---	-------------

Front plates and accessories

Rails, slotted mounting plates, accessories	C-52
--	-------------

Accessories

Installation accessories	C-53
---------------------------------	-------------

ComPacT and ComPacT Vigi (ELCB) NSXm up to 160

Horizontal mounting - Fixed - Toggle / Rotary handle

W600 - W850

Circuit breakers

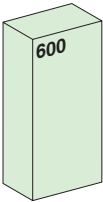
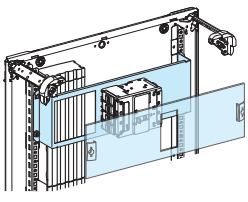
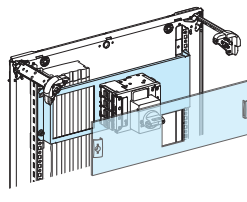
Mounting	W600 Horizontal - Fixed - Toggle		W600 Horizontal - Fixed - Rotary handle
			
Devices	NSXm	NSXm Vigi (ELCB)	NSXm
Number of devices per row	1	1	1
Nb. of vertical modules	3	3	3
Mounting plates	LVS03020	LVS03020	LVS03021
Front plates with cut-out [Nb. of vertical modules]	LVS03330 [3]	LVS03330 [3]	LVS03331 [3]
Long terminal shields	3P : LV426912 4P : LV426913	3P : LV426912 4P : LV426913	3P : LV426912 4P : LV426913
Collar			

(1) Maximum size of connection cables: 70 mm². For cable cross-sections greater than 70 mm², use of a cable duct is recommended.

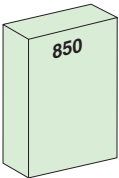
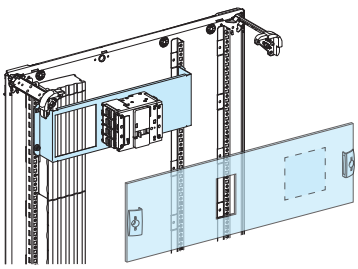
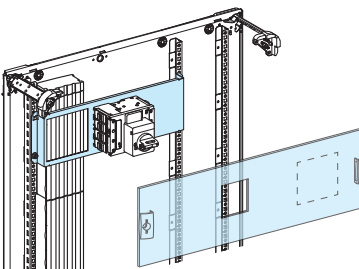
Mounting	W850 Horizontal - Fixed - Toggle		W850 Horizontal - Fixed - Rotary handle
			
Devices	NSXm	NSXm Vigi (ELCB)	NSXm
Number of devices per row	1	1	1
Nb. of vertical modules	3	3	3
Mounting plates	LVS03020	LVS03020	LVS03021
Front plate with cut-out [Nb. of vertical modules]	LVS03332 [3]	LVS03332 [3]	LVS03333 [3]
Long terminal shields	3P : LV426912 4P : LV426913	3P : LV426912 4P : LV426913	3P : LV426912 4P : LV426913
Collar			

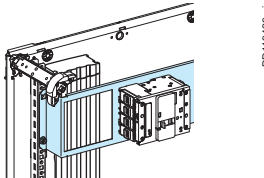
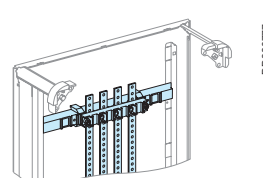
Downstream distribution	Insulated Linergy BW busbars	Rear Linergy BS busbars
		
Busbars	Linergy BW > page D-4	LVS04191 + copper bars > page D-6
Prefabricated connection	LVS04021, LVS04145, LVS04146, LVS04148	LVS04030

Note: For cable-tie function, add 2 modules above. > page C-47

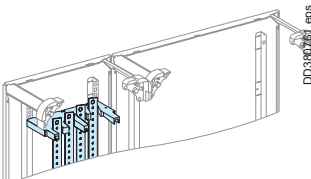
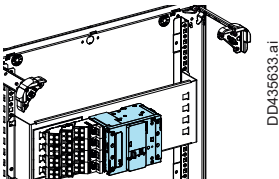
Downstream distribution	Linergy BS multi-stage busbars	Linergy DP
		
Busbars / Distribution block	LVS04192 + copper bars > pages D-7, D-8	LVS04038, LVS04039 > page D-13
Prefabricated connection	Connection must be made	

Note: For cable-tie function, add 2 modules above. > page C-51

ComPacT and ComPacT Vigi (ELCB) NSXm up to 160

Vertical mounting on modular rail - Toggle

W600 - W850 - W300

Circuit breakers

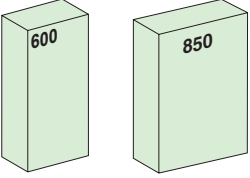
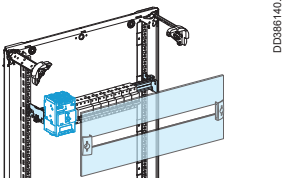
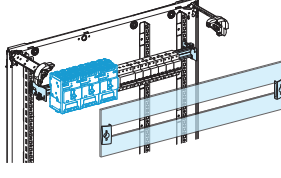
Mounting		W600 Modular rail - Toggle		W850 Modular rail - Toggle	
					
Devices		NSXm	NSXm Vigi (ELCB)	NSXm	NSXm Vigi (ELCB)
Nb. of vertical modules		5 (1)	5 (2)	5 (1)	5 (2)
Rail (48 modules of 9 mm)		LVS03002 (adjustable) (3)	LVS03002 (adjustable) (3)	LVS03007 (adjustable) (3)	LVS03007 (adjustable) (3)
Modular front plates	With cut-out plates	LVS03205 [5]	LVS03205 [5]	LVS03218 [5]	LVS03218 [5]
[Nb. of vertical modules]					
Blanking plate	Strip	LVS03220	LVS03220	LVS03220	LVS03220
	Divisible	LVS03221	LVS03221	LVS03221	LVS03221



(1) With Linergy DP, the number of vertical modules will be 7 and must be used with downstream front plate; cat no. LVS03802 for W600 (quantity:1) or cat no. LVS03851 for W850 (quantity:2).

(2) With Linergy DP, the number of vertical modules will be 8 and must be used with downstream front plate; cat no. LVS03803 for W600 or cat no. LVS03853 for W850.

(3) Can be completed by a rail (cat no. LVS04226) + raiser (cat no. LVS04225) to install modular devices. > page C-44, C55

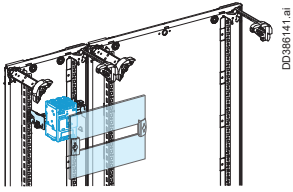
(4) With Linergy DP, the number of vertical modules will be 9 and must be used with downstream front plate; cat no. LVS03813 for W300.

Mounting		W300 Modular rail - Toggle	
			
Devices		NSXm	NSXm Vigi (ELCB)
Nb. of vertical modules		8 (1)	8 (2)
Rail (20 modules of 9 mm)		LVS03011 (adjustable)	LVS03011 (adjustable)
Front plate	modular	LVS03214 [4]	LVS03214 [4]
	upstream	LVS03812 [2]	LVS03812 [2] (4)
	downstream	LVS03812 [2]	LVS03812 [2]
[Nb. of vertical modules]			
Blanking plate	Strip	LVS03220	LVS03220
	Divisible	LVS03221	LVS03221

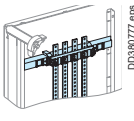
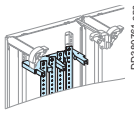
Downstream distribution	Insulated Linergy BW busbars	Rear Linergy BS busbars	Linergy BS Multi-stage busbars in duct
			
Busbars	Linergy BW > page D-4	LVS04191 + copper bars > page D-6	LVS04192 + copper bars > pages D-7, D-8
Connection	LVS04030, LVS04145, LVS04146, LVS04147, LVS04148	LVS04145, LVS04146 (centred device)	Must be made

Note: For cable-tie function, add 2 modules above > page C-47

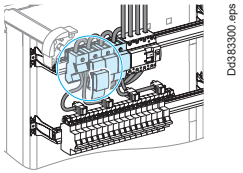
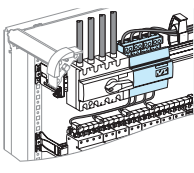
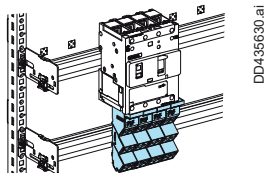
Downstream distribution	Distributionblock Linergy DX 1P, 160 A	Distribution block Linergy DX 4P, 125 A/160 A	Linergy DP, 3P/4P, 160 A	
				
Distribution block	LVS04031 > page C-15	LVS04045 > page C-15	LVS04046 > page C-15	LVS04038, LVS04039 > page D-13
Connection	LVS04149	LVS04047	included	
Rail				LVS03002 (W600) LVS03007 (W850) LVS03011 (W300)

Note: For cable-tie function, add 2 modules above. > page C-51

ComPacT and ComPacT Vigi (ELCB) NSX 100/160/250

Horizontal mounting - Fixed - Toggle

W600 - W600+W300 - W850



Designed for PowerTag NSX
Circuit breakers

Mounting		W600 Horizontal - Fixed - Toggle			
Devices		NSX / NSX Vigi (ELCB) 100/250		NSX / NSX Vigi (ELCB) 100/160 (1)	
Number of devices per row		1		1	
Nb. of vertical modules		5		5	
Mounting plates		LVS03030		LVS03030	
Front plates		LVS03232 [4]		LVS03232 [4]	
[Nb. of vertical modules]		upstream		LVS03801 [1]	
		downstream		LVS03801 [1]	
Upstream connection		LVS04066 > page C-42		LVS04067 > page C-42	
Incoming connection block or cables + Long terminal shields					
				3P : LV429517, 4P : LV429518	

Mounting		W600+W300 Horizontal - Fixed - Toggle				W850 Horizontal - Fixed - Toggle			
Devices		NSX / NSX Vigi (ELCB) 100/250				NSX / NSX Vigi (ELCB) 100/250			
Number of devices per row		1		1		1		1	
Nb. of vertical modules		5		4		5		4	
Standard Mounting plates		LVS03030		LVS03030		LVS03030		LVS03030	
Front plates		LVS03232 [4]		LVS03232 [4]		LVS03294 [4]		LVS03294 [4]	
[Nb. of vert. mod.]		upstream		LVS03801 [1]		LVS03851 [1]		LVS03851 [1]	
		downstream		LVS03801 [1]		LVS03851 [1]		LVS03851 [1]	
With PowerTag NSX									
Mounting plates				LVS03033		LVS03033		LVS03033	
Front plates				LVS03334 [4]		LVS03334 [4]		LVS03335 [4]	
cut-out								LVS03335 [4]	
[Nb. of vert. mod.]									
Upstream connection		LVS04066 > page C-42		LVS04067 > page C-42		LVS04066 > page C-42		LVS04067 > page C-42	
Incoming connection block or cables + Long terminal shields									
				3P : LV429517 4P : LV429518				3P : LV429517 4P : LV429518	

Downstream distribution	Linergy DP 250 A distribution block	Linergy BW + Power supply block	Rear Linergy BS busbars	Linergy BS multi-stage busbars
Busbars / Distrib blocks	3P : LVS04033 , 4P : LVS04034 > page D-12	Linergy BW > page D-4	LVS04191 + copper bars > page D-6	LVS04192 + copper bars > pages D-7, D-8
Power supply block / connection	-	LVS04060 (2) > page C-42	Connection must be made	
Long terminal shields	-		3P : LV429517 4P : LV429518	

Note: For cable-tie function, add 2 modules above. > page C-47

(1) Maximum size of connection cables: 70 mm². For cable cross-sections greater than 70 mm², use of a cable duct is recommended.

(2) Supplied with connections.

ComPacT and ComPacT Vigi (ELCB) NSX 100/160/250

Vertical mounting - Fixed - Toggle

W600 - W300



Designed for PowerTag NSX
Circuit breakers

Mounting	W600 Vertical - Fixed - Toggle	
Devices	NSX / NSX Vigi (ELCB) 100/160	
Number of devices per row	1 or 4 x 3P or 3 x 4P	
Nb. of vertical modules	9 or 10	
Mounting plates	LVS03040	
Front plates cut-out	LVS03243 [5]	
[Nb. of upstream vertical modules]	LVS03802 [2]	
[Nb. of downstream vertical modules]	LVS03802 [2]	
downstream with PowerTag NSX	LVS03803 [3]	
Upstream connection		
Long terminal shields	3P : LV429517 4P : LV429518	
Divisible blanking plates (HxL)	LVS03220 ComPacT NSX 3P or 4P without electronic trip unit LVS03221 ComPacT NSX 3P or 4P with electronic trip unit	

Downstream distribution	Linergy DP 250 A distribution block	Linergy BW + Power supply block (1)	Rear Linergy BS busbars	Linergy BS multi-stage busbars
Busbars / Distrib blocks	3P : LVS04033 4P : LVS04034+ LVS03002 > page D-12	Linergy BW > page D-4	LVS04191 + copper bars > page D-6	LVS04192 + copper bars > pages D-7, D-8
Power supply block / connection	-	LVS04061 + LVS04062 (2) > page C-43	Connection must be made	
Long terminal shields	-	3P : LV429515 4P : LV429516	3P : LV429517 4P : LV429518	

Mounting	W300 Vertical Fixed - Toggle	Downstream distribution	Linergy DP 250 A distribution block in duct	Insulated Linergy BW busbars (2)	Rear Linergy BS busbars	Linergy BS multi-stage busbars or multi-stage distribution block
Devices	NSX / NSX Vigi (ELCB) 100/250 [1]					
Number of devices per row	1					
Nb. of vertical modules	9 or 10					
Mounting plates	LVS03050					
Front plates cut-out	LVS03253 [9]					
[Nb. of downstream vertical modules]	LVS03811 [1] (3)					
downstream with PowerTag NSX						
Upstream connection						
Cables + Long terminal shields	3P : LV429517 4P : LV429518					
Busbars / Distrib blocks	3P : LVS04033 + LVS03011 4P : LVS04034 > page D-12		Linergy BW > page D-4		LVS04191 copper bars > page D-6	LVS04192 copper bars > pages D-7, D-8
Power supply block	-		LVS04061 > page C-43		-	
Connection	-		LVS04064 > page C-43		Must be made	
Short / Long terminal shields	-		3P : LV429515 4P : LV429516		3P : LV429517 4P : LV429518	3P : LV429515 4P : LV429516

Note: For cable-tie function, add 1 module above. > [page C-47](#)

(1) 1 device centred on mounting plate.

(2) Space available at the top of the enclosure after mounting the universal power supply block: NSX100/250 = 7 modules.

(3) Mounting 1 module front plate (LVS03811) on the extreme top or bottom is not allowed.

ComPacT and ComPacT Vigi (ELCB) NSX 100/160/250
Horizontal mounting - Fixed - Rotary handle /
Motor mechanism module / Plug-in
W600 - W600+W300 - W850



Designed for PowerTag NSX
Circuit breakers

Mounting	W600 Horizontal - Fixed - Rotary handle (1)	
Devices	NSX / NSX Vigi (ELCB) 100/160	
Number of devices per row	1	1
Nb. of vertical modules	5	5
Mounting plates	LVS03031	
Front plates cut-out	LVS03232 [4]	
[Nb. of vertical modules] upstream	LVS03801 [1]	
downstream	LVS03801 [1]	
Upstream connection		
Long terminal shields	3P : LV429517 4P : LV429518	



Mounting	W600+W300 Horizontal - Fixed - Rotary handle	W850 Horizontal - Fixed - Rotary handle	W600+W300 Horizontal - Fixed - Motor mechanism module	W600+W300 Horizontal - Plug-in - Toggle
Devices	NSX / NSX Vigi (ELCB) 100/250	NSX / NSX Vigi (ELCB) 100/250	NSX / NSX Vigi (ELCB) 100/250	NSX100/250
Number of devices per row	1	1	1	1
Nb. of vertical modules	4	4	4	4
Mounting plates	LVS03031	LVS03031	LVS03032	LVS03032
Front plates [Nb. of vert. mod.] cut-out	LVS03232 [4]	LVS03232 [4]	LVS03234 [4]	LVS03290 [4]
With PowerTag NSX				
Front plates [Nb. of vert. mod.] cut-out	LVS03334 [4]	LVS03334 [4]	LVS03335 [4]	LVS03335 [4]
Upstream connection				
Terminal shields	3P : LV429517 4P : LV429518			Plug-in base Device
+ connection adapter for plug-in base				3P : LV429517 3P : LV429515 4P : LV429518 4P : LV429516
				3P : LV429306 4P : LV429307

Downstream distribution	Linergy DP 250 A distribution block	Linergy BW + Power supply block (2)	Rear Linergy BS busbars	Linergy BS multi-stage busbars
Busbars / Distrib blocks	3P : LVS04033, 4P : LVS04034 > page D-12	Linergy BW > page D-4	LVS04191 + copper bars > page D-6	LVS04192 + copper bars > pages D-7, D-8
Power supply block / connection		LVS04060 > page C-42	Connection must be made	
Long terminal shields			3P : LV429517 4P : LV429518	

Note: For cable-tie function, add 2 modules above. > page C-47

(1) Maximum size of connection cables: 70 mm². For cable cross-sections greater than 70 mm², use of a cable duct is recommended.

(2) With motor mechanism, use power supply units with connections (cat no.LVS04061) + connection to make with Linergy BW. >page D5

ComPacT and ComPacT Vigi (ELCB) NSX 100/160/250

Vertical mounting - Fixed - Rotary handle

W600 - W300



Designed for PowerTag NSX
Circuit breakers

Mounting		W600 Horizontal - Fixed - Rotary handle (1)			
Devices		NSX / NSX Vigi (ELCB) 100/160		NSX / NSX Vigi (ELCB) 250	
Number of devices per row		1 or 4 x 3P or 3 x 4P		1 or 4 x 3P or 3 x 4P	
Nb. of vertical modules		9 or 10		11 or 12	
Mounting plates		LVS03041		LVS03041	
Front plates cut-out		LVS03243 [5]		LVS03243 [5]	
[Nb. of upstream vertical modules]		LVS03802 [2]		LVS03804 [4]	
downstream		LVS03802 [2]		LVS03802 [2]	
downstream with PowerTag NSX		LVS03803 [3]		LVS03803 [3]	
Upstream connection					
Long terminal shields		3P : LV429517 4P : LV429518			
Divisible blanking plates (HxL)		LVS03220 ComPacT NSX 3P or 4P without electronic trip unit LVS03221 ComPacT NSX 3P or 4P with electronic trip unit			
Downstream distribution		Linery DP 250 A distribution block	Linery BW + Power supply block (1)	Rear Linery BS busbars	Linery BS multi-stage busbars
Busbars / Distrib blocks		3P : LVS04033 + LVS04034 4P : LVS04034 + LVS03002 > page D-12	Linery BW > page D-4	LVS04191 + copper bars > page D-6	LVS04192 + copper bars > pages D-7, D-8
Power supply block / connection			LVS04061 + LVS04062 (2) > page C-43	Connection must be made	
Long terminal shields			3P : LV429515 4P : LV429516	3P : LV429517 4P : LV429518	
Mounting		W300 Vertical - Fixed - Rotary handle			
Devices		NSX / NSX Vigi (ELCB) 100/250			
Number of devices per row		1			
Nb. of vertical modules		9 or 10			
Mounting plates		LVS03051			
Front plates cut-out		LVS03253 [9]			
[Nb. of downstream vertical modules]		LVS03811 [1] (3)			
downstream with PowerTag NSX					
Upstream connection					
Long terminal shields		3P : LV429517 4P : LV429518			
Downstream distribution		Linery DP 250 A distribution block in duct	Insulated Linery BW busbars (2)	Rear Linery BS busbars	Linery BS multi-stage busbars or multi-stage distribution block
Busbars / Distrib blocks		3P : LVS04033 + LVS03011 4P : LVS04034 > page D-12	Linery BW > page D-4	LVS04191 copper bars > page D-6	LVS04192 copper bars > pages D-7, D-8
Power supply block			LVS04061 > page C-43 		
Connection block			LVS04064 > page C-43 	Must be made	LVS04065 > page C-44
Short / Long terminal shields			3P : LV429515 4P : LV429516 	3P : LV429517 4P : LV429518 	3P : LV429515 4P : LV429516

Note: For cable-tie function, add 1 module above. > page C-47







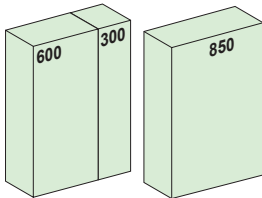
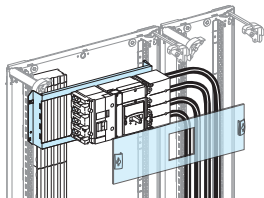
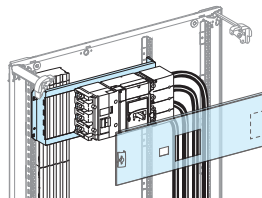

(1) 1 device centred on mounting plate.

(2) Space available at the top of the enclosure after mounting the universal power supply block: NSX100/250 = 7 modules.

(3) Mounting 1 module front plate (LVS03811) on the extreme top or bottom is not allowed.

VigicomPacT NSX100/160/250
Horizontal mounting - Fixed - Toggle
W600+W300 - W850

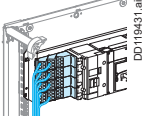
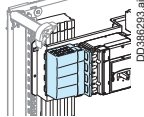
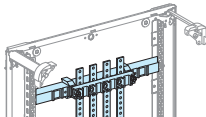
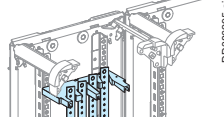
Circuit breakers

Mounting	W600+W300 Horizontal - Fixed - Toggle		W850 Horizontal - Fixed - Toggle	
				
Devices	Vigi NSX100/250 with ammeter module or Vigi		Vigi NSX100/250	
				
Number of devices per row	1	1	1	1
Nb. of vertical modules	4	4	4	4
Mounting plates	LVS03033	LVS03033	LVS03033	LVS03033
Front plates cut-out [Nb. of vertical modules]	LVS03292 [4]	LVS03292 [4]	LVS03295 [4]	LVS03295 [4]
Upstream connection				
Long terminal shields	3P : LV429517 4P : LV429518 			
Downstream distribution				
				
Busbars / Distrib blocks	3P : LVS04033 4P : LVS04034 > page D-12	Linergy BW > page D-4	LVS04191 + copper bars > page D-6	LVS04192 + copper bars > pages D-7, D-8
Power supply block / connection	-	LVS04060 > page C-42 	Connection must be made	
Long terminal shields	-		3P : LV429517 4P : LV429518 	

Note: For cable-tie function, add 2 modules above. > page C-44

VigicomPacT NSX100/160/250
Vertical mounting - Fixed - Toggle
W600 - W300

Circuit breakers

Mounting		W600 Horizontal - Fixed - Toggle (1)	
Devices		Vigi NSX100/160	Vigi NSX250
Number of devices per row		1 or 4 x 3P or 3 x 4P	1 or 4 x 3P or 3 x 4P
Nb. of vertical modules		10	13
Mounting plates		LVS03040	LVS03040
Front plates cut-out		LVS03241 [7]	LVS03241 [7]
[Nb. of vertical modules] upstream		LVS03802 [2]	LVS03804 [4]
downstream		LVS03801 [1]	LVS03802 [2]
Upstream connection			
Long terminal shields			3P : LV429517 4P : LV429518
Divisible blanking plates (HxL)			LVS03222 ComPacT NSX 3P or 4P + Vigi without electronic trip unit LVS03249 ComPacT NSX 3P or 4P + Vigi with electronic trip unit - Set of 4 strips

Downstream distribution	Linergy DP 250 A distribution block	Linergy BW + Power supply block (1)	Rear Linergy BS busbars	Linergy BS multi-stage busbars
Busbars / Distrib blocks Power supply block	3P : LVS04033 + LVS03002 4P : LVS04034 > page D-12	Linergy BW > page D-4	LVS04191 + copper bars > page D-6	LVS04192 + copper bars > pages D-7, D-8
Power supply block / connection			Connection must be made	
Long terminal shields	-		3P : LV429517 4P : LV429518	

Mounting	W300 Vertical - Fixed - Toggle	Downstream distribution	Linergy DP 250 A distribution block in duct	Insulated Linergy BW busbars (2)	Rear Linergy BS busbars	Linergy BS multi-stage busbars or multi-stage distribution block
Devices	Vigi NSX100/250	Busbars / Distrib blocks	3P : LVS04033 + LVS03011 4P : LVS04034 > page D-12	Linergy BW > page D-4	LVS04191 + copper bars > page D-6	LVS04192 + copper bars > pages D-7, D-8
Number of devices per row	1	Power supply block	-	LVS04061 > page C-43 	-	-
Nb. of vertical modules	13	Connection	-	Must be made		LVS04065 > page C-44
Mounting plates	LVS03050	Short / Long terminal shields	-	3P : LV429517 4P : LV429518 	3P : LV429515 4P : LV429516 	
Front plates cut-out	LVS03293 [11]					
[Nb. of vertical modules] upstream	LVS03812 [2]					
downstream						

New: Earth leakage protection inside circuit breaker size NSX Vigi (ELCB) PrismaSeT functional units > page C-6

Note: For cable-tie function, add 1 module above. > page C-47

(1) 1 device centred on mounting plate.

(2) Space available at the top of the enclosure after mounting the universal power supply block:









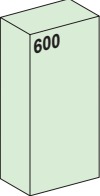
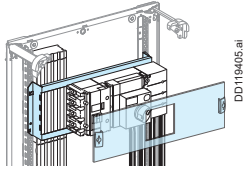

- Vigi NSX100/250 = 9 modules. Space required by power supply block on Linergy BW busbars = 5 modules.

VigicomPacT NSX100/160/250

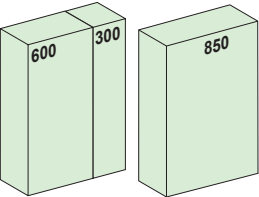
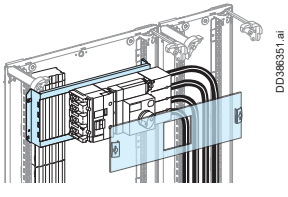
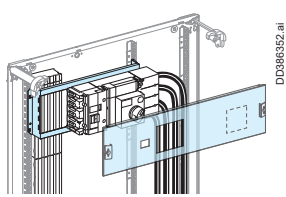
Horizontal mounting - Fixed - Rotary handle

W600 - W600+W300 - W850

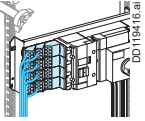
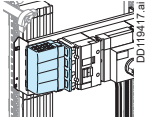
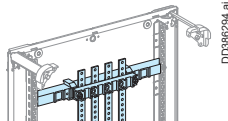
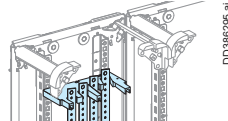
Circuit breakers

Mounting		W600 Horizontal - Fixed - Rotary handle (1)			
					
Devices		Vigi NSX100/160			
					
Number of devices per row		1		1	
Nb. of vertical modules		5		5	
Mounting plates		LVS03031		LVS03031	
Front plates cut-out		LVS03292 [4] + LV429285 (collar)		LVS03292 [4] + LV429285 (collar)	
[Nb. of vertical modules] upstream		LVS03801 [1]		-	
downstream		-		LVS03801 [1]	
Upstream connection					
Long terminal shields		 3P : LV429517 4P : LV429518			
Mounting		W600+W300 Horizontal - Fixed - Rotary handle		W850 Horizontal - Fixed - Rotary handle	
					
Devices		Vigi NSX100/250		Vigi NSX100/250	
					
Number of devices per row		1		1	
Nb. of vertical modules		4		4	
Mounting plates		LVS03031		LVS03031	
Front plates		LVS03292 [4] + LV429285 (collar)		LVS03295 [4] + LV429285 (collar)	
[Nb. of vertical modules]		LVS03292 [4] + LV429285 (collar)		LVS03295 [4] + LV429285 (collar)	
Upstream connection					
Long terminal shields		 3P : LV429517 4P : LV429518			
Downstream distribution		Linergy DP 250 A distribution block	Linergy BW + Power supply block	Rear Linergy BS busbars	Linergy BS multi-stage busbars
					
Busbars / Distrib blocks		3P : LVS04033 4P : LVS04034 > page D-12	Linergy BW > page D-4	LVS04191 copper bars > page D-6	LVS04192 copper bars > pages D-7, D-8
Power supply block / connection		-	LVS04060 > page C-42	 Connection must be made	
Long terminal shields		 3P : LV429517 4P : LV429518			

Note: For cable-tie function, add 2 modules above. > page C-47





(1) Maximum size of connection cables: 70 mm². For cable cross-sections greater than 70 mm², use of a cable duct is recommended.



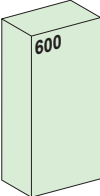

VigicomPacT NSX100/160/250

Vertical mounting - Fixed - Rotary handle

W600

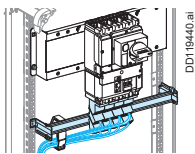
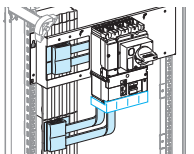
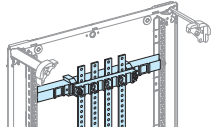
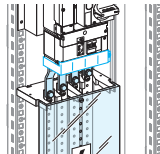
Circuit breakers

Mounting		W600 Horizontal - Fixed - Rotary handle (1)	
			
Devices		Vigi NSX100/160	Vigi NSX250
Number of devices per row		1 or 4 x 3P or 3 x 4P	1 or 4 x 3P or 3 x 4P
Nb. of vertical modules		10	13
Mounting plates		LVS03041	LVS03041
Front plates cut-out		LVS03244 (7) + LV429285 (collar)	LVS03244 (7) + LV429285 (collar)
[Nb. of vertical modules] upstream		LVS03802 (2)	LVS03804 (4)
downstream		LVS03801 (1)	LVS03802 (2)
Upstream connection			
Long terminal shields		 3P : LV429517 4P : LV429518	
Divisible		107 x 147 mm	
Blanking plates (HxL)		85 x 147 mm	
		 LVS03222 ComPacT NSX 3P or 4P + Vigi without electronic trip unit LVS03249 ComPacT NSX 3P or 4P + Vigi with electronic trip unit - Set of 4 strips	

Downstream distribution	Linergy DP 250 A distribution block	Linergy BW + Power supply block (2)	Rear Linergy BS busbars	Linergy BS multi-stage busbars
				
Busbars / Distrib blocks	3P : LVS04033 + LVS03002 4P : LVS04034 > page D-12	Linergy BW > page D-4	LVS04191 copper bars > page D-6	LVS04192 copper bars > pages D-7, D-8
Power supply block / connection	-	 LVS04061 + connection must be made	Connection must be made	
Terminal shields	-	 3P : LV429515 4P : LV429516	 3P : LV429517 4P : LV429518	

New: Earth leakage protection inside circuit breaker size NSX Vigi (ELCB) PrismaSeT functional units > page C-8

Note: For cable-tie function, add 1 module above. > page C-47

(1) 1 device centred on mounting plate.

(2) Space available at the top of the enclosure after mounting the universal power supply block:

- Vigi NSX100/250 = 9 modules. Space required by power supply block on Linergy BW busbars = 5 modules.

ComPacT and ComPacT Vigi (ELCB) NSX 400/630

Horizontal mounting - Fixed - Toggle

W600+W300 - W850

Circuit breakers

Mounting		W600+W300 Horizontal - Fixed - Toggle			
Devices		NSX / NSX Vigi (ELCB) 400/630		NSX / NSX Vigi (ELCB) 400/630	
Number of devices per row		1		1	
Nb. of vertical modules		9		6	
Mounting plates		LVS03070		LVS03070	
Front plates cut-out		LVS03296 [6]		LVS03296 [6]	
[Nb. of vertical upstream modules]		LVS03803 [3]		LVS03803 [3]	
Upstream connection		LVS04076 > page C-42		LVS04076 > page C-42	
Incoming connection block or cables + Long terminal shields					
		3P : LV432593 4P : LV432594			

Mounting		W850 Horizontal - Fixed - Toggle	
Devices		NSX / NSX Vigi (ELCB) 400/630	
Number of devices per row		1	
Nb. of vertical modules		9	
Mounting plates		LVS03070	
Front plates cut-out		LVS03289 [6]	
[Nb. of vertical upstream modules]		LVS03853 [3]	
Upstream connection		LVS04076 > page C-42	
Incoming connection block or cables + Long terminal shields			
		3P : LV432593 4P : LV432594	

Downstream distribution	Insulated Linergy BW busbars	Rear Linergy BS busbars	Linergy BS multi-stage busbars
Type of connected devices	NSX400	NSX400	All types
Busbars	Linergy BW > page D-4	NSX630 LVS04191 + copper bars > page D-6	LVS04192 + copper bars > pages D-7, D-8
Power supply block / connection			Connection must be made
	LVS04070 > page C-42	LVS04071 > page C-42	
Long terminal shields	-		
			3P : LV429593 4P : LV429594

Note: For cable-tie function, add 2 modules above. > page C-47

ComPacT and ComPacT Vigi (ELCB) NSX 400/630

Vertical mounting - Fixed - Toggle / Rotary handle

W600 - W300



Designed for PowerTag NSX
Circuit breakers

Mounting	W600 Vertical - Fixed - Toggle		W600 Vertical - Fixed - Rotary handle	
Devices	NSX / NSX Vigi (ELCB) 400		NSX / NSX Vigi (ELCB) 630	
Number of devices per row (2)	1		1	
Nb. of vertical modules	12 or 14		15 or 17	
Mounting plates	LVS03073		LVS03073	
Front plates cut-out	LVS03275 [9]		LVS03275 [9]	
[Nb. of vertical modules]	upstream	LVS03803 [3]	LVS03803 [3]	LVS03803 [3]
	downstream	-	LVS03801 [1]	LVS03803 [3]
	downstream with PowerTag NSX	LVS03802 [2]	LVS03803 [3]	LVS03805 [5]
Upstream connection				
Cables + Long terminal shields	3P : LV432593 4P : LV432594			
Downstream distribution	Insulated Linergy BW busbars (1)	Rear Linergy BS busbars		Linergy BS multi-stage busbars
Type of connected devices	Linergy BW > page D-4	NSX400	NSX630	All types
Busbars		LVS04191 + copper bars > page D-6	LGY4193 + copper bars > page D-6	LVS04192 + copper bars > pages D-7, D-8
Power supply block / connection	LVS04074 Connection must be made > page C-43	Connection must be made		
Long terminal shields	3P : LV432593 4P : LV432594			
Mounting	W300 Vertical - Fixed Toggle		Downstream distribution	Insulated Linergy BW busbars (2)
			Busbars	Linergy BW > page D-4
Devices	NSX / NSX Vigi (ELCB) 400/630		Power supply block	LVS04074 > page C-43
Number of devices per row	1		Connection	LVS04073 > page C-43
Nb. of vertical modules	12 or 16		Short/Long terminal shields	3P : LV432591 4P : LV432592
Mounting plates	LVS03080		Barrier	Included
Front plates cut-out	LVS03298 [8]		Linergy BS busbars	LVS04191/LGY4193 + copper bars > page D-6
[Nb. of vertical modules]	upstream	LVS03812 [2]	Linergy BS multi-stage busbars	LVS04192 + copper bars > pages D-7, D-8
	downstream	LVS03812 [2]	Connection	LVS04075 > page C-44
	downstream with PowerTag NSX	LVS03814 [4]	Must be made	
Upstream connection	3P : LV432593 4P : LV432594		Short/Long terminal shields	3P : LV432591 4P : LV432592
Cables + Long terminal shields	3P : LV432593 4P : LV432594		Barrier	LVS04198





Note: For cable-tie function, add 1 module above > page C-47
 (1) Space required by power supply block on insulated Linergy BW busbars = 5 modules.
 (2) 1 device centred on mounting plate.

VigicomPacT NSX400/630

Vertical mounting - Fixed - Toggle / Rotary handle

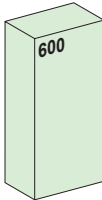
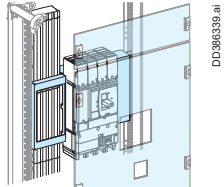
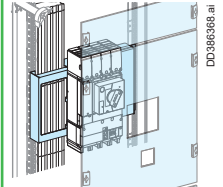
W600

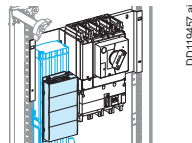
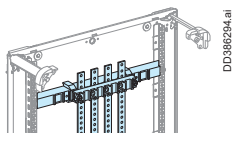
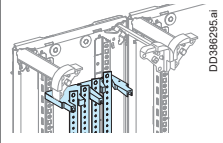

Circuit breakers







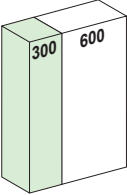
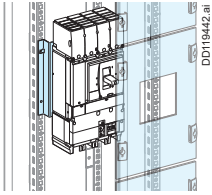

Mounting	W600 Vertical - Fixed - Toggle		W600 Vertical - Fixed - Rotary handle	
				
Devices	Vigi NSX400 (1)	Vigi NSX630 (1)	Vigi NSX400/630 (1)	
Number of devices per row	1	1	1	
Nb. of vertical modules	14	15	18	
Mounting plates	LVS03073	LVS03073	LVS03074	
Front plates cut-out	LVS03297 [11]	LVS03297 [11]	LVS03297 [11] + LV429285 (collar)	
[Nb. of vertical upstream modules] upstream	LVS03803 [3]	LVS03803 [3]	LVS03803 [3]	
downstream		LVS03801 [1]	LVS03804 [4]	
Upstream connection				
Cables + Long terminal shields	 DD386301.ai 3P : LV432593 4P : LV432594			
Downstream distribution	Linery BW + Power supply bloc (1)	Rear Linery BS busbars		Linery BS multi-stage busbars
				
Type of connected devices		NSX400	NSX630	All types
Busbars	Linery BW > page D-4	LVS04191 + copper bars > page D-6	LGY4193 + copper bars > page D-6	LVS04192 + copper bars > pages D-7, D-8
Power supply block / connection	 DD385245.eps LVS04074 Connection must be made > page C-43	Connection must be made		
Long terminal shields	 DD386301.ai 3P : LV432593 4P : LV432594			

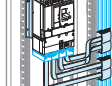
(1) Space required by power supply block on Linery BW busbars = 5 modules.

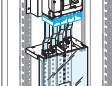
VigicomPacT NSX400/630

Vertical mounting - Fixed - Toggle / Rotary handle
W300

Mounting		W300 Vertical - Fixed - Toggle	
			
Devices		Vigi NSX400/630	
Number of devices per row	1		
Nb. of vertical modules	14		
Mounting plates	LVS03080		
Front plates	cut-out LVS03299 [10]		
[Nb. of vertical modules]	upstream	LVS03812 [2]	
	downstream	LVS03812 [2]	
Upstream connection			
Cables + Long terminal shields			3P : LV432593 4P : LV432594

Downstream distribution	Insulated Linergy BW busbars (2)	Rear Linergy BS busbars	Linergy BS multi-stage busbars
			
Busbars	Linergy BW > page D-4	LVS04191 / LGY4193 + copper bars > page D-6	LVS04192 + copper bars > pages D-7, D-8
Power supply block	LVS04074 > page D-5 	-	-
Connection	LVS04073 > page D-5 	Must be made	LVS04075 > page D-7 
Short/Long terminal shields	3P : LV432591 4P : LV432592 	3P : LV432593 4P : LV432594 	3P : LV432591 4P : LV432592 
Barrier	Included	LVS04198	LVS04197

New: Earth leakage protection inside circuit breaker size NSX Vigi (ELCB) PrismaSeT functional units > page C-14

Note: For cable-tie function, add 1 module above. > page C-47











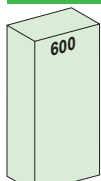
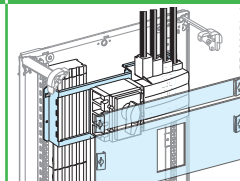
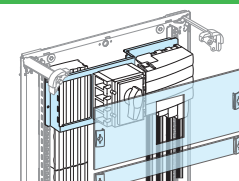
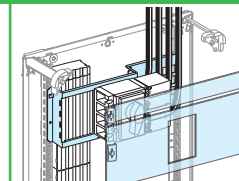
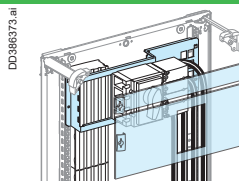







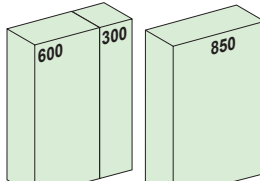
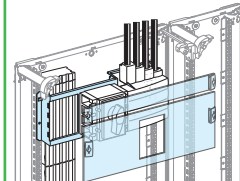
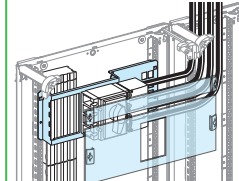
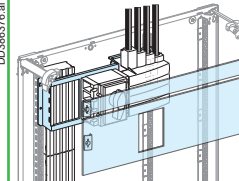
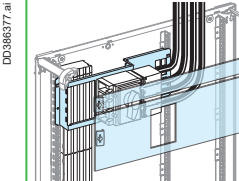













(2) Space required by power supply block on insulated Linergy BW busbars = 5 modules.

Compact INS-INV100/160/250

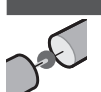
Horizontal mounting - Fixed - Direct front handle

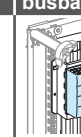
W600 - W600+W300 - W850

Switch-disconnector

Mounting	W600 Horizontal - Fixed - Direct front handle							
								
Devices	INS250-INV100/160				INS250-INV100/160			
								
Number of devices per row	1		1		1		1	
Nb. of vertical modules	5		5		5		5	
Mounting plates	LVS03030		LVS03030		LVS03030		LVS03030	
Front plates cut-out	LVS03231 [4]		LVS03231 [4]		LVS03231 [4]		LVS03231 [4]	
[Nb. of vertical upstream modules]	LVS03801 [1]		-		LVS03801 [1]		-	
[Nb. of vertical downstream modules]	-		LVS03801 [1]		-		LVS03801 [1]	
Upstream connection								
Incoming connection block or cables + Long terminal shields			LVS04066 > page C-42				LVS04067 > page C-42	
							3P : LV429517 4P : LV429518	
Mounting	W600+W300 Horizontal - Fixed - Direct front handle				W850 Horizontal - Fixed - Direct front handle			
								
Devices	INS-INV100/160/250		INS-INV100/160/250		INS-INV100/160/250		INS-INV100/160/250	
								
								
								
Number of devices per row	1		1		1		1	
Nb. of vertical modules	5		5		5		5	
Mounting plates	LVS03030		LVS03030		LVS03030		LVS03030	
Front plates cut-out	LVS03231 [4]		LVS03231 [4]		LVS03239 [4]		LVS03239 [4]	
[Nb. of vertical upstream modules]	LVS03801 [1]		-		LVS03851 [1]		-	
[Nb. of vertical downstream modules]	-		LVS03801 [1]		-		LVS03851 [1]	
Upstream connection								
Incoming connection block or cables + Long terminal shields	LVS04066 > page C-42		LVS04067 > page C-42		3P : LV429517 4P : LV429518		LVS04066 > page C-42	
								
								
								
Downstream distribution	Linery DP 250 A distribution block	Insulated Linery BW busbars (1)	Rear Linery BS busbars	Linery BS multi-stage busbars				
								
Type of connected devices	INS250-INV100/250	INS250-INV100/250	INV-INV250	INV-INV250				
Busbars / Distrib blocks	3P : LVS04033 4P : LVS04034 > page D-12	Linery BW > page D-4	LVS04191 + copper bars > page D-6	LVS04192 + copper bars > pages D-7, D-8				
Power supply block / connection	Connection must be made	LVS04060 > page C-42	Connection must be made					
Long terminal shields	-		3P : LV429517 4P : LV429518	3P : LV429517 4P : LV429518				
								

Note: For cable-tie function, add 2 modules above. > page C-47

(1) Maximum size of connection cables: 70 mm². For cable cross-sections greater than 70 mm², use of a cable duct is recommended.











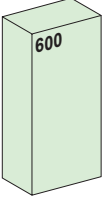
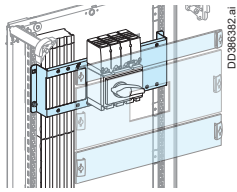



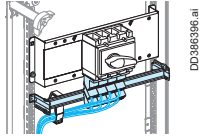
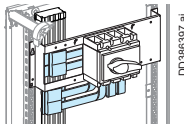
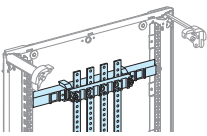
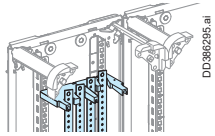

Compact INS-INV100/250

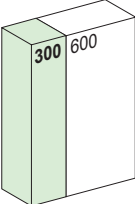
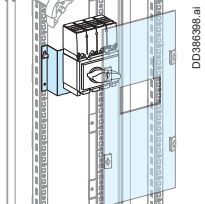
Vertical mounting - Fixed - Direct front handle

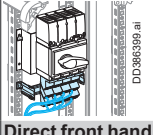
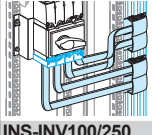
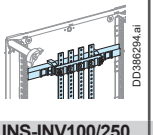
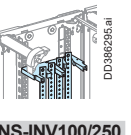
W600 - W300



Designed for PowerTag NSX
Switch-disconnector

Mounting		W600 Vertical - Fixed with or without spreaders											
													
Devices		INS250-INV100/160/250		INS-INV250 lateral handle									
Number of devices per row		1		1									
Nb. of vertical modules		8 or 9		8 or 9									
Mounting plates		LVS03040		LVS03032									
Front plates cut-out		LVS03248 [5]		LVS03806 [6] (plain front plate)									
[Nb. of vertical modules]		upstream LVS03801 [1]		-									
		downstream LVS03802 [2]		LVS03802 [2]									
		downstream with PowerTag NSX LVS03803 [3]		LVS03803 [3]									
Upstream connection													
Cables + Long terminal shields		 3P : LV429517 4P : LV429518		 3P : LV429517 4P : LV429518									
Downstream distribution		Linery DP 250 A distribution block (1)		Insulated Linery BW busbars (2)		Rear Linery BS busbars		Linery BS multi-stage busbars					
													
Type of connected devices		Direct front handle INS-INV100/250		INS-INV100/250		INS-INV250		INS-INV250					
Busbars / Distrib blocks		3P : LVS04033 4P : LVS04034 + LVS03002 > page D-12		Lateral handle INS-INV100/250 3P : LVS04033 4P : LVS04034 + LVS04037 (3) + LVS03003 > page D-12		Linery BW > page D-4		LVS04191 + copper bars > page D-6					
Power supply block / connection		-		LVS04060 + LVS04062 > page C-43		Connection must be made		LVS04192 + copper bars > pages D-7, D-8					
Long terminal shields		-		 3P : LV429515 4P : LV429516		 3P : LV429517 4P : LV429518		 3P : LV429517 4P : LV429518					
Mounting		W300 Vertical - Fixed with or without spreaders		Downstream distribution		Linery DP 250 A distribution block		Insulated Linery BW busbars (2)		Rear Linery BS busbars		Linery BS multi-stage busbars	
													
Devices		INS-INV100/160/250		Direct front handle INS-INV100/250		INS-INV100/250		INS-INV100/250		INS-INV100/250		INS-INV100/250	
Number of devices per row		1		3P : LVS04033		Linery BW > page D-4		LVS04191 + copper bars > page D-6		LVS04192 + copper bars > pages D-7, D-8		LVS04192 + copper bars > pages D-7, D-8	
Nb. of vertical modules		9 or 10		4P : LVS04034		Connection must be made		-		-		-	
Mounting plates		LVS03050		+ LVS03011 > page D-12		LVS04061 + LVS04064 > page C-43		-		-		-	
Front plates cut-out		LVS03251 [9]		-		-		-		-		-	
[Nb. of vert. modules]		downstream with PowerTag NSX LVS03811 [1] (4)		-		-		-		-		-	
Upstream connection		Cables + Long terminal shields		 3P : LV429517 4P : LV429518		 3P : LV429515 4P : LV429516		 3P : LV429517 4P : LV429518		 3P : LV429517 4P : LV429518		 3P : LV429517 4P : LV429518	

Note: For cable-tie function, add 1 module above. > page C-47







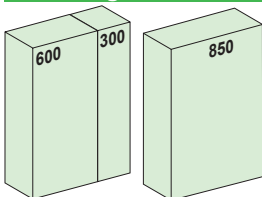
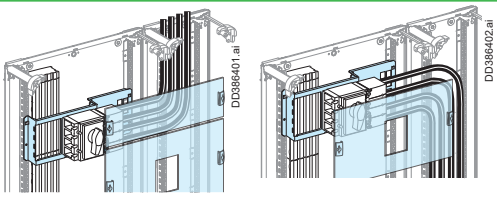
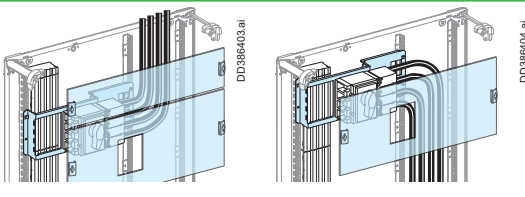

- (1) 1 device centred on mounting plate.
- (2) Space available at the top of the enclosure after mounting the universal power supply block: 7 modules.
Space required by power on insulated Linery BW busbars = 5 modules.
- (3) Copper spacer.
- (4) Mounting 1 module front plate (LVS03811) on the extreme top or bottom is not allowed.

Compact INS-INV320/630

Horizontal mounting - Fixed - Direct front handle

W600+W300 - W850

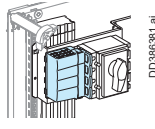
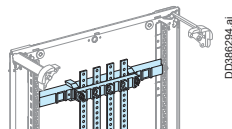
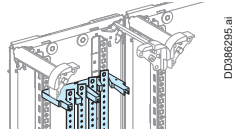
Switch-disconnector

Mounting	W600+W300 Horizontal fixed		W850 Horizontal - Fixed	
				
Devices	INS-INV320/630		INS-INV320/630	
	 DD386277.ai	 DD386278.ai	 DD386277.ai	 DD386278.ai
Number of devices per row	1	1	1	1
Nb. of vertical modules	9	6	9	6
Mounting plates	LVS03070	LVS03070	LVS03070	LVS03030
Front plates cut-out	LVS03271 [6]	LVS03271 [6]	LVS03287 [6]	LVS03287 [6]
[Nb. of vertical upstream modules]	LVS03803 [3]	-	LVS03853 [3]	-
Upstream connection				
Cables + Long terminal shields	 DD386301.ai 3P : LV432593 4P : LV432594			
W600 downstream distribution	Insulated Linergy BW busbars		Rear Linergy BS busbars	Linergy BS multi-stage busbars
	 DD386381.ai		 DD386294.ai	 DD386295.ai
Type of connected devices	INS-INV320/400		INS-INV320/630	INS-INV320/630
Busbars / Distrib blocks	Linergy BW > page D-4		Linergy BW > page D-4	LVS04192 + copper bars > pages D-7, D-8
Power supply block / connection	LVS04070 > page C-42	LVS04071 > page C-42	Connection must be made	
Long terminal shields	-		3P : LV432593 4P : LV432594  DD386301.ai	3P : LV432593 4P : LV432594  DD386301.ai

Note: For cable-tie function, add 2 modules above. > page C-44



Compact INS-INV320/630

Vertical mounting - Fixed - Direct front handle

W600 - W300



Designed for PowerTag NSX
Switch-disconnector

Mounting		W600 Vertical - Fixed with or without spreaders	
Devices	INV320/400	INV500/630	
Number of devices per row	1	1	
Nb. of vertical modules	10 or 12	12 or 14	
Mounting plates	LVS03073	LVS03073	
Front plates cut-out	LVS03274 [10]	LVS03274 [10]	
[Nb. of vertical modules] upstream	-	LVS03802 [2]	
[Nb. of vertical modules] downstream with PowerTag NSX	LVS03802 [2]	LVS03804 [4]	
Upstream connection			
Cables + Long terminal shields		 3P : LV429593 4P : LV429594	





Downstream distribution	Insulated Linergy BW busbars	Rear Linergy BS busbars	Linergy BS multi-stage busbars
Type of connected devices	INS-INV320/630	INS-INV320/400	INS-INV320/630
Busbars	Linergy BW > page D-4	LVS04191 + copper bars > page D-6	LVS04192 + copper bars > pages D-7, D-8
Power supply block / connection	LVS04074 > page C-43 Connection must be made	Connection must be made	
Long terminal shields	 3P : LV429515 4P : LV429516	 3P : LV429517 4P : LV429518	 3P : LV429517 4P : LV429518

Mounting	W300 Vertical - Fixed with or without spreaders	Downstream distribution	Insulated Linergy BW busbars	Rear Linergy BS busbars	Linergy BS multi-stage busbars
Devices	INS-INV 320/400	INS-INV 320/630	INS-INV320/630	INS-INV320/630	INS-INV320/630
Number of devices per row	1	1	1	1	1
Nb. of vertical modules	10 or 12	12 or 14	12 or 14	12 or 14	12 or 14
Mounting plates	LVS03080	LVS03080	LVS03080	LVS03080	LVS03080
Front plates cut-out	LVS03281 [10]	LVS03281 [10]	LVS03281 [10]	LVS03281 [10]	LVS03281 [10]
[Nb. of vertical modules] upstream	-	LVS03812 [2]	LVS03812 [2]	LVS03812 [2]	LVS03812 [2]
[Nb. of vertical modules] downstream with PowerTag NSX	LVS03802 [2]	LVS03802 [2]	LVS03802 [2]	LVS03802 [2]	LVS03802 [2]
Upstream connection					
Cables + Long terminal shields		 3P : LV429593 4P : LV429594		 3P : LV429593 4P : LV429594	
		 3P : LV429593 4P : LV429594		 3P : LV429593 4P : LV429594	

Note: For cable-tie function, add 1 module above. > page C-47

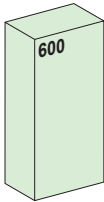
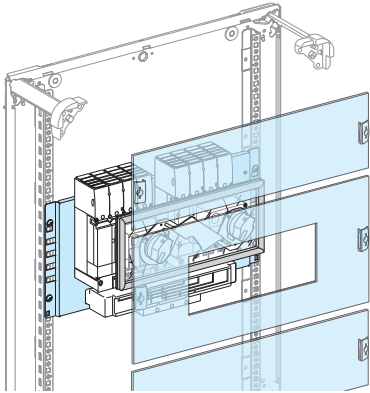
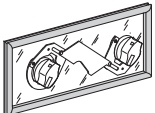
Compact NSX100/250 circuit breakers changeover system
 Vertical mounting - Fixed - Manual source
 W600

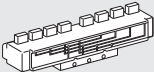
Changeover system

Mounting		W600 Fixed - Changeover with mechanical interlocking	
		DD3884405.ai	
Devices		NSX100/250	
Nb. of vertical modules		11	
Mounting plates		LVS03043	
Front plates cut-out		LVS03245 [5]	
[Nb. of vertical modules] upstream		LVS03803 [3]	
downstream		LVS03803 [3]	
Mechanical interlocking		LV429369	
		DD3884408.ai	
Upstream connection			
Cable + Long terminal shields		3P : LV429517 4P : LV429518	 DD3883301.ai
Coupling accessory		3P : LV429358 4P : LV429359	 DD3884407.ai
Downstream connection			
			
Cable + Long terminal shields		3P : LV429517 4P : LV429518	 DD3883301.ai







Compact INS-INV250 switch-disconnectors changeover system

Vertical mounting - Fixed - Manual source

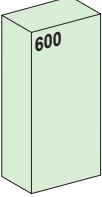
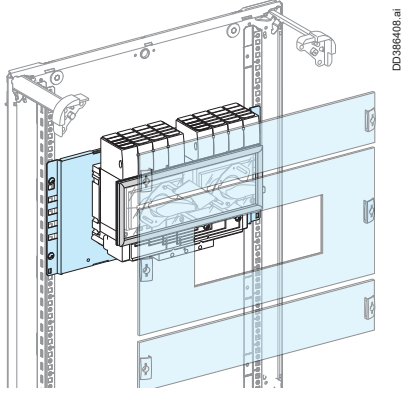
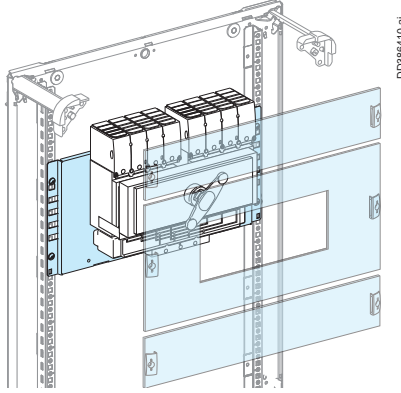
W600

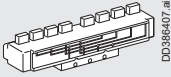
Changeover system

Mounting	W600 Fixed - Changeover with mechanical interlocking)	W600 Fixed - Complete source changeover assembly	
			
Devices	INS-INV250	INS250 3P	4P
Nb. of vertical modules	10	10	10
Mounting plates	LVS03043 + 2 x LV431064 (raiser)	LVS03043	LVS03043
Front plates cut-out	LVS03247 [5]	LVS03235 [5]	LVS03235 [5]
[Nb. of vertical upstream modules]	LVS03803 [3]	LVS03803 [3]	LVS03803 [3]
downstream	LVS03802 [2]	LVS03802 [2]	LVS03802 [2]
Mechanical interlocking / Complete source-changeover assembly	31073 	100 A: 31140 160 A: 31144 200 A: 31142 250 A: 31146	100 A: 31141 160 A: 31145 200 A: 31143 250 A: 31147
Upstream connection			
Cable + Long terminal shields	3P : LV429517 4P : LV429518 		
Coupling accessory	3P : LV429358 4P : LV429359 		
Downstream connection			
Cable + Long terminal shields	3P : LV429517 4P : LV429518 		

Note: For cable-tie function, add 1 module above. > page C-44



TransferPacT 32A-100A Automatic source changeover system W600/850

Changeover system

Mounting		Vertical Fixed	
Devices		TransferPacT Automatic / Active Automatic 32A-100A 2P/3P/4P	
No. of devices per row		1	
No. of vertical modules		6M	
Mounting plate		LVS03426	
DIN Rail	W600	-	LVS03002 (adjustable)
	W850	-	LVS03007 (adjustable)
Front plate with cut-out	W600	LVS03206	
	W850	LVS03208	

Upstream / Downstream Connections									
Cable	<table border="1"> <tr> <td>mm in.</td> <td></td> <td></td> <td></td> </tr> <tr> <td></td> <td>13 0.51</td> <td>1.5-35 mm² 16-2 AWG</td> <td>1-35 mm² 18-2 AWG</td> </tr> </table>	mm in.					13 0.51	1.5-35 mm ² 16-2 AWG	1-35 mm ² 18-2 AWG
mm in.									
	13 0.51	1.5-35 mm ² 16-2 AWG	1-35 mm ² 18-2 AWG						
Long terminal shields	<p>TPSISO30</p>								

Auxiliary	
Coupling auxiliary module	<p>TPSAUX32 TPSAUX33</p>

TransferPacT 80A-160A Automatic source changeover system W600/850

Changeover system

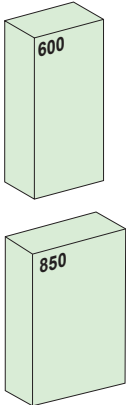
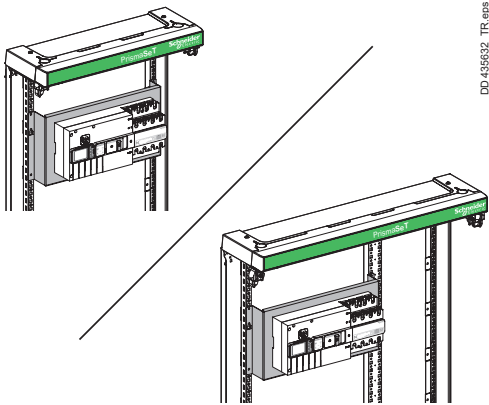
Mounting		Vertical Fixed
		
Devices	TransferPacT Automatic / Active Automatic 80A-160A 3P/4P	
No. of devices per row	1	
No. of vertical modules	8M	
Mounting plate	LVS03427	
Front plate	W600	LVS03207
with cut-out	W850	LVS03209

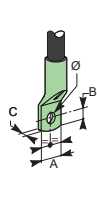
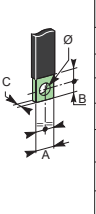
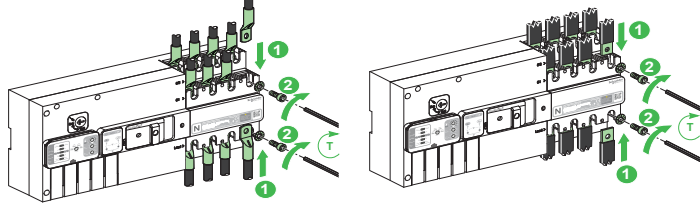

Upstream / Downstream Connections

Cable/Busbars	  <table border="1" data-bbox="638 1131 774 1344"> <thead> <tr> <th>mm</th> <th>in.</th> </tr> </thead> <tbody> <tr> <td>A</td> <td>≤ 20</td> </tr> <tr> <td>B</td> <td>≤ 0.78</td> </tr> <tr> <td>B</td> <td>≤ 10</td> </tr> <tr> <td>B</td> <td>≤ 0.39</td> </tr> <tr> <td>C</td> <td>≤ 6</td> </tr> <tr> <td>C</td> <td>≤ 0.24</td> </tr> <tr> <td>Ø</td> <td>≥ 8</td> </tr> <tr> <td>Ø</td> <td>≥ 0.31</td> </tr> <tr> <td>T</td> <td>8±0.8 N·m</td> </tr> <tr> <td></td> <td>70.8±7.08 lb-in.</td> </tr> <tr> <td></td> <td>M8</td> </tr> <tr> <td></td> <td>6</td> </tr> </tbody> </table> 	mm	in.	A	≤ 20	B	≤ 0.78	B	≤ 10	B	≤ 0.39	C	≤ 6	C	≤ 0.24	Ø	≥ 8	Ø	≥ 0.31	T	8±0.8 N·m		70.8±7.08 lb-in.		M8		6
mm	in.																										
A	≤ 20																										
B	≤ 0.78																										
B	≤ 10																										
B	≤ 0.39																										
C	≤ 6																										
C	≤ 0.24																										
Ø	≥ 8																										
Ø	≥ 0.31																										
T	8±0.8 N·m																										
	70.8±7.08 lb-in.																										
	M8																										
	6																										

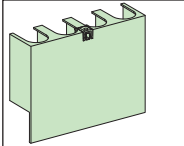
Long terminal shields	 <p>TPSISO31</p>
-----------------------	--

Auxiliary

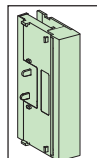
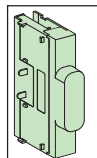
Coupling auxiliary module	 <p>TPSAUX32</p>  <p>TPSAUX33</p>
---------------------------	---

Fupact GS32/63/100/160

Horizontal mounting - Fixed - Extended rotary handle

W600

Fusegear

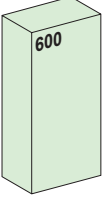
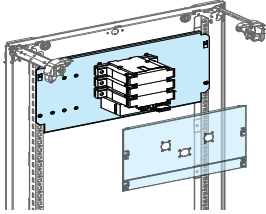
Mounting		W600 Horizontal - Fixed	
			
Devices		GS32	GS63/100/160
		3P or 4P	-
Number of devices per row		1	1
Nb. of vertical modules		3	5
Mounting plates		LVS03117	LVS03118
Front plates cut-out		LVS03308	LVS03309
[Nb. of vertical modules] downstream		-	-
Upstream connection			
Long terminal shields		-	-
		-	-
		-	-
		3 x LV480445	4 x LV480445

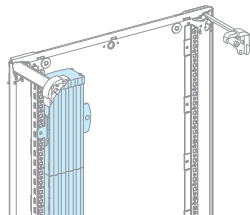
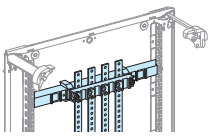
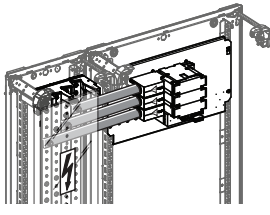

Downstream distribution	Insulated Linergy BW busbars (2)	Rear Linergy BS busbars	Linergy BS multi-stage busbars
			
Type of connected devices	GS100/160	All types	All types
Busbars	Linergy BW > page D-4	LVS04191 + copper bars > page D-6	LVS04192 + copper bars > pages D-7, D-8
Power supply block	LVS04061 > page C-43	-	-
Connection	Must be made	Must be made	Must be made
Long terminal shields	3P : 3 x LV480445 4P : 4 x LV480445	3P : 3 x LV480445 4P : 4 x LV480445	3P : 3 x LV480445 4P : 4 x LV480445

Fupact GS32/63/100/160

Vertical mounting - Fixed - Extended rotary handle

W600

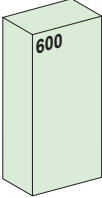
Fusegear

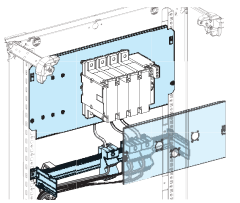
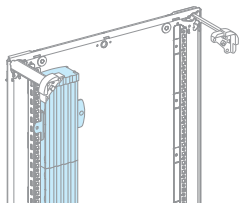
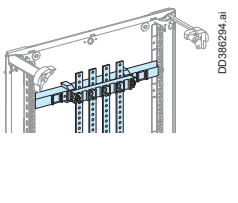
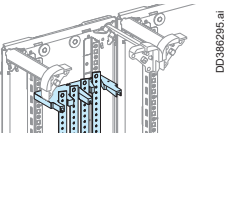

Mounting		W600 Vertical - Fixed	
			
Devices		GS32	GS63/100/160
		3P or 4P	-
Number of devices per row		3	2
Nb. of vertical modules		3	5
Mounting plates		LVS03117	LVS03118
Front plates cut-out		LVS03308	LVS03309
[Nb. of vertical modules] downstream		-	-
Upstream connection			
Long terminal shields		-	3 x LV480445

Downstream distribution	Distribution block Linergy DX 1P, 160 A	Insulated Linergy BW busbars (2)	Rear Linergy BS busbars	Linergy BS multi-stage busbars
				
Type of connected devices	GS100/160	GS100/160	GS100/160	GS100/160
	3P 4P	3P 4P	3P 4P	3P 4P
Distribution block / busbars	3 x LVS04031 + LVS03002 > page D-11	4 x LVS04031 + LVS03002 > page D-11	Linergy BW > page D-4	LVS04191 + copper bars > page D-6
Power supply block	-	LVS04061 > page C-43	-	-
Connection	Must be made	Must be made	Must be made	Must be made
Long terminal shields	3 x LV480445 4 x LV480445	3 x LV480445 4 x LV480445	3 x LV480445 4 x LV480445	3 x LV480445 4 x LV480445

Fupact ISFT160/250

Horizontal mounting - Fixed

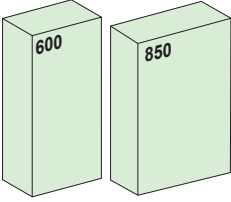
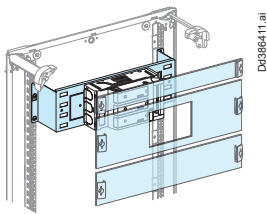
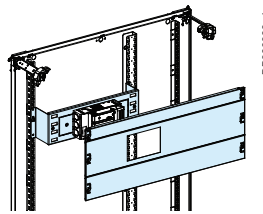
W600 - W850

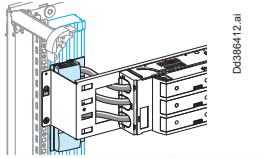
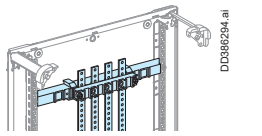
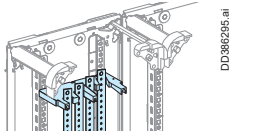
Mounting		W600 Horizontal - Fixed		W850 Horizontal - Fixed			
							
Devices		ISFT160	ISFT250	ISFT160	ISFT250		
Number of devices per row		1	1	1	1		
Nb. of vertical modules		6	6	6	6		
Mounting plates		LVS03121	LVS03124	LVS03121	LVS03124		
Front plates cut-out		LVS03326 [3]	LVS03328 [5]	LVS03336 [3]	LVS03337 [5]		
[Nb. of vertical modules] upstream		LVS03801 [1]	-	LVS03851 [1]	LVS03851 [1]		
downstream		LVS03802 [2] (1)	LVS03801 [1]	LVS03809 [2]	-		
Upstream connection							
Long terminal shields		LV480819		LV480824			
Downstream distribution		Insulated Linergy BW busbars		Rear Linergy BS busbars		Linergy BS multi-stage busbars	
							
Type of connected devices		ISFT160	ISFT250	ISFT160	ISFT250	ISFT160	ISFT250
Busbars		Linergy BW > page D-4		LVS04191 + copper bars > page D-6		LVS04192 + copper bars > pages D-7, D-8	
Power supply block		LVS04061 > page C-43		-		-	
Connection		Must be made		Must be made		Must be made	
Long terminal shields		LV480819	LV480824	LV480819	LV480824	LV480819	LV480824

(1) Not needed if direct distribution.

Fupact ISFT100/100N, ISFT160/250

Vertical mounting - Fixed

W600 - W850 - W300

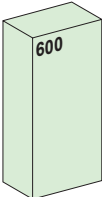
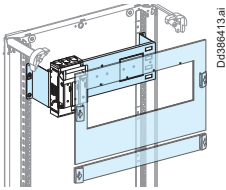
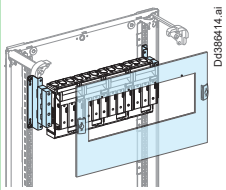
Mounting		W600 Vertical - Fixed				
						
Devices		On mounting plate			On busbars (2)	
		ISFT100	ISFT100N	ISFT160	ISFT100N	ISFT160
Number of devices per row		5	8	4	6	4
Nb. of vertical modules		6	8	8	8	8
Mounting plates		LVS03120	LVS03126	LVS03121	LVS03122 (2)	LVS03122 (2)
Front plates [Nb. of vertical modules]	cut-out	LVS03320 [6]	-	LVS03321 [6]	-	LVS03321 [6]
	upstream	-	-	-	-	-
	downstream	-	-	LVS03802 [2] (1)	-	LVS03802 [2] (1)
Upstream connection						
Long terminal shields		-	LV480756	LV480819	LV480756	LV480819

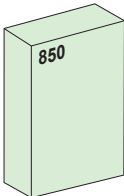
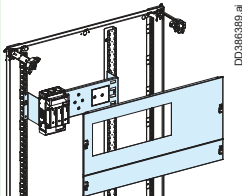
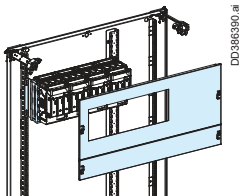
Mounting		W850 Vertical - Fixed				
						
Devices		On mounting plate			On busbars (2)	
		ISFT100	ISFT100N	ISFT160	ISFT100N	ISFT160
Number of devices per row		5	-	4	-	4
Nb. of vertical modules		6	-	8	-	8
Mounting plates		LVS03120	-	LVS03121	-	LVS03122 (2)
Front plates [Nb. of vertical modules]	cut-out	LVS03338 [6]	-	LVS03318 [6]	-	LVS03318 [6]
	upstream	-	-	-	-	-
	downstream	-	-	LVS03809 [2] (1)	-	LVS03809 [2] (1)
Upstream connection						
Long terminal shields		-	LV480756	LV480819	LV480756	LV480819

(1) Not needed if direct distribution.
 (2) Only for 3P.

PrismaSeT G - Functional units

Fupact ISFT100/100N, ISFT160/250

Vertical mounting - Fixed

W600 - W850 - W300

Fusegear

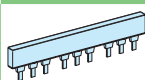
Upstream connection		Comb busbar		
				
		DD382434.eps		
Connected devices	Type	ISFT100		
	Number	2	3	4
Comb busbar		49861	49862	49863
Set of 3 connectors		49865 (25 to 95 mm ²)		
		49860 (3 x 10 mm ²)		

Incoming connection		Comb busbar		
				
		DD119428.ai		
Connected devices	Type	ISFT160		
	Number	2	3	4
Comb busbar		LV480811	LV480812	LV480813
Set of 3 connectors		LV480818 (25 to 95 mm ²)		
		LV480814 (3 x 16 mm ²)		

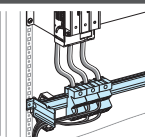
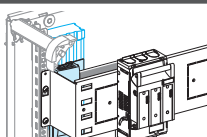
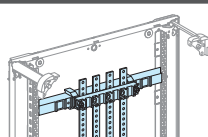
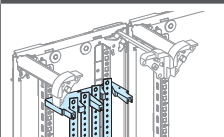
Downstream distribution	Distribution block Linergy DX 1 P, 160 A		Insulated Linergy BW busbars		Rear Linergy BS busbars		Linergy BS multi-stage busbars	
								
	DD383659.ai		DD386415.ai		DD386294.ai		DD386295.ai	
Type of connected devices	ISFT100N	ISFT160	ISFT100N	ISFT160	ISFT100N	ISFT160	ISFT100N	ISFT160
Distribution block / busbars	3 x LVS04031 + LVS03002 > page D-11		Linergy BW > page D-4		LVS04191 + copper bars > page D-6		LVS04192 + copper bars > pages C-25, D-8	
Power supply block	-		LVS04061 > page C-43		-		-	
Connection	Must be made		Must be made		Must be made		Must be made	
Long terminal shields	LV480756	LV480819	LV480756	LV480819	LV480756	LV480819	LV480756	LV480819

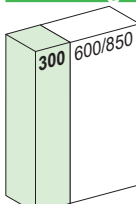
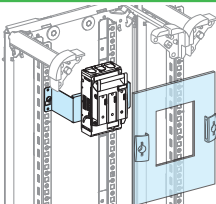
Mounting	W300 Vertical - Fixed			
				
	DD386416.ai			
Devices	ISFT160		ISFT250	
Number of devices per row	1		1	
Nb. of vertical modules	6		9	
Mounting plates	LVS03123		LVS03125	
Cut-out front plate	LVS03327		LVS03329	
Upstream connection	LV480819		LV480824	
Long terminal shields	LV480819		LV480824	

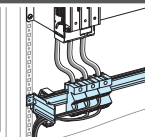
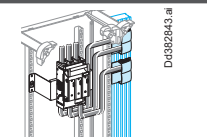
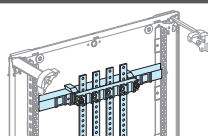
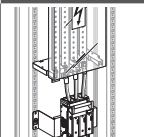
Downstream distribution	Distribution block Linergy DX 1 P, 160 A		Insulated Linergy BW busbars		Rear Linergy BS busbars		Linergy BS busbars in duct	
								
	DD383659.ai		DD382843.ai		DD386294.ai		DD382490.ai	
Type of connected devices	ISFT160	ISFT250	ISFT160	ISFT250	ISFT160	ISFT250	ISFT160	ISFT250
Busbars / Distribution block	3 x LVS04031 + LVS03002 > page D-11		Linergy BW > page D-4		LVS04191 + copper bars > page D-6		LVS04192 + copper bars > pages D-7, D-8	
Power supply block	-		LVS04061 > page C-43		-		-	
Connection	Must be made		Must be made		Must be made		Must be made	
Long terminal shields	LV480819	LV480824	LV480819	LV480824	LV480819	LV480824	LV480819	LV480824

(1) Not needed if direct distribution.

(2) Only for 3P.

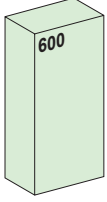
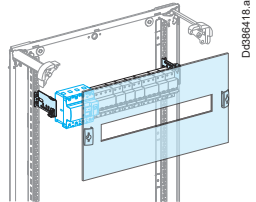
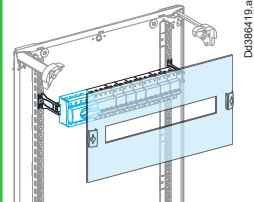

Modular devices ≤ 160 A switchboard incomer
W600 - W850 - W300

Modular devices

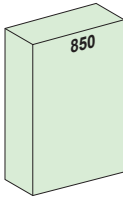
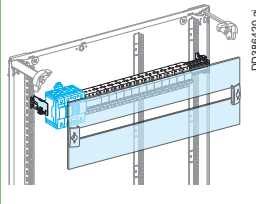
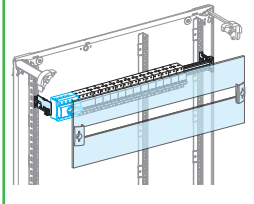
Mounting	W600 Circuit breaker		W600 Switch-disconnector	
				
Devices	NG160, Vigi NG160 (1) (2)	NG125, Vigi NG125, C120, Vigi C120	INS-INV40/160	INS-INV100/160 with long terminal shields
Nb. of vertical modules	5	5	4	5
Rail (48 modules of 9 mm)	LVS03002 (adjustable) (1)	LVS03001	LVS03001	LVS03001
Modular front plates [Nb. of vertical modules]	LVS03205 [5]	LVS03205 [5]	LVS03204 [4]	LVS03205 [5]
Blanking plates	strip divisible	LVS03220 LVS03221	LVS03220 LVS03221	LVS03220 LVS03221

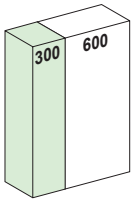
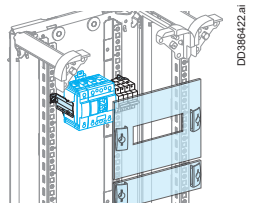
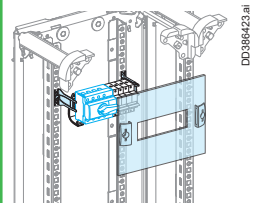
Mounting	W850 Circuit breaker		W850 Switches	
				
Devices	NG160, Vigi NG160 (1) (2)	NG125, Vigi NG125	Compact INS-INV40/160	Compact INS-INV100/160 with long terminal shields
Nb. of vertical modules	5	5	4	5
Rail (72 modules of 9 mm)	LVS03007 (adjustable) (2)	LVS03006	LVS03006	LVS03006
Modular front plates [Nb. of vertical modules]	LVS03218 [5]	LVS03218 [5]	LVS03217 [4]	LVS03218 [5]
Blanking plates	strip divisible	LVS03220 LVS03221	LVS03220 LVS03221	LVS03220 LVS03221

Mounting	W300 Circuit breaker		W300 Switch-disconnector	
				
Devices	NG160 (1)	NG125, Vigi NG125, C120, Vigi C120	INS-INV40/160	INS-INV100/160 with long terminal shields
Nb. of vertical modules	6	4	4	6
Rail (20 modules of 9 mm)	LVS03011 (adjustable) (1)	LVS03010	LVS03010	LVS03010
Front plates [Nb. of vertical modules]	modular downstream	LVS03214 [4]	LVS03214 [4]	LVS03214 [4]
Blanking plates	strip divisible	LVS03812 [2] LVS03220 LVS03221	- LVS03220 LVS03221	LVS03812 [2] LVS03220 LVS03221

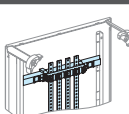
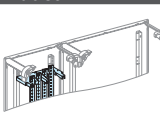
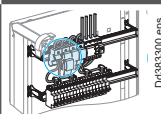
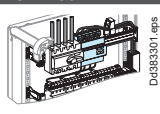
Downstream distribution	Insulated Linergy BW busbars	Rear Linergy BS busbars	Linergy BS Multi-stage busbars in duct	Distribution block, Linergy DX 1P, 160 A	Distribution block, Linergy DX 4P, 125 A/160 A	
						
Type of connected devices Busbars / Distrib blocks	All types Linergy BW > page D-4	All types LVS04191+ copper bars > page D-6	All types LVS04192+ copper bars > pages D-7, D-8	All types LVS04031 > page C-15	125A LVS04045 > page C-15	160A LVS04046 > page C-15
Connection	> page D-5	Must be made	Must be made	LVS04149	LVS04047	supplied with

(1) End of life mid 2018 substituted by NSXm > page C-3.

(2) Can be completed by a rail + raiser (cat no. LVS04227) to install modular devices on.

Modular devices outgoers ≤ 63 A

W600 - W850 - W300

Modular devices

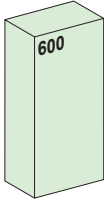
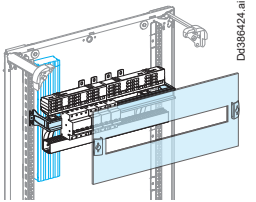
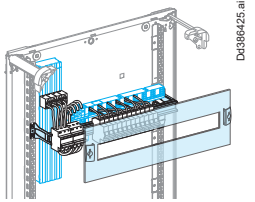
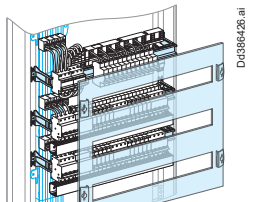
Mounting	W600 Distances between centres : 200 mm	W600 Distances between centres : 150 mm	
			
Devices	All modular devices	Modular devices ≤ 40 A	
Rail length (modules of 9 mm)	48	48	48 x 3
Nb. of vertical modules	4 (1)	3	8
Rail (48 modules of 9 mm)	LVS03001	LVS03001	LVS03001 x 3
Modular front plates <i>[Nb. of vertical modules]</i>	LVS03204 [4]	LVS03203 [3]	LVS03223 [8]
Blanking plates	strip LVS03220	LVS03220	LVS03220
divisible	LVS03221	LVS03221	LVS03221

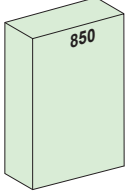
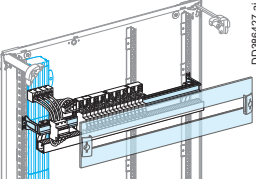
Mounting	W850 distance between centres : 200 mm	W850 Distance between centres : 150 mm
		
Devices	All modular devices	Modular devices ≤ 40 A
Rail length (modules of 9 mm)	72	72
Nb. of vertical modules	4	3
Rail (72 modules of 9 mm)	LVS03006	LVS03006
Modular front plates <i>[Nb. of vertical modules]</i>	LVS03217 [4]	LVS03216 [3]
Blanking plates	strip LVS03220	LVS03220
divisible	LVS03221	LVS03221

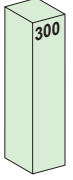
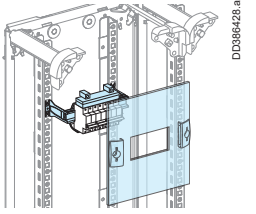
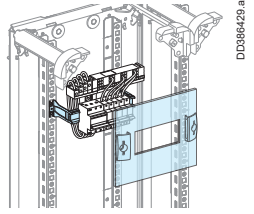
Mounting	W300 Distance between centres : 200 mm	W300 Distance between centres : 150 mm
		
Devices	All modular devices	Modular devices ≤ 40 A
Rail length (modules of 9 mm)	20	20
Nb. of vertical modules	4	3
Rail (20 modules of 9 mm)	LVS03010	LVS03010
Modular front plate <i>[Nb. of vertical modules]</i>	LVS03214 [4]	LVS03213 [3]
Blanking plates	strip LVS03220	LVS03220
divisible	LVS03221	LVS03221

Downstream distribution	Linergy FH comb busbar	Distribution system Linergy FM 63 A
		
Type of connected devices	According devices	LVS04008
Comb Busbars / Distrib system	> page D-18	> page D-16

(1) For a modular row with Linergy FM160 or 200 A positioned directly below a non-modular mounting plate (Compact...) or at the top of a switchboard, add 1 module (4+1) and a plain upstream front plate (cat no. LVS03801).

Other modular devices

Switchboard lighting

W600 - W850 - W300

Other devices

Other devices behind transparent front plates

		W600	W850 (4)	W300
Nb. of modules	Height			
4	200 mm	LVS03342	-	LVS03352
6	300 mm	LVS03343	LVS03363	LVS03353
9	450 mm	LVS03344	LVS03364	LVS03354
12	600 mm	LVS03345	-	-

Vigirex, Vigilohm and other modular devices

		W600	W600	W850	W300
Devices		Vigirex (1), Vigilohm (2)		Other modular devices (3) ammeter, voltmeter, lamp, pushbuttons	
Nb. of vertical modules		3		3	3
Rail (48 modules of 9 mm)		LVS03001	LVS03001	LVS03006	LVS03010
Cut-out front plates		LVS03203	LVS03202	LVS03216	LVS03213

Lighting

	W600 fixed lighting	Switchboard portable lamp
Catalog number	LVS08964	LVS08965
Presentation	This system is generally used to illuminate the front of a switchboard.	<ul style="list-style-type: none"> Lamp with a magnetic base for installation behind a door or directly on the cubicle framework. Supplied without a power cord H x W x D: 90 x 345 x 42
Characteristics	<ul style="list-style-type: none"> Supply voltage: 220/240 V Power rating: 8 W Height: 1 module vertical (50 mm) 	<ul style="list-style-type: none"> Supply voltage: 220/240 V Power rating: 11 W Lamp: picoline OSRAM 8W (supplied) Class 2 IP20

(1) RH10, RH21, RH99, RMH relay and RM12T Multiplexer.

(2) IM9, IM9-OL, IM20, IM20H.

(3) For installation at the top or bottom of the enclosure, use a 3-modules modular front plate (LVS03203).

(4) 2/3 transparent front plate.

Kilowatt-hour meters

Class II

W600 - W850 - W300

Other devices

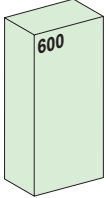
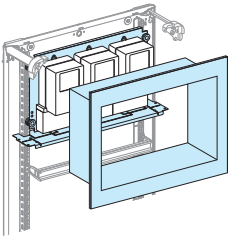
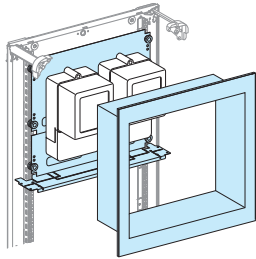
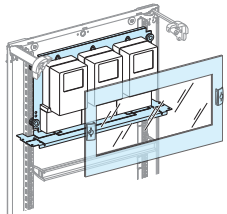
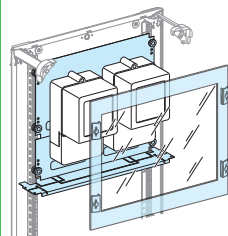
Mounting	W600 Accessible (1)		W600 Behind front plate (1)	
				
Devices	1-phase (Ph + N)	3-phase (3 Ph + N)	1-phase (Ph + N)	3-phase (3 Ph + N)
Number of devices per row	3	2	3	2
Nb. of vertical modules	6	8	6	9
Mounting plates	-	LVS03152	-	LVS03152
Metering front plate	LVS03155 [6]	LVS03158 [8]	-	-
Front plates transparent	-	-	LVS03343 [6]	LVS03344 [9]
at your choice plain	-	-	LVS03806 [6]	-
Horizontal partitioning	LVS04331	LVS04331	LVS04331	LVS04331
Insulating plate (class II)	-	-	-	-
Accessories	M5 spacers for mounting plate > page C-51			

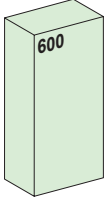
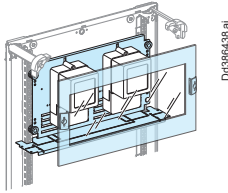
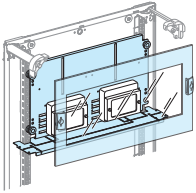
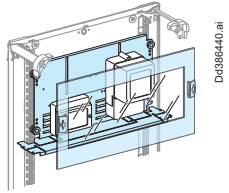
Mounting	W600 Behind front plate (1)		
			
Devices	3-phase kilowatt-hour meters (3 Ph + N)	Connection blocks	3-phase kilowatt-hour meters (3 Ph + N) + connection blocks
Number of devices per row	2	2	1+1
Nb. of vertical modules	6	6	6
Mounting plates	LVS03160	LVS03160	LVS03160
Front plates transparent	LVS03343 [6]	LVS03343 [6]	LVS03343 [6]
at your choice plain	LVS03806 [6]	LVS03806 [6]	LVS03806 [6]
Horizontal partitioning	LVS04331	LVS04331	LVS04331
Earthing braid (2)	LVS08910	LVS08910	LVS08910
Accessories	M5 spacers for mounting plate > page C-51		

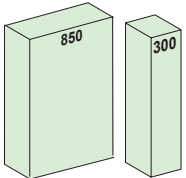
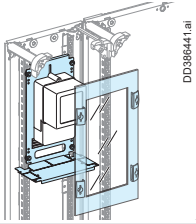
Mounting	W850 Behind front plate (3)			W300 Behind front plate (1)
				
Devices	1-phase (Ph + N)	3-phase (3 Ph + N)	3-phase (3 Ph + N)	3-phase (3 Ph + N)
Number of devices per row	3	2	2	1
Nb. of vertical modules	6	9	6	9
Mounting plates	-	LVS03152	LVS03160	LVS03156
Front plates transparent	LVS03363	LVS03364	LVS03363	LVS03354 [9]
at your choice plain	LVS03856	LVS03859	LVS03856	LVS03817 [9]
Horizontal partitioning	-	-	-	LVS04332
Earthing braid (2) / Insulating plate	-	-	LVS08910	LVS08910
Accessories	-	-	-	M5 spacers for mounting plate > page C-51

(1) Order one additional horizontal partition in case of installation other than at the top of enclosure.

(2) Meters can be installed directly on mounting plate equipped with 6 mm² earthing braid (cat.no LVS08910) and combined with partitioning or front plates.

(3) On the right of the front plate, possibility to install 96 x 96 device > page C-37.

TeSys D, TeSys K contactors

Mounting	W600	W850	W300
Devices	LC1D● or LC1K● (≤ 40 A)	LC1D● or LC1K● (≤ 40 A)	LC1D● or LC1K● (≤ 40 A)
Useful length for rail	432 mm	648 mm	180 mm
Nb. of vertical modules	3	3	3
Modular rail	LVS03004 (in rear)	LVS03007	LVS03011 (adjustable)
Plain front plate	LVS03803	LVS03853	LVS03813

TeSys GV2/GV3 circuit breakers

Mounting	W600			W850			W300		
Devices	TeSys GV2L, GV2P	TeSys GV2RT, GV2ME, GV2LE	TeSys GV3	TeSys GV2L, GV2P	TeSys GV2RT, GV2ME, GV2LE	TeSys GV3	TeSys GV2L, GV2P	TeSys GV2RT, GV2ME, GV2LE	TeSys GV3
Useful length for rail	432 mm	432 mm	432 mm	648 mm	648 mm	648 mm	180 mm	180 mm	180 mm
Nb. of vertical modules	3	3	5	3	3	5	3	3	7
Modular rail	LVS03002	LVS03001	LVS03002	LVS03007	LVS03006	LVS03007	LVS03011	LVS03010	LVS03011 (adjustable)
Front plates [Nb. of vertical modules]	cut-out upstream	LVS03203 [3]	LVS03203 [3]	LVS03205 [5]	LVS03216 [3]	LVS03216 [3]	LVS03218 [3]	LVS03213 [3]	LVS03213 [3]
	downstream	-	-	-	-	-	-	-	LVS03812 [2]
Blanking plates > page C-52	strip	LVS03220	LVS03221	-	-	-	-	-	LVS03812 [2]
	divisible	-	-	-	-	-	-	-	-

Combined TeSys GV2 circuit breaker + TeSys GV3P●●1 contactor

Mounting	W600		W850		W300		
Devices	GV2 + LC1D● or LC1K● (≤ 40 A)	GV3P●●1	GV2 + LC1D● or LC1K● (≤ 40 A)	GV3P●●1	GV2 + LC1D● or LC1K● (≤ 40 A)	GV3P●●1	
Useful length for rail	432 mm	432 mm	648 mm	648 mm	180 mm	180 mm	
Nb. of vertical modules	5	7	6	9	6	8	
Modular rail	LVS03004 (in rear)	LVS03004	LVS03007	LVS03007	LVS03011 (adjustable)	LVS03011	
Front plates [Nb. of vertical modules]	transparent	LVS03342 [4]	LVS03343 [6]	LVS03363 [6]	LVS03364 [9]	LVS03352 [4]	LVS03353 [6]
	downstream	LVS03801 [1]	LVS03801 [1]	-	-	LVS03812 [2]	LVS03812 [2]

2 types of device mounting 72 x 72 and 96 x 96

①

> On an interface with plastic mounting plates clipped onto the metal front plate with cut-outs

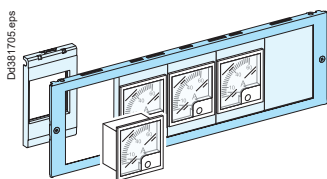

- The interface is made up of a metal front plate and plastic mounting plates that clip onto the front plate.
- The devices are attached in the cut-outs of the plastic mounting plates and insulated from the front plate.

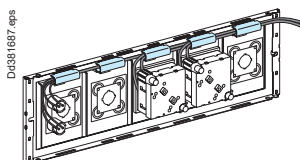

- A system at the rear of the mounting plates guides the wires.

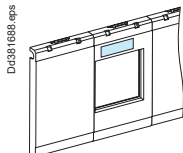

- Each mounting plate can receive an adhesive label.
- Plain mounting plates are available to blank off any unused locations.

②

> Directly on a metal front plate with cut-outs

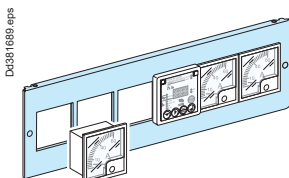

- Devices are attached directly to the metal front plate.
- Blanking plates are available to blank off any unused locations.

2 mounting types in PrismaSeT G

①

> In the device zone of wall-mounted and floor-standing enclosures

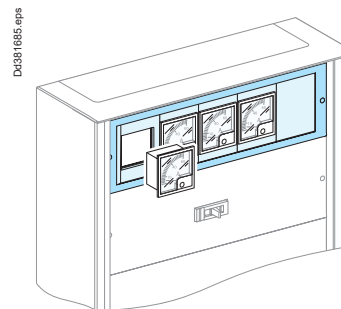

②

> On a plain door with cut-outs, on an inclined visor by 30°

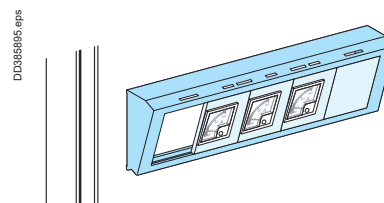

- With cut-out plastic mounting plate directly clipped on the visor.
- Supplied with a drilling diagram for mounting on a plain door.

Precut dimensions

- Cat. number **LVS03910**

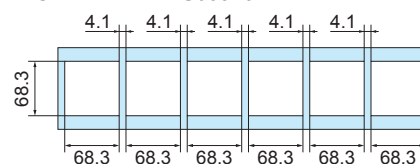

- Cat. number **LVS03911**

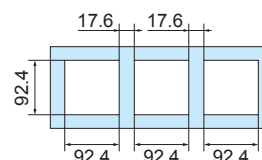

- Cat. number **LVS03925**

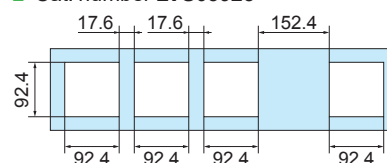











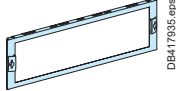



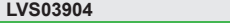





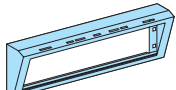









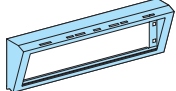





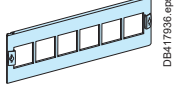

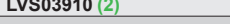
Note: device mounting on door: earthing braid (ref. LVS08910) or earthing wire (ref. LVS08911).

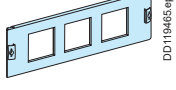
Human-switchboard interface

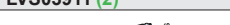
Devices 72 x 72 - 96 x 96

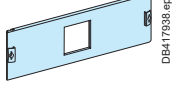
Ø22 Lamps and pushbuttons

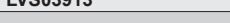
Other devices

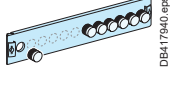
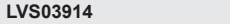
No. and type of devices per row	Metal front plate with cut-outs	Nb. of vertical modules	Plastic mounting plates cut-out	Blanking plate or devices support
Mounted on W600 front plate with interface and/or plastic plate				
5 x  Vigirex and other devices 72 x 72	 DB417935.eps	3	 DD385485.eps	 DD385486.eps To blank-off or install: - from 1 to 4 buttons Ø 16 or 22 mm - 1 device, 45 x 45
4 x  Power Meter and others devices 96 x 96	 LVS03904		 DD385487.eps	 DD385488.eps To blank-off or install: - from 1 to 4 buttons Ø 16 or 22 mm - 1 device, 45 x 45 - 1 device, 72 x 72
or 2 x  For PM200, 200P, PM5 & PM8 series meters			 LVS03903	 LVS03901
Mounted on W600 canopy tilted to 30° with plastic plate				
5 x  Vigirex and other devices 72 x 72	 DD385459.eps	3	 DD385465.eps	 DD385466.eps To blank-off or install: - from 1 to 4 buttons Ø 16 or 22 mm - 1 device, 45 x 45
4 x  Power Meter and others devices 96 x 96	 LVS03928 (1)		 DD385467.eps	 DD385468.eps To blank-off or install: - from 1 to 4 buttons Ø 16 or 22 mm - 1 device, 45 x 45 - 1 device, 72 x 72
or 2 x  For PM200, 200P, PM5 & PM8 series meters			 LVS03903	 LVS03901
Mounted on W850 canopy tilted to 30° with plastic plate				
5 x  Vigirex and other devices 72 x 72	 DD385458.eps	3	 DD385465.eps	 DD385466.eps To blank-off or install: - from 1 to 4 buttons Ø 16 or 22 mm - 1 device, 45 x 45
	 LVS03929 (1)		 LVS03902	 LVS03900
Directly mounted on W600 metal front plate with cut-out				
72 x 72 devices				
7 x  Vigirex and other devices 72 x 72	 DB417936.eps	3	Direct mounting	 DD385469.eps To blank-off or install: - from 1 or 2 buttons Ø 22 mm - 1 device, 45 x 45
	 LVS03910 (2)		-	 LVS03907
96 x 96 devices				
3 x  Power Meter and other devices 96 x 96	 DD119465.eps	3	Direct mounting	 DD385470.eps To blank-off or install: - from 1 or 2 buttons Ø 22 mm - 1 device, 45 x 45 - 1 device, 72 x 72
	 LVS03911 (2)		-	 LVS03908
1 x  Power Meter and other devices 96 x 96	 DB417938.eps	3	Direct mounting	 DD385470.eps To blank-off or install: - from 1 or 2 buttons Ø 22 mm - 1 device, 45 x 45 - 1 device, 72 x 72
	 LVS03913		-	 LVS03908
Pushbuttons and lamps Ø22 mm				
20 x  Ø 22 mm	 DB417940.eps	2	Direct mounting	
	 LVS03914		-	-

Note: To maintain the IP55 degree of protection, the measurement devices must be installed behind a transparent door.

(1) The visor (cat. no. LVS03928) can be installed on a plain door with cut-out.

(2) Precut dimensions "Human-switchboard interface", page C-37.







(3) For PM200, 200P, PM5 & PM 8 series meters, use 2 no. blank off sheets between each meter.

Human-switchboard interface

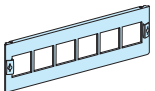
Devices 72 x 72 - 96 x 96

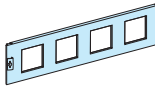
Ø22 Lamps and pushbuttons

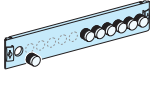
Other devices

Directly mounted on W850 metal front plate with cut-out							
72 x 72 devices							
6 x	72 x 72	Vigirex and other devices 72 x 72	 DB417936.eps	3	Direct mounting	 DD385469.eps	To blank-off or install: - from 1 or 2 buttons Ø 22 mm - 1 device, 45 x 45
			LVS03909 (2)	-		LVS03907	
96 x 96 devices							
4 x	96 x 96	Power Meter and other devices 96 x 96	 DD385861.eps	3	Direct mounting	 DD385470.eps	To blank-off or install: - from 1 or 2 buttons Ø 22 mm - 1 device, 45 x 45 - 1 device, 72 x 72
			LVS03925 (2)	-		LVS03908	
Pushbuttons and lamps Ø22 mm							
12 x	Ø 22 mm		 DB417940.eps	2	Direct mounting		
			LVS03919	-		-	
Directly mounted on W300 metal front plate with cut-outs							
1 x	96 x 96	Power Meter and other devices 96 x 96	 DD385960.eps	3	Direct mounting	 DD385470.eps	To blank-off or install: - from 1 or 2 buttons Ø 22 mm - 1 device, 45 x 45 - 1 device, 72 x 72
			LVS03923	-		LVS03908	

Note: To maintain the IP55 degree of protection, the measurement devices must be installed behind a transparent door.

(1) The visor (cat. no. LVS03928) can be installed on a plain door with cut-out.

(2) Precut dimensions "Human-switchboard interface", page C-37





Terminal block and earth bar installation

Accessories

Support plate and dedicated mounting plate, in device compartment

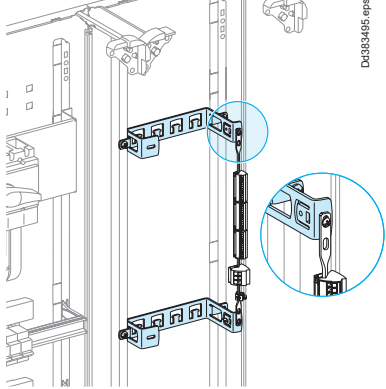
This mounting assembly is used to easily install and connect a large number of terminal blocks in a minimum amount of space. It is particularly useful when a duct is not warranted or cannot be installed.

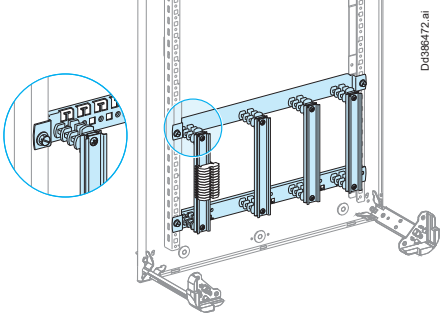
Used for	On mounting plate for terminal block and Linergy TB earth bar	Used for	In device compartment
			
Number of vertical modules	-		5 (250 mm)
Catalog number	LVS04220		LVS04223
Characteristics	<ul style="list-style-type: none"> ■ A mounting plate made up of two supports, is equipped with: <ul style="list-style-type: none"> □ a 1600 mm modular rail (LVS04226) for terminal blocks □ Linergy TB earth bar > page D-23 ■ The supports have cut-outs that can be used to easily tie down the connection wires. 		<ul style="list-style-type: none"> ■ Mounting brackets, fixed to the functional uprights at the top or bottom of the enclosure, is equipped with four 200 mm symmetrical rails. They are installed vertically to facilitate cable running. ■ To facilitate mixing of different size terminal blocks and ensure convenient connections from the front or the side, the distance between rails and the depth of each rail can be adjusted. ■ The assembly has cut-outs that can be used to easily tie down the connection wires. ■ Linergy TB earth bars and Linergy TR terminal blocks layout, supplied separately, can be installed between the rows of terminal blocks to form different configurations, e.g.: <ul style="list-style-type: none"> □ four sets of terminal blocks □ 3 sets of terminal blocks + one or two Linergy TB earth bars (W = 290 mm).

Installation on the side or in the width of the enclosure

This solution saves considerable space in the device zone and avoids the need for the 300 mm wide duct.

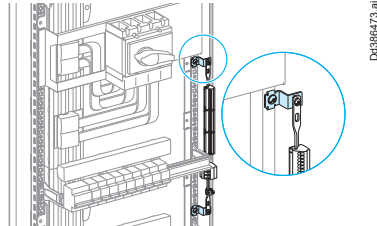
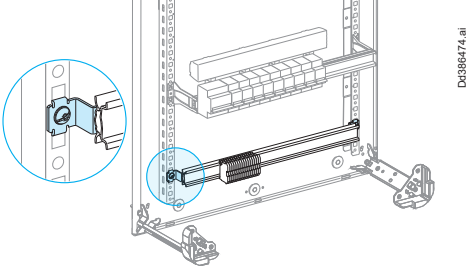
Fixing mode	2 fixing brackets for the earth bar on the functional uprights			Horizontally on brackets		
						
Catalog numbers	LVS04206	LVS04207	LVS04208	LVS04206	LVS04207	LVS04208
Characteristics	H = 15 mm	H = 45 mm	H = 80 mm	H = 15 mm	H = 45 mm	H = 80 mm
	Set of 2 brackets			Set of 2 brackets		

Linergy TR terminal blocks

> [page D-24](#)

Linergy TB earth bars

> [page D-23](#)

Partitioning in PrismaSeT G IP30 and IP55

Horizontal and Vertical system

Partitioning of functional units

Horizontal partitioning

The metal partitions are used to:

- separate the functional units from one to another
- create a physical separation between devices and a terminal block, for example.

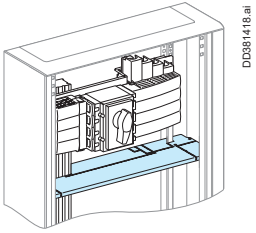
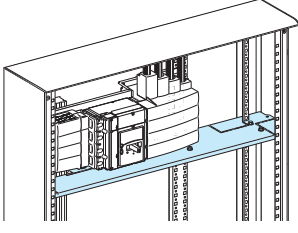
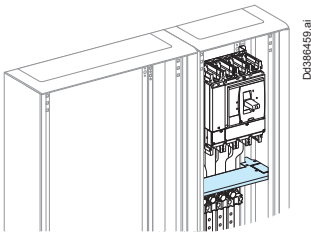
Used for	W600	W850	W300
IP30 IP55			
Catalog numbers	LVS04331	LVS04336	LVS04332
Characteristics	Metal. It is mounted directly on the functional uprights. Lateral and rear cut-outs are available for cable running or the installation of busbars at the rear of the switchboard.		

Vertical partitioning

The metal partition creates a physical separation between the device compartment and a wide duct, or enclosure.

It is used to:

- separate the devices from busbars or a distribution block installed in the duct,
- set up a special zone for terminal blocks in the duct.

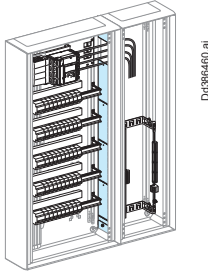
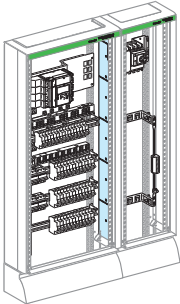
Used for	From 6 to 33 modules	36 modules
IP30		
Cat. no.	LVS04330	LVS04335
Description	Can be used for partitioning up to 33-modules. It can be cut to length every 150 mm.	Can be used for partitioning in 36-module floor standing enclosure.

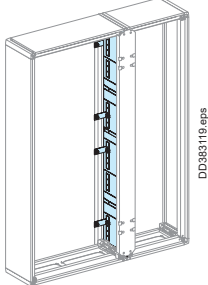
Used for	From 7 to 33 modules																								
IP55																									
Cat. no.	LVS08384																								
Description	Metal. There are cut -outs for cable running. Quantity to order according to height.																								
	<table border="1"> <thead> <tr> <th>Nb. of vertical modules</th> <th>7</th> <th>11</th> <th>15</th> <th>19</th> <th>23</th> <th>27</th> <th>33</th> </tr> </thead> <tbody> <tr> <td>Height (mm)</td> <td>450</td> <td>650</td> <td>850</td> <td>1050</td> <td>1250</td> <td>1450</td> <td>1750</td> </tr> <tr> <td>Quantity</td> <td>1</td> <td>2</td> <td>3</td> <td></td> <td></td> <td></td> <td></td> </tr> </tbody> </table>	Nb. of vertical modules	7	11	15	19	23	27	33	Height (mm)	450	650	850	1050	1250	1450	1750	Quantity	1	2	3				
Nb. of vertical modules	7	11	15	19	23	27	33																		
Height (mm)	450	650	850	1050	1250	1450	1750																		
Quantity	1	2	3																						

Connections blocks

Power supply blocks

Horizontal / Vertical mounting

Prefabricated connections

Incoming connection blocks

Upstream connection	Incoming connection block 250 A via top		Incoming connection block 250 A via bottom		Connection block 630 A (top/bottom)
Devices	ComPacT NSX100/250	ComPacT INS250, INV100/250	ComPacT NSX100/250	ComPacT INS250, INV100/250	ComPacT NSX400/630
Mounting	Horizontal	Horizontal	Horizontal	Horizontal	Horizontal, in duct
Catalog number	LVS04066	LVS04066	LVS04067	LVS04067	LVS04076
Configuration	> page C-6	> page C-18	> page C-6	> page C-18	> page C-13
Characteristics	Optimize the dimension of the enclosure, avoid the constraints of cables bending radius, and IPxxB solution				

Power supply block with connections between ComPacT device and Linergy BW isolated busbar

Downstream connection	Power supply block 250 A		Power supply block 250 A + prefabricated connections 250 A
Devices	ComPacT NSX100/250	ComPacT INS250, INV100/250	ComPacT INS250, INV100/250
Mounting	Horizontal	Horizontal	Vertical
Catalog number	LVS04060	LVS04060	LVS04060 + connection LVS04062
Configuration	> page C-6	> page C-18	> page C-19



Power supply block with connections between ComPacT device and Linergy BW isolated busbar
Devices 400-630 A

Downstream connection	Power supply block 400 A		Power supply block 630 A	
Devices	ComPacT NSX400	ComPacT INS-INV320/400	ComPacT NSX630	ComPacT INS-INV500/630
Mounting	Horizontal	Horizontal	Horizontal	Horizontal
Catalog number	LVS04070	LVS04070	LVS04071	LVS04071
Configuration	> page C-13	> page C-20	> page C-13	> page C-19

Connections blocks
Power supply blocks
Vertical mounting

Prefabricated connections

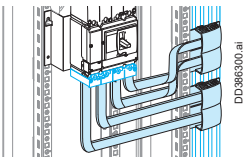
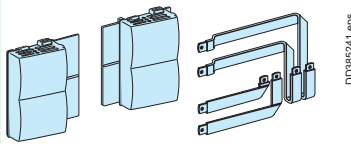
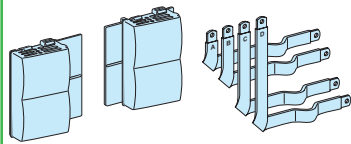
Universal power supply block + prefabricated connections between ComPacT device and Linergy BW isolated busbar



Downstream connection	Universal power supply 250 A + prefabricated connections 250 A	Universal power supply 250 A + prefabricated connections 250 A	
			
Devices	ComPacT NSX100/250	ComPacT NSX100/250	ComPacT INS250, INV100/250
Mounting	Vertical	Vertical, in duct	Vertical, in duct
Catalog number	LVS04061 + connection LVS04062	LVS04061 + connection LVS04064	LVS04061 + connection LVS04064
Configuration	> page C-7	> page C-7	> page C-7

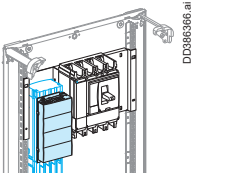
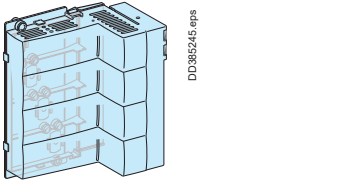
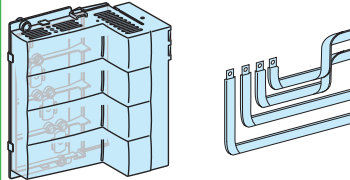
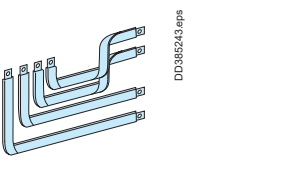

Downstream connection	Universal power supply 400/630 A + connection must be made		Universal power supply 400/630 A + prefabricated connections 400/630 A	
				
Devices	ComPacT NSX400/630	ComPacT INS-INV320/630	ComPacT NSX400/630	ComPacT INS-INV320/630
Mounting	Vertical	Vertical	Vertical, in duct	Vertical, in duct
Catalog number	LVS04074 + connection must be made	LVS04074 + connection must be made	LVS04074 + connection LVS04073	LVS04074 + connection LVS04073
Configuration	> page C-15	> page C-20	> page C-16	> page C-20

Universal power supply block, connections to make between ComPacT device and Linergy BW isolated busbar

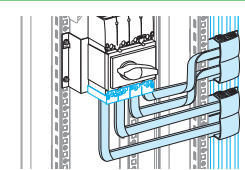
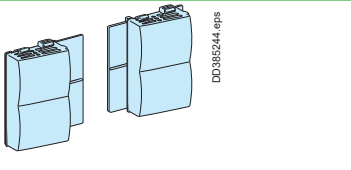
Devices ≤ 250 A

Downstream connection	Universal power supply 250 A + connection must be made	
		
Devices	ComPacT NSX100/250	
Mounting	Horizontal - Motor mechanism module	Vertical - Direct rotary handle
Catalog number	LVS04061 + connection must be made	LVS04061 + connection must be made
Configuration	> page C-7	> page C-12

Lineryg BW and devices connections
Other prefabricated connections

Prefabricated connections

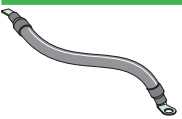
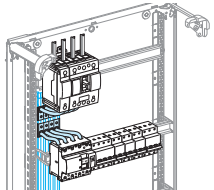
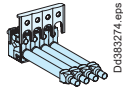
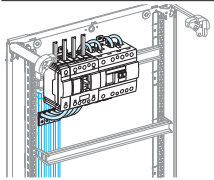
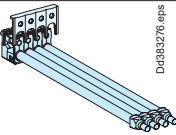
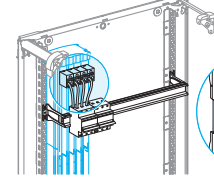
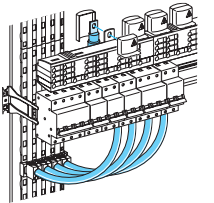
	Description	Allows connection of	Cat. no.
 DC881376-LIN.eps	Set of 4 - 125 A - L = 230 mm <ul style="list-style-type: none"> + 45° angle connector 35 mm² ferrule 	NSXm125, NG125, INS-INV with enclosed terminals cat. no. 28947 or 28948	LVS04145 (1)
	Set of 4 - 160 A - L = 250 mm <ul style="list-style-type: none"> + 45° angle connector 45 mm² ferrule 	NSXm160, INS-INV160 cat. no. 28947 or 28948	LVS04146 (1)
 DD388477.ai	One-piece connection 3/4P - 160 A, L = 165 mm <ul style="list-style-type: none"> Fast connection to Lineryg BW busbars Equipped with male fittings one end for tunnel terminals Respects the degree of protection IPxxB Neutral is clearly indicated (blue) 	 DD383274.eps NSXm, NSXm Vigi, NG125, INS-INV160, C120	LVS04147 (1)
 DD388478.ai	One-piece connection 3/4P - 160 A, L = 440 mm <ul style="list-style-type: none"> Fast connection to Lineryg BW busbars Equipped with male fittings one end for tunnel terminals Respects the degree of protection IPxxB Neutral is clearly indicated (blue) 	 DD383276.eps NSXm, NSXm Vigi, NG125, INS-INV160, C120	LVS04148 (1)
 DD388479.ai	12 tap-off blocks for 1 cable of 6 mm ² (32 A max.) and 1 of 10 mm ² (40 A max.) Respects the degree of protection IPxxB. In: 55 A max., Ui: 750 V	All types of device, equipped with tunnel terminals, Lineryg FM 160/200 A	LVS04151
	12 tap-off blocks for 1 cable of 16 mm ² (50 A max.) Respects the degree of protection IPxxB. In: 55 A max., Ui: 750 V	All types of device, equipped with tunnel terminals, Lineryg FM 63/80/160/200 A	LVS04152
 DD383472.eps	Set of 4 connections 4P - 200 A, L = from 230 to 330 mm Supplied with mounting hardware + insulated covers	Lineryg FM 200 A	LVS04021 + LVS04150

When mounting Schneider Electric prefabricated connections, short terminal shields can be used. If the function is already integrated in prefabricated connections, no need for terminal shields.

Devices/Lineryg BS multi-stage busbars connections

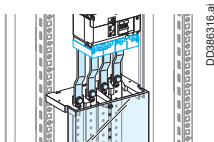
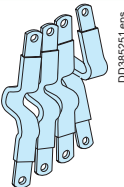
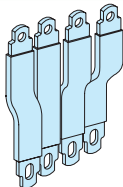
	Lineryg BS multi-stage lateral busbars, 250 A	Lineryg BS multi-stage lateral busbars, 630 A
 DD388316.ai	 DD388251.eps	 DD388253A.eps
Devices	ComPacT NSX-INS-INV 100/160/250	ComPacT NSX-INS-INV 400/630
Mounting	Vertical, in duct	Vertical, in duct
Catalog number	LVS04065	LVS04075
Configuration	> page C-6	> page C-15

Connections between two sets of Lineryg BS rear busbars

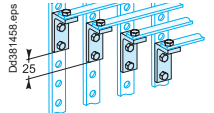
	Connection between 2 sets of Lineryg BS rear busbars
 DC881458.eps	
Devices	Set of 4 copper angle brackets - 250 A
Catalog number	LVS04190
Allows connection of	Electrical connections between two sets of rear busbars

Note: for some devices, it is recommended to use Schneider Electric prefabricated connections. If not, switchgears must be equipped with long terminal shields for personnel safety.

(1) Adaptation with references **28947** and **28948** for INS-INV 160.

Lineryg BS
and Lineryg FM busbars connections ≤ 200 A / NSXm

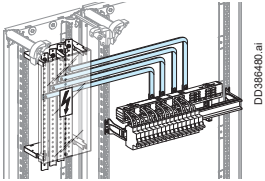
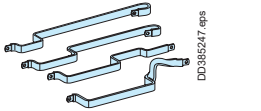
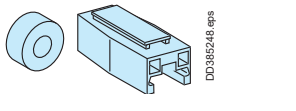
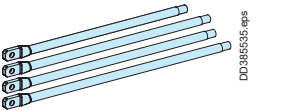
	Lineryg BS multi-stage busbars	Rear Lineryg BS busbars	Lineryg FM 160A / NSXm160
			
Devices			
Catalog number	LVS04024	LVS04029	LVS04030
Configuration	> page C-3	> page C-3	> page C-3
Allows supply of a distribution block	Lineryg FM 200 A	Lineryg FM 200 A Set of 4	Lineryg FM 160 device feeders / NSXm160 Lugs \varnothing 6 mm L1: 398 mm, L2: 418 mm, L3: 438 mm, N: 378 mm 160 A

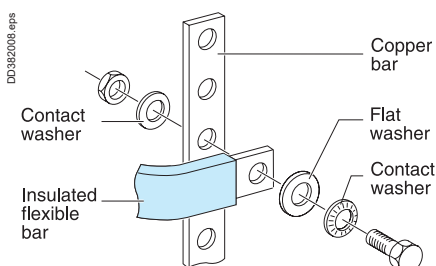

Insulated flexible bars

The insulated flexible bars are tested in a type-tested switchboard environment. Their design takes into account the switchboard architecture where they are often in close proximity to a protection device (circuit breaker or fuse) with significant heat losses. The sizes for the flexible bars indicated below take into account the heat losses of Schneider Electric devices in a PrismaSeT switchboard.

Characteristics

Length	1800 mm
Rated insulation voltage (Ui)	1000 V

Connection between device busbar

The flexible bars are determined taking into account the connected device, whatever the internal temperature of the switchboard.

The bar sizes indicated below take into account the derating curves of devices.

Devices	Size (mm)	Catalog numbers
NSX100	20 x 2	LVS04742
NSX160/250	20 x 3 ⁽¹⁾	LVS04743
NSX400	32 x 5	LVS04751
NSX630	32 x 8	LVS04753
INS-INV125/160	20 x 2	LVS04742
INS-INV250	20 x 3	LVS04743
INS-INV400	32 x 5	LVS04751
INS-INV630	32 x 6	LVS04752
Lineryg FM 200	20 x 3	LVS04743
FuPacT 250	24 x 5	LVS04746
FuPacT 400	32 x 5	LVS04751
FuPacT 630	32 x 8	LVS04753

(1) To connect a ComPacT NSX250 to Lineryg BW busbars, use a 24 x 5 mm flexible bar (LVS04746).

Connection between busbars

Flexible bars are designed for connections between busbars taking into account the following characteristics:

- a maximum temperature of 60 °C inside the switchboard. This corresponds to the average temperature inside a switchboard for an ambient temperature of 35 °C
- the maximum withstand temperature for the insulating material is 125 °C.

Ie ⁽¹⁾ max	Size (mm)	Catalog numbers
200 A	20 x 2	LVS04742
250 A	20 x 3	LVS04743
400 A	24 x 5	LVS04746
520 A	32 x 5	LVS04751
580 A	32 x 6	LVS04752
660 A	32 x 8	LVS04753

Designing connections

> page G-3

(1) Rated operational current.

Organisation of switchboard

Trunking

Type	Vertical trunking 80 x 60 mm	Horizontal trunking 60 x 30 mm	Brackets
Catalog numbers	LVS04267	LVS04257	LVS04206
Characteristics	Set of 18 L = 2000 mm	Set of 4 L = 450 mm Supplied with 8 supports	H = 15 mm For vertical trunking installation
Used with	PrismaSeT G wall-mounted and floor-standing enclosures	PrismaSeT G wall-mounted and floor-standing enclosures + Pack 160 enclosures	Pack 160 enclosures

Trunking supports

Type	Horizontal and vertical	Vertical	Horizontal
Catalog numbers	LVS04266 (1)	LVS04256	LVS04255
Characteristics	Set of 10 Vertical trunking metal support plates (80x60 mm) for wall mounted and floor standing enclosures. The support is screwed in at the same time as the modular rail. Supplied with 10 plastic screws to fix the trunking. Used to align the cover of a horizontal trunking section (H = 80 mm) with that of a vertical trunking section (H = 80 mm).	Set of 10 Aligns the cover of a horizontal trunking section (H = 80 mm) with that of a vertical trunking section (H = 80 mm)	Set of 12
Used	PrismaSeT G wall-mounted and floor standing enclosures for trunkings LVS04267 and LVS04257	PrismaSeT G wall-mounted and floor-standing enclosures	PrismaSeT G wall-mounted and floor standing enclosures for trunkings LVS04267 and LVS04257

(1) Horizontal mounting not possible with Linergy BW.



Cable trunking for doors

Type	Flexible trunking for wiring to door	Cable trunking
Catalog numbers	LVS04235	LVS04233
Characteristics	L = 500 mm, inner Ø = 19 mm	Set of 30 adhesive trunking 30 x 30 mm, L = 2000 mm

Grommets for wiring through front

Grommets	
Catalog number	LVS04234
Characteristics	Set of 10. For wiring through front.

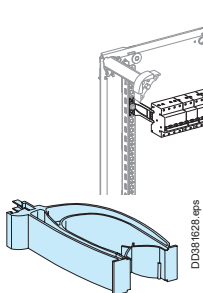
Straps and covers

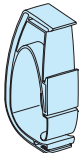
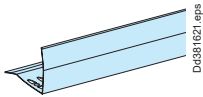
Type	Vertical cable straps	Covers for vertical cable straps	Horizontal cable straps	Covers for horizontal cable straps
				
Catalog numbers	LVS04264	LVS04263	LVS04239	LVS04243
Characteristics	Set of 12	Set of 2 x 1 m	Set of 12 Have the same capacity as 60 x 30 mm trunking	Set of 4 covers of 430 mm
Used	PrismaSeT G wall-mounted and floor-standing enclosures		PrismaSeT G wall-mounted and floor-standing enclosures + Pack enclosures	PrismaSeT G wall-mounted and floor-standing enclosures + Pack enclosures

Cable-tie supports

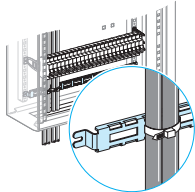
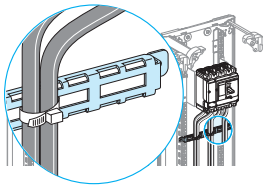
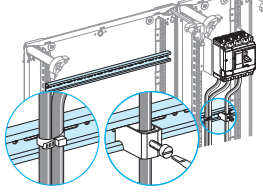
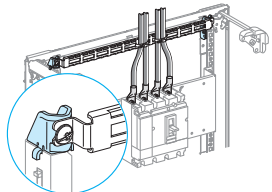
Used for	Cable-tie supports for wall-mounted or floor-standing enclosures	Cable-tie supports in a duct	C-shaped cable-tie supports for wall-mounted or floor-standing enclosures and ducts	Cable-tie support adapters
				
Catalog numbers	LVS08867	LVS08868	LVS08783	LVS08866
Characteristics	<ul style="list-style-type: none"> ■ Set of 2 ■ Supplied with hardware for mounting on the functional uprights of the enclosure. 	<ul style="list-style-type: none"> ■ Set of 4 ■ Supplied with hardware for mounting on the functional uprights of the duct. 	<ul style="list-style-type: none"> ■ W = 1600 mm, can be cut to length as needed. ■ Cables secured by ties or cable clamps. ■ Supplied with hardware for mounting on the functional uprights of the enclosure or duct. 	<ul style="list-style-type: none"> ■ Set of 2 ■ Makes it possible to tie down the cables next to the gland plate and gain one module in height. ■ Only for use in 33- and 36-module enclosures.

Note: for the connection of power cables, see [page G-8](#).

Thermal management

Ventilation

In most cases and notably for IP30 switchboards, the heat dissipation by convection takes place naturally and does not require fans.

However, when the switchboard is installed in temperate environments or when the degree of protection is high (IP54), ventilation accessories are indispensable.

For more in-depth information on selecting air-conditioning accessories and the thermal management of switchboards > [page G-26](#).

Front plate W = 600 Ventilated front plate

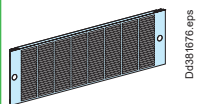

Catalog number	LVS03891	LVS03895
Height	1 module, H = 50 mm	3 modules, H = 150 mm
Characteristics	Degree of protection: IP30. Located at the top and bottom of the switchboard, IP30 ventilated front plates facilitate natural convection in the switchboard.	
Surface area of the openings	80 cm ²	250 cm ²

Front plate W = 850 Ventilated front plate

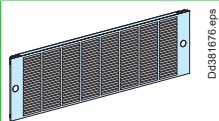

Catalog number	LVS03892	LVS03894
Height	1 module, H = 50 mm	3 modules, H = 150 mm
Characteristics	Degree of protection: IP30. Located at the top and bottom of the switchboard, IP30 ventilated front plates facilitate natural convection in the switchboard.	
Surface area of the openings	100 cm ²	350 cm ²

Forced-air ventilation 85 m³/h 165 m³/h



Catalog numbers	NSYCVF85M230PF	NSYCVF165M230PF
Free flow rate with filter (m ³ /h)	50 Hz: 85 60 Hz: 98	165 193
Flow rate with outlet grille (m ³ /h)	50 Hz: 63 60 Hz: 72	153 171
Power consumption (W) (max. current (A))	17/15 (0,121/0,097)	16,3/14,3 (0,12/0,94)
Sound level (dB (A))	46/49	50/51
External dimensions (cut-out)	170 x 150 x 62 (125 x 125) Plain front plate (≥ 4 modules) to cut out	268 x 248 x 104 (223 x 223) Plain front plate (≥ 6 modules) to cut out
Weight (kg)	0,780	1,140
Operating temp.	-20...+60 °C	-20...+60 °C
Installation	Generally installed at the bottom of floor-standing enclosures: <ul style="list-style-type: none"> ■ by cutting out a side panel, ■ on front of switchboard by cutting out a 4M (LVS03804) or 6M (LVS03806) plain front plate. 	
Characteristics	The set comprises the fan with a grill and a standard filter. <ul style="list-style-type: none"> ■ Input voltage: 230 V (50/60 Hz). ■ Degree of protection: IP54. ■ RAL 7035. ■ Material: ABS, V0 	

Outlet grille filters, set of 5, spare parts

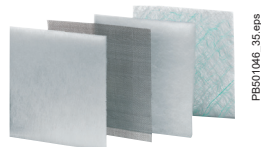

Standards filters G2 M1	NSYCAF125	NSYCAF223
Fine filters G3 M1	NSYCAF125T	NSYCAF223T

Thermal management



Heating elements

The resistors prevent condensation, corrosion and superficial leakage currents. They maintain a positive temperature in the enclosures when external temperatures drop very low.

Install heaters according to the desired power level at the bottom of the enclosure, respect a safety area of at least 10 cm around the device.

Vertical installation is recommended to ensure optimum convection.

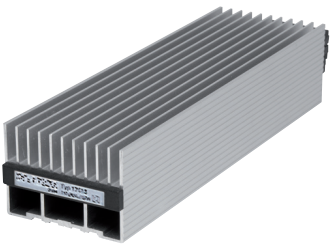
The resistance heaters are equipped with a PTC - type sensor (positive temperature coefficient). Thanks to these heaters, the surface temperature stabilises at 75 °C when the ambient is at -5 °C.

Heating resistor			
			
Catalog numbers	NSYCR55WU2	NSYCR100WU2	NSYCR250W230VV
Power rating	55 W	90 W	250 W
Characteristics	<ul style="list-style-type: none"> ■ Vertical mounting. ■ Aluminium case with fins. ■ Temperature: <ul style="list-style-type: none"> □ turns off at 60 °C, □ turns on at 25-30 °C (temperature of the resistor itself). ■ Equipped with a symmetrical rail for rapid mounting (clips on). ■ Input voltage: 110-250 V. 		<ul style="list-style-type: none"> ■ Vertical mounting. ■ Aluminium case with fins. ■ Temperature: <ul style="list-style-type: none"> □ turns off at 60 °C, □ turns on at 25-30 °C (temperature of the resistor itself). ■ Equipped with a symmetrical rail for rapid mounting (clips on). ■ Input voltage: 230 V.

Regulating

Used to control the temperature inside electrical switchboards in conjunction with heating resistors and fans.

This thermostat can control the activation of a fan and a heater and regulate their temperature independently.

Double adjustable thermostat

Double temperature control with a resistance heater and a fan with separate operation

- Red button: with normally closed contact (NC) for controlling the resistance heaters.
- Blue button: with normally open contact (NO) for controlling the fans, signalling systems or alarms.

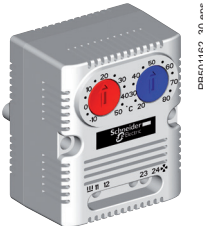
Thermostat	
	
Catalog number	NSYCCOTH
Characteristics	<ul style="list-style-type: none"> ■ Setting range: 0 °C to +60 °C. ■ Power rating: 30 W ■ Input voltage: 120 V AC: 15 A - 230 V AC: 10 A ■ Fixing: clips onto a modular rail.

Thermal management of switchboards

> page G-26

Front plates

W600 - W850 - W300

Front plates and accessories

Plain front plates

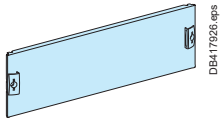
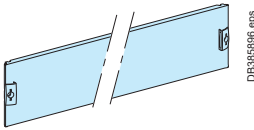
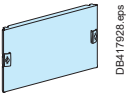
Used for		W600 Enclosure	W850 Enclosure	W300 Duct
				
Nb. of vertical modules	Height	Plain	Plain	Plain
1	50 mm	LVS03801	LVS03851	LVS03811 (2)
2	100 mm	LVS03802	-	LVS03812
3	150 mm	LVS03803	LVS03853	LVS03813
4	200 mm	LVS03804	LVS03854	LVS03814
5	250 mm	LVS03805	-	LVS03815
6	300 mm	LVS03806	LVS03856	LVS03816
9	450 mm	-	LVS03859	LVS03817
11	550 mm	-	LVS03861	-
12	600 mm	LVS03808	-	-

Transparent front plates

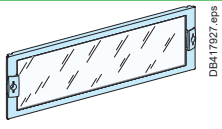
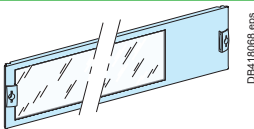
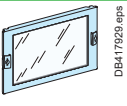
Used for		W600 Enclosure	W850 Enclosure	W300 Duct
				
Nb. of vertical modules	Height	Transparent	Transparent (1)	Transparent
4	200 mm	LVS03342	-	LVS03352
6	300 mm	LVS03343	LVS03363	LVS03353
9	450 mm	LVS03344	LVS03364	LVS03354
12	600 mm	LVS03345	-	-

Modular front plates

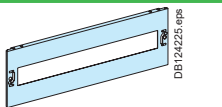
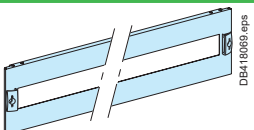
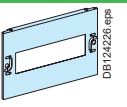
Used for		W600 Enclosure	W850 Enclosure	W300 Duct
				
Nb. of vertical modules	Height	1 row of modular devices	1 row of modular devices	1 row of modular devices
2	100 mm	LVS03202	-	-
3	150 mm	LVS03203	LVS03216	LVS03213
4	200 mm	LVS03204	LVS03217	LVS03214
5	250 mm	LVS03205	LVS03218	-

Other front plates

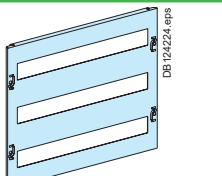
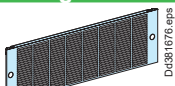
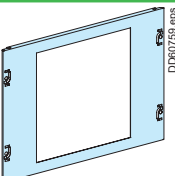
Used for		W600 wall mounted and floor standing enclosures		
				
Nb. of vertical modules	Height	3 rows of modular devices	Ventilated	With cut-out for fan or filter > page C-46
1	50 mm	-	LVS03891	-
3	150 mm	-	LVS03895	-
7	350 mm	-	-	LVS03890
8	400 mm	LVS03223	-	-

(1) 2/3 transparent front plate

(2) Mounting 1 module front plate (LVS03811) on the extreme top or bottom is not allowed



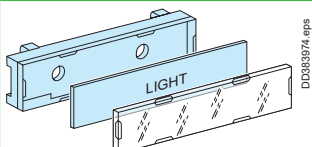
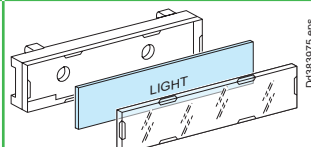

Finishing parts

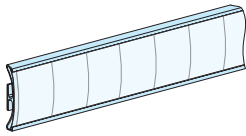
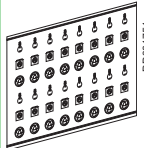
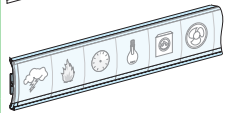
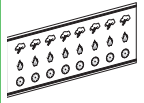
Identification labels

	Clip-on labels			Engraving plates		
						
Catalog numbers	LVS08913	LVS08915	LVS08917	LVS08914	LVS08916	LVS08918
Dimensions (mm)	18 x 35	18 x 72	25 x 85	18 x 35	18 x 72	25 x 85
Characteristics	<ul style="list-style-type: none"> ■ Set of 12 ■ The clip-on support is supplied with a paper label and a transparent cover. ■ It clips onto the front plate horizontally or vertically and can be screwed to any support (plain door, plain front plate, etc.). 			<ul style="list-style-type: none"> ■ Set of 12 ■ These plates simply replace the paper labels. 		

	Adhesive labels						Symbol sheets	
								
								
Width	W600		W850		W300			
Catalog numbers	LVS08903	LVS08904	LVS08907	LVS08908	LVS08905	LVS08906	13735	13736
Dimensions (mm)	24 x 432	36 x 432	24 x 650	36 x 650	24 x 180	36 x 180		
Characteristics	<ul style="list-style-type: none"> ■ Set of 12 ■ The adhesive label holders are supplied with a paper label and a transparent cover. 						<ul style="list-style-type: none"> ■ Set of 10 adhesive symbol sheets ■ Standard symbols: <ul style="list-style-type: none"> □ loads: sockets, lights, heating units, etc. □ rooms: bedroom, bathroom, etc. ■ Set of 10 adhesive symbol sheets ■ Special symbols: <ul style="list-style-type: none"> □ loads: lightning arrester, gate, swimming pool, etc. □ rooms: technical room, computer room, etc. 	

Adhesive labels for mimic diagrams

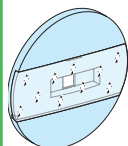
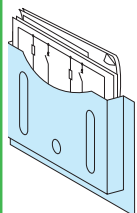
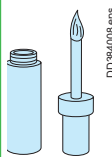

	Lines, 900 mm long (7 mm thick)	Outgoing arrows	Incoming arrows	Transformers
	 x 10	 x 10	 x 10	 x 10
Catalog numbers	LVS01005	LVS01006	LVS01007	LVS01008
Characteristics	Set of 10 Colour: black			

Accessories





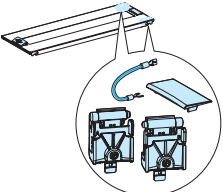

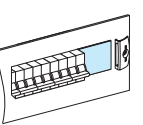
	Switchboard identification plate	Adhesive drawing holder	Touch-up paint brush
			
Catalog numbers	LVS08900	LVS08963	LVS08961
Characteristics	Colour: RAL 9003	Colour: RAL 9003	Colour: RAL 9003

Front plates and accessories

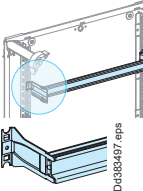
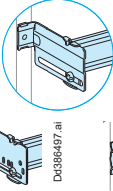
Front plates accessories

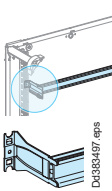
Used for	Front plate hinge kit	Self adhesive front plate grips	Blanking plates				
							
Catalog numbers	LVS08585	LVS01093	LVS03220	LVS03221	LVS03222	LVS03249	
Characteristics	Set of 2 hinges	Set of 20 white RAL9003	<ul style="list-style-type: none"> Strip H = 46 mm, L = 100 mm 	<ul style="list-style-type: none"> Divisible Set of 4 H = 46 mm, L = 90 mm 	<ul style="list-style-type: none"> H = 107 mm, L = 147 mm 	<ul style="list-style-type: none"> Strip Set of 4 H = 85 mm, L = 147 mm 	

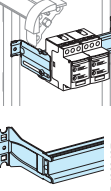
Rails

Used for	W600 Enclosure				W850 Enclosure		W300 Duct	
								
	Fixed	Adjustable	Rear	Surbaissé	Fixed	Adjustable	Fixed	Adjustable
Catalog numbers	LVS03001	LVS03002	LVS03004	LVS03003	LVS03006	LVS03007	LVS03010	LVS03011
Useful length	432 mm	432 mm	432 mm	432 mm	648	648	180 mm	180 mm
9 mm pitch number	48	48	48	48	72 pitch (36 modules)	72 pitch (36 modules)	20	20
Useful depth behind front plate	50 mm	from 47 to 114 mm	128 mm	158 mm	50	from 47 to 114 mm	50 mm	from 47 to 114 mm

Adjustable rails

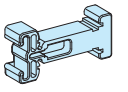
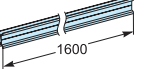
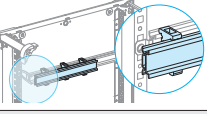
	Raiser	Rail	Rail + raiser
			
Catalog numbers	LVS04225	LVS04226	LVS04227
Characteristics	Set of 12 raisers (NSXm) Raiser height 11 mm To be completed with LVS04226 rail	Set of 2 rails, useful length: 1600 mm with 4 holes, dia. 6.4 mm, 450 mm between centres To be cut	Rail and 4 modular raisers (NG160) Useful length: 432 mm Raiser height: 33 mm

Slotted mounting plate (1)

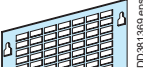
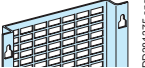
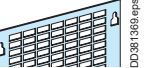
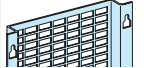
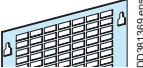
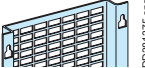
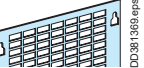
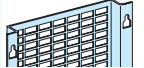
Used for	W600 Enclosure				W300 Duct			
								
	Flat	Recessed		Flat	Recessed		Flat	Recessed
Catalog numbers	LVS03170	LVS03171	LVS03172	LVS03173	LVS03175	LVS03176	LVS03177	LVS03178
Nb. of vertical modules	4	4	6	9	4	4	6	9
Height	200 mm	200 mm	300 mm	450 mm	200 mm	200 mm	300 mm	450 mm
Useful width	440 mm	420 mm			172 mm	152 mm		
Useful depth behind front plate	140 mm	160 mm			140 mm	160 mm		

Dedicated mounting plate (LVS04223)

> page C-51.

(1) For 850 width floor standing enclosure, fit a W600 mounting plate plus a W300.

Self-tapping screws

		DD381425.eps
M5	LVS03183	
Characteristics	Set of 20, mounting on functional uprights	

Universal angle bracket

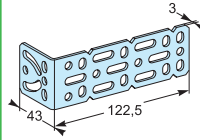
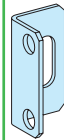
		DD381577.eps		DD383076.eps
Catalog numbers	LVS03581		LVS03583	
Characteristics	Set of 2		Set of 6	

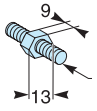
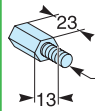
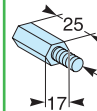
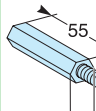
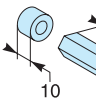

Hexagonal spacers

		DD380828.eps		DD380828.eps		DD380828.eps		DD380828.eps		DD380828.eps
M5	LVS03185		LVS03186		-		LVS03187		-	
M6	LVS03195		LVS03196		LVS03198		LVS03197		-	
M8	-		-		-		-		LVS03199	
Characteristics	Height: 9 mm Set of 4		Height: 23 mm Set of 4		Height: 25 mm Set of 4		Height: 55 mm Set of 4		Height: 40 + 10 mm Set of 4	

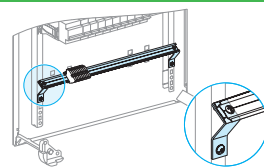
30° supports

		DD383504.eps
Catalog numbers	LVS03005	
Characteristics	Set of 2 supports (to fix a modular rail, earth bar, etc.)	

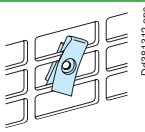
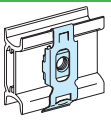
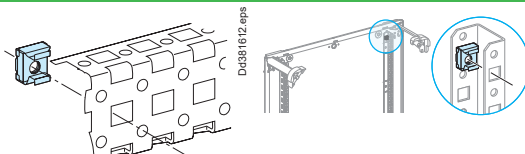
Clip-nuts

		DD381132.eps		DD381133.eps		DD381612.eps		DD386476.ai
M4	LVS03180		LVS03164		-			
M5	LVS03181		LVS03165		-			
M6	LVS03182		LVS03166		LVS03194			
Mounting on	Slotted mounting plate and also on cable-tie support (LVS08876)		Rail		Functional uprights of IP30/55 enclosures			
Characteristics	Set of 20, mounting of various devices		Set of 20		Set of 20			

Raiser for rails and slotted mounting plates

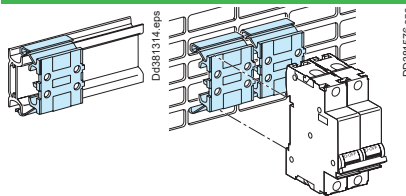
		DD381314.eps	DD381576.eps
Catalog number	LVS04224		
Characteristics	Set of 5, height: 10 mm, length 27 mm Colour: RAL 9003, insulating material		

Linergy distribution and connection systems

Contents

Distribution and connection

Panorama of the solutions	D-2
----------------------------------	------------

Power busbars up to 630 A

Linergy BW	
Insulated busbars	D-4
Linergy BS	
Rear flat busbars	D-6
Multi-stage busbars	D-7
Multi-stage distribution blocks	D-8
Common accessories	D-9

Distribution blocks

Linergy DX	
Quick distribution blocks	D-10
Linergy DP	
Quick distribution blocks - ComPacT NSX and INS-INV up to 250 A	D-12
Quick distribution blocks - ComPacT NSXm up to 160 A	D-13
Linergy DS	
Screw distribution blocks	D-14

Device feeders

Linergy FM	
Quick device feeders	D-16
Linergy FH	
Horizontal comb busbar for 27 mm pitch for NG125	D-18
Horizontal comb busbar for 18 mm pitch for Acti 9	D-19
Horizontal comb busbar for 9 mm pitch for Acti 9, C60	D-21

Terminal blocks

Linergy TB	
Earth bars	D-23
Linergy TR	
Terminal blocks	D-24

Terminal blocks and bars

Linergy TA	
Auxiliary connections	D-26

Electrical characteristics

Designing connection ≤ 630 A	D-27
---	-------------



Panorama of the solutions

Distribution and connection

Linergy and PrismaSeT G: an optimised and high-performance type-tested offer (IEC 61439-1 and 2 standard)

> For incoming devices

Linergy DX 160 A and Linergy DP upto 250 A distribution block

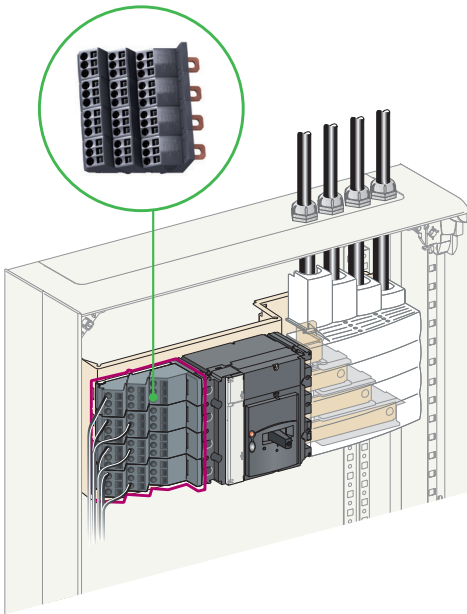

- Reliable spring-terminal connections for outgoing circuits, requiring no maintenance
- Horizontal or vertical installation in minimum space

Linergy BS 160 to 630 A distribution block

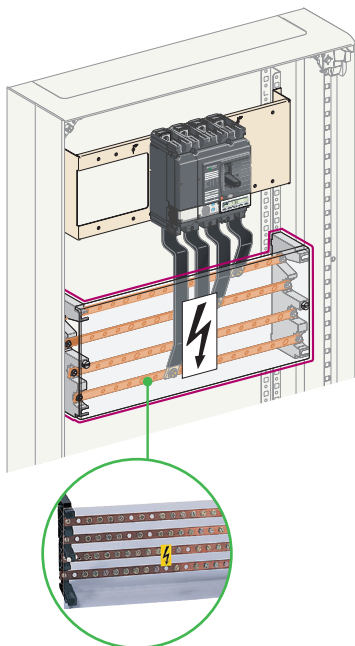

- Traditional, highly polyvalent solution
- Many installation possibilities

> For rows of modular devices

Linergy DX 125 at 160 A distribution block

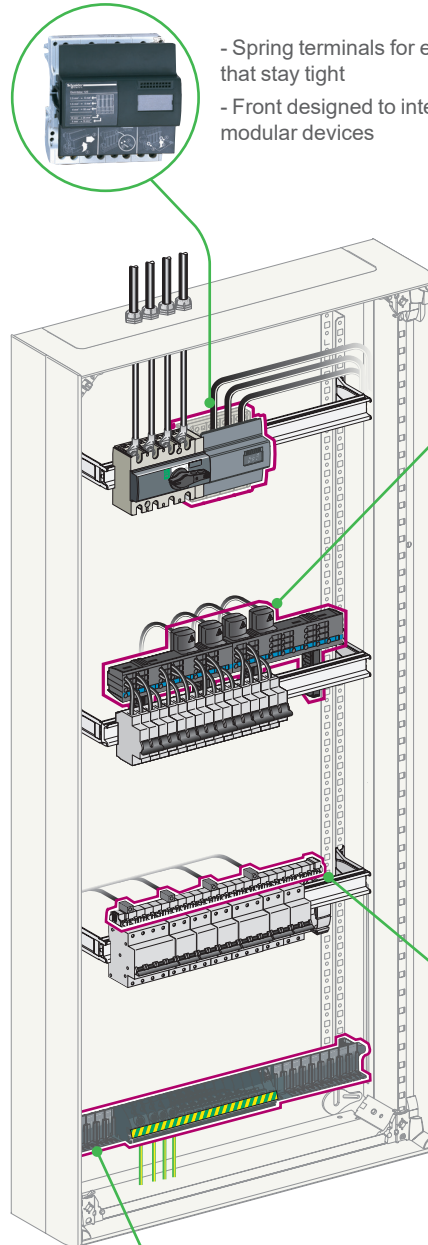

- Spring terminals for electrical connections that stay tight
- Front designed to integrate perfectly with modular devices

Linergy FM 63/200 A

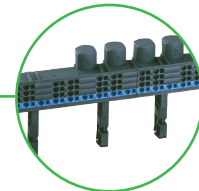

- Reliable spring-terminal connections requiring no maintenance
- Fast installation
- Easy upgrades through replacement or addition of devices
- Easy balancing of phases

Linergy FH 100 to 125 A comb busbars

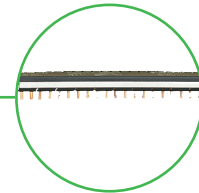

- Fast and direct connections, adaptable to all needs
- Easy, economical connections

Linergy TR

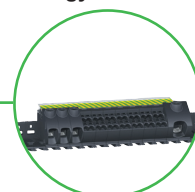

- Fast and simple installation
- Multiple connection options (screw, spring or push-in connections)

Customised organisation of your switchboard

> Busbars up to 630 A for all switchboard architectures

Lineryg BW busbars:
comPacT and insulated for fast upgrades.

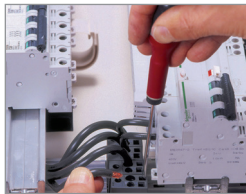

Prefabricated connections, optimised and fully insulated.

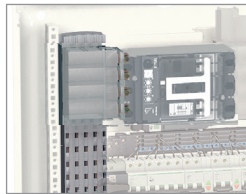

Lineryg BS busbars:
for traditional distribution.

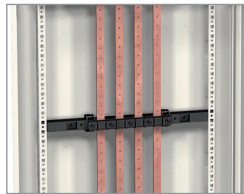

Rear Lineryg BS busbars.

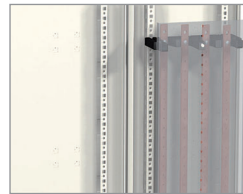

Lateral busbars. The bars are staggered for easy access to connection points.

> Row distribution blocks for modular devices

Lineryg FH comb busbars:
a simple, cost-effective solution.

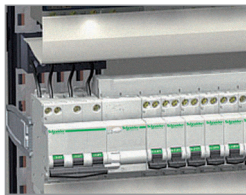

Lineryg FH comb busbars.
Lineryg FH comb busbars are fully insulated.
Device can be connected in a single operation.

Lineryg FM device feeder:
a fast, flexible and reliable solution.



Lineryg FM device feeder 80 A.
The Lineryg FM device feeder snaps easily onto the back of the rails.
All types of modular devices can be mixed in the same row and phase balancing is simple. It's easy to change or add devices.



Lineryg FM device feeder 200 A.

> Centralised distribution blocks for switchboard incomers



Lineryg DX 160 A 4P:
practical and aesthetic.
Modular monobloc distribution block for fast connections



Lineryg DX 160 A 1P:
"Quick" distribution block.
Modular combinable components for fast connections.

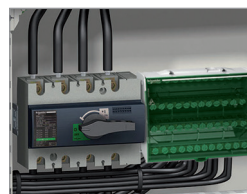

Lineryg DS 160 A:
a traditional solution.
Installation on modular rail on mounting-plate.
Screw-terminal connections.



Lineryg DP 160 A:
modular and comPacT.

Installed directly downstream of ComPacT circuit breakers and switches without taking up any extra vertical modules. Fast connections in spring-loaded terminals.



Lineryg DP 250 A:
modular and comPacT.

Linergy BW Insulated busbars

Power busbars up to 630 A

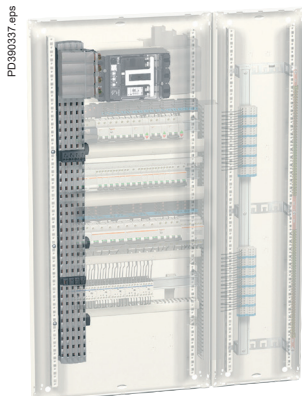

Description

- ComPacT busbar, **IPxxB**, ready for installation (supplied complete with supports and end caps)
- Shaped busbar, threaded M6 with 25-mm pitch, can be cut with 200-mm pitch (150 mm for the 125 A)
- Busbar installed on insulating supports, screwed onto the rear uprights
- Wide selection of tested pre-wired connectors
- Clip-on covers to protect against direct contact (IPxxB). Can easily be cut to allow connections to pass through to the switchgear
- Ends protected by end caps

Linergy BW (160 to 630 A) is fully compatible with seismic constraints. Just add a seismic kit (LVS04130) to Linergy BW 160/250/400.

Linergy BW busbar											
	125 A (1)		160 A		250 A		400 A		630 A		
Rated peak withstand current / 60 ms (I _{pk})	20 kA		30 kA		30 kA		52.5 kA		52.5 kA		
Rated insulation voltage (U _i)	500 V AC		750 V AC		750 V AC		750 V AC		1000 V AC		
Rated impulse withstand voltage (U _{imp})	8 kV		8 kV		8 kV		8 kV		8 kV		
Rated short-time current (I _{sc})	50 kA		150 kA		150 kA		150 kA		150 kA		
Thermal stress (I ² .t)	7.225 x 10 ⁷		1.000 x 10 ⁸		1.690 x 10 ⁸		4.000 x 10 ⁸		6.250 x 10 ⁸		
Rated short-time withstand current (I _{cw})	8.5 kA rms/1 second		10 kA rms/1 second		13 kA rms/1 second		20 kA rms/1 second		25 kA rms/1 second		
Length (mm)	450	750	1000	1400	1000	1400	1000	1400	1000	1400	
Catalog numbers	3P	LVS04103	LVS04107	LVS04111	LVS04116	LVS04112	LVS04117	LVS04113	LVS04118	LVS04114	LVS04119
	4P	LVS04104	LVS04108	LVS04121	LVS04126	LVS04122	LVS04127	LVS04123	LVS04128	LVS04124	LVS04129

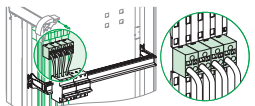
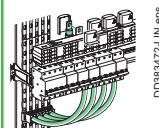
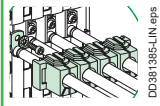
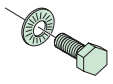
Accessories					
					
	IPxxB tap-off terminals	200 A connections	IPxxB insulating covers	Class 8.8 fixing accessories	
	12 tap-off blocks For 1 cable of 6 mm ² (32 A max.) and 1 cable of 10 mm ² (40 A max.) U _i : 750 V I _n : 55 A max. (2)	12 tap-off blocks For 1 cable of 1 to 16 mm ² U _i : 750 V I _n : 55 A max. with only 1 cable		Covers which can be clipped on and cut to size are used to isolate the connectors of a connection with cables of cross-section 10 to 25 mm ²	M6 x 12 + 20 M6 contact washers
Used for connecting	<ul style="list-style-type: none"> ■ All switchgear equipped with enclosed terminals ■ Linergy FM 160/200 A 	<ul style="list-style-type: none"> ■ All switchgear equipped with enclosed terminals ■ Linergy FM 63/80/160/200 A 	<ul style="list-style-type: none"> ■ Linergy FM 200 A 		
Set of	12	12	4	8	20
Catalog numbers	LVS04151	LVS04152	LVS04021	LVS04150	LVS04158

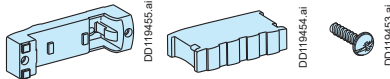
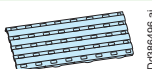
Spare parts				
				
	Linergy BW busbar supports			
Rated operational current at 40 °C (I _e)	160 A	250 A	400 A	630 A
Composition	2 busbar supports + 2 end caps + packet of fixing accessories			
Catalog numbers	LVS01210	LVS01210	LVS01210	LVS01211
				
	IPxxB clip-on covers			
Length (mm)	200			
Set of	2			
Catalog numbers	LVS01201	LVS01201	LVS01201	LVS01201

Note: Electrical characteristics. > page D-27

(1) Not compatible with seismic kit.



(2) I_{max} = 55 A for all connected cables.

Linergy BW Insulated busbars

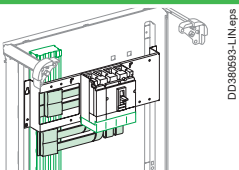
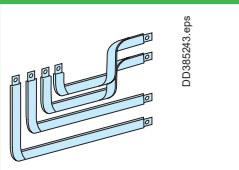
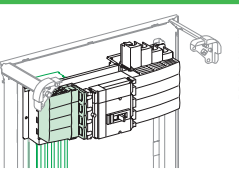
Power busbars up to 630 A

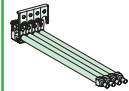
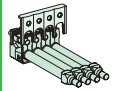
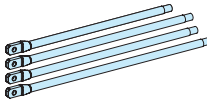
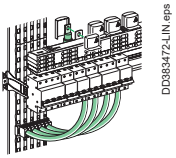
Mounting	Vertical			Horizontal					
									
	Power supply units without connections			Universal power supply units			Universal power supply units with connections		
Switchgear	Fixed <ul style="list-style-type: none"> Enclosed horizontal NSX100/250 with rotary handle or remote control Vertical FuPacT GS100/160, FuPacT ISFT100/250 	Fixed <ul style="list-style-type: none"> Enclosed NSX400/630 with or without Vigi Enclosed INS-INV320/630 	Fixed <ul style="list-style-type: none"> Enclosed NSX100/250 with toggle switch Enclosed Vertical INS-INV250 	Fixed <ul style="list-style-type: none"> In duct NSX100/250 with or without Vigi In duct Vertical INS-INV250 	Fixed <ul style="list-style-type: none"> In duct NSX400/630 with or without Vigi In duct INS-INV320/630 	Fixed <ul style="list-style-type: none"> NSX100/250 horizontal with or without Vigi INS-INV250 horizontal 	Fixed <ul style="list-style-type: none"> NSX400 horizontal INS-INV320/400 horizontal 	Fixed <ul style="list-style-type: none"> NSX630 horizontal INS-INV500/630 horizontal 	
Catalog numbers	LVS04061	LVS04074	LVS04062	LVS04064	LVS04073	LVS04060 (1)	LVS04070	LVS04071	

Pre-wired connectors						
						
	Connections		IPxxB 3/4P monobloc connection		Connections 4P	
	35 mm ² ferrule + 45° angled connector	45 mm ² ferrule + 45° angled connector	Quick connection on the busbar equipped with a male ferrule for enclosed terminals. Neutral identified by the colour blue.		Lugs Ø 6 mm	
Rated operational (Ie) current at 40 °C	125 A	160 A	160 A	160 A	160 A	200 A
Length	230 mm	250 mm	440 mm	165 mm	L1: 398 mm, L2: 410mm, L3: 438 mm, N: 378 mm	230 to 330 mm
Used for connecting	<ul style="list-style-type: none"> NSXm125, NG125, INS-INV with enclosed terminals cat. no. 28947 or 28948 	<ul style="list-style-type: none"> INS-INV160, NSXm160 	<ul style="list-style-type: none"> NSXm160, NSXm Vigi 160 (left-hand position), NG125, INS-INV160, C120 	<ul style="list-style-type: none"> NSXm160 (left-hand position), NG125, INS-INV160, C120 	<ul style="list-style-type: none"> Linergy FM 160 NSXm160 	<ul style="list-style-type: none"> Linergy FM 200 A
Set of	4	4	1	1		4
Catalog numbers	LVS04145	LVS04146	LVS04148	LVS04147	LVS04030 + LVS04150 insulated covers	LVS04021 + LVS04150 insulated covers

Seismic kit for Linergy BW 160 up to 400 A (1)	
	
Catalog numbers	LVS04130

(1) Not compatible with Linergy BW 125 A. Not requested for Linergy BW 630A which is compatible with seismic constraints.

Linery BS

Multi-stage distribution blocks

Power busbars up to 630 A

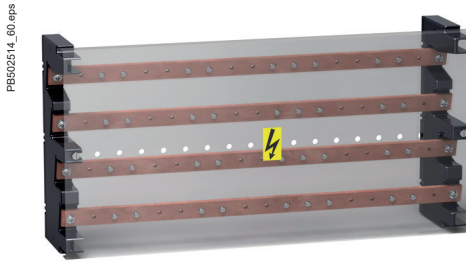

IEC 61439-1 and 2

Description

The multi-stage distribution block can be installed horizontally in the device zone or vertically in the 300 mm wide duct of enclosures and cubicles.

The distribution block is made up of:

- two staggered supports made of an insulating material
- four slanted copper bars with holes every 25 mm.

Multi-stage distribution blocks

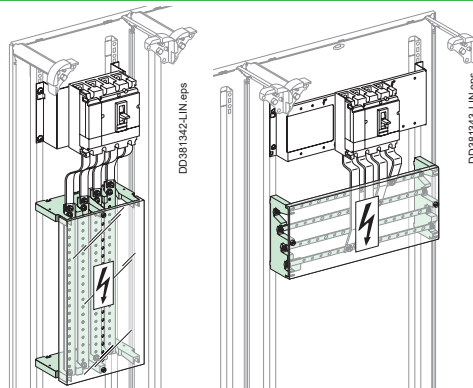

	160 A	250 A	400 A	630 A
Rated peak withstand current / 60 ms (Ipk)	30 kA	40 kA	55 kA	55 kA
Rated insulation voltage (Ui)	750 V AC			
Rated operational voltage (Ue)	440 V AC			
Rated impulse withstand voltage (Uimp)	8 kV			
Rated short-time current (Isc)	150 kA	150 kA	150 kA	150 kA
Thermal stress (I².t)	1.000 x 10⁸	1.690 x 10⁸	4.000 x 10⁸	6.250 x 10⁸
Rated short-time withstand current (Icw)	25 kA rms/1 second	25 kA rms/1 second	25 kA rms/1 second	25 kA rms/1 second
Total connection capacity	4 incomers per phase: Ø from 8 to 12 mm clearance holes 13 outgoing per phase 16 to 50 mm²: M6 tapped holes			
Busbar cross-section	15 x 5 mm	20 x 5 mm	32 x 5 mm	32 x 8 mm
Dimensions (mm)				
Installation	Screwed in horizontal position on functional uprights in enclosures and cubicles (PrismaSeT G) Screwed in vertical position on sheathed uprights (PrismaSeT G) Screwed onto a solid or pre-slotted plate (fixing centres 450 x 200 mm)			
Composition	2 multi-stage supports made of an insulating material 4 slanted copper busbars, with holes every 25 mm 1 pack of 36 M6 x 16 screws + contact washers 1 IPxxB front insulating shield			
Catalog numbers	LVS04052	LVS04053	LVS04054	LVS04055
	A		B	
LVS04052	4 x Ø 8.2		13 x M6	
LVS04053	4 x Ø 10.2		13 x M6	
LVS04054	4 x Ø 12.2		13 x M6	
LVS04055	4 x Ø 12.2		13 x M6	

Linergy BS

Common accessories

Power busbars up to 630 A

Incomer accessories

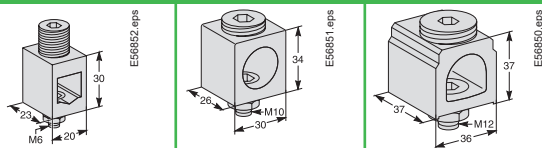

Connectors for copper or aluminium cables			
Rated operational current at 40 °C (Ie)	160 A	250 A	400 A
Supply at incoming terminals	70 mm ² Cables	16 - 185 mm ² Cables	70 - 300 mm ² Cables
Composition	Supplied with fixings at busbar end		
Set of	4		
Catalog numbers	LVS07051	LVS07052	LVS07053

Outgoer accessories

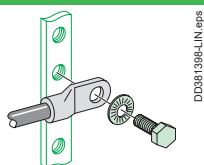

Class 8.8 fixings	
Composition	20 M6 x 20 screws + 20 nuts + 40 contact washers
	40 M6 x 16 screws + 40 contact washers
Catalog numbers	LVS04194
	LVS04195

Connections to device and Linergy FM

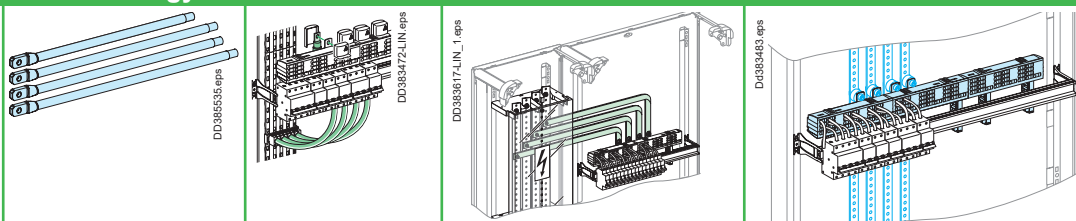

4P 160 A connection		4P 200 A connection (Supplied with mounting hardware)		4P 200 A connection (supplied with fixings)		4P 200 A connection (supplied with fixings)	
Allows supply of	Linergy FM 160 A	Linergy FM 200 A	Linergy BS busbars in duct	Rear Linergy BS busbars			
Catalog numbers	LVS04030	LVS04021	LVS04024	LVS04029			

Note: Electrical characteristics. > page D-27



Linergy DX

Quick distribution blocks

Distribution blocks

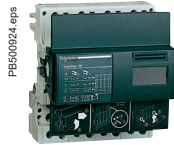

IEC 60947-7-1, IEC 61439-2

Description

- Downstream circuits are connected from the front, to spring terminals.
- Contact pressure automatically adapts to the size of the conductor.
- Contacts are insensitive to vibrations and thermal variations.
- Only one cable (flexible or rigid) can be inserted per terminal.

Quick distribution blocks

Number of poles	4P, upstream incoming	4P, downstream incoming
	PB104500-6-eps	PB104499-6-eps
Rated operational current at 40 °C (Ie)	63 A	63 A
Rated conditional short-circuit breaker of an assembly (Isc)	The reinforced breaking capacity due to cascading in circuit breaker combinations is maintained. The worst-case situations have been tested. 150 kA	
Rated peak withstand current (Ipk)	10 kA	10 kA
Rated insulation voltage (Ui)	500 V AC	500 V AC
Rated operational voltage (Ue)	440 V AC	440 V AC
Rated impulse withstand voltage (Uimp)	6 kV	6 kV
Rated short-time current Icw (Icc)	150 kA	150 kA
Thermal stress (I².t)	9,03 x 10 ⁶	9,03 x 10 ⁶
Rated operational frequency	50/60 Hz	50/60 Hz
Degree of protection	IPxxB	IPxxB
Incoming terminals	1 tunnel terminal 25 ² /Ph	1 tunnel terminal 25 ² /Ph
Total connection capacity, outgoing terminals	24 connections: 4 x 6 ² /phase 12 x 6 ² /neutral	24 connections: 4 x 6 ² /phase 12 x 6 ² /neutral
Dimensions (H x W x D)	96.5 x 72 x 62 8 x 9 mm pitch	96.5 x 72 x 62 8 x 9 mm pitch
Installation	Clipped onto a DIN rail	Clipped onto a DIN rail
Other		
Standard for installation inside PrismaSeT	IEC 61439-2	IEC 61439-2
Glow-wire 60695-2-11	960 °C	960 °C
Degree of pollution	3	3
Catalog numbers	LVS04040	LVS04041

Accessories

Catalog numbers	-	-
------------------------	---	---

Linergy DX

Quick distribution blocks

Distribution blocks

Advantages

- A reliable electrical connection, no maintenance required (tightness guaranteed over time).
- Quick connection.
- Easy phase balancing.
- Ease of rewiring if the switchboard is expanded or modified.

4P		1P	
	PB500924-75 eps		DD386251 eps
	PB111453_10 eps		
125 A	160 A	160 A	
The reinforced breaking capacity due to cascading in circuit breaker combinations is maintained. The worst-case situations have been tested.			
150 kA			
20 kA	20 kA	24 kA	
750 V AC	750 V AC	750 V AC	
690 V AC	690 V AC	690 V AC	
8 kV	8 kV	8 kV	
150 kA	150 kA	150 kA	
2.025×10^7	2.025×10^7	3.025×10^7	
50/60 Hz	50/60 Hz	50/60 Hz	
IPxxB	IPxxB	IPxxB	
1 tunnel terminal 35 ² /Ph	Supplied with a prefabricated flexible connection equipped with tunnel terminals.	1 tunnel terminal 70 ² /Ph	
52 connections: 7 x 4 ² /phase 3 x 6 ² /phase 2 x 10 ² /phase 1 x 16 ² /phase (screw terminal)	52 connections: 7 x 4 ² /phase 3 x 6 ² /phase 2 x 10 ² /phase 1 x 16 ² /phase (screw terminal)	6 connections: 6 x 16 ² /phase	
127 x 108 x 48 12 x 9 mm pitch	127 x 108 x 48 12 x 9 mm pitch	95 x 36 x 70 4 x 9 mm pitch	
Screwed to plain or slotted backplate or onto DIN rail	Screwed to plain or slotted backplate or onto DIN rail	Onto DIN rail	
Possible to combine 2 terminal blocks (2nd terminal block supplied from enclosed terminals in the 1st, I _{max} of 2nd terminal block: 80 A)			
IEC 61439-2	IEC 61439-2	IEC 61439-2	
960 °C	960 °C	960 °C	
3	3	3	
LVS04045	LVS04046 (1)	LVS04031	
4 x 125A flexible connections, L=240 mm with end fitting for tunnel terminals	-	4 x 160 A flexible connections, L = 380 mm with 2 x 45 mm ² end fittings for tunnel terminals	
LVS04047 (1)		LVS04149	

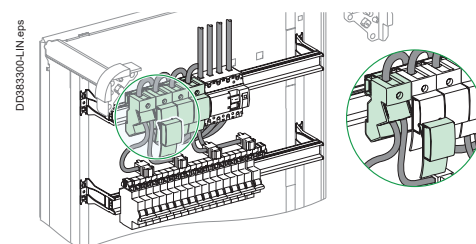
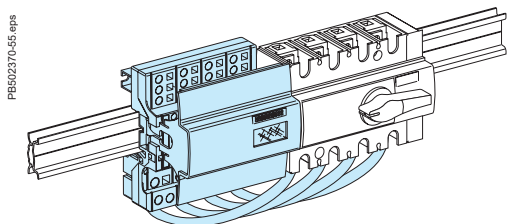

Nota: Electrical characteristics. > page D-27

(1) For INS-INV160: adaptation with references 28947 and 28948

Lineryy DP

Quick distribution blocks - ComPacT NSX and INS-INV up to 250 A

Distribution blocks

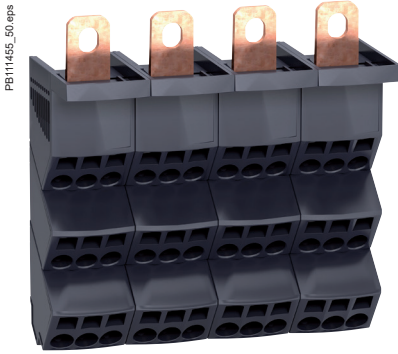



IEC 60947-7-1, IEC 61439-1 and 2

Description

The Lineryy DP quick distribution block is designed for installation directly downstream of ComPacT NSX and INS-INV up to 250 A. It can also be clipped onto a modular rail.

Avantages

- It is quick to mount in the horizontal position. Electrical connections are made directly to the device terminals.
- It is the same width as the devices and does not take up any additional space in the switchboard.
- The connection terminals are slanted to facilitate cable entry and avoid exceeding the bending radius of the flexible and rigid cables.

Quick distribution blocks for ComPacT devices		Additional block	
Number of poles	3P	4P	3P/4P
			
Rated operational current (Ie)	250 A	250 A	250 A
Rated peak withstand current (Ipk)	30 kA	30 kA	30 kA
Rated short-time current with upstream protection of 150 kA Icc (Icc)	150 kA	150 kA	150 kA
Thermal stress (I².t)	7.225 x 10⁷	7.225 x 10⁷	
Total connection capacity, outgoing terminals	27 connections: 6 x 10²/phase 3 x 16²/phase	36 connections: 6 x 10²/phase 3 x 16²/phase	2 connections: 2 x 35²/pole
Incomer terminals	1 cable lug 120 mm² per pole		
Dimensions (H x W x D)	105 x 138 x 63	140 x 138 x 64	
Installation	On mounting plate or DIN rail		On mounting plate
Product certifications	ASEFA		
Standard for installation inside PrismaSeT	IEC 61439-1-2		
Glow-wire 60695-2-11	960 °C		
Catalog numbers	LVS04033	LVS04034	LVS04155 (3P) LVS04156 (4P)

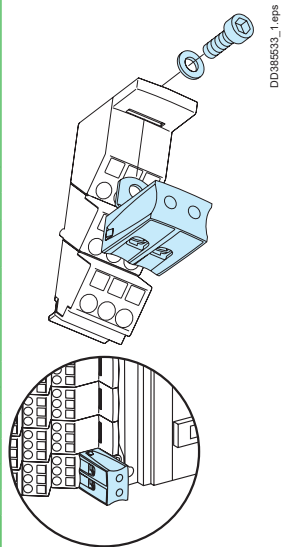

Technical Data	
Common characteristics	
Rated conditional short-circuit current of an assembly (Isc)	The reinforced breaking capacity due to cascading in circuit-breaker combinations is maintained. The worst-case situations have been tested.
Rated insulation voltage (Ui)	750 V AC
Rated operational voltage (Ue)	690 V AC
Rated impulse withstand voltage (Uimp)	8 kV
Network frequency	50/60 Hz
Degree of protection	IPxxB
Degree of pollution	3
Overvoltage category	III
Additional technical characteristics	
Reference temperature	40 °C
Operating temperature	-25 °C to 55 °C

Installation

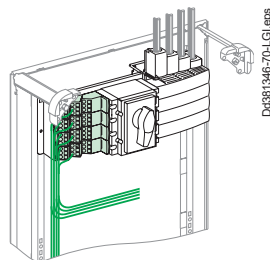

Directly on the mounting plates of horizontally mounted **ComPacT NSX100/250** and **ComPacT INS-INV250** devices in the enclosures.

For details on mounting plates, refer [pages C-3, C-5, C-7, C-9, and C-10](#).

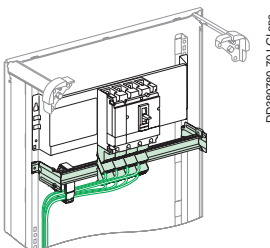

It can also be mounted downstream of vertically mounted **ComPacT NSX100/250** and **ComPacT INS-INV250** devices in the enclosures. In this case, the Lineryy DP is mounted on a depth-adjustable modular rail.

Note: Electrical characteristics > [page D-27](#)

Linergy DP

Quick distribution blocks - ComPacT NSXm up to 160 A

Distribution blocks

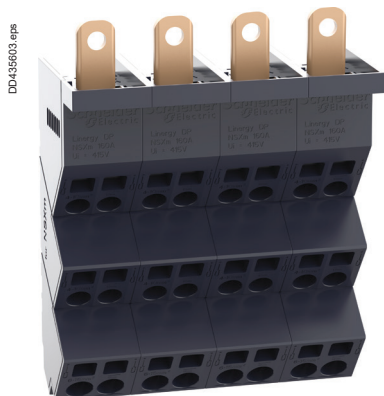

IEC 60947-7-1, IEC 61439-1 and 2



Description

■ The Linergy DP quick distribution block is designed for installation directly downstream of ComPacT NSXm up to 160 A. It can also be clipped onto a modular rail.

Avantages

- It is quick to mount in the horizontal position. Electrical connections are made directly to the device terminals.
- It is the same width as the devices and does not take up any additional space in the switchboard.
- The connection terminals are slanted to facilitate cable entry and avoid exceeding the bending radius of the flexible and rigid cables.

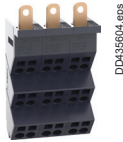
Quick distribution blocks for ComPacT devices

Number of poles	3P	4P
		
Rated operational current (Ie)	160 A	160 A
Rated peak withstand current (Ipk)	20 kA	20 kA
Rated short-time current (Icc)	70 kA	70 kA
Thermal stress (I ² .t)	4.7 x 10 ⁶ A ² S	4.7 x 10 ⁶ A ² S
Total connection capacity, outgoing terminals	18 connections: 4 x 10 ² /phase 2 x 16 ² /phase	24 connections: 4 x 10 ² /phase 2 x 16 ² /phase
Incomer terminals	1 cable lug 70 mm ² per pole	
Dimensions (H x W x D)	140 X 81 X 58 mm	140 X 108 X 58 mm
Installation	On mounting plate or DIN rail	
Product certifications	ASEFA	
Standard for installation inside PrismaSeT	IEC 61439-1-2	
Glow-wire 60695-2-11	960 °C	
Catalog numbers	LVS04038	LVS04039



Technical Data

Common characteristics		
Rated conditional short-circuit current of an assembly (Isc)		The reinforced breaking capacity due to cascading in circuit-breaker combinations is maintained. The worst-case situations have been tested.
Rated insulation voltage (Ui)		800 V AC
Rated operational voltage (Ue)		690 V AC
Rated impulse withstand voltage (Uimp)		8 kV
Network frequency		50/60 Hz
Degree of protection		IPxxB
Degree of pollution		3
Overvoltage category		III
Additional technical characteristics		
Reference temperature		40 °C
Operating temperature		-25 °C to 55 °C

Installation

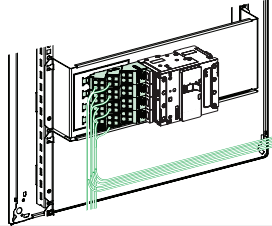

Directly on the mounting plates of horizontally mounted **ComPacT NSXm** devices in the enclosures.

For details on mounting plates, refer [page C-3](#).

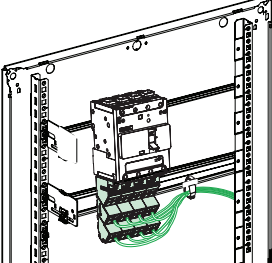

It can also be mounted downstream of vertically mounted **ComPacT NSXm** devices in the enclosures. In this case, the Linergy DP is mounted on a depth-adjustable modular rail.

Note: Electrical characteristics > [page D-27](#)

Linery DS

Screw distribution blocks

Distribution blocks



IEC/EN 60947-7-1, IEC/EN 61439-1 & 2



Description

- Single-pole or four-pole distribution block that can be installed on a standard DIN rail or on a mounting plate.
- Compatible with PrismaSeT G and P, Pragma, Mini Pragma and Resbo series switchboards.
- Incomers and feeders are connected to screw terminals that accept rigid or flexible cables with ferrule.
- Optional: additional neutral terminal strip for four-pole distribution block.

Avantages

- Simplified power supply for main incomers.
- Easy phase balancing.
- Easy, effortless cabling due to excellent accessibility.
- Visible cabling.
- Insulation between phases.
- The single-pole distribution blocks are adjacent and bridgeable via the second incoming hole for parallel connection.

Screw distribution blocks

Number of poles	1P			4P
				
Rating	125 A	160 A	250 A	100 A
Number of connections	10	13	14	4 x 7
Terminal capacity				
Diameter	2 x Ø 9.5 mm	2 x Ø 12 mm	1 x Ø 15.3 mm	2 x Ø 7.5 mm
	2 x Ø 7.5 mm	3 x Ø 7.5 mm	1 x Ø 10 mm	5 x Ø 5.5 mm
	6 x Ø 5.8 mm	8 x Ø 5.8 mm	4 x Ø 6 mm	-
	-	-	8 x Ø 7.5 mm	-
Rated peak withstand current (I _{pk})	I _{pk} /60 ms	25 kA	36 kA	60 kA
	I _{pk} /6 ms	-	-	-
Rated short-time withstand current (I _{cc}) (IEC/EN 60947-7-1)	36 kA	36 kA	36 kA	20 kA
Width (number of 9 mm pitches)	3	4	5	8
Dimension (H x W x D)	85 x 27 x 50.5	85 x 36 x 50.5	85 x 45 x 50.5	100 x 71 x 50.5
Weight (g)	125	163	239	210
Neutral terminal strip (optional)	-	-	-	LGYN1007
Catalog numbers	LGY112510	LGY116013	LGY125014	LGY410028

Linery DS

Screw distribution blocks

Distribution blocks

Technical data

Common characteristics

In compliance with IEC/EN 60947-7-1 and IEC/EN 61439-1 & 2

Rated insulation voltage (Ui)	500 V AC
Rated operational voltage (Ue)	230 V AC (Ph/N) 440 V AC(Ph/Ph)
Rated impulse withstand voltage (Uimp)	8 kV
Rated conditional short-circuit current of an assembly	Up to the breaking capacity of Schneider Electric feeder circuit breakers, even in cascading configuration
Network frequency	50/60 Hz
Pollution degree	3
Overtoltage category	III

Additional technical characteristics

Reference temperature	40 °C
Operating temperature	-25 °C to 55 °C
Dielectric withstand (IEC/EN 60947-1)	2500 V AC

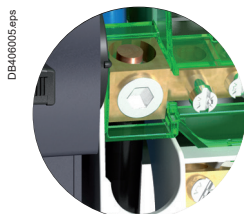

On LGY412560 and LGY416048 references.
Input cabling facilitated by side terminals.

			Neutral terminal strip		
125 A	160 A	100 A	125 A		
4 x 12	4 x 15	4 x 12	7	12	15
1 x Ø 9 mm	1 x Ø 9.5 mm	1 x Ø 12 mm	2 x Ø 7.5 mm	1 x Ø 9 mm	1 x Ø 9.5 mm
7 x Ø 7.5 mm	3 x Ø 8.5 mm	3 x Ø 9 mm	5 x Ø 5.5 mm	7 x Ø 7.5 mm	3 x Ø 8.5 mm
4 x Ø 6.5 mm	11 x Ø 6.5 mm	8 x Ø 7.5 mm	-	4 x Ø 6.5 mm	11 x Ø 6.5 mm
-	-	-	-	-	-
18 kA	18 kA	22 kA	-	-	-
26 kA	28 kA	36 kA	-	-	-
36 kA	36 kA	36 kA	-	-	-
14	20	18	7	14	17
100 x 126 x 50.5	100 x 162 x 50.5	100 x 174 x 50.5	20 x 70 x 35	20 x 125 x 35	20 x 155 x 35
390	559	567	63	111	149
LGYN12512	LGYN12515	LGYN12512	-	-	-
LGY412548	LGY412560	LGY416048	LGYN1007	LGYN12512	LGYN12515

Terminal technical data

Type	PZ2 screw							
Diameter	Ø 5.5 mm	Ø 5.8 mm	Ø 6 mm	Ø 6.5 mm	Ø 7.5 mm	Ø 8.5 mm	Ø 9 mm	Ø 9.5 mm
Section Rigid cable	1.5 to 16 mm ²	1.5 to 16 mm ²	1.5 to 16 mm ²	1.5 to 16 mm ²	2.5 to 25 mm ²	6 to 35 mm ²	10 to 35 mm ²	10 to 35 mm ²
Section Flexible cable or with ferrule	1.5 to 10 mm ²	1.5 to 10 mm ²	1.5 to 10 mm ²	1.5 to 10 mm ²	1.5 to 16 mm ²	4 to 25 mm ²	4 to 25 mm ²	6 to 35 mm ²
Tightening torque	2 N.m	2 N.m	2 N.m	2 N.m	2 N.m	2 N.m	2.5 N.m	2.5 N.m
Type	Hc screw							
Diameter	Ø 9.5 mm	Ø 10 mm	Ø 12 mm		Ø 15.3 mm			
Section Rigid cable	10 to 35 mm ²	1.5 to 50 mm ²	25 to 70 mm ²		35 to 120 mm ²			
Section Flexible cable or with ferrule	6 to 35 mm ²	1.5 to 35 mm ²	16 to 50 mm ²		25 to 95 mm ²			
Tightening torque	8 N.m	4 N.m	1P: 10 N.m	4P: 5 N.m	14 N.m			

Linery FM
Quick device feeders

Device feeders

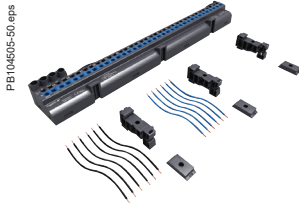



IEC60947-7-1 and IEC61439-1 and 2

Description

- Distribution over full rows of modular devices.
- The distribution block is generally supplied by busbars in enclosures and cubicles.
- Easy phase balancing.
- Mix of devices and functions in the same row.
- Installation ≥ 160 A: clipped onto the back of a modular rail or screwed onto a solid or pre-slotted plate

Distribution blocks

Number of poles		4P	4P	4P
				
		PB502496-31 _{rep}	PB 104601-52 _{rep}	PB502500-18 _{rep}
Rated peak withstand current (Ipk) 60ms		15 kA	13 kA	27 kA
Rated conditional short-circuit current of an assembly (Isc)		The cascading reinforced breaking capacity when combining circuit breakers is maintained. The worst-case scenarios have been tested. The characteristics are exactly right for the connected devices. Circuit breakers and switches still have their temperature derating curves, and their whole performance is maintained.		
Insulation voltage (Ui)		500 V AC	500 V AC	750 V AC
Rated voltage (Ue)		440 V AC	440 V AC	690 V AC
Rated impulse withstand voltage (Uimp)		6 kV	8 kV	8 kV
Maximum current (Imax)		-	-	50 A for feeder for 1 10 mm ² cable/63 A for feeder for 2 10 mm ² cables
Thermal stress (I ² .t)		9.03 x 10 ⁶	9.03 x 10 ⁶	3600 x 10 ⁷
Rated operational frequency		50/60 Hz	50/60 Hz	50/60 Hz
Degree of protection		IPxxB	IPxxB	IPxxB
Width				
9 mm modules		24	48	24
18 mm modules		12	24	12
Supply at incoming terminals		Enclosed terminals for cables up to 25 mm ²	Enclosed terminals for cables up to 25 mm ²	Direct onto the row by cable 70 mm ² with crimped lug, or flexible bar 20 x 3 from busbar with prefabricated connection
Downstream connection capacity (1)				
Phase		(6 x 4 mm ²) + (2 x 6 mm ²)	(7 x 4 mm ²) + (2 x 6 mm ²)	18 x 10 mm ²
Neutral		(4 x 4 mm ²) + (4 x 6 mm ²)	(13 x 4 mm ²) + (4 x 6 mm ²)	9 x 10 mm ²
Accessories included				
Pre-stripped copper connections		10 x 4 mm ² + 6 x 6 mm ² (W = 100 mm)	20 x 4 mm ² + 6 x 6 mm ² (W = 100 mm)	12 of 10 mm ² (W = 100 mm)
Protection cover		-	-	4
Fixing legs		2	3	2
Catalog numbers		LVS04008 (1)	LVS04004	LVS04018 (1)

Installation

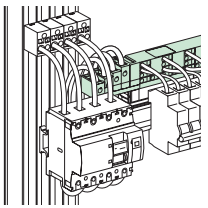
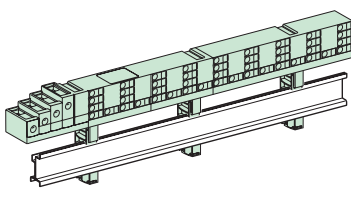
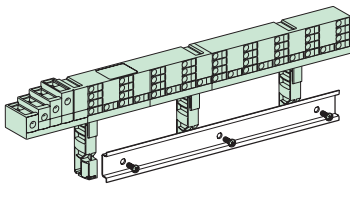
 <p>DD381664-LIN_{eps}</p> <p>Clipped onto the back of a modular rail, or screw fixing.</p>	 <p>DB124195-LIN_{eps}</p> <p>Clipped onto the back of a modular rail, or screw fixing.</p>	 <p>DB124196-LIN_{eps}</p> <p>Can be mounted in Pragma Evolution enclosures and in PrismaSeT Pack 160.</p>
--	--	---

Connections to the device feeders

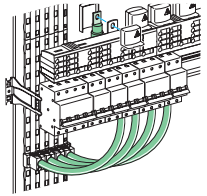
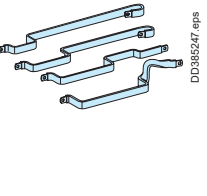
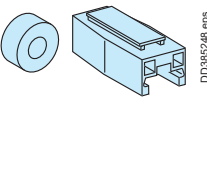
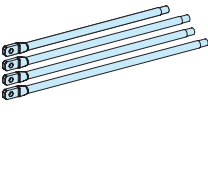
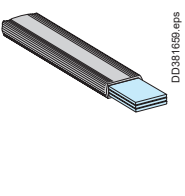



 <p>DD383472-LIN_{1 eps}</p>	 <p>DD385247_{eps}</p>	 <p>DD385248_{eps}</p>	 <p>DD385253_{eps}</p>	 <p>DD381669_{eps}</p>	
Allows power supply from	Linery BW busbar	Multi-stage Linery BS busbar	Rear Linery BS busbar	Device	Device
Catalog numbers	LVS04021 + LVS04150 <i>insulating covers</i>	LVS04024	LVS04029	LVS04030	LVS04743

Linergy FM

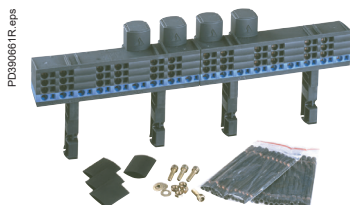
Quick device feeders

Device feeders



1P+N	3P	4P (1)	4P - L = 36 modules
			
200 A	200 A	200 A	200 A
25 kA	25 kA	30 kA	20 kA

750 V AC	750 V AC	750 V AC	750 V AC
690 V AC	690 V AC	690 V AC	690 V AC
8 kV	8 kV	8 kV	8 kV
50 A for feeder for 1 10 mm ² cable/63 A for feeder for 2 10 mm ² cables			
3600 x 10 ⁷	3600 x 10 ⁷	3600 x 10 ⁷	3600 x 10 ⁷
50/60 Hz AC	50/60 Hz AC	50/60 Hz AC	50/60 Hz AC
IPxxB	IPxxB	IPxxB	IPxxB
48	48	48	72
24	24	24	36
Direct onto the row by cable 70 mm ² with crimped lug, or flexible bar 20 x 3 from busbar with prefabricated connection			
12 x 10 mm ²	36 x 10 mm ²	36 x 10 mm ²	54 x 10 mm ²
12 x 10 mm ²	-	18 x 10 mm ²	27 x 10 mm ²
24 of 10 mm ²	24 of 10 mm ²	24 of 10 mm ²	36 of 10 mm ²
2	3	4	4
4	4	4	6
LVS04012 (1) (2)	LVS04013 (1)	LVS04014 (1) (2)	LVS04026 (1)

Spare parts



	4 covers for 160/200 A Linergy FM rows
Catalog numbers	LVS01202

Note: modular row with Linergy FM 200 A (24 or 36 modules) and 160 A (12 modules) positioned directly below a non-modular mounting plate (ComPact, etc.), or at the top of a switchboard: add 1 additional module and a plain upstream front plate.

Electrical characteristics. > page D-27

(1) Cable to be used without ferrules.

(2) The Linergy FM 200 (LVS04012 and LVS04014) can be used with direct current. The upstream and downstream terminal type (⊕ and ⊖) must be marked on the device. For more information, please contact our customer services.

Lineryg FH

Horizontal comb busbar for 27 mm pitch for NG125

Device feeders

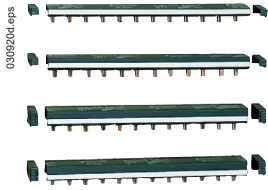

IEC 60664-1

Description

Comb busbars make it easier to install NG125 circuit breakers.

- Supplied with 2 lateral end-caps, IP 2.
- Outgoing feeders can be marked.
- Cutting markings on the copper bars and the insulating material.

NG125		27 mm poles, cuttable			
Number of poles		1P	2P	3P	4P
		Each com busbar reference includes: ■ 1 x single or 2 pole comb busbar + 8 tooth-caps + 2 side plates ■ 1 x 3 or 4 pole comb busbar + 4 tooth-caps + 2 side plates To insulate teeth that have been left free can be insulated by tooth-caps			
Rated operational current at 40 °C	(Ie)	125 A (63 A max by outgoer)			
Rated conditional short-circuit current of an assembly	(Isc)	Compatible with the breaking capacity of NG125 circuit breakers			
Insulation voltage	(Ui)	620 V AC			
Rated voltage	(Ue)	500 V AC			
Fire resistance to IEC 695-2-1		Self-extinguishing 960 °C, 30 s			
Colour		RAL 7016 (anthracite grey)			
Use					
Power supply by connector recommended					
Number of 27 mm modules		16	16	15	16
Set of		1			
Catalog numbers		14811	14812	14813	14814

Installation	
Comb busbars allow dismountability (1-2)	

Accessories	
Number of poles	1P, 2P, 3P, 4P
	Tooth covers PG 134071, eps
	Insulated connector 030621d, eps Compatible with all Schneider Electric comb busbars. Clip onto the comb busbar's insulating material, which gives them very great stability Receive clip-on markers allowing circuit identific
Use	
Set of	20
Set of	4
Catalog numbers	14818
Catalog numbers	14885
Installation	

Lineryg FH

Horizontal comb busbar for 18 mm pitch for Acti 9

Device feeders

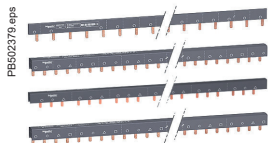

IEC 60947-7-1, IEC 61439-2

Description

Comb busbars make it easier to install Acti 9 circuit breaker.

- Can be sawn and cut in a single pass.
- Supplied with two IP20 lateral end-caps except for 57 module references.
- Cutting marks on the insulating material for easy adaptation.
- The phases are identified by symbols on each side of the comb busbar for installation in all positions.
- The special comb busbars for circuit breakers with 9 mm auxiliaries have a 9 mm gap for inserting iOF and iSD.

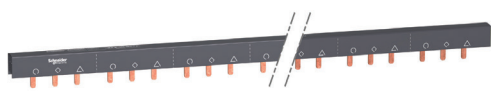

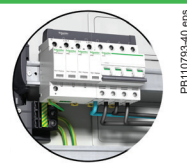
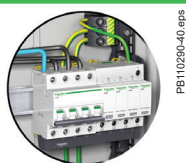

Acti 9	18 mm poles, cuttable											
	Number of poles	1P	2P	3P	4P	3 (N+P)	Aux+1P	Aux+2P	Aux+3P	Aux+4P	3 (Aux+1P)	3 (Aux+N+1P)
Rated operational current at 40 °C (Ie)	100 A											
Rated conditional short-circuit current of an assembly (Isc)	Compatible with the breaking capacity of Acti 9 circuit breakers											
Insulation voltage (Ui)	500 V AC											
Rated voltage (Ue)	415 V AC											
Fire resistance to IEC 695-2-1	Self-extinguishing 960 °C, 30 s											
Colour	RAL 7016 (anthracite grey)											
Use												
Power supply by connector recommended												
Type	L1...	L1L2...	L1L2L3...	NL1L2L3...	NL1NL2... ...NL3	AuxL1...	AuxL1L2...	AuxL1L2L3	AuxNL1... ...L2L3	AuxL1... ...AuxL2... ...AuxL3	AuxL1... ...AuxL2... ...AuxL3	
Set of	1	1	1	1	1	1	1	1	1	1	1	1
Catalog numbers												
6 modules of 18 mm	A9XPH106	-	-	-	-	-	-	-	-	-	-	-
12 modules of 18 mm	A9XPH112	A9XPH212	A9XPH312	A9XPH412	A9XPH512*	-	-	-	-	-	-	-
18 modules of 18 mm	-	-	-	-	A9XPH518*	-	-	-	-	-	-	-
24 modules of 18 mm	A9XPH124	A9XPH224	A9XPH324	A9XPH424	A9XPH524*	-	-	-	-	-	-	-
57 modules of 18 mm	A9XPH157	A9XPH257	A9XPH357	A9XPH457	A9XPH557*	A9XAH157	A9XAH257	A9XAH357	A9XAH457	A9XAH657	A9XAH557*	

* This comb busbar is only compatible in top feeding for simple lug devices and bottom feeding on double lug devices.

Installation



Accessories

Number of poles	1P	2P	3P	4P	-	-	-	
								
	Side plates				Tooth covers		Connectors	
	Lateral end-caps providing IP20 protection				To insulate teeth that have been left free		Monoconnect Double terminals Comb busbar power supply. Horizontal in comer on each side. For 35 mm ² cable. Tightening torque 4 N.m	
Set of	10	10	10	10	20	4	4	
Catalog numbers	A9XPE110	A9XPE210	A9XPE310	A9XPE410	A9XPT920	A9XPCM04	A9XPCD04	

Linery FH

Horizontal comb busbar for 18 mm pitch for Acti 9

Device feeders

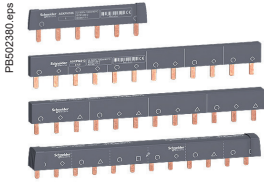

IEC 60947-7-1, IEC 61439-2

Description

- Comb busbars make it easier to install Acti 9 circuit breakers.
- The phases are identified by symbols on each side of the comb busbar for installation in all positions.

Acti 9	18 mm poles, not cuttable				
Number of poles	1P	2P	3P	4P	3 (N+P)
Rated operational current at 40 °C (Ie)	100 A				
Rated conditional short-circuit current of an assembly (Isc)	Compatible with the breaking capacity of Acti 9 circuit breaker				
Insulation voltage (Ui)	500 V AC				
Rated voltage (Ue)	415 V AC				
Fire resistance to IEC 695-2-1	Self-extinguishing 960 °C, 30 s				
Colour	RAL 7016 (anthracite grey)				
Use					
Type	Power supply by connector recommended				
Set of	L1	L1L2	L1L2L3	NL1L2L3	NL1NL2NL3
Catalog numbers	1	1	1	1	1
12 modules of 18 mm	-	A9XPM212	-	A9XPM412	A9XPM512 (1)

Installation

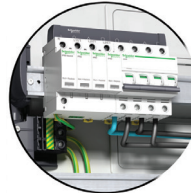
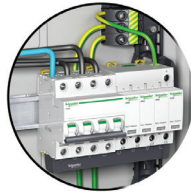

Accessories

	Tooth covers	Connectors	
	To insulate teeth that have been left free	Monoconnect	Double terminals
		Comb busbar power supply	
Use			
		Horizontal in-comer on each side For 35 mm ² cable Tightening torque 4 N.m	
Set of	20	4	4
Catalog numbers	A9XPT920	A9XPCM04	A9XPCD04
Installation			

(1) This comb busbar is only compatible in top feeding for simple lug devices and bottom feeding on double lug devices.

Linergy FH

Horizontal comb busbar for 9 mm pitch for Acti 9, C60

Device feeders

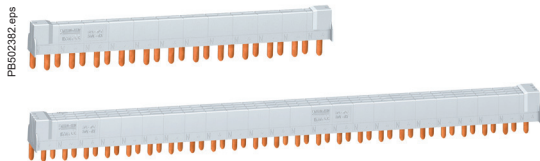



IEC 60439-1 Description

■ Easy, reliable mounting of 1P+N and 3P+N, TL, CT, ID, V, BP and Cm switchgear: tooth positioning opposite the device terminals is ensured by indexing of copper parts

C60/ID Group Feeder comb busbars contain two different parts:

■ connection of Group Feeder switchgear: C60 (3P + N) or ID (3P + N) circuit breaker in 18 mm modules, powered by cables, through the bottom, directly by the terminals

■ connection of Acti 9 switchgear in 9 mm modules.

Acti 9 Ph+N		9 mm poles, cuttable					
Number of poles		1P+N			3P+N		
							
		21501			21505		
		Complete comb busbars (supplied with 4 side plates and 1 tooth-cover)					
Rated operational current at 40 °C (Ie)		80 A					
Rated conditional short-circuit current of an assembly (Isc)		Compatible with the breaking capacity of Acti 9 and C60 circuit breakers					
Insulation voltage (Ui)		440 V AC					
Rated voltage (Ue)		230 V AC (P + N) - 400 V AC (3P + N)					
Rated impulse withstand voltage (Uimp)		6 kV					
Degree of protection		IP20					
Fire resistance to IEC 695-2-1		Self-extinguishing 960 °C, 30 s					
Colour		RAL 7035					
Number of 18 mm modules	Comb busbar	12	18	24	12	18	24
	Tooth cover	3	3	6	3	3	6
Catalog numbers		21501	19512	21503	21505	19516	21507
Comb busbars alone							
Number of 18 mm modules		48			48		
Catalog numbers		21089			21093		

C60/ID Group Feeder comb busbars alone		3P+N		
Number of poles				
Rated operational current at 40 °C (Ie)		80 A		
Rated conditional short-circuit current of an assembly (Isc)		Compatible with the breaking capacity of Schneider Electric circuit breakers		
Insulation voltage (Ui)		440 V AC		
Rated voltage (Ue)		230 V AC (P + N) - 400 V AC (3P + N)		
Rated impulse withstand voltage (Uimp)		6 kV		
Degree of protection		IP20		
Fire resistance to IEC 695-2-1		Self-extinguishing 960 °C 30 s		
Colour		RAL 7035		
Number of 18 mm modules		12	48	48
Power supply		Through left-hand	Through left-hand	Through right-hand
Catalog numbers		10545	10546	10547

Accessories				
Number of poles	1P+N	3P+N		
				
	Side plates	Tooth caps (3 x 18-mm module)	Tooth caps (1 x 18-mm module)	Connectors (grey)
Set of	40	12	10	4
Catalog numbers	21094	21095	21096	21098

Linery FH

Horizontal comb busbar for 9 mm pitch for Acti 9, C60

Device feeders

PB602383 eps

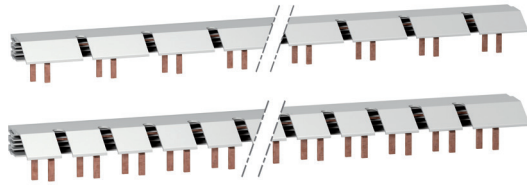

IEC 60439-1

Description

- Connection of Clario, Prodis and Libro switchgear in 9 mm modules.
- The special comb busbars for circuit breaker have a gap of 9 mm for inserting OF, SD, OF-SD/OF auxiliaries.
- The comb busbars for 3P + N circuit breakers and auxiliaries are compatible with PrismaSeT switchboard.
- 1P + N comb busbars are compatible with PrismaSeT and Pragma 24.

Acti 9				
9 mm poles, cuttable				
Number of poles	1P + N	3P + N	1P + N	3P + N
	A9N21036			
	Comb busbars		Comb busbars DPN Vigi	
Rated operational current at 40 °C (Ie)	63 A			
Rated conditional short-circuit current of an assembly (Isc)	Compatible with the breaking capacity of Acti 9 circuit breaker			
Insulation voltage (Ui)	500 V AC			
Rated voltage (Ue)	230 V AC (P + N) - 400 V AC (3P + N)			
Degree of protection	IP20			
Degree of pollution	3			
Fire resistance to IEC 695-2-1	Self-extinguishing 960 °C, 30 s			
Colour	RAL 7035			
Number of 18 mm modules	56	56	56	56
Catalog numbers	A9N21035	A9N21036	A9N21037	A9N21038

Accessories				
Number of poles	1P+N	3P+N		
	Side plates		Connectors (grey)	Neutral connectors (blue)
Set of	20		10	10
Catalog numbers	A9N21039	A9N21040	A9N21041	A9N21042
				Tooth caps (1 x 18 mm module)
				10
Catalog numbers				A9N21050

Linergy TB

Earth bars

Terminal blocks

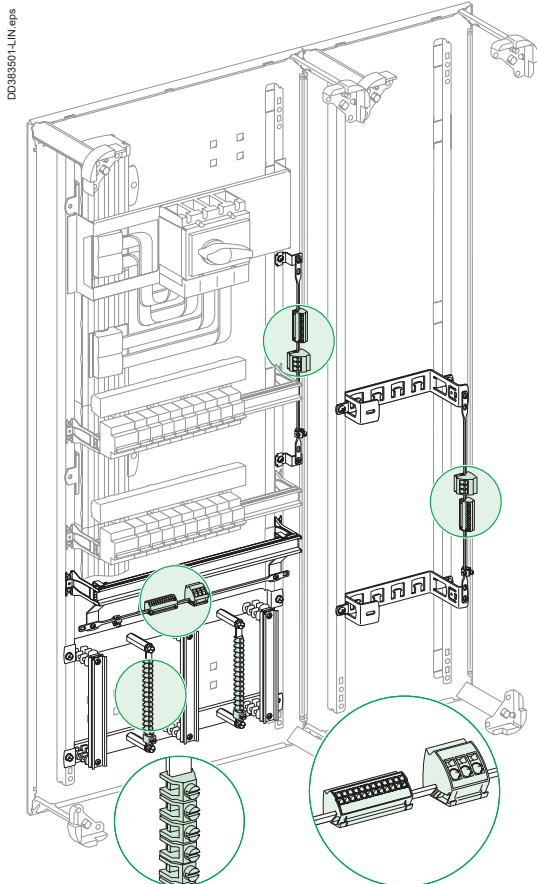

Description

This range of earth bars is installed:

- in the duct which can constitute a dedicated area, completely separate from the equipment
- or in the switchgear compartment, at the top or the bottom.

Fast-connecting earth bar

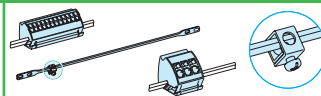

DD381560-LIN.eps

	Copper earth bar
Cross-section (mm)	12 x 3
Effective length (mm)	330
Total length (mm)	450
Composition	Copper bar with 1 terminal 16 to 35 mm ²
Catalog numbers	LVS04201

Accessories

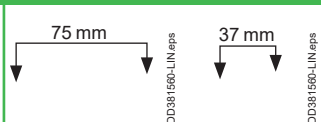

DD381560-LIN.eps

DD381560-LIN.eps

	Earth blocks with terminals	
	Spring-fixing (clip onto the earth bar)	
Total connection capacity	12 x 4 mm ²	3 x 16 mm ²
Composition	4 earth blocks	4 earth blocks
Catalog numbers	LVS04214	LVS04215

Accessories

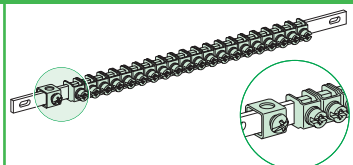

DD381516-LIN.eps

	Earth bar with jumper	
Total connection capacity	40 x 2.5 to 16 mm ²	20 x 2.5 to 16 mm ²
Cross-section (mm)	12 x 3	12 x 3
Length (mm)	450	200
Composition	40 jumpers and a terminal (16 to 35 mm ²)	20 jumpers and a terminal (16 to 35 mm ²)
Catalog numbers	LVS04200	LVS04202

Accessories

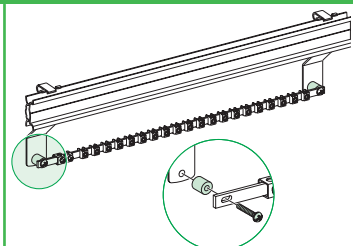

DD381519-LIN.eps

	Neutral bar
	Converts an earth bar to a neutral bar
Composition	2 insulating spacers
Catalog numbers	LVS04210



Installation accessories

> pages C-43 to C-53

Linery TR
Terminal blocks

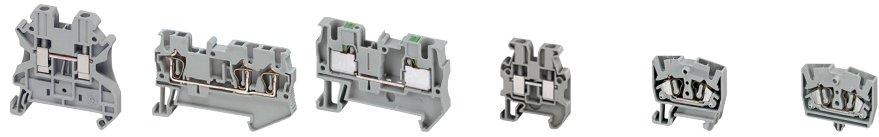
Terminal blocks



			Connection technology					
Type of terminal block	Cross section area	Color	Screw tech 	Spring tech 	Push-in tech 	Miniature screw for 15 mm DIN rail	Miniature spring for 15 mm DIN rail	Miniature spring for direct mount
Passthrough	2.5 mm ² (2 pts)	Grey	NSYTRV22	NSYTRR22	NSYTRP22	NSYTRV22M	NSYTRR22M	NSYTRR22MF
		Blue	NSYTRV22BL	NSYTRR22BL	NSYTRP22BL	NSYTRV22MBL	NSYTRR22MBL	NSYTRR22MBFL
		Orange	NSYTRV22AR	NSYTRR22AR	NSYTRP22AR	-	-	NSYTRR22MFF [*]
	2.5 mm ² (3 pts)	Grey	NSYTRV23	NSYTRR23	NSYTRP23	-	-	-
		Blue	NSYTRV23BL	NSYTRR23BL	NSYTRP23BL	-	-	-
		Orange	-	NSYTRR23AR	NSYTRP23AR	-	-	-
	2.5 mm ² (4 pts)	Grey	NSYTRV24	NSYTRR24	NSYTRP24	-	NSYTRR24M	NSYTRR24M
		Blue	NSYTRV24BL	NSYTRR24BL	NSYTRP24BL	-	NSYTRR24MBL	NSYTRR24MBL
	2.5 mm ² (4 pts, 2 levels)	Grey	NSYTRV24D	NSYTRR24D	NSYTRP24D	-	-	-
		Blue	NSYTRV24DBL	NSYTRR24DBL	NSYTRP24DBL	-	-	-
	2.5 mm ² (6 pts, 3 levels)	Grey	NSYTRV26T	NSYTRR26T	NSYTRP26T	-	-	-
		Blue	NSYTRV26TBL	NSYTRR26TBL	NSYTRP26TBL	-	-	-
	4 mm ² (2 pts)	Grey	NSYTRV42	NSYTRR42	NSYTRP42	NSYTRV42M	-	-
		Blue	NSYTRV42BL	NSYTRR42BL	NSYTRP42BL	NSYTRV42MBL	-	-
		Orange	NSYTRV42AR	NSYTRR42AR	-	-	-	-
	4 mm ² (3 pts)	Grey	NSYTRV43	NSYTRR43	NSYTRP43	-	-	-
		Blue	NSYTRV43BL	NSYTRR43BL	NSYTRP43BL	-	-	-
	4 mm ² (4 pts)	Grey	NSYTRV44	NSYTRR44	NSYTRP44	-	-	-
		Blue	NSYTRV44BL	NSYTRR44BL	NSYTRP44BL	-	-	-
	4 mm ² (4 pts, 2 levels)	Grey	NSYTRV44D	NSYTRR44D	-	-	-	-
Blue		NSYTRV44DBL	NSYTRR44DBL	-	-	-	-	
6 mm ² (2 pts)	Grey	NSYTRV62	NSYTRR62	-	-	-	-	
	Blue	NSYTRV62BL	NSYTRR62BL	-	-	-	-	
10 mm ² (2 pts)	Grey	NSYTRV102	NSYTRR102	-	-	-	-	
	Blue	NSYTRV102BL	NSYTRR102BL	-	-	-	-	
16 mm ² (2 pts)	Grey	NSYTRV162	NSYTRR162	-	-	-	-	
	Blue	NSYTRV162BL	NSYTRR162BL	-	-	-	-	
Earth protection	2.5 mm ² (2 pts)	Green/Yellow	NSYTRV22PE	NSYTRR22PE	NSYTRP22PE	NSYTRV22MPE	NSYTRR22MPE	-
	2.5 mm ² (3 pts)	Green/Yellow	NSYTRV23PE	NSYTRR23PE	NSYTRP23PE	-	-	-
	2.5 mm ² (4 pts)	Green/Yellow	NSYTRV24PE	NSYTRR24PE	NSYTRP24PE	-	-	-
	4 mm ² (2 pts)	Green/Yellow	NSYTRV42PE	NSYTRR42PE	NSYTRP42PE	NSYTRV42MPE	-	-
	4 mm ² (3 pts)	Green/Yellow	NSYTRV43PE	NSYTRR43PE	NSYTRP43PE	-	-	-
	4 mm ² (4 pts)	Green/Yellow	NSYTRV44PE	NSYTRR44PE	NSYTRP44PE	-	-	-
	6 mm ² (2 pts)	Green/Yellow	NSYTRV62PE	NSYTRR62PE	-	-	-	-
	10 mm ² (2 pts)	Green/Yellow	NSYTRV102PE	NSYTRR102PE	-	-	-	-
Knife Disconnect	2.5 mm ² (2 pts)	Grey	NSYTRV22SC	NSYTRR22SC	NSYTRP22SC	-	-	-
		Orange	NSYTRV22ST (1)	NSYTRR22SCAR	-	-	-	-
	2.5 mm ² (3 pts)	Grey	-	NSYTRR23SC	NSYTRP23SC	-	-	-
		Orange	-	NSYTRR23SCAR	-	-	-	-
	2.5 mm ² (2 levels)	Grey	NSYTRV24SCD	NSYTRR24SCD	-	-	-	-
Fuse Disconnect	4 mm ² (2 pts)	Black	NSYTRV42SF5	-	-	-	-	-
	5 x 20 mm fuse	Black (12 V)	NSYTRV42SF5LD (2)	-	-	-	-	-
		Black (230 V)	NSYTRV42SF5LA (2)	-	-	-	-	-
Basic Disconnect (3)	4 mm ² (2 pts)	Grey	NSYTRV42TB	NSYTRR42TB	NSYTRP42TB	-	-	-
Measuring transducer	6 mm ² (2 pts)	Grey	NSYTRV62TTD	-	-	-	-	-
	6 mm ² (2 pts)	Grey	NSYTRV62TT	-	-	-	-	-
	6 mm ² (2 pts)	Green/Yellow	NSYTRV62TTPE	-	-	-	-	-

* Grey terminal with flange. (1) Grey disconnect terminal with 2 test points. (2) With light indicator. (3) Fuse or component carrier not supplied.

Linery TR
Terminal blocks

Terminal blocks

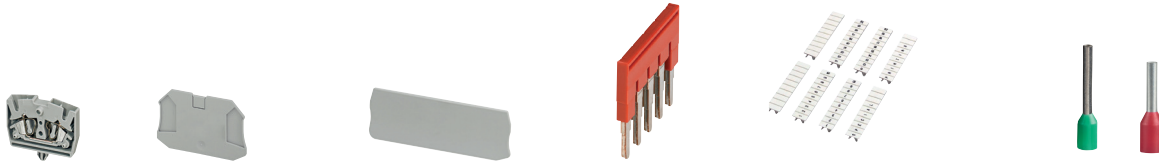

Accessories						
Miniature spring for direct mount	End plate for screw TBs	End plate for spring TBs	End plate for push-in TBs	Plug-in bridge	Marking strips 10 characters	
NSYTRR22MP	NSYTRAC22	NSYTRACR22	NSYTRACR22	NSYTRAL22	NSYTRABF510	
NSYTRR22MPBL	NSYTRAC22BL	NSYTRACR22BL	NSYTRACR22BL	NSYTRAL23	NSYTRABF520	
-	-	-	-	NSYTRAL24	NSYTRABF530	
-	NSYTRAC23	NSYTRACR23	NSYTRACR23	NSYTRAL25	NSYTRABF540	
-	-	NSYTRACR23BL	NSYTRACR23BL	NSYTRAL210	NSYTRABF550	
-	-	-	-	NSYTRAL210BL	NSYTRAB560	
NSYTRR24MP	NSYTRAC24	NSYTRACR24	NSYTRACR24	NSYTRAL210GR	NSYTRAB570	
NSYTRR24MPBL	-	NSYTRACR24BL	NSYTRACR24BL	NSYTRAL220	NSYTRAB580	
-	NSYTRACE24	NSYTRACRE24	NSYTRACRE24		NSYTRAB590	
-	-	-	-		NSYTRAB5100	
-	NSYTRACE26	NSYTRACRE26	NSYTRACPE26		NSYTRAB51100	
-	-	-	-			
-	NSYTRAC22	NSYTRACR42	NSYTRACR42	NSYTRAL42	NSYTRAB610	
-	NSYTRAC22BL	-	-	NSYTRAL43	NSYTRAB620	
-	-	-	-	NSYTRAL44	NSYTRAB630	
-	NSYTRAC23	NSYTRACR43	NSYTRACP43	NSYTRAL45	NSYTRAB640	
-	-	-	-	NSYTRAL410	...	
-	NSYTRAC24	NSYTRACR44	NSYTRACP44	NSYTRAL410BL	NSYTRAB690	
-	-	-	-	NSYTRAL410GR	NSYTRAB6100	
-	NSYTRACE24	NSYTRACRE44	-	NSYTRAL420	NSYTRAB61100	
-	-	-	-			
-	NSYTRAC22	NSYTRACR62	-	NSYTRAL62	NSYTRAB810	
-	NSYTRAC22BL	-	-	NSYTRAL65	NSYTRAB820	
-	NSYTRAC22	NSYTRACR102	-	NSYTRAL102	NSYTRAB1010	
-	NSYTRAC22BL	-	-		NSYTRAB1020	
-	NSYTRAC162	NSYTRACR162	-	NSYTRAL162	NSYTRAB1010	
-	-	-	-		NSYTRAB1020	
-	NSYTRAC22	NSYTRACR22	NSYTRACR22			
-	NSYTRAC23	NSYTRACR23	NSYTRACR23			
-	NSYTRAC24	NSYTRACR24	NSYTRACR24			
-	NSYTRAC22	NSYTRACR42	NSYTRACR42			
-	NSYTRAC23	NSYTRACR43	NSYTRACP43			
-	NSYTRAC24	NSYTRACR44	NSYTRACP44			
-	NSYTRAC22	NSYTRACR62	-			
-	NSYTRAC22	NSYTRACR102	-			
-	NSYTRAC162	NSYTRACR162	-			
-	NSYTRAC23	NSYTRACR23	NSYTRACPK22			
-	NSYTRAC23	-	-			
-	-	NSYTRACR24	NSYTRACPK23			
-	-	-	-			
-	NSYTRACED24	Included	-			
-	Included	-	-			
-	Included	-	-			
-	Included	-	-			
-	Included	Included	NSYTRACR42			
-	NSYTRACT22	-	-			
-	NSYTRACT22	-	-			
-	NSYTRACT22	-	-			

Cable ends compatible with all technologies

Wires cross section area	References
0.5 mm ²	DZ5CE005 DZ5CA005
0.75 mm ²	DZ5CE007 DZ5CA007
1 mm ²	DZ5CE010 DZ5CA010
1.5 mm ²	DZ5CE015 DZ5CA015
2.5 mm ²	DZ5CE025 DZ5CA025
4 mm ²	DZ5CE042 DZ5CA042
6 mm ²	DZ5CE062 DZ5CA062
10 mm ²	DZ5CE102 DZ5CA102
16 mm ²	DZ5CE162 DZ5CA162
25 mm ²	DZ5CE252 DZ5CA252
35 mm ²	DZ5CE352 DZ5CA352
50 mm ²	DZ5CE502 DZ5CA502

DZ5CE*** = standard insulated cable ends.
DZ5CA*** = markable insulated cable ends.



Linery TA
Auxiliary connections

Terminal blocks and bars

Connectors

For plug & play interconnection between electrical switchboard for control and communication wires.

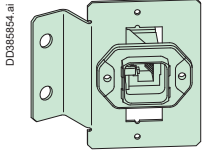

DD381644.ai

RJ45 female-female connector with mounting plate

Connector type	8 wires RJ45; 1 Gbps	
For ethernet cable	CAT5e SFTP (IEC 11801) or higher	
Degree of protection	IP67 for direct mount	
Dimensions (H x W x D)	(mm)	75 x 70 x 45
Catalog number	LGY4230	

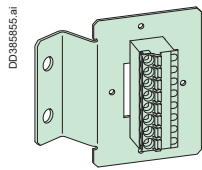

DD381644.ai

8P male-female connector with mounting plate

Rated operational current at 40 °C	(Ie)	12 A
Rated operational voltage	(Ue)	320 V
Rated impulse withstand voltage	(Uimp)	4 kV
Connection method	Push-in spring connection	
Connection capacity	Input	8
	Output	8
Dimensions (H x W x D)	(mm)	75 x 70 x 45
Wire size	0.2 to 2.5 mm ²	
Catalog number	LGY4231	

Terminal block

For distributing auxiliary voltages in power and regulation equipment.

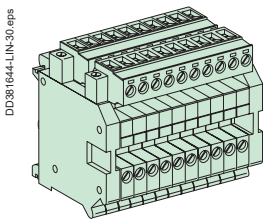

DD381644-LIN-30.eps

Terminal block for auxiliary wiring

Standards	IEC	UL
Rated operational current at 40 °C	(Ie)	12 A
Rated operational voltage	(Ue)	250 V AC
Rated impulse withstand voltage	(Uimp)	4 kV
Connection capacity	Input	10 (grey)
	Output	2 x 10 (grey)
Dimensions (H x W x D)	(mm)	61 x 48 x 45
Wire size	0.2 to 2.5 mm ²	
Tightening torque	0.5 to 0.6 N.m	
Composition	3.5 18-mm modules	
Catalog number	LVS04228	

Bus duct

Four-pole auxiliary bus duct

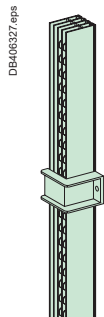

DB406327.eps

	Duct for 4 conductors	
	166 tap-off points with Faston connectors, per linear meter	
Rated operational current at 40°	(Ie)	32 A
Rated insulation voltage	(Ui)	660 V AC
Width (mm)	1755	
Composition	Supplied with 2 end clamps and 1 lateral clamp for mounting on cable-tie supports	
Catalog number	LVS04203	

USB and RJ45 ports Ø 22



XB5_653_CPSCT10026A_24.eps

ZBSP_24.ai

Description	Interface type	Connection type	Degree of protection	Reference
Panel-mounted USB and RJ45 ports in 22.5 mm hole with notch	USB interface, jack type A	USB port 3.0 A-A	IP20 IP65, IP67, IP69K with protection cover	XB5PUSB3
	Ethernet interface, RJ45 jack	RJ45 port Cat. 6	IP20 IP65, IP67, IP69K with protection cover	XB5PRJ45
	Plastic protection cover IP65/IP67	Ø 22 mm/0.866 in. USB and RJ45 ports	Black	10
	Rigid plastic protection cover IP65/IP67	Ø 22 mm/0.866 in. USB and RJ45 ports	Transparent	1
	Metal protection cover IP65/IP67/IP69K	Ø 22 mm/0.866 in. USB and RJ45 ports	Silver	1
				ZBSP1
				ZBSP2
				ZBSP3

Designing connection ≤ 630 A

Electrical characteristics

Device	Ambient temperature around the switchboard											
	25°C		30°C		35°C		40°C		45°C		50°C	
	IP ≤ 31	IP > 31	IP ≤ 31	IP > 31	IP ≤ 31	IP > 31	IP ≤ 31	IP > 31	IP ≤ 31	IP > 31	IP ≤ 31	IP > 31
Rated current of a circuit I _{nc} (A)												
Linery BW												
Insulated bus bar Linery BW 125 A	134	125	129	120	125	116	120	111	116	106	111	■
Insulated bus bar Linery BW 160 A	171	160	166	154	160	148	154	142	148	135	142	■
Insulated bus bar Linery BW 250 A	267	250	259	241	250	231	241	222	231	211	222	■
Insulated bus bar Linery BW 400 A	428	400	414	385	400	370	385	355	370	338	355	■
Insulated bus bar Linery BW 630 A	673	630	652	607	630	583	607	558	583	532	558	■
Linery BS												
Rear flat busbars 160 A	171	160	166	154	160	148	154	142	148	135	142	■
Rear flat busbars 250 A	267	250	259	241	250	231	241	222	231	211	222	■
Rear flat busbars 400 A	428	400	414	385	400	370	385	355	370	338	355	■
Rear flat busbars 630 A	673	630	652	607	630	583	607	558	583	532	558	■
Linery BS												
Multi-stage busbars 160 A	171	160	166	154	160	148	154	142	148	135	142	■
Multi-stage busbars 250 A	267	250	259	241	250	231	241	222	231	211	222	■
Multi-stage busbars block 400 A	428	400	414	385	400	370	385	355	370	338	355	■
Multi-stage busbars block 630 A	673	630	652	607	630	583	607	558	583	532	558	■
Linery BS												
Multi-stage distribution block 160 A	171	160	166	154	160	148	154	142	148	135	142	■
Multi-stage distribution block 250 A	267	250	259	241	250	231	241	222	231	211	222	■
Multi-stage distribution block 400 A	428	400	414	385	400	370	385	355	370	338	355	■
Multi-stage distribution block 630 A	673	630	652	607	630	583	607	558	583	532	558	■
Linery DX												
Quick distribution block Linery DX 4P 125 A	134	125	129	120	125	116	120	111	116	106	111	■
Quick distribution block Linery DX 4P 160 A	171	160	166	154	160	148	154	142	148	135	142	■
Quick distribution block Linery DX 1P 1P 160 A	171	160	166	154	160	148	154	142	148	135	142	■
Linery DP												
Quick distribution block Linery DP 3P-4P 160 A	160	160	155	155	150	150	145	145	140	140	135	■
Quick distribution block Linery DP 3P-4P 250 A	267	250	259	241	250	231	241	222	231	211	222	■
Linery FM												
Quick device feeders Linery FM 4P 63 A	67	63	65	61	63	58	61	56	58	53	56	■
Quick device feeders Linery FM 4P 80 A	86	80	83	77	80	74	77	71	74	68	71	■
Quick device feeders Linery FM 4P 160 A	171	160	166	154	160	148	154	142	148	135	142	■
Quick device feeders Linery FM 2P 200 A	214	200	207	193	200	185	193	177	185	169	177	■
Quick device feeders Linery FM 3P 200 A	214	200	207	193	200	185	193	177	185	169	177	■
Quick device feeders Linery FM 4P 200 A	214	200	207	193	200	185	193	177	185	169	177	■
Quick device feeders Linery FM 4P 200 A (36 modules)	214	200	207	193	200	185	193	177	185	169	177	■

■ Check the concordance between Linery derating value and upstream protection device derating value.



IP30/IP4X

IP55 enclosures

Contents

PrismaSeT G IP30, IP4X

Presentation	E-3
Wall-mounted and floor-standing enclosures	E-6
Accessories	E-7
Combination kits	E-9
Lifting accessories - Installation	E-10
Accessories	E-11
Gland plates	E-12
Door accessories	E-13
Spare parts	E-14
Dimensions	E-17

PrismaSeT G IP55

Presentation	E-20
Weatherproof enclosures	E-23
Combination kits	E-24
Mounting accessories	E-25
Grand plates	E-26
Partial doors and functional units for partial door	E-27
Side panels	E-28
Door accessories	E-29
Spare-parts	E-30
Dimensions	E-31



Presentation

For safe and upgradeable electrical switchboards



E

> 100 % reliable and in compliance with existing standards

All the components (switchgear, splitter blocks, prefabricated connections, etc.) have been designed to work together. All switchboard configurations have been tested.

> Optimised, upgradeable installation

With PrismaSeT G, you can build the right switchboard for your customer, sized precisely to fit costs and needs.

Thanks to the organisation around functional units, the installation evolves simply while preserving its original performance.

> Ease of setup

The complete accessibility of all mounting and connection points facilitates assembly and cabling in the workshop. The functional units are clearly identified: operations are intuitive and reliable, and connection and checking are performed naturally.



- > Safety of people and property
- > Continuity of service
- > Optimisation and upgradeability
- > Ergonomics and complete accessibility
- > Controlled costs (installation, maintenance) and delivery times
- > Seismic characteristics: 2,5G without accessory

Presentation

Up to 630 A

Metallic indoor enclosures to compose.
Commercial buildings: hotels, offices, shops, etc.
Industry: technical room, etc.

Enclosure delivered flat in kit form:
total accessibility
Designed for electrical continuity

- 630 A
- IP30/IP4X
- IK07/08/10
- Seismic characteristics: 2,5G



Description

Steel sheet metal with electrophoresis treatment + hot-polymerised polyester epoxy powder.

Enclosure:

- width: 595 mm, 850 and 305 mm
- height: 385 to 2030mm
- depth: 205 mm without door / 259 mm with door (including the handle : 13.5 mm)
- properties of metal enclosures > page G-15.

Main characteristics

PrismaSeT G IP30 - IP4X enclosures

Rated operational current	$I_n = 630 \text{ A} - I_{sc} = 50 \text{ kA}, I_{cw} = 25 \text{ kA rms} / 1 \text{ s}, I_{pk} = 53 \text{ kA}$
Colour	White colour RAL 9003
Standards conformity	EN 62208, IEC 61439-2
Degree of protection	IP30 without door, IP40 with door IP41 with canopy + door, IP43 with canopy + door + gasket
Degree of protection against mechanical impacts	IK07 without door IK08 with door (transparent) IK10 with plain door
Seismic characteristics	2,5G without accessory (IEC 60068-2-57)
Isolation	Class 1
Doors	<ul style="list-style-type: none"> ■ Plain or transparent, opening to right or left, 130° ■ Earthed by design ■ Supplied with a handle and keylock (key 405) ■ Distance behind door = 58 mm (possibility of push-buttons, lamps installation). ■ 2 closing points on 15- to 24-module doors ■ 3 closing points on 27-, 30-, 33- and 36-module doors.
Mounting	Surface mounting, floor-standing, flush mounting via a kit > page E-11

PB115630_39.jpg



Easy design with
Rapsody software
> page B-29

Presentation

Up to 630 A

3 widths available:
300/600/850

Lengthened rear upright to facilitate the fitting of accessories (cables tying) and installation of earth, neutral terminals, etc....

New removable gland plate for quick on-site connection of incoming cables.

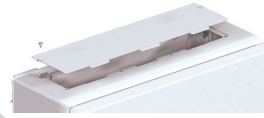

Hooks for quick plate pre-mounting

Plates for connecting control, command and communication circuits

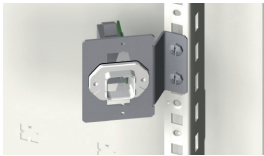

Ergonomic handle



Trunking support plate, fixed at the same time as the modular rail

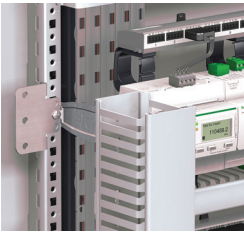

New pillar with natural positioning



Combination: old and new versions fully compatible

without door: IP30
with door: IP40
plain door: IK10
transparent door: IK08

Assembly of 2 enclosures facilitated by creating extension enclosures, including all necessary assembly parts

Vertical combination of 2 enclosures: simplified by creating a dedicated horizontal combination strip

15M to 24M doors with 2 closing points

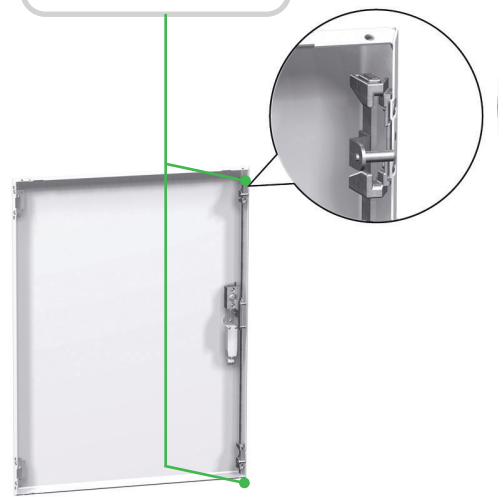
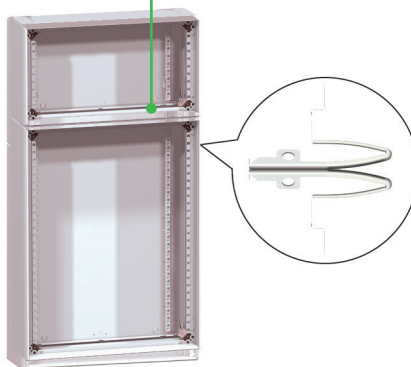
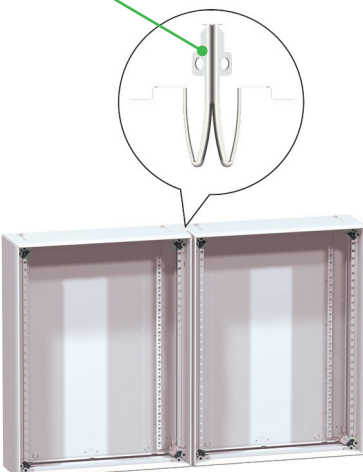

Wall-mounted and floor-standing enclosures

Up to 630 A

IP30, 630 A wall-mounted and floor-standing enclosures

Reversible doors (opening 130° to left or right), supplied equipped with a handle and keylock (key 405).

Equipped with a door the IP30 enclosure reaches IP4X.

- To create switchboard combinations (horizontal combination of enclosures of the same height), use a basic enclosure plus enclosure extensions, or W300 ducts.
- Enclosure extensions are supplied with a combination kit.
- In case of floor-standing enclosure combination, cables can be run on the sides of the plinth (diameter ≤ 140 mm).

Wall-mounted enclosures W600		Extensions W600		Doors W600		Ducts W300	Doors W300	
Nb. of vertical modules of 50 mm	Height in mm	Enclosure	Rear + top and bottom plates + combination upright	Plain door	Transparent door	Rear + top and bottom plates + combination upright	Plain door	Transparent door
6	330	LVS08102	-	LVS08122	LVS08132	LVS08172	LVS08182	-
9	480	LVS08103	LVS08113	LVS08123	LVS08133	LVS08173	LVS08183	-
12	630	LVS08104	LVS08114	LVS08124	LVS08134	LVS08174	LVS08184	-
15	780	LVS08105	LVS08115	LVS08125	LVS08135	LVS08175	LVS08185	-
18	930	LVS08106	LVS08116	LVS08126	LVS08136	LVS08176	LVS08186	-
21	1080	LVS08107	LVS08117	LVS08127	LVS08137	LVS08177	LVS08187	LVS08197
24	1230	LVS08108	LVS08118	LVS08128	LVS08138	LVS08178	LVS08188	LVS08198
27	1380	LVS08109	LVS08119	LVS08222	LVS08232	LVS08179	LVS08282	LVS08292

Floor-standing enclosures W600		Extensions W600		Doors W600		Ducts W300	Doors W300	
Nb. of vertical modules of 50 mm	Height in mm	Basic enclosure	Rear + top plates + combination upright + plinth	Plain door	Transparent door	Rear + top plates + combination upright + plinth	Plain door	Transparent door
27	1580	LVS08202	LVS08212	LVS08222	LVS08232	LVS08272	LVS08282	LVS08292
30	1730	LVS08203	LVS08213	LVS08223	LVS08233	LVS08273	LVS08283	LVS08293
33	1880	LVS08204	LVS08214	LVS08224	LVS08234	LVS08274	LVS08284	LVS08294
36	2030	-	LVS08215	LVS08225	LVS08235	LVS08275	LVS08285	LVS08295

Floor-standing enclosures W850		Doors W850		Ducts W300	Doors W300		
Nb. of vertical modules of 50 mm	Height in mm	Basic enclosure	Plain door	Transparent door	Rear + top plate + combination upright + plinth	Plain door	Transparent door
27	1580	LVS08242	LVS08252	LVS08262	LVS08272	LVS08282	LVS08292
30	1730	LVS08243	LVS08253	LVS08263	LVS08273	LVS08283	LVS08293
33	1880	LVS08244	LVS08254	LVS08264	LVS08274	LVS08284	LVS08294
36	2030	LVS08245	LVS08255	LVS08265	LVS08275	LVS08285	LVS08295

Switchgear on the door > [page E-11](#)

Spare parts > [page E-14](#)

Partitionning > [page C-41](#)





Wall-mounted and floor-standing enclosures

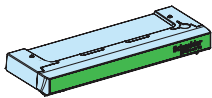

Accessories

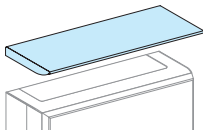
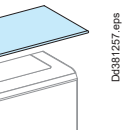
Up to 630 A

Accessory for Wireless communication - For Wall Mounted G IP30/4x		
		
Assembly	By replacing the standard roof top	
Description	W300 Basic Green roof IP30 for extensions	W600 Basic Green roof IP30 for extensions
Commercial References	LVS08886	LVS08893

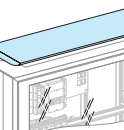
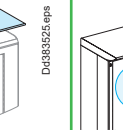
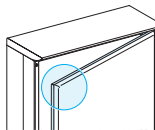
Accessories to increase the IP value

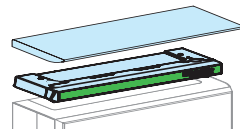
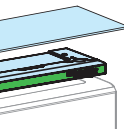
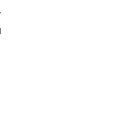
Accessories to increase the IP value from IP30 to IP41							Gasket for the door to increase the IP value from IP41 to IP43								
															
Used with	1 enclosure W = 600	1 enclosure + 1 duct W600 + 300 (1)	2 enclosures W600 + 600	1 enclosure + 2 ducts W600 + 300 + 300 (2)	2 enclosures + 1 duct W600 + 600 + 300 (1)	1 floor-standing enclosure W = 850	1 floor-standing enclosure + 1 duct W850 + 300 (1)	Enclosures or duct from 6 to 36 modules							
Catalog numbers	LVS08830	LVS08832	LVS08831	LVS08827	LVS08833	LVS08836	LVS08837	LVS08841 (3)							
Total length	600	900	1200	1200	1500	850	1150	5300							
Designation	The addition of a canopy over a wall-mounted or floor-standing enclosure equipped with a door ensures compliance with the degree of protection IP41. When the switchboard is equipped with a canopy, a gasket for the doors ensures compliance with the degree of protection IP43.														

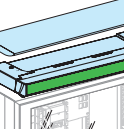
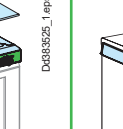
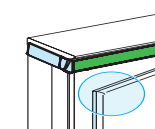
Accessories to increase the IP value from IP30 to IP41							Gasket for the door to increase the IP value from IP41 to IP43								
															
Used with	1 enclosure W = 600	1 enclosure + 1 duct W600 + 300 (1)	2 enclosures W600 + 600	1 enclosure + 2 ducts W600 + 300 + 300 (2)	2 enclosures + 1 duct W600 + 600 + 300 (1)	1 floor-standing enclosure W = 850	1 floor-standing enclosure + 1 duct W850 + 300 (1)	Enclosures or duct from 6 to 36 modules							
Catalog numbers	LVS08842	LVS08843	LVS08844	LVS08845	LVS08846	LVS08847	LVS08848	LVS08841 (3)							
Total length	600	900	1200	1200	1500	850	1150	5300							
Designation	The addition of a canopy over a wall-mounted or floor-standing enclosure equipped with a door ensures compliance with the degree of protection IP41. When the switchboard is equipped with a canopy, a gasket for the doors ensures compliance with the degree of protection IP43.														

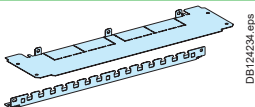
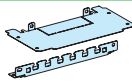
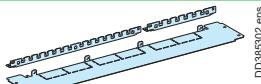
Metal gland plates for plinth						
						
Used with	Floor-standing enclosure W600		Duct W300		Floor-standing enclosure W850	
Catalog numbers	LVS08887		LVS08888		LVS08889 (4)	
Designation	Between the plinth and the bottom of a floor-standing enclosure or duct, for ensuring IP20.					

Spare parts > page E-14 Dimensions > page E-17

(1) Whatever the duct position. (2) Ducts on the sides. (3) x2 for width 850 mm. (4) Not compatible with 36-module height.

Wall-mounted and floor-standing enclosures

Accessories

Up to 630 A

Accessories to increase the IP value

Wall-mounted enclosures W300						Floor-standing enclosures W300					
Nb. of vertical modules of 50 mm	Height in mm	Rear + top plate + plinth	Side panels	Plain door	Transparent door	Nb. of vertical modules of 50 mm	Height in mm	Rear + top plate + plinth	Side panels	Plain door	Transparent door
6	330	LVS08172	2 x LVS01040	LVS08182	-	-	-	-	-	-	-
9	480	LVS08173	2 x LVS01041	LVS08183	-	-	-	-	-	-	-
12	630	LVS08174	2 x LVS01042	LVS08184	-	-	-	-	-	-	-
15	780	LVS08175	2 x LVS01043	LVS08185	-	-	-	-	-	-	-
18	930	LVS08176	2 x LVS01044	LVS08186	-	-	-	-	-	-	-
21	1080	LVS08177	2 x LVS01045	LVS08187	LVS08197	-	-	-	-	-	-
24	1230	LVS08178	2 x LVS01046	LVS08188	LVS08198	-	-	-	-	-	-
27	1380	LVS08179	2 x LVS01035	LVS08282	LVS08292	27	1580	LVS08272	2 x LVS01035	LVS08282	LVS08292
-	-	-	-	-	-	30	1730	LVS08273	2 x LVS01034	LVS08283	LVS08293
-	-	-	-	-	-	33	1880	LVS08274	2 x LVS01033	LVS08284	LVS08294
-	-	-	-	-	-	36	2030	LVS08275	2 x LVS01047	LVS08285	LVS08295

Spare parts > page E-14

Dimensions > page E-17

(1) Whatever the duct position.

(2) Ducts on the sides.

(3) x2 for width 850 mm.

(4) Not compatible with W850 width and 36-module height.

Wall-mounted and floor-standing enclosures

Combination kits

Up to 630 A

Combinations

To make the combination more rigid, particularly during transport, it is mandatory to use a set of cross-members secured to the rear of the switchboard.

A combination kit is delivered with each duct and each enclosure extension.

It is sometime necessary to use a combination kit (Catalog number LVS08816) in addition to those already delivered.

Combination kits	Horizontal					
Possible combinations						
For enclosure W600/W300	1 wall-mounted enclos. + 1 duct	1 wall-mounted enclos. + 2 ducts	1 wall-mounted enclos. + 1 enclos. extension	1 wall-mounted enclos. + 1 duct + 1 enclos. extension	1 wall-mounted enclos. + 2 ducts + 1 enclos. extension	1 wall-mounted enclos. + 3 ducts + 1 enclos. extension
Lifting/reinforcement cross-members width	900	1200	1200	1500	1800	2100
Set of two lifting/reinforcement cross-members	LVS08812	LVS08811	LVS08811	LVS08813	LVS08814	LVS08826
For floor-standing enclosure W850/W300	1 fl. standing enclos. + 1 duct	1 fl. standing enclos. + 2 ducts				
Lifting/reinforcement cross-members width	1150	must be made	-	-	-	-
Set of two lifting/reinforcement cross-members or vertical uprights	LVS08809	-	-	-	-	-

Combination kits	Vertical	Multiple						
Possible combinations								
For enclosure W600	2 wall-mounted enclos.	2 enclos. + 2 ducts	2 enclos. + 2 enclos. extension	2 enclos. + 2 enclos. extension + 2 ducts	2 enclos. + 2 enclos. extension + 4 ducts	2 enclos. + 2 enclos. extension + 6 ducts	2 additional ducts	2 additional enclosures
Lifting/reinforcement cross-members width	-	900	1200	1500	1800	2100	-	-
Set of two lifting/reinforcement cross-members	-	LVS08812	LVS08811	LVS08813	LVS08814	LVS08826	must be made	must be made
Set of two vertical uprights (1)	-	LVS08817	LVS08817	LVS08817	LVS08817	LVS08817	LVS08817	LVS08817
+ combination kit (2)	LVS08816	LVS08816	LVS08816	LVS08816	LVS08816	LVS08816	LVS08816	LVS08816
+ multiple combination kit	-	LVS08818	LVS08818	2 x LVS08818	3 x LVS08818	4 x LVS08818	+ LVS08818	+ LVS08818
+ 2 horizontal combination strip W=600	LVS08882	LVS08882	2 x LVS08882	2 x LVS08882	2 x LVS08882	2 x LVS08882	-	LVS08882
+ 2 horizontal combination strip W=300	-	LVS08885	-	LVS08885	2 x LVS08885	3 x LVS08885	+ LVS08885	-

(1) For more than 33 combined modules, these vertical uprights (1676 mm) are mandatory.

(2) Floor standing enclosure combination kit (LVS08815) > page E-14







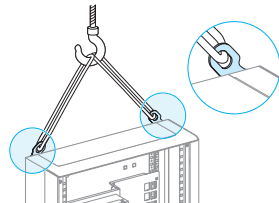

Wall-mounted and floor-standing enclosures

Lifting accessories - Installation

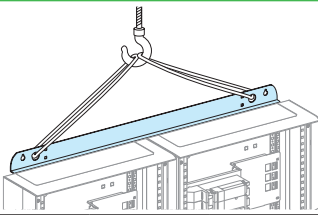
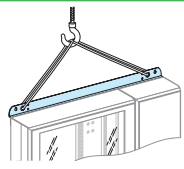
Up to 630 A

Lifting accessories

The lifting rings are used to move a single wall-mounted or floor-standing enclosure. For combined enclosures, use the lifting/reinforcement cross-members (see below).

2 lifting rings for single wall-mounted or floor standing enclosures						
						
Catalog numbers	LVS08801					
Characteristics	 <p>Set of two lifting rings</p>					
2 Lifting/reinforcement cross-members for combined enclosures W600 + W300			2 Lifting/reinforcement cross-members for combination wall-mounted enclosure W850 + duct W300			
						
Catalog numbers	LVS08812	LVS08811	LVS08811	LVS08813	LVS08814	LVS08826 LVS08809
Characteristics						
Have 2 types of holes: for lifting and for mounting on a wall						

Installation possibilities

Switchboards can be mounted on a wall in three manners: with the hook-on rail system, via the inside of the enclosure or using external wall-mounted brackets. Combined enclosures can be mounted using the lifting/reinforcement cross-members set of two lifting/reinforcement cross-members.

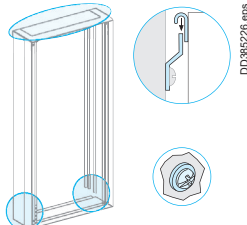
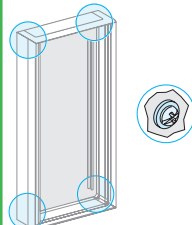
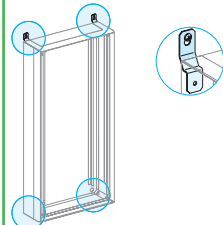
	Hook-on rail system	Mounting via the inside	Mounting using the external wall-mounted brackets
			
Catalog numbers	Delivered with the enclosure	-	LVS08804
Characteristics	The enclosure comes with 2 cross-members secured to the back of the enclosure (top and bottom) and a support rail (with levelling adjustment) for screw-mounting on the wall. The enclosure is easily mounted on the hook-on rail system. End the fixation with 2x 8mm diameter screws, at the bottom of enclosure	The enclosure can be mounted through the spacers in the 4 holes provided on the enclosure using 8 mm diameter screws (2 knockouts can be removed if necessary to provide 2 other holes).	4 external wall-mounted brackets.

Wall-mounted and floor-standing enclosures

Accessories

Up to 630 A

Flush-mounting kit

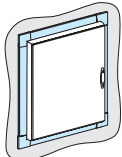
For wall-mounted enclosure		
		
Catalog numbers	LVS08819	LVS08820
Characteristics	6 to 18 modules PVC frame	21 to 27 modules PVC frame

Plinth raiser

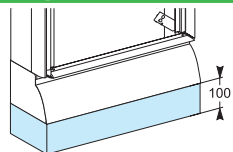
100 mm for floor-standing enclosure		
		
Catalog numbers	LVS08805	LVS08806
Characteristics	For basic floor-standing enclosure or extension. W = 600 mm	For basic floor-standing enclosure or extension. W = 850 mm
		LVS08807
		For a duct. W = 300 mm

Trunking spreader

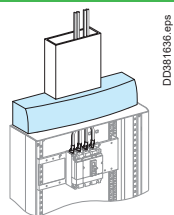
Trunking spreader	
	
Catalog number	LVS08824
Characteristics	For a professional-looking connection between the trunking and the enclosure. Can be installed at the top or bottom. The spreader is marked for cut-outs for standard trunking sizes. The maximum capacity is two 250 x 80 mm trunking sections.

Mounting of devices on doors

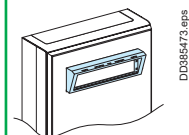
Type	Plain door with cut-out W600, W850
	
Catalog numbers	Plain door + LVS03928
Characteristics	Inclined visor by 30 °. Allows mounting of measurement, inspection, indication 72 x 72, 96 x 96, Ø 16 or Ø 22 mm, 45 x 45 devices. See page C-38.

Earthing braid

The earthing braid is used to earth a door or partial door with devices.

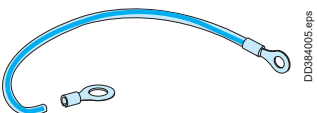
	Earthing braid, 6 mm ²	Earthing wire, 6 mm ²
		
Catalog numbers	LVS08910	LVS08911
Characteristics	Equipped with a 4 mm diameter lug at one end and a 6 mm diameter lug on the other. L = 200 mm	Equipped with a 5 mm diameter lug at one end and a 6 mm diameter lug on the other. L = 200 mm

Wall-mounted and floor-standing enclosures

Gland plates

Up to 630 A

Plain metal gland plates

Enclosures (wall-mounted, floor-standing, ducts) are supplied with a plastic gland plate installed on the top or bottom for wall-mounted enclosures and the top for floor-standing enclosures. For some connections needs, the existing plastic gland plate can be replaced by this metal gland plate.

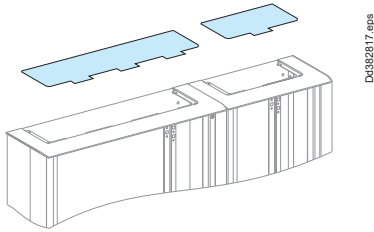

DD382817.eps

Plain metal gland plates

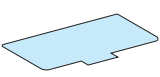
		
	DD385829.eps	DD385830.eps
Used with	Wall-mounted or floor-standing enclos. W600 / 850 mm	Duct W300
Catalog numbers	LVS08870	LVS08874

Interface metal plates with cut-outs

The enclosures (wall mounted and floor standing enclosures and ducts) are supplied with a plastic gland plate fitted on the top or bottom plate. This plastic gland plate can be replaced by an interface plate with cut-outs for special cable entry systems made of an insulating material (plain, with knockouts or membrane-type).

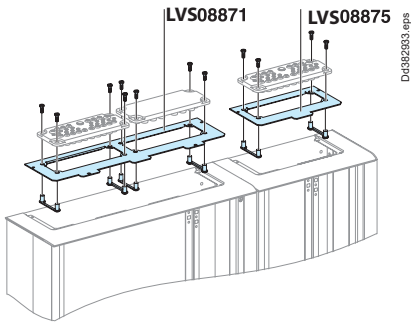

DD382833.eps

Metal interface plates with cut-outs

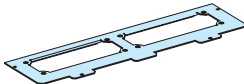
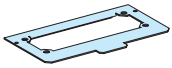
		
	DD385827.eps	DD385828.eps
Used with	Wall-mounted or floor-standing enclos. W600 / 850 mm	Duct W300
Catalog numbers	LVS08871	LVS08875

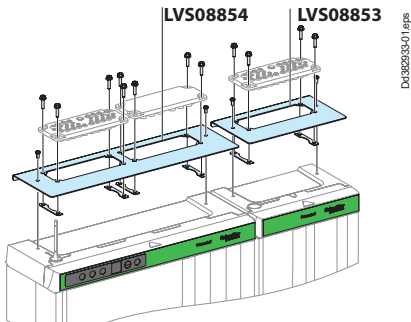

DD382833-01.eps



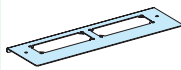
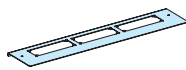
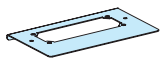

Metal interface plates with cut-outs

			
	DD385827-01.eps	DD385827-02.eps	DD385828-01.eps
Used with	W600	W850	W300
Catalog numbers	LVS08854	LVS08855	LVS08853

Gland plates : plain, with knockouts or membrane-type

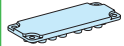
Mounting on the interface plates ref LVS08871 or LVS08875.

Gland plates

	plain	membrane-type		
				
	DD385708.eps	DD385712.eps	DD385713.eps	DD385714.eps
Catalog numbers	LVS08881	LVS08872	LVS08896	LVS08897
Ø 3 mm	-	-	8	-
Ø 3 to 7 mm	-	4	4	-
Ø 5 mm	-	-	4	-
Ø 7 to 12 mm	-	-	20	-
Ø 7 to 14 mm	-	8	4	-
Ø 7 to 18 mm	-	-	2	-
Ø 10 to 14 mm	-	12	-	-
Ø 14 to 20 mm	-	4	-	-
Ø 20 to 26 mm	-	1	-	-
Ø 17 to 30 mm	-	-	1	-
Ø 8 to 67 mm	-	-	-	2
Total number of entries	-	29	43	2

Wall-mounted and floor-standing enclosures

Door accessories

Up to 630 A

Padlocking

Padlocking	
	<p>mm2313101_p_2.eps</p>
Catalog numbers	LVS07938
Characteristics	For new rotary handle

Barrel locks, inserts

Rotary handle barrel locks and inserts			
	Characteristics	Catalog numbers	
<p>mm2313101_1.eps</p>	<p>mm2313101_3.eps</p>	1 key no. 405	LVS07940
	<p>mm23253301_4.eps</p>	2 keys no. 455	LVS07941
		2 keys no. 1242E	LVS07942
		2 keys no. 3113A	LVS07943
		2 keys no. 2433A	LVS07944
		2 keys no. 2432E	LVS07956
	<p>mm23253701_5.eps</p>	DIN double bar insert	LVS07945
<p>mm23253801_6.eps</p>	Screwdriver slot insert	LVS07946	
<p>mm23254101_7.eps</p>	Male triangle insert	8 mm	LVS07949
<p>mm23254301_8.eps</p>	Male square insert	6 mm	LVS07951
		8 mm	LVS07953

Rotary Handle	Handle	
RAL 7016 handle	EURO handle - RAL 9003	ASSA/ABLOY handle - RAL 9003
<p>mm2313101_1.eps</p>	<p>Dd1193888.ai</p>	<p>Dd1193897.ai</p>
Supplied with barrel lock (key no. 405) RAL 7016	Supplied without barrel	
LVS07931	LVS07932	LVS07933

(1) Can be adapted to the new rotary handle on PrismaSet G Active IP30 enclosures.

Wall-mounted and floor-standing enclosures

Spare parts

Up to 630 A

Accessories

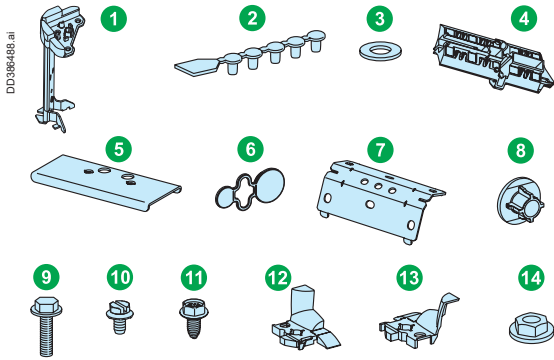

Duct accessories

LVS01036

- 1 4 pillars
- 2 1 earthing braid plug
- 3 4 washers
- 4 2 combination uprights
- 5 2 short combination crossbars
- 6 2 base blanking plugs
- 7 2 association fasteners
- 8 4 spacers
- 9 2 screws with flange
- 10 2 screws
- 11 1 self-threading screw
- 12 2 A-angle parts
- 13 2 B-angle parts
- 14 6 nuts HX grooved

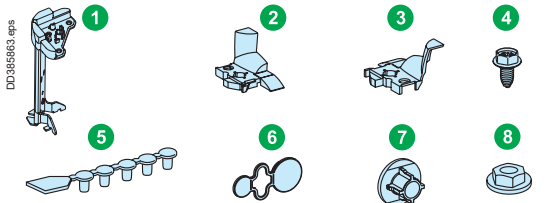

Wall mounted and floor standing enclosures accessories

LVS01018

- 1 4 pillars
- 2 2 A-angle parts
- 3 2 B-angle parts
- 4 8 self threading screws
- 5 1 earthing braid plug
- 6 4 base blanking plugs
- 7 4 spacers
- 8 4 nuts HX grooved

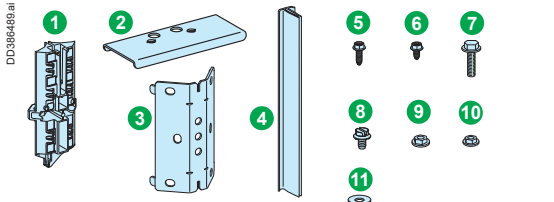

G IP30 floor standing enclosure combination kit

LVS08815

- 1 1 combination upright
- 2 1 short combination crossbar + 2 screws + 2 nuts
- 3 2 association fasteners
- 4 7 plastic protectors
- 5 2 self-threading screws
- 6 3 self-threading screws
- 7 1 screw with flange
- 8 1 screw
- 9 3 nuts
- 10 3 nuts
- 11 2 washers

Door accessories

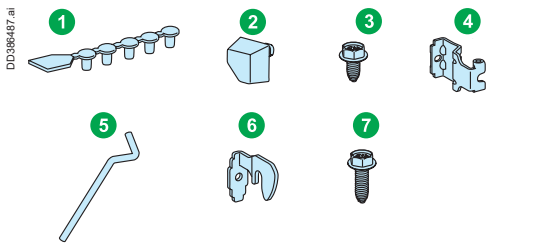

Wall mounted and floor standing enclosures closing accessories

LVS01032

- 1 1 earthing braid plug
- 2 2 door stops
- 3 3 self threading screws
- 4 3 fixed hinges
- 5 3 hinge pins
- 6 3 stop bolts
- 7 4 self threading screws

Wall-mounted and floor-standing enclosures

Spare parts

Up to 630 A

Metal plates with cut-outs + plastic gland plates

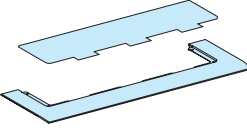
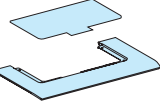
D438532.eps 	W600	LVS08880
	W300	LVS08884
D438534.eps 		

Metal top/bottom plate (IP30)

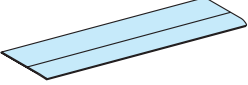
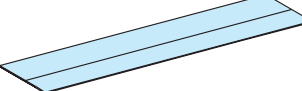
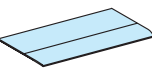
DD384488.EPS 	W600	LVS01017
	W850	LVS01070
DD385831.EPS 		
DD384490.EPS 	W300	LVS01039

Green Bar

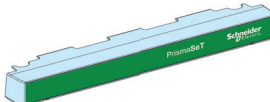
	W850	LVS01125
---	-------------	-----------------

Side (IP30)

DD384491.EPS 	6 modules	LVS01040
	9 modules	LVS01041
	12 modules	LVS01042
	15 modules	LVS01043
	18 modules	LVS01044
	21 modules	LVS01045
	24 modules	LVS01046
	27 modules	LVS01035
	30 modules	LVS01034
	33 modules	LVS01033
36 modules	LVS01047	

Rotary handle

LVS01218



Wall-mounted and floor-standing enclosures

Spare parts

Up to 630 A

Central uprights (IP30)

DD384492.EPS

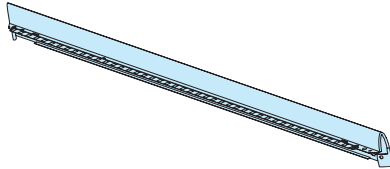

Association profile 9 modules	LVS01063
Association profile 12 modules	LVS01064
Association profile 15 modules	LVS01065
Association profile 18 modules	LVS01066
Association profile 21 modules	LVS01067
Association profile 27 modules	LVS01030
Association profile 30 modules	LVS01029
Association profile 33 modules	LVS01028
Association profile 36 modules	LVS01069

Plinth

DD384494.EPS

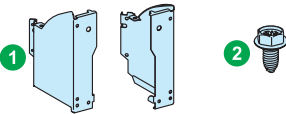

Accessories for plinth LVS01051

- 1 Left drilled base bracket + right drilled base bracket
- 2 4 self-threading screws

DD384493.EPS

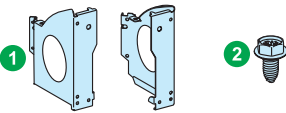

Floor standing enclosures LVS01050

- 1 Left base bracket + right base bracket
- 2 4 self-threading screws

DD384495.EPS

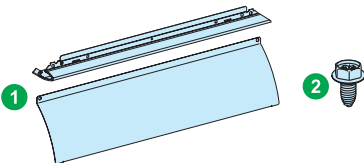

Plinth front, 600 mm LVS01052

- 1 Base cover + plinth
- 2 2 self-threading screws

DD384496.EPS

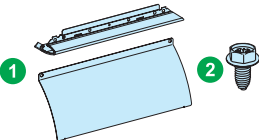

Plinth front, 300 mm LVS01053

- 1 Base cover + plinth
- 2 2 self-threading screws

Front cover support uprights (IP30)

DD384500.EPS

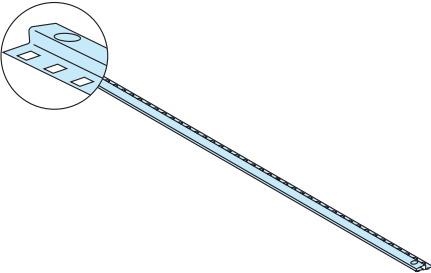

18 modules	LVS01254
27 modules	LVS01257
30 modules	LVS01258
33 modules	LVS01259
36 modules	LVS01261

Wall-mounted and floor-standing enclosures

Dimensions

Up to 630 A

Enclosures W600 – 6 to 27 mod.

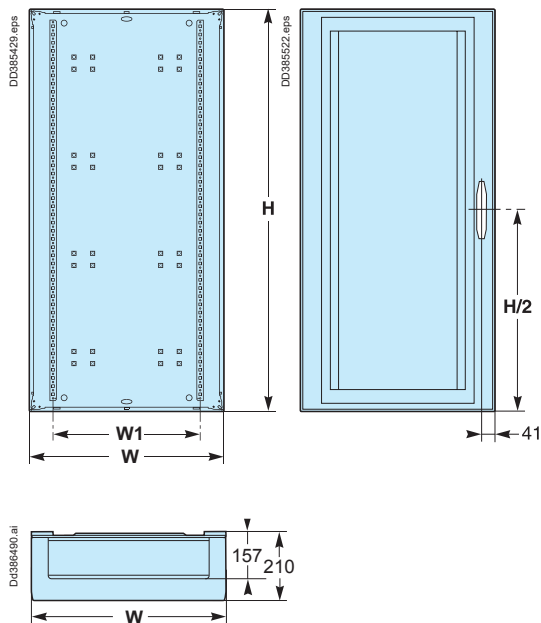

Enclosures W600 – 27 to 36 mod.

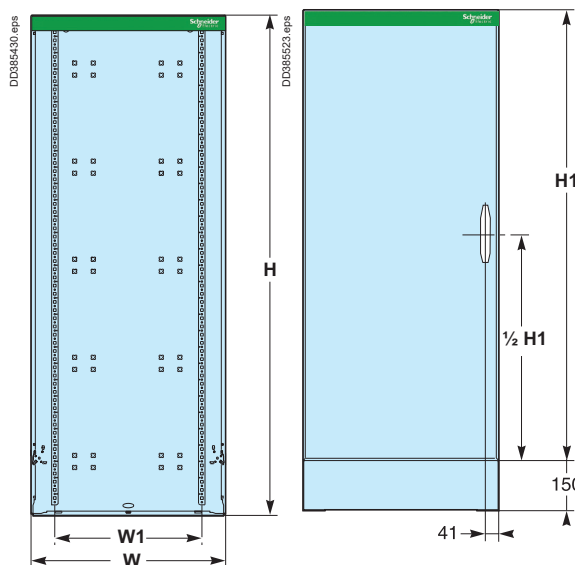

Ducts W300

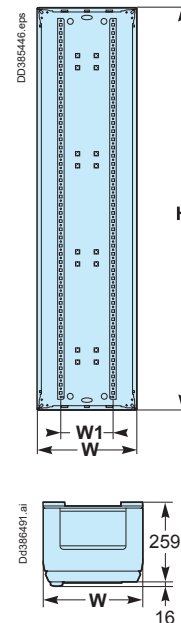

	Nb. of vertical modules	Height		Width						Depth		
		H	H1	W600		W850		W300		W/O door	with door	
				W	W1	W	W1	W2	W			W1
Wall-mounted enclosures / duct	6	330	-	595	450	-	-	-	305	200	210	259
	9	480	-	595	450	-	-	-	305	200	210	259
	12	630	-	595	450	-	-	-	305	200	210	259
	15	780	-	595	450	-	-	-	305	200	210	259
	18	930	-	595	450	-	-	-	305	200	210	259
	21	1080	-	595	450	-	-	-	305	200	210	259
	24	1230	-	595	450	-	-	-	305	200	210	259
27	1380	-	595	450	-	-	-	305	200	210	259	
Floor-standing enclosures / duct	27	1580	1430	595	450	845	450	200	305	200	210	259
	30	1730	1580	595	450	845	450	200	305	200	210	259
	33	1880	1730	595	450	845	450	200	305	200	210	259
	36	2030	1880	595	450	845	450	200	305	200	210	259

Depth behind front plate

Functional uprights

Modular rails

Slotted mounting plate

Cable running

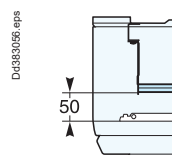
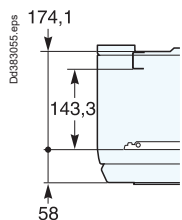

Fixed rail
Cat. no. LVS03001 or LVS03010

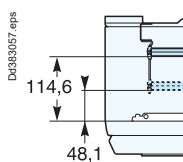

Adjustable rail
Cat. no. LVS03002 or LVS03011

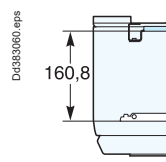

Recessed mounting plate
Cat. no. LVS03171, LVS03172, LVS03173, LVS03176, LVS03177 or LVS03178

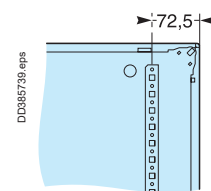

Rear upright

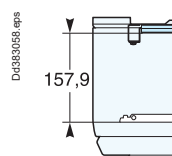

Recessed rail
Cat. no. LVS03003

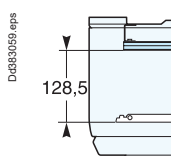

Rear rail
Cat. no. LVS03004

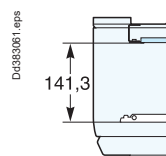

Flat plate
Cat. no. LVS03170 or LVS03175

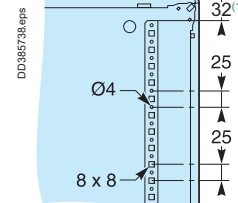

(1) 57 mm for height 36 modules

Wall-mounted and floor-standing enclosures

Dimensions

Up to 630 A

Enclosures W850

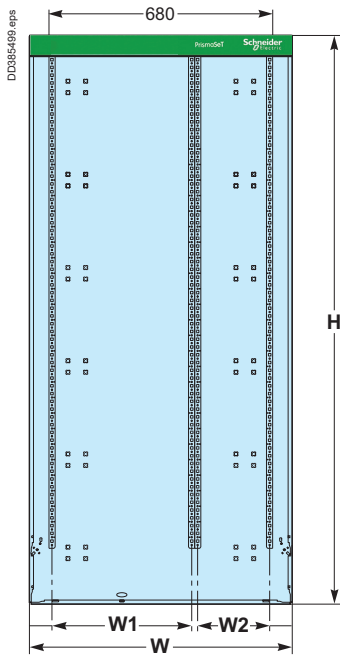

Door

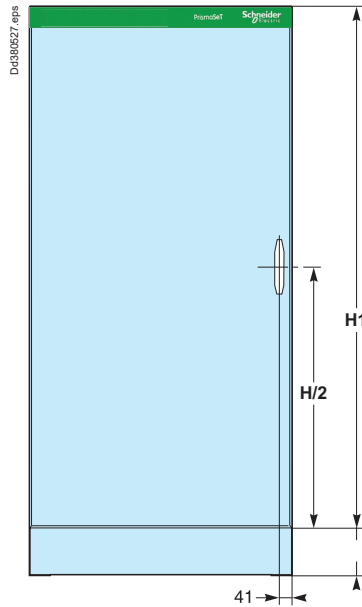

Cable entry

W600

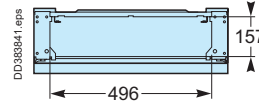

W300

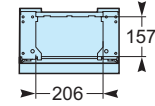

W850

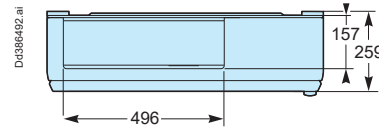

Trunking spreader

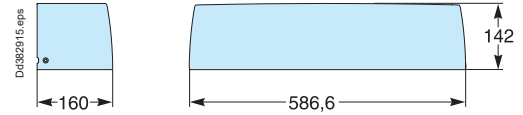

Wall-mounted installation

External brackets

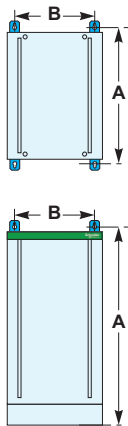

	Nb. of vertical modules	A	B		
			W600	W850	W300
Wall-mounted enclosures	6	430	545	795	255
	9	580	545	795	255
	12	730	545	795	255
	15	880	545	795	255
	18	1030	545	795	255
	21	1180	545	795	255
Floor-standing enclosures	24	1330	545	795	255
	27	1480	545	795	255
	30	1630	545	795	255
	33	1780	545	795	255
	36	1930	545	795	255
	39	2080	545	795	255

Cyma system

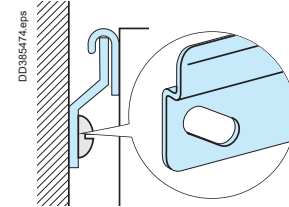

Screws

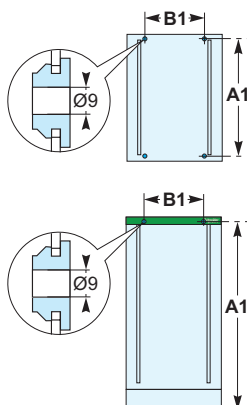

	Nb. of vertical modules	A1	B1		
			W600	W850	W300
Wall-mounted enclosures	6	270	381	631	91
	9	420	381	631	91
	12	570	381	631	91
	15	720	381	631	91
	18	870	381	631	91
	21	1020	381	631	91
Floor-standing enclosures	24	1170	381	631	91
	27	1320	381	631	91
	30	1470	381	631	91
	33	1620	381	631	91
	36	1770	381	631	91
	39	1920	381	631	91

Enclosure plinth fixation

W600

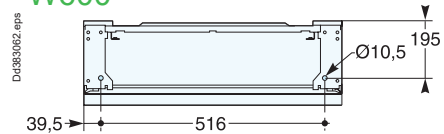

W850

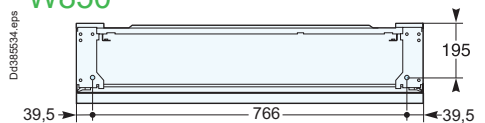

W300

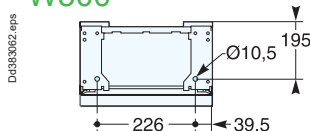



Up to 630 A

Great capability for meeting the requirements of your installation



PB 110167 eps

> 100 % reliable and in compliance with existing standards

All the components (switchgear, splitter blocks, prefabricated connections, etc.) have been designed to work together. All switchboard configurations have been tested. Even the most demanding.

> Optimised, upgradeable installation

PrismaSeT G IP55 is the only switchboard in this category designed as a "kit". All configurations and combinations are possible, with full access. Thanks to the organisation around functional units, the installation evolves simply while preserving its original performance.

> Ease of setup

The complete accessibility of all mounting and connection points facilitates assembly and cabling in the workshop. The functional units are clearly identified: operations are intuitive and reliable, and connection and checking are performed naturally.



Tested
specifications



- > Safety of people and property
- > Continuity of service
- > Robustness
- > Ergonomics and complete accessibility
- > Optimisation and upgradeability

Presentation

Up to 630 A

Metallic indoor enclosures to compose Severe environments: industrial and agricultural buildings, basements, kitchens, etc.

Enclosure delivered flat: total accessibility
Designed for electrical continuity

- 630 A
- IP55
- IK10
- Seismic characteristics: 2,5G



PB119167.eps



PE60331.eps

Description

Steel sheet metal with electrophoresis treatment + hot-polymerised polyester epoxy powder.

Enclosure:

- width: 575 mm, with duct: 325 mm
- height: 450 to 1750 mm
- depth: 260 mm with door
- properties of metal enclosures > page G-15

Main characteristics

IP55 enclosure

Rated operational current	$I_n = 630 \text{ A} - I_{sc} = 50 \text{ kA}, I_{cw} = 25 \text{ kA rms} / 1 \text{ s}, I_{pk} = 53 \text{ kA}$
Colour	White colour RAL 9003
Standards conformity	EN 62208, IEC 61439-2
Degree of protection	IP55 with door
Degree of protection against mechanical impacts	IK10
Seismic characteristics	2,5G without accessories (IEC 60068-2-57)
Isolation	Class 1
Doors	<ul style="list-style-type: none"> ■ Plain or transparent, opening to right or left 180° ■ Supplied with a handle and keylock (key 405) Distance behind plain door = 78 mm, Distance behind transparent door = 73 mm.
Earthing	Earthing braid delivered with enclosure
Combination	> page E-24



Easy design with

Rapsody software

> page B-29

Presentation

Up to 630 A

Fingers safe for cabling
 ■ Painted sheet metal inside, protection for wiring installers' hands

Accessories shared with PrismaSeT G Active, IP30

Plates for connecting control circuits

Pre-hooked plates for quick positioning

Full accessibility
 ■ Removable side panels: easy wiring

Trunking support plate, fixed at the same time as the modular rail

Plain or transparent door

Ergonomics and safety
 ■ Easy panel handling thanks to the ergonomic gripper
 ■ Legible "Open/closed" positions of front plate,
 ■ Integrated front plate sealing function

Practical
 ■ Functionalized installation of push buttons, power sockets, etc.
 ■ Installation of power sockets on the side

Weatherproofing
 ■ Large choice of IP55 gland plates

Multiple combinations



Weatherproof enclosures





Up to 630 A



Wall mounted and floor standing enclosures

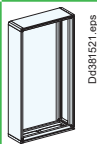

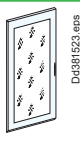

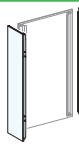
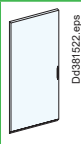
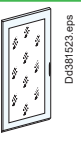

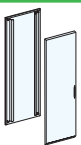
Enclosures are supplied with plain metal gland plates and external mounting brackets.

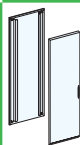
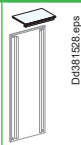
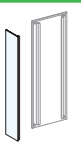
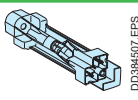
The doors are reversible, opening 180° to right or left, supplied equipped with a handle with 405 key lock.

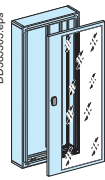
The wall mounted and floor standing enclosure extensions and ducts are supplied without combination kits, see table opposite.

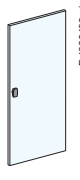
Type		Basic enclosure W600			Extension enclosures W600				
									
Nb. of vertical modules of 50 mm	Height in mm	Basic enclosure	Frame + plain door	Frame + transparent door	Rear	Top and bottom plates for side-by-side combination	Side panels for vertical combination	Frame + plain door	Frame + transparent door
7	450	LVS08302	LVS08322	LVS08332	LVS08312	LVS08371	LVS08352	LVS08322	LVS08332
11	650	LVS08303	LVS08323	LVS08333	LVS08313	LVS08371	LVS08353	LVS08323	LVS08333
15	850	LVS08304	LVS08324	LVS08334	LVS08314	LVS08371	LVS08354	LVS08324	LVS08334
19	1050	LVS08305	LVS08325	LVS08335	LVS08315	LVS08371	LVS08355	LVS08325	LVS08335
23	1250	LVS08306	LVS08326	LVS08336	LVS08316	LVS08371	LVS08356	LVS08326	LVS08336
27	1450	LVS08307	LVS08327	LVS08337	LVS08317	LVS08371	LVS08357	LVS08327	LVS08337
33	1750	LVS08309	LVS08329	LVS08339	LVS08319	LVS08371	LVS08359	LVS08329	LVS08339

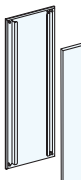
Type		Ducts W300		Wall-mounted enclosures W300			
							
Nb. of vertical modules of 50 mm	Height in mm	Rear + plain door	Top and bottom plates	Rear + plain door	Top and bottom plates	Side panels	Struts (set of 2)
7	450	LVS08342	LVS08372	LVS08342	LVS08372	LVS08352	2 x LVS01025
11	650	LVS08343	LVS08372	LVS08343	LVS08372	LVS08353	2 x LVS01025
15	850	LVS08344	LVS08372	LVS08344	LVS08372	LVS08354	2 x LVS01025
19	1050	LVS08345	LVS08372	LVS08345	LVS08372	LVS08355	2 x LVS01025
23	1250	LVS08346	LVS08372	LVS08346	LVS08372	LVS08356	2 x LVS01025
27	1450	LVS08347	LVS08372	LVS08347	LVS08372	LVS08357	2 x LVS01025
33	1750	LVS08349	LVS08372	LVS08349	LVS08372	LVS08359	2 x LVS01025

W850 floor standing enclosure (plinth sold separately)				Duct W300		
						
Nb. of vertical modules of 50 mm	Height in mm	Floor standing enclosure	Plain door	Transparent door	Rear + plain door	Top and bottom plates
33	1750	LVS08311	LVS08330	LVS08340 (1)	LVS08349	LVS08372

Spare parts > page E-30 ; Dimensions > page E-31

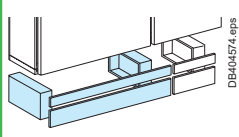
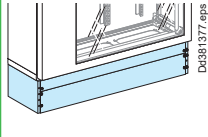
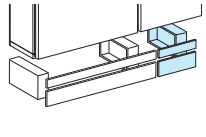
Plinth H = 150 mm	W600	W850 floor standing enclosure	Duct W300
			
Catalog numbers	2 x LVS08392 + LVS08393	LVS08802	LVS08392 + LVS08394

(1) New ref, commercialised mid 2018.

Spare parts > page E-30

Dimensions > page E-31

Partitioning > page C-41

Weatherproof enclosures

Combination kits

Up to 630 A

Combination kits

	Components Catalog numbers				
	Single pillar ●	Horizontal/vertical combination kit ●	"L" combination kit ●	Square combination kit ●	Mounting upright
Catalog numbers	LVS01025 (set of 2)	LVS08381 x 2	LVS08382 + LVS08381	LVS08383	LVS08391
Characteristics	Supplied with basic enclosures	2 double pillars	2 L pillars + 2 double pillar + 1 single pillar	1 square pillar + 4 double pillar	L = 1950 mm

Mounting example

	Simple	In L	In square
Wall-mounted enclosures	<p>1 Basic enclosure</p> <p>Rear plate for enclosure extension</p> <p>3 1 set of two side panels</p>	<p>1 1 basic enclosure</p> <p>2 1 rear + door for duct</p> <p>3 1 set of two top and bottom plates for duct W300 or W600</p> <p>4 1 rear plate for enclosure extension</p> <p>5 1 set of two side panels</p>	<p>1 1 basic enclosure</p> <p>2 3 rear plates for enclosure extensions</p> <p>3 1 set of two top and bottom plates for enclosure extensions W300 or W600</p> <p>4 1 set of two side panels</p>
Combination kits	<p>4 2 x 1 double pillar LVS08381</p>	<p>6 1 L pillar LVS08382</p> <p>7 2 x 1 double pillar LVS08381</p> <p>8 1 standard pillar LVS01025</p>	<p>5 1 square pillar LVS08383</p> <p>6 4 x 1 double pillar LVS08381</p>
Mounting uprights	<p>5 2 x 1 mounting upright LVS08391</p>	<p>9 2 x 1 mounting upright LVS08391</p>	<p>7 3 mounting uprights W = 1950 mm (to reinforce the switchboard) 3 x LVS08391</p>

Lifting

Lifting rings

Catalog number	LVS08396
Characteristics	Set of two, supplied with mounting hardware. The lifting rings are secured directly to the switchboard or to the mounting uprights.

Note: for combinations of more than two enclosures, the switchboard must be reinforced using mounting uprights (LVS08391).

Weatherproof enclosures

Mounting accessories

Up to 630 A

Mounting accessories

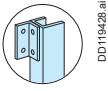
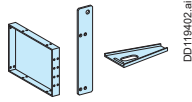
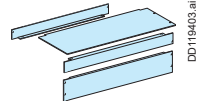
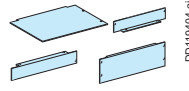
Upright	Mounting uprights	Plinth	Plinth gusset	Plinth cover panel (for enclosure)	Plinth cover panel (for duct)
Catalog numbers	LVS08391	LVS08392	LVS08392	LVS08393	LVS08394
Characteristics	<ul style="list-style-type: none"> W = 1950 mm Colour: RAL 7016 Supplied with: <ul style="list-style-type: none"> two adjustable fixing brackets, one joint for combination with a plinth or another upright. Leave space behind the switchboard for cable running and to improve ventilation. 	<ul style="list-style-type: none"> H = 150 mm Colour: RAL 7016 	<ul style="list-style-type: none"> W = 600 mm Colour: RAL 7016 	<ul style="list-style-type: none"> W = 300 mm Colour: RAL 7016 	
Quantity to order	For one enclosure, order two uprights. For each enclosure extension or duct, order one additional upright.	For the basic enclosure, order two gussets and one 600 mm wide plinth cover panel. For each enclosure extension or duct, order one additional gusset and the corresponding cover panel.			

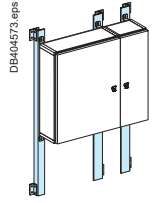
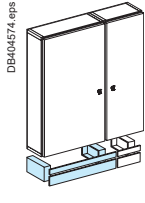
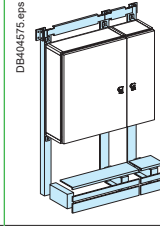
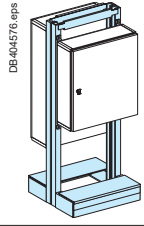
Mounting example	On uprights	On plinth	On wall structure	Free-standing structure
				
Catalog numbers	3 x LVS08391	3 x LVS08392 + LVS08393 + LVS08394	3 x LVS08391 + 3 x LVS08392 + LVS08393 + LVS08394	4 x LVS08391 + 4 x LVS08392 + 2 x LVS08393
Designation	3 mounting uprights	3 gussets + 1 plinth cover panel for enclosure + 1 plinth cover panel for duct	3 uprights + 3 gussets + 1 plinth cover panel for enclosure + 1 plinth cover panel for duct	4 uprights + 4 gussets + 2 plinth cover panels for enclosure
Remarks	The uprights are used to mount on a wall one or more enclosures combined horizontally or vertically.	The plinth, installed in the factory or on-site, raises the switchboard to protect it and facilitate spreading of cables arriving from a trough. The wall-fixing brackets supplied with the plinth ensure that the switchboard cannot topple over.	The supplied external brackets prevent the switchboard from tilting.	Assembly of 2 wall structures connected back-to-back. The switchboard is free-standing. Fixed to the ground and can be moved very easily with lifting rings ref. LVS08396. It can house one or more enclosures.

Mounting on a pole

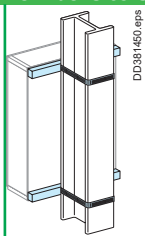
2 reinforcement cross-members to support the enclosure	
	
Catalog number	LVS08395
Characteristics	The kit is used to mount an enclosure or an enclosure + duct combination, without drilling, to an I-beam or concrete pole that can be rectangular or cylindrical. The maximum circumference of the pole is 580 mm. Supplied with mounting hardware.

Canopy

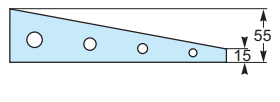
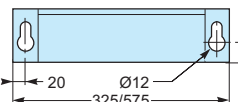
Using	For wall-mounted enclosures W600	For duct W300
		
Catalog numbers	LVS08386	LVS08387
Characteristics	<ul style="list-style-type: none"> Installed on the mounting uprights or directly on the wall, canopies improve switchboard protection against vertically falling water and objects. Colour: RAL 7016. Supplied with: the hardware required for mounting on the uprights, the components required for combination with another canopy. 	

Dimensions > page E-31 ; Partitioning > page C-41

Weatherproof enclosures

Grand plates

Up to 630 A

Metal interface plate with cut-outs

Enclosures are supplied with plain metal gland plates installed on the top or bottom panel of the enclosures (2 plates) or 300 mm wide ducts (1 plate).

These plates can be replaced by metal plates with cut-outs LVS08876 for special cable entry systems made of an insulating material (plain, with knockouts or membrane-type).

They are designed for entry of cables of different cross-sectional areas via the bottom of a switchboard while maintaining the IP55 degree of protection.

The gland plates are easy to install using the mounting kit (supplied with each gland plate) that positions and holds the nuts during installation.

This makes it possible to mount the gland plates using a single tool.



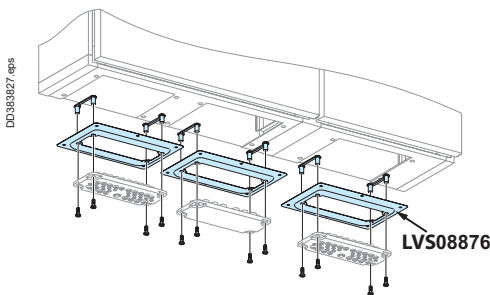

Plain gland plates, plates with knockouts and membrane-type plates

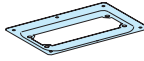

Metal interface plate with cut-outs

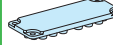
	
Catalog numbers	LVS08876
Characteristics	Fitting gland plates: plain and membrane-type.

Gland plates for metal interface

	plain	membrane-type		
				
Catalog numbers	LVS08881	LVS08872	LVS08896	LVS08897
Ø 3 mm	-	-	8	-
Ø 3 to 7 mm	-	4	4	-
Ø 5 mm	-	-	4	-
Ø 7 to 12 mm	-	-	20	-
Ø 7 to 14 mm	-	8	4	-
Ø 7 to 18 mm	-	-	2	-
Ø 10 to 14 mm	-	12	-	-
Ø 14 to 20 mm	-	4	-	-
Ø 20 to 26 mm	-	1	-	-
Ø 17 to 30 mm	-	-	1	-
Ø 8 to 67 mm	-	-	-	2
Total number of entries	-	29	43	2

Gland plates, direct mounting

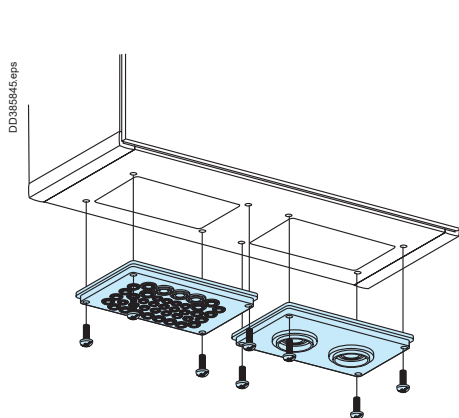

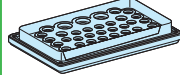
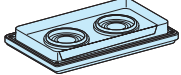
		
Catalog numbers	LVS08898	LVS08899
Ø 7 to 26 mm	39	-
Ø 33 to 72 mm	-	2
Total number of entries	39	2

Weatherproof enclosures

Partial doors and functional units for partial door

Up to 630 A

Partial doors

Type	Plain	With cut-outs
4 modules (H = 200 mm) for enclosure from 11 to 27 modules	LVS08374	LVS08376
Installation	<ul style="list-style-type: none"> On a wall-mounted enclosure at least 11 modules high (H = 650 mm). The front must be completed with another door (plain or transparent). Each enclosure or extension can be equipped with only one partial door. 	
Caractéristiques	-	<ul style="list-style-type: none"> Designed for two mounting plates with 22 mm diameter devices or Schneider Electric industrial sockets. They are supplied with an insulating plain mounting plate that can be used to: <ul style="list-style-type: none"> blank off a reserve hole, install all types of devices (sockets, EPO devices, measurement devices). The dimensions of the two holes are 201 mm x 111 mm.
	<ul style="list-style-type: none"> Hinges that open 170° Equipped with a 8 mm male triangle insert (key not supplied). 	

Plastic plates for equipping openings on partial doors

They can be installed:

- horizontally on the partial doors with cut-outs
- horizontally or vertically at any point on a door or side panel.

Type	Plain	For 22 mm diameter devices
Catalog numbers	LVS08861	LVS08862
Characteristics	<ul style="list-style-type: none"> Can be used to: <ul style="list-style-type: none"> blank off partial doors with cut-outs mount any type of device (EPO devices, measurement devices, sockets) 	<ul style="list-style-type: none"> For installation of eight 22 mm diameter devices (lights, switches, pushbuttons, etc.) Supplied with 4 blanking plug

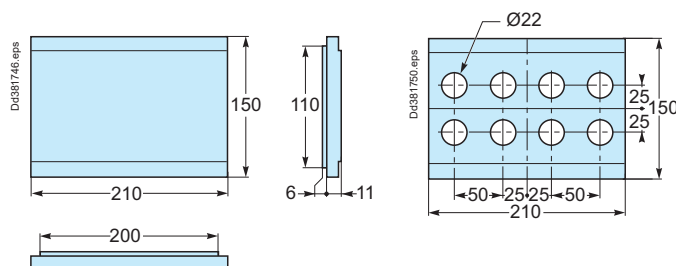

Weatherproof enclosures

Side panels

Up to 630 A

Side panels with cut-outs

These panels are designed to replace the standard side panel. They can be mounted on the left or right-hand side.

Side panels with cut-out

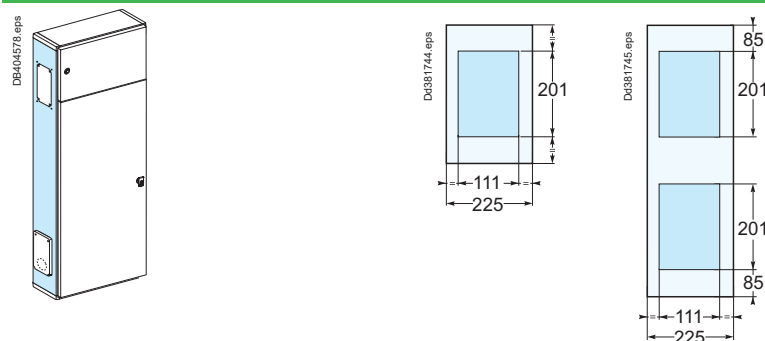

Nb. of vertical modules of 50 mm	Height in mm	Nb. of 111 x 201 mm holes	Catalog numbers
15	850	2	LVS08364
33	1750	2	LVS08369

The cut-outs are designed for the installation of Pratika PK industrial sockets up to 63 A either directly or on 111 x 201 mm adaptation plates of the Kaedra enclosure range.

Installation is direct for:

- 16/32 A interlocked LV sockets, IP44/IP65, IK08
- 16 A VLV sockets with 160 VA safety transformers, IP44/IP65, IK08.

Plastic plate for equipping openings on partial door

Type	Plain
Catalog numbers	LVS08861
Characteristics	<ul style="list-style-type: none"> ■ Can be used to: <ul style="list-style-type: none"> □ blank off □ mount any type of device (EPO devices, measurement devices, sockets)

Weatherproof enclosures

Door accessories

Up to 630 A

Locks

- The small plain and transparent doors (7 to 23 modules) are supplied with a small handle comprising a barrel lock no. 405.
- The large plain and transparent doors (27 to 33 modules) are supplied with a large handle comprising a barrel lock no. 405.
- The partial doors are supplied with an 8 mm male triangle insert.
- All doors can receive as optional equipment:
 - a large or small handle with a barrel lock no. 405. The latter can be replaced by other barrel locks or special inserts
 - a large EURO handle, supplied without a barrel lock
 - door inserts (squares, triangles, double bars, screwdriver slots).

Handles for replacement

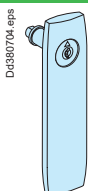
Handles			
	 Dd380704 eps	 Dd380704 eps	
Catalog numbers	LVS08936	LVS08935	LVS08934
Designation	Door latch with lock and 2 no. 405 keys	Handle (W = 155 mm) with lock and 2 no. 405 keys	EURO handle without a barrel lock (1)





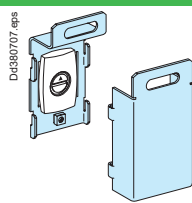

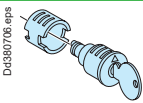

(1) Do not suit to barrels with an automatic return stroke of the key.

Padlocking

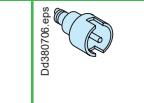
Padlocking	
	 Dd380707 eps
Catalog number	LVS08939
Designation	The kit can be installed on all IP55 doors, except those equipped with an EURO lock. Kit designed for three padlocks.

Handle barrel locks and inserts

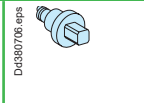
These components may equip handles after removing the standard barrel lock no. 405.

Handle barrel locks (1)										
	 Dd380706 eps	 Dd380706 eps	 Dd380706 eps	 Dd380706 eps	 Dd380706 eps	 Dd380706 eps	 Dd380706 eps	 Dd380706 eps	 Dd380706 eps	 Dd380706 eps
Supplied with	2 keys no. 2433A	2 keys no. 455	2 keys no. 1242E	2 keys no. 3113A	Double bar insert 3 mm	Male triangle insert			Male square insert	
Catalog numbers	LVS09933	LVS09945	LVS09942	LVS09943	LVS09932	LVS09937	-	-	LVS09947	LVS09948

(1) Others A and E combinations are available from Ronis, please contact us.

Weatherproof enclosures

Spare-parts

Up to 630 A

Accessories (IP55)

DD384507_1.EPS

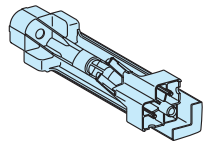

2 pillars

LVS01025

DD384508.EPS

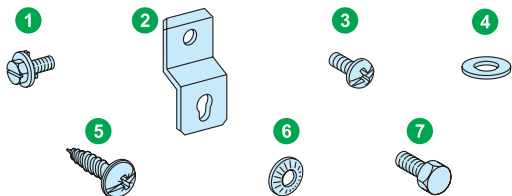

Set of spare parts for wall-mounted enclosure

LVS01247

- 1 24 screws + stubs contact
- 2 4 simple fixing brackets
- 3 4 screws pillar/seating
- 4 12 nylon washers
- 5 12 self threading screws
- 6 4 conical washers
- 7 4 screws

DD384509.EPS

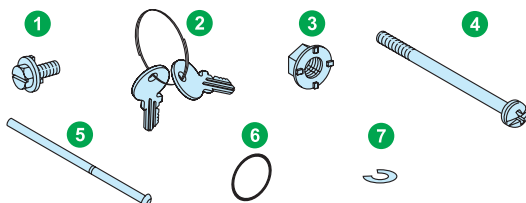

Set of spare parts for door

LVS01248

- 1 1 screw + stub washers
- 2 2 keys no.405
- 3 1 spring nut
- 4 4 screws frame/pillar
- 5 3 hinge pins
- 6 8 o-ring joints
- 7 3 stop rings

DD384510.EPS

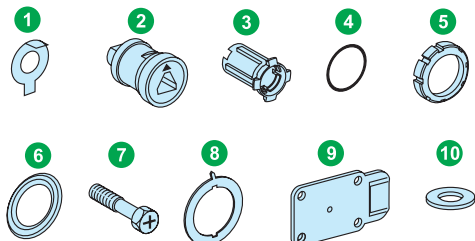

Spare parts for closing system

LVS01249

- 1 1 stop washer
- 2 1 screw body
- 3 1 screw cap
- 4 1 o-ring
- 5 1 screw nut
- 6 1 composite seal
- 7 1 captive screw
- 8 1 special washer
- 9 1 cam
- 10 1 washer

Weatherproof enclosures

Dimensions

Up to 630 A

W600 enclosures

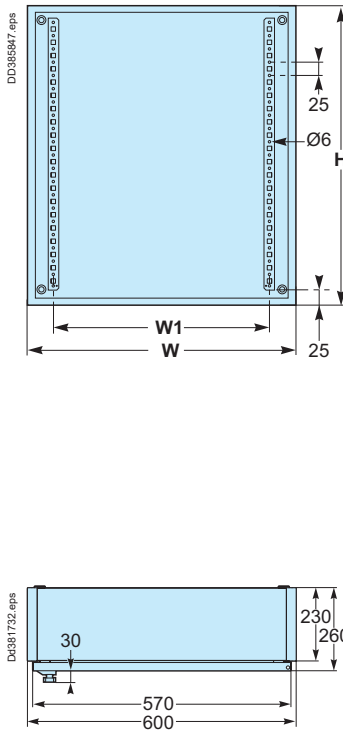

W850 enclosure, 33 mod.

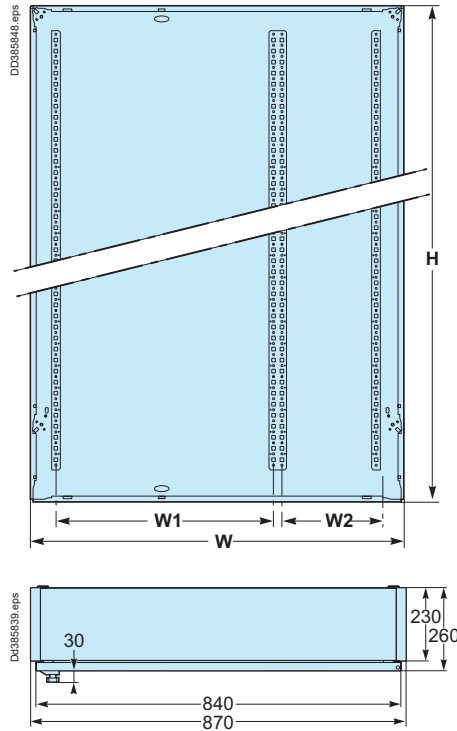

W300 ducts

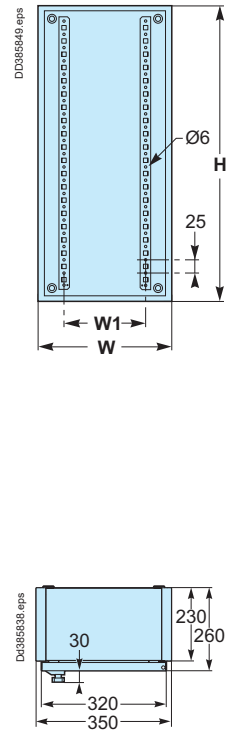

	Nb. of vertical modules	H	W600		W850			W300	
			W	W1	W	W1	W2	W	W1
Enclosures	7	425	575	450	-	-	-	325	200
Ducts	11	625	575	450	-	-	-	325	200
	15	825	575	450	-	-	-	325	200
	19	1025	575	450	-	-	-	325	200
	23	1225	575	450	-	-	-	325	200
	27	1425	575	450	-	-	-	325	200
	33	1725	575	450	845	450	200	325	200

Functional uprights

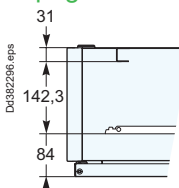

Modular rails

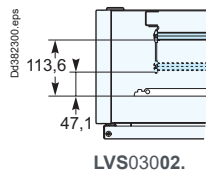
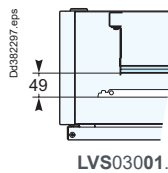

Slotted mounting plate

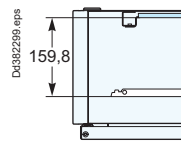

LVS03171/LVS03172/LVS03173/
LVS03176/LVS03177/LVS03178.

Cable running plate

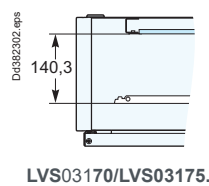
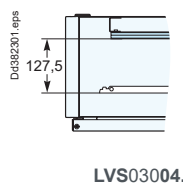
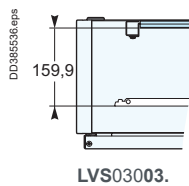
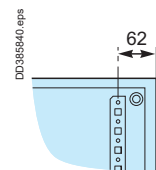

Rear upright

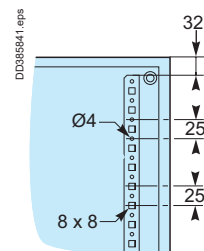

- (1) Double profile modular rail.
- (2) Recessed slotted mounting plate.
- (3) Transparent door.
- (4) Plain door.
- (5) Front plate.
- (6) Door.

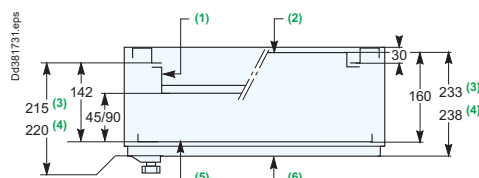

Weatherproof enclosures

Dimensions

Up to 630 A

Doors W600

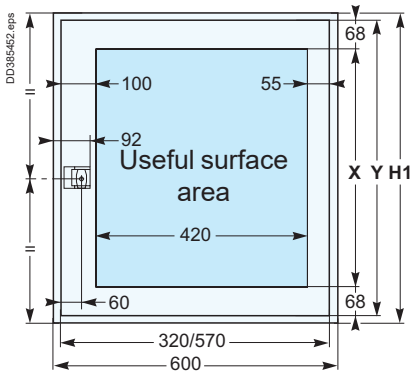

Doors W850 of 33 mod.

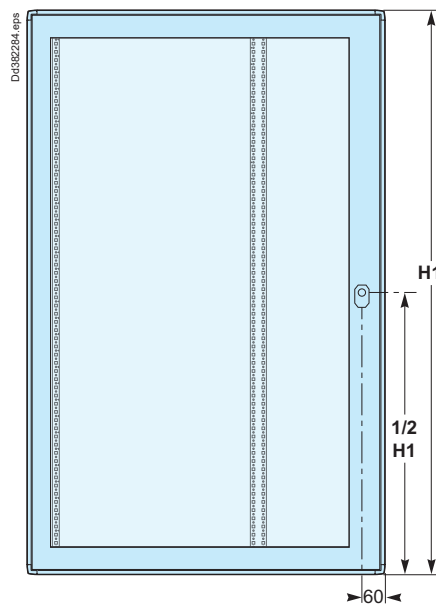

Cable entry W600

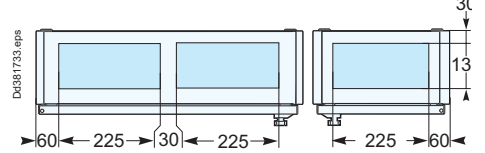

W300

W850

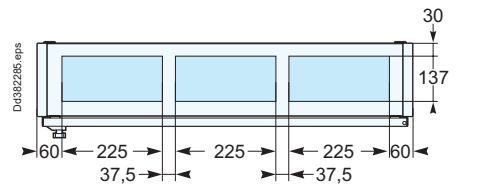

Doors

H1	X	Y
450	284	420
650	484	620
850	684	820
1050	884	1020
1250	1084	1220
1450	1284	1420
1750	1584	1720

Wall-mounted installation

External brackets W600/850

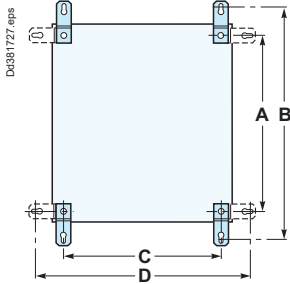

External brackets W300

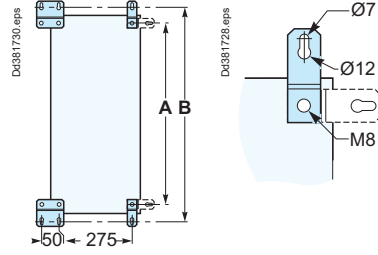

Wall structure

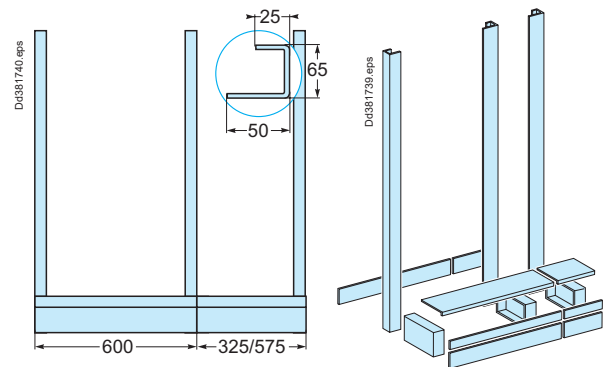

Nb. of vertical modules	A	B	C		D	
			W600	W850	W600	W850
7	375	525	525	-	650	-
11	575	725	525	-	650	-
15	775	925	525	-	650	-
19	975	1125	525	-	650	-
23	1175	1325	525	-	650	-
27	1375	1525	525	-	650	-
33	1675	1825	525	-	650	-

Plinth fixation W600

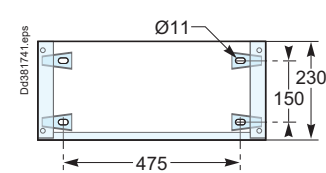

Plinth fixation W850

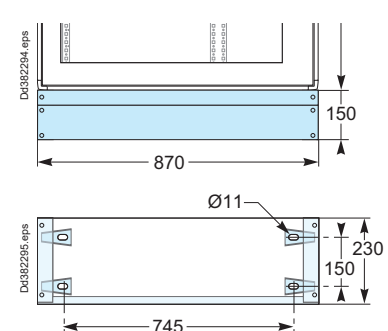

Enclosure combinations

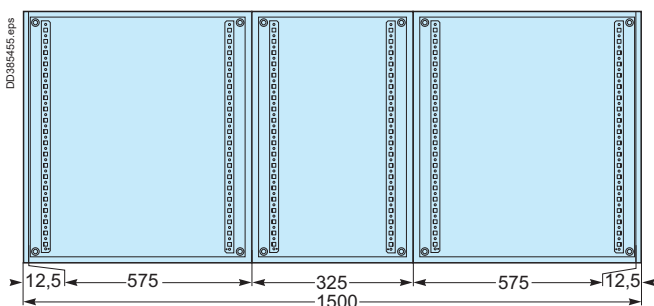

Pack 160,
Pack 250
enclosures

Contents

Pack 160, IP30/IP43

Presentation	F-3
Wall-mounted enclosures	F-4
Enclosures extension and metering	F-5
Functional units for extension enclosures	F-5
Gland plates, trunk, canopy, gasket	F-6
Combination, installation, flush-mounting kit	F-7
Accessories and spare-parts	F-8
Linery distribution and connection systems	F-9
Dimensions	F-10

Pack 250, IP30/IP4X

Presentation	
Wall-mounted and floor-standing enclosures	F-12
Wall-mounted and floor standing enclosures	
W600	F-13
Wall-mounted and floor standing enclosures + duct	
W600 + W300	F-14
Installation / Lifting accessories, IP degree level	F-15
Gland plates, cable running	F-16
Finishing parts, door accessories	F-17
Linery distribution and accessories	F-18



Presentation

Up to 160 A

Premounted metallic indoor enclosures can be ordered with a single catalog number.

An enclosure + modular rails + front plates + blanking plates + a plastic gland plate + an earth bar + a template for drilling wall-mounting holes.

One product reference = a complete modular enclosure ready to be equipped

- 160 A
- IP30
- IK07/08

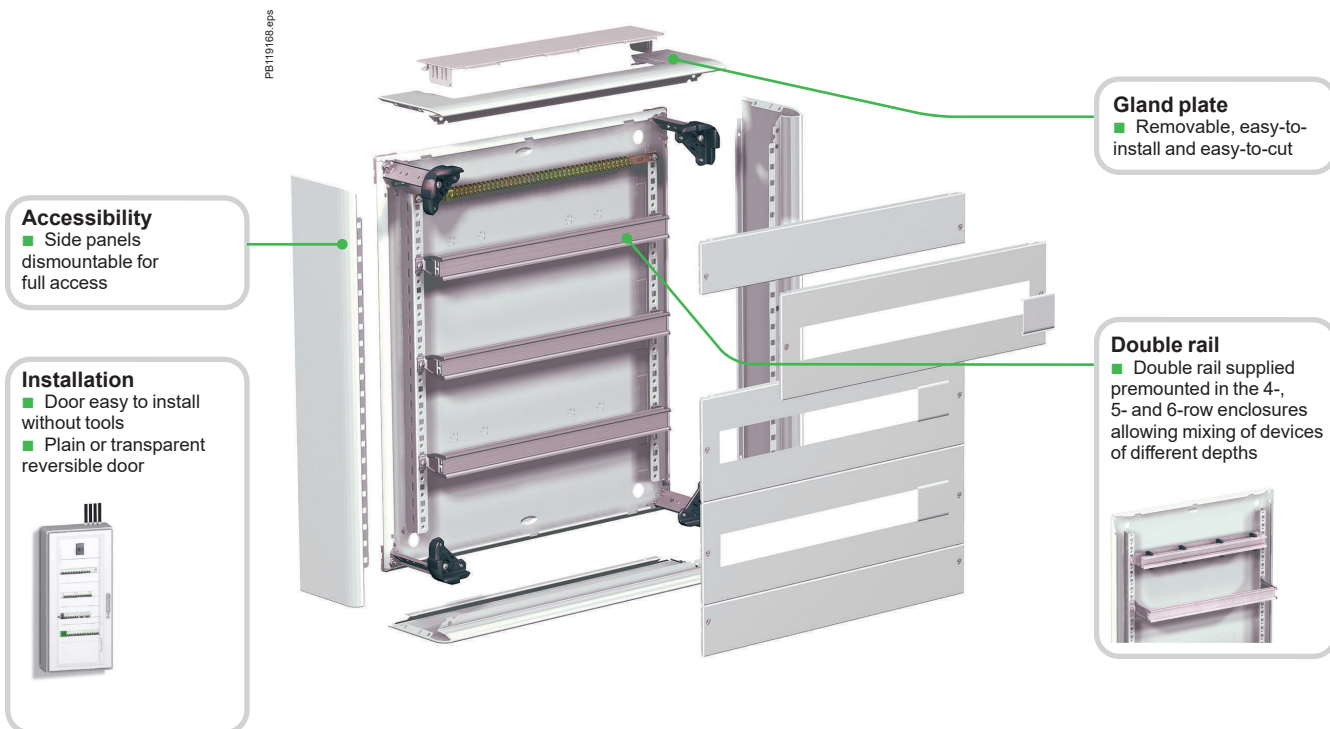

Description

Steel sheet metal with electrophoresis treatment + hot-polymerised polyester epoxy powder.

Enclosure:

- width: 555 mm
- height: 480 to 1080 mm
- depth: 157 mm without door / 186 mm with door
- properties of metal enclosures > page G-15.

Main characteristics

Pack enclosures

Rated operational current	160 A
Colour	White RAL 9003
Compliance with standards	EN 62208, IEC 61439-1-2-3, NFC 61-910
Degree of protection	IP30 without door, IP40 with door, IP41 with canopy + door, IP43 with canopy + door + door gasket
Degree of protection against mechanical impact	IK07 without door IK08 with door
Insulation	Class 1
Doors	<ul style="list-style-type: none"> ■ Plain or transparent, opening to right or left, 130° ■ By design, electrical continuity of moving parts (hinges...) ■ Supplied with a handle and keylock (key 405) ■ No possibility to install push buttons (distance behind door = 42 mm)
Mounting	Pack 160 enclosures easily integrated in using flush-mounting kit



The design of Pack 160 enclosures ensures easy device access and mounting. Optimised depth and an extra-thin door ensure perfect integration in all environments.

Models with 4, 5 and 6 rows are particularly well-suited for the incomer function:

- more space available for wiring of the incoming device
- optimised number of front plates.

Wall-mounted enclosures

Up to 160 A

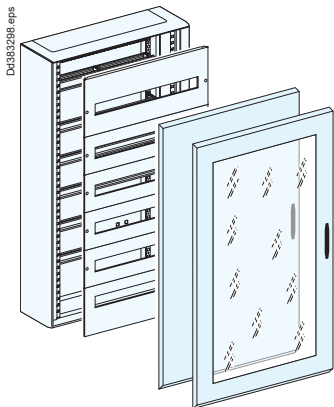
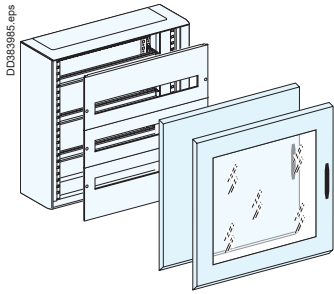

Wall-mounted enclosures for modular devices

Enclosures include:

- 1 modular rail per row (L= 24 modules of 18mm).
The recessed rail at the top of 4, 5, 6-row enclosures is adapted for NSXm installation or INS/INV160 (for NG160, you can order LVS03008) and supplied with another rail + raisers to complete the row with modular devices.
- 1 front plate with cut-out per row (height depending on model)
- 1 plastic gland plate
- divisible blanking plates: 3 for 2 and 3 rows enclosures, 6 for 4 to 6 rows enclosures
- earth bar with 40 straps

Doors are:

- reversible, opening to left or right,
- supplied with a handle and barrel with keylock (key 405)
- barrel locks and inserts

Enclosure W555

Nb. of rows	Nb. of vertical modules of 50 mm	Height in mm	Enclosure	Plain door	Transparent door
2	9	480	LVS08002	LVS08082	LVS08092
3	12	630	LVS08003	LVS08083	LVS08093
4	15	780	LVS08004	LVS08084	LVS08094
5	18	930	LVS08005	LVS08085	LVS08095
6	21	1080	LVS08006	LVS08086	LVS08096

Flush-mounting kit > see page F-7

	Other modular ≅ 63 A rails W555	Other devices			
	Fixed	Rear	Recessed	NSXm/NSXm Vigi	For NG160
Catalog numbers	LVS01260	LVS03004	LVS03003	LVS03018	LVS03008
Useful length	432 mm	432 mm	432 mm	432 mm	432 mm
9 mm modules number	48	48	48	48	48
Depth behind front plate	50 mm	80 mm	110 mm	76 mm	83 mm

Accessories

Allows adding modular devices to the row, if the LVS03008 or LVS03018 rail is used.

	Raiser for NSXm	Rail to be cut L1600	Rail + raiser for NG160
Catalog numbers	LVS04225	LVS04226	LVS04227 (2)
Characteristics	Set of 12 raisers (NSXm/NSXm Vigi) height 11 mm to be completed with LVS04226	Set of 2 rails, useful length: 1600 mm with 4 holes, dia. 6.4 mm, 450 mm between centres	Rail and 4 modular raisers (NG160) Useful length: 432 mm Raiser height: 33 mm

Other front plates W600

> page C-50 and page F-8.

Enclosure extension and metering

Functional units for extension enclosure

Up to 160 A

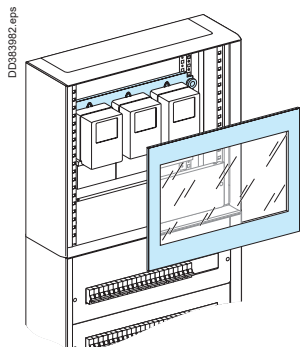

Enclosure extension for metering

Meters can be installed at different levels on the functional uprights of enclosures. Class 1: Depending on preferences and needs, meters can be installed directly on mounting plates equipped with earthing braids and combined with partitioning or front plates.

The mounting plates can be raised using M5 spacers.

Enclosure extension W555

Nb. of vertical modules of 50 mm	Height in mm	Enclosure extension		
		Enclosure	Plain door	Transparent door
9	480	LVS08012	LVS08082	LVS08092

Kilowatt-hour meters, Class 2

Class 1: Depending on preferences and needs, meters can be installed directly on mounting plates (without insulating plate) equipped with earthing braids of 6 mm² (LVS08910) and combined with partitioning or front plates. The mounting plates can be raised using M5 spacers > see page C-51.

Installation	In Pack wall-mounted enclosures		In an enclosure extension	
Device	Single-phase meters	3-phase meters	Single-phase meters	3-phase meters
Nb. of devices per row	3	2	3	2
Nb. of vertical modules	6	9	6	9
Mounting plate	-	LVS03152	-	LVS03152
Insulating plate	-	-	-	-
Horizontal partitioning ⁽¹⁾	LVS04333	LVS04333	-	-
Front plate transparent plain	LVS03343 or LVS03806	LVS03344	LVS03343 or LVS03806	LVS03344
Enclosure	Pack enclosure	Pack enclosure	LVS08012	-
Door	Depending on enclosure	Depending on enclosure	LVS08092 (transparent) or LVS08082 (plain)	LVS08093 (transparent) or LVS08083 (plain)
Earthing wire 6 mm ²	LVS08911	LVS08911	LVS08911	LVS08911
Combination uprights (set of 2)	-	-	LVS08817 ⁽²⁾	LVS08817 ⁽²⁾

(1) If not installed at the top of a Pack enclosure, order an addition horizontal partition (LVS04333).

(2) To make the combination more rigid, particularly during transport, it is mandatory to use a set of combination uprights secured to the rear of the switchboard.



Gland plates, trunk, canopy, gasket

Up to 160 A

Gland plates

Gland plates

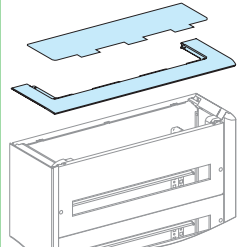
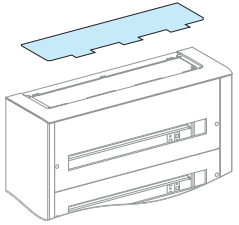
		
	Top or bottom plate with plastic gland plate	Metal gland plate
Catalog numbers	LVS08878	LVS08879
Characteristics	-	Plain metal gland plate

Trunking spreader

Trunking spreader

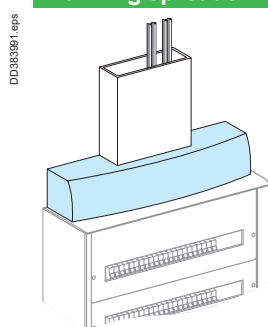

Catalog numbers	LVS08821
-----------------	-----------------

Canopy

Canopy to increase the IP value from IP30 to IP31 (1)

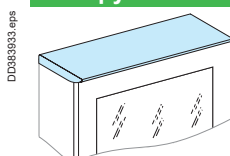

Catalog numbers	LVS08823
Characteristics	The canopy cannot be mounted on the existing top plate. It therefore comes with a special top plate that must be mounted in place of the existing top plate. The existing top plate is remounted at the bottom of the enclosure to allow cable entry and exit via the bottom. The addition of a canopy over a wall-mounted or floor-standing enclosure equipped with a door ensures compliance with the degree of protection IP41.

(1) With a door, the IP30 become IP40
With a door + canopy, the IP40 become IP41.

Gasket

Gasket for IP43

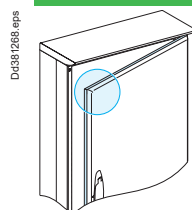

Catalog numbers	LVS08841
Characteristics	When the switchboard is equipped with a canopy, a gasket for the doors ensures compliance with the degree of protection IP43. L = 5.3 m

Up to 630 A

Combination uprights

Combination uprights

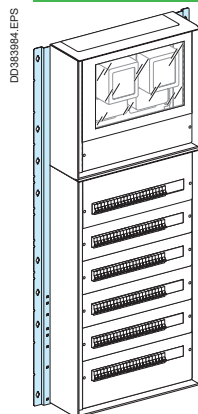

Catalog numbers	LVS08817
Characteristics	Set of 2 uprights. Particularly during transport, it is mandatory to use a set of combination uprights secured to the rear of the switchboard, to make the combination more rigid.

Wall mounting installation

Wall mounting

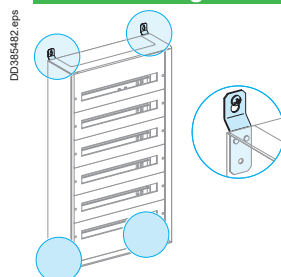

Catalog numbers	LVS08803
Characteristics	4 external wall-mounted brackets

Flush-mounting kit

Flush-mount kit

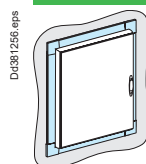

Catalog numbers	LVS08822
-----------------	-----------------

Blanking plates

Blanking plates



Catalog numbers	LVS03220	LVS03221
Characteristics	<ul style="list-style-type: none"> ■ Blanking strip ■ H = 46 mm, L = 1 m 	<ul style="list-style-type: none"> ■ Divisible ■ Set of 4 ■ H = 46 mm, L = 90 mm

Finishing parts > see page C-40

Up to 160 A

Cable-tie supports



> page C-42.

Cable running



> page C-44.

Earthing braid

The earthing braid is used to earth a door with devices.

	Earthing braid, 6 mm ²	Earthing wire, 6 mm ²
	 DD384005.eps	 DD384005.eps
Catalog numbers	LVS08910	LVS08911
Characteristics	The braid is equipped with a 4 mm diameter lug at one end and a 6 mm diameter lug on the other. L = 200 mm	Equipped with a 5 mm diameter lug at one end and a 6 mm diameter lug on the other. L = 200 mm

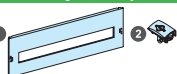
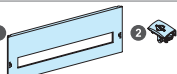
Spare-parts

Front plate (IP30)			
DD384499hb.eps		4 modules decentered plate	LVS01264
		<ol style="list-style-type: none"> 1 1 front plate 2 2 front plates locking mechanisms 	
DD384499hb.eps		4.5 modules decentered plate	LVS01265
		<ol style="list-style-type: none"> 1 1 front plate 2 2 front plates locking mechanisms 	
DD384488.EPS		Gland plate (IP30)	
		Cut-out gland plate for Pack 160 enclosure	LVS01020

Handle and padlocking

	Padlocking	RAL 7016 handle
	 nnc231101-p_2.eps	 mect0101_t.eps
Catalog numbers	LVS07938	LVS07931
Characteristics	For existing handle	Supplied with barrel lock (key no. 405) RAL 7016

Up to 160 A

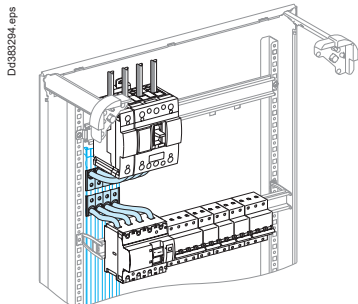

Presentation

At the head of a switchboard, the incoming device can supply by one of the following:

- busbars mounted in rear of the enclosure
- centralised distribution blocks
- row distribution blocks.

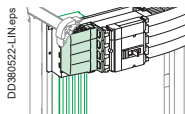
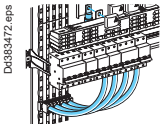
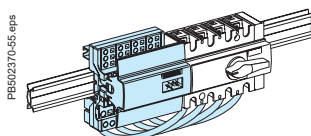
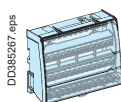
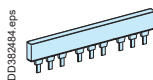
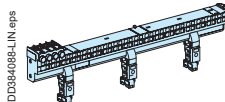
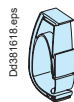
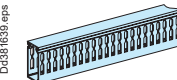
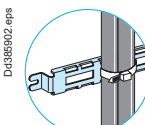
Linergy distribution		Catalog numbers	Pages
Linergy BW busbars 125 A			
 DD38522-LIN.eps	125 A	LVS04103, LVS04107, LVS04104, LVS04108, LVS01210, LVS01201	D-4
Prefabricated connections 125 to 160 A			
 Dd383472.eps	125 A	LVS04145	D-4, D-5
	160 A	LVS04146, LVS04147, LVS04148, LVS04151	
Linergy DX distribution block			
 PE502370-55.eps	63 A	LVS04040, LVS04041 (4P)	D-10, D-11
	125 A	LVS04045, LVS04047 (4P)	
	160 A	LVS04031, LVS04149, LVS04046	
Linergy DS distribution block			
 DD385267.eps	100 A	LGY410028, LGYN1007 LGYN12512	D-14, D-15
	125 A	LGY112510, LGY412548, LGY412560, LGYN12515	
	160 A	LGY116013, LGY416048	
Linergy FH comb busbars			
 DD382644.eps			D-18 to D-22
Linergy FM distribution block			
 DD384085-LIN.eps	63 A	LVS04008 (4P)	D-16, D-17
	80 A	LVS04004 (4P)	
Cable straps			
 Dd381618.eps		LVS04239, LVS04243	C-43
Trunking			
 Dd381639.eps	80 x 60 mm support external brackets	LVS04257, LVS04255, LVS04206	C-43, C-42
Cable-tie supports			
 Dd385902.eps		LVS08867	C-43



Dimensions

Up to 160 A

Wall-mounted enclosures of 2 and 3 rows

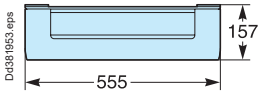
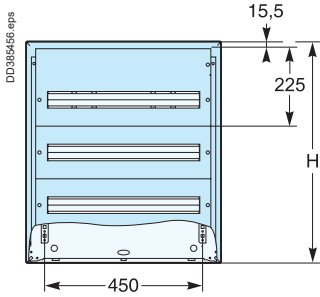

Wall-mounted enclosures of 4, 5 and 6 rows

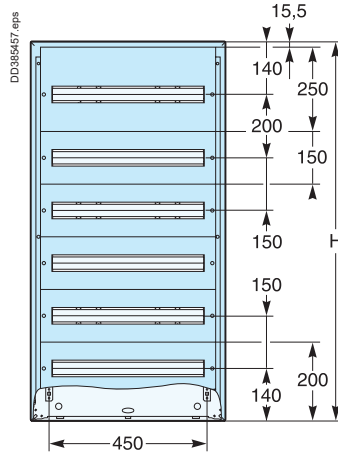

Door

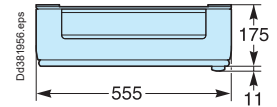
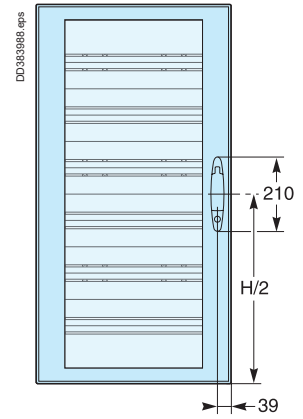

Nb. of rows	Nb. of vertical modules of 50 mm	Height in mm
2	9	480
3	12	630
4	15	780
5	18	930
6	21	1080

Useful depth behind front plate Cable running

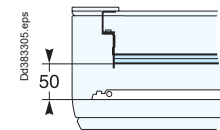
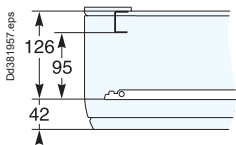

Supplied modular rail.

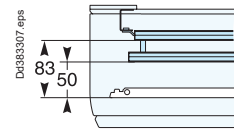

Upper rail in wall-mounted enclosures of 4, 5 and 6 rows.

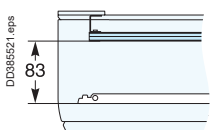
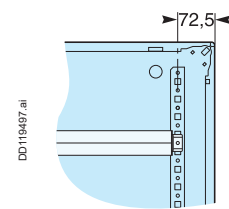

Rail cat. no. LVS03008.

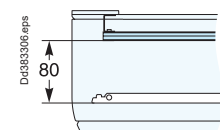

Rail cat. no. LVS03004.

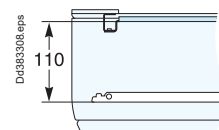

Rail cat. no. LVS03003.

Rear upright

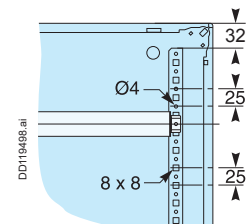

Up to 160 A

Cable entry

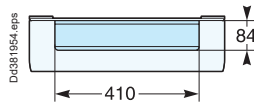

Trunking spreader

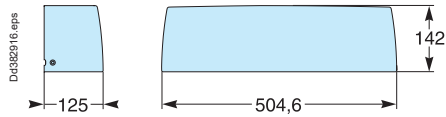

Wall-mounted installation

Nb. of rows	H1	H2
2	396	546
3	546	696
4	696	846
5	846	996
6	996	1146

Screws

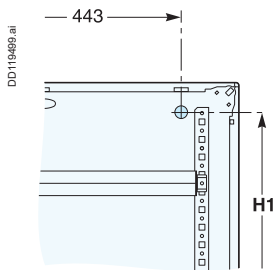

External brackets

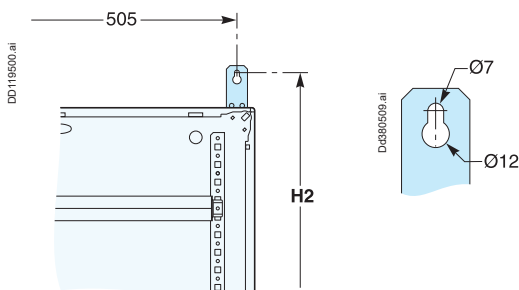

Presentation

Wall-mounted and floor-standing enclosures

Up to 250 A

Metallic indoor wall-mounted and floor-standing enclosures delivered in a kit with a limited number of references. Commercial buildings: hotels, offices, shops, etc.

Wall-mounted and floor-standing enclosures delivered flat: total accessibility
Designed for electrical continuity

- 250 A
- IP30/IP4X
- IK07/08
- Seismic characteristics 2,5G

- Free space**
- H = 300 mm for incomer device installation at your choice

- Gland plate**
- Dismountable and cuttable
- 

- Quick fastening on hook-on rail**
- Easy wall mounting
- 

- Total accessibility**
- Dismountable side panels: flat wiring

- Comfortable wiring**
- Steel sheet metal with inside painting, not aggressive for the hands of the wiring staffs

- Common accessories with PrismaSeT G**

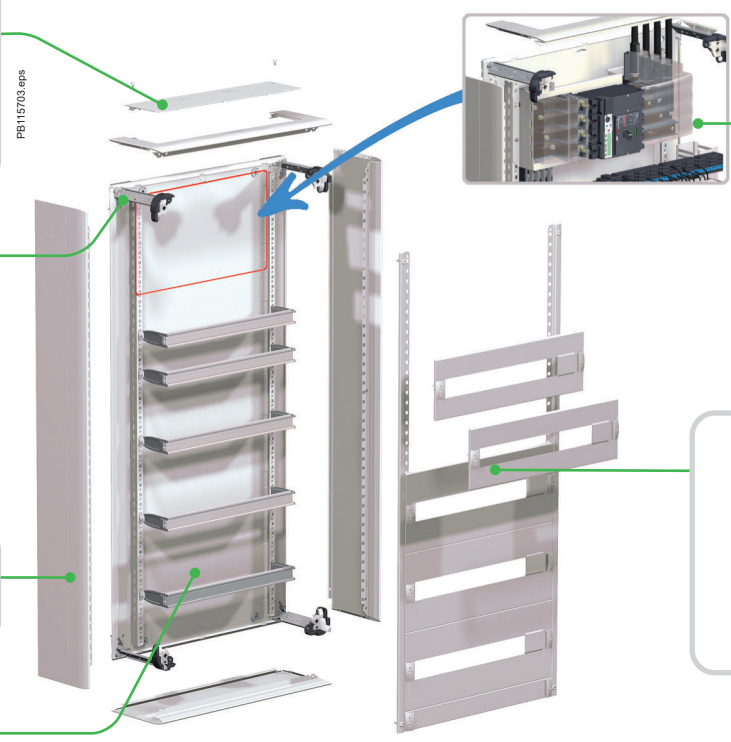

- Ergonomics and safety**
- Easy panel handling thanks to the ergonomic gripper
 - Legible "Open/closed" positions of front plate
 - Integrated front plate sealing function
- 



Description

Steel sheet metal with electrophoresis treatment + hot-polymerised polyester epoxy powder.

Enclosure:

- width: 595 mm
- height: 630 to 1830 mm
- depth: 205 mm without door / 261 mm with door (including the handle : 16.6 mm)
- properties of metal enclosures > page G-15

Main characteristics

PrismaSeT G - Pack 250 enclosures, IP30/IP4X

Rated operational current	In = 250 A, Isc = 50 kA, Icw = 25 kA rms/1 s, Ipk = 52.5 kA
Colour	White colour RAL 9003
Standards conformity	EN 62208, IEC 61439-1-2-3
Degree of protection	IP30 without door IP40 with door IP41 with canopy + door IP43 with canopy + door + gasket
Degree of protection against mechanical impacts	IK07 without door IK08 with door (transparent) IK10 with plain door
Seismic characteristics	2.5G without accessory (IEC 60068-2-57)
Isolation	Class 1
Doors	<ul style="list-style-type: none"> ■ Plain or transparent, opening to right or left, 130° ■ By design, electrical continuity of moving parts ■ Supplied with a handle and keylock (key 405) ■ Distance behind door = 58 mm
Mounting	Surface mounting, floor-standing, flush-mounting via a kit

PrismaSeT G - Pack 250, IP30/IP4X enclosures

Wall-mounted and floor standing enclosures

W600

Up to 250 A

Each enclosure is delivered with H = 150 mm front plates and rails for modular devices (quantity according the number of rows) and a plastic gland plate.

Wall-mounted and floor standing enclosures W600

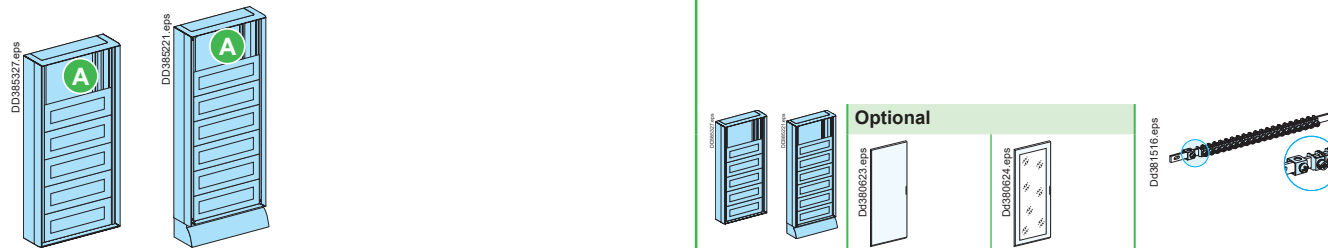

Capacity		Nb of row + Zone A to complete height 300 mm (6 modules)	H x W x D (in mm)	Wall-mounted and floor-standing	Optional		Earth bar with 40 staples (16 mm ²) and 1 incoming terminal (35 mm ²)
9-mm pitches	18-mm modules				Plain door (1)	Transparent door (1)	
Wall-mounted							
96 + 96	48 + 48	2R + A	630 x 600 x 205	LVS08064	LVS08124	LVS08134	1
144 + 96	72 + 48	3R + A	780 x 600 x 205	LVS08065	LVS08125	LVS08135	1
192 + 96	96 + 48	4R + A	930 x 600 x 205	LVS08066	LVS08126	LVS08136	1
240 + 96	120 + 48	5R + A	1080 x 600 x 205	LVS08067	LVS08127	LVS08137	2
288 + 96	144 + 48	6R + A	1230 x 600 x 205	LVS08068	LVS08128	LVS08138	2
336 + 96	168 + 48	7R + A	1380 x 600 x 205	LVS08069	LVS08222	LVS08232	2
Floor-standing							
336 + 96	168 + 48	7R + A	1580 x 600 x 205	LVS08072	LVS08222	LVS08232	2
384 + 96	192 + 48	8R + A	1730 x 600 x 205	LVS08073	LVS08223	LVS08233	2
432 + 96	216 + 48	9R + A	1880 x 600 x 205	LVS08074	LVS08224	LVS08234	2

(1) Reversible doors, opening to left or right, equipped with a handle and keylock (key 405).

Zone A to complete depending on the incoming device

Zone A (H = 300 mm) to complete

	Zone A incoming device	Cat. no.	Composition
<p>DD385339 eps</p> <p>LVS03260</p>	Modular devices ≤ 40 A (2 rows)	LVS03001 x 2 + LVS03203 x 2	2 modular rails 2 modular front plates (H = 2 x 150 mm)
	Modular devices ≤ 63 A (1 row)	LVS03001 + LVS03204 + LVS03802	1 modular rail 1 modular front plate H = 200 mm 1 plain front plate H = 100 mm
	ComPacT INS-INV40-160, NG125, Vigi NG125, C120, Vigi C120 + Modular devices Acti 9	LVS03260	1 modular rail + 1 modular front plate H = 250 mm + 1 plain front plate H = 50 mm
	NSXm or NSXm Vigi + modular devices	LVS03261	1 adjustable modular rail + 1 modular rail + 2 raisers (1) + 1 modular front plate H = 250 mm + 1 plain front plate H = 50 mm
<p>DD385340 eps</p> <p>LVS03264</p>	ComPacT INS/INV250 horizontal fixed, toggle	LVS03264	1 mounting plate + 1 front plate INS/INV250 H = 200 mm + 2 plain front plates H = 50 mm
	ComPacT NSX100/250 horizontal fixed, toggle	LVS03030 + LVS03232 + LVS03802	1 mounting plate + 1 front plate with cut-out H = 200 mm + 1 plain front plate H = 100 mm
	VigicomPacT NSX100/250 horizontal fixed, toggle	LVS03033 + LVS03292 + LVS03802	1 mounting plate + 1 front plate with cut-out H = 200 mm + 1 plain front plate H = 100 mm
	FuPacT ISFT160, horizontal fixed	LVS03121 + LVS03326 + LVS03801 + LVS03802	1 mounting plate + 1 front plate with cut-out H = 150 mm + 1 plain front plate H = 50 mm + 1 plain front plate H = 100 mm
	FuPacT ISFT250, horizontal fixed	LVS03124 + LVS03328 + LVS03801	1 mounting plate + 1 front plate with cut-out H = 250 mm + 1 plain front plate H = 50 mm

(1) To add modular devices to the row.

Wall-mounted and floor standing enclosures + duct

W600 + W300

Up to 250 A

Wall-mounted and floor standing enclosures W600 + Ducts W300

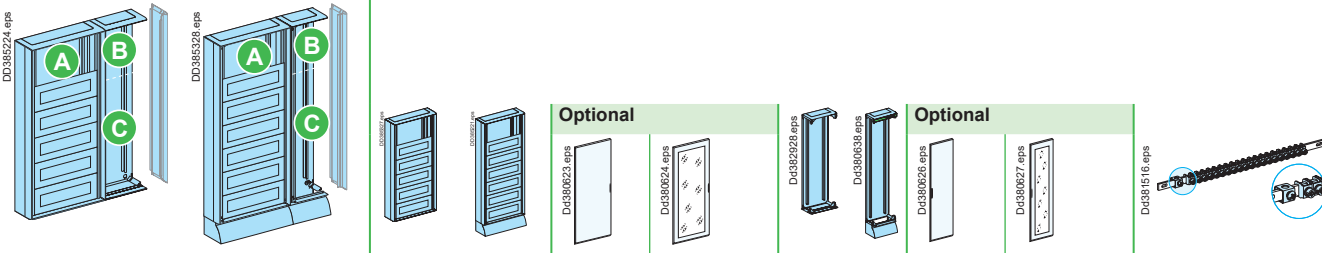

Nb of row + Zone A to complete height 300 mm (6 modules)	Height in mm	Wall-mounted and floor-standing	Plain door (2)	Transparent door (2)	Ducts (1)	Plain door	Transparent door	Earth bar with 40 staples
Wall-mounted								
2R + A	630	LVS08064	LVS08124	LVS08134	LVS08174	LVS08184	-	1
3R + A	780	LVS08065	LVS08125	LVS08135	LVS08175	LVS08185	-	1
4R + A	930	LVS08066	LVS08126	LVS08136	LVS08176	LVS08186	-	1
5R + A	1080	LVS08067	LVS08127	LVS08137	LVS08177	LVS08187	LVS08197	2
6R + A	1230	LVS08068	LVS08128	LVS08138	LVS08178	LVS08188	LVS08198	2
7R + A	1380	LVS08069	LVS08222	LVS08232	LVS08179	LVS08282	LVS08292	2
Floor-standing								
7R + A	1580	LVS08072	LVS08222	LVS08232	LVS08272	LVS08282	LVS08292	2
8R + A	1730	LVS08073	LVS08223	LVS08233	LVS08273	LVS08283	LVS08293	2
9R + A	1880	LVS08074	LVS08224	LVS08234	LVS08274	LVS08284	LVS08294	2

(1) Supplied with a combination kit for enclosure + duct association.
 (2) Reversible doors, opening to left or right, equipped with a handle and keylock (key 405).

Zone A to complete with 2 rails (Ref. LVS03001) + 2 front plates (Ref. LVS03203)

Zone B to complete (H = 450 mm) with the incoming device

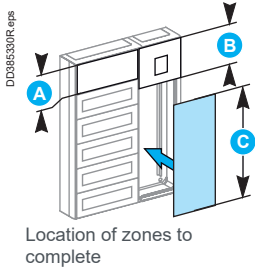
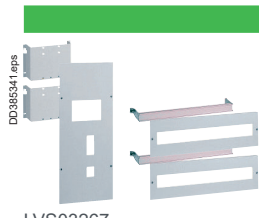
Incoming device Zone B	Cat. no.	Composition
ComPacT INV250	LVS03267	1 mounting plate INV 1 front plate INV 2 modular rails L = 600 mm 2 front plates L = 600 mm
ComPacT NSX100/250 Vertical fixed, toggle	LVS03050 + LVS03253	1 mounting plate 1 front plate
FuPacT ISFT160 Vertical fixed, toggle	LVS03123 + LVS03327 + LVS03813	1 mounting plate 1 front plate H = 300 mm 1 front plate H = 150 mm
FuPacT ISFT250 Vertical fixed, toggle	LVS03125 + LVS03329	1 mounting plate 1 front plate

Zone C to complete

The table below gives the cat. no of plain front plates to be installed to complete the duct.

Cat. no. of the duct	Dimensions of zone C to complete (mm)	Cat. no.
LVS08174	150	LVS03813 x 1
LVS08175	300	LVS03816 x 1
LVS08176	450	LVS03817 x 1
LVS08177	600	LVS03816 x 2
LVS08178	750	LVS03815 x 3
LVS08179	900	LVS03816 x 3
LVS08272	900	LVS03817 x 2
LVS08273	1050	LVS03817 x 2 + LVS03813 x 1
LVS08274	1200	LVS03816 x 4

Other combinations are possible to complete the zone C, including 7 heights of 300 mm width front-plates:

Height (mm)	Cat. no.
50	LVS03811 (3)
100	LVS03812
150	LVS03813
200	LVS03814
250	LVS03815
300	LVS03816
450	LVS03817

(3) Mounting 1 module front plate (LVS03811) on the extreme top or bottom is not allowed.

Up to 250 A

Installation possibilities

Switchboards can be mounted on a wall in three manners: with the hook-on rail system, via the inside of the enclosure or using external wall-mounted brackets. Combined enclosures can be mounted using the lifting/reinforcement crossmembers set of two lifting/reinforcement cross-members.

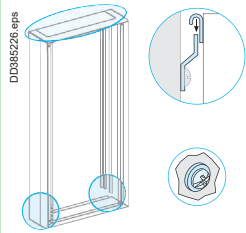
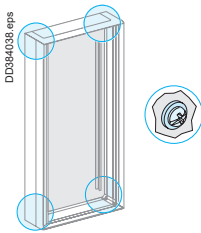
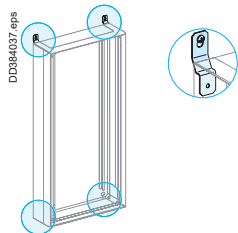

	Hook-on rail system	Mounting via the inside	Mounting using the external wall-mounted brackets
			
Catalog numbers	Delivered with the enclosure	-	LVS08804
Characteristics	The enclosure comes with 2 cross-members secured to the back of the enclosure (top and bottom) and a support rail (with levelling adjustment) for screw-mounting on the wall. The enclosure is easily mounted on the hook-on rail system. End the fixation with 2x 8mm diameter screws, at the bottom of enclosure	The enclosure can be mounted through the spacers in the 4 holes provided on the enclosure using 8 mm diameter screws (2 knockouts can be removed if necessary to provide 2 other holes).	4 external wall-mounted brackets.

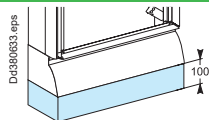
Plinth raiser

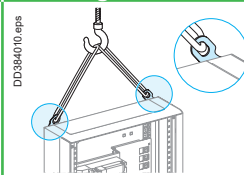
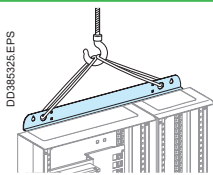

Plinth raiser	
	
Catalog numbers	LVS08805 LVS08807
Characteristics	For basic floor-standing enclosure or extension W = 600 mm For a duct W = 300 mm

Lifting accessories

The lifting rings are used to move a single wall-mounted or floor-standing enclosure. For combined enclosures, use the lifting/reinforcement cross-members (see below).

	2 lifting rings for single wall-mounted or floor-standing enclosures	Lifting/reinforcement cross-members for combined enclosures
		
Catalog numbers	LVS08801	LVS08812
Characteristics	 Set of two lifting rings	 Have 2 types of holes: for lifting and for mounting on a wall

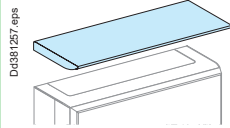
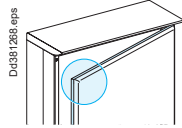
Accessories to increase the degree of protection IP

	Canopy to increase the IP value from IP30 to IP31 (1)	Gasket for the door to increase the IP value from IP31 to IP43
		
Used with	1 wall-mounted enclosure	1 wall-mounted enclosure + 1 duct (2)
		
Catalog numbers	LVS08830	LVS08841
Designation	The addition of a canopy over a wall-mounted or floor-standing enclosure equipped with a door ensures compliance with the degree of protection IP41.	When the switchboard is equipped with a canopy, a gasket for the doors ensures compliance with the degree of protection IP43. L = 5.3 m

(1) With a door, the IP30 become IP40
With a door + canopy, the IP40 become IP41.
(2) Whatever the duct position.



Gland plates, cable running

Up to 250 A

Gland plates

Enclosures (wall-mounted, floor-standing, ducts) are supplied with a plastic gland plate installed on the top or bottom for wall-mounted enclosures and the top for floor-standing enclosures.

The existing plastic gland plate can be replaced by this metal gland plate or by an interface plate with cut-out.

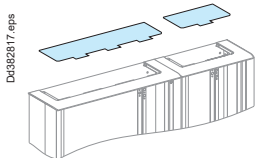
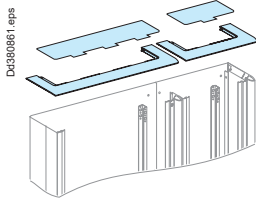
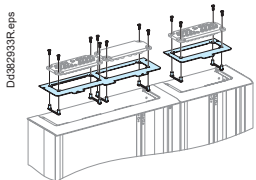
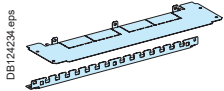
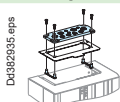
Wall-mounted and floor-standing W600 and duct W300		Pages
Plain metal gland plates		
 Dd382817.eps		E-12
Metal plates with cut-outs + plastic gland plates		
 Dd383081.eps		E-12
Metal plate with cut-outs		
 Dd382933R.eps		E-12
Metal gland plates for plinth		
 Dd112423k.eps		E-7
Gland plates, plain with knockouts or membrane-type		
 Dd382935.eps		E-12

Cable running

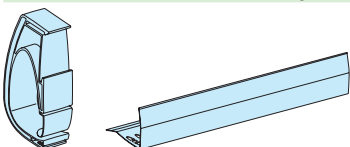
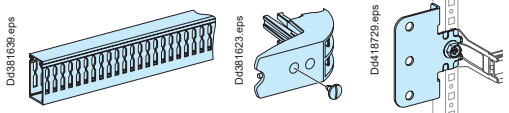
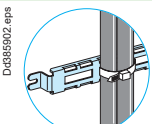
Cable running		Pages
Horizontal/vertical cable straps + covers		
		C-43
Horizontal/vertical trunkings + supports		
 Dd381639.eps, Dd381623.eps, Dd418729.eps		C-43, C-46
Cable-tie supports		
 Dd385902.eps		C-43

Up to 250 A

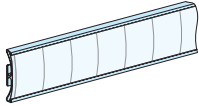
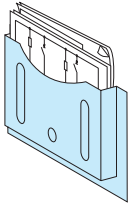
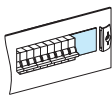
Labels	Pages
Adhesive labels	
	C-41
Adhesive drawing holder	
	C-41
Blanking plates modular device (blanking strip or divisible)	
	F-7

Door handles and padlocking *See page E-13*

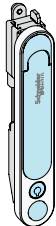
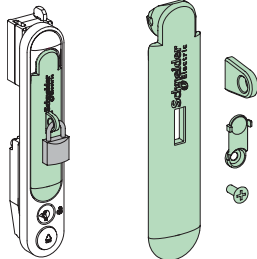
	Rotary handle	Padlocking
	 mz23131101_1.eps	 mz23131101-p_2.eps
Catalog numbers	LVS01218	LVS07938
Characteristics	New rotary handle - RAL 9003	For new rotary handle

Earthing braid

The earthing braid is used to earth a door or partial door with devices.

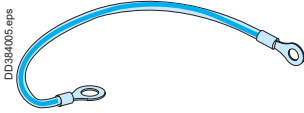
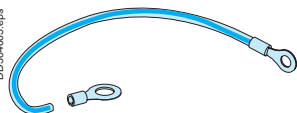
	Earthing braid, 6 mm ²	Earthing wire, 6 mm ²
	 DD384405.eps	 DD384405.eps
Catalog numbers	LVS08910	LVS08911
Characteristics	Equipped with a 4 mm diameter lug at one end and a 6 mm diameter lug on the other L = 200 mm	Equipped with a 5 mm diameter lug at one end and a 6 mm diameter lug on the other. L = 200 mm

Spare parts

> see pages E-14 to E-16.

Dimensions

> see page E-17.



Lineryg distribution and accessories

Up to 250 A

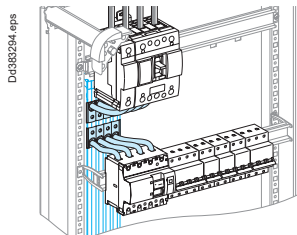

Presentation

At the head of a switchboard, the incoming device can be supplied by one of the following:

- busbars mounted in rear of the enclosure
- centralised distribution blocks
- row distribution blocks.

Lineryg distribution		Catalog numbers	Pages
Lineryg BW insulated busbars up to 250 A			
<p>DD385344.eps</p>	125 A	LVS04103, LVS04104, LVS04107, LVS04108	D-4
	160 A	LVS04111, LVS04121, LVS04116, LVS04126	
	250 A	LVS04112, LVS04122, LVS04117, LVS04127	
Lineryg BS rear busbars			
<p>DD385346.eps</p>	160 A	LVS04161, LVS04171	D-6
	250 A	LVS04162, LVS04172	
	Support	LVS04191	
Lineryg BS multi-stage distribution block up to 250 A / Lineryg BS multi-stage busbars up to 250 A			
<p>DD381344-LIN_R.eps</p>	Complete		D-7, D-8
	160 A	LVS04052	
	250 A	LVS04053	
	To be assembled		
	160 A	LVS04161, LVS04171	
	250 A	LVS04162, LVS04172	
Lineryg DP quick distribution blocks 160 A / Lineryg DP quick distribution blocks 250 A			
<p>DD435226.eps</p>	NSXm up to 160 A	LVS04038 (3P)	D-13
	NSXm up to 160 A	LVS04039 (4P)	
<p>DD385347_LinerygDP.eps</p>	NSX100 to 250 A	LVS04033, LVS04155 (3P)	D-12
	NSX100 to 250 A	LVS04034, LVS04156 (4P)	
Lineryg DX distribution block			
<p>PE602370-55.eps</p>	63 A	LVS04040, LVS04041 (4P)	D-10, D-11
	125 A	LVS04045 (4P)	
	160 A	LVS04031 (1P), LVS04046 (4P)	

Note: see pages C-49, C-50 for prefabricated connections.

Up to 250 A

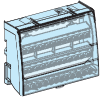
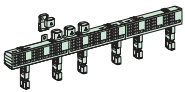
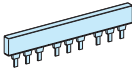
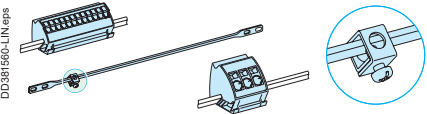
Linergy distribution		Catalog numbers	Pages
Linergy DS screw distribution blocks			
 <small>DD305267.eps</small>	100 A	LGY410028	D-14, D-15
	125 A	LGY112510, LGY416048, LGY412560	
	160 A	LGY116013, LGY412548	
	250 A	LGY125014	
Linergy FM quick device feeders			
 <small>DD301674-LIN.eps</small>	63 A	LVS04008 (4P)	D-16, D-17
	80 A	LVS04004 (4P)	
	160 A	LVS04018 (4P)	
	200 A	LVS04012 (1P+N), LVS04013 (3P), LVS04014 (4P)	
Horizontal comb busbars Linergy FH			
 <small>DD302484.eps</small>			D-18 to D-22
Linergy TB earth bar, neutral bar			
 <small>DD301560-LIN.eps</small>		LVS04201, LVS04214, LVS04215, LVS04200, LVS04202, LVS04210	D-23

Note: see pages C-49, C-50 for prefabricated connections.

Additional information

Contents

Electrical characteristics

Designing PrismaSeT power circuits	
Presentation and approach	G-2
Designing connections ≤ 630 A	
Device connections	G-3
ComPacT circuit breakers NSX100 to 630	G-4
Incoming connection block and power supply block on Linergy BW busbars	G-6
Tubular lugs, Bimetal lugs	G-6
Designing the PEN conductor	
Power circuit	G-7
Connection of power cables	G-8

Practical information

Tools required for mounting and connection	G-9
---	------------

Standards

PrismaSeT G seismic Standards	G-10
	G-12

Enclosure characteristics

Selection of enclosures according to the premises	G-18
--	-------------

Thermal characteristics

Thermal management of switchboards	
General	G-26
Comparative method	G-28
Example	G-30
Charts	G-31
Ventilation	G-32
Heating	G-33

Designing PrismaSeT power circuits

Presentation and approach

The PrismaSeT G system takes into account the installation and connection conditions of Schneider Electric devices.
The entire installation complies with standard IEC 61439-1 and 2 of tested switchboard.

PB115625_66.eps



Electrical characteristics

In the following pages you will find a number of examples, validated for PrismaSeT switchboards, intended to assist in determining the busbars as well as the upstream and downstream connections for the installation.

The examples assume that the devices have already been selected.

A complete process involves a number of steps before making final choices (transformer, conductors, protection, etc.).

Schneider Electric offers a number of tools to assist in designing a complete installation (technical guides, software).

Busbar sizing

The factors that must be taken into account in determining the size of busbars include:

- the diversity factor.

Not all the loads supplied by a set of busbars are used at full rated load or at the same time. The diversity factor is the means to determine the maximum load current used to size the busbars.

Standard IEC 61439-1 and 2 §4.7 specifies the table below:

Number of circuits	Rated diversity factor (RDF)
2 and 3	0.9
4 and 5	0.8
6 and 9	0.7
10 and more	0.6

- the degree of protection IP.
- the ambient temperature around the switchboard.

Supply of devices for outgoers ≤ 630 A

Flexible copper bars with an insulating cover.

To determine the required sizes for flexible bars, see the tables starting on > see page G-3 which indicate the correct size for each type of connected device.

- an insulated flexible bar (not connected) must meet standards IEC 60243-1, (dielectric, > see page G-3), NFC 32201 (insulation) and IEC 60332-1 (fire)
- a flexible bar connected to a device in an enclosure must comply with standard IEC 61439-1 and 2.

Cables

To determine the cables required, see the tables. on > see page G-5.

They can be used to determine:

- the size of cables as a function of:
 - the circuit breaker rating
 - the current
 - the ambient temperature around the switchboard
- the permissible current for individually tied cables or touching cables as a function of:
 - the size of the cables
 - the degree of protection for the switchboard.



Rapsody software

Easy design with

> see page B-20

Designing connections ≤ 630 A

Device connections

Electrical characteristics

Flexible copper bars with an insulating sheath

Switchboards that comply with standard IEC 61439-1 and 2

It is imperative to use the values indicated below that have been validated for the installation of devices in PrismaSeT switchboards.

The parameters determining the size of flexible bars are:

- the environment in which the devices are installed:
 - position in the enclosure
 - dimensions of other conductors in the circuit
 - ambient temperature around the switchboard
- the characteristics of the connected devices:
 - device heat losses
 - the type of installation (horizontal or vertical)
 - the type of device (fixed or withdrawable).

Only the equipment manufacturer with in-depth knowledge on:

- the characteristics of the installed devices
- the configuration of the installation in the enclosure can provide the correct sizes of flexible bars for a given permissible current.

Insulated flexible bars brings flexibility, easy and quick installation.

Insulated flexible bars are better solution than cables:

- better insulation temperature withstand (125 °C for bars, 105 °C for cables) and a larger exchange surface for an equivalent size, i.e. a smaller size for a given current
- greater rigidity offering better electrodynamic characteristics for short-circuit currents
- no intermediate parts (lugs) for a direct connection between the device and the busbars therefore less temperature rise and less risk of error
- fast implementation of prefabricated connections already cut to length, formed and drilled.

Technical characteristics

- thickness of the insulation: variable depending on the bar size, 2 mm on average
- rated insulation level $U_i = 1000$ V
- impulse withstand voltage $U_{imp} = 12$ kV
- maximum withstand temperature of insulating material = 125 °C.

Connection

In all enclosures with IP ≤ 55

- the switchboard internal temperature is 60 °C
- the withstand temperature of the insulating material is 125 °C.

If the withstand temperature of the insulation is only 105 °C, use the next largest flexible bar.

The bar sizes (S) indicated below take into account the derating curves of devices.

Connection of devices and distribution blocks to busbars

Device	INS-INV125	INS-INV160	INS-INV250	INS-INV320 INS-INV400	INS-INV500 INS-INV630	INF250 ISFT250	INF400 ISFT400	INF630 ISFT630
S (mm)	20 x 2	20 x 2	20 x 3	32 x 5	32 x 6	24 x 5	32 x 5	32 x 8

To connect a ComPacT NSX250 to Linergy BW busbars, use a 24 x 5 mm flexible bar (LVS04746).

Device	Linergy FM distribution block (200 A)
S (mm)	20 x 3

Disconnectors, terminal blocks, connections, busbars to busbars

I max. (60 °C)	200 A	250 A	400 A	400 A	480 A	520 A	580 A	660 A
S (mm)	20 x 2	20 x 3	24 x 5	24 x 5	24 x 6	32 x 5	32 x 6	32 x 8

Note: The values indicated above have been validated for PrismaSeT switchboards.

Designing connections ≤ 630 A

ComPacT circuit breakers NSX100 to 630

Electrical characteristics

ComPacT NSX100 to NSX250

Insulated flexible copper bars

Devices		Rated current of a circuit I_{nc} (A)					
		Ambient temperature around the switchboard					
		25 °C	30 °C	35 °C	40 °C	45 °C	50 °C
IP ≤ 55							
NSX100 TMD-TMG	Size per phase	20 x 2	20 x 2	20 x 2	20 x 2	20 x 2	20 x 2
	I_{nc} (A)	100	97.5	95	92.5	90	85
NSX125 TMD-TMG	Size per phase	20 x 2	20 x 2	20 x 2	20 x 2	20 x 2	20 x 2
	I_{nc} (A)	125	122	119	116	113	100
NSX160 (1) TMD-TMG	Size per phase	20 x 3	20 x 3	20 x 3	20 x 3	20 x 3	20 x 3
	I_{nc} (A)	160	156	152	147	144	140
NSX250 (1) TMD-TMG	Size per phase	20 x 3	20 x 3	20 x 3	20 x 3	20 x 3	20 x 3
	I_{nc} (A)	250	244	238	231	225	198
NSX100 STR	Size per phase	20 x 2	20 x 2	20 x 2	20 x 2	20 x 2	20 x 2
	I_{nc} (A)	100	100	100	100	100	100
NSX160 STR	Size per phase	20 x 3	20 x 3	20 x 3	20 x 3	20 x 3	20 x 3
	I_{nc} (A)	160	160	160	160	160	160
NSX250 (2) STR	Size per phase	20 x 3	20 x 3	20 x 3	20 x 3	20 x 3	20 x 3
	I_{nc} (A)	250	250	237.5	237.5	225	225

ComPacT NSX400 to NSX630

Insulated flexible copper bars

Devices		Rated current of a circuit I_{nc} (A)					
		Ambient temperature around the switchboard					
		25 °C	30 °C	35 °C	40 °C	45 °C	50 °C
IP ≤ 55							
NSX400B/F/N/H/S/L fixed	Size per phase	32 x 5	32 x 5	32 x 5	32 x 5	32 x 5	32 x 5
	I_{nc} (A)	400	400	400	390	380	370
NSX400B/F/N/H/S/L with Vigi or NSX Vigi (ELCB) 400 B/F/N/H/S/L	Size per phase	32 x 5	32 x 5	32 x 5	32 x 5	32 x 5	32 x 5
	I_{nc} (A)	400	390	380	370	360	350
NSX400B/F/N/H/S/L withdrawable	Size per phase	32 x 5	32 x 5	32 x 5	32 x 5	32 x 5	32 x 5
	I_{nc} (A)	400	390	380	370	360	350
NSX630B/F/N/H/S/L fixed	Size per phase	32 x 6	32 x 6	32 x 6	32 x 6	32 x 6	32 x 6
	I_{nc} (A)	630	615	600	585	570	550
NSX630B/F/N/H/S/L with Vigi or withdrawable or NSX Vigi (ELCB) 630 B/F/N/H/S/L	Size per phase	32 x 8	32 x 8	32 x 8	32 x 8	32 x 8	32 x 8
	I_{nc} (A)	570	550	535	520	505	490

Note: the values indicated above have been validated for PrismaSeT switchboards.

(1) For a withdrawable NSX160 or NSX250 equipped with a Vigi or NSX Vigi (ELCB) or an insulation-monitoring module, multiply the I_n values by 0.9.

(2) For a withdrawable NSX250 equipped with a Vigi or NSX Vigi (ELCB) or an insulation-monitoring module, multiply the I_n values by 0.86.

Designing connections ≤ 630 A

ComPacT circuit breakers NSX100 to 630

ComPacT circuit breakers NSXm up to 160

Electrical characteristics

Cables

Schneider Electric provides cabling recommendations according to the rating of the circuit breaker.

The size of cables must be selected according to:

- the level of current
- the ambient temperature around the conductors
- the degree of protection for the switchboard.

When mounting Schneider Electric prefabricated connections, short terminal shields can be used or not if the function is already integrated in prefabricated connections.

Note: For some devices, it is recommended to use Schneider Electric prefabricated connections. If not, switchgears must be equipped with long terminal shields for personnel safety.

ComPacT NSX100 to NSX250

Copper cable, withstand temperature = 105 °C

Devices		Rated current of a circuit I_{nc} (A)					
		Ambient temperature around the switchboard					
		25 °C	30 °C	35 °C	40 °C	45 °C	50 °C
IP ≤ 55							
NSX100 TMD-TMG	Size per phase (mm ²)	50	50	50	50	50	50
	I_{nc} (A)	100	97.5	95	92.5	90	85
NSX125 TMD-TMG	Size per phase (mm ²)	70	70	70	70	70	70
	I_{nc} (A)	125	122	119	116	113	100
NSX160 (1) TMD-TMG	Size per phase (mm ²)	95	95	95	95	95	95
	I_{nc} (A)	160	156	152	147	144	140
NSX250 (1) TMD-TMG	Size per phase (mm ²)	120	120	120	120	120	120
	I_{nc} (A)	250	244	238	231	225	198
NSX250 (1) Withdrawable TMD-TMG	Size per phase (mm ²)	120	120	120	120	120	120
	I_{nc} (A)	238	231	223	215	204	195
NSX100 STR	Size per phase (mm ²)	50	50	50	50	50	50
	I_{nc} (A)	100	100	100	100	100	100
NSX160 STR	Size per phase (mm ²)	95	95	95	95	95	95
	I_{nc} (A)	160	160	160	160	160	160
NSX250 (2) STR	Size per phase (mm ²)	120	120	120	120	120	120
	I_{nc} (A)	250	250	237.5	237.5	225	225

ComPacT NSX400 to NSX630

In case of cable connection

Cable connection is not recommended if the cable sizes are too large. Choose insulated flexible bar (see table opposite and list of insulated flexible bars).

(1) For a withdrawable NSX160 or NSX250 equipped with a Vigi or an insulation-monitoring module, multiply the I_n values by 0.9.

(2) For a withdrawable NSX250 equipped with a Vigi or an insulation-monitoring module, multiply the I_n values by 0.86.

Note: the values indicated above have been validated for PrismaSeT switchboards.

ComPacT NSXm up to 160

Copper cable, withstand temperature = 105 °C

Devices		Rated current of a circuit I_{nc} (A)					
		Ambient temperature around the switchboard					
		25 °C	30 °C	35 °C	40 °C	45 °C	50 °C
IP ≤ 55							
NSXm100 TMD	Size per phase (mm ²)	50	50	50	50	50	50
	I_{nc} (A)	96	94	90	87	83	80
NSXm125 TMD	Size per phase (mm ²)	70	70	70	70	70	70
	I_{nc} (A)	120	117	113	109	104	100
NSXm160 TMD	Size per phase (mm ²)	95	95	95	95	95	95
	I_{nc} (A)	156	152	148	144	139	133
NSXm Vigi (ELCB) 100	Size per phase (mm ²)	50	50	50	50	50	50
	I_{nc} (A)	100	100	100	100	96	93
NSXm Vigi (ELCB) 160	Size per phase (mm ²)	95	95	95	95	95	95
	I_{nc} (A)	160	155	150	145	140	135

Note: For use of NSXm in PrismaSeT Pack multiply the I_{nc} values by 0.98.

Designing connections ≤ 630 A

Incoming connection block and power supply block on Linergy BW busbars

Tubular lugs, Bimetal lugs

Electrical characteristics

ComPacT NSX100 to NSX630

Horizontal mounting

Determining the permissible current of NSX100 to NSX630 connection and power supply blocks as a function of the ambient temperature around the switchboard and their IP degree of protection.

Device			Rated current of a circuit I _{nc} (A)												
			Ambient temperature around the switchboard												
			25 °C		30 °C		35 °C		40 °C		45 °C		50 °C		
			IP ≤ 31	IP > 31	IP ≤ 31	IP > 31	IP ≤ 31	IP > 31	IP ≤ 31	IP > 31	IP ≤ 31	IP > 31	IP ≤ 31	IP > 31	
NSX100 TMD-TMG	Incoming connection	via the top block	LVS04066	100	95	100	92	100	90	97	87	95	85	92	■
		via the bottom block	LVS04067												
	Power supply block	LVS04060													
NSX100STR	Incoming connection	via the top block	LVS04066	100	100	100	97	100	95	100	92	100	90	97	■
		via the bottom block	LVS04067												
	Power supply block	LVS04060													
NSX160 TMD-TMG	Incoming connection	via the top block	LVS04066	160	152	160	147	160	144	156	140	152	136	147	■
		via the bottom block	LVS04067												
	Power supply block	LVS04060													
NSX160STR	Incoming connection	via the top block	LVS04066	160	160	160	156	160	152	160	147	160	144	156	■
		via the bottom block	LVS04067												
	Power supply block	LVS04060													
NSX250 TMD-TMG	Incoming connection	via the top block	LVS04066	238	213	231	207	225	200	219	193	213	185	207	■
		via the bottom block	LVS04067												
	Power supply block	LVS04060													
NSX250STR	Incoming connection	via the top block	LVS04066	250	219	245	213	238	207	225	200	219	193	213	■
		via the bottom block	LVS04067												
	Power supply block	LVS04060													
NSX400B/F/ N/H/S/L fixed	Incoming connection	block	LVS04076	400	360	390	350	380	340	370	330	360	320	350	■
	Power supply block	LVS04070													
NSX630B/F/ N/H/S/L fixed	Incoming connection	block	LVS04076	570	520	555	505	540	490	525	470	510	450	495	■
	Power supply block	LVS04071													

Note: the values indicated above have been validated for PrismaSeT switchboards.

■ connection not possible.

The indicated performance characteristics are valid for:

- ComPacT NSX100/160/250/400 circuit breakers used as incoming or outgoing devices
- ComPacT NSX630 circuit breakers used as incoming device.

Designing connections with cables

Tubular lugs

Tubular lugs for incoming connection blocks

Maximum size of lugs for connection to the different incoming connection blocks.

	Standard Cu lugs	Narrow Cu lugs	Narrow bimetal lugs
Incoming connection block for NSX-INS-INV250 supplied via the top or bottom, cat. no. LVS04066 and LVS04067	150 mm ²	240 mm ²	185 mm ²
In-duct incoming connection block for NSX630, cat. no. LVS04076	240 mm ²	300 mm ²	300 mm ²

Narrow bimetal lugs

Catalog numbers selection

Catalog numbers	Cable size (mm ²)	Quantity
Lugs for aluminium cable(1)		
LV429504	150	3
LV429505	150	4
LV429506	185	3
LV429507	185	4
LV432504	240	3
LV432505	240	4
LV432506	300	3
LV432507	300	4

(1) Supplied with 2 or 3 interphase barriers.

DD09278E-eps

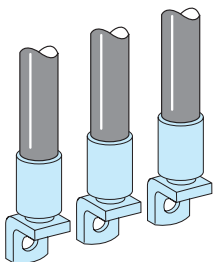

Designing the PEN conductor

Power circuit

Electrical characteristics

Size of PEN protective conductor

Practical guidelines

The size of the PEN is determined in the same manner as a neutral conductor, i.e.:

- for copper single-phase circuits or sized $\geq 16\text{mm}^2$, it must be the same size as the phase conductors
- for copper three-phase circuits sized $> 16\text{mm}^2$, it can be:
 - the same size as the phase conductors
 - smaller on the condition that:
 - the current likely to flow in the neutral during normal operation is less than the permissible current for the conductor
 - the power rating of single-phase loads does not exceed 10 % of the total rating.

The conductor must be accessible to enable connections both in the factory and on site, as well as checks on the tightness of connections.

Implementing the PEN protective conductor

Practical guidelines

According to standard IEC 61439-1 and 2, the practical guidelines for implementing the PEN are the following:

- at the entry to the assembly, the PEN connection must be next to the phase connections
- within the assembly, the PEN does not need to be insulated from the exposed conductive parts (except on sites where there is a risk of fire or explosion)
- the size of the conductor must be at least equal to that of the neutral
- the size must remain constant throughout the main busbars
- the change from a TNC to a TNS system must take place at a single point in the switchboard, via a marked neutral-disconnection bar that is accessible and can be dismantled to facilitate the impedance measurement of the fault loop
- after the TNS creation point, it is forbidden to recreate a TNC system.

The PE and the neutral must meet their specific requirements.

Connection of power cables

Electrical characteristics

- To ensure protection of persons, first connect the switchboard protective conductor to the earth electrode.
- Tie the cables as close as possible to the connections to avoid any mechanical stresses on the device terminals. When not using cable glands, also attach the cables near to the electrical switchboard.
- Cables must never be in contact with or passed between live conductors.
- Sharp edges of the framework must be protected where cables pass to avoid damaging the conductors.
- Comply with a minimum radius of curvature of 6 to 8 times the cable outside diameter.
- All power connections must be made with class 8.8 mounting hardware and elastic contact washers, tightened to the torque indicated in the table below.
- When connecting aluminium cables to copper terminals, use bimetal lugs or interfaces.
- Separate the different types of circuits into separate cable bundles (power, control, 48 V, 24 V, DC, AC, etc).

Cable bundles

Cable cross-sectional area (mm ²)	Max. number of cables per bundle
CSA ≤ 10	8
16 < CSA ≤ 50	4
CSA ≥ 50	Tie individually

Tying the cable bundles

Type of tie	Maximum I _{cw} (kA/rms 1s)	Distance between ties (mm)
Width: 4.5 mm Load: 22 kg	10	200
	15	100
	20	50
Width: 9 mm Load: 80 kg	20	350
	25	200
	35	100
	45	70

For cable sizes of 50 mm² or more, use 9 mm wide fixing ties.

Recommended tightening torque for mechanical and electrical connections with 8.8 class screws.

Diameter of screw	Tightening torque (Nm) (with nut + contact washer)
M3	1.5
M4	3.5
M5	7
M6	13
M8	28
M10	50
M12	75

Tools required for mounting and connection

Practical information

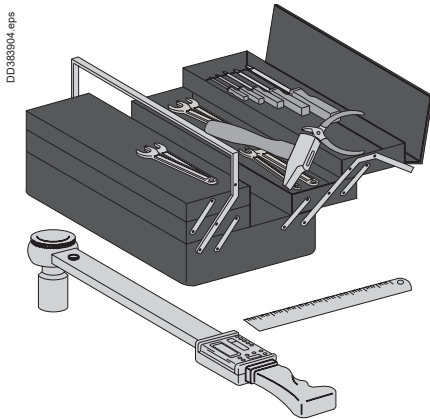

- Vacuum cleaner to clean the switchboards
- Ratchet wrench with sockets
- Torque wrench with sockets and ring bits to tighten the electrical connections to the correct torque (max. torque 50 Nm)
- Open-ended spanners (15 to 27 mm)
- Electrician's knife
- 7, 8, 10, 13, 16, 17 and 19 mm sockets
- Bit holder socket
- 4, 5, 6, 8 and 10 mm hexagonal-head bits
- Pozidriv no. 1, 2 and 3 bits
- Rubber mallet
- Level
- Measurement and inspection tools and instruments
- Drill
- Semi-circuit nosed pliers
- Cable-tie pliers
- Wire stripper
- Crimping tool
- Diagonal cutter
- Wire cutters
- Flat-nosed pliers
- Bit holder for screwdriver
- Extension
- Electric saw
- Jig saw
- Clamp for cubicle alignment
- Buzzer or tester
- 3, 4, 5, 5.5 and 8 mm flat screwdrivers
- Pozidriv no. 2 crosshead screwdriver (to mount handle)
- Hydraulic jacks that can be operated in horizontal position to lift cubicles and move them sideways if necessary
- Coloured, indelible and temperature resistant acrylic varnish
- Electric screwdriver



Seismic zone

Around the world can be found different zones with a specific seismic risk. These zones have been classified according to the Uniform Building Code (UBC).

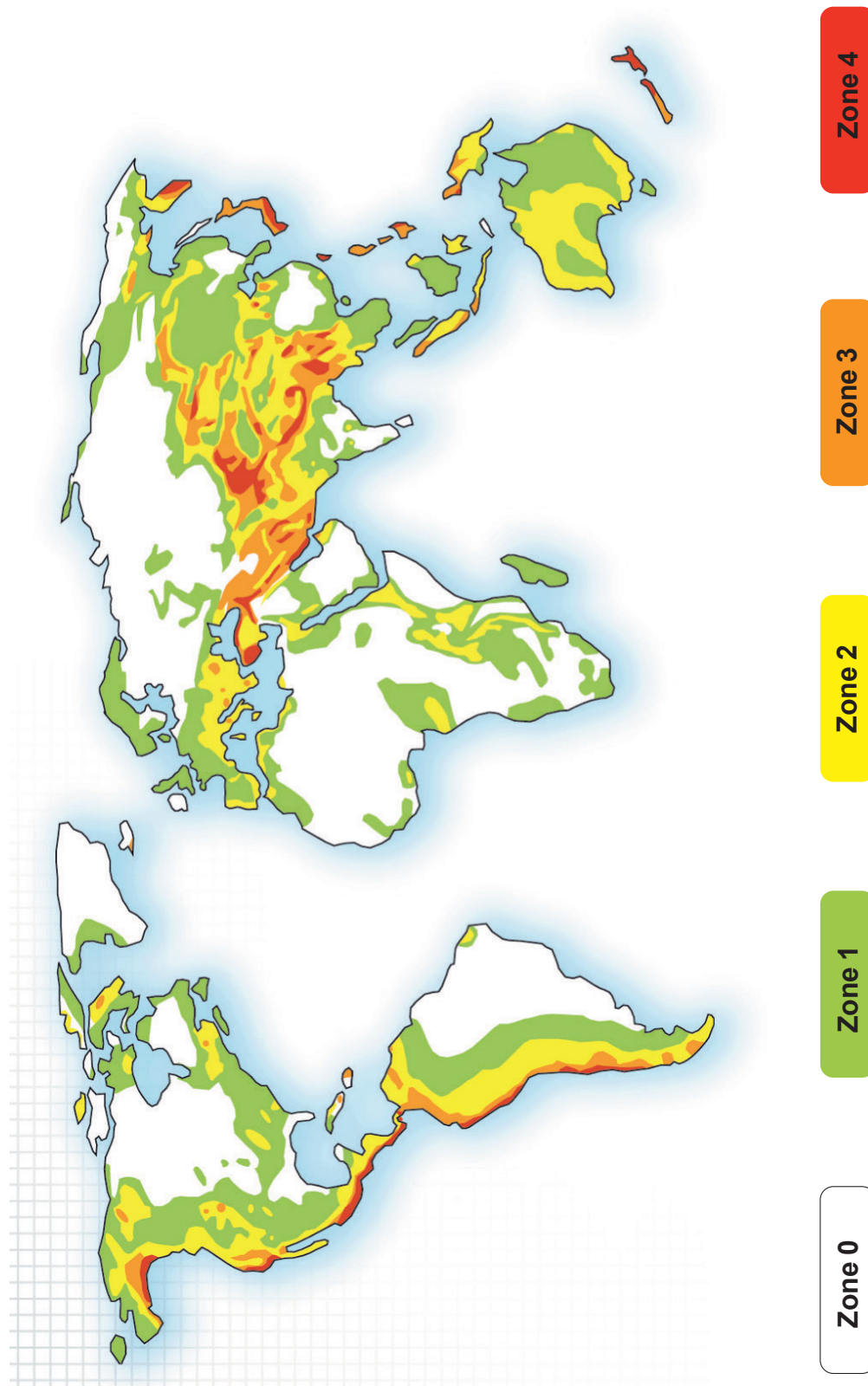



Switchboard qualification

Tests are carried out on switchboards to ensure that they operate correctly (structural and functional integrity) under severe earthquake conditions and meet specific safety requirements. The tests carried out to qualify these switchboards are described in the international standard IEC 60068-3-3.

Classification

From weak to strong earthquakes, PrismaSeT G has been tested in the following ground accelerations to guarantee the right performance on seismic risk.

IEC 60068 -3-3 Ground acceleration	Seismic characteristics			
References	General description	Richter scale magnitude	MSK Intensity	UBC Zone
AG2	Intensity from weak to average	< 5.5	< VIII	0 1
AG3	Intensity from average to strong	5.5 to 7.0	VIII to IX	2 3
AG5	Intensity from strong to very strong	> 7.0	> IX	4

PrismaSeT G is compliant up to level AG5 from IEC 60068-3-3 (2,5G) :

Compare PrismaSeT G Switchboards Performances with seismic Standard
Damping % - horizontal

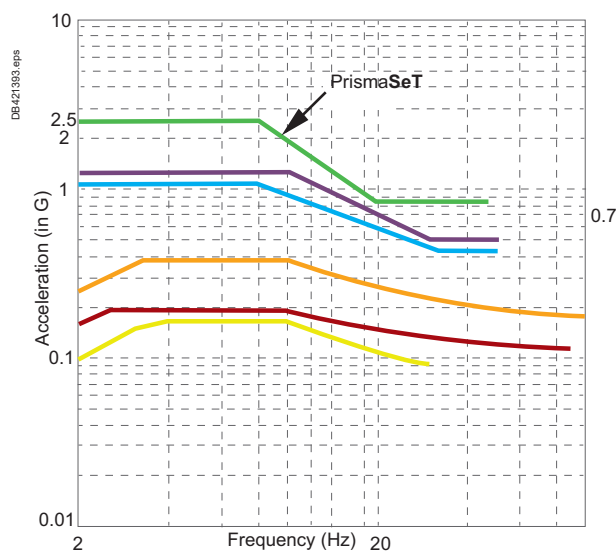

Compare PrismaSeT G Switchboards Performances with seismic Standard
Damping % - vertical

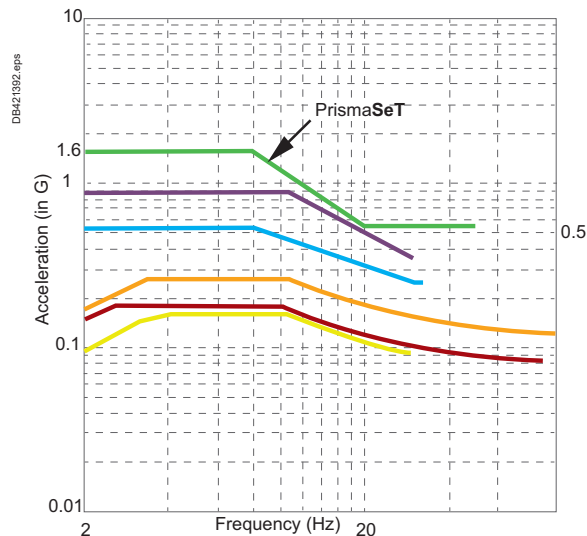

Country	Standard	Parameters
PrismaSeT G	IEC60068-3-3	Up to level AG5
Russia	GOST 17516.1-90	Civil Market (Seismic intensity 8, all installation levels) or (Up to Seismic Intensity 9, Level 1 only)
Chile	ENDESA 1986	All seismic categories
Turkey	Seismic Turkish Code 2009	All seismic zones, all site class
Greece	EAK 2000	All soil types, Worst case
Australia	AS1170	All soil types, Worst case

Warning: use the seismic kit LVS04130 when using linergy BW > see page D-4





What is a standard?

A common reference

"A standard helps to define a common language between economic stakeholders (producers, users and consumers), to clarify and harmonize practices and to define the levels of quality, safety, compatibility, and least environmental impact of products, services and practices.

Standards facilitate trade, both national and international, and help to better structure the economy and facilitate the everyday life of everyone."

Afnor definition

IEC international standards

The IEC (International Electrotechnical Commission) is a worldwide organisation for standardisation comprising all national electrotechnical committees (IEC National Committees).

The object of the IEC is to promote international cooperation on all questions concerning standardisation in the electrical and electronic fields.

To that end, the IEC publishes International Standards.

Their preparation is entrusted to technical committees and any IEC National Committee interested in the subject dealt with may participate in the preparatory work.

National standards

In Europe

The IEC documents are first studied by CENELEC, which establishes:

- either a European standard (EN), often identical to the IEC standard, which then becomes the applicable national standard in all the member countries
- or, in the event of differences, a harmonisation document (HD).

Other IEC member countries

Each country is autonomous and can accept the IEC standard as the national standard, with or without modifications.

Even though they are IEC members, countries such as Japan and the United States continue to develop their own standardisation systems.

Countries without a standardisation system

It is possible to refer to an IEC standard in the framework of a project.

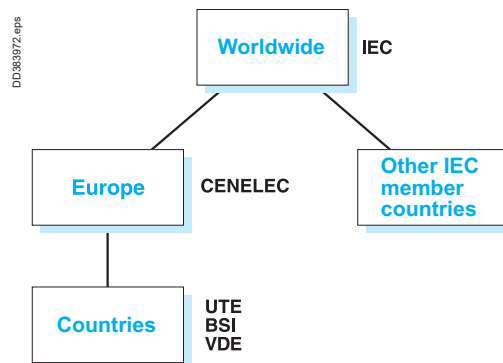

CEI / IEC

Commission Electrotechnique Internationale

CENELEC

Comité Européen de Normalisation ELECtrotechnique

UTE

Union Technique de l'Électricité

VDE

Verband der Elektrotechnik, Elektronik und Informationstechnik

e.v. (German electrotechnical, electronics and computer

technology standardisation organisation)

BSI

British Standards Institution



The different types of standards

There are different types of standards, including:

- management standards
- installation standards
- product standards.

Management standards

ISO 9004: Quality-management systems - guidelines for performance improvements. Used in setting up a quality-management system.

ISO 9001: Quality management systems - requirements. Used for certification audits.

ISO 14004: Environmental-management systems. General guidelines on the principles, systems and supporting techniques.

ISO 14001: Environmental-management systems. Specification with guidance for use.

The majority of Schneider Electric development centres and factories are certified ISO 9001 and ISO 14001.

Low voltage installation standards

The set of IEC 60364 standards defines the main principles and rules for the design and the mounting of the electrical installation:

- determining general characteristics of installations
- protection
- selection and installation of equipment
- verification and maintenance of installations.

Switchgears standards

They apply to devices or assemblies and are aimed at ensuring correct operation and safety of the concerned products:

- standards on low voltage switchgear and controlgear:
 - IEC 60947-1: general rules
 - IEC 60947-2: circuit breakers
 - IEC 60947-3: switches and disconnectors
 - IEC 60947-4: contactors
 - IEC 60947-7-1: terminal blocks for copper conductors
 - IEC 62208: empty enclosures.
- The IEC 61439 switchboard standard:
 - characterizes the electrical switchboard and specifies the design, construction and verification rules
 - describes in detail all low voltage switchgear and controlgear: definitions, technical characteristics, conditions of use, and construction and verification requirements
 - applies to power switchgear and controlgear assemblies (PSC assemblies) whose rated voltage does not exceed 1000 V in alternating current or 1500 V in direct current.

Regulations in a given country may make certain standards legally binding and may also create additional safety requirements.

In addition to providing proof of the conformity of its quality-management system, a product manufacturer can demonstrate the quality of products by providing proof that the design and manufacture comply with the requirements in the applicable standard.

Proof of conformity may be a declaration by the manufacturer or a certificate supplied by an independent organisation.

> More informations in [pages B-14 to B-17](#).

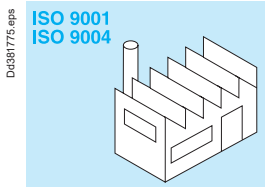

Dd381775.eps

ISO 9001
ISO 9004

Design and manufacture.

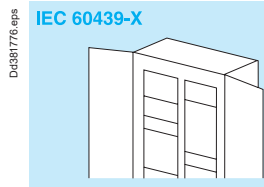

Dd381776.eps

IEC 60439-X

Switchgear and controlgear assemblies.

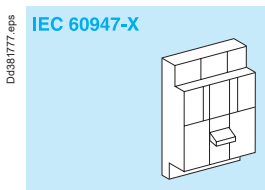

Dd381777.eps

IEC 60947-X

Switchgear and controlgear.

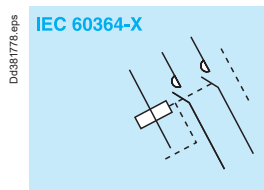

Dd381778.eps

IEC 60364-X

Installation.



Standards

Enclosure standards

Standard IEC 62208 lay down definitions, classifications, characteristics and test requirements for enclosures used for switchgear and controlgear assemblies. They apply to empty enclosures before installation of the devices by the panelbuilder, as supplied by the manufacturer. They apply to one-piece enclosures and to enclosures supplied in kit form.

Type tests of standard IEC 62208

- 1 - Static load
- 2 - Hoisting
- 3 - Axial loads of metal inserts
- 4 - IK code
- 5 - IP code
- 6 - Thermal stability
- 7 - Resistance to heat
- 8 - Resistance to abnormal heat and to fire
- 9 - Dielectric strength
- 10 - Protective-circuit continuity
- 11 - Weather resistance
- 12 - Corrosion resistance
- 13 - Marking

CE marking

CE marking is a regulatory symbol attributed under the sole responsibility of the manufacturer and intended for the verification authorities of the European countries that enforce the European regulations.

It allows free circulation of a product in the European Union and certifies that it complies with the basic requirements in all the applicable European directives. CE marking is not a quality symbol and does not indicate conformity with a standard

The CE declaration is intended exclusively for the authorities in charge of verifying compliance with the applicable regulations and it is drafted, signed and held for presentation to the authorities by the manufacturer.

For the PrismaSeT range, the declaration is the responsibility of the Schneider Electric unit that has designed and developed the product.

For LV switchboards, the declaration is the responsibility of the panelbuilder.

The following products receive CE marking:

- all products that are liable to endanger the safety of persons, animals and property (LV directive)
- all products likely to emit electromagnetic disturbances above a standardised threshold or to be disturbed during operation (EMC directive).

Consequences:

- the PrismaSeT range falls under the LV directive only
- LV switchboards are covered by the LV directive and may also fall under the EMC directive, depending on the type of devices incorporated.

For the PrismaSeT range, CE marking is applied:

- on the packing of "mechanical" components
- on the product itself for "electrical" components.

For the LV assemblies created by the panelbuilder, CE marking is applied:

- on the packing
- on the rating plate (if applicable)
- on one of the documents accompanying the switchboard when it is shipped.





Standards

Schneider Electric enclosures comply with standard IEC 62208 for empty enclosures. The sheet metal used for Schneider Electric enclosures receives an anti-corrosion epoxy electrophoresis treatment and a coating of a thermosetting, polyester-resinmodified epoxy powder for colour and appearance. This two-coat system provides excellent finish and corrosion protection. The characteristics of this coating are much better than those of traditional epoxy powders:

- improved colour stability
- wider operating temperature range.

Mechanical properties of enclosures

Static load on doors, wall-mounted and floor-standing enclosures and cubicles

Floor-standing enclosure	64 kg
Wall-mounted enclosure	48 kg
Floor-standing enclosure door	4 kg
Wall-mounted enclosure door	4 kg

Mechanical properties of powder coated surfaces

Test conditions

Test piece made of 1 mm thick steel sheet, degreased, iron phosphated, final rinsing with 100000 Ω cm DI water, 15 microns of anti-corrosion electrophoresis treatment and 35 microns of powder paint.

Adhesion (cross-hatch and pull-off)	class 0 required	(ISO 2409)
Impact strength ⁽¹⁾	> 1 kg/50 cm	(ISO 6272)
Mandrel bending test ⁽²⁾	< 10 mm	(ISO 6860)
Persoz hardness	300 s	(ISO 1522)

Artificial ageing test on powder coating

Test conditions: two tests carried out on the same 1 mm thick steel sheet test piece.

- cyclical damp-heat test:
 - as per standard IEC 68-2-30
 - six 24-hour cycles at temperatures higher than 40 °C
- continuous resistance to neutral salt mist:
 - the tests were carried out over a period of 400 hours, far more than the 48 hours required by the standard for indoor installations
 - as per standard IEC 68-2-11 and ISO 7253
 - 400 hours without blistering for normal surface on test piece
 - 250 hours for a scratched surface.

Evaluation of corrosion as per ISO 4628:

- adhesion: class ≤ 1
- blistering: degree 1 dim. 1
- rusting: Ri 1
- cracking: class 1
- flaking imp. 1 dim. 1
- propagation of corrosion under scratch with respect to the scratch axis: 3 mm max.

Chemical properties of powder coating

Tests carried out at ambient temperature on phosphated test pieces coated with a 150 to 200 micron film.

Test duration (months)		2	4	6	8	10	12	
Acids	Concentration							
	Acetic	20 %						
	Sulphuric	30 %						
	Nitric	30 %						
	Phosphoric	30 %						
	Hydrochloric	30 %						
	Lactic	10 %						
	Citric	10 %						
	Bases	Soda	10 %					
		Ammonia	10 %					
Water	Distilled water							
	Seawater							
	Tap water							
	Diluted bleach							
Solvents	Petrol							
	High alcohols							
	Aliphatics							
	Aromatics							
	Ketones, esters							
	Tri-perchloroethylene							

Film intact.

Film damaged (blisters, yellowing, loss of shine).

(1) No cracking of the paint film after dropping a weight of one kilogram on the test piece from a height of 50 centimetres.

(2) Film cracks over a length of 10 millimetres maximum.



Standards

Degree of protection

Standard IEC 60364-5-51 lists and codifies a large number of external influences to which electrical installations can be subjected, including the presence of water, solid objects, shocks, vibrations, corrosive substances, etc.

IP code

Standard IEC 60529 (IP code, February 2001) indicates the degrees of protection provided by an enclosure for electrical devices against access to hazardous parts, against penetration of solid foreign objects and against penetration of water. These standards do not apply for the protection against the risks of explosion or conditions such as humidity, corrosive vapour, fungus or vermin. The IP code is made up of two characteristic numerals and can include an additional letter when the actual protection for persons against access to the hazardous parts is better than that indicated by the first numeral. The first numeral characterises the protection provided against the ingress of solid foreign objects and the protection of persons. The second numeral characterises the protection provided against the ingress of water with harmful effects.

1st numeral Protection of persons		Protection against ingress of solid objects		2nd numeral Protection against ingress of water	
1	Protected against access with back of hand Dd381959.eps Ø50 mm	Protection against solid foreign objects larger than 50 mm Dd381959.eps Ø50 mm		1	Protected against vertically dripping water (condensation) Dd381966.eps Dd381966.eps
2	2 Protected against access with a finger Dd381960.eps Ø12 mm	Protection against solid foreign objects larger than 12.5 mm Dd381963.eps Ø12,5 mm		2	Protected against dripping water up to 15° from vertical Dd381967.eps Dd381967.eps
3	Protected against access with a tool Dd381961.eps Ø2,5 mm	Protection against solid foreign objects larger than 2.5 mm Dd381961.eps Ø2,5 mm		3	Protected against spraying water up to 60° from vertical Dd381968.eps Dd381968.eps
4	4 Protected against access with a wire Dd381962.eps Ø1 mm	Protection against solid foreign objects larger than 1 mm Dd381962.eps Ø1 mm		4	Protected against splashing water from all directions Dd381969.eps Dd381969.eps
5	Protected against access with a wire Dd381962.eps Ø1 mm	Protected against dust (dust protected) Dd381964.eps Dd381964.eps		5	Protected against water jets from all directions Dd381970.eps Dd381970.eps
6	Protected against access with a wire Dd381962.eps Ø1 mm	Dust tight Dd381965.eps Dd381965.eps		6	Protected against powerful water jets from all directions Dd381971.eps Dd381971.eps
				7	Protected against the effects of temporary immersion in water Dd381972.eps Dd381972.eps
				8	Protected against the effects of continuous immersion in water Dd381973.eps Dd381973.eps
				9	Protected against close-range high pressure, high temperature spray downs



Standards

Additional letter

The additional letter is used only if the actual protection of persons is higher than that indicated by the first characteristic numeral of the IP code.

Additional letter	Protection
A	A Protected against access with back of hand
B	B Protected against access with a 12 mm diameter finger
C	C Protected against access with a 2.5 mm diameter tool
D	D Protected against access with a 1 mm diameter wire

If only the protection of persons is of interest, the two characteristic numerals are replaced by the letter "X", e.g. IPXXB.

Illustration of the above explanations:

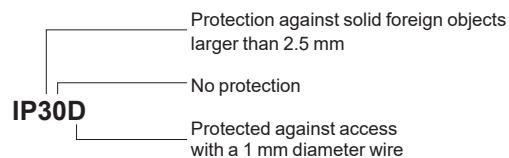

Remarks

- The degree of protection IP must always be read and understood numeral by numeral and not as a whole. For example, an IP31 wall-mount enclosure is suitable for an environment that requires a minimum degree of protection IP21. However an IP30 wall-mount enclosure is not suitable.
- the degrees of protection indicated in this catalog are valid for the enclosures as presented. However, the indicated degree of protection is guaranteed only when installation and device mounting are carried out in accordance with professional standards that conserve the initial degree of protection.

IK code

Standard IEC 62262 defines an IK code characterising the capacity of products to resist mechanical impacts from all sides.

IK code	Impact energy (joules)
01	0.14
02	0.2
03	0.35
04	0.5
05	0.7
06	1
07	2
08	5
09	10
10	20

IK codes can be selected according to the risks of impacts on a given site.

	Site	Recommended IK
No risk of major impact	Technical premises	07
Significant risk of impact that can damage devices	Hallways	08 (switchboard with door)
Maximum risk of impact that can damage the switchboard	Workshops	10



Selection of enclosures according to the premises

Enclosure characteristics

The IP and IK degrees of protection provided by an enclosure must be specified as a function of the various external influences defined by standard IEC 30364-5-51, in particular:

- presence of foreign solid bodies (code AE)
- presence of water (code AD)
- mechanical stress (code not specified)
- capability of persons (code BA)
- ...

PrismaSeT switchboards are designed for indoor installation.

Unless the rules, standards and regulations of a specific country stipulate otherwise, Schneider Electric recommends the following IP and IK values based on French guide UTE C 15-103 (March 2004).

Using the table

- 1 Opposite the relevant premises, read the recommended IP and IK values.
- 2 The ■ symbol indicates the enclosure or cubicle satisfying the criteria of the UTE guide.
Any enclosure or cubicle with a higher degree of protection can also be used.
- 3 If several degrees of protection are possible (refer to the standard for more details) and the □ and ■ symbols are indicated (e.g. 24[□]/25[■]), enclosures that correspond to the higher degree of protection (■) are suitable for the lower degree of protection (□).

Example:

Selection of an enclosure for a laundry room.

Minimum degree of protection: IP21/IK02

A wall-mounted enclosure with a door (plain or transparent), a canopy and a gasket offer IP43/IK08 degrees of protection and are therefore suitable for this application.

Type of premises	Enclosures					
	Wall-mounted enclosure	without door	with door (1)	with door + canopy (1)	with door + canopy + gasket (1)	IP55
	Floor-standing enclosure	without door	with door (1)	with door + canopy (1)	with door + canopy + gasket (1)	
Min. IP/IK required	IP30/IK07	IP40/IK08 - IK10	IP41/IK08 - IK10	IP43/IK08 - IK10	IP55/IK10	
IP	IK					
Domestic or comparable premises or locations						
Porch	24	07				■
Bathrooms (see washrooms)						
Bicycles, motorcycles, tricycles, etc. (premises for)	20	07	■			
Water, sewer and heating connections	23	02			■	
Laundries	21	02		■		
Cellars, garages, furnace rooms	20	02/07	■			
Bedrooms	20	02	■			
Trash rooms	25	07				■
Halls in cellars	20	07	■			
Courtyards	24/25	02/07				■
Kitchens	20	02	■			
Shower rooms (see washrooms)						
Indoor stairways and alleys	20	02/07	■			
Outdoor stairways and outdoor alleys without roofs	24	07				
Outdoor alleys with roofs	21	02		■		
Attics (roof space)	20	02	■			
Garden shelters	24/25	02/07				■
Latrines	20	02	■			
Dustbin rooms	25	02/07				■
Ironing room	20	02	■			
Access ramps to garages	25	07				■

N/A

(1) IK08 with transparent door, IK10 with plain door.

Selection of enclosures according to the premises

Enclosure characteristics

Type of premises		Enclosures					
		Wall-mounted enclosure	without door	with door (1)	with door + canopy (1)	with door + canopy + gasket (1)	IP55
		Floor-standing enclosure	without door	with door (1)	with door + canopy (1)	with door + canopy + gasket (1)	IP55/IK10
		Min. IP/IK required	IP30/IK07	IP40/IK08 - IK10	IP41/IK08 - IK10	IP43/IK08 - IK10	
		IP	IK				
Washrooms, rooms containing a bathtub or shower	volume 0	27	02				
	volume 1	24	02				■
	volume 2	23	02			■	
	volume 3	21	02		■		
Lounges, living rooms, etc		20	02	■			
Drying rooms		21	02			■	
Covered terraces		21	02			■	
WCs		20	02	■			
Verandas		20	02	■			
Crawl spaces		23	07				■
Commercial premises and adjoining areas							
Gunsmiths (storage area, workshop)		30	08		■		
Laundries (wash room)		24	07				■
Butchers	shop	24	07				■
	cold room: ≤ -10 °C	23	07			■	
Bakers, cake shops (kitchens)		50	07				■
Coffee roasters		21	02			■	
Coal, wood, oil		20	08		■		
Delicatessen (production)		24	07				■
Sweets (production)		20	02	■			
Shoe repair shops		20	02	■			
Dairies		24	02				■
Hardware stores (storage areas for chemicals and paint)		33	07			■	
Wood workers		50	07				■
Art galleries		20	02/07	■			
Florists		24	07				■
Furriers		20	07	■			
Fruit and vegetable merchants		24	07				■
Grain shops		50	07				■
Bookshops, stationers		20	02	■			
Motorcycle and bicycle repairs and accessories		20	08		■		
Messenger services		20	08		■		
Furniture shops (antiques, secondhand)		20	07	■			
Glass and mirror merchants (workshop)		20	07	■			
Wallpaper shop (storage area)		20	07	■			
Cosmetics shop (storage area)		20	02	■			
Chemists (storage area)		20	02	■			
Photographers (dark room)		23	02			■	
Plumbers (storage area)		20	08		■		
Fishmongers		25	07				■
Dry cleaners		23	02			■	
Hardware stores (without paint, chemicals, etc.)		20	07	■			
Locksmiths		20	07=08		■		
Vintners, spirits		20	07	■			
Interior decorator (carding)		50	07				■
Tailors, clothing retailers (storage area)		20	02	■			
Pet care		35	07				■

N/A

(1) IK08 with transparent door, IK10 with plain door.

Selection of enclosures according to the premises

Enclosure characteristics

Type of premises		Enclosures					
		Wall-mounted enclosure	without door	with door (1)	with door + canopy (1)	with door + canopy + gasket (1)	IP55
		Floor-standing enclosure	without door	with door (1)	with door + canopy (1)	with door + canopy + gasket (1)	IP55/IK10
		Min. IP/IK required	IP30/IK07	IP40/IK08 - IK10	IP41/IK08 - IK10	IP43/IK08 - IK10	
		IP	IK				
Buildings open to the general public							
Shared premises of buildings open to the general public	storage rooms	20	08		■		
	packing rooms	20	08		■		
	archive rooms	20	02	■			
	film and magnetic media storage	20	02	■			
	linen rooms	20	02	■			
	laundry rooms	24	07				■
	misc. shops	21	07/08			■	
	kitchens (large)						
J	Reception old and handicapped people	20	02	■			
L	Lecture halls, meeting rooms, auditoriums, halls used for several purposes						
	halls	20	02/07	■			
	stage areas	20	08		■		
	scenery storage rooms	20	08		■		
	costume rooms	20	07	■			
M	Retail premises, shopping malls						
	sales premises	20	08		■		
	areas for storage and handling of packing	20	08		■		
N	Restaurants and cafes	20	08		■		
O	Hotels and boarding houses	20	02	■			
P	Dance halls and gaming parlours	20	07	■			
R	Teaching establishments, holiday camps						
	classrooms	20	02	■			
	dormitories	20	08		■		
S	Libraries and documentation centres						
		20	02	■			
T	Exhibitions						
	halls and rooms	20	02	■			
	areas for reception of equipment and merchandise	20	07	■			
U	Healthcare establishments						
	bedrooms	20	02	■			
	incineration	21	07/08			■	
	operating rooms	20	07	■			
	centralised sterilisation	24	02/07				■
	pharmacies and labs with more than 10 l of inflammable liquids	21 [□] /23 [■]	02 [□] /07 [■]			■	
V	Places of worship	20	02	■			
W	Administrative premises, banks	20	02	■			
X	Indoor sports facilities						
	halls	20	07 [□] /08 [■]		■		
	premises containing refrigeration facilities	21	08	□		■	
Y	Museums	20	02	■			
PA	Covered open air facilities	23 [□] /25 [■]	08 [□] /10 [■]				■
CTS	Marquees and tents	44	08			□	■
SG	Inflatable structures	44	08				■
PS	Covered parking lots	21	08 [□] /10 [■]				■

(1) IK08 with transparent door, IK10 with plain door.

Selection of enclosures according to the premises

Enclosure characteristics

Type of premises	Enclosures					
	Wall-mounted enclosure	without door	with door (1)	with door + canopy (1)	with door + canopy + gasket (1)	IP55
	Floor-standing enclosure	without door	with door (1)	with door + canopy (1)	with door + canopy + gasket (1)	IP55/IK10
	Min. IP/IK required	IP30/IK07	IP40/IK08 - IK10	IP41/IK08 - IK10	IP43/IK08 - IK10	
	IP	IK				
Technical premises						
Battery rooms	23	02/07				■
Lifts (machine rooms and pulley rooms)	20	07°/08°	□	■		
Electrical rooms	20	07	■			
Control rooms	20	02	■			
Workshops	21°/23°	07°/08°			□	■
Laboratories	21°/23°	02°/07°			□	■
Air conditioning washers	24	07				
Garages (used exclusively for parking vehicles) of an area not exceeding 100 m ²	21	07			■	
Machine rooms	31	07/08			■	
Water pressurisers	23	07/08				■
Boiler houses and adjoining premises (power in excess of 70 kW)						
Boiler rooms	coal fuel	51°/61°	07°/08°			□
	other fuel	21	07/08		■	
	electrical	21	07/08		■	
Fuel storage areas	coal	50°/60°	08			□
	oil	20	07°/08°	□	■	
	liquefied gas	20	07°/08°	□	■	
Cinder tips	50	08				■
Pump rooms	21°/23°	07°/08°			□	■
Pressure reduction rooms (gas)	20	07°/08°	□	■		
Steam or hot water facilities	21°/23°	07°/08°			□	■
Expansion vessel rooms	21	02			■	
Garages and car parks of an area exceeding 100 m²						
Parking lots	21	07°/10°			□	■
Carwash areas (inside premises)	25	07				■
Petrol stations	inside	21	07		■	
	outside					
Lubrication areas	23	08				■
Battery recharging areas	23	07				■
Workshops	21	08			■	
Public building (other than for the general public)						
Offices	20	02	■			
Libraries	20	02	■			
Archives	20	02	■			
Computer rooms	20	02	■			
Design offices	20	02	■			
Rooms containing reprographic machines	20	02	■			
Sorting rooms	20	07	■			
Refectories in restaurants or canteens	21	07			■	
Large kitchens						
Sports rooms	20	07°/08°	□	■		
Barracks	20	07	■			
Meeting rooms	20	02	■			
Waiting rooms, lounges, halls	20	02	■			
Medical consulting rooms, not fitted with specific equipment	20	02	■			
Demonstration and exhibition rooms	20	02/07	■			

N/A

(1) IK08 with transparent door, IK10 with plain door.

Selection of enclosures according to the premises

Enclosure characteristics

Type of premises	Enclosures					
	Wall-mounted enclosure	without door	with door (1)	with door + canopy (1)	with door + canopy + gasket (1)	IP55
	Floor-standing enclosure	without door	with door (1)	with door + canopy (1)	with door + canopy + gasket (1)	
	Min. IP/IK required	IP30/IK07	IP40/IK08 - IK10	IP41/IK08 - IK10	IP43/IK08 - IK10	IP55/IK10
	IP	IK				
Industrial facilities						
Slaughter houses	55	08				■
Batteries (manufacture)	33	07				■
Acid (manufacture and storage)	33	07				■
Alcohol (manufacture and storage)	33	07				■
Aluminium (manufacture and storage)	51	08				■
Livestock (raising, fattening and sale)	45	07				■
Asphalt and bitumen storage	53	07				■
Wool beating and carding	50	08				■
Industrial laundry	24/25	07				■
Wood (processing)	50	08				■
Meat packers	24/25	07				■
Bakeries	50	07				■
Breweries	24	07				■
Brickworks	53	08				■
Rubber (production and processing)	54	07				■
Carbide (manufacture and storage)	51	07				■
Ammunition factories	53	08				■
Carton board (production)	33	07			■	
Quarries	55	08				■
Celluloid (manufacture of objects)	30	08		■		
Cellulose (manufacture)	34	08				■
Coal (depots)	53	08				■
Pork products	24/25	07				■
Boiler-making works	30	08		■		
Lime kilns	50	08				■
Rag (storage)	30	07	■			
Chlorine (manufacture and storage)	33	07			■	
Chrome-plating	33	07			■	
Cement works	50	08				■
Coking plant	53	08				■
Adhesives (production)	33	07			■	
Bottling lines	35	08				■
Liquid fuels (storage)	31 [□] /33 [■]	08		□	■	
Fats (processing)	51	07				■
Leather (tanning and storage)	31	08			■	
Copper (ore processing)	31	08			■	
Paint stripping	54	08				■
Detergents (manufacture)	53	07				■
Distilleries	33	07			■	
Electrolysis	33	08			■	
Ink manufacturing	31	07			■	
Fertilisers (manufacture and storage)	53	07				■
Explosives (manufacture and storage)	55	08				■
Iron (production and processing)	51	08				■
Spinning mills	50	07				■
Furriers (beating process)	50	07				■
Cheese factories	25	07				■
Gas (production and storage)	31	08			■	
Tar (processing)	33	05			■	
Seed production	50	07				■
Metal engraving	33	07			■	
Oils (extraction)	31	07			■	
Petroleum products (manufacture)	33 [□] /34 [■]	08			□	■
Printworks	20	08		■		

(1) IK08 with transparent door, IK10 with plain door.

Selection of enclosures according to the premises

Enclosure characteristics

Type of premises	Enclosures					
	Wall-mounted enclosure	without door	with door (1)	with door + canopy (1)	with door + canopy + gasket (1)	IP55
	Floor-standing enclosure	without door	with with door (1)	with door + canopy (1)	with door + canopy + gasket (1)	
	Min. IP/IK required	IP30/IK07	IP30/IK07	IP41/IK08 - IK10	IP43/IK08 - IK10	IP55/IK10
	IP	IK				
Industrial establishments (continued)						
Dairies	25	07				■
Public wash-houses	25	07				■
Liqueurs (production)	21	07			■	
Halogenated liquids (use)	21	08			■	
Inflammable products (storage and workshops where they are used)	21	08			■	
Magnesium (production, storage and use)	31	08			■	
Machine rooms	20	08		■		
Plastics (production)	51	08				■
Cabinet makers	50	08				■
Metals (processing)	31 [□] /33 [■]	08			□	■
Combustion engines (testing of)	30	08		■		
Ammunition storage	33	08				■
Nickel (ore processing)	33	08				■
Household waste (processing)	54	07				■
Paper (production)	33 [□] /34 [■]	07			□	■
Paper (storage)	31	07			■	
Perfume (production and storage)	31	07			■	
Pulp mill	34/35	07				■
Paint (production and storage)	33	08				■
Plaster (processing and storage)	50	07				■
Gunpowder factory	55	08				■
Chemicals (production)	30 [□] /50 [■]	08		□		■
Oil refineries	34/35	07				■
Salt preserve factories	33	07				■
Soap (production)	31	07			■	
Saw mills	50	08				■
Metalwork shops	30	08		■		
Grain or sugar silos	50	07				■
Silk and artificial hair factories	50	08				■
Sodium carbonate (processing and storage)	33	07				■
Sulphur (processing)	51	07				■
Spirits (storage)	33	07				■
Sugar mills	55	07				■
Tanners	35	07				■
Dye works	35	07				■
Textile and fabric (production)	51	08				■
Varnish (production and application)	33	08				■
Glass works	33	08				■
Zinc works	31	08			■	

(1) IK08 with transparent door, IK10 with plain door.

Selection of enclosures according to the premises

Enclosure characteristics

Type of premises	Enclosures					
	Wall-mounted enclosure	without door	with door (1)	with door + canopy (1)	with door + canopy + gasket (1)	IP55
	Floor-standing enclosure	without door	with door (1)	with door + canopy (1)	with door + canopy + gasket (1)	
	Min. IP/IK required	IP30/IK07	IP40/IK08 - IK10	IP41/IK08 - IK10	IP43/IK08 - IK10	IP55/IK10
	IP	IK				
Farm premises or locations						
Alcohol (storage)	23	07			■	
Closed cattle sheds	35	07				■
Laundries	24	07				■
Wood storage rooms	30	10				■
Threshing floors	50	07				■
Distilling cellars	23	07			■	
Vat rooms (wine)	23	07			■	
Courtyards	35	07				■
Poultry barns	35	07				■
Stables	35	07				■
Fertiliser (storage)	50	07				■
Stables	35	07				■
Manure heaps	24	07				■
Haylofts	50	07				■
Haystacks, forage (storage)	50	07				■
Granaries, barns	50	07				■
Straw (storage)	50	07				■
Greenhouses	23	07			■	
Grain silos	50	07				■
Milking rooms	35	07				■
Pig sties	35	07				■
Chicken houses	35	07				■
Miscellaneous installations						
Fair facilities	33	08			■	
Water treatment facilities	24/25	07/08				■
Thermodynamic installations, air-conditioned rooms and cold rooms						
Height above ground	from 0 to 1.10 m	25	07			■
	from 1.10 to 2 m	24	07			■
	above 2 m under evaporator or water drain pipe	21	07		■	
	ceiling and up to 10 cm underneath	23	07			■
Temperature ≤ -10 °C		23	07			■
Compressor room	room	21	08		■	
	integral unit located outside or on a terrace	34	08			

N/A

(1) IK08 with transparent door, IK10 with plain door.



Thermal management of switchboards

General

Thermal characteristics

A switchboard is designed for operation under normal ambient conditions. Most devices do not operation correctly outside a temperature range of -10 and +70 °C.

It is therefore important to maintain the switchboard internal temperature within this temperature range by:

- correctly sizing the switchboard during design
- correcting the temperature using suitable means.

Management of the internal temperature

Cooling

There are a number of way to dissipate heat from the switchboard.

The drawings below present the various means.

Convection

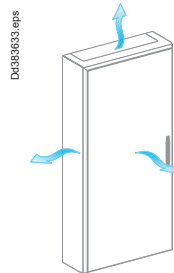

IP > 31
Ensured naturally in PrismaSeT enclosures.

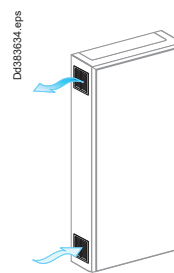

IP ≤ 31

Forced-air ventilation

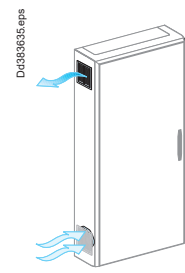

IP ≤ 54
Using fans, it significantly increases the thermal capacity of an enclosure.

Forced-air ventilation with air-air exchanger

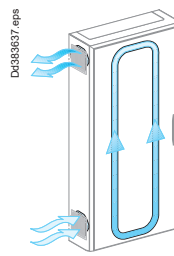

IP > 31
On special request.

Forced convection and cooling

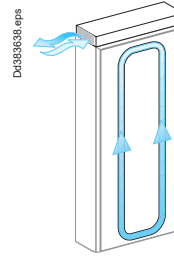

IP > 31

For these extreme cases, many installers prefer to set up the switchboards with other electrotechnical and electronic devices in air-conditioned electrical rooms.

Heating

The means employed to raise the internal temperature in a switchboard is a resistorbased heater, used to:

- avoid condensation by limiting variations in temperature
- ensure that the switchboard does not freeze.

Thermal management of switchboards

General

Thermal characteristics

Calculation of the internal temperature

Calculation of the temperature is the means to check that the enclosure can evacuate the dissipated power of the installed devices.

Important note

Correct thermal management of the switchboard depends on compliance with the installation requirements for the distribution system (power circuits).

Incorrect installation will have major consequences on the connected device, but almost none on the internal temperature of the enclosure.

Once the circuit has been correctly sized, it is necessary to check whether the assembly (devices + distribution system + cables) have a level of dissipated power $P(W) \leq$ the $P(W)$ that the enclosure can handle.

Method defined by IEC 890 technical report

This IEC guide for switchboards proposes a calculation method to determine three levels of internal temperature, depending on the dissipated power of the devices and distribution blocks installed in the switchboard.

Users can consult this document when it is necessary to determine precisely the internal temperature in view of optimising the switchboard.

On request, Schneider Electric can carry out a thermal study to check that the installed assembly and the thermal capacity of the enclosure are compatible.

Comparative method

A number of qualified and tested configurations serve as the basis for indicating the thermal capacity of PrismaSeT enclosures.

This is an empirical means to check whether the dissipated power of the desired configuration is close to that of a tested configuration.

Method using charts taking into account enclosure characteristics

To speed up calculations, Schneider Electric produces charts based on the company's experience and a number of assumptions on the installation.

They can be used sufficiently precisely to determine the variations in temperature and the dissipated-power levels for the different types of wall-mount enclosures, floor-standing enclosures and cubicles.

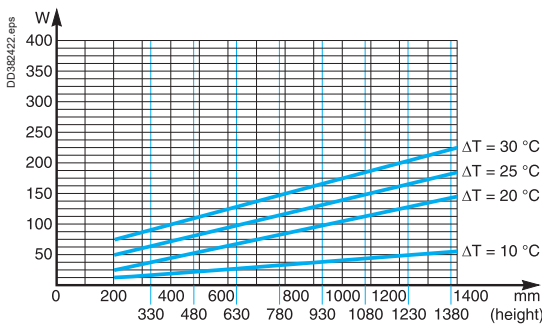
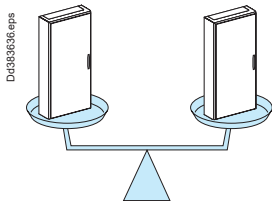
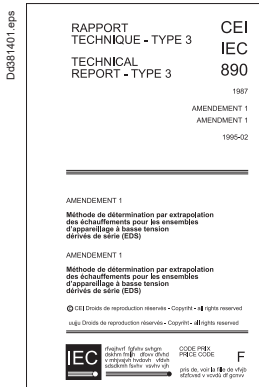

Thermal management of switchboards

Comparative method

Thermal characteristics

Comparative method

You will have no problems with your switchboard if:

- the volume of the enclosure is greater than that of the tested enclosure with a similar assembly
- the P(W) of the installed assembly is less than the P(W) of the tested configuration in the same size enclosure.

Pack enclosure, 3 rows, IP30

Diversity factor: 0.7

Ambient temperature around the switchboard: 35 °C

35 °C

P(W) = 95 W

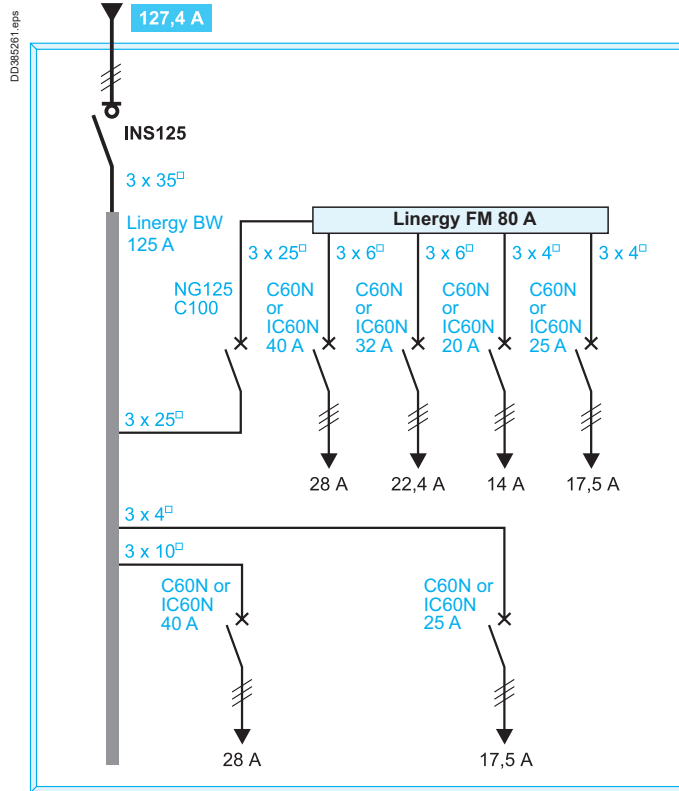

Wall-mounted enclosure, 23 modules, IP30/IP4X

Diversity factor: 0.7

Ambient temperature around the switchboard: 35 °C

P(W) = 170 W

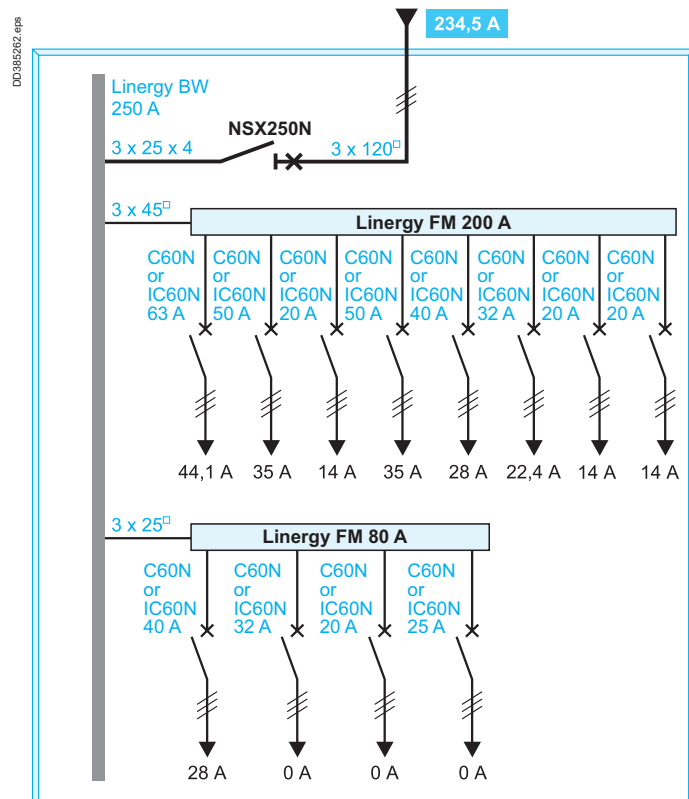

Thermal management of switchboards

Comparative method

Thermal characteristics

Comparative method

You will have no problems with your switchboard if:

- the volume of the enclosure is greater than that of the tested enclosure with a similar assembly
- the P(W) of the installed assembly is less than the P(W) of the tested configuration in the same size enclosure.

Wall-mounted enclosure, 23 modules, plain door, IP30/IP4X

Diversity factor: 0.7

Ambient temperature around the switchboard: 35 °C

P(W) = 200 W

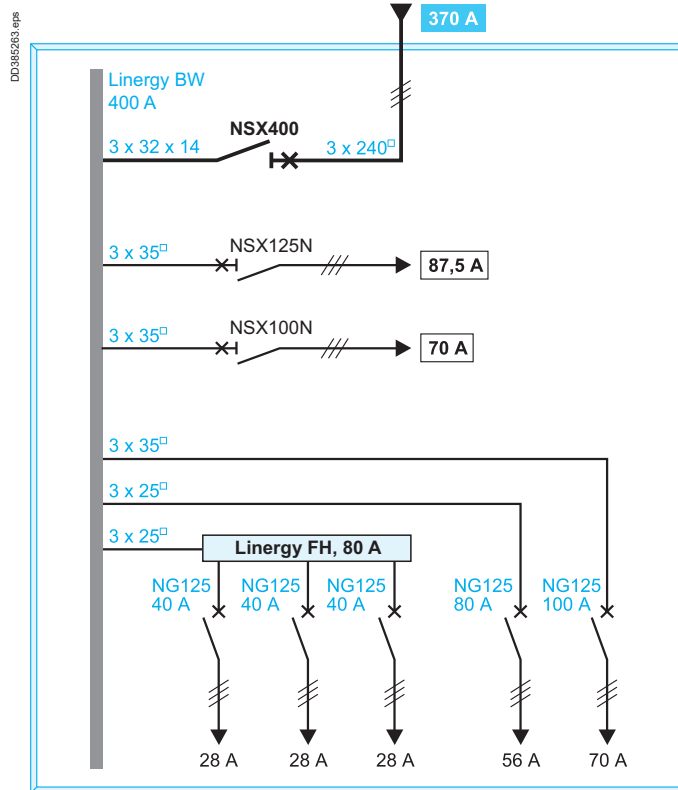

Floor-standing enclosure, 33 modules, IP30/IP4X

Diversity factor: 0.7

Ambient temperature around the switchboard: 35 °C

P(W) = 270 W

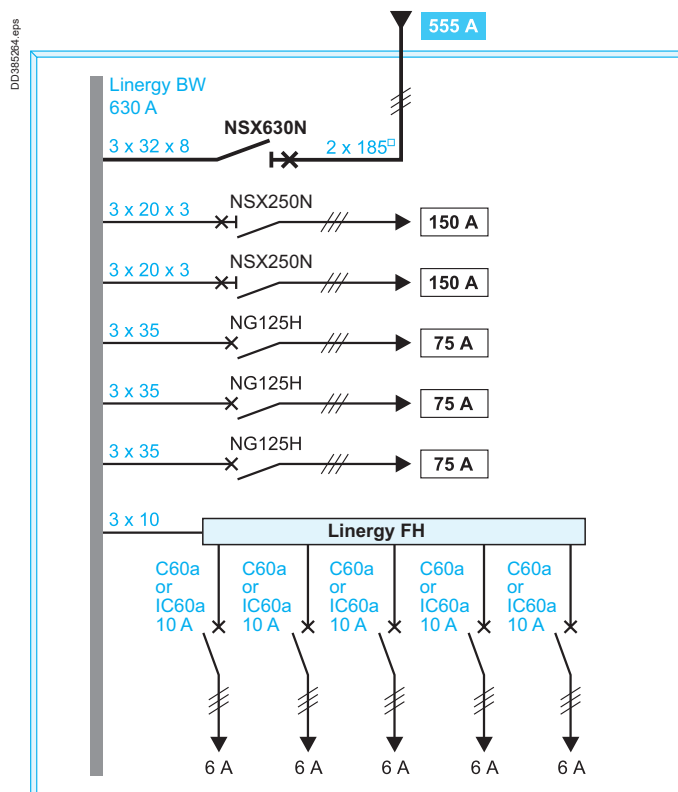

Thermal management of switchboards

Example

Thermal characteristics

Once the dissipated power of the devices has been determined and the enclosure with its IP selected, transfer the results (sum of the dissipated power and width of the device zone) to the chart corresponding to the enclosure IP.

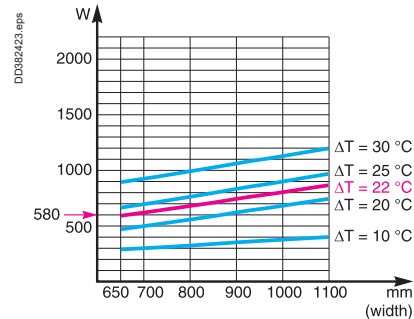

Draw a line parallel to the others on the chart and read the corresponding difference in temperature.

For the given example, the heat rise is 22 °C at mid-height in the enclosure.

The internal temperature = external temperature + heat rise
= 35 °C + 22 °C = 57 °C

57 °C < 60 °C stipulated by the standard, i.e. the result is acceptable for an IP30/IP4X all-mounted and floor-standing enclosures.

This gives roughly:

Internal temperature = 60 °C at mid-height in the enclosure for a low IP value.
= 70 °C at mid-height in the enclosure for a high IP value.

Thermal management of switchboards

Charts

Thermal characteristics

Quick calculation charts for internal temperatures

The indicated internal heat rise is that measured at mid-height in the enclosure.

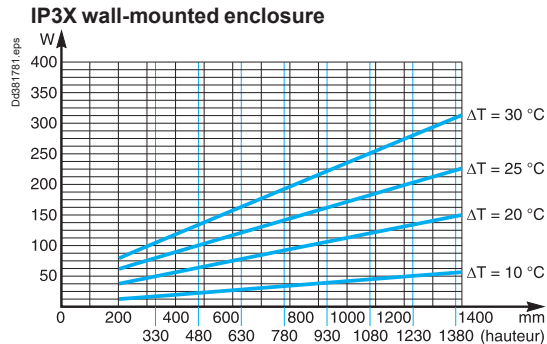

Test conditions:
600 mm wide enclosure mounted directly on wall without fixing lugs.

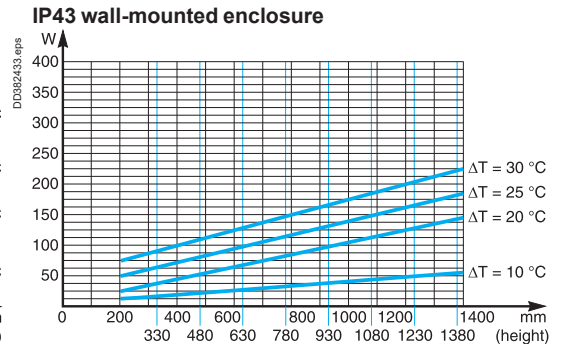

Test conditions:
600 mm wide enclosure mounted directly on wall without fixing lugs.

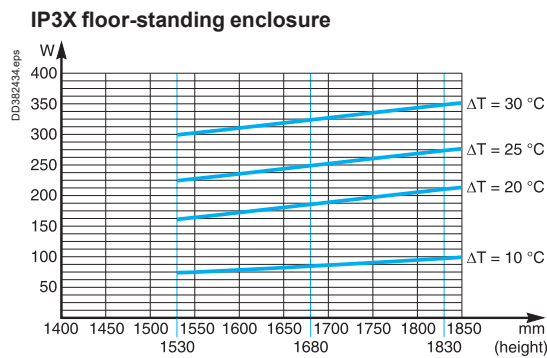

Test conditions:
600 mm wide enclosure on floor against a wall.

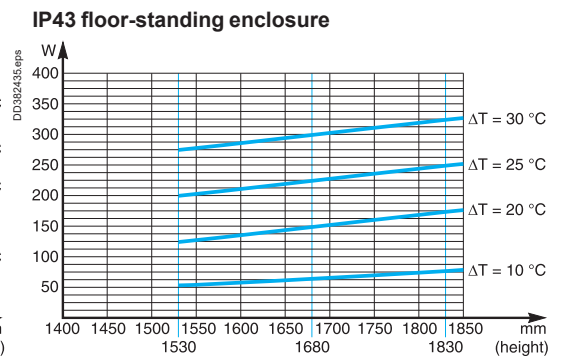

Test conditions:
Mounted on wall with fixing lugs or on mounting uprights.

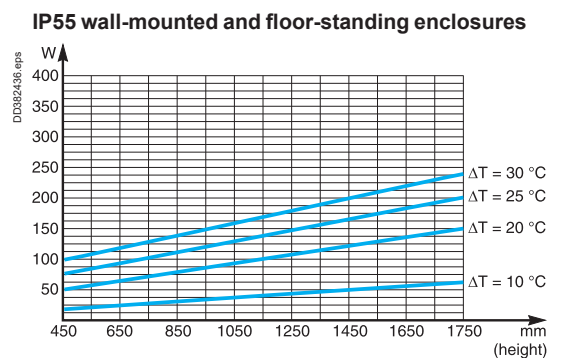

Test conditions:
600 mm wide enclosure mounted directly on wall without fixing lugs or mounting uprights.

Thermal management of switchboards

Ventilation

Thermal characteristics

Switchboard ventilation

The air enters the lower section via the fans and exits the upper section:

- through a ventilated roof
- or through a ventilation opening.

The air throughput of the fans is determined by the equation:

$$D = 3,1 \times \left(\frac{P}{\Delta T} - KS \right)$$

The chart below can be used to determine the necessary throughput, based on the dissipated power, the difference in temperature (internal - external) and the exposed surface area of the enclosure.

Example

Consider an IP3X cubicle, 650 mm wide and 400 mm deep, containing components (devices, connections, busbars, etc.) dissipating 1000 W.

The ambient temperature around the cubicle is 50 °C.

Given that the average temperature at mid-height should not exceed 60 °C, the difference in temperature ΔT is equal to 60 - 50 = 10 °C.

The exposed surface of the cubicle (non adjacent to a wall or other cubicle) is 4.46 m².

(back = 1.3 m², front = 1.3 m², roof = 0.26 m², side panels = 1.6 m²).

What is the necessary throughput of the ventilation system?

The throughput can be calculated as:

$$D = 3,1 \times \left(\frac{1000}{10} - 5,5 \times 4,46 \right)$$

D = 234 m³/h.

In the range of PrismaSeT accessories, select a system with a throughput of 300 m³/h.

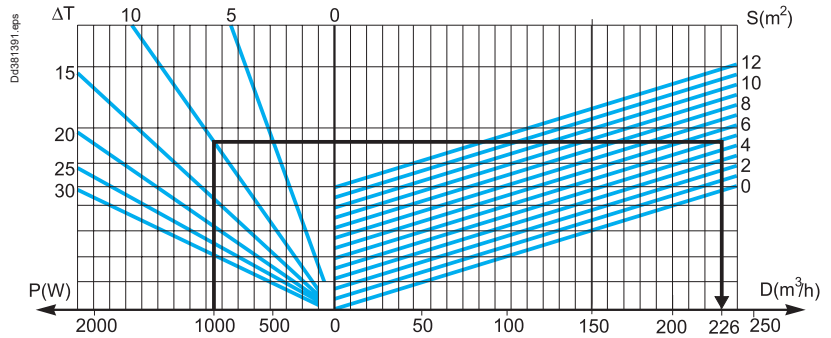

Calculation data

P : power dissipated by the devices, connections and busbars (in Watts)

P_r : power of the heating resistor (in Watts)

T_m : maximum internal temperature in the device zone (in °C)

T_i : average internal temperature (in °C)

T_e : average external temperature (in °C)

$$\Delta T_m = T_m - T_e$$

$$\Delta T = T_i - T_e$$

S : total free surface area of the enclosure (expressed in m²)

K : thermal-conduction coefficient of the material (W/m² °C)

K = 5.5 W/m² °C for painted sheet metal

D : ventilation throughput (in m³/h)

Note: the dissipated power of each device is provided by the manufacturer. Add approximately 30 % to account for the connections and the busbars.

Thermal management of switchboards

Heating

Thermal characteristics

Switchboard heating

The heating resistor, placed in the bottom of the switchboard, maintains the internal temperature 10 °C higher than the external temperature.

When the switchboard is not in operation, the heater compensates the dissipated power normally emitted by the switchboard.

The power of the heating resistor is calculated:

- using the equation: $P_r = (\Delta T \times S \times K) - P$
- or using the charts below, based on the exposed surface area of the enclosure and the desired difference in temperature.

Chart to determine the heating resistor for small wall-mounted enclosures (exposed surfaces ≤ 1 m²)

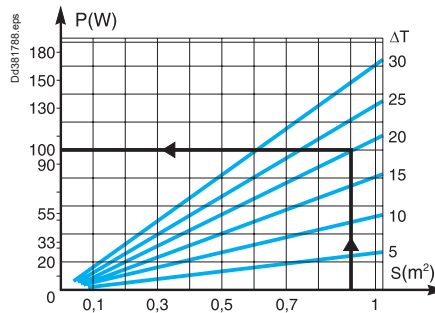
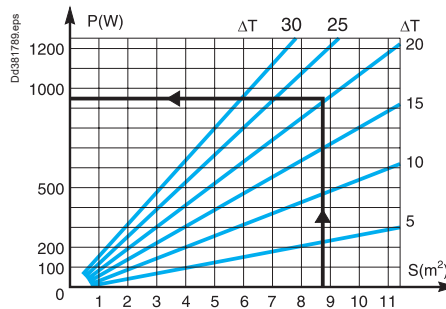

Chart to determine the heating resistor for all types of enclosures



Calculation data

- P** : power dissipated by the devices, connections and busbars (in Watts)
- P_r** : power of the heating resistor (in Watts)
- T_m** : maximum internal temperature in the device zone (in °C)
- T_i** : average internal temperature (in °C)
- T_e** : average external temperature (in °C)

$$\Delta T_m = T_m - T_e$$

$$\Delta T = T_i - T_e$$

S : total free surface area of the enclosure (expressed in m²)

K : thermal-conduction coefficient of the material (W/m² °C)

K = 5.5 W/m² °C for painted sheet metal

D : ventilation throughput (in m³/h)

Note: the dissipated power of each device is provided by the manufacturer. Add approximately 30 % to account for the connections and the busbars.



Life Is On



Schneider Electric Industries SAS

35, rue Joseph Monier
CS 30323
92506 Rueil Malmaison Cedex
France

RCS Nanterre 954 503 439
Capital social 896 313 776 €
www.se.com

04-2022
DESW025EN

© 2022 - Schneider Electric. All Rights Reserved.
All trademarks are owned by Schneider Electric Industries SAS or its affiliated companies.
Document reference: DESW025EN

This document has been
printed on recycled paper

