

## Features

- Schottky barrier diodes
- Low forward voltage drop
- High Junction Temperature
- Moisture sensitivity: level 1, per J-STD-020
- Plastic package has Underwriters Laboratory Flammability Classification 94V-0
- Add suffix "E" for Halogen Free
- Halogen-free according to IEC 61249-2-21 definition
- AEC-Q101 qualified

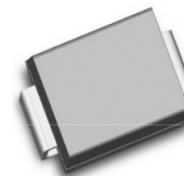

DO-214AA (SMB)

## Typical Applications

For use in low voltage, high frequency inverters, free wheeling, and polarity protection application

<b>Maximum Ratings</b> (TA = 25 °C unless otherwise noted)			
Parameter	Symbol	SK5C0B SK5C0BE	Unit
Maximum repetitive peak reverse voltage	$V_{RRM}$	200	V
Maximum RMS voltage	$V_{RMS}$	140	V
Maximum DC blocking voltage	$V_{DC}$	200	V
Maximum average forward rectified current	$I_{F(AV)}$	5.0	A
Peak forward surge current 8.3 ms single half sine-wave superimposed on rated load	$I_{FSM}$	120	A
Operating junction and storage temperature range	$T_J, T_{STG}$	- 55 to + 150	°C

<b>Electrical Characteristics</b> (TA = 25 °C unless otherwise noted)				
Parameter	Test Conditions	Symbol	SK5C0B SK5C0BE	Unit
Maximum instantaneous forward voltage	$I_F=5A, T_A=25^\circ C$	$V_F$	0.85	V
Maximum DC reverse current at rated DC blocking voltage	$T_A=25^\circ C$	$I_R$	30	uA
	$T_A=125^\circ C$		1000	
Typical junction capacitance	4.0 V, 1 MHz	$C_J$	96	pF

<b>Thermal Characteristics</b>			
Parameter	Symbol	SK5C0B SK5C0BE	Unit
Typical thermal resistance <sup>(1)</sup>	$R_{\theta JA}$	65	°C/W
	$R_{\theta JC}$	25	
	$R_{\theta JI}$	15	

Note1: Thermal resistance from junction to lead, mounted on PCB with 8.0x8.0mm copper pads

## Ratings and Characteristics Curves

(TA = 25°C unless otherwise noted)

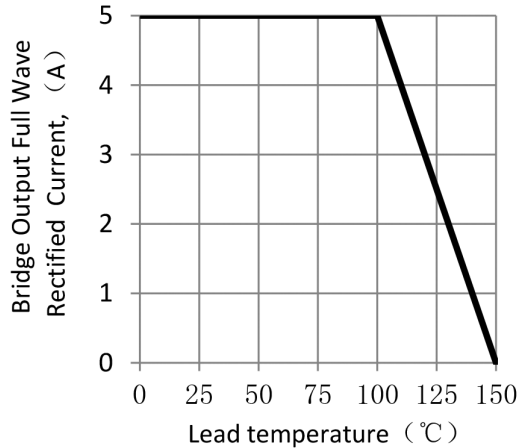

Figure 1. Forward Current Derating Curve

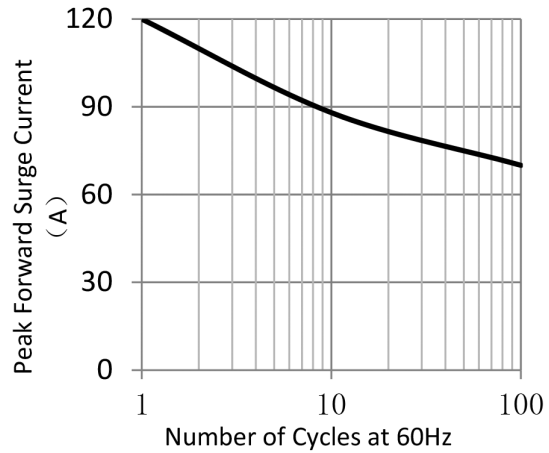

Figure 2. Maximum Non-Repetitive Peak Forward Surge Current

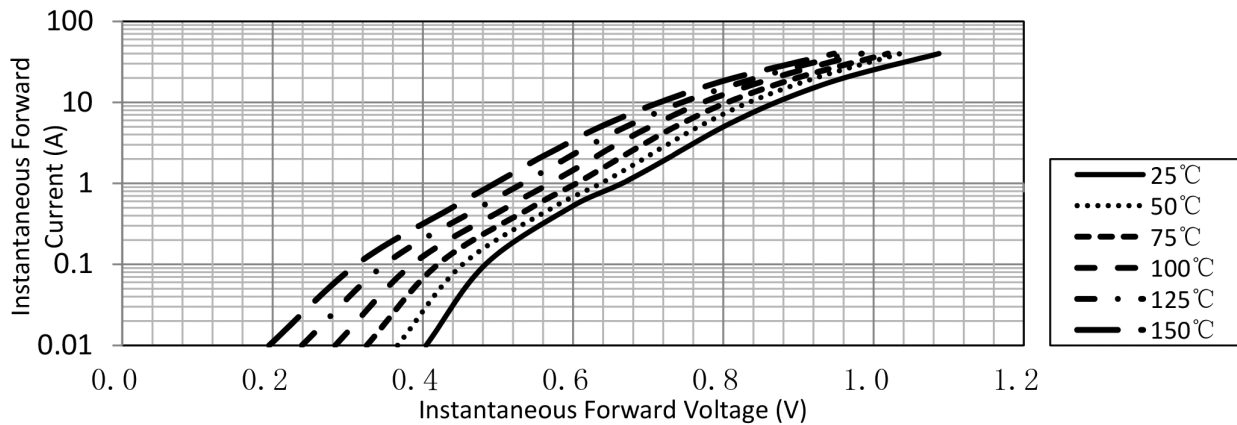

Figure 3. Typical Instantaneous Forward Characteristics

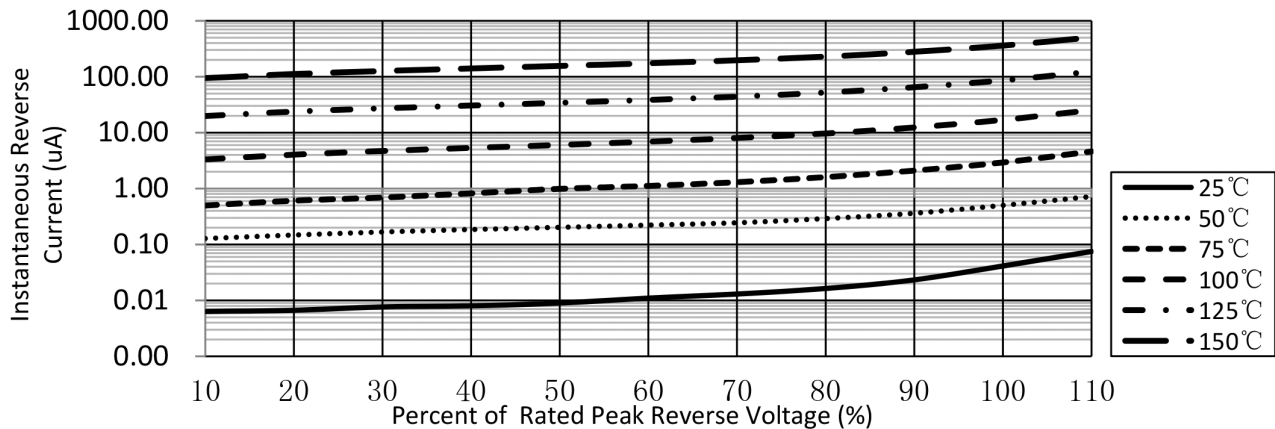
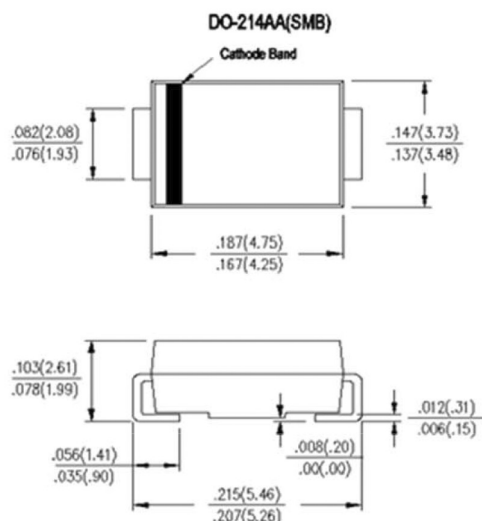

Figure 4. Typical Reverse Characteristics

## Package Outline Dimensions

in inches (millimeters)



## Mounting Pad Layout

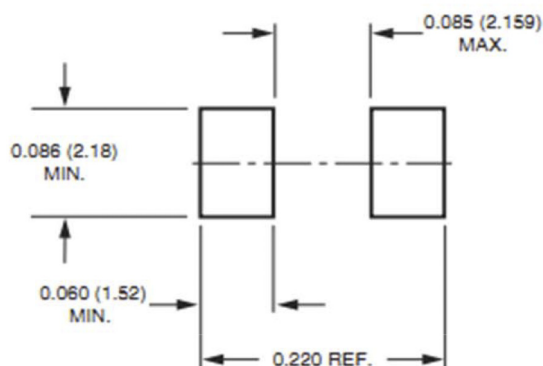

## Packing Information

3000 pcs/Reel, 18 Reels/Box; 12mm Tape, 13" Reel

## Tape & Reel Specification

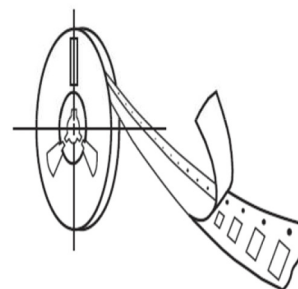
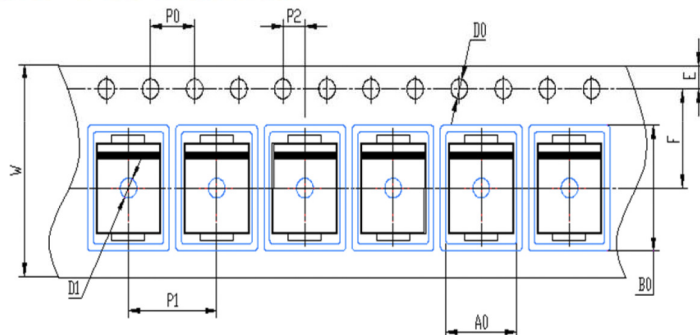

Symbol	SMB (mm)
W	12 ± 0.2
E	1.75 ± 0.1
F	5.5 ± 0.05
D0	1.5 ± 0.1
D1	1.50 +0.1/-0
P0	4.0 ± 0.1
P1	8.0 ± 0.1
P2	2.0 ± 0.05
A0	3.95 ± 0.1
B0	5.74 ± 0.1

## Soldering Parameters

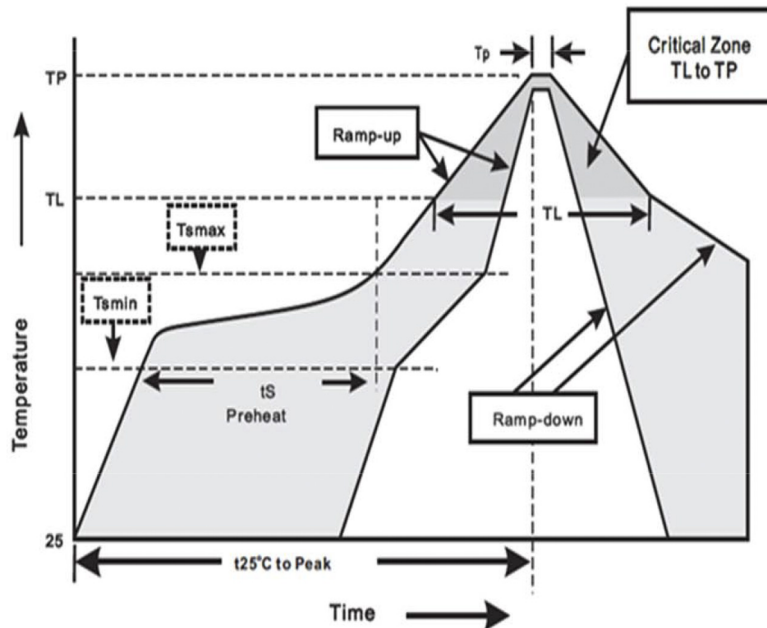

Reflow Soldering		Sn-Pb Eutectic Assembly	Pb-Free assembly
Pre Heat	- Temperature Min (Ts(min))	100°C	150°C
	- Temperature Max (Ts(max))	150°C	200°C
	- Time (min to max) (ts)	60 – 120 secs	60 – 180 secs
Average ramp up rate (Liquidus) Temp (TL) to peak		3°C/second max	3°C/second max
TS(max) to TL - Ramp-up Rate		3°C/second max	3°C/second max
Reflow	- Temperature (TL) (Liquidus)	183°C	217°C
	- Time (min to max) (ts)	60 – 150 seconds	60 – 150 seconds
Peak Temperature (TP)		240+0/-5 °C	240+0/-5°C
Time within 5°C of actual peak Temperature (tp)		10 –30 seconds	20 – 40 seconds
Ramp-down Rate		6°C/second max	6°C/second max
Time 25°C to peak Temperature (TP)		6 minutes Max.	8 minutes Max.
Do not exceed		260°C	260°C

Wave Soldering	
Peak Temperature :	260+0/-5°C
Dipping Time :	10 seconds
Soldering :	1 time