

**System pitch 5.08 mm (0.200 inch)
SL-SMT 5.08/08/90G 3.2SN BK BX**

Weidmüller Interface GmbH & Co. KG
Klingenbergstraße 16
D-32758 Detmold
Germany
Fon: +49 5231 14-0
Fax: +49 5231 14-2083
www.weidmueller.com



High-temperature-resistant male connector, packed in box or tape. In tape with 1.5 mm solder pin optimised for automatic assembly. 3.2 mm solder pin suitable for reflow and wave soldering. These male connectors can be labelled and coded.

- 400 V (IEC) / 300 V (UL)
- 19 A (IEC) / 15 A (UL)

General ordering data

Order No.	1780240000
Part designation	SL-SMT 5.08/08/90G 3.2SN BK BX
Version	PCB plug-in connector, male header, 5.08 mm, No. of poles: 8, 90°, Solder pin length: 3.2 mm, tinned, black, Reflow solder connection, Box
GTIN (EAN)	4032248165568
Qty.	50 pc(s).
Packaging	Box

**System pitch 5.08 mm (0.200 inch)
SL-SMT 5.08/08/90G 3.2SN BK BX**

Weidmüller Interface GmbH & Co. KG
Klingenbergstraße 16
D-32758 Detmold
Germany
Fon: +49 5231 14-0
Fax: +49 5231 14-2083
www.weidmueller.com

Technical data

System parameters

Fitted to PCB	Reflow solder connection	Outgoing elbow	90°
Pitch in mm	5.08 mm	Pitch in inch	0.2 inch
No. of poles	8	Solder pin length	3.2 mm
Can be coded	Yes	No. of rows	1
Number of solder pins per pole	1	L1 in mm	35.56 mm
L1 in inch	1.4 inch		

Material data

Insulating material	LCP GF	Colour	black
Insulating material group	IIIa	Flammability class UL 94	V-0
Contact material	CuSn	Contact surface	tinned
Highest continuous operating temperature, min.	-25 °C	Highest continuous operating temperature, max.	100 °C
Max. relative humidity during storage	80 %		

DIN IEC rating data

Rated current, min. No. of poles (Tu=20°C)	19 A	Rated current, max. No. of poles (Tu=20°C)	15 A
Rated current, no. of poles (Tu=40°C), min.	16 A	Rated current, no. of poles (Tu=40°C), max.	13 A
Rated voltage at overvoltage category/pollution degree III/3	250 V	Rated impulse withstand voltage for overvoltage class/pollution severity III/3	4 kV
Rated voltage for overvoltage class/pollution severity III/2	320 V	Rated impulse withstand voltage for overvoltage class/pollution severity III/2	4 kV
Rated voltage for overvoltage class/pollution severity II/2	400 V	Rated impulse withstand voltage for overvoltage class/pollution severity II/2	4 kV

CSA rating data

Rated voltage (Use group B)	300 V	Rated current (use group B)	15 A
Rated voltage (use group D)	300 V	Rated current (use group D)	10 A

UL 1059 rating data

Rated voltage (use group B)	300 V	Rated current (use group B)	15 A
Rated voltage (use group D)	300 V	Rated current (use group D)	10 A

Approvals

Approvals institutes	CSA; GOSTME25; UR; ROHS
----------------------	-------------------------

Classifications

ETIM 3.0	EC001284	eClass 5.1	27-26-07-04
eClass 6.0	27-26-07-04		

Datasheet

System pitch 5.08 mm (0.200 inch)
SL-SMT 5.08/08/90G 3.2SN BK BX

Weidmüller Interface GmbH & Co. KG
Klingenbergstraße 16
D-32758 Detmold
Germany
Fon: +49 5231 14-0
Fax: +49 5231 14-2083
www.weidmueller.com

Technical data**Notes**

Notes

- Additional colours on request
- Gold-plated contact surfaces on request
- Rated current related to rated cross-section and min. No. of poles.
- Diameter of solder eyelet $D = 1.4 \pm 0.1$ mm
- Diameter of solder eyelet $D = 1.5 \pm 0.1$ mm from 9-pole
- P on drg. = pitch
- Rated data refer only to the component itself. Clearance and creepage distances to other components are to be designed in accordance with the relevant application standards.

Datasheet

System pitch 5.08 mm (0.200 inch)
SL-SMT 5.08/08/90G 3.2SN BK BX

Weidmüller Interface GmbH & Co. KG
Klingenbergstraße 16
D-32758 Detmold
Germany
Fon: +49 5231 14-0
Fax: +49 5231 14-2083
www.weidmueller.com

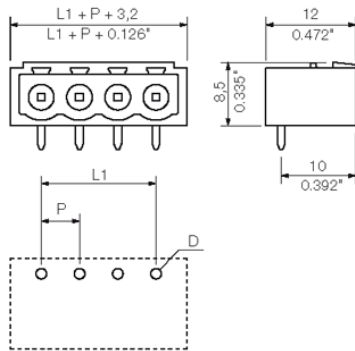
Drawings

System pitch 5.08 mm (0.200 inch) SL-SMT 5.08/08/90G 3.2SN BK BX

Weidmüller Interface GmbH & Co. KG
 Klingenbergstraße 16
 D-32758 Detmold
 Germany
 Fon: +49 5231 14-0
 Fax: +49 5231 14-2083
 www.weidmueller.com

Counterpart

BLZP 5.08/225 SN



Clamping-yoke wire connection with right-angled (90° or 270°) or angled (225°) outlet direction. The female connectors provide space for labelling and can be coded. Can be fastened with flange or release latch. They feature an integrated plus/minus screw, protection against false insertion under clamping yoke. They are delivered with an opened clamping yoke.

- 0.2-2.5 mm² (IEC) / 26-12 AWG (UL)
- 400 V (IEC) / 300 V (UL)
- 17.5 A (IEC) / 10 A (UL)

General ordering data

Order No.	Part designation	Version	GTIN (EAN)	Qty.	Packaging
1946310000	BLZP 5.08/08/225 SN OR BX	PCB plug-in connector, female plug, 5.08 mm, No. of poles: 8, 225°, Clamping yoke connection, Clamping range, max.: 4 mm ² , Box	4032248621880	42 pc(s).	Box
1946620000	BLZP 5.08/08/225 SN BK BX	PCB plug-in connector, female plug, 5.08 mm, No. of poles: 8, 225°, Clamping yoke connection, Clamping range, max.: 4 mm ² , Box	4032248622399	42 pc(s).	Box

BLZP 5.08/180 SN



Female connectors with clamping yoke screw connection for conductor connection with straight (180°) outlet direction. The female connectors provide space for labelling and can be coded. Can be fastened with flange or release latch. They feature an integrated plus/minus screw, protection against false insertion under clamping yoke. They are delivered with an opened clamping yoke.

- 0.2-2.5 mm² (IEC) / 26-12 AWG (UL)
- 400 V (IEC) / 300 V (UL)
- 19 A (IEC) / 15 A (UL)

General ordering data

Order No.	Part designation	Version	GTIN (EAN)	Qty.	Packaging
1943870000	BLZP 5.08/08/180 SN BK BX	PCB plug-in connector, female plug, 5.08 mm, No. of poles: 8, 180°, Clamping yoke connection, Clamping range, max.: 4 mm ² , Box	4032248617913	45 pc(s).	Box
1943640000	BLZP 5.08/08/180 SN OR BX	PCB plug-in connector, female plug, 5.08 mm, No. of poles: 8, 180°, Clamping yoke connection, Clamping range, max.: 4 mm ² , Box	4032248617647	45 pc(s).	Box

System pitch 5.08 mm (0.200 inch) SL-SMT 5.08/08/90G 3.2SN BK BX

Weidmüller Interface GmbH & Co. KG
 Klingenbergstraße 16
 D-32758 Detmold
 Germany
 Fon: +49 5231 14-0
 Fax: +49 5231 14-2083
 www.weidmueller.com

Counterpart

BLF 5.08/90 SN



Just as reliable as the tried-and-true original, with innovation in detail:

The BLF 5.0x – the PUSH-IN version of the BLZ 5.0x socket block – features a new connection system and a more compact design. Weidmüller's innovative PUSH-IN spring connection features a trend-setting, tool-free wire connection system that is simple to operate.

In terms of versatility, the BLF 5.0x offers just as much as the older versions:

- The choice of three wire outlet directions offers you proven design flexibility for your applications.
- Four flange variations, including the patented release latch, allow for user-friendly unplugging designs.

General ordering data

Order No.	Part designation	Version	GTIN (EAN)	Qty.	Packaging
1000090001	BLF 5.08/08/90 SN BK BX	PCB plug-in connector, female plug, 5.08 mm, No. of poles: 8, 90°, PUSH IN, Clamping range, max.: 3.31 mm², Box	4032248690022	42 pc(s).	Box
1001590000	BLF 5.08/08/90 SN OR BX	PCB plug-in connector, female plug, 5.08 mm, No. of poles: 8, 90°, PUSH IN, Clamping range, max.: 3.31 mm², Box	4032248693399	42 pc(s).	Box

BLZP 5.00/270 SN

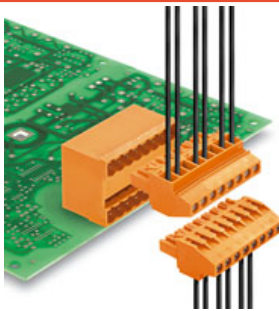

Socket connectors with clamping yoke screw connection for conductor connection with a right-angle (90° or 270°) outlet direction. The female connectors provide space for labelling and can be coded. Can be fastened with flange or release latch. They feature an integrated plus/minus screw, protection against false insertion under clamping yoke. They are delivered with an opened clamping yoke.

- 0.2-2.5 mm² (IEC) / 26-12 AWG (UL)
- 400 V (IEC) / 300 V (UL)
- 15 A (IEC) / 10 A (UL)

General ordering data

Order No.	Part designation	Version	GTIN (EAN)	Qty.	Packaging
1958810000	BLZP 5.00/08/270 SN OR BX	PCB plug-in connector, female plug, 5.00 mm, No. of poles: 8, 90°, Clamping yoke connection, Clamping range, max.: 4 mm², Box	4032248637645	42 pc(s).	Box
1959040000	BLZP 5.00/08/270 SN BK BX	PCB plug-in connector, female plug, 5.00 mm, No. of poles: 8, 90°, Clamping yoke connection, Clamping range, max.: 4 mm², Box	4032248637973	42 pc(s).	Box

System pitch 5.08 mm (0.200 inch) SL-SMT 5.08/08/90G 3.2SN BK BX

Weidmüller Interface GmbH & Co. KG
 Klingenbergstraße 16
 D-32758 Detmold
 Germany
 Fon: +49 5231 14-0
 Fax: +49 5231 14-2083
 www.weidmueller.com

Counterpart

BLZ 5.00/270



Female connectors with clamping yoke screw connection. The female connectors provide space for labelling and can be coded. Packed in cardboard box.

- 0.20 - 2.5 mm² (IEC) / 26 - 12 AWG (UL)
- 400 V (IEC) / 300 V (UL)
- 15 A (IEC) / 10 A (UL)

General ordering data

Order No.	Part designation	Version	GTIN (EAN)	Qty.	Packaging
1637640000	BLZ 5.00/08/270 SN OR BX	PCB plug-in connector, female plug, 5.00 mm, No. of poles: 8, 270°, Clamping yoke connection, Clamping range, max.: 3.31 mm ² , Box	4008190274887	42 pc(s).	Box
1637870000	BLZ 5.00/08/270 SN BK BX	PCB plug-in connector, female plug, 5.00 mm, No. of poles: 8, 270°, Clamping yoke connection, Clamping range, max.: 3.31 mm ² , Box	4008190275112	42 pc(s).	Box

BLL 5.08/180



Female connector for PCB mounting. The solder pin length is optimised for wave flow soldering. Packed in cardboard box.

- 400 V (IEC) / 300 V (UL)
- 23 A (IEC) / 15 A (UL)

General ordering data

Order No.	Part designation	Version	GTIN (EAN)	Qty.	Packaging
1630770000	BLL 5.08/08/180 3.2SN OR BX	PCB plug-in connector, female header, 5.08 mm, No. of poles: 8, 180°, Solder pin length: 3.2 mm, tinned, Orange, Solder connection, Box	4008190204198	50 pc(s).	Box

System pitch 5.08 mm (0.200 inch) SL-SMT 5.08/08/90G 3.2SN BK BX

Weidmüller Interface GmbH & Co. KG
 Klingenbergstraße 16
 D-32758 Detmold
 Germany
 Fon: +49 5231 14-0
 Fax: +49 5231 14-2083
 www.weidmueller.com

Counterpart

BLZF 5.08/180



Female connectors for connecting conductors with tension clamp system, straight 180° outlet direction. The female connectors include space for labelling and can be coded. Packed in cardboard box.

- 0.20 - 2.5 mm² (IEC) / 26 - 12 AWG (UL)
- 400 V (IEC) / 300 V (UL)
- 17 A (IEC) / 15 A (UL)

General ordering data

Order No.	Part designation	Version	GTIN (EAN)	Qty.	Packaging
1707750000	BLZF 5.08/08/180 SN BK BX	PCB plug-in connector, female plug, 5.08 mm, No. of poles: 8, 180°, Tension clamp connection, Clamping range, max.: 3.31 mm ² , Box	4008190316754	42 pc(s).	Box
1707520000	BLZF 5.08/08/180 SN OR BX	PCB plug-in connector, female plug, 5.08 mm, No. of poles: 8, 180°, Tension clamp connection, Clamping range, max.: 3.31 mm ² , Box	4008190395889	42 pc(s).	Box

BLF 5.00/90 SN



Just as reliable as the tried-and-true original, with innovation in detail:

The BLF 5.0x – the PUSH-IN version of the BLZ 5.0x socket block – features a new connection system and a more compact design. Weidmüller's innovative PUSH-IN spring connection features a trend-setting, tool-free wire connection system that is simple to operate.

In terms of versatility, the BLF 5.0x offers just as much as the older versions:

- The choice of three wire outlet directions offers you proven design flexibility for your applications.
- Four flange variations, including the patented release latch, allow for user-friendly unplugging designs.

General ordering data

Order No.	Part designation	Version	GTIN (EAN)	Qty.	Packaging
1980230000	BLF 5.00/08/90 SN OR BX	PCB plug-in connector, female plug, 5.00 mm, No. of poles: 8, 90°, PUSH IN, Clamping range, max.: 3.31 mm ² , Box	4032248675319	42 pc(s).	Box
1979330000	BLF 5.00/08/90 SN BK BX	PCB plug-in connector, female plug, 5.00 mm, No. of poles: 8, 90°, PUSH IN, Clamping range, max.: 3.31 mm ² , Box	4032248674534	42 pc(s).	Box

System pitch 5.08 mm (0.200 inch) SL-SMT 5.08/08/90G 3.2SN BK BX

Weidmüller Interface GmbH & Co. KG
 Klingenbergstraße 16
 D-32758 Detmold
 Germany
 Fon: +49 5231 14-0
 Fax: +49 5231 14-2083
 www.weidmueller.com

Counterpart

BLIDC 5.08



Female connectors for conductor connection with IDC system. The female connectors provide space for labelling and can be coded. Packed in cardboard box.

- 0.35 - 0.75 mm² (IEC) / 22 - 20 AWG (UL)
- 400 V (IEC) / 300 V (UL)
- 11 A (IEC) / 5 A (UL)

General ordering data

Order No.	Part designation	Version	GTIN (EAN)	Qty.	Packaging
1725000000	BLIDC 5.08/08/180 SN OR BX	PCB plug-in connector, female plug, 5.08 mm, No. of poles: 8, 180°, IDC terminal, Clamping range, max.: 0.75 mm ² , Box	4008190377342	50 pc(s).	Box

BLZP 5.00/90 SN



Socket connectors with clamping yoke screw connection for conductor connection with a right-angle (90° or 270°) outlet direction. The female connectors provide space for labelling and can be coded. Can be fastened with flange or release latch. They feature an integrated plus/minus screw, protection against false insertion under clamping yoke. They are delivered with an opened clamping yoke.

- 0.2-2.5 mm² (IEC) / 26-12 AWG (UL)
- 400 V (IEC) / 300 V (UL)
- 15 A (IEC) / 10 A (UL)

General ordering data

Order No.	Part designation	Version	GTIN (EAN)	Qty.	Packaging
1958230000	BLZP 5.00/08/90 SN OR BX	PCB plug-in connector, female plug, 5.00 mm, No. of poles: 8, 90°, Clamping yoke connection, Clamping range, max.: 4 mm ² , Box	4032248637102	42 pc(s).	Box
1958590000	BLZP 5.00/08/90 SN BK BX	PCB plug-in connector, female plug, 5.00 mm, No. of poles: 8, 90°, Clamping yoke connection, Clamping range, max.: 4 mm ² , Box	4032248637331	42 pc(s).	Box

System pitch 5.08 mm (0.200 inch) SL-SMT 5.08/08/90G 3.2SN BK BX

Weidmüller Interface GmbH & Co. KG
 Klingenbergstraße 16
 D-32758 Detmold
 Germany
 Fon: +49 5231 14-0
 Fax: +49 5231 14-2083
 www.weidmueller.com

Counterpart

BLZ 5.00/90

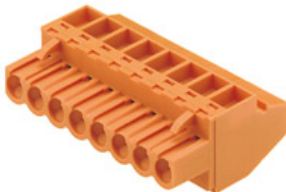

Female connectors with clamping yoke screw connection. The female connectors provide space for labelling and can be coded. Packed in cardboard box.

- 0.20 - 2.5 mm² (IEC) / 26 - 12 AWG (UL)
- 400 V (IEC) / 300 V (UL)
- 15 A (IEC) / 10 A (UL)

General ordering data

Order No.	Part designation	Version	GTIN (EAN)	Qty.	Packaging
163600000	BLZ 5.00/08/90 SN OR BX	PCB plug-in connector, female plug, 5.00 mm, No. of poles: 8, 90°, Clamping yoke connection, Clamping range, max.: 3.31 mm ² , Box	4008190265793	42 pc(s).	Box
1636950000	BLZ 5.00/08/90 SN BK BX	PCB plug-in connector, female plug, 5.00 mm, No. of poles: 8, 90°, Clamping yoke connection, Clamping range, max.: 3.31 mm ² , Box	4008190274191	42 pc(s).	Box

BLZF 5.08/90



Female connectors for connecting conductors with tension clamp system. The female connectors include space for labelling and can be coded. Packed in cardboard box.

- 0.20 - 2.5 mm² (IEC) / 26 - 12 AWG (UL)
- 400 V (IEC) / 300 V (UL)
- 16.5 A (IEC) / 10 A (UL)

General ordering data

Order No.	Part designation	Version	GTIN (EAN)	Qty.	Packaging
1670850000	BLZF 5.08/08/90 SN OR BX	PCB plug-in connector, female plug, 5.08 mm, No. of poles: 8, 90°, Tension clamp connection, Clamping range, max.: 3.31 mm ² , Box	4008190432454	42 pc(s).	Box
1671080000	BLZF 5.08/08/90 SN BK BX	PCB plug-in connector, female plug, 5.08 mm, No. of poles: 8, 90°, Tension clamp connection, Clamping range, max.: 3.31 mm ² , Box	4008190432751	42 pc(s).	Box

**System pitch 5.08 mm (0.200 inch)
SL-SMT 5.08/08/90G 3.2SN BK BX**

Weidmüller Interface GmbH & Co. KG
Klingenbergstraße 16
D-32758 Detmold
Germany
Fon: +49 5231 14-0
Fax: +49 5231 14-2083
www.weidmueller.com

Counterpart
BL 5.00

Female connectors for conductor connection in leaf spring system. Packed in cardboard box. The female connectors provide space for labelling. Packed in cardboard box.

- 0.2 - 1.5 mm² (IEC) / 26 - 14 AWG (UL)
- 400 V (IEC) / 300 V (UL)
- 11 A (IEC) / 10 A (UL)

General ordering data

Order No.	Part designation	Version	GTIN (EAN)	Qty.	Packaging
1723170000	BL 5.00/08/180 SN OR BX	PCB plug-in connector, female plug, 5.00 mm, No. of poles: 8, 180°, Leaf spring connection, Clamping range, max.: 2.08 mm ² , Box	4032248002573	50 pc(s).	Box
1730760000	BL 5.00/08/180 SN BK BX	PCB plug-in connector, female plug, 5.00 mm, No. of poles: 8, 180°, Leaf spring connection, Clamping range, max.: 2.08 mm ² , Box	4008190387273	50 pc(s).	Box

BLZP 5.00/180 SN

Female connectors with clamping yoke screw connection for conductor connection with straight (180°) outlet direction. The female connectors provide space for labelling and can be coded. Can be fastened with flange or release latch. They feature an integrated plus/minus screw, protection against false insertion under clamping yoke. They are delivered with an opened clamping yoke.

- 0.2-2.5 mm² (IEC) / 26-12 AWG (UL)
- 400 V (IEC) / 300 V (UL)
- 19 A (IEC) / 15 A (UL)

General ordering data

Order No.	Part designation	Version	GTIN (EAN)	Qty.	Packaging
1955510000	BLZP 5.00/08/180 SN BK BX	PCB plug-in connector, female plug, 5.00 mm, No. of poles: 8, 180°, Clamping yoke connection, Clamping range, max.: 4 mm ² , Box	4032248634002	45 pc(s).	Box
1954430000	BLZP 5.00/08/180 SN OR BX	PCB plug-in connector, female plug, 5.00 mm, No. of poles: 8, 180°, Clamping yoke connection, Clamping range, max.: 4 mm ² , Box	4032248633142	45 pc(s).	Box

System pitch 5.08 mm (0.200 inch) SL-SMT 5.08/08/90G 3.2SN BK BX

Weidmüller Interface GmbH & Co. KG
 Klingenbergstraße 16
 D-32758 Detmold
 Germany
 Fon: +49 5231 14-0
 Fax: +49 5231 14-2083
 www.weidmueller.com

Counterpart

BLIDC 5.08B



Female connectors for conductor connection with IDC system. The female connectors provide space for labelling and can be coded. Packed in cardboard box.

- 0.35 - 0.75 mm² (IEC) / 22 - 20 AWG (UL)
- 400 V (IEC) / 300 V (UL)
- 11 A (IEC) / 5 A (UL)

General ordering data

Order No.	Part designation	Version	GTIN (EAN)	Qty.	Packaging
1759670000	BLIDC 5.08/08/180B SN BK BX	PCB plug-in connector, female plug, 5.08 mm, No. of poles: 8, 180°, IDC terminal, Clamping range, max.: 0.75 mm ² , Box	4032248069903	50 pc(s).	Box

BLZP 5.08/270 SN

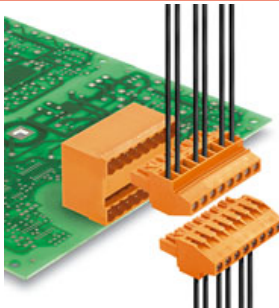

Socket connectors with clamping yoke screw connection for conductor connection with a right-angle (90° or 270°) outlet direction. The female connectors provide space for labelling and can be coded. Can be fastened with flange or release latch. They feature an integrated plus/minus screw, protection against false insertion under clamping yoke. They are delivered with an opened clamping yoke.

- 0.2-2.5 mm² (IEC) / 26-12 AWG (UL)
- 400 V (IEC) / 300 V (UL)
- 15 A (IEC) / 10 A (UL)

General ordering data

Order No.	Part designation	Version	GTIN (EAN)	Qty.	Packaging
1948850000	BLZP 5.08/08/270 SN OR BX	PCB plug-in connector, female plug, 5.08 mm, No. of poles: 8, 270°, Clamping yoke connection, Clamping range, max.: 4 mm ² , Box	4032248626304	42 pc(s).	Box
1949080000	BLZP 5.08/08/270 SN BK BX	PCB plug-in connector, female plug, 5.08 mm, No. of poles: 8, 270°, Clamping yoke connection, Clamping range, max.: 4 mm ² , Box	4032248626533	42 pc(s).	Box

System pitch 5.08 mm (0.200 inch) SL-SMT 5.08/08/90G 3.2SN BK BX

Weidmüller Interface GmbH & Co. KG
 Klingenbergstraße 16
 D-32758 Detmold
 Germany
 Fon: +49 5231 14-0
 Fax: +49 5231 14-2083
 www.weidmueller.com

Counterpart

BLZFS 5.00/180



Female connectors for connecting conductors with tension clamp system, straight 180° outlet direction in thin-element design. The female connectors include space for labelling and can be coded. Packed in cardboard box.

- 0.20 - 2.5 mm² (IEC) / 26 - 14 AWG (UL)
- 400 V (IEC) / 300 V (UL)
- 17 A (IEC) / 10 A (UL)

General ordering data

Order No.	Part designation	Version	GTIN (EAN)	Qty.	Packaging
1696660000	BLZFS 5.00/08/180 SN BK BX	PCB plug-in connector, female plug, 5.00 mm, No. of poles: 8, 180°, Tension clamp connection, Clamping range, max.: 2.5 mm ² , Box	4008190878689	50 pc(s).	Box
1696430000	BLZFS 5.00/08/180 SN OR BX	PCB plug-in connector, female plug, 5.00 mm, No. of poles: 8, 180°, Tension clamp connection, Clamping range, max.: 2.5 mm ² , Box	4008190878450	50 pc(s).	Box

BL 5.08



Female connectors for conductor connection in leaf spring system. Packed in cardboard box. The female connectors provide space for labelling. Packed in cardboard box.

- 0.2 - 1.5 mm² (IEC) / 26 - 14 AWG (UL)
- 400 V (IEC) / 300 V (UL)
- 11 A (IEC) / 10 A (UL)

General ordering data

Order No.	Part designation	Version	GTIN (EAN)	Qty.	Packaging
1723890000	BL 5.08/08/180 SN DKGX BX	PCB plug-in connector, female plug, 5.08 mm, No. of poles: 8, 180°, Leaf spring connection, Clamping range, max.: 2.08 mm ² , Box	4008190376253	50 pc(s).	Box
1716530000	BL 5.08/08/180 SN BK BX	PCB plug-in connector, female plug, 5.08 mm, No. of poles: 8, 180°, Leaf spring connection, Clamping range, max.: 2.08 mm ² , Box	4008190376604	50 pc(s).	Box
1716380000	BL 5.08/08/180 SN OR BX	PCB plug-in connector, female plug, 5.08 mm, No. of poles: 8, 180°, Leaf spring connection,	4008190376420	50 pc(s).	Box

System pitch 5.08 mm (0.200 inch) SL-SMT 5.08/08/90G 3.2SN BK BX

Weidmüller Interface GmbH & Co. KG
 Klingenbergstraße 16
 D-32758 Detmold
 Germany
 Fon: +49 5231 14-0
 Fax: +49 5231 14-2083
 www.weidmueller.com

Counterpart

Clamping range, max.: 2.08
mm², Box

BLZ 5.00/180



Female connectors with clamping yoke screw connection for conductor connection with straight outlet direction. The female connectors provide space for labelling and can be coded. Packed in cardboard box.

- 0.20 - 2.5 mm² (IEC) / 26 - 12 AWG (UL)
- 400 V (IEC) / 300 V (UL)
- 19 A (IEC) / 15 A (UL)

General ordering data

Order No.	Part designation	Version	GTIN (EAN)	Qty.	Packaging
1571410000	BLZ 5.00/08/180 SN OR BX	PCB plug-in connector, female plug, 5.00 mm, No. of poles: 8, 180°, Clamping yoke connection, Clamping range, max.: 3.31 mm ² , Box	4008190052386	50 pc(s).	Box
1596110000	BLZ 5.00/08/180 SN BK BX	PCB plug-in connector, female plug, 5.00 mm, No. of poles: 8, 180°, Clamping yoke connection, Clamping range, max.: 3.31 mm ² , Box	4008190014223	50 pc(s).	Box

BLT 5.08



Female connectors with TOP screw system for connecting conductors with straight 180° outlet direction. The female connectors include space for labelling and can be coded. Packed in cardboard box.

- 0.20 - 2.5 mm² (IEC) / 26 - 14 AWG (UL)
- 400 V (IEC) / 300 V (UL)
- 17 A (IEC) / 10 A (UL)

General ordering data

Order No.	Part designation	Version	GTIN (EAN)	Qty.	Packaging
1500160000	BLT 5.08/08/180 SN OR BX	PCB plug-in connector, female plug, 5.08 mm, No. of poles: 8, 180°, TOP connection, Clamping range, max.: 2.5 mm ² , Box	4008190009152	42 pc(s).	Box
1500110000	BLT 5.08/08/180 SN BK BX	PCB plug-in connector, female plug, 5.08 mm, No. of poles: 8, 180°, TOP connection,	4008190861742	42 pc(s).	Box

System pitch 5.08 mm (0.200 inch) SL-SMT 5.08/08/90G 3.2SN BK BX

Weidmüller Interface GmbH & Co. KG
 Klingenbergstraße 16
 D-32758 Detmold
 Germany
 Fon: +49 5231 14-0
 Fax: +49 5231 14-2083
 www.weidmueller.com

Counterpart

Clamping range, max.: 2.5
mm², Box

BLC 5.08R



Female connectors for conductor connection with crimp connection system. The female connectors provide space for labelling and can be coded. Packed in cardboard box.

- 0.25 - 2.5 mm² (IEC) / 26 - 14 AWG (UL)
- 400 V (IEC) / 300 V (UL)
- 21 A (IEC) / 10 A (UL)

General ordering data

Order No.	Part designation	Version	GTIN (EAN)	Qty.	Packaging
1610550000	BLC 5.08/08/180R OR BX	PCB plug-in connector, female plug, 5.08 mm, No. of poles: 8, 180°, Crimp connection, Clamping range, max.: 2.5 mm ² , Box	4008190080563	50 pc(s).	Box
1712020000	BLC 5.08/08/180R BK BX	PCB plug-in connector, female plug, 5.08 mm, No. of poles: 8, 180°, Crimp connection, Clamping range, max.: 2.5 mm ² , Box	4008190935030	50 pc(s).	Box

BLZ 5.08/180



Female connectors with clamping yoke screw connection for conductor connection with straight outlet direction. The female connectors provide space for labelling and can be coded. Packed in cardboard box.

- 0.20 - 2.5 mm² (IEC) / 26 - 12 AWG (UL)
- 400 V (IEC) / 300 V (UL)
- 19 A (IEC) / 15 A (UL)

General ordering data

Order No.	Part designation	Version	GTIN (EAN)	Qty.	Packaging
1527060000	BLZ 5.08/08/180 SN OR BX	PCB plug-in connector, female plug, 5.08 mm, No. of poles: 8, 180°, Clamping yoke connection, Clamping range, max.: 3.31 mm ² , Box	4008190152314	50 pc(s).	Box
1527010000	BLZ 5.08/08/180 SN BK BX	PCB plug-in connector, female plug, 5.08 mm, No. of poles: 8, 180°, Clamping yoke	4008190138967	50 pc(s).	Box

System pitch 5.08 mm (0.200 inch) SL-SMT 5.08/08/90G 3.2SN BK BX

Weidmüller Interface GmbH & Co. KG
 Klingenbergstraße 16
 D-32758 Detmold
 Germany
 Fon: +49 5231 14-0
 Fax: +49 5231 14-2083
 www.weidmueller.com

Counterpart

connection, Clamping range,
 max.: 3.31 mm², Box

BLDT 5.08

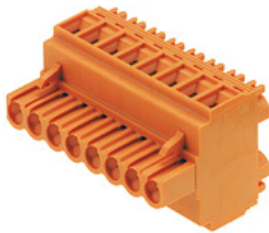

Female connectors with two clamping yoke screw connections per pole for conductor connection with 90° & 270° outlet direction. The female connectors provide space for labelling and can be coded. Packed in cardboard box.

- 0.20 - 2.5 mm² (IEC) / 26 - 12 AWG (UL)
- 400 V (IEC) / 300 V (UL)
- 14 A (IEC) / 10 A (UL)

General ordering data

Order No.	Part designation	Version	GTIN (EAN)	Qty.	Packaging
1644790000	BLDT 5.08/08/- SN OR BX	PCB plug-in connector, female plug, 5.08 mm, No. of poles: 8, 90°/270°, Clamping yoke connection, Clamping range, max.: 3.31 mm ² , Box	4008190284008	50 pc(s).	Box
1660770000	BLDT 5.08/08/- SN BK BX	PCB plug-in connector, female plug, 5.08 mm, No. of poles: 8, 90°/270°, Clamping yoke connection, Clamping range, max.: 3.31 mm ² , Box	4008190417222	50 pc(s).	Box

BLZ 5.08/90

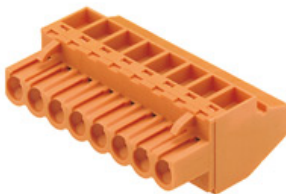

Female connectors with clamping yoke screw connection. The female connectors provide space for labelling and can be coded. Packed in cardboard box.

- 0.20 - 2.5 mm² (IEC) / 26 - 12 AWG (UL)
- 400 V (IEC) / 300 V (UL)
- 15 A (IEC) / 10 A (UL)

General ordering data

Order No.	Part designation	Version	GTIN (EAN)	Qty.	Packaging
1553310000	BLZ 5.08/08/90 SN BK BX	PCB plug-in connector, female plug, 5.08 mm, No. of poles: 8, 90°, Clamping yoke connection, Clamping range, max.: 3.31 mm ² , Box	4008190267773	42 pc(s).	Box
1553360000	BLZ 5.08/08/90 SN OR BX	PCB plug-in connector, female plug, 5.08 mm, No. of poles: 8, 90°, Clamping yoke connection,	4008190001315	42 pc(s).	Box

System pitch 5.08 mm (0.200 inch) SL-SMT 5.08/08/90G 3.2SN BK BX

Weidmüller Interface GmbH & Co. KG
 Klingenbergstraße 16
 D-32758 Detmold
 Germany
 Fon: +49 5231 14-0
 Fax: +49 5231 14-2083
 www.weidmueller.com

Counterpart

Clamping range, max.: 3.31
 mm², Box

BLL 5.08/90



Female connector for PCB mounting. The solder pin length is optimised for wave flow soldering. Packed in cardboard box.

- 400 V (IEC) / 300 V (UL)
- 23 A (IEC) / 15 A (UL)

General ordering data

Order No.	Part designation	Version	GTIN (EAN)	Qty.	Packaging
1623000000	BLL 5.08/08/90 3.2SN OR BX	PCB plug-in connector, female header, 5.08 mm, No. of poles: 8, 90°, Solder pin length: 3.2 mm, tinned, Orange, Solder connection, Box	4008190194055	50 pc(s).	Box

BLZ 5.08/225



Female connectors with clamping yoke screw connection for conductor connection with 225° outlet direction. The female connectors provide space for labelling and can be coded. Packed in cardboard box.

- 0.20 - 2.5 mm² (IEC) / 26 - 12 AWG (UL)
- 400 V (IEC) / 300 V (UL)
- 16.5 A (IEC) / 10 A (UL)

General ordering data

Order No.	Part designation	Version	GTIN (EAN)	Qty.	Packaging
1741930000	BLZ 5.08/08/225 SN BK BX	PCB plug-in connector, female plug, 5.08 mm, No. of poles: 8, 225°, Clamping yoke connection, Clamping range, max.: 3.31 mm ² , Box	4008190272876	42 pc(s).	Box
1741700000	BLZ 5.08/08/225 SN OR BX	PCB plug-in connector, female plug, 5.08 mm, No. of poles: 8, 225°, Clamping yoke connection, Clamping range, max.: 3.31 mm ² , Box	4008190219093	42 pc(s).	Box

System pitch 5.08 mm (0.200 inch) SL-SMT 5.08/08/90G 3.2SN BK BX

Weidmüller Interface GmbH & Co. KG
 Klingenbergstraße 16
 D-32758 Detmold
 Germany
 Fon: +49 5231 14-0
 Fax: +49 5231 14-2083
 www.weidmueller.com

Counterpart

BLZ 5.08/270



Female connectors with clamping yoke screw connection. The female connectors provide space for labelling and can be coded. Packed in cardboard box.

- 0.20 - 2.5 mm² (IEC) / 26 - 12 AWG (UL)
- 400 V (IEC) / 300 V (UL)
- 15 A (IEC) / 10 A (UL)

General ordering data

Order No.	Part designation	Version	GTIN (EAN)	Qty.	Packaging
1557910000	BLZ 5.08/08/270 SN BK BX	PCB plug-in connector, female plug, 5.08 mm, No. of poles: 8, 270°, Clamping yoke connection, Clamping range, max.: 3.31 mm ² , Box	4008190269487	42 pc(s).	Box
1557960000	BLZ 5.08/08/270 SN OR BX	PCB plug-in connector, female plug, 5.08 mm, No. of poles: 8, 270°, Clamping yoke connection, Clamping range, max.: 3.31 mm ² , Box	4008190085902	42 pc(s).	Box

BLZF 5.08/270



Female connectors for connecting conductors with tension clamp system. The female connectors include space for labelling and can be coded. Packed in cardboard box.

- 0.20 - 2.5 mm² (IEC) / 26 - 12 AWG (UL)
- 400 V (IEC) / 300 V (UL)
- 16.5 A (IEC) / 10 A (UL)

General ordering data

Order No.	Part designation	Version	GTIN (EAN)	Qty.	Packaging
1672000000	BLZF 5.08/08/270 SN OR BX	PCB plug-in connector, female plug, 5.08 mm, No. of poles: 8, 270°, Tension clamp connection, Clamping range, max.: 3.31 mm ² , Box	4008190433710	42 pc(s).	Box
1672230000	BLZF 5.08/08/270 SN BK BX	PCB plug-in connector, female plug, 5.08 mm, No. of poles: 8, 270°, Tension clamp connection, Clamping range, max.: 3.31 mm ² , Box	4008190433949	42 pc(s).	Box

System pitch 5.08 mm (0.200 inch) SL-SMT 5.08/08/90G 3.2SN BK BX

Weidmüller Interface GmbH & Co. KG
 Klingenbergstraße 16
 D-32758 Detmold
 Germany
 Fon: +49 5231 14-0
 Fax: +49 5231 14-2083
 www.weidmueller.com

Counterpart

BLZP 5.08/270F SN



Socket connectors with clamping yoke screw connection for conductor connection with a right-angle (90° or 270°) outlet direction. The female connectors provide space for labelling and can be coded. Can be fastened with flange or release latch. They feature an integrated plus/minus screw, protection against false insertion under clamping yoke. They are delivered with an opened clamping yoke.

- 0.2-2.5 mm² (IEC) / 26-12 AWG (UL)
- 400 V (IEC) / 300 V (UL)
- 15 A (IEC) / 10 A (UL)

General ordering data

Order No.	Part designation	Version	GTIN (EAN)	Qty.	Packaging
1950640000	BLZP 5.08/08/270F SN BK BX	PCB plug-in connector, female plug, 5.08 mm, No. of poles: 8, 270°, Clamping yoke connection, Clamping range, max.: 4 mm ² , Box	4032248629015	36 pc(s).	Box
1950370000	BLZP 5.08/08/270F SN OR BX	PCB plug-in connector, female plug, 5.08 mm, No. of poles: 8, 270°, Clamping yoke connection, Clamping range, max.: 4 mm ² , Box	4032248628490	36 pc(s).	Box

BLZP 5.08/180F SN



Female connectors with clamping yoke screw connection for conductor connection with straight (180°) outlet direction. The female connectors provide space for labelling and can be coded. Can be fastened with flange or release latch. They feature an integrated plus/minus screw, protection against false insertion under clamping yoke. They are delivered with an opened clamping yoke.

- 0.2-2.5 mm² (IEC) / 26-12 AWG (UL)
- 400 V (IEC) / 300 V (UL)
- 19 A (IEC) / 15 A (UL)

General ordering data

Order No.	Part designation	Version	GTIN (EAN)	Qty.	Packaging
1944150000	BLZP 5.08/08/180F SN OR BX	PCB plug-in connector, female plug, 5.08 mm, No. of poles: 8, 180°, Clamping yoke connection, Clamping range, max.: 4 mm ² , Box	4032248618736	45 pc(s).	Box
1944390000	BLZP 5.08/08/180F SN BK BX	PCB plug-in connector, female plug, 5.08 mm, No. of poles: 8, 180°, Clamping yoke connection, Clamping range, max.: 4 mm ² , Box	4032248618965	45 pc(s).	Box

System pitch 5.08 mm (0.200 inch) SL-SMT 5.08/08/90G 3.2SN BK BX

Weidmüller Interface GmbH & Co. KG
 Klingenbergstraße 16
 D-32758 Detmold
 Germany
 Fon: +49 5231 14-0
 Fax: +49 5231 14-2083
 www.weidmueller.com

Counterpart

BLZP 5.00/270F SN

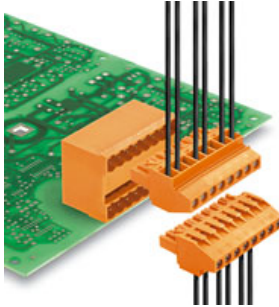

Socket connectors with clamping yoke screw connection for conductor connection with a right-angle (90° or 270°) outlet direction. The female connectors provide space for labelling and can be coded. Can be fastened with flange or release latch. They feature an integrated plus/minus screw, protection against false insertion under clamping yoke. They are delivered with an opened clamping yoke.

- 0.2-2.5 mm² (IEC) / 26-12 AWG (UL)
- 400 V (IEC) / 300 V (UL)
- 15 A (IEC) / 10 A (UL)

General ordering data

Order No.	Part designation	Version	GTIN (EAN)	Qty.	Packaging
1960400000	BLZP 5.00/08/270F SN OR BX	PCB plug-in connector, female plug, 5.00 mm, No. of poles: 8, 90°, Clamping yoke connection, Clamping range, max.: 4 mm ² , Box	4032248639267	36 pc(s).	Box
1960660000	BLZP 5.00/08/270F SN BK BX	PCB plug-in connector, female plug, 5.00 mm, No. of poles: 8, 90°, Clamping yoke connection, Clamping range, max.: 4 mm ² , Box	4032248639625	36 pc(s).	Box

BLZ 5.08/180LH



Socket connectors with clamping yoke screw connection for conductor connection with 270° outlet direction and release lever or release latch mechanism. The female connectors provide space for labelling and can be coded. Packed in cardboard box.br/>

- 0.20–1.5 mm² (IEC) / 26–12 AWG (UL)
- 400 V (IEC) / 300 V (UL)
- 19 A (IEC) / 15 A (UL)

General ordering data

Order No.	Part designation	Version	GTIN (EAN)	Qty.	Packaging
1893660000	BLZ 5.08/08/180LH SN BK BX	PCB plug-in connector, female plug, 5.08 mm, No. of poles: 8, 180°, Clamping yoke connection, Clamping range, max.: 3.31 mm ² , Box	4032248507849	50 pc(s).	Box
1892250000	BLZ 5.08/08/180LH SN OR BX	PCB plug-in connector, female plug, 5.08 mm, No. of poles: 8, 180°, Clamping yoke connection, Clamping range, max.: 3.31 mm ² , Box	4032248505654	50 pc(s).	Box

System pitch 5.08 mm (0.200 inch) SL-SMT 5.08/08/90G 3.2SN BK BX

Weidmüller Interface GmbH & Co. KG
 Klingenbergstraße 16
 D-32758 Detmold
 Germany
 Fon: +49 5231 14-0
 Fax: +49 5231 14-2083
 www.weidmueller.com

Counterpart

BLZ 5.00/90B



Female connectors with clamping yoke screw connection. The female connectors provide space for labelling and can be coded. Packed in cardboard box.

- 0.20 - 2.5 mm² (IEC) / 26 - 12 AWG (UL)
- 400 V (IEC) / 300 V (UL)
- 15 A (IEC) / 10 A (UL)

General ordering data

Order No.	Part designation	Version	GTIN (EAN)	Qty.	Packaging
1637410000	BLZ 5.00/08/90B SN BK BX	PCB plug-in connector, female plug, 5.00 mm, No. of poles: 8, 90°, Clamping yoke connection, Clamping range, max.: 3.31 mm ² , Box	4008190274658	42 pc(s).	Box
1637180000	BLZ 5.00/08/90B SN OR BX	PCB plug-in connector, female plug, 5.00 mm, No. of poles: 8, 90°, Clamping yoke connection, Clamping range, max.: 3.31 mm ² , Box	4008190274429	42 pc(s).	Box

BLZP 5.08/90F SN

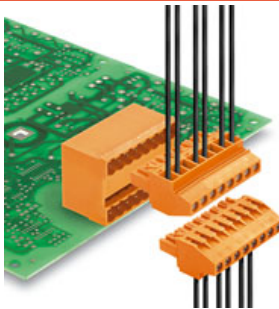

Socket connectors with clamping yoke screw connection for conductor connection with a right-angle (90° or 270°) outlet direction. The female connectors provide space for labelling and can be coded. Can be fastened with flange or release latch. They feature an integrated plus/minus screw, protection against false insertion under clamping yoke. They are delivered with an opened clamping yoke.

- 0.2-2.5 mm² (IEC) / 26-12 AWG (UL)
- 400 V (IEC) / 300 V (UL)
- 15 A (IEC) / 10 A (UL)

General ordering data

Order No.	Part designation	Version	GTIN (EAN)	Qty.	Packaging
1950100000	BLZP 5.08/08/90F SN BK BX	PCB plug-in connector, female plug, 5.08 mm, No. of poles: 8, 90°, Clamping yoke connection, Clamping range, max.: 4 mm ² , Box	4032248628032	36 pc(s).	Box
1949860000	BLZP 5.08/08/90F SN OR BX	PCB plug-in connector, female plug, 5.08 mm, No. of poles: 8, 90°, Clamping yoke connection, Clamping range, max.: 4 mm ² , Box	4032248627783	36 pc(s).	Box

System pitch 5.08 mm (0.200 inch) SL-SMT 5.08/08/90G 3.2SN BK BX

Weidmüller Interface GmbH & Co. KG
Klingenbergstraße 16
D-32758 Detmold
Germany
Fon: +49 5231 14-0
Fax: +49 5231 14-2083
www.weidmueller.com

Counterpart

BLZP 5.00/270LH SN



Socket connectors with clamping yoke screw connection for conductor connection with a right-angle (90° or 270°) outlet direction. The female connectors provide space for labelling and can be coded. Can be fastened with flange or release latch. They feature an integrated plus/minus screw, protection against false insertion under clamping yoke. They are delivered with an opened clamping yoke.

- 0.2-2.5 mm² (IEC) / 26-12 AWG (UL)
- 400 V (IEC) / 300 V (UL)
- 15 A (IEC) / 10 A (UL)

General ordering data

Order No.	Part designation	Version	GTIN (EAN)	Qty.	Packaging
1961380000	BLZP 5.00/08/270LH SN OR BX	PCB plug-in connector, female plug, 5.00 mm, No. of poles: 8, 90°, Clamping yoke connection, Clamping range, max.: 4 mm ² , Box	4032248640652	36 pc(s).	Box
1961610000	BLZP 5.00/08/270LH SN BK BX	PCB plug-in connector, female plug, 5.00 mm, No. of poles: 8, 90°, Clamping yoke connection, Clamping range, max.: 4 mm ² , Box	4032248640881	36 pc(s).	Box

BLZP 5.00/180F SN



Female connectors with clamping yoke screw connection for conductor connection with straight (180°) outlet direction. The female connectors provide space for labelling and can be coded. Can be fastened with flange or release latch. They feature an integrated plus/minus screw, protection against false insertion under clamping yoke. They are delivered with an opened clamping yoke.

- 0.2-2.5 mm² (IEC) / 26-12 AWG (UL)
- 400 V (IEC) / 300 V (UL)
- 19 A (IEC) / 15 A (UL)

General ordering data

Order No.	Part designation	Version	GTIN (EAN)	Qty.	Packaging
1955740000	BLZP 5.00/08/180F SN OR BX	PCB plug-in connector, female plug, 5.00 mm, No. of poles: 8, 180°, Clamping yoke connection, Clamping range, max.: 4 mm ² , Box	4032248634279	45 pc(s).	Box
1955970000	BLZP 5.00/08/180F SN BK BX	PCB plug-in connector, female plug, 5.00 mm, No. of poles: 8, 180°, Clamping yoke connection, Clamping range, max.: 4 mm ² , Box	4032248634545	45 pc(s).	Box

System pitch 5.08 mm (0.200 inch) SL-SMT 5.08/08/90G 3.2SN BK BX

Weidmüller Interface GmbH & Co. KG
 Klingenbergstraße 16
 D-32758 Detmold
 Germany
 Fon: +49 5231 14-0
 Fax: +49 5231 14-2083
 www.weidmueller.com

Counterpart

BLZ 5.08/180F



Female connectors with clamping yoke screw connection for conductor connection with straight outlet direction. The female connectors provide space for labelling and can be coded. Packed in cardboard box.

- 0.20 - 2.5 mm² (IEC) / 26 - 12 AWG (UL)
- 400 V (IEC) / 300 V (UL)
- 19 A (IEC) / 15 A (UL)

General ordering data

Order No.	Part designation	Version	GTIN (EAN)	Qty.	Packaging
1803100000	BLZ 5.08/08/180F SN BK BX	PCB plug-in connector, female plug, 5.08 mm, No. of poles: 8, 180°, Clamping yoke connection, Clamping range, max.: 3.31 mm ² , Box	4032248258208	50 pc(s).	Box
1802890000	BLZ 5.08/08/180F SN OR BX	PCB plug-in connector, female plug, 5.08 mm, No. of poles: 8, 180°, Clamping yoke connection, Clamping range, max.: 3.31 mm ² , Box	4032248257966	50 pc(s).	Box

BLT 5.08F

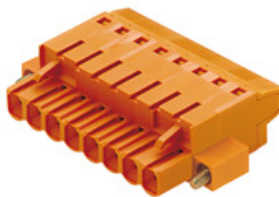

Female connectors with TOP screw system for connecting conductors with straight 180° outlet direction. The female connectors include space for labelling and can be coded. Packed in cardboard box.

- 0.20 - 2.5 mm² (IEC) / 26 - 14 AWG (UL)
- 400 V (IEC) / 300 V (UL)
- 17 A (IEC) / 10 A (UL)

General ordering data

Order No.	Part designation	Version	GTIN (EAN)	Qty.	Packaging
1844050000	BLT 5.08/08/180F SN OR BX	PCB plug-in connector, female plug, 5.08 mm, No. of poles: 8, 180°, TOP connection, Clamping range, max.: 2.5 mm ² , Box	4032248355976	36 pc(s).	Box
1844280000	BLT 5.08/08/180F SN BK BX	PCB plug-in connector, female plug, 5.08 mm, No. of poles: 8, 180°, TOP connection, Clamping range, max.: 2.5 mm ² , Box	4032248356218	36 pc(s).	Box

System pitch 5.08 mm (0.200 inch) SL-SMT 5.08/08/90G 3.2SN BK BX

Weidmüller Interface GmbH & Co. KG
 Klingenbergstraße 16
 D-32758 Detmold
 Germany
 Fon: +49 5231 14-0
 Fax: +49 5231 14-2083
 www.weidmueller.com

Counterpart

BLL 5.08/90FI



Female connector for PCB mounting. The solder pin length is optimised for wave flow soldering. Packed in cardboard box.

- 400 V (IEC) / 300 V (UL)
- 23 A (IEC) / 15 A (UL)

General ordering data

Order No.	Part designation	Version	GTIN (EAN)	Qty.	Packaging
1843810000	BLL 5.08/08/90FI 3.2SN OR BX	PCB plug-in connector, female header, 5.08 mm, No. of poles: 8, 90°, Solder pin length: 3.2 mm, tinned, Orange, Solder connection, Box	4032248355563	50 pc(s).	Box

BLF 5.08/90LH SN



Just as reliable as the tried-and-true original, with innovation in detail:

The BLF 5.0x – the PUSH-IN version of the BLZ 5.0x socket block – features a new connection system and a more compact design. Weidmüller's innovative PUSH-IN spring connection features a trend-setting, tool-free wire connection system that is simple to operate.

In terms of versatility, the BLF 5.0x offers just as much as the older versions:

- The choice of three wire outlet directions offers you proven design flexibility for your applications.
- Four flange variations, including the patented release latch, allow for user-friendly unplugging designs.

General ordering data

Order No.	Part designation	Version	GTIN (EAN)	Qty.	Packaging
1000700001	BLF 5.08/08/90LH SN BK BX	PCB plug-in connector, female plug, 5.08 mm, No. of poles: 8, 90°, PUSH IN, Clamping range, max.: 3.31 mm², Box	4032248690893	36 pc(s).	Box
1002540000	BLF 5.08/08/90LH SN OR BX	PCB plug-in connector, female plug, 5.08 mm, No. of poles: 8, 90°, PUSH IN, Clamping range, max.: 3.31 mm², Box	4032248694914	36 pc(s).	Box

System pitch 5.08 mm (0.200 inch) SL-SMT 5.08/08/90G 3.2SN BK BX

Weidmüller Interface GmbH & Co. KG
 Klingenbergstraße 16
 D-32758 Detmold
 Germany
 Fon: +49 5231 14-0
 Fax: +49 5231 14-2083
 www.weidmueller.com

Counterpart

BLZP 5.00/180LR SN



Female connectors with clamping yoke screw connection for conductor connection with straight (180°) outlet direction. The female connectors provide space for labelling and can be coded. Can be fastened with flange or release latch. They feature an integrated plus/minus screw, protection against false insertion under clamping yoke. They are delivered with an opened clamping yoke.

- 0.2-2.5 mm² (IEC) / 26-12 AWG (UL)
- 400 V (IEC) / 300 V (UL)
- 19 A (IEC) / 15 A (UL)

General ordering data

Order No.	Part designation	Version	GTIN (EAN)	Qty.	Packaging
1956310000	BLZP 5.00/08/180LR SN OR BX	PCB plug-in connector, female plug, 5.00 mm, No. of poles: 8, 180°, Clamping yoke connection, Clamping range, max.: 4 mm ² , Box	4032248635016	45 pc(s).	Box
1956540000	BLZP 5.00/08/180LR SN BK BX	PCB plug-in connector, female plug, 5.00 mm, No. of poles: 8, 180°, Clamping yoke connection, Clamping range, max.: 4 mm ² , Box	4032248635337	45 pc(s).	Box

BLDT 5.08B



Female connectors with two clamping yoke screw connections per pole for conductor connection with 90° & 270° outlet direction. The female connectors provide space for labelling and can be coded. Packed in cardboard box.

- 0.20 - 2.5 mm² (IEC) / 26 - 12 AWG (UL)
- 400 V (IEC) / 300 V (UL)
- 14 A (IEC) / 10 A (UL)

General ordering data

Order No.	Part designation	Version	GTIN (EAN)	Qty.	Packaging
1651800000	BLDT 5.08/08/-B SN OR BX	PCB plug-in connector, female plug, 5.08 mm, No. of poles: 8, 90°/270°, Clamping yoke connection, Clamping range, max.: 3.31 mm ² , Box	4008190400484	50 pc(s).	Box
1673840000	BLDT 5.08/08/-B SN BK BX	PCB plug-in connector, female plug, 5.08 mm, No. of poles: 8, 90°/270°, Clamping yoke connection, Clamping range, max.: 3.31 mm ² , Box	4008190435578	50 pc(s).	Box

System pitch 5.08 mm (0.200 inch) SL-SMT 5.08/08/90G 3.2SN BK BX

Weidmüller Interface GmbH & Co. KG
 Klingenbergstraße 16
 D-32758 Detmold
 Germany
 Fon: +49 5231 14-0
 Fax: +49 5231 14-2083
 www.weidmueller.com

Counterpart

BLZ 5.00/180F



Female connectors with clamping yoke screw connection for conductor connection with straight outlet direction. The female connectors provide space for labelling and can be coded. Packed in cardboard box.

- 0.20 - 2.5 mm² (IEC) / 26 - 12 AWG (UL)
- 400 V (IEC) / 300 V (UL)
- 19 A (IEC) / 15 A (UL)

General ordering data

Order No.	Part designation	Version	GTIN (EAN)	Qty.	Packaging
1843350000	BLZ 5.00/08/180F SN OR BX	PCB plug-in connector, female plug, 5.00 mm, No. of poles: 8, 180°, Clamping yoke connection, Clamping range, max.: 3.31 mm ² , Box	4032248355075	50 pc(s).	Box
1843580000	BLZ 5.00/08/180F SN BK BX	PCB plug-in connector, female plug, 5.00 mm, No. of poles: 8, 180°, Clamping yoke connection, Clamping range, max.: 3.31 mm ² , Box	4032248355303	50 pc(s).	Box

BLZP 5.08/180LH SN



Female connectors with clamping yoke screw connection for conductor connection with straight (180°) outlet direction. The female connectors provide space for labelling and can be coded. Can be fastened with flange or release latch. They feature an integrated plus/minus screw, protection against false insertion under clamping yoke. They are delivered with an opened clamping yoke.

- 0.2-2.5 mm² (IEC) / 26-12 AWG (UL)
- 400 V (IEC) / 300 V (UL)
- 19 A (IEC) / 15 A (UL)

General ordering data

Order No.	Part designation	Version	GTIN (EAN)	Qty.	Packaging
1945580000	BLZP 5.08/08/180LH SN BK BX	PCB plug-in connector, female plug, 5.08 mm, No. of poles: 8, 180°, Clamping yoke connection, Clamping range, max.: 4 mm ² , Box	4032248620753	45 pc(s).	Box
1945350000	BLZP 5.08/08/180LH SN OR BX	PCB plug-in connector, female plug, 5.08 mm, No. of poles: 8, 180°, Clamping yoke connection, Clamping range, max.: 4 mm ² , Box	4032248620524	45 pc(s).	Box

System pitch 5.08 mm (0.200 inch) SL-SMT 5.08/08/90G 3.2SN BK BX

Weidmüller Interface GmbH & Co. KG
 Klingenbergstraße 16
 D-32758 Detmold
 Germany
 Fon: +49 5231 14-0
 Fax: +49 5231 14-2083
 www.weidmueller.com

Counterpart

BLZ 5.08/90B

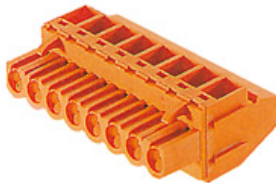

Female connectors with clamping yoke screw connection. The female connectors provide space for labelling and can be coded. Packed in cardboard box.

- 0.20 - 2.5 mm² (IEC) / 26 - 12 AWG (UL)
- 400 V (IEC) / 300 V (UL)
- 15 A (IEC) / 10 A (UL)

General ordering data

Order No.	Part designation	Version	GTIN (EAN)	Qty.	Packaging
1555680000	BLZ 5.08/08/90B SN OR BX	PCB plug-in connector, female plug, 5.08 mm, No. of poles: 8, 90°, Clamping yoke connection, Clamping range, max.: 3.31 mm ² , Box	4008190136413	42 pc(s).	Box

BLC 5.08BR

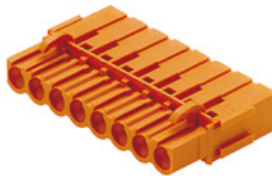

Female connectors for conductor connection with crimp connection system. The female connectors provide space for labelling and can be coded. Packed in cardboard box.

- 0.25 - 2.5 mm² (IEC) / 26 - 14 AWG (UL)
- 400 V (IEC) / 300 V (UL)
- 21 A (IEC) / 10 A (UL)

General ordering data

Order No.	Part designation	Version	GTIN (EAN)	Qty.	Packaging
1712170000	BLC 5.08/08/180BR BK BX	PCB plug-in connector, female plug, 5.08 mm, No. of poles: 8, 180°, Crimp connection, Clamping range, max.: 2.5 mm ² , Box	4008190935184	50 pc(s).	Box
1649430000	BLC 5.08/08/180BR OR BX	PCB plug-in connector, female plug, 5.08 mm, No. of poles: 8, 180°, Crimp connection, Clamping range, max.: 2.5 mm ² , Box	4008190294540	50 pc(s).	Box

System pitch 5.08 mm (0.200 inch) SL-SMT 5.08/08/90G 3.2SN BK BX

Weidmüller Interface GmbH & Co. KG
 Klingenbergstraße 16
 D-32758 Detmold
 Germany
 Fon: +49 5231 14-0
 Fax: +49 5231 14-2083
 www.weidmueller.com

Counterpart

BLL 5.08/180B



Female connector for PCB mounting. The solder pin length is optimised for wave flow soldering. Packed in cardboard box.

- 400 V (IEC) / 300 V (UL)
- 23 A (IEC) / 15 A (UL)

General ordering data

Order No.	Part designation	Version	GTIN (EAN)	Qty.	Packaging
1682790000	BLL 5.08/08/180B 3.2SN OR BX	PCB plug-in connector, female header, 5.08 mm, No. of poles: 8, 180°, Solder pin length: 3.2 mm, tinned, Orange, Solder connection, Box	4008190474553	50 pc(s).	Box

BLZP 5.08/270LR SN



Socket connectors with clamping yoke screw connection for conductor connection with a right-angle (90° or 270°) outlet direction. The female connectors provide space for labelling and can be coded. Can be fastened with flange or release latch. They feature an integrated plus/minus screw, protection against false insertion under clamping yoke. They are delivered with an opened clamping yoke.

- 0.2-2.5 mm² (IEC) / 26-12 AWG (UL)
- 400 V (IEC) / 300 V (UL)
- 15 A (IEC) / 10 A (UL)

General ordering data

Order No.	Part designation	Version	GTIN (EAN)	Qty.	Packaging
1947590000	BLZP 5.08/08/270LR SN OR BX	PCB plug-in connector, female plug, 5.08 mm, No. of poles: 8, 270°, Clamping yoke connection, Clamping range, max.: 4 mm ² , Box	4032248623884	36 pc(s).	Box
1947820000	BLZP 5.08/08/270LR SN BK BX	PCB plug-in connector, female plug, 5.08 mm, No. of poles: 8, 270°, Clamping yoke connection, Clamping range, max.: 4 mm ² , Box	4032248624317	36 pc(s).	Box

System pitch 5.08 mm (0.200 inch) SL-SMT 5.08/08/90G 3.2SN BK BX

Weidmüller Interface GmbH & Co. KG
 Klingenbergstraße 16
 D-32758 Detmold
 Germany
 Fon: +49 5231 14-0
 Fax: +49 5231 14-2083
 www.weidmueller.com

Counterpart

BLF 5.08/90LR SN



Just as reliable as the tried-and-true original, with innovation in detail:

The BLF 5.0x – the PUSH-IN version of the BLZ 5.0x socket block – features a new connection system and a more compact design. Weidmüller's innovative PUSH-IN spring connection features a trend-setting, tool-free wire connection system that is simple to operate.

In terms of versatility, the BLF 5.0x offers just as much as the older versions:

- The choice of three wire outlet directions offers you proven design flexibility for your applications.
- Four flange variations, including the patented release latch, allow for user-friendly unplugging designs.

General ordering data

Order No.	Part designation	Version	GTIN (EAN)	Qty.	Packaging
1000470001	BLF 5.08/08/90LR SN BK BX	PCB plug-in connector, female plug, 5.08 mm, No. of poles: 8, 90°, PUSH IN, Clamping range, max.: 3.31 mm², Box	4032248690435	36 pc(s).	Box
1002340000	BLF 5.08/08/90LR SN OR BX	PCB plug-in connector, female plug, 5.08 mm, No. of poles: 8, 90°, PUSH IN, Clamping range, max.: 3.31 mm², Box	4032248694501	36 pc(s).	Box

BLZ 5.00/270B



Female connectors with clamping yoke screw connection.

The female connectors provide space for labelling and can be coded. Packed in cardboard box.

- 0.20 - 2.5 mm² (IEC) / 26 - 12 AWG (UL)
- 400 V (IEC) / 300 V (UL)
- 15 A (IEC) / 10 A (UL)

General ordering data

Order No.	Part designation	Version	GTIN (EAN)	Qty.	Packaging
1638330000	BLZ 5.00/08/270B SN BK BX	PCB plug-in connector, female plug, 5.00 mm, No. of poles: 8, 270°, Clamping yoke connection, Clamping range, max.: 3.31 mm², Box	4008190275594	42 pc(s).	Box
1638100000	BLZ 5.00/08/270B SN OR BX	PCB plug-in connector, female plug, 5.00 mm, No. of poles: 8, 270°, Clamping yoke connection, Clamping range, max.: 3.31 mm², Box	4008190275365	42 pc(s).	Box

System pitch 5.08 mm (0.200 inch) SL-SMT 5.08/08/90G 3.2SN BK BX

Weidmüller Interface GmbH & Co. KG
Klingenbergstraße 16
D-32758 Detmold
Germany
Fon: +49 5231 14-0
Fax: +49 5231 14-2083
www.weidmueller.com

Counterpart

BLZF 5.08/180LH



Socket blocks for conductor connection, featuring the time-saving tension clamp technology, with straight outlet direction and release lever or release latch mechanism. The female connectors provide space for labelling and can be coded. Packed in cardboard box.

- 0.20 - 1.5 mm² (IEC) / 26 - 12 AWG (UL)
- 400 V (IEC) / 300 V (UL)
- 17 A (IEC) / 15 A (UL)

General ordering data

Order No.	Part designation	Version	GTIN (EAN)	Qty.	Packaging
1895780000	BLZF 5.08/08/180LH SN OR BX	PCB plug-in connector, female plug, 5.08 mm, No. of poles: 8, 180°, Tension clamp connection, Clamping range, max.: 3.31 mm ² , Box	4032248510504	36 pc(s).	Box
1893220000	BLZF 5.08/08/180LH SN BK BX	PCB plug-in connector, female plug, 5.08 mm, No. of poles: 8, 180°, Tension clamp connection, Clamping range, max.: 3.31 mm ² , Box	4032248507368	36 pc(s).	Box

BLZF 5.08/180F



Female connectors for connecting conductors with tension clamp system, straight 180° outlet direction. The female connectors include space for labelling and can be coded. Packed in cardboard box.

- 0.20 - 2.5 mm² (IEC) / 26 - 12 AWG (UL)
- 400 V (IEC) / 300 V (UL)
- 17 A (IEC) / 15 A (UL)

General ordering data

Order No.	Part designation	Version	GTIN (EAN)	Qty.	Packaging
1803620000	BLZF 5.08/08/180F SN BK BX	PCB plug-in connector, female plug, 5.08 mm, No. of poles: 8, 180°, Tension clamp connection, Clamping range, max.: 3.31 mm ² , Box	4032248259021	36 pc(s).	Box
1803390000	BLZF 5.08/08/180F SN OR BX	PCB plug-in connector, female plug, 5.08 mm, No. of poles: 8, 180°, Tension clamp connection, Clamping range, max.: 3.31 mm ² , Box	4032248258796	36 pc(s).	Box

System pitch 5.08 mm (0.200 inch) SL-SMT 5.08/08/90G 3.2SN BK BX

Weidmüller Interface GmbH & Co. KG
 Klingenbergstraße 16
 D-32758 Detmold
 Germany
 Fon: +49 5231 14-0
 Fax: +49 5231 14-2083
 www.weidmueller.com

Counterpart

BLF 5.00/90LH SN



Just as reliable as the tried-and-true original, with innovation in detail:

The BLF 5.0x – the PUSH-IN version of the BLZ 5.0x socket block – features a new connection system and a more compact design. Weidmüller's innovative PUSH-IN spring connection features a trend-setting, tool-free wire connection system that is simple to operate.

In terms of versatility, the BLF 5.0x offers just as much as the older versions:

- The choice of three wire outlet directions offers you proven design flexibility for your applications.
- Four flange variations, including the patented release latch, allow for user-friendly unplugging designs.

General ordering data

Order No.	Part designation	Version	GTIN (EAN)	Qty.	Packaging
1981430000	BLF 5.00/08/90LH SN OR BX	PCB plug-in connector, female plug, 5.00 mm, No. of poles: 8, 90°, PUSH IN, Clamping range, max.: 3.31 mm², Box	4032248676736	36 pc(s).	Box
1980040000	BLF 5.00/08/90LH SN BK BX	PCB plug-in connector, female plug, 5.00 mm, No. of poles: 8, 90°, PUSH IN, Clamping range, max.: 3.31 mm², Box	4032248675104	36 pc(s).	Box

BLT 5.08LR



Socket connectors with clamping yoke screw connection for conductor connection with 270° outlet direction and release lever or release latch mechanism. The female connectors provide space for labelling and can be coded. Packed in cardboard box.

- 0.20 - 1.5 mm² (IEC) / 26 - 14 AWG (UL)
- 400 V (IEC) / 300 V (UL)
- 17 A (IEC) / 10 A (UL)

General ordering data

Order No.	Part designation	Version	GTIN (EAN)	Qty.	Packaging
1890280000	BLT 5.08/08/180LR SN OR BX	PCB plug-in connector, female plug, 5.08 mm, No. of poles: 8, 180°, TOP connection, Clamping range, max.: 2.5 mm², Box	4032248498765	36 pc(s).	Box
1894190000	BLT 5.08/08/180LR SN BK BX	PCB plug-in connector, female plug, 5.08 mm, No. of poles: 8, 180°, TOP connection, Clamping range, max.: 2.5 mm², Box	4032248508532	36 pc(s).	Box

System pitch 5.08 mm (0.200 inch) SL-SMT 5.08/08/90G 3.2SN BK BX

Weidmüller Interface GmbH & Co. KG
Klingenbergstraße 16
D-32758 Detmold
Germany
Fon: +49 5231 14-0
Fax: +49 5231 14-2083
www.weidmueller.com

Counterpart

BLZ 5.08/180LR



Socket connectors with clamping yoke screw connection for conductor connection with 270° outlet direction and release lever or release latch mechanism. The female connectors provide space for labelling and can be coded. Packed in cardboard box.

- 0.20 - 1.5 mm² (IEC) / 26 - 12 AWG (UL)
- 400 V (IEC) / 300 V (UL)
- 19 A (IEC) / 15 A (UL)

General ordering data

Order No.	Part designation	Version	GTIN (EAN)	Qty.	Packaging
1851260000	BLZ 5.08/08/180LR SN OR BX	PCB plug-in connector, female plug, 5.08 mm, No. of poles: 8, 180°, Clamping yoke connection, Clamping range, max.: 3.31 mm ² , Box	4032248382637	50 pc(s).	Box
1893010000	BLZ 5.08/08/180LR SN BK BX	PCB plug-in connector, female plug, 5.08 mm, No. of poles: 8, 180°, Clamping yoke connection, Clamping range, max.: 3.31 mm ² , Box	4032248507153	50 pc(s).	Box

BLZP 5.00/270LR SN



Socket connectors with clamping yoke screw connection for conductor connection with a right-angle (90° or 270°) outlet direction. The female connectors provide space for labelling and can be coded. Can be fastened with flange or release latch. They feature an integrated plus/minus screw, protection against false insertion under clamping yoke. They are delivered with an opened clamping yoke.

- 0.2-2.5 mm² (IEC) / 26-12 AWG (UL)
- 400 V (IEC) / 300 V (UL)
- 15 A (IEC) / 10 A (UL)

General ordering data

Order No.	Part designation	Version	GTIN (EAN)	Qty.	Packaging
1960900000	BLZP 5.00/08/270LR SN OR BX	PCB plug-in connector, female plug, 5.00 mm, No. of poles: 8, 90°, Clamping yoke connection, Clamping range, max.: 4 mm ² , Box	4032248639922	36 pc(s).	Box
1961130000	BLZP 5.00/08/270LR SN BK BX	PCB plug-in connector, female plug, 5.00 mm, No. of poles: 8, 90°, Clamping yoke connection, Clamping range, max.: 4 mm ² , Box	4032248640195	36 pc(s).	Box

System pitch 5.08 mm (0.200 inch) SL-SMT 5.08/08/90G 3.2SN BK BX

Weidmüller Interface GmbH & Co. KG
 Klingenbergstraße 16
 D-32758 Detmold
 Germany
 Fon: +49 5231 14-0
 Fax: +49 5231 14-2083
 www.weidmueller.com

Counterpart

BLZF 5.08/90B



Female connectors for connecting conductors with tension clamp system. The female connectors include space for labelling and can be coded. Packed in cardboard box.

- 0.20 - 2.5 mm² (IEC) / 26 - 12 AWG (UL)
- 400 V (IEC) / 300 V (UL)
- 16.5 A (IEC) / 10 A (UL)

General ordering data

Order No.	Part designation	Version	GTIN (EAN)	Qty.	Packaging
1671310000	BLZF 5.08/08/90B SN OR BX	PCB plug-in connector, female plug, 5.08 mm, No. of poles: 8, 90°, Tension clamp connection, Clamping range, max.: 3.31 mm ² , Box	4008190433017	42 pc(s).	Box
1671540000	BLZF 5.08/08/90B SN BK BX	PCB plug-in connector, female plug, 5.08 mm, No. of poles: 8, 90°, Tension clamp connection, Clamping range, max.: 3.31 mm ² , Box	4008190433246	42 pc(s).	Box

BLF 5.00/90F SN



Just as reliable as the tried-and-true original, with innovation in detail:

The BLF 5.0x – the PUSH-IN version of the BLZ 5.0x socket block – features a new connection system and a more compact design. Weidmüller's innovative PUSH-IN spring connection features a trend-setting, tool-free wire connection system that is simple to operate.

In terms of versatility, the BLF 5.0x offers just as much as the older versions:

- The choice of three wire outlet directions offers you proven design flexibility for your applications.
- Four flange variations, including the patented release latch, allow for user-friendly unplugging designs.

General ordering data

Order No.	Part designation	Version	GTIN (EAN)	Qty.	Packaging
1979520000	BLF 5.00/08/90F SN BK BX	PCB plug-in connector, female plug, 5.00 mm, No. of poles: 8, 90°, PUSH IN, Clamping range, max.: 3.31 mm ² , Box	4032248674725	36 pc(s).	Box
1980700000	BLF 5.00/08/90F SN OR BX	PCB plug-in connector, female plug, 5.00 mm, No. of poles: 8, 90°, PUSH IN, Clamping range, max.: 3.31 mm ² , Box	4032248675852	36 pc(s).	Box

System pitch 5.08 mm (0.200 inch) SL-SMT 5.08/08/90G 3.2SN BK BX

Weidmüller Interface GmbH & Co. KG
 Klingenbergstraße 16
 D-32758 Detmold
 Germany
 Fon: +49 5231 14-0
 Fax: +49 5231 14-2083
 www.weidmueller.com

Counterpart

BLF 5.00/90LR SN



Just as reliable as the tried-and-true original, with innovation in detail:

The BLF 5.0x – the PUSH-IN version of the BLZ 5.0x socket block – features a new connection system and a more compact design. Weidmüller's innovative PUSH-IN spring connection features a trend-setting, tool-free wire connection system that is simple to operate.

In terms of versatility, the BLF 5.0x offers just as much as the older versions:

- The choice of three wire outlet directions offers you proven design flexibility for your applications.
- Four flange variations, including the patented release latch, allow for user-friendly unplugging designs.

General ordering data

Order No.	Part designation	Version	GTIN (EAN)	Qty.	Packaging
1979850000	BLF 5.00/08/90LR SN BK BX	PCB plug-in connector, female plug, 5.00 mm, No. of poles: 8, 90°, PUSH IN, Clamping range, max.: 3.31 mm², Box	4032248674916	36 pc(s).	Box
1980930000	BLF 5.00/08/90LR SN OR BX	PCB plug-in connector, female plug, 5.00 mm, No. of poles: 8, 90°, PUSH IN, Clamping range, max.: 3.31 mm², Box	4032248676040	36 pc(s).	Box

BLT 5.08LH



Female connectors with TOP screw system for connecting conductors with straight 180° outlet direction. The female connectors include space for labelling and can be coded. Packed in cardboard box.

- 0.20 - 2.5 mm² (IEC) / 26 - 14 AWG (UL)
- 400 V (IEC) / 300 V (UL)
- 17 A (IEC) / 10 A (UL)

General ordering data

Order No.	Part designation	Version	GTIN (EAN)	Qty.	Packaging
1890050000	BLT 5.08/08/180LH SN OR BX	PCB plug-in connector, female plug, 5.08 mm, No. of poles: 8, 180°, TOP connection, Clamping range, max.: 2.5 mm², Box	4032248498468	36 pc(s).	Box
1892550000	BLT 5.08/08/180LH SN BK BX	PCB plug-in connector, female plug, 5.08 mm, No. of poles: 8, 180°, TOP connection, Clamping range, max.: 2.5 mm², Box	4032248506590	36 pc(s).	Box

System pitch 5.08 mm (0.200 inch) SL-SMT 5.08/08/90G 3.2SN BK BX

Weidmüller Interface GmbH & Co. KG
Klingenbergstraße 16
D-32758 Detmold
Germany
Fon: +49 5231 14-0
Fax: +49 5231 14-2083
www.weidmueller.com

Counterpart

BLZP 5.00/90F SN



Socket connectors with clamping yoke screw connection for conductor connection with a right-angle (90° or 270°) outlet direction. The female connectors provide space for labelling and can be coded. Can be fastened with flange or release latch. They feature an integrated plus/minus screw, protection against false insertion under clamping yoke. They are delivered with an opened clamping yoke.

- 0.2-2.5 mm² (IEC) / 26-12 AWG (UL)
- 400 V (IEC) / 300 V (UL)
- 15 A (IEC) / 10 A (UL)

General ordering data

Order No.	Part designation	Version	GTIN (EAN)	Qty.	Packaging
1959460000	BLZP 5.00/08/90F SN OR BX	PCB plug-in connector, female plug, 5.00 mm, No. of poles: 8, 90°, Clamping yoke connection, Clamping range, max.: 4 mm ² , Box	4032248638291	36 pc(s).	Box
1959690000	BLZP 5.00/08/90F SN BK BX	PCB plug-in connector, female plug, 5.00 mm, No. of poles: 8, 90°, Clamping yoke connection, Clamping range, max.: 4 mm ² , Box	4032248638628	36 pc(s).	Box

BLZ 5.08/225B



Female connectors with clamping yoke screw connection for conductor connection with 225° outlet direction. The female connectors provide space for labelling and can be coded. Packed in cardboard box.

- 0.20 - 2.5 mm² (IEC) / 26 - 12 AWG (UL)
- 400 V (IEC) / 300 V (UL)
- 16.5 A (IEC) / 10 A (UL)

General ordering data

Order No.	Part designation	Version	GTIN (EAN)	Qty.	Packaging
1742390000	BLZ 5.08/08/225B SN BK BX	PCB plug-in connector, female plug, 5.08 mm, No. of poles: 8, 225°, Clamping yoke connection, Clamping range, max.: 3.31 mm ² , Box	4032248049813	42 pc(s).	Box
1742160000	BLZ 5.08/08/225B SN OR BX	PCB plug-in connector, female plug, 5.08 mm, No. of poles: 8, 225°, Clamping yoke connection, Clamping range, max.: 3.31 mm ² , Box	4008190247485	42 pc(s).	Box

System pitch 5.08 mm (0.200 inch) SL-SMT 5.08/08/90G 3.2SN BK BX

Weidmüller Interface GmbH & Co. KG
 Klingenbergstraße 16
 D-32758 Detmold
 Germany
 Fon: +49 5231 14-0
 Fax: +49 5231 14-2083
 www.weidmueller.com

Counterpart

BLZ 5.08/270B



Female connectors with clamping yoke screw connection. The female connectors provide space for labelling and can be coded. Packed in cardboard box.

- 0.20 - 2.5 mm² (IEC) / 26 - 12 AWG (UL)
- 400 V (IEC) / 300 V (UL)
- 15 A (IEC) / 10 A (UL)

General ordering data

Order No.	Part designation	Version	GTIN (EAN)	Qty.	Packaging
1560260000	BLZ 5.08/08/270B SN OR BX	PCB plug-in connector, female plug, 5.08 mm, No. of poles: 8, 270°, Clamping yoke connection, Clamping range, max.: 3.31 mm ² , Box	4008190163396	42 pc(s).	Box
1560210000	BLZ 5.08/08/270B SN BK BX	PCB plug-in connector, female plug, 5.08 mm, No. of poles: 8, 270°, Clamping yoke connection, Clamping range, max.: 3.31 mm ² , Box	4008190269715	42 pc(s).	Box

BLZP 5.00/180LH SN



Female connectors with clamping yoke screw connection for conductor connection with straight (180°) outlet direction. The female connectors provide space for labelling and can be coded. Can be fastened with flange or release latch. They feature an integrated plus/minus screw, protection against false insertion under clamping yoke. They are delivered with an opened clamping yoke.

- 0.2-2.5 mm² (IEC) / 26-12 AWG (UL)
- 400 V (IEC) / 300 V (UL)
- 19 A (IEC) / 15 A (UL)

General ordering data

Order No.	Part designation	Version	GTIN (EAN)	Qty.	Packaging
1957230000	BLZP 5.00/08/180LH SN BK BX	PCB plug-in connector, female plug, 5.00 mm, No. of poles: 8, 180°, Clamping yoke connection, Clamping range, max.: 4 mm ² , Box	4032248636051	45 pc(s).	Box
1956930000	BLZP 5.00/08/180LH SN OR BX	PCB plug-in connector, female plug, 5.00 mm, No. of poles: 8, 180°, Clamping yoke connection, Clamping range, max.: 4 mm ² , Box	4032248635818	45 pc(s).	Box

System pitch 5.08 mm (0.200 inch) SL-SMT 5.08/08/90G 3.2SN BK BX

Weidmüller Interface GmbH & Co. KG
 Klingenbergstraße 16
 D-32758 Detmold
 Germany
 Fon: +49 5231 14-0
 Fax: +49 5231 14-2083
 www.weidmueller.com

Counterpart

BLZP 5.08/270LH SN



Socket connectors with clamping yoke screw connection for conductor connection with a right-angle (90° or 270°) outlet direction. The female connectors provide space for labelling and can be coded. Can be fastened with flange or release latch. They feature an integrated plus/minus screw, protection against false insertion under clamping yoke. They are delivered with an opened clamping yoke.

- 0.2-2.5 mm² (IEC) / 26-12 AWG (UL)
- 400 V (IEC) / 300 V (UL)
- 15 A (IEC) / 10 A (UL)

General ordering data

Order No.	Part designation	Version	GTIN (EAN)	Qty.	Packaging
1947300000	BLZP 5.08/08/270LH SN BK BX	PCB plug-in connector, female plug, 5.08 mm, No. of poles: 8, 270°, Clamping yoke connection, Clamping range, max.: 4 mm ² , Box	4032248623266	36 pc(s).	Box
1947070000	BLZP 5.08/08/270LH SN OR BX	PCB plug-in connector, female plug, 5.08 mm, No. of poles: 8, 270°, Clamping yoke connection, Clamping range, max.: 4 mm ² , Box	4032248622931	36 pc(s).	Box

BLZF 5.08/270B



Female connectors for connecting conductors with tension clamp system. The female connectors include space for labelling and can be coded. Packed in cardboard box.

- 0.20 - 2.5 mm² (IEC) / 26 - 12 AWG (UL)
- 400 V (IEC) / 300 V (UL)
- 16.5 A (IEC) / 10 A (UL)

General ordering data

Order No.	Part designation	Version	GTIN (EAN)	Qty.	Packaging
1672460000	BLZF 5.08/08/270B SN OR BX	PCB plug-in connector, female plug, 5.08 mm, No. of poles: 8, 270°, Tension clamp connection, Clamping range, max.: 3.31 mm ² , Box	4008190434175	42 pc(s).	Box
1672690000	BLZF 5.08/08/270B SN BK BX	PCB plug-in connector, female plug, 5.08 mm, No. of poles: 8, 270°, Tension clamp connection, Clamping range, max.: 3.31 mm ² , Box	4008190434403	42 pc(s).	Box

System pitch 5.08 mm (0.200 inch) SL-SMT 5.08/08/90G 3.2SN BK BX

Weidmüller Interface GmbH & Co. KG
 Klingenbergstraße 16
 D-32758 Detmold
 Germany
 Fon: +49 5231 14-0
 Fax: +49 5231 14-2083
 www.weidmueller.com

Counterpart

BLZP 5.08/225B SN



Clamping-yoke wire connection with right-angled (90° or 270°) or angled (225°) outlet direction. The female connectors provide space for labelling and can be coded. Can be fastened with flange or release latch. They feature an integrated plus/minus screw, protection against false insertion under clamping yoke. They are delivered with an opened clamping yoke.

- 0.2-2.5 mm² (IEC) / 26-12 AWG (UL)
- 400 V (IEC) / 300 V (UL)
- 17.5 A (IEC) / 10 A (UL)

General ordering data

Order No.	Part designation	Version	GTIN (EAN)	Qty.	Packaging
1946040000	BLZP 5.08/08/225B SN BK BX	PCB plug-in connector, female plug, 5.08 mm, No. of poles: 8, 225°, Clamping yoke connection, Clamping range, max.: 4 mm ² , Box	4032248621576	42 pc(s).	Box
1945810000	BLZP 5.08/08/225B SN OR BX	PCB plug-in connector, female plug, 5.08 mm, No. of poles: 8, 225°, Clamping yoke connection, Clamping range, max.: 4 mm ² , Box	4032248621286	42 pc(s).	Box

BLZP 5.08/180LR SN



Female connectors with clamping yoke screw connection for conductor connection with straight (180°) outlet direction. The female connectors provide space for labelling and can be coded. Can be fastened with flange or release latch. They feature an integrated plus/minus screw, protection against false insertion under clamping yoke. They are delivered with an opened clamping yoke.

- 0.2-2.5 mm² (IEC) / 26-12 AWG (UL)
- 400 V (IEC) / 300 V (UL)
- 19 A (IEC) / 15 A (UL)

General ordering data

Order No.	Part designation	Version	GTIN (EAN)	Qty.	Packaging
1945120000	BLZP 5.08/08/180LR SN BK BX	PCB plug-in connector, female plug, 5.08 mm, No. of poles: 8, 180°, Clamping yoke connection, Clamping range, max.: 4 mm ² , Box	4032248620265	45 pc(s).	Box
1944890000	BLZP 5.08/08/180LR SN OR BX	PCB plug-in connector, female plug, 5.08 mm, No. of poles: 8, 180°, Clamping yoke connection, Clamping range, max.: 4 mm ² , Box	4032248619917	45 pc(s).	Box

System pitch 5.08 mm (0.200 inch) SL-SMT 5.08/08/90G 3.2SN BK BX

Weidmüller Interface GmbH & Co. KG
Klingenbergstraße 16
D-32758 Detmold
Germany
Fon: +49 5231 14-0
Fax: +49 5231 14-2083
www.weidmueller.com

Counterpart

BLF 5.08/90F SN



Just as reliable as the tried-and-true original, with innovation in detail:

The BLF 5.0x – the PUSH-IN version of the BLZ 5.0x socket block – features a new connection system and a more compact design. Weidmüller's innovative PUSH-IN spring connection features a trend-setting, tool-free wire connection system that is simple to operate.

In terms of versatility, the BLF 5.0x offers just as much as the older versions:

- The choice of three wire outlet directions offers you proven design flexibility for your applications.
- Four flange variations, including the patented release latch, allow for user-friendly unplugging designs.

General ordering data

Order No.	Part designation	Version	GTIN (EAN)	Qty.	Packaging
1002150000	BLF 5.08/08/90F SN OR BX	PCB plug-in connector, female plug, 5.08 mm, No. of poles: 8, 90°, PUSH IN, Clamping range, max.: 3.31 mm², Box	4032248694105	36 pc(s).	Box
1000280001	BLF 5.08/08/90F SN BK BX	PCB plug-in connector, female plug, 5.08 mm, No. of poles: 8, 90°, PUSH IN, Clamping range, max.: 3.31 mm², Box	4032248690244	36 pc(s).	Box

BLZF 5.08/180LR



Female connectors for connecting conductors with tension clamp system, straight 180° outlet direction. The female connectors include space for labelling and can be coded. Packed in cardboard box.

- 0.20 - 2.5 mm² (IEC) / 26 - 12 AWG (UL)
- 400 V (IEC) / 300 V (UL)
- 17 A (IEC) / 15 A (UL)

General ordering data

Order No.	Part designation	Version	GTIN (EAN)	Qty.	Packaging
1892780000	BLZF 5.08/08/180LR SN BK BX	PCB plug-in connector, female plug, 5.08 mm, No. of poles: 8, 180°, Tension clamp connection, Clamping range, max.: 3.31 mm², Box	4032248506927	36 pc(s).	Box
1851470000	BLZF 5.08/08/180LR SN OR BX	PCB plug-in connector, female plug, 5.08 mm, No. of poles: 8, 180°, Tension clamp connection, Clamping range, max.: 3.31 mm², Box	4032248382941	36 pc(s).	Box