

**Contact Information**

**520-P.C. Tail, Regular Point - Tail LG.=.175(4.45)**

**.100" (2.54mm) Contact Spacing x .200" (5.08mm) Row Spacing**

THIS IS A C.A.D. GENERATED DRAWING  
DO NOT MAKE MANUAL REVISIONS TO MASTER.



ISSUE NUMBER

ORIGINAL ①

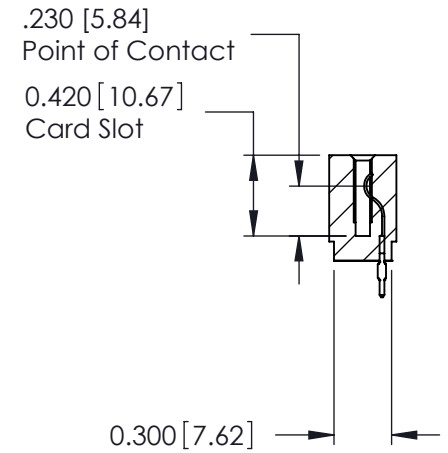
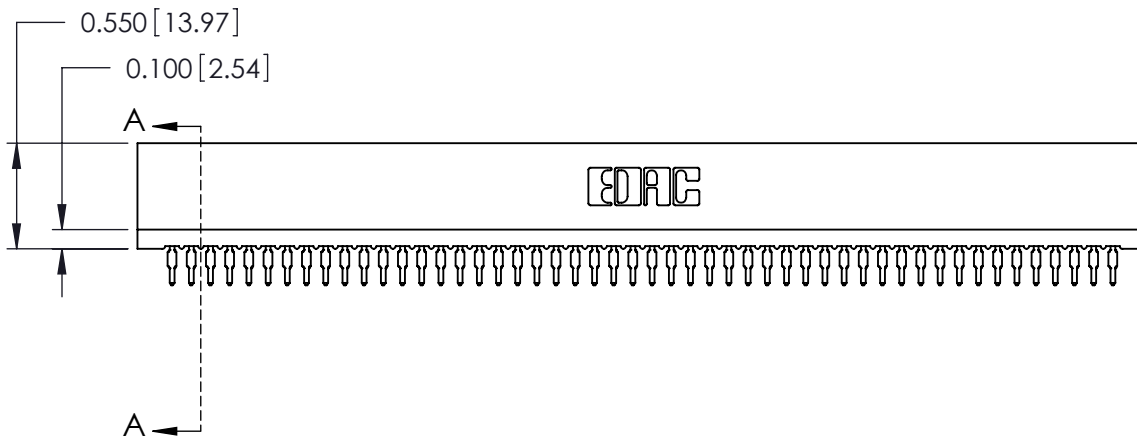
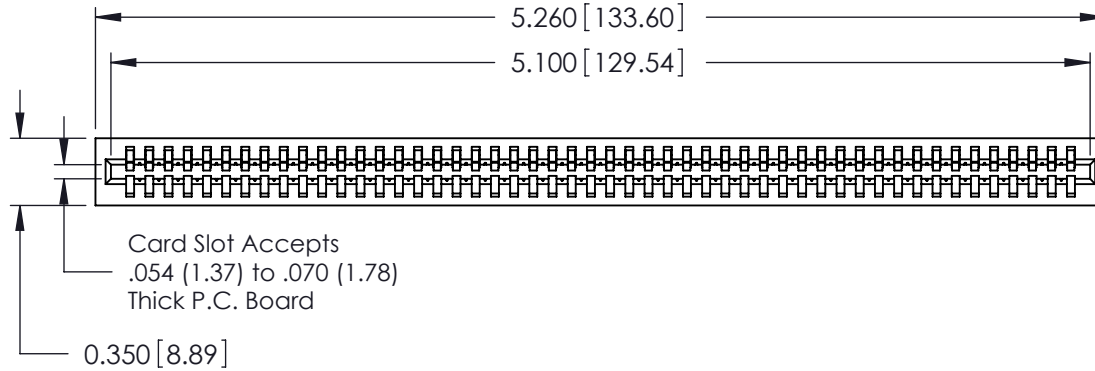

SECTION A-A

725 Series Ultra-Mate Card Edge Connector - Press Fit		ACAD REFERENCE NO.	725-ENG MASTER
Part Number: 725-050-520-101		DRAWN:	J.LEE
		CHECKED:	DATE: AUG31/09
		SCALE:	DATE:
		DRAWING NUMBER	SHEET 1 OF 1
		725-ENG MASTER	ISSUE 1



EDAC INC  
TORONTO, ONTARIO  
CANADA

YOUR CONNECTION TO QUALITY & SERVICE

THESE DRAWINGS AND SPECIFICATIONS ARE THE PROPERTY OF EDAC INC. AND SHALL NOT BE REPRODUCED, OR COPIED OR USED AS THE BASIS FOR THE MANUFACTURE OR SALE OF APPARATUS WITHOUT WRITTEN PERMISSION.